

Dell™ Inspiron™ 8200

Owner's Manual



Hints, Notices, and Cautions



HINT: A HINT indicates important information that helps you make better use of your computer.



NOTICE: A NOTICE indicates either potential damage to hardware or loss of data and tells you how to avoid the problem.



CAUTION: A CAUTION indicates a potential for property damage, personal injury, or death.

Abbreviations and Acronyms

For a complete list of abbreviations and acronyms, see the *Tell Me How* help file. To access the help file, see page 72.

**Information in this document is subject to change without notice.
© 2002 Dell Computer Corporation. All rights reserved.**

Reproduction in any manner whatsoever without the written permission of Dell Computer Corporation is strictly forbidden.

Trademarks used in this text: *Dell*, the *DELL* logo, *DellPlus*, *DellWare*, *Inspiron*, *TrueMobile*, *Dimension*, *OptiPlex*, *UltraSharp*, *DellNet*, *AccessDirect*, *Dell Precision*, and *Latitude* are trademarks of Dell Computer Corporation; *Intel*, *Pentium*, and *Celeron* are registered trademarks of Intel Corporation; *EMC* is the registered trademark of EMC Corporation; *GeForce2 Go* and *GeForce4 440 Go* are trademarks of NVIDIA Corporation; *ATI Mobility* and *RADEON* are trademarks of ATI Technologies Inc.; Microsoft and Windows are registered trademarks of Microsoft Corporation.

Other trademarks and trade names may be used in this document to refer to either the entities claiming the marks and names or their products. Dell Computer Corporation disclaims any proprietary interest in trademarks and trade names other than its own.

Contents

CAUTION: Safety Instructions	9
General	9
Power	10
Battery	11
Air Travel	12
EMC Instructions	12
When Using Your Computer	13
When Working Inside Your Computer	14
Protecting Against Electrostatic Discharge	15
Battery Disposal	15
Ergonomic Computing Habits	16

1 Setting Up and Using Your Computer

A Tour of Your Computer	20
Front View	20
Left Side View	24
Right Side View	27
Back View	29
Bottom View	33
Setting Up a Printer	34
Printer Cable	34
Connecting a Parallel Printer	34
Connecting a USB Printer	35
Transferring Information to a New Computer With Microsoft® Windows® XP	36
Setting Up a Home and Office Network With Windows XP	37

Connecting to the Internet	37
Setting Up Your Internet Connection	38
Copying CDs	39
Using Easy CD Creator Basic	40
Using Blank CD-R Discs or Blank CD-RW Discs	40
Helpful Tips	40
How to Copy a CD	41
Turning Off the Computer	42
About the Module Bay	42
Swapping Devices While the Computer Is Turned Off	42
Swapping Devices While the Computer Is Running	44
Using the Keyboard and Touch Pad	44
Dell™ AccessDirect™ Buttons	44
Numeric Keypad	46
Keyboard Shortcuts	47
Touch Pad	49
Customizing the Touch Pad and Track Stick	50
Changing the Track Stick Cap	50
Enabling the Infrared Sensor	51
Connecting a Television to the Computer	52
S-Video and Standard Audio	54
S-Video and Digital Audio	56
Composite Video and Standard Audio	58
Composite Video and Digital Audio	60
Enabling the Display Settings for a Television	61
Using S/PDIF Digital Audio	62
Setting Up the Dolby Headphone	64
Setting Up the Docking Device to Connect to a Network	65

Power Protection Devices	65
Surge Protectors	66
Line Conditioners	66
Uninterruptible Power Supply Devices	66

2 Solving Problems

Finding Solutions	70
Accessing Help	72
Power Problems	72
Ensuring Sufficient Power for Your Computer	73
Docking Power Considerations	74
Start-Up Error Messages	74
Video and Display Problems	75
If the display is blank	75
If the display is difficult to read	76
If only part of the display is readable	76
Sound and Speaker Problems	77
If you have a problem with integrated speakers	77
If you have a problem with external speakers	77
Printer Problems	78
Modem and Internet Connection Problems	79
Scanner Problems	80
Touch Pad or Mouse Problems	81
External Keyboard Problems	82
Unexpected Characters	82
Drive Problems	83
If you cannot save a file to a floppy disk drive	83
If you cannot play a CD, CD-RW, or DVD	84

If you cannot eject the CD, CD-RW, or DVD drive tray	85
If you hear an unfamiliar scraping or grinding sound	85
If the CD-RW drive stops writing	86
If you have problems with a hard drive	86
PC Card Problems	86
Network Problems	87
Error Messages	87
General Program Problems	89
A program crashes	89
A program stops responding	89
A solid blue screen appears	89
Error messages appear	89
E-Mail Problems	90
Resolving Other Technical Problems	90
If Your Computer Gets Wet	90
If You Drop or Damage Your Computer	91
Drivers	92
What Is a Driver?	92
Identifying Drivers	92
Reinstalling Drivers	93
Manually Reinstalling Drivers for Windows XP	94
Resolving Software and Hardware Incompatibilities	95
Using Microsoft® Windows® XP System Restore	96
Creating a Restore Point	97
Restoring the Computer to an Earlier Operating State	98
Undoing the Last System Restore	99

Reinstalling Microsoft® Windows® XP	99
Before You Reinstall	99
Reinstalling Windows XP	99
Reinstalling Drivers and Software	102

3 Adding and Replacing Parts

Replacing the Palm Rests	104
Adding Memory	105
Replacing the Hard Drive	108
Returning a Hard Drive to Dell	110

4 Appendix

Specifications	112
System Setup Overview	119
Viewing the System Setup Screens	119
System Setup Screens	119
Commonly Used Options	120
Changing the Boot Sequence	120
Dell Technical Support Policy (U.S. Only)	121
Definition of "Dell-Installed" Software and Peripherals	122
Definition of "Third-Party" Software and Peripherals	122
Returning Items for Warranty Repair or Credit	123
Contacting Dell	124
Regulatory Notices	140
NOM Information (Mexico Only)	142
CE Mark Notice	143
Limited Warranties and Return Policy	145
Limited Warranty for the U.S.	145
"Total Satisfaction" Return Policy (U.S. Only)	148

Limited Warranty Terms for Canada	149
"Total Satisfaction" Return Policy	152
Dell Software and Peripherals	153
One-Year End-User Manufacturer Guarantee (Latin America and the Caribbean Only)	154
Intel® Warranty Statement for Pentium® and Celeron® Processors Only (U.S. and Canada Only)	155
Index	157

CAUTION: Safety Instructions

Use the following safety guidelines to help ensure your own personal safety and to help protect your computer and working environment from potential damage.

General

- Do not attempt to service the computer yourself unless you are a trained service technician. Always follow installation instructions closely.
- If you use an extension power cable with your AC adapter, ensure that the total ampere rating of the products plugged in to the extension power cable does not exceed the ampere rating of the extension cable.
- Do not push objects into air vents or openings of your computer. Doing so can cause fire or electric shock by shorting out interior components.
- Do not store your computer in a low-airflow environment, such as a carrying case or a closed briefcase, while the computer is turned on. Restricting airflow can damage the computer or cause a fire.
- Keep your computer away from radiators and heat sources. Also, do not block cooling vents. Avoid placing loose papers underneath your computer; do not place your computer in a closed-in wall unit or on a bed, sofa, or rug.
- Place the AC adapter in a ventilated area, such as a desk top or on the floor, when you use it to run the computer or to charge the battery. Do not cover the AC adapter with papers or other items that will reduce cooling; also, do not use the AC adapter inside a carrying case.
- The AC adapter may become hot during normal operation of your computer. Use care when handling the adapter during or immediately after operation.
- Do not allow your portable computer to operate with the base resting directly on exposed skin for extended periods of time. The surface temperature of the base will rise during normal operation (particularly when AC power is present). Allowing sustained contact with exposed skin can cause discomfort or, eventually, a burn.
- Do not use your computer in a wet environment, for example, near a bath tub, sink, or swimming pool or in a wet basement.
- If your computer includes an integrated or optional (PC Card) modem, disconnect the modem cable if an electrical storm is approaching to avoid the remote risk of electric shock from lightning via the telephone line.

CAUTION: Safety Instructions (*continued*)

- To help avoid the potential hazard of electric shock, do not connect or disconnect any cables or perform maintenance or reconfiguration of this product during an electrical storm. Do not use your computer during an electrical storm unless all cables have been disconnected and the computer is operating on battery power.
- If your computer includes a modem, the cable used with the modem should be manufactured with a minimum wire size of 26 American wire gauge (AWG) and an FCC-compliant RJ-11 modular plug.
- Before you open the memory module/Mini PCI card/modem cover on the bottom of your computer, disconnect all cables from their electrical outlets and disconnect the telephone cable.
- If your computer has a modem RJ-11 connector and a network RJ-45 connector, insert the telephone cable into the RJ-11 connector, not the R-45 connector.
- PC Cards may become very warm during normal operation. Use care when removing PC Cards after their continuous operation.
- Before you clean your computer, disconnect the computer from the electrical outlet. Clean your computer with a soft cloth dampened with water. Do not use liquid or aerosol cleaners, which may contain flammable substances.

Power

- Use only the Dell-provided AC adapter approved for use with this computer. Use of another AC adapter may cause a fire or explosion.
- Before you connect the computer to an electrical outlet, check the AC adapter voltage rating to ensure that the required voltage and frequency match the available power source.
- To remove the computer from all power sources, turn the computer off, remove the battery pack, and disconnect the AC adapter from the electrical outlet.
- To help prevent electric shock, plug the AC adapter and device power cables into properly grounded power sources. These power cables may be equipped with 3-prong plugs to provide an earth grounding connection. Do not use adapter plugs or remove the grounding prong from the power cable plug. If you use a power extension cable, use the appropriate type, 2-prong or 3-prong, to mate with the AC adapter power cable.
- Be sure that nothing rests on your AC adapter's power cable and that the cable is not located where it can be tripped over or stepped on.

CAUTION: Safety Instructions (*continued*)

- If you are using a multiple-outlet power strip, use caution when plugging the AC adapter's power cable into the power strip. Some power strips may allow you to insert the plug incorrectly. Incorrect insertion of the power plug could result in permanent damage to your computer, as well as risk of electric shock and/or fire. Ensure that the ground prong of the power plug is inserted into the mating ground contact of the power strip.

Battery

- Use only Dell™ battery modules that are approved for use with this computer. Use of other types may increase the risk of fire or explosion.
- Do not carry a battery pack in your pocket, purse, or other container where metal objects (such as car keys or paper clips) could short-circuit the battery terminals. The resulting excessive current flow can cause extremely high temperatures and may result in damage to the battery pack or cause fire or burns.
- The battery poses a burn hazard if you handle it improperly. Do not disassemble it. Handle a damaged or leaking battery pack with extreme care. If the battery is damaged, electrolyte may leak from the cells and may cause personal injury.
- Keep the battery away from children.
- Do not store or leave your computer or battery pack near a heat source such as a radiator, fireplace, stove, electric heater, or other heat-generating appliance or otherwise expose it to temperatures in excess of 60°C (140°F). When heated to excessive temperatures, battery cells could explode or vent, posing a risk of fire.
- Do not dispose of your computer's battery in a fire or with normal household waste. Battery cells may explode. Discard a used battery according to the manufacturer's instructions or contact your local waste disposal agency for disposal instructions. Dispose of a spent or damaged battery promptly.

CAUTION: Safety Instructions (*continued*)

Air Travel

- Certain Federal Aviation Administration regulations and/or airline-specific restrictions may apply to the operation of your Dell computer while you are on board an aircraft. For example, such regulations/restrictions may prohibit the use of any personal electronic device (PED) that has the capacity for intentional transmission of radio frequency or other electromagnetic signals while on an aircraft.
 - In order to best comply with all such restrictions, if your Dell portable computer is equipped with Dell TrueMobile™ or some other wireless communication device, please disable this device before you board the aircraft and follow all instructions provided by airline personnel with regard to such device.
 - Additionally, the use of any PED, such as a portable computer, may be prohibited in aircraft during certain critical phases of flight, for example, takeoff and landing. Some airlines may further define the critical flight phase as any time the aircraft is below 3050 m (10,000 ft). Please follow the airline's specific instructions as to when the use of a PED is allowed.

EMC Instructions

Use shielded signal cables to ensure that you maintain the appropriate EMC classification for the intended environment. For parallel printers, a cable is available from Dell. If you prefer, you can order a cable from Dell at its worldwide website at www.dell.com.

Static electricity can harm electronic components inside your computer. To prevent static damage, discharge static electricity from your body before you touch any of your computer's electronic components, such as a memory module. You can do so by touching an unpainted metal surface on the computer's input/output panel.

When Using Your Computer

Observe the following safe-handling guidelines to prevent damage to your computer:

- When setting up the computer for work, place it on a level surface.
 - When traveling, do not check the computer as baggage. You can put your computer through an X-ray security machine, but never put your computer through a metal detector. If you have the computer checked by hand, be sure to have a charged battery available in case you are asked to turn on the computer.
 - When traveling with the hard drive removed from the computer, wrap the drive in a nonconducting material, such as cloth or paper. If you have the drive checked by hand, be ready to install the drive in the computer. You can put the hard drive through an X-ray security machine, but never put the drive through a metal detector.
 - When traveling, do not place the computer in overhead storage compartments where it could slide around. Do not drop your computer or subject it to other mechanical shocks.
 - Protect your computer, battery, and hard drive from environmental hazards such as dirt, dust, food, liquids, temperature extremes, and overexposure to sunlight.
 - When you move your computer between environments with very different temperature and/or humidity ranges, condensation may form on or within the computer. To avoid damaging the computer, allow sufficient time for the moisture to evaporate before using the computer.
-  **NOTICE:** When taking the computer from low-temperature conditions into a warmer environment or from high-temperature conditions into a cooler environment, allow the computer to acclimate to room temperature before turning on power.
- When you disconnect a cable, pull on its connector or on its strain-relief loop, not on the cable itself. As you pull out the connector, keep it evenly aligned to avoid bending any connector pins. Also, before you connect a cable make sure both connectors are correctly oriented and aligned.
 - Handle components with care. Hold a component such as a memory module by its edges, not its pins.
 - When preparing to remove a memory module from the system board or disconnect a device from the computer, turn off the computer, disconnect the AC adapter cable, and then wait 5 seconds before proceeding to help avoid possible damage to the system board.

When Using Your Computer (*continued*)

- Clean the display with a soft, clean cloth and water. Apply the water to the cloth; then stroke the cloth across the display in one direction, moving from the top of the display to the bottom. Remove moisture from the display quickly and keep the display dry. Long-term exposure to moisture can damage the display. *Do not* use a commercial window cleaner to clean your display.
- If your computer gets wet or is damaged, follow the procedures described in "Solving Problems" on page 90 or 91. If, after following these procedures, you confirm that your computer is not operating properly, contact Dell (see "Contacting Dell" on page 124 for the appropriate contact information).

When Working Inside Your Computer

Before removing or installing memory modules, Mini PCI cards, or modems, perform the following steps in the sequence indicated.

- ➡ **NOTICE:** The only time you should ever access the inside of your computer is when you are installing memory modules, a Mini PCI card, or a modem.
 - ➡ **NOTICE:** Wait 5 seconds after turning off the computer before disconnecting a device or removing a memory module, Mini PCI card, or modem to help prevent possible damage to the system board.
- 1 Shut down your computer and turn off any attached devices.
 - 2 Disconnect your computer and devices from electrical outlets to reduce the potential for personal injury or shock. Also, disconnect any telephone or telecommunication lines from the computer.
 - 3 Remove the main battery from the battery bay and, if necessary, the secondary battery from the module bay.

When Using Your Computer (*continued*)

- 4 Ground yourself by touching the unpainted metal surface of the I/O panel on the back of the computer.

While you work, periodically touch the I/O panel to dissipate any static electricity that might harm internal components.

Protecting Against Electrostatic Discharge

Static electricity can harm electronic components inside your computer. To prevent static damage, discharge static electricity from your body before you touch any of your computer's electronic components, such as a memory module. You can do so by touching an unpainted metal surface on the computer's I/O panel.

As you continue to work inside the computer, periodically touch an I/O connector to remove any static charge your body may have accumulated.

You can also take the following steps to prevent damage from electrostatic discharge (ESD):

- When unpacking a static-sensitive component from its shipping carton, do not remove the component from the antistatic packing material until you are ready to install the component. Just before unwrapping the antistatic packaging, be sure to discharge static electricity from your body.
- When transporting a sensitive component, first place it in an antistatic container or packaging.
- Handle all sensitive components in a static-safe area. If possible, use antistatic floor pads and workbench pads.



Battery Disposal

Your computer uses a lithium-ion battery and a nickel-metal reserve battery. For instructions about replacing the lithium-ion battery in your computer, refer to the section about replacing the battery in your Dell computer documentation. The reserve battery is a long-life battery, and it is very possible that you will never need to replace it. However, should you need to replace it, the procedure must be performed by an authorized service technician.

Do not dispose of the battery along with household waste. Contact your local waste disposal agency for the address of the nearest battery deposit site.

Ergonomic Computing Habits

 **CAUTION: Improper or prolonged keyboard use may result in injury.**

 **CAUTION: Viewing the display or external monitor screen for extended periods of time may result in eye strain.**

For comfort and efficiency, observe the following ergonomic guidelines when setting up and using your computer:

- Position your computer directly in front of you as you work.
- Adjust the tilt of the computer's display, its contrast and/or brightness settings, and the lighting around you (such as overhead lights, desk lamps, and the curtains or blinds on nearby windows) to minimize reflections and glare on the display.
- When using an external monitor with your computer, set the monitor at a comfortable viewing distance (usually 510 to 610 millimeters [20 to 24 inches] from your eyes). Make sure the monitor screen is at eye level or slightly lower when you are sitting in front of the monitor.
- Use a chair that provides good lower-back support.
- Keep your forearms horizontal with your wrists in a neutral, comfortable position while using the keyboard, touch pad, track stick, or external mouse.
- Always use the palm rest with the keyboard, touch pad, or track stick. Leave space to rest your hands when using an external mouse.
- Let your upper arms hang naturally at your sides.
- Sit erect with your feet resting on the floor and your thighs level.
- When sitting, make sure the weight of your legs is on your feet and not on the front of your chair seat. Adjust your chair's height or use a footrest, if necessary, to maintain proper posture.
- Vary your work activities. Try to organize your work so that you do not have to type for extended periods of time. When you stop typing, try to do things that use both hands.

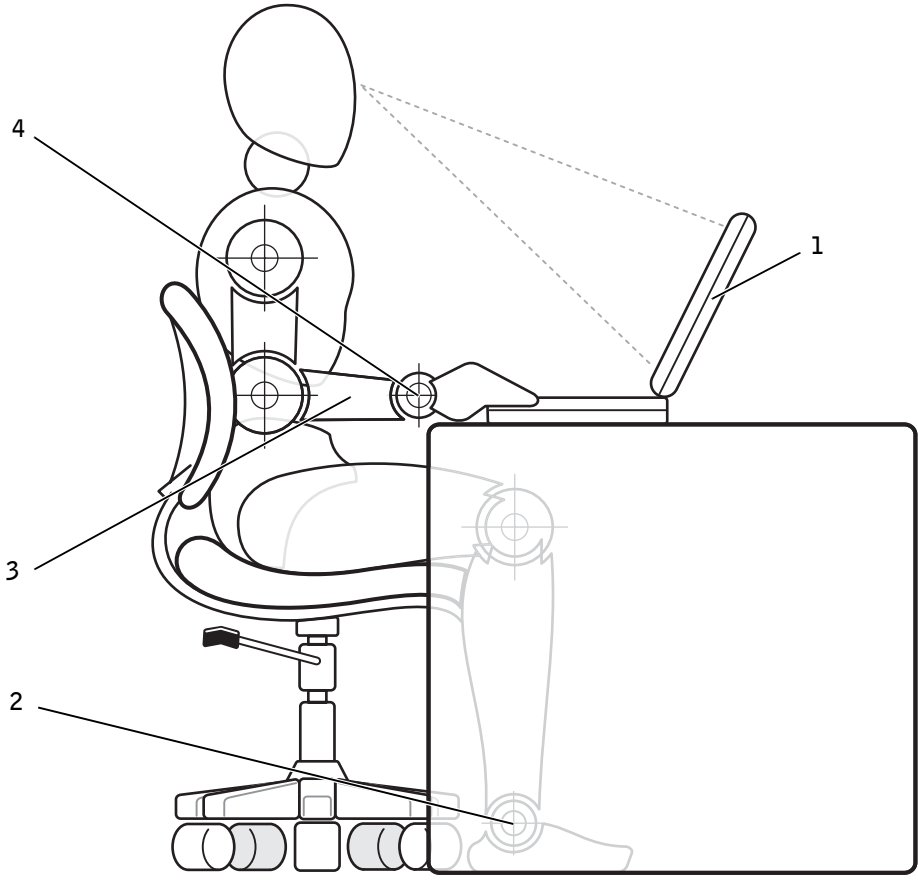

1 display screen at or below eye level

3 arms at desk level

2 feet flat on the floor

4 wrists relaxed and flat

SECTION 1

Setting Up and Using Your Computer

A Tour of Your Computer

Transferring Information to a New Computer With
Microsoft® Windows® XP

Setting Up a Home and Office Network With
Windows XP

Connecting to the Internet

Copying CDs

Turning Off the Computer

About the Module Bay

Swapping Devices While the Computer Is Turned Off

Swapping Devices While the Computer Is Running

Using the Keyboard and Touch Pad

Enabling the Infrared Sensor

Connecting a Television to the Computer

Setting Up the Dolby Headphone

Setting Up the Docking Device to Connect to a Network

Power Protection Devices

A Tour of Your Computer

Front View

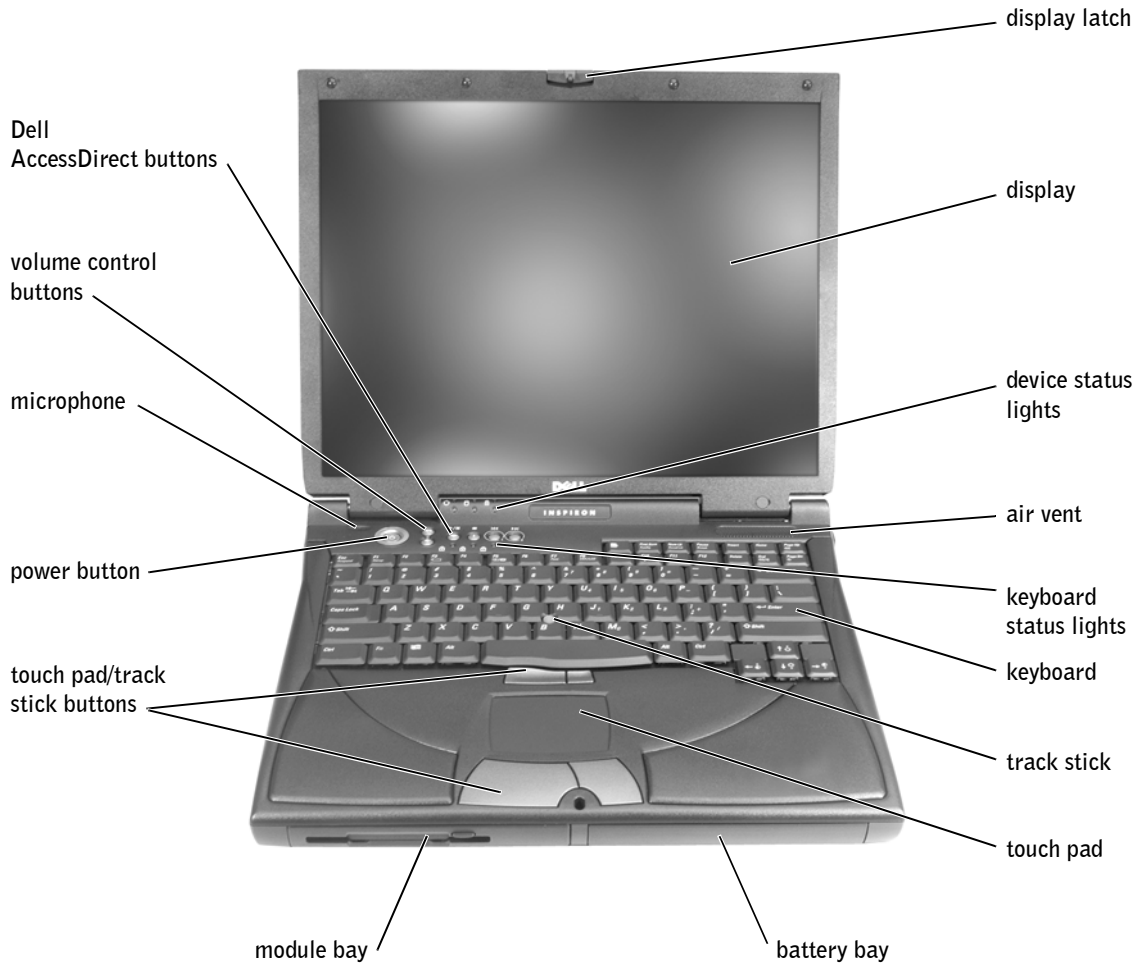



DISPLAY LATCH — Keeps the display closed.

DISPLAY — For more information on using your color display, see "Using the Display" in the *Tell Me How* help file. To access the help file, see page 72.

DEVICE STATUS LIGHTS

 Turns on when you turn on the computer.

 Turns on when the computer reads or writes data.

 **NOTICE:** To avoid loss of data, never turn off the computer while the  light is flashing.

 Turns on steadily or blinks when the computer is in a power management mode. It also blinks to indicate battery charge status.

If the computer is connected to an electrical outlet, the  light operates as follows:

- Solid green: The battery is charging.
- Flashing green: The battery is fully charged.

If the computer is running on a battery, the  light operates as follows:

- Off: The battery is adequately charged (or the computer is turned off).
- Flashing orange: The battery charge is low.
- Solid orange: The battery charge is critically low.

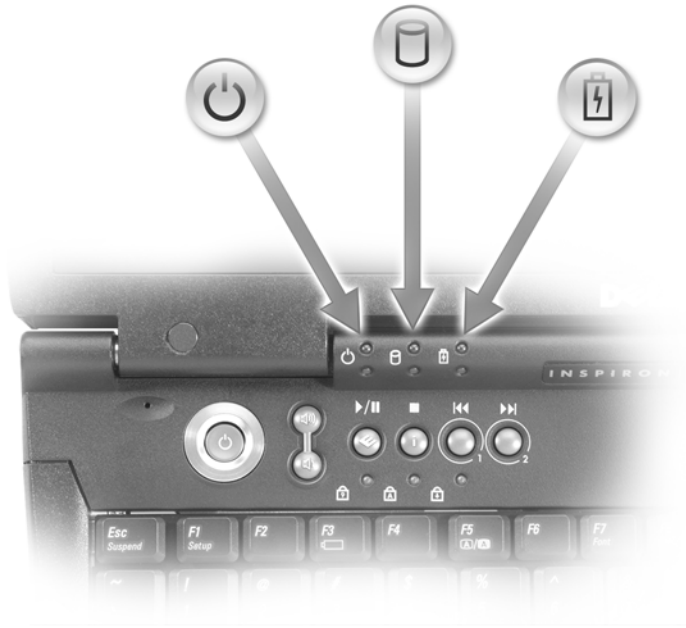



HINT: The computer turns on the fans when the computer gets hot. The fans may make noise, which is normal and does not indicate a problem with the fans or the computer

AIR VENTS — The computer uses an internal fan to create airflow through the vents, which prevents the computer from overheating.

CAUTION: Do not block, push objects into, or allow dust to accumulate in the air vents. Doing so can damage the computer or cause a fire.

KEYBOARD STATUS LIGHTS — The green lights located above the keyboard indicate the following:

-  Turns on when the numeric keypad is enabled
-  Turns on when the uppercase letter function is enabled
-  Turns on when the scroll lock function is enabled

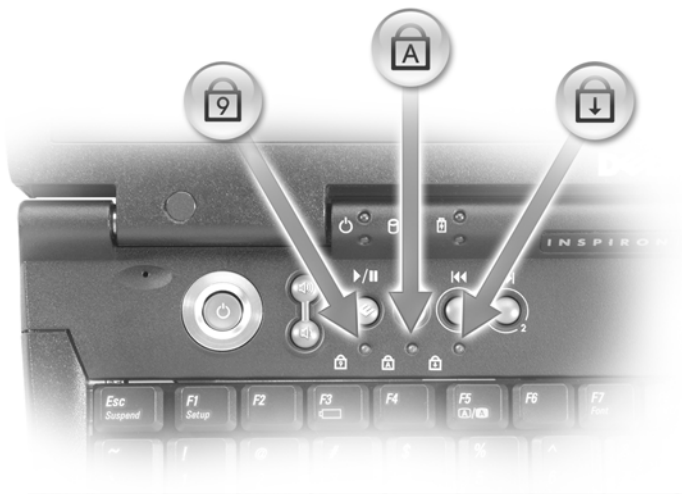

KEYBOARD — The keyboard includes a numeric keypad as well as the Microsoft® Windows® logo key . For information on supported keyboard shortcuts, see page 47.

TRACK STICK — Use the track stick and track stick buttons as you would use a mouse. See page 49 for more information.

TOUCH PAD — Use the touch pad and touch pad buttons as you would use a mouse. See page 49 for more information.

BATTERY BAY — When a battery is installed, you can use the computer without connecting it to an electrical outlet. See "Using a Battery" in the *Tell Me How* help file. To access the help file, see page 72.

MODULE BAY — You can install devices such as a CD drive, CD-RW drive, DVD drive, or Dell TravelLite™ module in the module bay.

TOUCH PAD/TRACK STICK BUTTONS — Correspond to the left and right buttons on a standard mouse.

DELL™ ACCESSDIRECT™ BUTTONS — Press these buttons to launch various resources, such as your default Internet browser and e-mail program. For more information, see page 44.

POWER BUTTON — Press the power button to turn on the computer or to enter or exit standby or hibernate mode.

If the computer stops responding, press and hold the power button until the computer turns off completely (which may take about 4 seconds).

NOTICE: Turn off your computer by performing a Windows shutdown (see page 42). Otherwise, you may lose data.

MICROPHONE — Allows you to record audio.

VOLUME CONTROL BUTTONS — Increase or decrease the speaker volume with these buttons. Alternatively, you can increase speaker volume by pressing

Fn **Page Up** and decrease speaker volume by pressing **Fn** **Page Dn**.

You can enable or disable (mute) the integrated stereo speakers or external speakers by pressing **Fn** **End**. When you mute music, the computer may take a moment to respond. Certain audio utilities installed on your computer also allow you to control speaker volume. If no sound comes from the speakers, press **Fn** **End** and check the volume control buttons to make sure that the sound is not disabled.

Left Side View

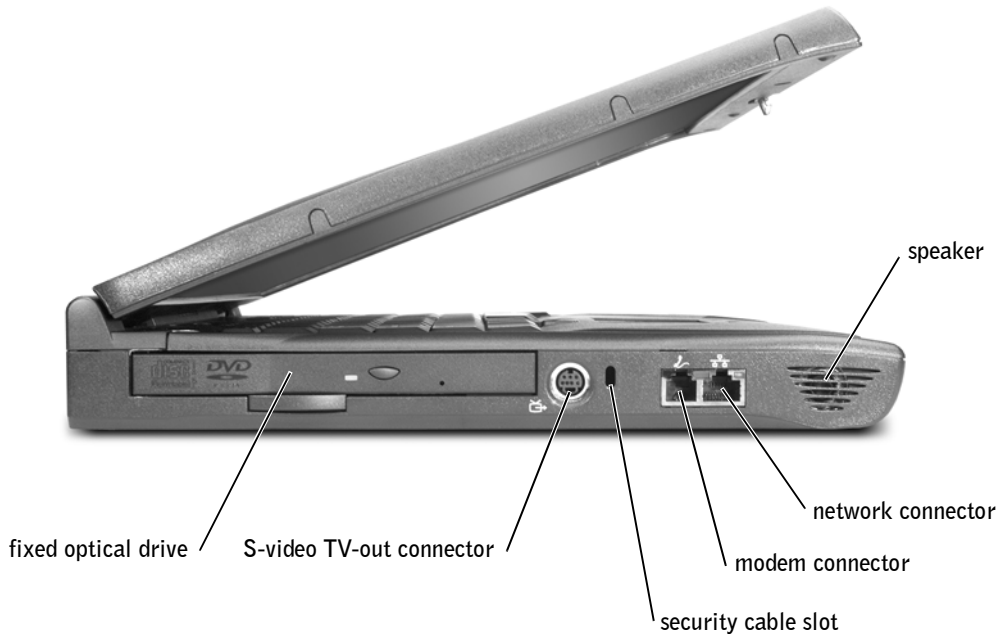

FIXED OPTICAL DRIVE — Accommodates devices such as a CD drive, DVD drive, CD-RW drive, or CD-RW/DVD combo drive.

S-VIDEO TV-OUT CONNECTOR



Connects your computer to a TV. Also connects S/PDIF capable devices using the TV/digital audio adapter cable. For more information, see "Playing CDs and Movies" in the *Tell Me How* help file. To access the help file, see page 72

SECURITY CABLE SLOT — Lets you attach a commercially available antitheft device to the computer. Instructions for installing antitheft devices are usually included with the device.

 **NOTICE:** Before you buy an antitheft device, ensure that it will work with the security cable slot.

MODEM CONNECTOR



Connect the telephone line to the modem connector. For information on using the modem, see the online modem documentation supplied with your computer. To access device user's guides, see the *Tell Me How* help file. To access the help file, see page 72.

NETWORK CONNECTOR



Connects the computer to a network. The lights next to the connector indicate activity for both wired and wireless network communications.

For information on using the network adapter, see the online network adapter documentation supplied with your computer. To access device user's guides, see the *Tell Me How* help file. To access the help file, see page 72.



NOTICE: The network connector is slightly larger than the modem connector. Do not plug a telephone line into the network connector.

SPEAKERS — Press the volume control buttons or volume control keyboard shortcuts to adjust the volume of the integrated speakers. For more information, see page 47.

Right Side View

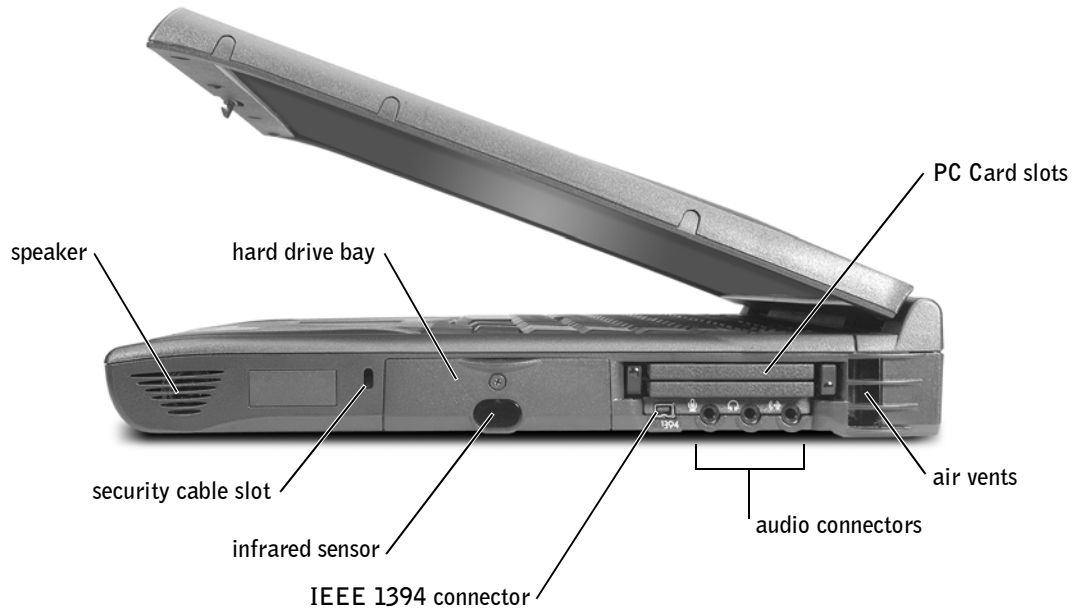

SPEAKERS — Press the volume control buttons or volume control keyboard shortcuts to adjust the volume of the integrated speakers. For more information, see page 47.

SECURITY CABLE SLOT — Lets you attach a commercially available antitheft device to the computer. Instructions for installing antitheft devices are usually included with the device.



NOTICE: Before you buy an antitheft device, ensure that it will work with the security cable slot.

HARD DRIVE — Reads and writes data on a hard disk.

INFRARED SENSOR — The infrared sensor lets you transfer files from your computer to another infrared-compatible device without using cable connections.

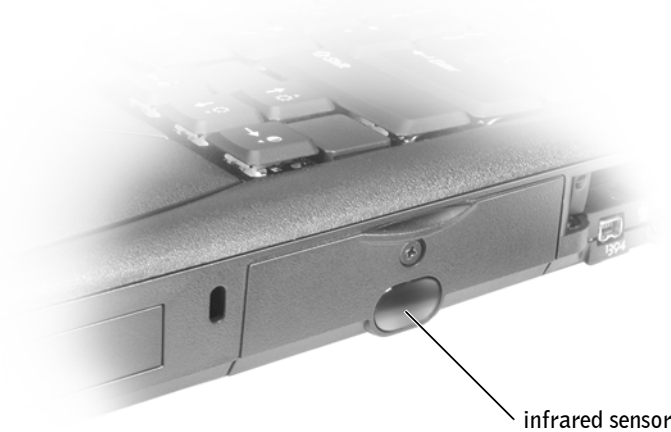

IEEE 1394 CONNECTOR — Use this connector to attach devices supporting IEEE 1394 high-speed transfer rates, such as some digital cameras and video cameras.

PC CARD SLOT — Has two connectors that support various types of PC Cards, including modems and network adapters. For more information, see "Using PC Cards" in the *Tell Me How* help file. To access the help file, see page 72.

AUDIO CONNECTORS

Attach record/playback devices, such as cassette players and CD players, to the ((→)) connector.

Attach headphones or speakers to the 🎧 connector.

Attach a microphone to the 🎤 connector.

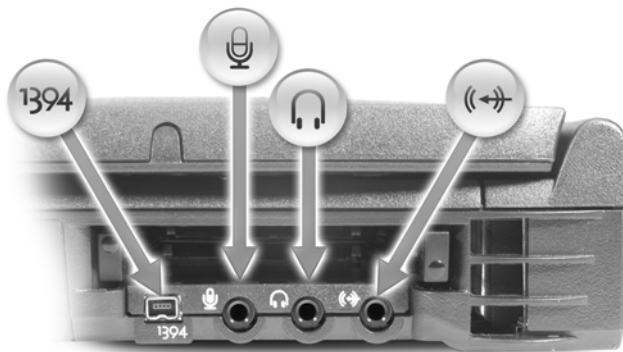

AIR VENTS — The computer uses an internal fan to create airflow through the vents, which prevents the computer from overheating.

⚠ CAUTION: Do not block, push objects into, or allow dust to accumulate in the air vents. Doing so can damage the computer or cause a fire.

Back View

➡ NOTICE: To avoid damaging the computer, wait 5 seconds after turning off the computer before you disconnect an external device.

⚠ CAUTION: Do not block, push objects into, or allow dust to accumulate in the air vents. Doing so can damage the computer or cause a fire.

📌 HINT: The computer turns on the fans when the computer gets hot. The fans may make noise, which is normal and does not indicate a problem with the fans or the computer.

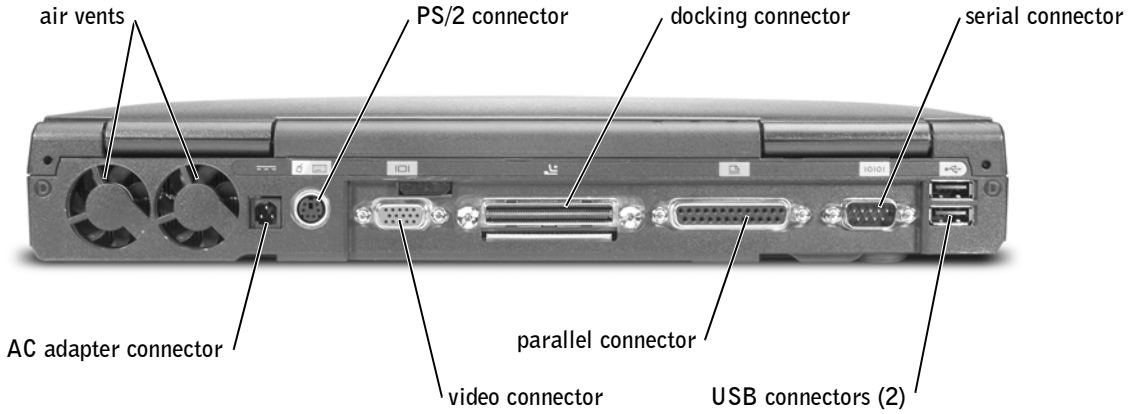

AIR VENTS — The computer uses an internal fan to create airflow through the vents, which prevents the computer from overheating.

HINT: The computer turns on the fans when the computer gets hot. The fans may make noise, which is normal and does not indicate a problem with the fans or the computer.

CAUTION: Do not block, push objects into, or allow dust to accumulate in the air vents. Doing so can damage the computer or cause a fire.

HINT: Use only the 90-watt AC adapter supplied with the computer.

AC ADAPTER CONNECTOR — Attach the 90-watt AC adapter to the computer.



The AC adapter converts AC power to the DC power required by the computer. You can connect the AC adapter with your computer turned either on or off.

⚠ CAUTION: The AC adapter works with electrical outlets worldwide. However, power connectors and power strips vary among countries. Using an incompatible cable or improperly connecting the cable to the power strip or electrical outlet may cause fire or equipment damage.

➡ NOTICE: When you disconnect the AC adapter from the computer, grasp the adapter cable connector, not the cable itself, and pull firmly but gently to avoid damaging the cable.

PS/2 CONNECTOR



Connects PS/2-compatible devices, such as a mouse, keyboard, or external numeric keypad.

Shut down the computer before attaching or removing a PS/2-compatible device. If the device does not work, install the device drivers from the floppy disk or CD that came with the device, and restart the computer.

✍ HINT: You can use the integrated keyboard and an external keyboard at the same time. When you attach a PS/2 keyboard or PS/2 numeric keypad, the integrated keypad is disabled.

VIDEO CONNECTOR



Connects an external monitor. See "Using the Display" in the *Tell Me How* help file. To access the help file, see page 72.

DOCKING CONNECTOR

 **HINT:** Docking devices may not be available in all countries.



Connects the optional docking device. A docking device allows you to easily use external devices with your computer, such as an external keyboard, mouse, and monitor.

See the documentation that came with your docking device for additional information.

PARALLEL CONNECTOR



Connects a parallel device, such as a printer.

SERIAL CONNECTOR



Connects serial devices, such as a mouse or handheld device.

USB CONNECTOR



Connects USB devices, such as a mouse, keyboard, or printer.

Bottom View

memory module and
modem cover

device latch releases

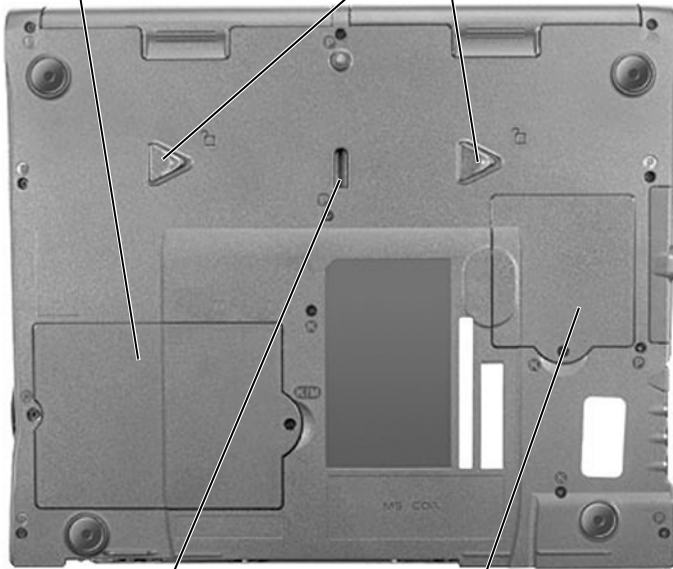

docking device latch

Mini PCI card cover

MEMORY MODULE AND MODEM COVER — Protects the memory module(s) and the modem daughter card. For more information, see page 103.

DEVICE LATCH RELEASES — Press a latch release to remove a device in the module bay. For more information, see page 42.

MINI PCI CARD COVER — Covers the compartment that contains the optional Mini PCI card.

DOCKING DEVICE LATCH — Latches onto the docking device.

Setting Up a Printer

 **NOTICE:** Complete the operating system setup before you connect a printer to the computer.

See the documentation that came with the printer for setup information, including how to:

- Obtain and install updated drivers
- Connect the printer to the computer
- Load paper and install the toner or ink cartridge
- Contact the printer manufacturer for technical assistance

Printer Cable

Your printer connects to your computer with either a USB cable or a parallel cable. Your printer may not come with a printer cable, so if you purchase a cable separately, ensure that it is compatible with your printer. If you purchased a printer cable at the same time you purchased your computer, the cable may arrive in the computer box.

Connecting a Parallel Printer

- 1 Complete the operating system setup, if you have not already done so.
- 2 Turn off the computer (see page 42).

 **NOTICE:** For best results, use a 3-m (10-ft) or shorter parallel cable.

- 3 Attach the parallel printer cable to the parallel connector on the computer and tighten the two screws. Attach the cable to the connector on the printer and snap the two clips into the two notches.

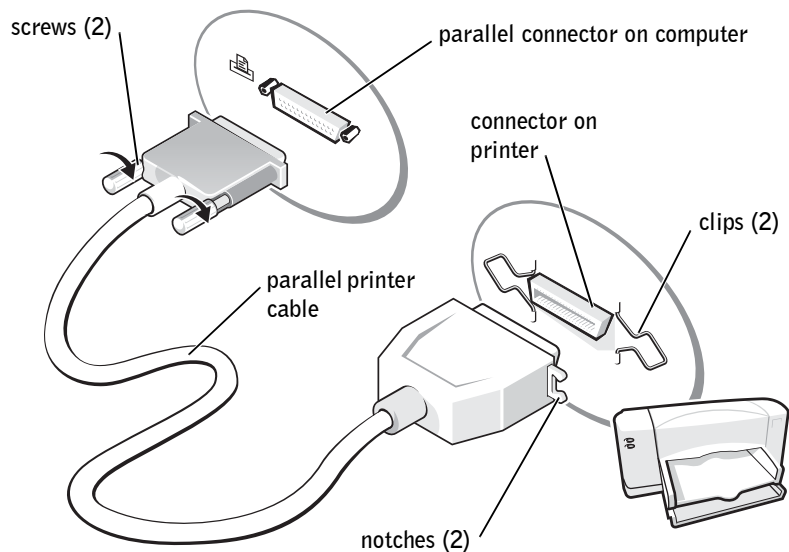

- 4 Turn on the printer and then turn on the computer. If the **Add New Hardware Wizard** window appears, click **Cancel**.
- 5 Install the printer driver if necessary. See the documentation that came with your printer.

Connecting a USB Printer

- 1 Complete the operating system setup if you have not already done so.
- 2 Install the printer driver if necessary. See the documentation that came with your printer.
- 3 Attach the USB printer cable to the USB connectors on the computer and the printer. The USB connectors fit only one way.

 **HINT:** You can connect USB devices while the computer is turned on.

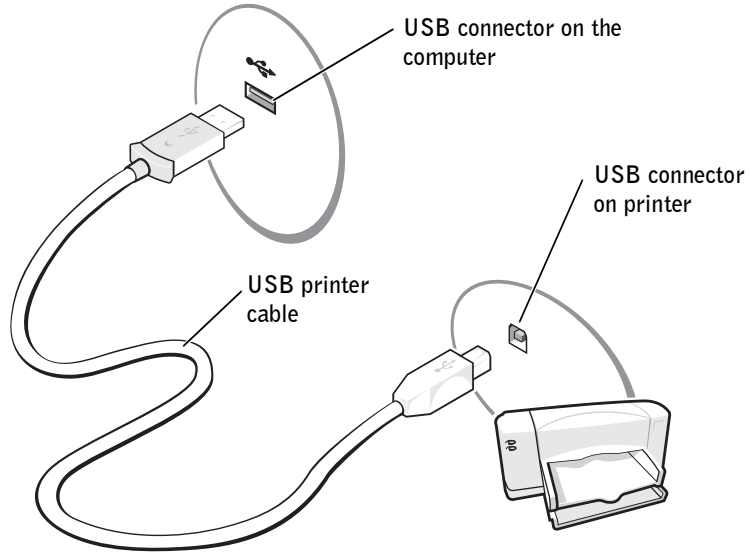

Transferring Information to a New Computer With Microsoft® Windows® XP

Windows XP provides a **Files and Settings Transfer Wizard** to move data, such as e-mails, window sizes, toolbar settings, and Internet bookmarks, from one computer to another. First you collect the data from the source computer, and then you import the data to the new computer.

If the source computer uses another Windows operating system, you can launch the wizard from the Windows XP operating system CD or from a floppy disk created on the computer that is running Windows XP. You can transfer the data to the new computer over a network or serial connection, or you can store it on a removable medium, such as a floppy disk, a Zip disk, or a writable CD.

- 1 On the computer running Windows XP, click the **Start** button, point to **All Programs**→**Accessories**→**System Tools**, and then click **Files and Settings Transfer Wizard**.

- 2 On the welcome screen, click **Next**.
- 3 On the **Which computer is this?** screen, select **New Computer**, and then click **Next**.
- 4 Follow the instructions on the screen.

Setting Up a Home and Office Network With Windows XP

Windows XP provides a **Network Setup Wizard** to guide you through the process of sharing files, printers, or an Internet connection between computers in a home or small office.

- 1 Click the **Start** button, point to **All Programs**→**Accessories**→**Communications**, and then click **Network Setup Wizard**.
- 2 On the welcome screen, click **Next**.
- 3 Click **checklist for creating a network**.
- 4 Complete the checklist and required preparations, and then return to the **Network Setup Wizard**.
- 5 Follow the instructions on the screen.

 **HINT:** Selecting the **This computer connects directly to the Internet** connection method enables the integrated firewall provided with Windows XP.

 **HINT:** ISPs vary by country.

Connecting to the Internet

To connect to the Internet, you need a modem or network connection and an Internet service provider (ISP), such as AOL or MSN. Your ISP will offer one or more of the following Internet connection options:

- Dial-up connections that provide Internet access through a phone line. Dial-up connections are considerably slower than DSL and cable modem connections.
- DSL connections that provide high-speed Internet access through your existing phone line. With a DSL connection, you can access the Internet and use your phone on the same line simultaneously.
- Cable modem connections that provide high-speed Internet access through your local cable TV line.

If you are using a dial-up connection, connect a telephone line to the modem connector on your computer and to the telephone wall jack before you set up your Internet connection. If you are using a DSL or cable modem connection, contact your ISP for setup instructions.

Setting Up Your Internet Connection

To set up an AOL or MSN connection:

- 1 Save and close any open files, and exit any open programs.
- 2 Double-click the **MSN Explorer** or **AOL** icon on the Windows® desktop.
- 3 Follow the instructions on the screen to complete the setup.

If you do not have an **MSN Explorer** or **AOL** icon on your desktop or if you want to set up an Internet connection with a different ISP:

- 1 Save and close any open files, and exit any open programs.
- 2 Click the **Start** button and click **Internet Explorer**.
The **New Connection Wizard** appears.
- 3 Click **Connect to the Internet**.
- 4 In the next window, click the appropriate option:
 - If you do not have an ISP and want to select one, click **Choose from a list of Internet service providers (ISPs)**.
 - If you have already obtained setup information from your ISP but you did not receive a setup CD, click **Set up my connection manually**.
 - If you have a CD, click **Use the CD I got from an ISP**.

- 5 Click **Next**.

If you selected **Set up my connection manually**, continue to step 6. Otherwise, follow the instructions on the screen to complete the setup.

- 6 Click the appropriate option under **How do you want to connect to the Internet?**, and then click **Next**.
- 7 Use the setup information provided by your ISP to complete the setup.



HINT: If you do not know which type of connection to select, contact your ISP.

If you are having problems connecting to the Internet, see "Modem and Internet Connection Problems" on page 79. If you cannot connect to the Internet but have successfully connected in the past, the ISP might have a service outage. Contact your ISP to check the service status, or try connecting again later.

Copying CDs

The information in this section is based on the Roxio Easy CD Creator Basic documentation that came with your computer. See the following section, "Using Easy CD Creator Basic," for instructions on how to locate that documentation.

To burn CDs, you need to use CD-burner software. Roxio Easy CD Creator Basic is your computer's CD-burner software. The software includes these project programs that enable you to record specialty CDs for different types of uses:

- DirectCD allows you to format a blank CD-R or CD-RW disc so that you can use Microsoft® Windows® Explorer to drag and drop data files to the CD-RW drive. You can use a DirectCD-formatted CD-RW disc like another hard drive on your computer because CD-RW discs are fully rewritable (CD-R discs can be used with DirectCD, but that media type has overwriting limitations—see "Using Blank CD-R Discs or Blank CD-RW Discs" on page 40 for recording media differences).
- MusicCD allows you to burn custom music CDs.
- DataCD allows you to copy a variety of your documents, such as spreadsheet or accounting files, to a CD for permanent storage.
- Disc Copier allows you to make a backup copy of almost any type of CD. This program allows you to make a copy of a CD for everyday use so that you can archive and save the original copy. (Disc Copier is titled "CD Copier" in some versions of Roxio CD Creator Basic.)

All four project programs are available on the Easy CD Creator Basic **Select a Project** menu screen. To view the **Select a Project** menu screen, click the **Start** button, point to **All Programs**→**Roxio Easy CD Creator**, and then click **Project Selector**.

 **HINT:** Ensure that you follow all copyright laws when you create CDs.

 **HINT:** The information in this section also applies to using Easy CD Creator Basic with a DVD+RW or a DVD+R drive.

 **HINT:** Some music and game CDs are copy-protected. If you have a CD that cannot be copied, you must use the original CD for everyday use.

Using Easy CD Creator Basic

See the Easy CD Creator Basic documentation for instructions on how to use the program, information about different recording techniques, and CD media limitations. The Easy CD Creator Basic documentation is located in the Microsoft® Windows® XP Help and Support Center (see "Accessing Help" on page 72). The documentation is also provided on the *Drivers and Utilities* CD, which is included with your computer. Each Easy CD Creator Basic project program also has thorough online help files.

Using Blank CD-R Discs or Blank CD-RW Discs

Your CD-RW drive writes to two different types of recording media—CD-R and CD-RW discs. Use blank CD-R (CD-Recordable) disks to record music or permanently store data files. After creating a CD-R disc, you cannot write to that disc again without changing your method of recording (see the Roxio documentation for more information). Use blank CD-RW (CD-ReWritable) discs when you want to write, erase, rewrite, and update your files onto CDs.

Helpful Tips

- You must use the Easy CD Creator Basic project programs to copy and record all music and data CDs. You can use Windows Explorer to drag and drop files to a CD-R or CD-RW disc only after you first use DirectCD to format the disc.
- You must use CD-R discs to burn music CDs that you want to play in regular stereos. CD-RW discs do not play in most home or car stereos.
- If you want to copy files from the Internet or files from a floppy or Zip drive, copy those files to your hard drive first, and then burn your CD. Your CD-RW drive requires a steady stream of data to properly record. Direct Internet downloads, floppy drives, and Zip drives may not be able to provide a steady data stream to your CD-RW drive.
- Music MP3 files can be played only on MP3 players or on computers that have MP3 software installed.
- Ensure that you set the sampling rate to at least 128 Kbps when you burn MP3 files to a CD. Otherwise, recording errors may occur.

- Do not burn a blank CD-R or CD-RW disc to its maximum capacity; for example, do not copy a 650-MB file to a 650-MB blank CD. The CD-RW drive needs 1 or 2 MB of the blank CD to finalize the recording.
- Use a blank CD-RW disc to practice CD recording until you are familiar with CD recording techniques. If you make a mistake, you can erase the CD-RW disc and try again. You can also use blank CD-RW discs to test music file projects before you record the project permanently to a blank CD-R disc.
- See the Roxio support website at support.roxio.com for additional helpful tips.

How to Copy a CD

The procedure assumes that your computer is equipped with a single CD-RW drive (without an additional CD drive). If your computer is equipped with both types of drives, see the Roxio documentation for instructions on how to copy CDs from a CD drive to a CD-RW drive.

- 1 Click the **Start** button, point to **All Programs**→ **Roxio Easy CD Creator**, and then click **Project Selector**.

The **Select a Project** window appears.

- 2 Click **Disc Copier**. (Disc Copier is titled "CD Copier" in some versions of Easy CD Creator Basic.)

The **Disc Copier** window appears and displays your CD-RW drive in the **Copy from** and the **Record to** lists.

- 3 Insert the source CD that you want to copy into the CD-RW drive.

The Disc Copier project program briefly checks the source CD in the CD-RW drive to ensure that it is a readable CD.

- 4 Click **Copy**.

Depending on the size of the files that are being copied, the copy process may take a few minutes.

- 5 After the source CD is copied, remove the source CD from the CD-RW drive tray.

The CD-RW drive tray opens automatically after the source CD is copied.



HINT: If you have a DVD/CD-RW combo drive and experience recording problems, check the Roxio support website at support.roxio.com for available software patches.

 **HINT:** You must use CD-R discs to burn music CDs that you want to play in regular stereos. CD-RW discs do not play in most home or car stereos.

 **HINT:** If you are having difficulties turning off your computer, see "General Program Problems" on page 89.

- 6 Insert a blank CD into the CD-RW drive and close the tray. The recording starts automatically.
- 7 After the recording completes, click **OK**.

Turning Off the Computer

 **NOTICE:** To prevent data loss, you must turn off your computer through the **Start** menu rather than by pressing the power button.

- 1 Save and close any open files and exit any open programs.
- 2 Click the **Start** button and then click **Turn off Computer**.
- 3 Click **Turn off**.

The computer automatically turns off after the shutdown process finishes.

About the Module Bay

You can install devices such as a floppy drive, CD drive, CD-RW drive, DVD drive, DVD/CD-RW drive, Zip drive, second hard drive, or second battery in the module bay.

 **NOTICE:** To prevent damage to the docking connector, do not remove or replace devices while the computer is connected to a docking device.

Swapping Devices While the Computer Is Turned Off

- 1 Save and close any open files, exit any open programs, and shut down the computer (see page 42).
- 2 If the computer is connected (docked) to a docking device, undock it.
- 3 Close the display and turn the computer over.
- 4 Slide and hold the latch release, and pull the device out of the bay.

 **NOTICE:** To prevent damage to devices, place them in a travel case when they are not installed in the computer. Store devices in a dry, safe place, and avoid pressing down on them or placing heavy objects on top of them.

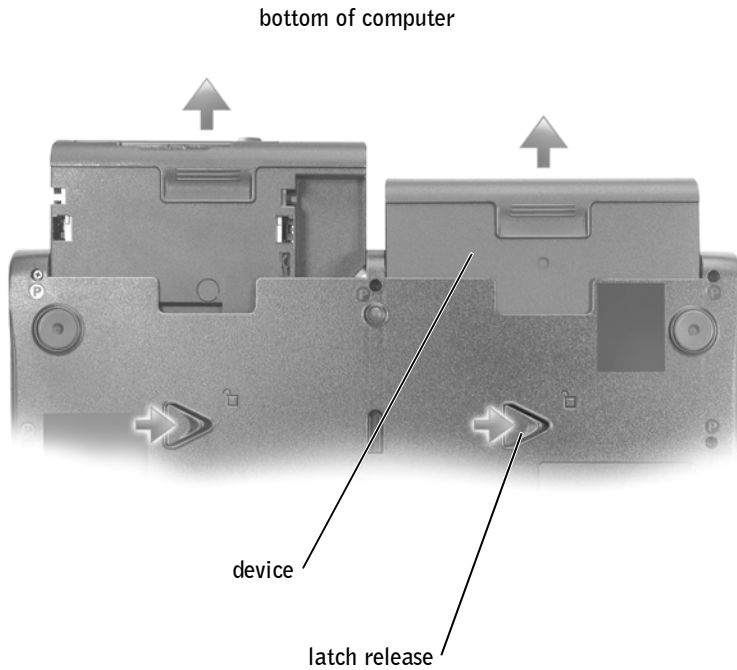

- ➔ **NOTICE:** Insert devices before you dock and turn on the computer.
- 5 Insert the new device into the bay, and push it until you feel a click.
 - 6 Turn on the computer.

Swapping Devices While the Computer Is Running

NOTICE: To prevent damage to the docking connector, do not remove or replace devices while the computer is connected to a docking device.

- 1 Double-click the **Unplug or Eject Hardware** icon on the taskbar.
- 2 Click the device you want to eject.
- 3 Keep the display open, and tilt the computer back so that you can access the bottom of the computer.
- 4 Slide and hold the latch release, and pull the device out of the bay.
- 5 Insert the new device into the bay, and push it until you feel a click.
- 6 If necessary, enter your password to unlock your computer.

Using the Keyboard and Touch Pad

Dell™ AccessDirect™ Buttons



Button Functions

- 1** Provides access to support and educational tools that Dell installed on your computer.
- 2** Launches your default Internet browser.
- 3** Launches www.dell.com; is reprogrammable to launch a program of your choice.
- 4** Opens your default e-mail program; is reprogrammable to launch a program of your choice.

Reprogramming the Buttons

To change the reprogrammable button settings, to find information on using the button, or to change the button scheme to control CD or DVD player functions:



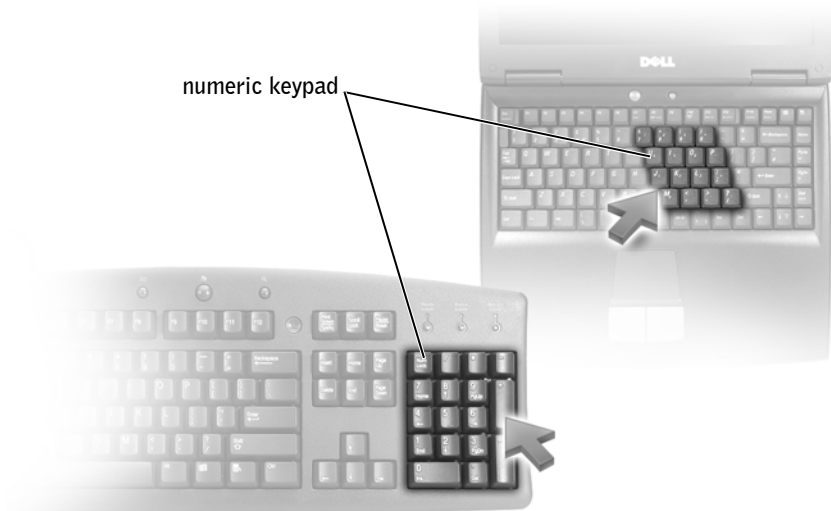

- 1** Click the **Start** button, click **Control Panel**, and then double-click the **Keyboard** icon.
- 2** Click the **AccessDirect** tab.
- 3** Click the **Help** button and follow the instructions on the screen.

Numeric Keypad



HINT: When you connect an external PS/2 keyboard or PS/2 keypad to the computer, the keypad is disabled.

The numeric keypad functions like the numeric keypad on an external keyboard. Each key on the keypad has multiple functions. The keypad numbers and symbols are marked in blue on the right of the keypad keys.

- To enable the keypad, press . The  light indicates that the keypad is active.
- To use the numeric function when the keypad is enabled, press  and the desired key.
- To disable the keypad, press  again.

Keyboard Shortcuts

System Functions



Opens the **Windows Security** window



Enables and disables the numeric keypad



Enables and disables the scroll lock

Display Functions



Switches the video image to the next display option. The options include the integrated display, an external monitor, and both displays simultaneously.



Increases brightness on the integrated display only (not on an external monitor).



Decreases brightness on the integrated display only (not on an external monitor).

Power Management



Activates a power management mode. You can reprogram this keyboard shortcut to activate a different power management mode using the **Advanced** tab in the **Power Options Properties** window.

Speaker Functions



Increases the volume of the integrated speakers and external speakers, if attached



Decreases the volume of the integrated speakers and external speakers, if attached



Enables and disables the integrated speakers and external speakers, if attached

Microsoft® Windows® Logo Key Functions



Minimizes all open windows



Maximizes all windows



Runs Windows Explorer



Opens the **Run** dialog box



Opens the **Search Results** dialog box



Opens the **Search Results-Computer** dialog box (if the computer is connected to a network)



Opens the **System Properties** dialog box

To adjust keyboard operation, such as the character repeat rate, click the **Start** button, click **Control Panel**, and then click **Printers and Other Hardware**.

Touch Pad

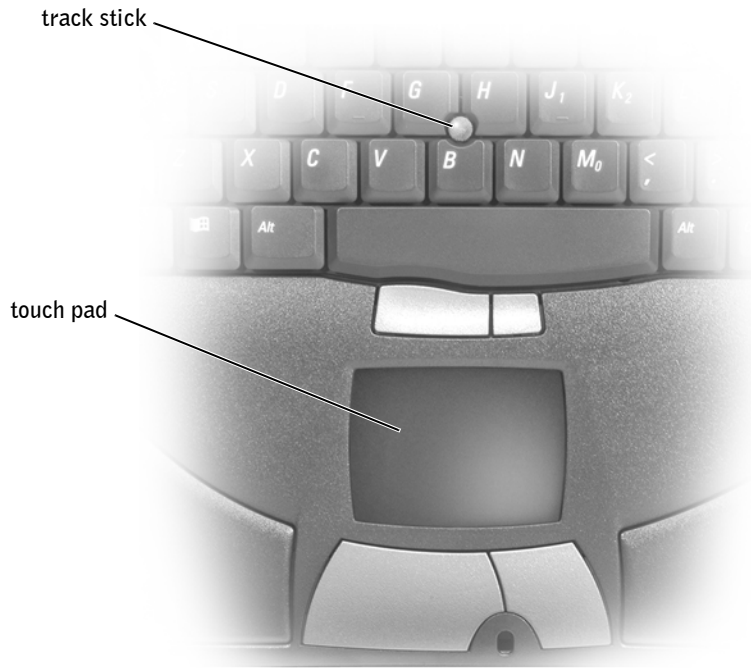

The touch pad detects the pressure and movement of your finger to allow you to move the cursor on the display. Use the touch pad and touch pad buttons as you would use a mouse.

- To move the cursor, lightly slide your finger over the touch pad.
- To select an object, lightly tap once on the surface of the touch pad or use your thumb to press the left touch pad button.
- To select and move (or drag) an object, position the cursor on the object and tap down-up-down on the touch pad. On the second down motion, leave your finger on the touch pad and move the selected object by sliding your finger across the surface.

- To double-click an object, position the cursor on the object and tap twice on the touch pad or use your thumb to press the left touch pad button twice.

You can also use the track stick to move the cursor. Press the track stick left, right, up, or down to change the direction of the cursor on the display. Use the track stick and track stick buttons as you would use a mouse.

Customizing the Touch Pad and Track Stick

You can disable the touch pad and track stick or adjust their settings using the **Mouse Properties** window.

- 1 Click the **Start** button and click **Control Panel**.
- 2 Click **Printers and Other Hardware** and click **Mouse**.
- 3 In the **Mouse Properties** window, click the **Device Settings** tab.

To disable the touch pad or mouse, highlight the device and click **Disable**. (If your computer is docked and connected to a PS/2 mouse, the touch pad and track stick may already be disabled.)

To change the touch pad or mouse settings, highlight the device, click **Settings**, select the desired setting(s), and then click **Apply**.

- 4 Click **OK** to save the settings and close the window, and then click **OK** again to exit the **Mouse Properties** window.

Changing the Track Stick Cap

You can replace your track stick cap if it wears down from prolonged use or if you prefer a different color. You can purchase additional caps by visiting the Dell website at www.dell.com.





- 1 Pull the cap off the track stick.
 - 2 Align the new cap over the square track stick post and gently press the cap down onto the post.
- ➔ NOTICE:** The track stick can damage the display if it is not properly seated on the post.
- 3 Test the track stick to ensure that the cap is seated properly.

Enabling the Infrared Sensor

- 1 Enter the system setup program:
 - a Turn on your computer.
 - b Press **F2** when the Dell™ logo appears.
- 2 Press **Alt** **P -** until you locate **Infrared Data Port** under **Basic Device Configuration**.
- 3 Press the down-arrow key to highlight **Disabled** next to **Infrared Data Port**.

 **HINT:** You cannot use the infrared sensor when the computer is docked.

- 4 Press the right-arrow key to change the setting to a COM port.
Ensure that the COM port that you select is different from the COM port assigned to the serial connector.
- 5 Press the down-arrow key to select **Infrared Mode**, and press the right-arrow key to change the setting to **Fast IR** or **Slow IR**.
Dell recommends that you use **Fast IR**. If the infrared device cannot communicate with your computer, turn off the computer and repeat steps 1 through 5 to change the setting to **Slow IR**.
- 6 Press  to save the changes and exit the system setup program.
If you are prompted to restart your computer, click **Yes**.
- 7 Follow the instructions on the screen while the infrared sensor driver is being installed.
- 8 At the end of the installation process, click **Yes** to restart the computer.

 **HINT:** If the infrared device cannot communicate with your computer after you repeat steps 1 through 5 to change the system setup program setting to **Slow IR**, contact the infrared device manufacturer.

 **HINT:** Not all of the video and audio cables for connecting your computer to a television are included with your computer. Additional cables may be purchased at most consumer electronics stores.

After you enable the infrared sensor, you can use it to establish a link to an infrared device. To set up and use an infrared device, see the infrared device documentation and the Windows XP Help and Support Center (to access help, see page 72).

Connecting a Television to the Computer

Your computer has an S-video TV-out connector that, together with the included TV/digital audio adapter cable, enables you to connect the computer to a television and/or stereo audio device. The TV/digital audio adapter cable provides connections for S-video, composite video, and S/PDIF digital audio.

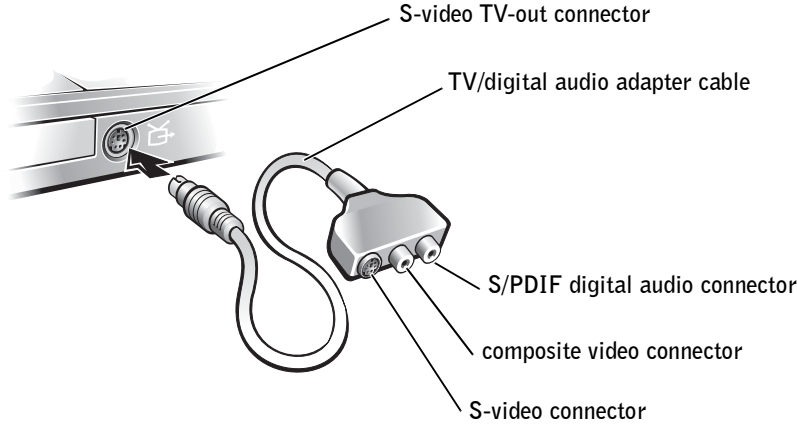

For televisions and audio devices without support for S/PDIF digital audio, you can use the audio connector on the side of the computer to connect the computer to your television or audio device.

Dell recommends that you connect video and audio cables to your computer in one of the following combinations:

- S-video and standard audio (see page 54)
- S-video and digital audio (see page 56)
- Composite video and standard audio (see page 58)
- Composite video and digital audio (see page 60)

When you complete the cable connection, see "Enabling the Display Settings for a Television" on page 61 to ensure that the computer recognizes and works properly with the television. Additionally, if you are using S/PDIF digital audio, see "Using S/PDIF Digital Audio" on page 62.

HINT: Diagrams for each connection combination appear at the beginning of each subsection to help you determine which method you should use.

S-Video and Standard Audio

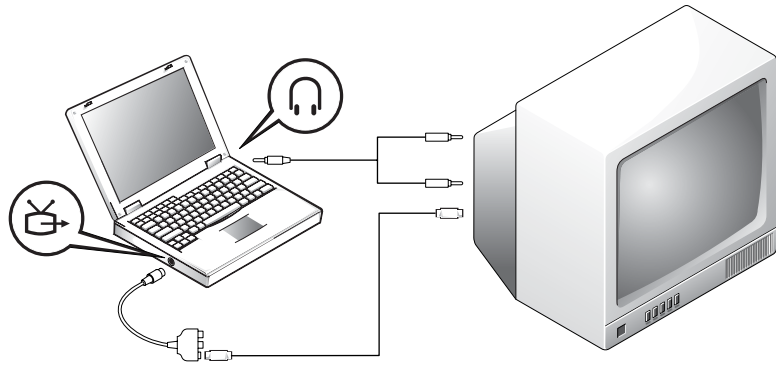

Before you begin, ensure that you have the following cables:

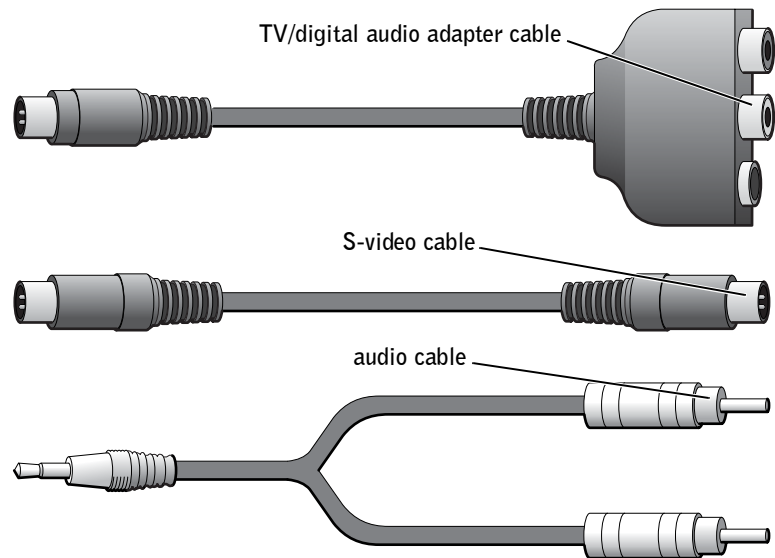

- 1 Turn off the computer and the television and/or audio device you want to connect.

- 2 Connect the TV/digital audio adapter cable to the S-video TV-out connector on your computer.
- 3 Plug one end of the S-video cable into the S-video connector on the TV/digital audio adapter cable.

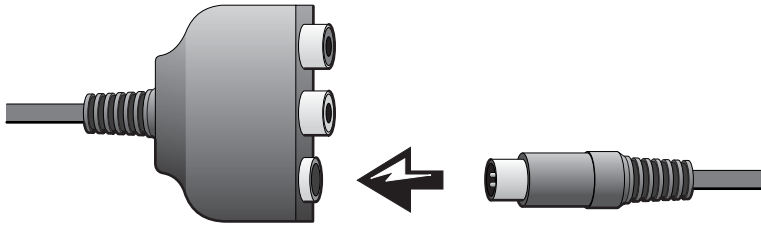

- 4 Plug the other end of the S-video cable into your television.
- 5 Plug the single-connector end of the audio cable into the headphone connector on your computer.

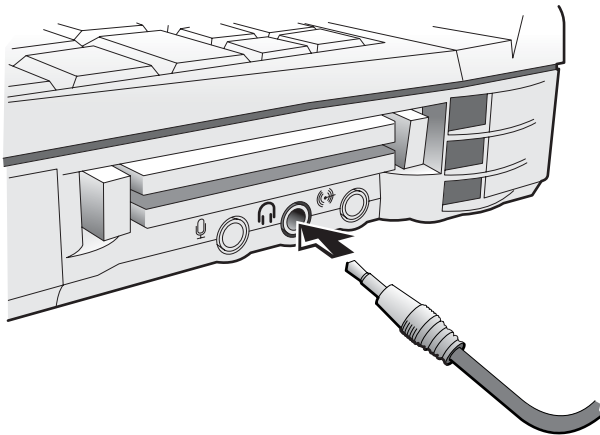

- 6 Plug the two RCA connectors on the other end of the audio cable into the audio input connectors on your television or other audio device.
- 7 Turn on the television and any audio device you connected, and then turn on the computer.
- 8 See "Enabling the Display Settings for a Television" on page 61 to ensure that the computer recognizes and works properly with the television.

 **HINT:** You can connect an S-video cable directly to the S-video connector on the computer (without the video adapter cable) if your television or audio device supports S-video but not S/PDIF digital audio.

S-Video and Digital Audio

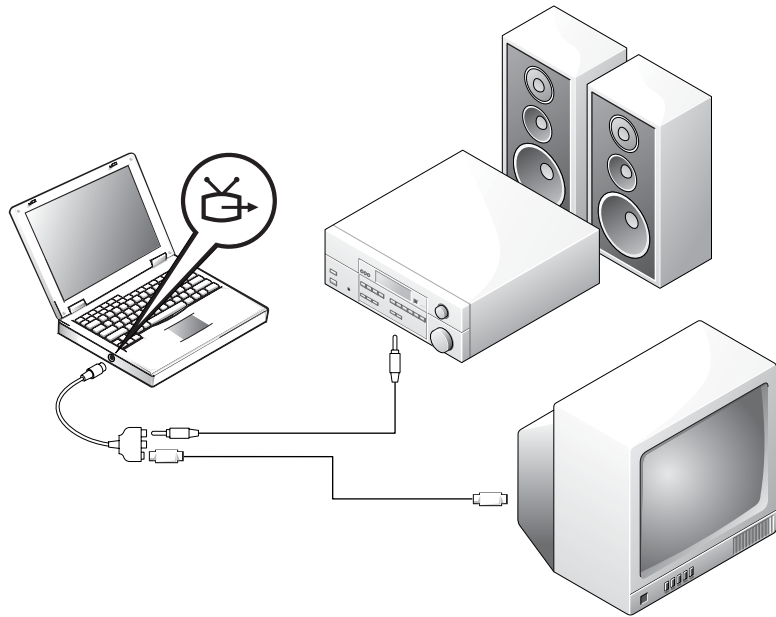

Before you begin, ensure that you have the following cables:

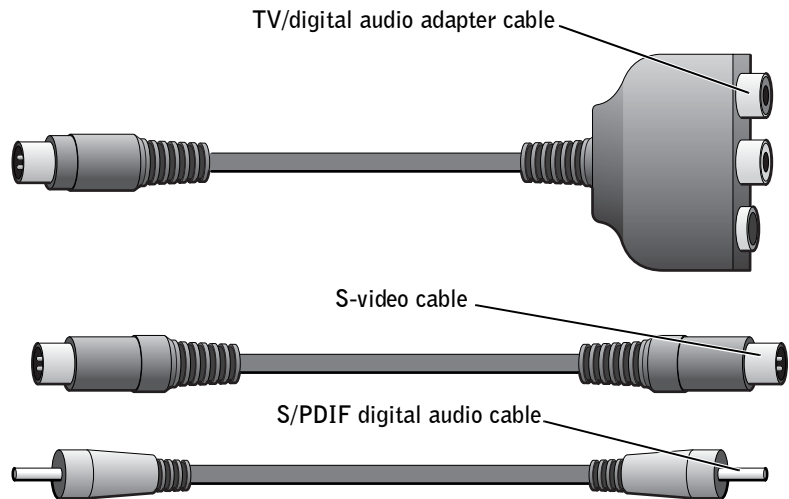

- 1 Turn off the computer and the television and/or audio device you want to connect.
- 2 Connect the TV/digital audio adapter cable to the S-video TV-out connector on your computer.
- 3 Plug one end of the S-video cable into the S-video connector on the TV/digital audio adapter cable.

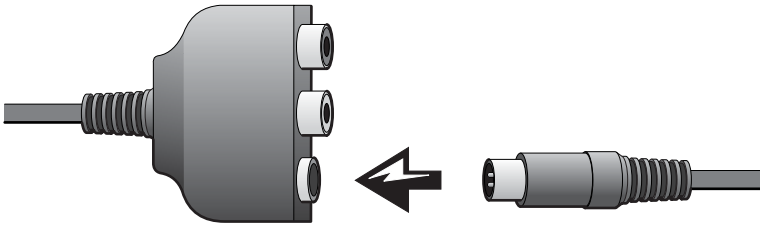

- 4 Plug the other end of the S-video cable into the S-video connector on the television.
- 5 Plug one end of the S/PDIF digital audio cable into the digital audio connector on the TV/digital audio adapter cable.

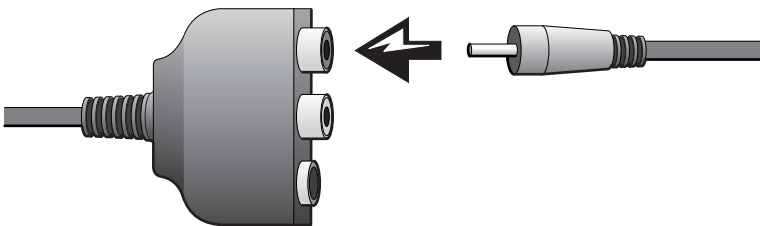

- 6 Plug the other end of the S/PDIF digital audio cable into the audio input connector on your television or other audio device.

Composite Video and Standard Audio

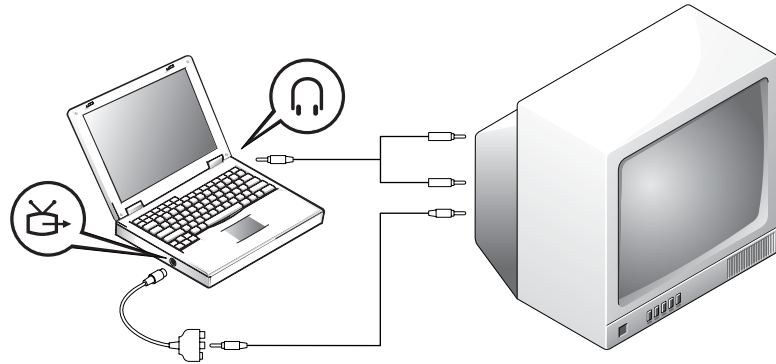

Before you begin, ensure that you have the following cables:

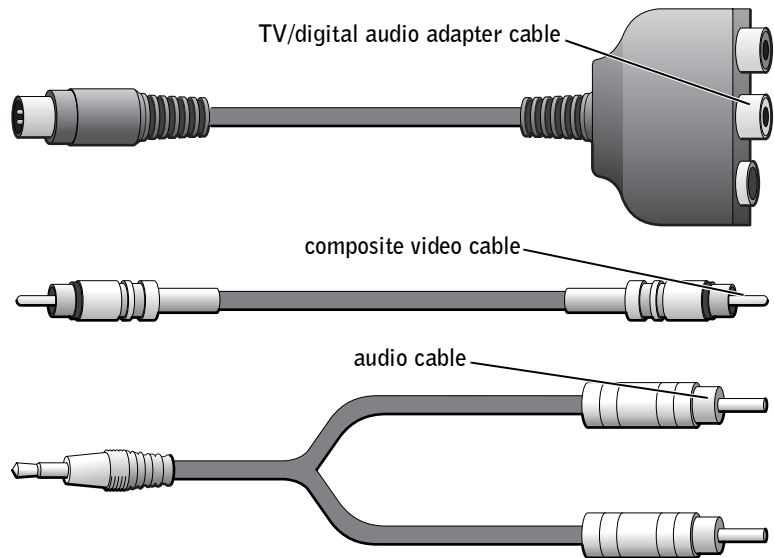

- 1 Turn off the computer and the television and/or audio device you want to connect.
- 2 Connect the TV/digital audio adapter cable to the S-video TV-out connector on the computer.

- 3 Plug one end of the composite video cable into the composite video connector on the TV/digital audio adapter cable.

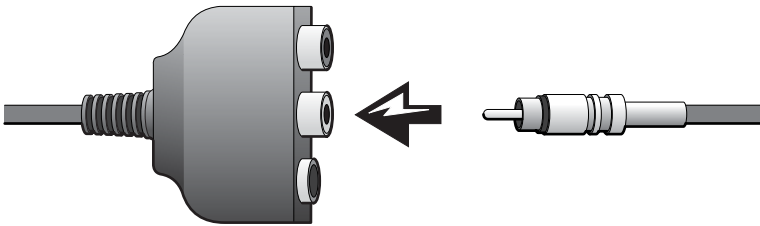

- 4 Plug the other end of the composite video cable into the composite video connector on the television.
- 5 Plug the single-connector end of the audio cable into the headphone connector on the computer.

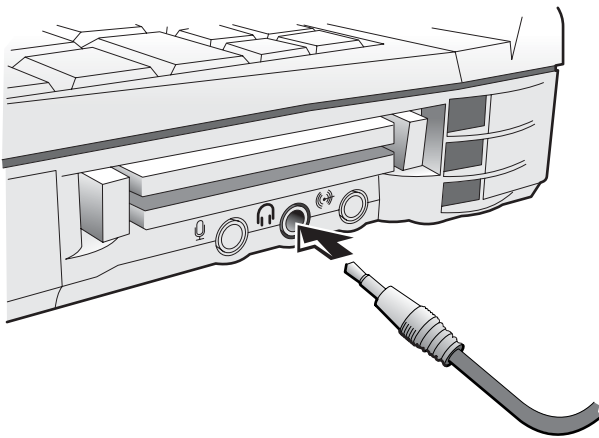

- 6 Plug the two RCA connectors on the other end of the audio cable into the audio input connectors on your television or other audio device.

Composite Video and Digital Audio

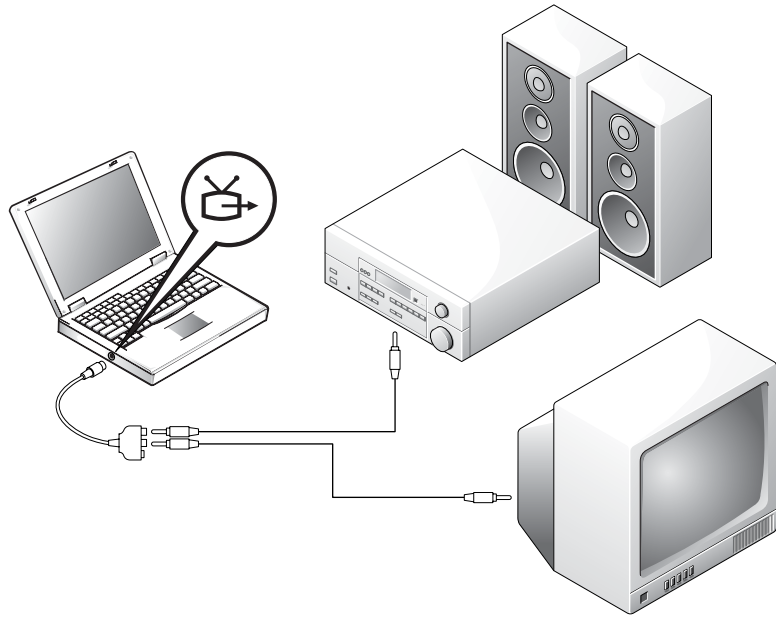

Before you begin, ensure that you have the following cables:

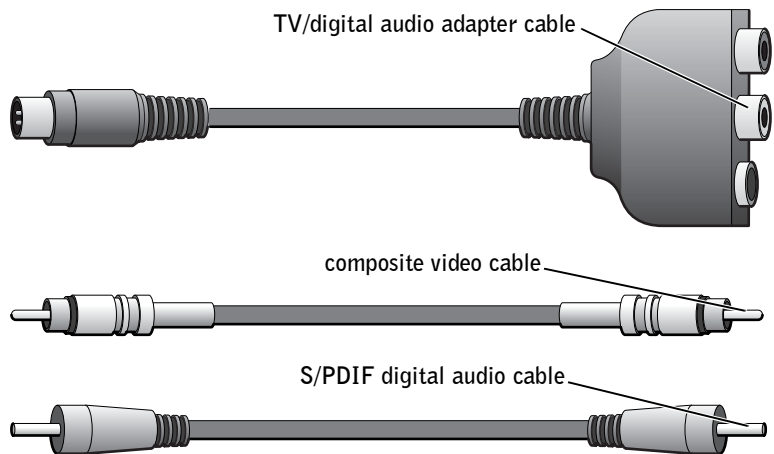

- 1 Turn off the computer and the television and/or audio device you want to connect.
- 2 Connect the TV/digital audio adapter cable to the S-video TV-out connector on the computer.
- 3 Plug one end of the composite video cable into the composite video connector on the TV/digital audio adapter cable.

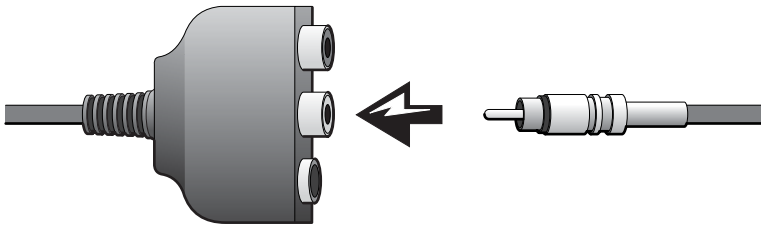

- 4 Plug the other end of the composite video cable into the composite video connector on the television.
- 5 Plug one end of the S/PDIF digital audio cable into the S/PDIF audio connector on the TV/digital audio adapter cable.

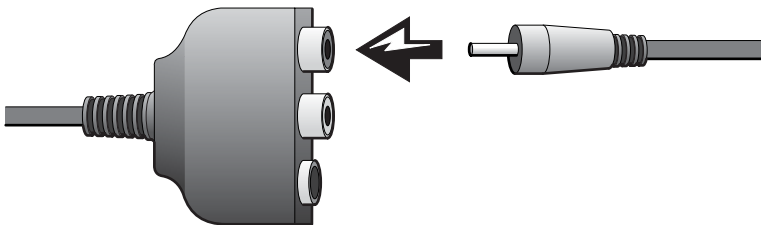

- 6 Plug the other end of the digital audio cable into the S/PDIF connector on your television or other audio device.

Enabling the Display Settings for a Television

NVIDIA Video Controller

- 1 Click the **Start** button and click **Control Panel**.
- 2 Click **Appearance and Themes** and click **Display**.
- 3 Click the **Settings** tab and click **Advanced**.

- 4 Click the **TwinView** tab or the **nView** tab, depending on the video card you have.
- 5 Click the **Clone** button to enable the television.
- 6 Click **Apply**.
- 7 Click **OK** to confirm the settings change.
- 8 Click **Yes** to keep the new settings.
- 9 Click **OK**.

ATI Video Controller

- 1 Click the **Start** button and click **Control Panel**.
- 2 Click **Appearance and Themes** and click **Display**.
- 3 Click the **Settings** tab and click **Advanced**.
- 4 Click the **ATI Displays** tab.
- 5 Click the upper-left corner of the **TV** button to enable the TV.
- 6 Click **OK**.

Using S/PDIF Digital Audio

To use Dolby Digital 5.1 audio for DVD playback, *enable* digital audio using the following steps:



HINT: When you enable digital audio, it disables all sound on your computer except for sound from DVDs. If you enable digital audio to watch a movie, disable the digital audio when you are finished watching the movie.

- 1 Double-click the speaker icon in the Windows notification area.
- 2 Click the **Options** menu and then click **Advanced Controls**.
- 3 Click **Advanced**.



- 4 To *enable* digital audio, click to check **Enable S/PDIF**.
To *disable* digital audio, click to uncheck **Enable S/PDIF**.
- 5 Click **Close**.
- 6 Click **OK**.
- 7 Double-click the **InterVideo WinDVD** icon on the Windows desktop.



- 8 Insert a DVD into the DVD drive.
If the DVD begins playing, click the stop button.
- 9 Click the Properties (wrench) icon.
- 10 Click the **Audio** tab.
- 11 To *enable* digital audio, click **Enable S/PDIF output**.
To *disable* digital audio, click **2 speaker mode**.
- 12 Click **Apply**.

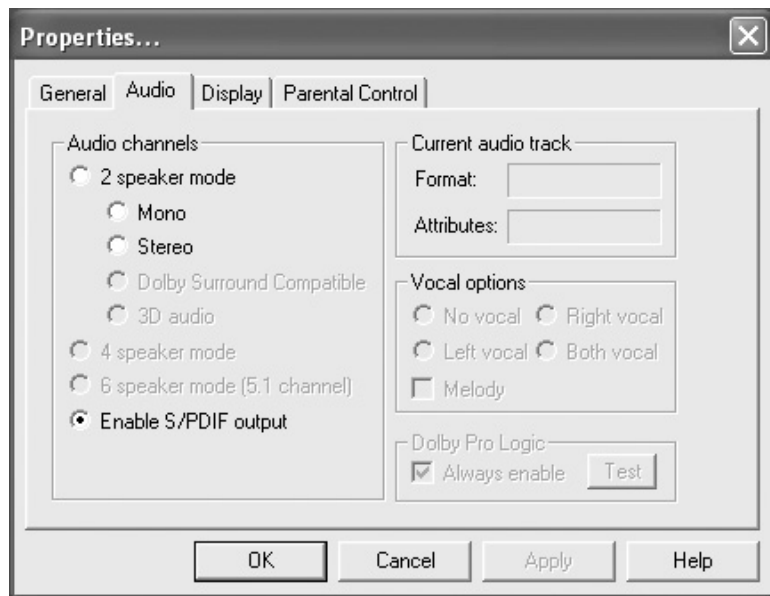

- 13 Click **OK**.

Setting Up the Dolby Headphone



HINT: The Dolby headphone feature is available only if your computer has a DVD drive.

- 1 Double-click the **Intervideo Win DVD** icon on the Windows desktop.
- 2 Click the **Properties** icon.
- 3 Click the **Dolby Headphone** tab.
- 4 Click **Enable Dolby Headphone**.

- 5 Select one of the four options to set the level of surround sound effects. **Option 1** is a baseline stereo option and **Options 2, 3, and 4** are surround sound levels.
- 6 Click **Apply**, and then click **OK** to close the **WinDVD Properties** window.
- 7 Click **Exit**.

 **HINT:** Icon labels may be visible only when you place the pointer over the icon.

Setting Up the Docking Device to Connect to a Network

-  **NOTICE:** Do not install a network adapter or a network adapter/modem combination PC Card until you complete the docking device setup.
-  **NOTICE:** To prevent serious operating system problems, do not dock your computer to a docking device until the Windows operating system setup on the computer is complete.

 **HINT:** A network adapter is also referred to as a network interface controller (NIC).

A docking device allows you to more fully integrate your portable computer into a desktop environment.

For instructions and details on setting up a docking device, refer to the documentation that came packaged with the device.

Power Protection Devices

Several devices are available that protect against power fluctuations and failures:

- Surge protectors
- Line conditioners
- Uninterruptible power supplies (UPS)

Surge Protectors

Surge protectors and power strips equipped with surge protection help to prevent damage to your computer from voltage spikes that can occur during electrical storms or following power interruptions. The level of protection is usually commensurate with the cost of the surge protector. Some surge protector manufacturers include warranty coverage for certain types of damage. Dell recommends that you carefully read the device warranty when choosing a surge protector. Compare joule ratings to determine the relative effectiveness of different devices.

 **NOTICE:** Most surge protectors do not protect against lightning strikes. Dell recommends that you disconnect your computer from the electrical outlet when lightning occurs in your area.

 **NOTICE:** Surge protectors do not protect against power fluctuations or power interruptions.

Power surges on telephone lines can damage modems. Dell recommends that you disconnect the telephone line from the telephone wall jack during electrical storms. Many surge protectors have a telephone jack for modem protection. See the surge protector documentation for modem connection instructions.

 **NOTICE:** Network adapter protection is not available on surge protectors. Dell recommends that you disconnect the network cable from the network wall jack during electrical storms.

Line Conditioners

 **NOTICE:** Line conditioners do not protect against power interruptions.

Line conditioners are designed to maintain AC voltage at a fairly constant level. Line conditioners can cost up to several hundred dollars more than surge protectors.

Uninterruptible Power Supply Devices

 **NOTICE:** Loss of power while data is being saved to the hard drive may result in data loss or file damage.

A UPS protects against power fluctuations and interruptions. UPS devices contain a battery that provides temporary power to connected devices when AC power is interrupted. The battery charges while AC power is available. See the UPS manufacturer documentation for information on battery operating time and to ensure that the device is approved by Underwriters Laboratories (UL).

 **HINT:** To ensure maximum battery operating time, connect only your computer to a UPS. Connect other devices, such as a printer, to a separate power strip that provides surge protection.

SECTION 2

Solving Problems

- Finding Solutions
- Accessing Help
- Power Problems
- Start-Up Error Messages
- Video and Display Problems
- Sound and Speaker Problems
- Printer Problems
- Modem and Internet Connection Problems
- Scanner Problems
- Touch Pad or Mouse Problems
- External Keyboard Problems
- Unexpected Characters
- Drive Problems
- PC Card Problems
- Error Messages
- General Program Problems
- E-Mail Problems
- Resolving Other Technical Problems
- If Your Computer Gets Wet
- If You Drop or Damage Your Computer
- Drivers
- Resolving Software and Hardware Incompatibilities
- Using Microsoft® Windows® XP System Restore
- Reinstalling Microsoft® Windows® XP

Finding Solutions

Sometimes it's difficult to figure out where to go for answers. Use this chart to quickly find the answers to your questions.

 **HINT:** If you have a problem with an external device, see the device documentation or contact the manufacturer.

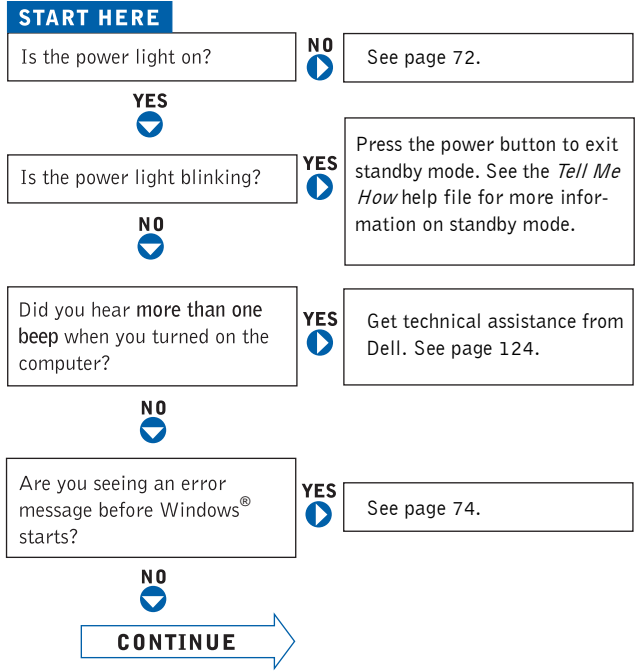

Are you having a problem with...

NO
▶

- ▶ video or the display? **YES** ▶ See page 75.
- ▶ sound or the speakers? **YES** ▶ See page 77.
- ▶ the printer? **YES** ▶ See page 78.
- ▶ the modem? **YES** ▶ See page 79.
- ▶ the scanner? **YES** ▶ See page 80.
- ▶ the touch pad? **YES** ▶ See page 81.
- ▶ the external keyboard? **YES** ▶ See page 82.
- ▶ unexpected characters? **YES** ▶ See page 82.
- ▶ the hard drive or a disk drive? **YES** ▶ See page 83.
- ▶ the network adapter? **YES** ▶ See page 87.
- ▶ Windows error messages? **YES** ▶ See page 87.
- ▶ a program? **YES** ▶ See page 89.
- ▶ the Internet? **YES** ▶ See page 90.
- ▶ your e-mail? **YES** ▶ See page 90.

Are you having some other type of problem?

YES ▶ See page 90.

Accessing Help

TO ACCESS THE *TELL ME HOW* HELP FILE

- 1 Click the **Start** button and then click **Help and Support**.
- 2 Click **User and system guides** and then click **User's guides**.
- 3 Click **Tell Me How**.

TO ACCESS HELP

- 1 Click the **Start** button and then click **Help and Support**.
- 2 Type a word or phrase that describes your problem and then click the arrow icon.
- 3 Click the topic that describes your problem.
- 4 Follow the instructions shown on the screen.



HINT: See the *Tell Me How* help file for information on standby mode. To access the help file, see "Accessing Help."

Power Problems

CHECK THE POWER LIGHT — When the power light is lit or blinking, the computer has power. If the power light is blinking, the computer is in standby mode—press the power button to exit standby mode. If the light is off, press the power button to turn on the computer.

CHARGE THE BATTERY — The battery charge may be depleted.

- 1 Reinstall the battery.
- 2 Use the AC adapter to connect the computer to an electrical outlet.
- 3 Turn on the computer.

CHECK THE BATTERY STATUS LIGHT — If the battery status light flashes orange or is a steady orange the battery charge is low or depleted. Connect the computer to an electrical outlet.

If the battery status light flashes green and orange, the battery is too hot to charge. Turn off the computer (see page 42), disconnect the computer from the electrical outlet, and then let the battery and computer cool to room temperature.

If the battery status light rapidly flashes orange, the battery may be defective. Contact Dell (see page 124).

TEST THE ELECTRICAL OUTLET — Ensure that the electrical outlet is working by testing it with another device, such as a lamp.

CHECK THE AC ADAPTER — Check the AC adapter cable connections. If the AC adapter has a light, ensure that the light is on.

CONNECT THE COMPUTER DIRECTLY TO AN ELECTRICAL OUTLET — Bypass power protection devices, power strips, and the extension cable to verify that the computer turns on.

ELIMINATE POSSIBLE INTERFERENCE — Turn off nearby fans, fluorescent lights, halogen lamps, or other appliances.

ADJUST THE POWER PROPERTIES — See the *Tell Me How* help file or search for the keyword *standby* in the Help and Support Center. To access help, see page 72.

RESET THE MEMORY MODULES — If the computer power light turns on but the display remains blank, reset the memory modules (see page 105).

Ensuring Sufficient Power for Your Computer

Your computer's Intel® Mobile Pentium® 4 microprocessor requires more power than the microprocessors used in Dell's previous portable computers. Your computer is designed to use the 90-W AC adapter and the 4400-mAh battery that shipped with it; for optimum system performance, you should always use these components.

The 70-W AC adapters used in some of Dell's older portable computers can be used with your computer, but they will decrease system performance. Likewise, you can use the 3800-mAh and 3600-mAh batteries from older Dell computers, but these lesser-capacity batteries will discharge faster. Using less-powerful AC adapters or batteries may cause you to receive a **WARNING** or a **SYSTEM CONFIGURATION ERROR** message similar to the following:

WARNING: 70 Watt AC adapter detected. System will not be capable of running in full performance without a 90 Watt AC adapter.

 **HINT:** If you want to upgrade the AC adapter for an existing Dell docking device, you can purchase an additional 90-W AC adapter from Dell.

 **NOTICE:** Do not use an AC adapter rated under 70 W or a battery rated under 3600 mAh in this computer. To do so will cause indeterminate results, including data loss and/or immediate system shutdown. Using one of these lower-powered components will cause a `SYSTEM CONFIGURATION ERROR` message to appear.

Docking Power Considerations

The 4400-mAh battery supplied with the computer is not designed to support both the computer and a docking device. For optimum system performance, always use the 90-W AC adapter (with or without a battery installed) when using the computer in a docking device. You can identify the 90-W adapter by the lighter-gray tip on the connector that plugs into the computer or docking device.

Using a 70-W AC adapter will cause the computer to run in reduced-performance mode and may display an AC adapter `WARNING` message.

Docking While the Computer Is Running

To accommodate the initial power surge when connecting to a docking device with the computer running in normal (non-power conservation) mode, a 90- or 70-W AC adapter *and* at least one battery (a 4400- or 3800-mAh battery) must be installed in the computer. The computer will then run in either full-performance or reduced-performance mode, depending on the battery/AC adapter combination installed.

AC Power Loss While the Computer Is Docked

If a computer loses AC power while docked, the computer immediately goes into low-performance mode and displays an appropriate `WARNING` message.

Start-Up Error Messages

OPERATING SYSTEM NOT FOUND — Contact Dell for technical assistance (see page 124).

INSERT BOOTABLE MEDIA — The operating system is trying to boot to a nonbootable floppy disk or CD. Insert a bootable floppy disk or CD.

NON-SYSTEM DISK ERROR — A floppy disk is in the floppy drive. Remove the floppy disk and restart the computer.

Video and Display Problems

If the display is blank

CHECK THE LIGHT — When the light is blinking, the computer has power.

- If the light is blinking, the computer is in standby mode—press the power button to exit standby mode.
- If the light is off, press the power button.
- If the light is on, your power management settings may have caused the display to turn off. Try pressing any key or move the cursor to exit standby mode.

CHECK THE BATTERY — If you are using a battery to power your computer, the battery charge may be depleted. Connect the computer to an electrical outlet using the AC adapter, and turn on the computer.



TEST THE ELECTRICAL OUTLET — Ensure that the electrical outlet is working by testing it with another device, such as a lamp.

CHECK THE AC ADAPTER — Check the AC adapter cable connections. If the AC adapter has a light, ensure that it is on.

CONNECT THE COMPUTER DIRECTLY TO AN ELECTRICAL OUTLET — Bypass power protection devices, power strips, and the extension cable to verify that the computer turns on.

ADJUST THE POWER PROPERTIES — See the *Tell Me How* help file, or search for the keyword *standby* in the Windows Help and Support Center. To access help, see page 72.

 **HINT:** If you are using a program that requires a higher resolution than your computer supports, Dell recommends that you attach an external monitor to your computer.

SWITCH THE VIDEO IMAGE — If your computer is attached to an external monitor, press   to switch the video image to the display.

If the display is difficult to read

ADJUST THE BRIGHTNESS — See the *Tell Me How* help file for instructions on adjusting the brightness. To access the help file, see page 72.

MOVE THE SUBWOOFER AWAY FROM THE COMPUTER OR MONITOR — If your external speaker system includes a subwoofer, ensure that the subwoofer is at least 60 cm (2 ft) away from the computer or external monitor.

ELIMINATE POSSIBLE INTERFERENCE — Turn off nearby fans, fluorescent lights, halogen lamps, or other appliances.

ROTATE THE COMPUTER TO FACE A DIFFERENT DIRECTION — Eliminate sunlight glare, which can cause poor picture quality.

ADJUST THE WINDOWS DISPLAY SETTINGS

- 1 Click the **Start** button and then click **Control Panel**.
- 2 Click **Appearance and Themes**.
- 3 Click the area you want to change or click the **Display** icon.
- 4 Try different settings for **Color quality** and **Screen resolution**.

SEE "ERROR MESSAGES" — If an error message appears, see "Error Messages" on page 87.

If only part of the display is readable

CONNECT AN EXTERNAL MONITOR



- 1 Turn off your computer and connect an external monitor to the computer.
- 2 Turn on the computer and the monitor and adjust the monitor brightness and contrast controls.

If the external monitor works, the computer display or video controller may be defective. Contact Dell (see page 124).

Sound and Speaker Problems

If you have a problem with integrated speakers

ADJUST THE WINDOWS® VOLUME CONTROL — Double-click the speaker icon in the lower-right corner of your screen. Ensure that the volume is turned up and that the sound is not muted. Adjust the volume, bass, or treble controls to eliminate distortion.

ADJUST THE VOLUME USING KEYBOARD SHORTCUTS — See "Using the Keyboard and Touch Pad" in the *Tell Me How* help file. Press   to disable (mute) or reenable the integrated speakers.

ENSURE THAT S/PDIF DIGITAL AUDIO IS DISABLED — See "Using S/PDIF Digital Audio" on page 62.

REINSTALL THE SOUND (AUDIO) DRIVER — See "Reinstalling Drivers" on page 93.

If you have a problem with external speakers

CHECK THE SPEAKER CABLE CONNECTIONS — See the setup diagram supplied with the speakers.

TEST THE ELECTRICAL OUTLET — Ensure that the electrical outlet is working by testing it with another device, such as a lamp.

ENSURE THAT THE SPEAKERS ARE TURNED ON — See the setup diagram supplied with the speakers.

ADJUST THE WINDOWS VOLUME CONTROL — Double-click the speaker icon in the lower-right corner of your screen. Ensure that the volume is turned up and that the sound is not muted. Adjust the volume, bass, or treble controls to eliminate distortion.

 **HINT:** The volume control in some MP3 players overrides the Windows volume setting. If you have been listening to MP3 songs, make sure that you did not turn the player volume down or off.

TEST THE SPEAKERS — Plug the speaker audio cable into the line-out connector on the computer. Ensure that the headphone volume control is turned up. Play a music CD.

RUN THE SPEAKER SELF-TEST — Some speaker systems have a self-test button on the subwoofer. See the speaker documentation for self-test instructions.

ELIMINATE POSSIBLE INTERFERENCE — Turn off nearby fans, fluorescent lights, or halogen lamps to check for interference.

ENSURE THAT S/PDIF DIGITAL AUDIO IS DISABLED — See "Using S/PDIF Digital Audio" on page 62.

REINSTALL THE SOUND (AUDIO) DRIVER — See "Reinstalling Drivers" on page 93.

Printer Problems

CHECK THE PRINTER CABLE CONNECTIONS — Ensure that the printer cable is properly connected to the computer (see page 20).

TEST THE ELECTRICAL OUTLET — Ensure that the electrical outlet is working by testing it with another device, such as a lamp.

ENSURE THAT THE PRINTER IS TURNED ON — See the documentation supplied with the printer.

VERIFY THAT WINDOWS® RECOGNIZES THE PRINTER

- 1 Click the Start button.
- 2 Click Control Panel.
- 3 Click Printers and Other Hardware.
- 4 Click View installed printers or fax printers. If the printer model is listed, right-click the printer icon.
- 5 Click Properties, and then click the Ports tab. Ensure that the Print to the following port(s): setting is LPT1 (Printer Port).

REINSTALL THE PRINTER DRIVER — See "Reinstalling Drivers" on page 93.

Modem and Internet Connection Problems

- ➔ **NOTICE:** Connect the modem to an analog telephone wall jack only. Connecting the modem to a digital telephone network damages the modem.
- ➔ **NOTICE:** Modem and network connectors look similar. Do not plug a telephone line into the network connector.

CHECK THE TELEPHONE WALL JACK — Disconnect the telephone line from the modem and connect it to a telephone. Listen for a dial tone. Ensure that you have touchtone telephone service. Try connecting the modem to a different telephone wall jack.

Slow connection speeds can be caused by telephone noise as well as by telephone line or network conditions. Contact your telephone company or network administrator for more information.

CONNECT THE MODEM DIRECTLY TO THE TELEPHONE WALL JACK —

If you have other telephone devices sharing the line, such as an answering machine, fax machine, surge protector, or line splitter, then bypass them and use the telephone line to connect the modem directly to the telephone wall jack.

CHECK THE CONNECTION — Verify that the telephone line is connected to the modem.

 **HINT:** If you can connect to your Internet service provider (ISP), your modem is functioning properly. If you are sure that your modem is working properly and you still experience problems, contact your ISP.

CHECK THE TELEPHONE LINE — Try using a different telephone line. If you are using a line that is 3 m (10 ft) or more in length, try a shorter one.

IRREGULAR DIAL TONE — If you have voice mail service, you might hear an irregular dial tone when you have messages. Contact your telephone company for instructions on restoring a dial tone.

TURN OFF CALL WAITING (CATCH-PHONE) — See your telephone directory for instructions on deactivating this feature. Then adjust the dial-up networking connection properties.

- 1 Click the **Start** button and click **Control Panel**.
- 2 Click **Printers and Other Hardware**, click **Phone and Modem Options**, click the **Dialing Rules** tab, and then click **Edit...**
- 3 In the **Edit Location** window, ensure that **To disable call waiting, dial:** is checked, and then select the proper code as listed in your telephone directory.
- 4 Click **Apply** and click **OK**.
- 5 Close the **Phone and Modems Options** window.
- 6 Close the **Control Panel** window.

VERIFY THAT THE MODEM IS COMMUNICATING WITH WINDOWS

- 1 Click the **Start** button and click **Control Panel**.
- 2 Click **Printers and Other Hardware**.
- 3 Click **Phone and Modem Options**.
- 4 Click the **Modems** tab.
- 5 Click the COM port for your modem.
- 6 Click **Properties**, click the **Diagnostics** tab, and then click **Query Modem** to verify that the modem is communicating with Windows.

If all commands receive responses, the modem is operating properly.

Scanner Problems

CHECK THE POWER CABLE CONNECTION — Ensure that the scanner power cable is firmly connected to a working electrical power source and that the scanner is turned on.

CHECK THE SCANNER CABLE CONNECTION — Ensure that the scanner cable is firmly connected to the computer and to the scanner.

UNLOCK THE SCANNER — Ensure that your scanner is unlocked if it has a locking tab or button.

REINSTALL THE SCANNER DRIVER — See the scanner documentation for instructions.

Touch Pad or Mouse Problems

CHECK THE TOUCH PAD SETTINGS

- 1 Click the Start button, click Control Panel, and then click Printers and Other Hardware.
- 2 Click Mouse.
- 3 Try adjusting the settings.

CHECK THE MOUSE CABLE — Shut down the computer (see page 42). Disconnect the mouse cable and check it for damage. For PS/2 cables, check the cable connector for bent or broken pins. Firmly reconnect the cable.

If you are using a mouse extension cable, disconnect it and connect the mouse directly to the computer.

TO VERIFY THAT THE PROBLEM IS WITH THE MOUSE, CHECK THE TOUCH PAD

- 1 Turn off the computer.
- 2 Disconnect the mouse.
- 3 Turn on the computer.
- 4 At the Windows desktop, use the touch pad to move the cursor around, select an icon, and open it.

If the touch pad operates correctly, the mouse may be defective.

REINSTALL THE TOUCH PAD DRIVER — See "Reinstalling Drivers" on page 93.

 **HINT:** When you attach an external keyboard, the integrated keyboard remains fully functional.

External Keyboard Problems

CHECK THE KEYBOARD CABLE — Shut down the computer (see page 42). Disconnect the keyboard cable and check it for damage. For PS/2 cables, check the cable connector for bent or broken pins. Firmly reconnect the cable.

If you are using a keyboard extension cable, disconnect it and connect the keyboard directly to the computer.

CHECK THE EXTERNAL KEYBOARD

- 1 Turn off the computer, wait 1 minute, and turn it on again.
- 2 Verify that the numbers, capitals, and scroll lock lights on the keyboard blink during the boot routine.
- 3 From the Windows® desktop, click the **Start** button, point to **Programs**, point to **Accessories**, and then click **Notepad**.
- 4 Type some characters on the external keyboard and verify that they appear on the display.

If you cannot verify these steps, you may have a defective external keyboard.

TO VERIFY THAT THE PROBLEM IS WITH THE EXTERNAL KEYBOARD, CHECK THE INTEGRATED KEYBOARD

- 1 Turn off the computer.
- 2 Disconnect the external keyboard.
- 3 Turn on the computer.
- 4 From the Windows desktop, click the **Start** button, point to **Programs**, point to **Accessories**, and then click **Notepad**.
- 5 Type some characters on the integrated keyboard and verify that they appear on the display.

If the characters appear now but did not with the external keyboard, you may have a defective external keyboard. Contact Dell (see page 124).

Unexpected Characters

DISABLE THE NUMERIC KEYPAD — Press  to disable the numeric keypad if numbers are displayed instead of letters. Verify that the numbers lock light is not lit.

Drive Problems

If you cannot save a file to a floppy disk drive

ENSURE THAT WINDOWS® RECOGNIZES THE DRIVE — Click the Start button and click My Computer. If the drive is not listed, perform a full scan with your antivirus software to check for and remove viruses. Viruses can sometimes prevent Windows from recognizing the drive. Insert a bootable disk and restart the computer. Verify that the  light is blinking, indicating normal operation.

ENSURE THAT THE DISK IS NOT WRITE-PROTECTED — You cannot save data to a write-protected disk.

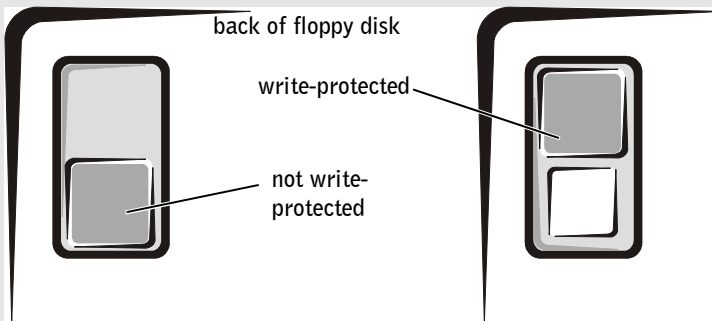

TRY ANOTHER FLOPPY DISK — Insert another disk to eliminate the possibility that the original disk is defective.

 **HINT:** For information on saving files to a floppy disk, see the *Tell Me How* help file. To access the help file, see page 72.

 **HINT:** Because of different worldwide file types, not all DVD titles work in all DVD drives.

REINSTALL THE DRIVE

- 1 Save and close any open files, exit any open programs, and shut down the computer.
- 2 *If the drive is installed in the module bay*, remove the drive. See "About the Module Bay" on page 42 for instructions.
If the drive is a fixed drive, review "Check the Drive for Errors" on page 86.
- 3 Reinstall the drive.
- 4 Turn on the computer.

CLEAN THE DRIVE — See "Cleaning Your Computer" in the *Tell Me How* help file for instructions. To access the help file, see page 72.

If you cannot play a CD, CD-RW, or DVD

High-speed CD drive vibration is normal and may cause noise. This noise does not indicate a defect with the drive or the CD.

ENSURE THAT WINDOWS® RECOGNIZES THE DRIVE — Click the **Start** button and click **My Computer**. If the drive is not listed, perform a full scan with your antivirus software to check for and remove viruses. Viruses can sometimes prevent Windows from recognizing the drive. Insert a bootable disk and restart the computer. Verify that the  light is blinking, indicating normal operation.

TRY ANOTHER DISC — Insert another disc to eliminate the possibility that the original disc is defective.

ADJUST THE WINDOWS VOLUME CONTROL — Double-click the speaker icon in the lower-right corner of your screen. Ensure that the volume is turned up and that the sound is not muted.

IDENTIFY THE DISC THAT IS NOT PLAYING — If you have one CD, CD-RW, or DVD in the fixed optical drive device and one in the module bay device:

- 1 Click the **Start** button and click **My Computer**.
- 2 Double-click the drive letter of the device that you are verifying.

REINSTALL THE DRIVE

- 1 Save and close any open files, exit any open programs, and shut down the computer.
- 2 *If the drive is installed in the module bay*, remove the drive. See "About the Module Bay" on page 42 for instructions.
If the drive is a fixed drive, review "Check the drive for errors" on page 86.
- 3 Reinstall the drive.
- 4 Turn on the computer.

CLEAN THE DRIVE OR DISC — See "Cleaning Your Computer" in the *Tell Me How* help file for instructions. To access the help file, see page 72.

CHECK THE DRIVE FOR ERRORS

If the drive is a fixed optical drive:

- 1 Remove the hard drive and floppy drive.
- 2 Insert the *Drivers and Utilities* CD for your computer and turn on the computer.
- 3 Verify that the  light is blinking, indicating normal operation.

If you cannot eject the CD, CD-RW, or DVD drive tray

- 1 Ensure that the computer is turned off.
- 2 Straighten a paper clip and insert one end into the eject hole at the front of the drive; push firmly until the tray is partially ejected.
- 3 Gently pull out the tray until it stops.

If you hear an unfamiliar scraping or grinding sound

- Ensure that the sound is not caused by the program that is running.
- Ensure that the disk or disc is inserted properly.

If the CD-RW drive stops writing

DISABLE STANDBY MODE IN WINDOWS BEFORE WRITING TO A CD-RW — Search for the keyword *standby* in the Windows Help and Support Center. To access the help file, see page 72.

CHANGE THE WRITE SPEED TO A SLOWER RATE — See the help files for your CD creation software.

CLOSE ALL OTHER OPEN PROGRAMS — Closing all other open programs before writing to the CD-RW may alleviate the problem.

If you have problems with a hard drive

ALLOW THE COMPUTER TO COOL BEFORE TURNING IT ON — A hot hard drive may prevent the operating system from starting. Try allowing the computer to return to room temperature before turning it on.

CHECK THE DRIVE FOR ERRORS

- 1 Click the **Start** button and click **My Computer**.
- 2 Right-click the drive letter (local disk) that you want to scan for errors, and then click **Properties**.
- 3 Click the **Tools** tab.
- 4 Under **Error-checking**, click **Check Now**.
- 5 Click **Start**.

PC Card Problems

CHECK THE PC CARD — Ensure that the PC Card is properly inserted into the connector.

ENSURE THAT THE CARD IS RECOGNIZED BY WINDOWS® — Double-click the **Unplug or Eject Hardware** icon in the Windows taskbar. Ensure that the card is listed.

IF YOU HAVE PROBLEMS WITH A DELL-PROVIDED PC CARD —
Contact Dell (see page 124).

**IF YOU HAVE PROBLEMS WITH A PC CARD NOT PROVIDED BY
DELL —** Contact the PC Card manufacturer.

Network Problems

CHECK THE NETWORK CABLE CONNECTOR — Ensure that the network cable connector is firmly connected to the connector on the computer and the network wall jack.

CHECK THE NETWORK LIGHTS ON THE NETWORK CONNECTOR —
Green indicates that the network connection is active. If the status light is not green, try replacing the network cable. Amber indicates that the network adapter driver is loaded and the adapter is detecting activity.

RESTART THE COMPUTER — Try to log on to the network again.

CONTACT YOUR NETWORK ADMINISTRATOR — Verify that your network settings are correct and that the network is functioning.

Error Messages

If the message is not listed, see the documentation for the operating system or the application program that was running at the time the message appeared.

**THE FILE BEING COPIED IS TOO LARGE FOR THE DESTINATION
DRIVE —** The file that you are trying to copy is too large to fit on the disk, or the disk is too full. Try copying the file to a different disk or use a larger capacity disk.

A FILENAME CANNOT CONTAIN ANY OF THE FOLLOWING CHARACTERS: \ / : * ? " < > | — Do not use these characters in filenames.

INSERT BOOTABLE MEDIA — The operating system is trying to boot to a nonbootable floppy disk or CD. Insert a bootable floppy disk or CD.

NON-SYSTEM DISK OR DISK ERROR — A floppy disk is in the floppy drive. Remove the floppy disk and restart the computer.

NOT ENOUGH MEMORY OR RESOURCES. CLOSE SOME PROGRAMS AND TRY AGAIN — You have too many programs open. Close all windows and open the program that you want to use.

OPERATING SYSTEM NOT FOUND — Contact Dell (see page 124).

A REQUIRED .DLL FILE WAS NOT FOUND — The program that you are trying to open is missing an essential file. Remove and then reinstall the program.

- 1 Click the **Start** button.
- 2 Click **Control Panel**.
- 3 Click **Add or Remove Programs**.
- 4 Select the program you want to remove.
- 5 Click the **Change or Remove Program** icon.
- 6 See the program documentation for installation instructions.

X:\ IS NOT ACCESSIBLE. THE DEVICE IS NOT READY — Insert a disk into the drive and try again.

General Program Problems



A program crashes

SEE THE SOFTWARE DOCUMENTATION — Many software manufacturers maintain websites with information that may help you solve the problem. Ensure that you properly installed and configured the program. Reinstall the program if necessary.

 **HINT:** Software usually includes installation instructions in its documentation or on a floppy disk or CD.

A program stops responding

END THE PROGRAM

- 1 Simultaneously press   .
- 2 Click the Applications tab, and then select the program that is no longer responding.
- 3 Click the End Task button.

A solid blue screen appears

TURN THE COMPUTER OFF — If the computer does not respond to a keystroke or a proper shutdown (see page 42), press the power button until the computer turns off. Press the power button again to restart the computer. The solid blue screen appears because you were not able to perform a proper Windows® shutdown. ScanDisk automatically runs during the start-up process. Follow the instructions on the screen.

Error messages appear

REVIEW "ERROR MESSAGES" — Look up the message and take the appropriate action. See page 87 and the software documentation.

E-Mail Problems

ENSURE THAT YOU ARE CONNECTED TO THE INTERNET — With the Outlook Express e-mail program open, click **File**. If **Work Offline** has a check mark next to it, click the check mark to remove it and connect to the Internet.

Resolving Other Technical Problems

GO TO THE DELL SUPPORT WEBSITE — Go to support.dell.com for help with general usage, installation, and troubleshooting questions.

E-MAIL DELL — Go to support.dell.com and then click **E-Mail Dell** in the **Communicate** list. Send an e-mail message to Dell about your problem; you can expect to receive an e-mail message from Dell within hours.

CONTACT DELL — If you cannot solve your problem using the Dell™ support website or e-mail service, contact Dell for technical assistance (see page 124).

If Your Computer Gets Wet



CAUTION: Perform this procedure only after you are certain that it is safe to do so. If the computer is connected to an electrical outlet, Dell recommends that you turn off AC power at the circuit breaker before attempting to remove the power cables from the electrical outlet. Use the utmost caution when removing wet cables from a live power source.

- 1 Turn off the computer (see page 42), disconnect the AC adapter from the computer, and then disconnect the AC adapter from the electrical outlet.
- 2 Turn off any attached external devices, and disconnect them from their power sources and then from the computer.
- 3 Ground yourself by touching one of the metal connectors on the back of the computer.
- 4 Remove the module bay device (see page 42) and any installed PC Cards, and put them in a safe place to dry.

- 5 Remove the battery.
- 6 Wipe off the battery and put it in a safe place to dry.
- 7 Remove the hard drive (see page 108).
- 8 Remove the memory module(s) (see page 105).
- 9 Open the display and place the computer right-side up across two books or similar props to let air circulate all around it. Let the computer dry for at least 24 hours in a dry area at room temperature.



NOTICE: Do not use artificial means, such as a hair dryer or a fan, to speed the drying process.



CAUTION: To help prevent electrical shock, verify that the computer is thoroughly dry before continuing with the rest of this procedure.

- 10 Ground yourself by touching one of the metal connectors on the back of the computer.
- 11 Replace the memory module(s), the memory module cover, and the screw(s).
- 12 Replace the hard drive.
- 13 Replace the module bay device and any PC Cards you removed.
- 14 Replace the battery.
- 15 Turn on the computer and verify that it is working properly.

If the computer does not start, or if you cannot identify the damaged components, contact Dell (see page 124).



HINT: See "Limited Warranties and Return Policy" on page 145 for information on your warranty coverage.

If You Drop or Damage Your Computer

- 1 Save and close any open files, exit any open programs, and shut down the computer (see page 42).
- 2 Disconnect the AC adapter from the computer and from the electrical outlet.
- 3 Turn off any attached external devices, and disconnect them from their power sources and then from the computer.
- 4 Remove and reinstall the battery.
- 5 Turn on the computer.

If the computer does not start, or if you cannot identify the damaged components, contact Dell (see page 124).

Drivers

What Is a Driver?

A driver is a program that controls a device such as a printer, mouse, or keyboard. All devices require a driver program.

A driver acts like a translator between the device and the programs that use the device. Each device has its own set of specialized commands that only its driver recognizes.

Many drivers such as the keyboard driver come with your Microsoft® Windows® operating system. You may need to install drivers if:

- You upgrade your operating system.
- You reinstall your operating system.
- You connect or install a new device.

If you experience a problem with any device, perform the steps in the following sections to identify whether the driver is the source of your problem and to update the driver, if necessary.

Identifying Drivers

- 1 Click the **Start** button and click **Control Panel**.
- 2 In the **Control Panel** window, under **Pick a Category**, click **Performance and Maintenance**.
- 3 In the **Performance and Maintenance** window, click **System**.
- 4 In the **System Properties** screen, click the **Hardware** tab.
- 5 Click **Device Manager**.
- 6 In the **Device Manager** window, scroll down the list to see if any device has an exclamation point (a yellow circle with a [!]) on the device icon.

If an exclamation point is next to the device name, you may need to reinstall the driver or install a new driver.

Reinstalling Drivers

 **NOTICE:** The Dell Support website and your *Drivers and Utilities* CD provide approved drivers for Dell™ computers. If you install drivers obtained from other sources, your computer might not work correctly.

Using Windows XP Device Driver Rollback

If a problem occurs on your computer after you install or update a driver, use Windows XP Device Driver Rollback to replace the driver with the previously installed version.

To use Device Driver Rollback:

- 1 Click the **Start** button and click **Control Panel**.
- 2 In the **Control Panel** window, under **Pick a Category**, click **Performance and Maintenance**.
- 3 In the **Performance and Maintenance** window, click **System**.
- 4 In the **System Properties** screen, click the **Hardware** tab.
- 5 Click **Device Manager**.
- 6 In the **Device Manager** window, right-click the device for which the new driver was installed, and then click **Properties**.
- 7 Click the **Drivers** tab.
- 8 Click **Roll Back Driver**.

If Device Driver Rollback does not resolve the problem, then use System Restore (see page 96) to return your operating system to the operating state it was in before you installed the new driver.

Using the Drivers and Utilities CD

If using Device Driver Rollback or System Restore (see page 96) does not resolve the problem, then reinstall the driver from the *Drivers and Utilities* CD:

- 1 Save and close any open files, and exit any open programs.
- 2 Insert the *Drivers and Utilities* CD.

In most cases, the CD starts running automatically. If it does not, start Microsoft Windows Explorer, click your CD drive directory to display the CD contents, and then double-click the **autocd.exe** file. The first

time that you run the CD, it might prompt you to install setup files. Click **OK**, and follow the instructions on the screen to continue.

- 3 From the **Language** pull-down menu in the toolbar, select your preferred language for the driver or utility (if available).

A welcome screen appears.

- 4 Click **Next**. The CD automatically scans your hardware to detect drivers and utilities used by your computer.

After the CD completes the hardware scan, you can also detect other drivers and utilities. Under **Search Criteria**, select the appropriate categories from the **System Model**, **Operating System**, and **Topic** pull-down menus.

A link or links appear(s) for the specific drivers and utilities used by your computer.

- 5 Click the link of a specific driver or utility to display information about the driver or utility that you want to install.

- 6 Click the **Install** button (if present) to begin installing the driver or utility. At the welcome screen, follow the screen prompts to complete the installation.

If no **Install** button is present, automatic installation is not an option. For installation instructions, either see the appropriate instructions in the following section, or click **Extract**, follow the extracting instructions, and read the readme file.

If instructed to navigate to the driver files, click the CD directory on the driver information window to display the files associated with that driver.

Manually Reinstalling Drivers for Windows XP

- 1 After extracting the driver files to your hard drive as described in the previous section, click the **Start** button, point to **Settings**, and click **Control Panel**.
- 2 Click the **Start** button and right-click **My Computer**.
- 3 Click **Properties**.
- 4 Click the **Hardware** tab and click **Device Manager**.
- 5 Double-click the type of device for which you are installing the driver (for example, **Modems** or **Infrared devices**).



HINT: If you are reinstalling an infrared sensor driver, you must first enable the infrared sensor in the system setup program (see page 51) before continuing with the driver installation.

- 6 Double-click the name of the device for which you are installing the driver.
- 7 Click the **Driver** tab and then click **Update Driver**.
- 8 Click **Install from a list or specific location (Advanced)**, and then click **Next**.
- 9 Click **Browse**, and browse to the location to which you previously extracted the driver files.
- 10 When the name of the appropriate driver appears, click **Next**.
- 11 Click **Finish** and restart your computer.

Resolving Software and Hardware Incompatibilities

In the Microsoft® Windows® XP operating system, IRQ conflicts occur if a device either is not detected during the operating system setup or is detected but incorrectly configured. To check for IRQ conflicts on your computer:

- 1 Click the **Start** button and click **Control Panel**.
- 2 Click **Performance and Maintenance** and click **System**.
- 3 Click the **Hardware** tab and click **Device Manager**.
- 4 In the **Device Manager** list, check for conflicts with the other devices.
Conflicts are indicated by a yellow exclamation point (!) beside the conflicting device or a red X if the device has been disabled.
- 5 Double-click any conflicting device listed to bring up the **Properties** window so that you can determine what needs to be reconfigured or removed from the Device Manager.
- 6 Resolve these conflicts before checking specific devices.
- 7 Double-click the malfunctioning device type in the **Device Manager** list.

- 8 Double-click the icon for the specific device in the expanded list.

The **Properties** window appears.

If an **IRQ** conflict exists, the **Device status** area in the **Properties** window reports what other devices are sharing the device's **IRQ**.

- 9 Resolve any **IRQ** conflicts.

You can also use the Windows XP Hardware Troubleshooter. To use the troubleshooter, click the **Start** button and click **Help and Support**. Type `hardware troubleshooter` in the **Search** field, and then click the arrow to start the search. Click **Hardware Troubleshooter** in the **Search Results** list. In the **Hardware Troubleshooter** list, click **I need to resolve a hardware conflict on my computer**, and then click **Next**.

Using Microsoft® Windows® XP System Restore

The Microsoft® Windows® XP operating system provides a System Restore feature that allows you to return your computer to an earlier operating state if changes to the computer's hardware or software (including new hardware or program installations) or system settings, have left the computer in an undesirable operating state. You can also undo the last *system restore*.

System Restore automatically creates system checkpoints. You can also manually create your own checkpoints by creating *restore points*. To limit the amount of hard disk space used, older restore points are automatically purged.

To resolve an operating system problem, you can use System Restore from Safe Mode or Normal Mode to return your computer to an earlier operating state.

System Restore does not cause you to lose personal files stored in the **My Documents** folder, data files, or e-mail messages after restoring the computer to an earlier time. If you restore the computer to an operating state that existed before you installed a program, the program's data files are not lost, but you must reinstall the actual program again.

 **NOTICE:** It is important to make regular backups of your data files. System Restore does not monitor changes to or recover your data files. If the original data on the hard disk is accidentally erased or overwritten, or if it becomes inaccessible because of a hard disk malfunction, use your backup files to recover the lost or damaged data.

System Restore is enabled on your new computer. However, if you reinstall Windows XP with less than 200 MB of free hard-disk space available, System Restore is automatically disabled. Before you use System Restore, confirm that it is enabled:

- 1 Click the **Start** button and click **Control Panel**.
- 2 Click the **Performance and Maintenance**.
- 3 Click **System**.
- 4 Click the **System Restore** tab.
- 5 Ensure that **Turn off System Restore** is not checked.

Creating a Restore Point

In Windows XP, you can either use the System Restore Wizard or manually create the restore points.

Using the System Restore Wizard

To use the System Restore Wizard, click the **Start** button, click **Help and Support**, click **System Restore**, and then follow the instructions on the **System Restore Wizard** window. You can also create and name a restore point if you are logged on as the computer administrator or a user with administrator rights.

Manually Creating the Restore Points

- 1 Click the **Start** button, point to **All Programs**→**Accessories**→**System Tools**, and then click **System Restore**.
- 2 Click **Create a restore point**.
- 3 Click **Next**.
- 4 Type a name for the new restore point in the **Restore point description** field.

The present date and time are automatically added to the description of the new restore point.

5 Click **Create**.

6 Click **OK**.

Restoring the Computer to an Earlier Operating State

If problems occur after installing a device driver, first try using Device Driver Rollback (see page 93). If Device Driver Rollback does not resolve the problem, then use System Restore.

 **NOTICE:** Before restoring the computer to an earlier operating state, save and close all open files and exit all open programs. Do not alter, open, or delete any files or programs until the system restoration is complete.

- 1 Click the **Start** button, point to **All Programs** → **Accessories** → **System Tools**, and then click **System Restore**.
- 2 Ensure that **Restore my computer to an earlier time** is selected and click **Next**.
- 3 Click a calendar date to which you want to restore your computer.

The **Select a Restore Point** screen provides a calendar that allows you to see and select restore points. All calendar dates with available restore points appear in bold.

- 4 Select a restore point and click **Next**.

If a calendar date has only one restore point, then that restore point is automatically selected. If two or more restore points are available, click the restore point that you want to use.

 **NOTICE:** Save and close all open files and exit all open programs. Do not alter, open, or delete any files or programs until the system restoration is complete.

- 5 Click **Next**.

The **Restoration Complete** screen appears after System Restore finishes collecting data, and then the computer automatically restarts.

- 6 After the computer restarts, click **OK**.

To change the restore point, you can either repeat the steps using a different restore point, or you can undo the restoration.

Undoing the Last System Restore

➡ **NOTICE:** Save and close all open files and exit all open programs. Do not alter, open, or delete any files or programs until the system restoration is complete.

1 Click the **Start** button, point to **All Programs**→**Accessories**→**System Tools**, and then click **System Restore**.

2 Select **Undo my last restoration** and click **Next**.

➡ **NOTICE:** Save and close all open files and exit all open programs. Do not alter, open, or delete any files or programs until the system restoration is complete.

3 Click **Next**.

The **System Restore** screen appears, and then the computer automatically restarts.

4 After the computer restarts, click **OK**.

Reinstalling Microsoft® Windows® XP

Before You Reinstall

If you are reinstalling the Windows XP operating system to correct a problem with a newly installed driver, use Windows XP Device Driver Rollback (see page 93) to replace the device driver with the previously installed version.

If Device Driver Rollback does not resolve the problem, then use System Restore (see page 96) to return your operating system to the operating state it was in before you installed the new device driver.



Reinstalling Windows XP

To reinstall Windows XP, perform the steps in the following sections in the order in which they are listed.



The reinstallation process can take 1 to 2 hours to complete. After the reinstallation is complete, you will need to reinstall the device drivers, virus protection program, and other software.

- ➔ **NOTICE:** The *Operating System CD* provides options for reinstalling Windows XP. The options can overwrite files and possibly affect programs installed on your hard drive. Therefore, do not reinstall Windows XP unless instructed to do so by a Dell technical support representative.
- ➔ **NOTICE:** To prevent conflicts with Windows XP, disable any virus protection software installed on your computer before you reinstall Windows XP. See the documentation that came with the software for instructions.

Preparing to Boot From the Operating System CD

- 1 Insert the *Operating System CD* into the CD or DVD drive.
- 2 Exit any program or utility that might run after you insert the CD.
- 3 Shut down (see page 42) and restart the computer.
- 4 Press  immediately after the Dell™ logo appears.
If the operating system logo appears, wait until you see the Windows desktop, and then shut down the computer and try again.
- 5 Use the arrow keys to select CD-ROM, and then press .
- 6 Press any key when the `Press any key to boot from CD` message appears on the screen.

Starting Windows XP Setup

- 1 When the **Windows XP Setup** screen appears, press  to select **To set up Windows now**.
- 2 Read the information in the **Microsoft Windows Licensing Agreement** screen, and then press  on your keyboard to accept the license agreement.
- 3 If your computer already has Windows XP installed and you want to recover your current Windows XP data, type `r` to select the repair option, and then remove the CD from the drive.
- 4 If you want to install a new copy of Windows XP, press  to select the fresh copy option.

- 5 Press  to select the highlighted partition (recommended), and then follow the instructions on the screen.

The **Windows XP Setup** screen appears, and the operating system begins to copy files and install the devices. The computer automatically restarts multiple times.



HINT: The time required to complete the setup depends on the size of the hard drive and the speed of your computer. You can step away from the computer at this time if you need to do so.

Completing the GUI Setup



NOTICE: When the computer restarts, you will see the following message:
Press any key to boot from the CD. Do not press any key when this message appears.

- 1 When the **Regional and Language Options** screen appears, select the settings for your location, and then click **Next**.
- 2 Enter your name and organization (optional) in the **Personalize Your Software** screen, and then click **Next**.
- 3 *If you are reinstalling Windows XP Home Edition*, at the **What's your computer's name** window, enter a name for your computer (or accept the name provided), and then click **Next**.

If you are reinstalling Windows XP Professional, at the **Computer Name and Administrator Password** window, enter a name for your computer (or accept the one provided) and a password, and then click **Next**.

- 4 If your computer has a modem installed, the **Modem Dialing Information** screen appears. Enter the requested information and click **Next**.
- 5 Enter the date, time, and time zone in the **Date and Time Settings** window and click **Next**.
- 6 *If your computer has a network adapter*, select **Typical** in the **Networking Settings** screen and click **Next**.

If your computer does not have a network adapter, you do not see this option.

- 7 If you are reinstalling Windows XP Professional, you may be prompted to provide further network information regarding your network configuration, such as the domain name or workgroup name. If you are unsure of your settings, accept the default selections.

Windows XP installs the operating system components and configures the computer. The computer automatically restarts.

Completing the Operating System Setup



NOTICE: When the computer restarts, you will see the following message: Press any key to boot from the CD. Do not press any key when this message appears.

- 1 When the **Welcome to Microsoft** screen appears, click **Next**.
- 2 When the **How will this computer connect to the Internet?** message appears, click **Skip**.
- 3 When the **Ready to register with Microsoft?** screen appears, select **No, not at this time**, and then click **Next**.
- 4 When the **Who will use this computer?** screen appears, you can enter up to five users.
- 5 Click **Next**.
- 6 Click **Finish** to complete the setup, and remove the CD from the drive.

Reinstalling Drivers and Software

- 1 Reinstall the appropriate drivers (see page 92).
- 2 Reinstall your virus protection software. See the documentation that came with the software for instructions.
- 3 Reinstall your other software programs. See the documentation that came with the software for instructions.

SECTION 3

Adding and Replacing Parts

Replacing the Palm Rests

Adding Memory

Replacing the Hard Drive

Replacing the Palm Rests

- 1 Save and close any open files, exit any open programs, and shut down the computer (see page 42).
- 2 If the computer is connected (docked) to a docking device, undock it.
- 3 Keep the display open, and tilt the computer back so that you can access the bottom of the computer.
- 4 Slide and hold the latch release on the left side, and remove any device installed in the module bay.
- 5 Slide and hold the latch release on the right side, and remove any battery installed in the battery bay.
- 6 Locate the indentation under each palm rest, place your thumbs on the indentation, and push to release the palm rests.

bottom of computer

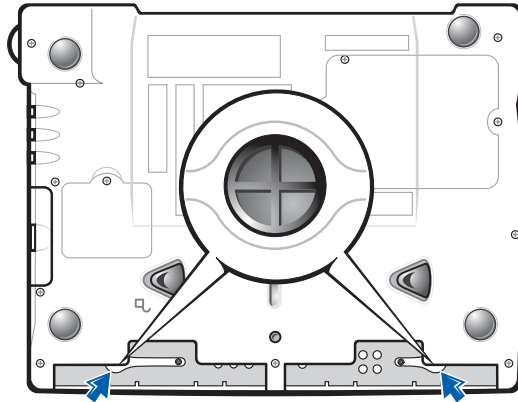

- 7 Remove the palm rests.
- 8 To replace the palm rests, insert the tabs on the edge of the palm rest into the slots and then press down until you feel a click.

Repeat the process for each side.

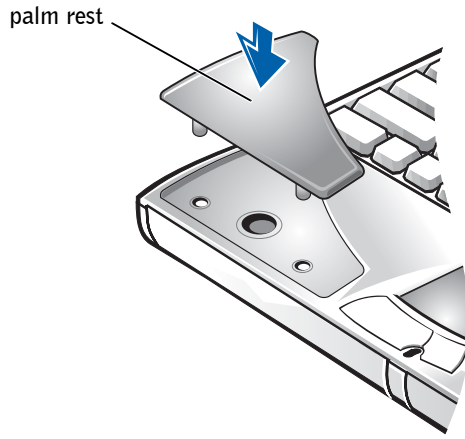

Adding Memory

You can increase your computer memory by installing memory modules on the system board. See "Specifications" on page 112 for information on the memory supported by your computer. Be sure to add only memory modules that are intended for your computer.

CAUTION: Before working inside your computer, read the safety instructions on page 9.

- 1 Save and close any open files, exit any open programs, and shut down the computer (see page 42).
- 2 If the computer is docked, undock it.
- 3 Remove any installed PC Cards.
- 4 Remove all installed batteries, and disconnect the AC adapter cable and any external devices from the computer. Wait 5 seconds before proceeding.
- 5 Ground yourself by touching a metal connector on the back of the computer, and continue to do so periodically during this procedure.

NOTICE: While you work, periodically touch unpainted metal on the computer to dissipate static electricity that might harm internal components.

HINT: Memory modules purchased from Dell are covered under your computer warranty.

- 6 Turn the computer over, remove the screw(s) from the memory module cover, and lift up the cover.

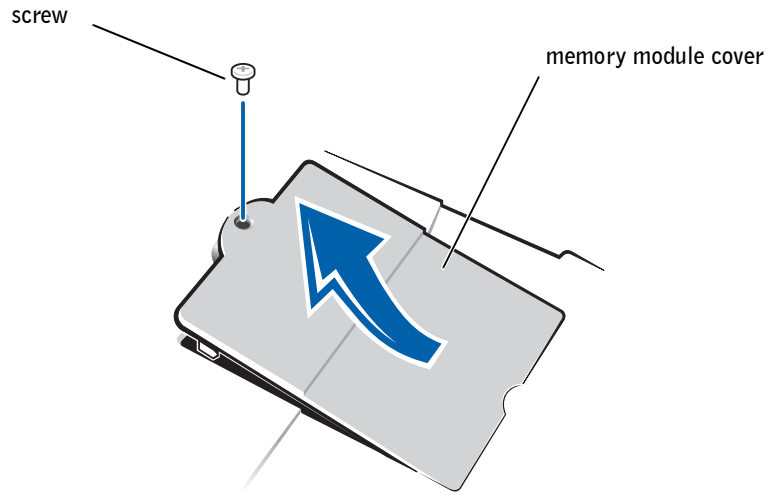

- ➡ NOTICE:** To prevent damage to the memory module connector, do not use tools to spread the inner metal tabs that secure the memory module.
- 7 If you are replacing a memory module, remove the existing module.
 - ➡ NOTICE:** Handle memory modules by their edges, and do not touch the components on a module.
 - a Use your fingertips to carefully spread apart the securing clips on each end of the memory module connector.
The module should pop up.
 - b Remove the module from the connector.

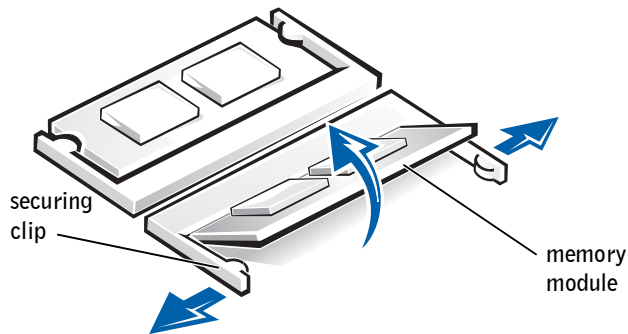

➔ **NOTICE:** If you need to install memory modules in two connectors, install a memory module in the connector labeled “JDIM (DIMMA)” before you install a module in the connector labeled “JDIM2 (DIMMB).”

8 Ground yourself and install the new memory module:

- a Align the notch in the module with the slot in the center of the connector.
- b Slide the edge of the module firmly into the connector, and rotate the module down until you feel a click. If you do not feel the click, remove the module and reinstall it.

 **HINT:** If the memory module is not installed properly, the computer does not boot. No error message indicates this failure.

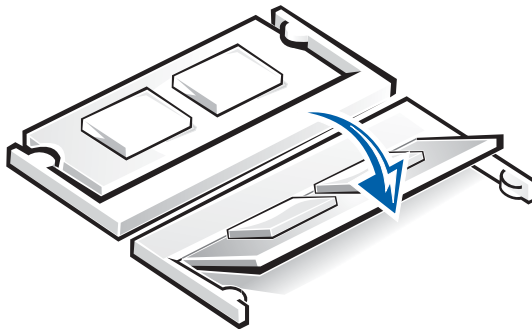

9 Replace the cover and screw(s).

➔ **NOTICE:** If the memory module cover is difficult to close, remove the module and reinstall it. Forcing the cover to close may damage your computer.

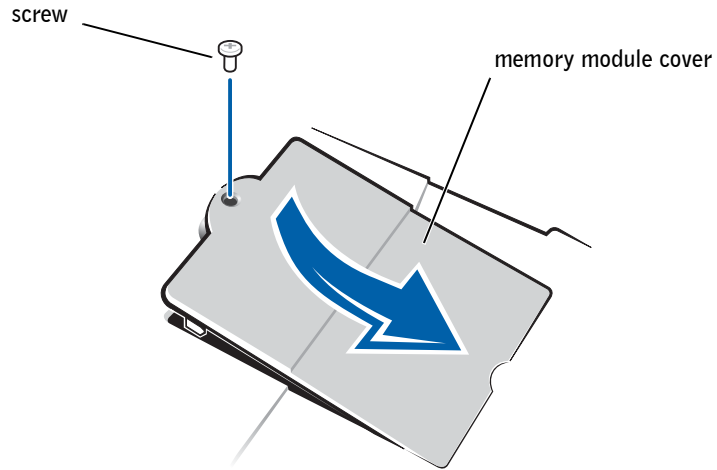

- 10 Insert the battery into the battery bay, or connect the AC adapter to your computer and an electrical outlet.
- 11 Turn on the computer.

As the computer boots, it detects the additional memory and automatically updates the system configuration information.

Replacing the Hard Drive

- ➔ **NOTICE:** To prevent data loss, turn off your computer (see page 42) before removing the hard drive. Do not remove the hard drive while the computer is on, in standby mode, or in hibernate mode.
- ➔ **NOTICE:** Hard drives are extremely fragile; even a slight bump can damage the drive.
- ⚠ **CAUTION:** If you remove the hard drive from the computer when the drive is hot, *do not touch* the metal housing of the hard drive.
- ⚠ **CAUTION:** Before working inside your computer, read the safety instructions on page 9.

To replace the hard drive in the hard drive bay:

- 1 Make sure that the work surface is flat and clean to prevent scratching the computer cover.
- 2 Save and close any open files, exit any open programs, and shut down the computer (see page 42).
- 3 If the computer is docked, undock it.
- 4 Disconnect the computer from the electrical outlet.
- 5 Wait 10 to 20 seconds and then disconnect any attached devices.
- 6 Remove any installed PC Cards, batteries, and devices.

Handle components and cards by their edges, and avoid touching pins and contacts.

- 7 Ground yourself by touching a metal connector on the back of the computer, and continue to do so periodically during this procedure.
- 8 Turn the computer over. Use a small screwdriver to remove the hard drive screw(s), and place the screw(s) in a safe location.

bottom of computer

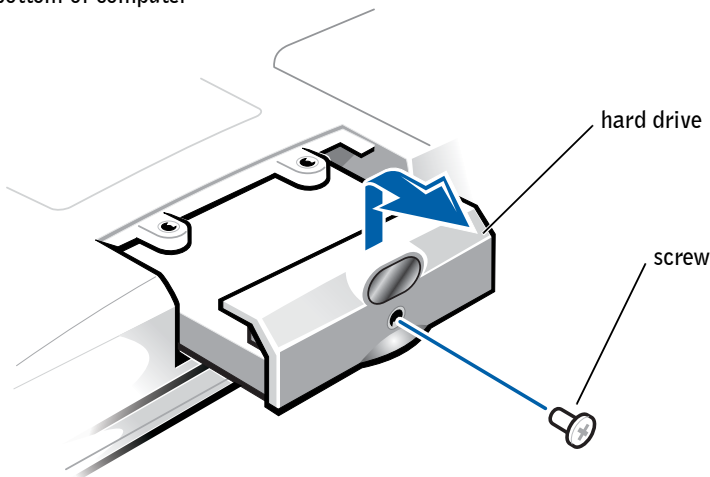

NOTICE: When the hard drive is not in the computer, store it in protective antistatic packaging. See "Protecting Against Electrostatic Discharge" on page 15.

- 9 Lift the hard drive cover until you feel a click.

HINT: Dell does not guarantee compatibility or provide support for hard drives from sources other than Dell.

HINT: You need the *Operating System* CD to install the Windows[®] operating system. You also need the *Drivers and Utilities* CD for your computer to install the drivers and utilities on the new hard drive.

10 Slide the hard drive out of the computer.

11 Remove the new drive from its packaging.

Save the original packaging to use when storing or shipping the hard drive.

➡ NOTICE: Use firm and even pressure to slide the drive into place. If you force the hard drive into place using excessive force, you may damage the connector.

12 Insert the drive into the bay, and lift the hard drive cover until you feel a click. Push the hard drive until it is fully seated in the bay. Press the hard drive cover down.

13 Replace and tighten the screw(s) you removed in step 8.

14 Use the *Operating System* CD to install the operating system for your computer (see page 99).

15 Use the *Drivers and Utilities* CD to install the drivers and utilities for your computer (see page 92).

Returning a Hard Drive to Dell

Return your old hard drive to Dell in its original or comparable foam packaging. Otherwise, the hard drive may be damaged in transit.

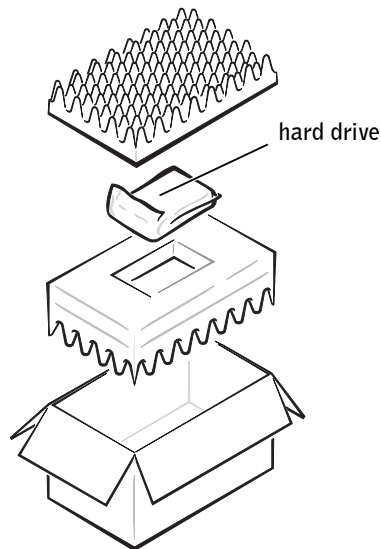

SECTION 4

Appendix

Specifications

System Setup Overview

Dell Technical Support Policy (U.S. Only)

Contacting Dell

Regulatory Notices

Limited Warranties and Return Policy

Specifications

Microprocessor

Microprocessor types	Intel® Mobile Pentium® 4
L1 cache	8 KB (internal)
L2 cache	512 KB
External bus frequency	400-MHz front-side bus

System Information

System chip set	Intel 845MP
Data bus width	64 bits
Microprocessor address bus width	32 bits
Graphics bus	32-bit AGP 4X
PCI bus	33 MHz

PC Card

CardBus controller	Texas Instruments PCI 4450/4451 CardBus controller
PC Card connector	two (supports two Type I or Type II cards or one Type III card)
Cards supported	3.3 V and 5 V
PC Card connector size	68 pins
Data width (maximum)	PCMCIA 16 bits CardBus 32 bits

Memory

Architecture	PC2100 DDR
Memory module connector	two user-accessible SODIMM sockets
Memory module capacities	128, 256, and 512 MB
Memory type	DDR SDRAM
Standard memory	128 MB

Memory (continued)

Maximum memory	1024 MB
Memory access time: clock speed	266 MHz

Ports and Connectors

Serial	9-pin connector; 16550C-compatible, 16-byte buffer connector
Parallel	25-hole connector; unidirectional, bidirectional, or ECP
Video	15-hole VGA connector
Audio	stereo (line-in) mini connector; microphone mini connector, stereo headphone/speakers (line-out) mini connector
PS/2 keyboard/mouse	6-pin mini-DIN connector
USB	two 4-pin USB-compliant connector
Infrared	sensor compatible with IrDA Standard 1.1 (Fast IR) and IrDA Standard 1.0 (Slow IR)
Docking	200-pin connector for a Dell™ docking device
S-video TV-out	7-pin mini-DIN connector for S-video, composite video, and S/PDIF (TV/digital audio adapter cable supports composite video and S/PDIF)
Modem	RJ-11 port
Network adapter	RJ-45 port
IEEE 1394	4-pin serial connector

Communications

Modem:

Type	integrated v.92 56K
Controller	softmodem
Interface	internal AC 97 bus

Communications (continued)

Network adapter	10/100 Ethernet LAN on system board
Wireless	internal Mini PCI Wi-Fi (802.11b) wireless support

Video

Video type	128-bit hardware accelerated
Data bus	4X AGP
Video controller	NVIDIA GeForce4 440 Go™ ATI Mobility™ RADEON™ 9000
Video memory	32 or 64 MB for NVIDIA GeForce4 440 Go 64 MB for ATI MOBILITY RADEON 9000
LCD interface	LVDS
TV support	NTSC or PAL in S-video and composite modes

Audio

Audio type	AC97 (Soft Audio)
Audio controller	Cirrus Logic/Crystal CS4205
Stereo conversion	18-bit analog-to-digital 20-bit digital-to-analog
Interfaces:	
Internal	AC 97
External	microphone-in connector, stereo headphones/speakers connector, and stereo line-in connector
Speaker	two 4-ohm speakers
Internal speaker amplifier	1.9 W per channel into 4 ohms
Volume controls	keyboard shortcuts, program menus

Display

Type (active-matrix TFT)	SXGA+, UXGA, or Dell UltraSharp™ UXGA TFT
Dimensions:	
Height	228.1 mm (9 inches)
Width	304.1 mm (12 inches)
Diagonal	380.1 mm (15 inches)
Maximum resolutions	1400 x 1050 at 16.8 million colors (SXGA+) 1600 x 1200 at 16.8 million colors (UXGA and Dell UltraSharp UXGA TFT)
Response time (typical)	20-ms rise (maximum) (SXGA+ and UXGA) 30-ms fall (maximum) (SXGA+ and UXGA) 9-ms rise (maximum) (Dell UltraSharp UXGA TFT) 16-ms fall (maximum) (Dell UltraSharp UXGA TFT)
Refresh rate	60 Hz
Operating angle	0° (closed) to 180°
Pixel pitch	0.20 x 0.20 mm (SXGA+) 0.19 x 0.19 mm (UXGA and Dell UltraSharp UXGA TFT)
Controls	brightness can be controlled through keyboard shortcuts

Keyboard

Number of keys	87 (U.S. and Canada); 88 (Europe); 90 (Japan)
Key travel	2.7 mm ± 0.3 (0.11 inch ± 0.016 inch)
Key spacing	19.05 mm ± 0.3 mm (0.75 inch ± 0.012 inch)
Layout	QWERTY/AZERTY/Kanji

Touch Pad

X/Y position resolution (graphics table mode)	240 cpi
Size:	
Width	64.88-mm (2.55-inch) sensor-active area
Height	48.88-mm (1.92-inch) rectangle

Track Stick

X/Y position resolution (graphics table mode)	250 count/sec @ 100 gf
Size	protrudes 0.5 mm higher than surrounding key caps

Battery

Type	66-WHr "smart" lithium ion (4460 mAh)
Dimensions:	
Depth	88.5 mm (3.48 inches)
Height	21.5 mm (0.83 inch)
Width	139.0 mm (5.47 inches)
Weight	0.40 kg (0.88 lb)
Voltage	14.8 VDC
Charge time (approximate):	
Computer on	2.5 hours
Computer off	1.5 hours
Operating life	approximately 2 to 4 hours, depending on usage and configuration
Life span (approximate)	400 discharge/charge cycles
Temperature range:	
Operating	0° to 35°C (32° to 95°F)
Storage	-40° to 65°C (-40° to 149°F)

AC Adapter

Input voltage	90 to 135 VAC and 164 to 264 VAC
Input current (maximum)	1.5 A
Input frequency	47 to 63 Hz
Output current	5.5 A (maximum at 4-second pulse); 4.5 A (continuous)
Output power	90 W
Rated output voltage	20 VDC
Dimensions:	
Height	27.94 mm (1.1 inches)
Width	58.42 mm (2.3 inches)
Depth	133.85 mm (5.25 inches)
Weight (with cables)	0.4 kg (0.9 lb)
Temperature range:	
Operating	0° to 35°C (32° to 95°F)
Storage	-40° to 65°C (-40° to 149°F)

Physical

Height	44.5 mm (1.75 inches)
Width	331.0 mm (13.03 inches)
Depth	276.0 mm (10.87 inches)
Weight (average, depending on configuration)	3.46 kg (7.64 lb)

Environmental

Temperature range:

Operating	0° to 35°C (32° to 95°F)
Storage	-40° to 65°C (-40° to 149°F)

Relative humidity (maximum):

Operating	10% to 90% (noncondensing)
Storage	5% to 95% (noncondensing)

Maximum vibration (using a random-vibration spectrum that simulates a user environment):

Operating	0.9 GRMS
Storage	1.3 GRMS

Maximum shock (measured with the hard drive in head-parked position and with a 2-ms half-sine pulse):

Operating	122 G
Storage	163 G

Altitude (maximum):

Operating	-15.2 to 3048 m (-50 to 10,000 ft)
Storage	-15.2 to 10,668 m (-50 to 35,000 ft)

System Setup Overview

You can use the system setup program as follows:

- To set or change user-selectable features—for example, your password
- To verify information about your computer's current configuration, such as the amount of system memory

After you set up your computer, run the system setup program to familiarize yourself with your system configuration information and optional settings. Dell recommends that you write down the information for future reference.



The system setup program contains the standard settings for your computer.

 **NOTICE:** Unless you are an expert computer user or are directed to do so by Dell technical support, do not change the settings for this program. Certain changes might make your computer work incorrectly.

Viewing the System Setup Screens

- 1 Turn on (or restart) your computer.
- 2 When the Dell™ logo appears, press  immediately.

If you wait too long and the Windows® logo appears, continue to wait until you see the Windows desktop. Then shut down your computer (see page 42) and try again.

Depending on your computer, you may also be able to enter the system setup program by pressing   at any time while the computer is running.

System Setup Screens

The system setup screens display the current setup information and settings for your computer. Each screen is laid out with the system setup options listed at the left. To the right of each option is a field that displays the setting or value for that option. You can change settings that appear as white type on the screen. Options or values that you cannot change (because they are determined by the computer) appear less bright.

 **HINT:** Your operating system may automatically configure most of the options available in the system setup program, thus overriding options that you set through the system setup program. (An exception is the **External Hot Key** option, which you can disable or enable only through the system setup program.) For more information on configuring features for your operating system, see your Microsoft® Windows Help and Support Center.

 **HINT:** To see information about a specific item on a system setup screen, highlight the item and refer to the **Help** area on the screen.

A box in the upper-right corner of the screen displays help information for the currently highlighted option; a box in the lower-right corner displays information about the computer. System setup key functions are listed across the bottom of the screen.

The screens display such information as:

- System configuration
- Boot (start-up) configuration and docking device configuration settings
- Basic device configuration settings
- Battery charge status
- Power management settings
- System security and hard drive password settings

Commonly Used Options

Changing the Boot Sequence



 **HINT:** Certain options require that you reboot the computer for new settings to take effect.

The *boot sequence*, or *boot order*, tells the computer where to look to find the software needed to start the operating system. You can control the boot sequence using the **Boot Order** page of the system setup program.

The **Boot Order** page displays a general list of the bootable devices that may be installed in your computer, including but not limited to the following:

- **Diskette Drive**
- **Modular bay HDD**
- **Internal HDD**
- **CD/DVD/CD-RW drive**

During the boot routine, the computer starts at the top of the list and scans each enabled device for the operating system start-up files. When the computer finds the files, it stops searching and starts the operating system.

To control the boot sequence, you can select (highlight) devices using the  and  keys and then enable or disable them or change their order in the list.

- To enable or disable a device, highlight the item and press . Enabled items appear as white and display a small triangle to the left; disabled items appear blue or dimmed without a triangle.
- To reorder a device in the list, highlight the device and then press or (not case-sensitive) to move the highlighted device up or down.

Boot sequence changes take effect as soon as you save the changes and exit the system setup program.

Changing Printer Modes

Set the **Parallel Mode** option according to the type of printer or device connected to the parallel connector. To determine the correct mode to use, see the documentation that came with the device.

Setting **Parallel Mode** to **Disabled** disables the parallel port and the port's LPT address, freeing its interrupt for another device to use.

Changing COM Ports

Serial Port allows you to map the serial port COM address or disable the serial port and its address, freeing that interrupt for another device to use.

Dell Technical Support Policy (U.S. Only)

Technician-assisted technical support requires the cooperation and participation of the customer in the troubleshooting process and provides for restoration of the operating system, application software, and hardware drivers to the original default configuration as shipped from Dell, as well as the verification of appropriate functionality of the computer and all Dell-installed hardware. In addition to this technician-assisted technical support, online technical support is available through Dell Support at support.dell.com. Additional technical support options may be available for purchase.

Dell provides limited technical support for the computer and any “Dell-installed” software and peripherals¹. Support for third-party software and peripherals is provided by the original manufacturer, including those purchased and/or installed through Dell Software and Peripherals (DellWare™), Readyware, and Custom Factory Integration (DellPlus™)².

- ¹ Repair services are provided pursuant to the terms and conditions of your limited warranty and any optional support service contract purchased with the computer.
- ² All Dell-standard components included in a Custom Factory Integration (CFI) project are covered by the standard Dell limited warranty for your computer. However, Dell also extends a parts replacement program to cover all nonstandard, third-party hardware components integrated through CFI for the duration of the computer’s service contract.

Definition of “Dell-Installed” Software and Peripherals

Dell-installed software includes the operating system and some of the application software that is preinstalled on the computer during the manufacturing process (Microsoft Office, Norton Antivirus, and so on).

Dell-installed peripherals include any internal expansion cards, or Dell-branded module bay or PC Card accessories. In addition, any Dell-branded monitors, keyboards, mice, speakers, microphones for telephonic modems, docking stations/port replicators, networking products, and all associated cabling are included.

Definition of “Third-Party” Software and Peripherals

Third-party software and peripherals include any peripheral, accessory, or application software sold by Dell not under the Dell brand (printers, scanners, cameras, games, and so on). Support for all third-party software and peripherals is provided by the original manufacturer of the product.

Returning Items for Warranty Repair or Credit

Prepare all items being returned, whether for repair or credit, as follows:

- 1** Call Dell to obtain an authorization number, and write it clearly and prominently on the outside of the box.
For the telephone number to call, see "Contacting Dell" on page 124.
- 2** Include a copy of the invoice and a letter describing the reason for the return.
- 3** Include any accessories that belong with the item(s) being returned (power cables, software floppy disks, guides, and so on) if the return is for credit.
- 4** Pack the equipment to be returned in the original (or equivalent) packing materials.

You are responsible for paying shipping expenses. You are also responsible for insuring any product returned, and you assume the risk of loss during shipment to Dell. Collect On Delivery (C.O.D.) packages are not accepted.

Returns that are missing any of the preceding requirements will be refused at Dell's receiving dock and returned to you.

Contacting Dell

To contact Dell electronically, you can access the following websites:

- www.dell.com
- support.dell.com (technical support)
- premiersupport.dell.com (technical support for educational, government, healthcare, and medium/large business customers, including Premier, Platinum, and Gold customers)

For specific web addresses for your country, find the appropriate country section in the table below.

NOTE: Toll-free numbers are for use within the country for which they are listed.

When you need to contact Dell, use the electronic addresses, telephone numbers, and codes provided in the following table. If you need assistance in determining which codes to use, contact a local or an international operator.

Country (City) International Access Code Country Code City Code	Department Name or Service Area, Website and E-Mail Address	Area Codes, Local Numbers, and Toll-Free Numbers
Anguilla	General Support	toll-free: 800-335-0031
Antigua and Barbuda	General Support	1-800-805-5924
Argentina (Buenos Aires)	Website: www.dell.com.ar	
International Access Code: 00	Tech Support and Customer Care	toll-free: 0-800-444-0733
Country Code: 54	Sales	0-810-444-3355
City Code: 11	Tech Support Fax	11 4515 7139
	Customer Care Fax	11 4515 7138
Aruba	General Support	toll-free: 800-1578

Country (City) International Access Code Country Code City Code	Department Name or Service Area, Website and E-Mail Address	Area Codes, Local Numbers, and Toll-Free Numbers
Australia (Sydney)	E-mail (Australia): au_tech_support@dell.com	
International Access Code: 0011	E-mail (New Zealand): nz_tech_support@dell.com	
Country Code: 61	Home and Small Business	1-300-65-55-33
City Code: 2	Government and Business	toll-free: 1-800-633-559
	Preferred Accounts Division (PAD)	toll-free: 1-800-060-889
	Customer Care	toll-free: 1-800-819-339
	Corporate Sales	toll-free: 1-800-808-385
	Transaction Sales	toll-free: 1-800-808-312
	Fax	toll-free: 1-800-818-341
Austria (Vienna)	Website: support.euro.dell.com	
International Access Code: 900	E-mail: tech_support_central_europe@dell.com	
Country Code: 43	Home/Small Business Sales	01 795 67602
City Code: 1	Home/Small Business Fax	01 795 67605
	Home/Small Business Customer Care	01 795 67603
	Preferred Accounts/Corporate Customer Care	0660 8056
	Home/Small Business Technical Support	01 795 67604
	Preferred Accounts/Corporate Technical Support	0660 8779
	Switchboard	01 491 04 0
Bahamas	General Support	toll-free: 1-866-278-6818
Barbados	General Support	1-800-534-3066
Belgium (Brussels)	Website: support.euro.dell.com	
International Access Code: 00	E-mail: tech_be@dell.com	
Country Code: 32	E-mail for French Speaking Customers: support.euro.dell.com/be/fr/emaildell/	
City Code: 2	Technical Support	02 481 92 88
	Customer Care	02 481 91 19
	Home/Small Business Sales	toll-free: 0800 16884
	Corporate Sales	02 481 91 00
	Fax	02 481 92 99
	Switchboard	02 481 91 00

Country (City) International Access Code Country Code City Code	Department Name or Service Area, Website and E-Mail Address	Area Codes, Local Numbers, and Toll-Free Numbers
Bermuda	General Support	1-800-342-0671
Bolivia	General Support	toll-free: 800-10-0238
Brazil	Website: www.dell.com/br	
International Access Code: 00	Customer Support, Technical Support	0800 90 3355
Country Code: 55	Tech Support Fax	51 481 5470
City Code: 51	Customer Care Fax	51 481 5480
	Sales	0800 90 3390
British Virgin Islands	General Support	toll-free: 1-866-278-6820
Brunei	Customer Technical Support (Penang, Malaysia)	604 633 4966
Country Code: 673	Customer Service (Penang, Malaysia)	604 633 4949
	Transaction Sales (Penang, Malaysia)	604 633 4955
Canada (North York, Ontario)	Automated Order-Status System	toll-free: 1-800-433-9014
International Access Code: 011	AutoTech (automated technical support)	toll-free: 1-800-247-9362
	Customer Care (from outside Toronto)	toll-free: 1-800-387-5759
	Customer Care (from within Toronto)	416 758-2400
	Customer Technical Support	toll-free: 1-800-847-4096
	Sales (direct sales—from outside Toronto)	toll-free: 1-800-387-5752
	Sales (direct sales—from within Toronto)	416 758-2200
	Sales (federal government, education, and medical)	toll-free: 1-800-567-7542
	Sales (major accounts)	toll-free: 1-800-387-5755
	TechFax	toll-free: 1-800-950-1329
Cayman Islands	General Support	1-800-805-7541
Chile (Santiago)	Sales, Customer Support, and Technical Support	toll-free: 1230-020-4823
Country Code: 56		
City Code: 2		

Country (City) International Access Code Country Code City Code	Department Name or Service Area, Website and E-Mail Address	Area Codes, Local Numbers, and Toll-Free Numbers
China (Xiamen) Country Code: 86 City Code: 592	Tech Support website: support.ap.dell.com/china Tech Support E-mail: cn_support@dell.com Tech Support Fax Home and Small Business Technical Support Corporate Accounts Technical Support Customer Experience Home and Small Business Preferred Accounts Division Large Corporate Accounts GCP Large Corporate Accounts Key Accounts Large Corporate Accounts North Large Corporate Accounts North Government and Education Large Corporate Accounts East Large Corporate Accounts East Government and Education Large Corporate Accounts Queue Team Large Corporate Accounts South Large Corporate Accounts West Large Corporate Accounts Spare Parts	818 1350 toll-free: 800 858 2437 toll-free: 800 858 2333 toll-free: 800 858 2060 toll-free: 800 858 2222 toll-free: 800 858 2062 toll-free: 800 858 2055 toll-free: 800 858 2628 toll-free: 800 858 2999 toll-free: 800 858 2955 toll-free: 800 858 2020 toll-free: 800 858 2669 toll-free: 800 858 2572 toll-free: 800 858 2355 toll-free: 800 858 2811 toll-free: 800 858 2621
Colombia	General Support	980-9-15-3978
Costa Rica	General Support	0800-012-0435
Czech Republic (Prague) International Access Code: 00 Country Code: 420 City Code: 2	Website: support.euro.dell.com E-mail: czech_dell@dell.com Technical Support Customer Care Fax TechFax Switchboard	02 22 83 27 27 02 22 83 27 11 02 22 83 27 14 02 22 83 27 28 02 22 83 27 11

Country (City) International Access Code Country Code City Code	Department Name or Service Area, Website and E-Mail Address	Area Codes, Local Numbers, and Toll-Free Numbers
Denmark (Copenhagen) International Access Code: 00 Country Code: 45	Website: support.euro.dell.com E-mail Support (portable computers): den_nbk_support@dell.com E-mail Support (desktop computers): den_support@dell.com E-mail Support (servers): Nordic_server_support@dell.com	
	Technical Support	7023 0182
	Customer Care (Relational)	7023 0184
	Home/Small Business Customer Care	3287 5505
	Switchboard (Relational)	3287 1200
	Fax Switchboard (Relational)	3287 1201
	Switchboard (Home/Small Business)	3287 5000
	Fax Switchboard (Home/Small Business)	3287 5001
Dominica	General Support	toll-free: 1-866-278-6821
Dominican Republic	General Support	1-800-148-0530
Ecuador	General Support	toll-free: 999-119
El Salvador	General Support	01-899-753-0777
Finland (Helsinki) International Access Code: 990 Country Code: 358 City Code: 9	Website: support.euro.dell.com E-mail: fin_support@dell.com E-mail Support (servers): Nordic_support@dell.com	
	Technical Support	09 253 313 60
	Technical Support Fax	09 253 313 81
	Relational Customer Care	09 253 313 38
	Home/Small Business Customer Care	09 693 791 94
	Fax	09 253 313 99
	Switchboard	09 253 313 00

Country (City) International Access Code Country Code City Code	Department Name or Service Area, Website and E-Mail Address	Area Codes, Local Numbers, and Toll-Free Numbers
France (Paris) (Montpellier) International Access Code: 00 Country Code: 33 City Codes: (1) (4)	Website: support.euro.dell.com E-mail: support.euro.dell.com/fr/fr/emaildell/ Home and Small Business Technical Support Customer Care Switchboard Switchboard (calls from outside of France) Sales Fax Fax (calls from outside of France) Corporate Technical Support Customer Care Switchboard Sales Fax	0825 387 270 0825 823 833 0825 004 700 04 99 75 40 00 0825 004 700 0825 004 701 04 99 75 40 01 0825 004 719 0825 338 339 01 55 94 71 00 01 55 94 71 00 01 55 94 71 01
Germany (Langen) International Access Code: 00 Country Code: 49 City Code: 6103	Website: support.euro.dell.com E-mail: tech_support_central_europe@dell.com Technical Support Home/Small Business Customer Care Global Segment Customer Care Preferred Accounts Customer Care Large Accounts Customer Care Public Accounts Customer Care Switchboard	06103 766-7200 0180-5-224400 06103 766-9570 06103 766-9420 06103 766-9560 06103 766-9555 06103 766-7000
Grenada	General Support	toll-free: 1-866-540-3355
Guatemala	General Support	1-800-999-0136
Guyana	General Support	toll-free: 1-877-270-4609

Country (City) International Access Code Country Code City Code	Department Name or Service Area, Website and E-Mail Address	Area Codes, Local Numbers, and Toll-Free Numbers
Hong Kong	Technical Support (Dimension™ and Inspiron™)	296 93188
International Access Code: 001 Country Code: 852	Technical Support (OptiPlex™, Latitude™, and Dell Precision™)	296 93191
	Customer Service (non-technical, post-sales issues)	800 93 8291
	Transaction Sales	toll-free: 800 96 4109
	Large Corporate Accounts HK	toll-free: 800 96 4108
	Large Corporate Accounts GCP HK	toll-free: 800 90 3708
India	Technical Support	1600 33 8045
	Sales	1600 33 8044
Ireland (Cherrywood)	Website: support.euro.dell.com	
International Access Code: 16 Country Code: 353 City Code: 1	E-mail: dell_direct_support@dell.com	
	Ireland Technical Support	1850 543 543
	U.K. Technical Support (dial within U.K. only)	0870 908 0800
	Home User Customer Care	01 204 4095
	Small Business Customer Care	01 204 4444
	U.K. Customer Care (dial within U.K. only)	0870 906 0010
	Corporate Customer Care	01 204 4003
	Ireland Sales	01 204 4444
	U.K. Sales (dial within U.K. only)	0870 907 4000
	SalesFax	01 204 0144
	Fax	01 204 5960
	Switchboard	01 204 4444

Country (City) International Access Code Country Code City Code	Department Name or Service Area, Website and E-Mail Address	Area Codes, Local Numbers, and Toll-Free Numbers
Italy (Milan)	Website: support.euro.dell.com	
International Access Code: 00	E-mail: support.euro.dell.com/it/it/emaildell/	
Country Code: 39	Home and Small Business	
City Code: 02	Technical Support	02 577 826 90
	Customer Care	02 696 821 14
	Fax	02 696 821 13
	Switchboard	02 696 821 12
	Corporate	
	Technical Support	02 577 826 90
	Customer Care	02 577 825 55
	Fax	02 575 035 30
	Switchboard	02 577 821
Jamaica	General Support (dial from within Jamaica only)	1-800-682-3639

Country (City) International Access Code Country Code City Code	Department Name or Service Area, Website and E-Mail Address	Area Codes, Local Numbers, and Toll-Free Numbers
Japan (Kawasaki)	Website: support.jp.dell.com	
International Access Code: 001	Technical Support (servers)	toll-free: 0120-1984-98
Country Code: 81	Technical Support outside of Japan (servers)	81-44-556-4162
City Code: 44	Technical Support (Dimension™ and Inspiron™)	toll-free: 0120-1982-26
	Technical Support outside of Japan (Dimension and Inspiron)	81-44-520-1435
	Technical Support (Dell Precision™, OptiPlex™, and Latitude™)	toll-free:0120-1984-33
	Technical Support outside of Japan (Dell Precision, OptiPlex, and Latitude)	81-44-556-3894
	24-Hour Automated Order Service	044-556-3801
	Customer Care	044-556-4240
	Business Sales Division (up to 400 employees)	044-556-1465
	Preferred Accounts Division Sales (over 400 employees)	044-556-3433
	Large Corporate Accounts Sales (over 3500 employees)	044-556-3430
	Public Sales (government agencies, educational institutions, and medical institutions)	044-556-1469
	Global Segment Japan	044-556-3469
	Individual User	044-556-1760
	Faxbox Service	044-556-3490
	Switchboard	044-556-4300
Korea (Seoul)	Technical Support	toll-free: 080-200-3800
International Access Code: 001	Sales	toll-free: 080-200-3600
Country Code: 82	Customer Service (Seoul, Korea)	toll-free: 080-200-3800
City Code: 2	Customer Service (Penang, Malaysia)	604 633 4949
	Fax	2194-6202
	Switchboard	2194-6000

Country (City) International Access Code Country Code City Code	Department Name or Service Area, Website and E-Mail Address	Area Codes, Local Numbers, and Toll-Free Numbers
Latin America	Customer Technical Support (Austin, Texas, U.S.A.)	512 728-4093
	Customer Service (Austin, Texas, U.S.A.)	512 728-3619
	Fax (Technical Support and Customer Service) (Austin, Texas, U.S.A.)	512 728-3883
	Sales (Austin, Texas, U.S.A.)	512 728-4397
	SalesFax (Austin, Texas, U.S.A.)	512 728-4600 or 512 728-3772
Luxembourg	Website: support.euro.dell.com	
International Access Code: 00	E-mail: tech_be@dell.com	
Country Code: 352	Technical Support (Brussels, Belgium)	02 481 92 88
	Home/Small Business Sales (Brussels, Belgium)	toll-free: 080016884
	Corporate Sales (Brussels, Belgium)	02 481 91 00
	Customer Care (Brussels, Belgium)	02 481 91 19
	Fax (Brussels, Belgium)	02 481 92 99
	Switchboard (Brussels, Belgium)	02 481 91 00
Macao	Technical Support	toll-free: 0800 582
Country Code: 853	Customer Service (Penang, Malaysia)	604 633 4949
	Transaction Sales	toll-free: 0800 581
Malaysia (Penang)	Technical Support	toll-free: 1 800 888 298
International Access Code: 00	Customer Service	04 633 4949
Country Code: 60	Transaction Sales	toll-free: 1 800 888 202
City Code: 4	Corporate Sales	toll-free: 1 800 888 213

Country (City) International Access Code Country Code City Code	Department Name or Service Area, Website and E-Mail Address	Area Codes, Local Numbers, and Toll-Free Numbers
Mexico International Access Code: 00 Country Code: 52	Customer Technical Support Sales Customer Service Main	001-877-384-8979 or 001-877-269-3383 50-81-8800 or 01-800-888-3355 001-877-384-8979 or 001-877-269-3383 50-81-8800 or 01-800-888-3355
Montserrat	General Support	toll-free: 1-866-278-6822
Netherlands Antilles	General Support	001-800-882-1519
Netherlands (Amsterdam) International Access Code: 00 Country Code: 31 City Code: 20	Website: support.euro.dell.com E-mail: support.euro.dell.com/nl/nl/emaildell/ Technical Support Home/Small and Medium Business Home/Small and Medium Business Fax Home/Small and Medium Business Customer Care Corporate Corporate Fax Corporate Customer Care	020 674 45 00 020 674 55 00 020 674 47 75 020 674 42 00 020 674 50 00 020 674 47 79 020 674 43 25
New Zealand International Access Code: 00 Country Code: 64	E-mail (New Zealand): nz_tech_support@dell.com E-mail (Australia): au_tech_support@dell.com Home and Small Business Government and Business Sales Fax	0800 446 255 0800 444 617 0800 441 567 0800 441 566
Nicaragua	General Support	001-800-220-1006

Country (City) International Access Code Country Code City Code	Department Name or Service Area, Website and E-Mail Address	Area Codes, Local Numbers, and Toll-Free Numbers
Norway (Lysaker)	Website: support.euro.dell.com	
International Access Code: 00	E-mail Support (portable computers):	
Country Code: 47	nor_nbk_support@dell.com	
	E-mail Support (desktop computers):	
	nor_support@dell.com	
	E-mail Support (servers):	
	nordic_server_support@dell.com	
	Technical Support	671 16882
	Relational Customer Care	671 17514
	Home/Small Business Customer Care	23162298
	Switchboard	671 16800
	Fax Switchboard	671 16865
Panama	General Support	001-800-507-0962
Peru	General Support	0800-50-669
Poland (Warsaw)	Website: support.euro.dell.com	
International Access Code: 011	E-mail: pl_support@dell.com	
Country Code: 48	Customer Service Phone	57 95 700
City Code: 22	Customer Care	57 95 999
	Sales	57 95 999
	Customer Service Fax	57 95 806
	Reception Desk Fax	57 95 998
	Switchboard	57 95 999
Portugal	E-mail: support.euro.dell.com/es/es/emaildell/	
International Access Code: 00	Technical Support	800 834 077
Country Code: 35	Customer Care	800 300 415 or 800 834 075
	Sales	800 300 410 or 800 300 411 or 800 300 412 or 121 422 07 10
	Fax	121 424 01 12

Country (City) International Access Code Country Code City Code	Department Name or Service Area, Website and E-Mail Address	Area Codes, Local Numbers, and Toll-Free Numbers
Puerto Rico	General Support	1-800-805-7545
St. Kitts and Nevis	General Support	toll-free: 1-877-441-4731
St. Lucia	General Support	1-800-882-1521
St. Vincent and the Grenadines	General Support	toll-free: 1-877-270-4609
Singapore (Singapore)	Technical Support	toll-free: 800 6011 051
International Access Code: 005	Customer Service (Penang, Malaysia)	604 633 4949
Country Code: 65	Transaction Sales	toll-free: 800 6011 054
	Corporate Sales	toll-free: 800 6011 053
South Africa (Johannesburg)	Website: support.euro.dell.com	
International Access Code:	E-mail: dell_za_support@dell.com	
09/091	Technical Support	011 709 7710
Country Code: 27	Customer Care	011 709 7707
City Code: 11	Sales	011 709 7700
	Fax	011 706 0495
	Switchboard	011 709 7700
Southeast Asian and Pacific Countries	Customer Technical Support, Customer Service, and Sales (Penang, Malaysia)	604 633 4810
Spain (Madrid)	Website: support.euro.dell.com	
International Access Code: 00	E-mail: support.euro.dell.com/es/es/emaildell/	
Country Code: 34	Home and Small Business	
City Code: 91	Technical Support	902 100 130
	Customer Care	902 118 540
	Sales	902 118 541
	Switchboard	902 118 541
	Fax	902 118 539
	Corporate	
	Technical Support	902 100 130
	Customer Care	902 118 546
	Switchboard	91 722 92 00
	Fax	91 722 95 83

Country (City) International Access Code Country Code City Code	Department Name or Service Area, Website and E-Mail Address	Area Codes, Local Numbers, and Toll-Free Numbers
Sweden (Upplands Vasby) International Access Code: 00 Country Code: 46 City Code: 8	Website: support.euro.dell.com E-mail: swe_support@dell.com E-mail Support for Latitude and Inspiron: Swe-nbk_kats@dell.com E-mail Support for OptiPlex: Swe_kats@dell.com E-mail Support for Servers: Nordic_server_support@dell.com Technical Support Relational Customer Care Home/Small Business Customer Care Employee Purchase Program (EPP) Support Fax Technical Support Sales	08 590 05 199 08 590 05 642 08 587 70 527 20 140 14 44 08 590 05 594 08 590 05 185
Switzerland (Geneva) International Access Code: 00 Country Code: 41 City Code: 22	Website: support.euro.dell.com E-mail: swisstech@dell.com E-mail for French-speaking HSB and Corporate Customers: support.euro.dell.com/ch/fr/emaildell/ Technical Support (Home and Small Business) Technical Support (Corporate) Customer Care (Home and Small Business) Customer Care (Corporate) Fax Switchboard	0844 811 411 0844 822 844 0848 802 202 0848 821 721 022 799 01 90 022 799 01 01
Taiwan International Access Code: 002 Country Code: 886	Technical Support (portable and desktop computers) Technical Support (servers) Transaction Sales Corporate Sales	toll-free: 00801 86 1011 toll-free: 0080 60 1256 toll-free: 0080 651 228 or 0800 33 556 toll-free: 0080 651 227 or 0800 33 555

Country (City) International Access Code Country Code City Code	Department Name or Service Area, Website and E-Mail Address	Area Codes, Local Numbers, and Toll-Free Numbers
Thailand	Technical Support	toll-free: 0880 060 07
International Access Code: 001	Customer Service (Penang, Malaysia)	604 633 4949
Country Code: 66	Sales	toll-free: 0880 060 09
Trinidad/Tobago	General Support	1-800-805-8035
Turks and Caicos Islands	General Support	toll-free: 1-866-540-3355
U.K. (Bracknell)	Website: support.euro.dell.com	
International Access Code: 00	Customer Care website:	
Country Code: 44	dell.co.uk/lca/customerservices	
City Code: 1344	E-mail: dell_direct_support@dell.com	
	Technical Support (Corporate/Preferred Accounts/PAD [1000+ employees])	0870 908 0500
	Technical Support (direct/PAD and general)	0870 908 0800
	Global Accounts Customer Care	01344 373 185
		or 01344 373 186
	Home and Small Business Customer Care	0870 906 0010
	Corporate Customer Care	0870 908 0500
	Preferred Accounts (500–5000 employees) Customer Care	01344 373 196
	Central Government Customer Care	01344 373 193
	Local Government & Education Customer Care	01344 373 199
	Health Customer Care	01344 373 194
	Home and Small Business Sales	0870 907 4000
	Corporate/Public Sector Sales	01344 860 456
Uruguay	General Support	toll-free: 000-413-598-2521

Country (City) International Access Code Country Code City Code	Department Name or Service Area, Website and E-Mail Address	Area Codes, Local Numbers, and Toll-Free Numbers
U.S.A. (Austin, Texas)	Automated Order-Status Service	toll-free: 1-800-433-9014
International Access Code: 011 Country Code: 1	AutoTech (portable and desktop computers)	toll-free: 1-800-247-9362
	Consumer (Home and Home Office)	
	Customer Technical Support	toll-free: 1-800-624-9896
	Customer Service	toll-free: 1-800-624-9897
	DellNet™ Service and Support	toll-free: 1-877-Dellnet (1-877-335-5638)
	Software Application Support	toll-free: 1-800-433-9005
	Employee Purchase Program (EPP) (Customer Service and Technical Support)	toll-free: 1-800-695-8133
	Financial Services website: www.dellfinancialservices.com	
	Financial Services (lease/loans)	toll-free: 1-877-577-3355
	Financial Services (Dell Preferred Accounts [DPA])	toll-free: 1-800-283-2210
	Business	
	Service and Technical Support	toll-free: 1-800-822-8965
	Employee Purchase Program (EPP) (Customer Service and Technical Support)	toll-free: 1-800-695-8133
	Public (government, education, and healthcare)	
	Service and Technical Support	toll-free: 1-800-456-3355
	Employee Purchase Program (EPP) (Customer Service and Technical Support)	toll-free: 1-800-234-1490
	Dell Sales	toll-free: 1-800-289-3355 or toll-free: 1-800-879-3355
	Dell Outlet Store (Dell refurbished computers)	toll-free: 1-888-798-7561
	Software and Peripherals Sales	toll-free: 1-800-671-3355
	Spare Parts Sales	toll-free: 1-800-357-3355
	Extended Service and Warranty Sales	toll-free: 1-800-247-4618
	Fax	toll-free: 1-800-727-8320
	Dell Services for the Deaf, Hard-of-Hearing, or Speech-Impaired	toll-free: 1-877-DELLTTY (1-877-335-5889)

Country (City) International Access Code Country Code City Code	Department Name or Service Area, Website and E-Mail Address	Area Codes, Local Numbers, and Toll-Free Numbers
U.S. Virgin Islands	General Support	1-877-673-3355
Venezuela	General Support	8001-3605

Regulatory Notices

Electromagnetic Interference (EMI) is any signal or emission, radiated in free space or conducted along power or signal leads, that endangers the functioning of a radio navigation or other safety service or seriously degrades, obstructs, or repeatedly interrupts a licensed radio communications service. Radio communications services include but are not limited to AM/FM commercial broadcast, television, cellular services, radar, air-traffic control, pager, and Personal Communication Services (PCS). These licensed services, along with unintentional radiators such as digital devices, including computers, contribute to the electromagnetic environment.

Electromagnetic Compatibility (EMC) is the ability of items of electronic equipment to function properly together in the electronic environment. While this computer has been designed and determined to be compliant with regulatory agency limits for EMI, there is no guarantee that interference will not occur in a particular installation. If this equipment does cause interference with radio communications services, which can be determined by turning the equipment off and on, you are encouraged to try to correct the interference by one or more of the following measures:

- Reorient the receiving antenna.
- Relocate the computer with respect to the receiver.
- Move the computer away from the receiver.
- Plug the computer into a different outlet so that the computer and the receiver are on different branch circuits.

If necessary, consult a Dell Technical Support representative or an experienced radio/television technician for additional suggestions.

Dell computers are designed, tested, and classified for their intended electromagnetic environment. These electromagnetic environment classifications generally refer to the following harmonized definitions:

- Class A is typically for business or industrial environments.
- Class B is typically for residential environments.

Information Technology Equipment (ITE), including devices, expansion cards, printers, input/output (I/O) devices, monitors, and so on, that are integrated into or connected to the computer should match the electromagnetic environment classification of the computer.

A Notice About Shielded Signal Cables: Use only shielded cables for connecting devices to any Dell device to reduce the possibility of interference with radio communications services. Using shielded cables ensures that you maintain the appropriate EMC classification for the intended environment. For parallel printers, a cable is available from Dell. If you prefer, you can order a cable from Dell on the World Wide Web at accessories.us.dell.com/sna/category.asp?category_id=4117.

Most Dell computers are classified for Class B environments. However, the inclusion of certain options can change the rating of some configurations to Class A. To determine the electromagnetic classification for your computer or device, refer to the following sections specific for each regulatory agency. Each section provides country-specific EMC/EMI or product safety information.

For additional regulatory information, see the *Tell Me How* help file that accompanied your computer. To access the help file, see page 72.

NOM Information (Mexico Only)

The following information is provided on the device(s) described in this document in compliance with the requirements of the official Mexican standards (NOM):

Exporter:	Dell Computer Corporation One Dell Way Round Rock, TX 78682
Importer:	Dell Computer de México, S.A. de C.V. Paseo de la Reforma 2620 - 11° Piso Col. Lomas Altas 11950 México, D.F.
Ship to:	Dell Computer de México, S.A. de C.V. al Cuidado de Kuehne & Nagel de México S. de R.L. Avenida Soles No. 55 Col. Peñon de los Baños 15520 México, D.F.
Model number:	PP01X
Supply voltage:	100–240 VAC
Frequency:	50–60 Hz
Current Consumption:	1.5 A
Output voltage:	20 VDC
Output current:	4.5 A

CE Mark Notice

This equipment complies with the essential requirements of the European Union Directive 1999/5/EC.

Cet équipement est conforme aux principales caractéristiques définies dans la Directive européenne RTTE 1999/5/CE.

Die Geräte erfüllen die grundlegenden Anforderungen der RTTE-Richtlinie (1999/5/EG).

Questa apparecchiatura è conforme ai requisiti essenziali della Direttiva Europea R&TTE 1999/5/CE.

Este equipo cumple los requisitos principales de la Directiva 1999/5/CE de la UE "Equipos de Terminales de Radio y Telecomunicaciones".

Este equipamento cumpre os requisitos essenciais da Directiva 1999/5/CE do Parlamento Europeu e do Conselho (Directiva RTT).

Ο εξοπλισμός αυτός πληροί τις βασικές απαιτήσεις της κοινοτικής οδηγίας EU R&TTE 1999/5/EK.

Deze apparatuur voldoet aan de noodzakelijke vereisten van EU-richtlijn betreffende radioapparatuur en telecommunicatie-eindapparatuur 1999/5/EG.

Dette udstyr opfylder de Væsentlige krav i EU's direktiv 1999/5/EC om Radio- og teleterminaludstyr.

Dette utstyret er i overensstemmelse med hovedkravene i R&TTE-direktivet (1999/5/EC) fra EU.

Utrustningen uppfyller kraven för EU-direktivet 1999/5/EC om ansluten teleutrustning och ömsesidigt erkännande av utrustningens överensstämmelse (R&TTE).

Tämä laite vastaa EU:n radio- ja telepäätelaitedirektiivin (EU R&TTE Directive 1999/5/EC) vaatimuksia.

Limited Warranties and Return Policy

Dell-branded hardware products purchased in the U.S. or Canada come with either a 90-day (U.S. only), one-year, two-year, three-year, or four-year limited warranty. To determine which warranty you purchased, see the Dell invoice that accompanied your computer. The following sections describe the limited warranties and return policy for the U.S., the limited warranties and return policy for Canada, and the manufacturer guarantee for Latin America and the Caribbean.

Limited Warranty for the U.S.

What is covered by this limited warranty?

This limited warranty covers defects in materials and workmanship in your—our end-user customer's—Dell-branded hardware products, including Dell-branded monitors, keyboards, and pointing devices (mice).

What is not covered by this limited warranty?

This limited warranty does not cover:

- Software, including the operating system and software added to the Dell-branded hardware products through our factory-integration system, third-party software, or the reloading of software
- Non-Dell-branded products and accessories
- Problems that result from:
 - External causes such as accident, abuse, misuse, or problems with electrical power
 - Servicing not authorized by us
 - Usage that is not in accordance with product instructions
 - Failure to follow the product instructions or failure to perform preventive maintenance
 - Problems caused by using accessories, parts, or components not supplied by us
- Products with missing or altered service tags or serial numbers
- Products for which we have not received payment

THIS WARRANTY GIVES YOU SPECIFIC LEGAL RIGHTS, AND YOU MAY ALSO HAVE OTHER RIGHTS WHICH VARY FROM STATE TO STATE (OR JURISDICTION TO JURISDICTION). DELL'S RESPONSIBILITY FOR MALFUNCTIONS AND DEFECTS IN HARDWARE IS LIMITED TO REPAIR AND REPLACEMENT AS SET FORTH IN THIS WARRANTY STATEMENT. ALL EXPRESS AND IMPLIED WARRANTIES FOR THE PRODUCT, INCLUDING BUT NOT LIMITED TO ANY IMPLIED WARRANTIES AND CONDITIONS OF MERCHANTABILITY AND FITNESS FOR A PARTICULAR PURPOSE, ARE LIMITED IN TIME TO THE TERM OF THE LIMITED WARRANTY PERIOD REFLECTED ON YOUR INVOICE. NO WARRANTIES, WHETHER EXPRESS OR IMPLIED, WILL APPLY AFTER THE LIMITED WARRANTY PERIOD HAS EXPIRED. SOME STATES DO NOT ALLOW LIMITATIONS ON HOW LONG AN IMPLIED WARRANTY LASTS, SO THIS LIMITATION MAY NOT APPLY TO YOU.

WE DO NOT ACCEPT LIABILITY BEYOND THE REMEDIES PROVIDED FOR IN THIS LIMITED WARRANTY OR FOR CONSEQUENTIAL OR INCIDENTAL DAMAGES, INCLUDING, WITHOUT LIMITATION, ANY LIABILITY FOR THIRD PARTY CLAIMS AGAINST YOU FOR DAMAGES, FOR PRODUCTS NOT BEING AVAILABLE FOR USE, OR FOR LOST DATA OR LOST SOFTWARE. OUR LIABILITY WILL BE NO MORE THAN THE AMOUNT YOU PAID FOR THE PRODUCT THAT IS THE SUBJECT OF A CLAIM. THIS IS THE MAXIMUM AMOUNT FOR WHICH WE ARE RESPONSIBLE.

SOME STATES DO NOT ALLOW THE EXCLUSION OR LIMITATION OF INCIDENTAL OR CONSEQUENTIAL DAMAGES, SO THE ABOVE LIMITATION OR EXCLUSION MAY NOT APPLY TO YOU.

How long does this limited warranty last?

This limited warranty lasts for the time period indicated on your invoice, except that the limited warranty on Dell-branded batteries lasts only one year and the limited warranty on the lamps for Dell-branded projectors lasts only ninety days. The limited warranty begins on the date of the invoice. The warranty period is not extended if we repair or replace a warranted product or any parts. Dell may change the availability of limited warranties, at its discretion, but any changes will not be retroactive.

What do I do if I need warranty service?

Before the warranty expires, please call us at the relevant number listed in the following table. Please also have your Dell service tag number or order number available.

Individual Home Consumers:	
Technical Support	1-800-624-9896
Customer Service	1-800-624-9897
Individual Home Consumers who purchased through an Employee Purchase Program:	
Technical Support and Customer Service	1-800-822-8965
Home and Small Business Commercial Customers:	
Technical Support and Customer Service	1-800-456-3355
Medium, Large, or Global Commercial Customers, Healthcare Customers, and Value Added Resellers (VARs):	
Technical Support and Customer Service	1-800-822-8965
Government and Education Customers:	
Technical Support and Customer Service	1-800-234-1490
Dell-Branded Memory	1-888-363-5150

What will Dell do?

During the first 90 days of the 90-day limited warranty and the first year of all other limited warranties: For the first 90 days of the 90-day limited warranty and the first year of all other limited warranties, we will repair any Dell-branded hardware products returned to us that prove to be defective in materials or workmanship. If we are not able to repair the product, we will replace it with a comparable product that is new or refurbished.

When you contact us, we will issue a Return Material Authorization Number for you to include with your return. You must return the products to us in their original or equivalent packaging, prepay shipping charges, and insure the shipment or accept the risk if the product is lost or damaged in shipment. We will return the repaired or replacement products to you. We will pay to ship the repaired or replaced products to you if you use an address in the United States (excluding Puerto Rico and U.S. possessions and territories). Otherwise, we will ship the product to you freight collect.

If we determine that the product is not covered under this warranty, we will notify you and inform you of service alternatives that are available to you on a fee basis.

NOTE: Before you ship the product(s) to us, make sure to back up the data on the hard drive(s) and any other storage device(s) in the product(s). Remove any confidential, proprietary, or personal information and removable media such as floppy disks, CDs, or PC Cards. We are not responsible for any of your confidential, proprietary, or personal information; lost or corrupted data; or damaged or lost removable media.

During the remaining years: For the remaining period of the limited warranty, we will replace any defective part with new or refurbished parts, if we agree that it needs to be replaced. When you contact us, we will require a valid credit card number at the time you request a replacement part, but we will not charge you for the replacement part as long as you return the original part to us within thirty days after we ship the replacement part to you. If we do not receive the original part within thirty days, we will charge to your credit card the then-current standard price for that part.

We will pay to ship the part to you if you use an address in the United States (excluding Puerto Rico and U.S. possessions and territories). Otherwise, we will ship the part freight collect. We will also include a prepaid shipping container with each replacement part for your use in returning the replaced part to us.

NOTE: Before you replace parts, make sure to back up the data on the hard drive(s) and any other storage device(s) in the product(s). We are not responsible for lost or corrupted data.

What if I purchased a service contract?

If your on-site service contract is with Dell, on-site service will be provided to you under the terms of the on-site service agreement. Please refer to that contract for details on how to obtain service.

If you purchased through us a service contract with one of our third-party service providers, please refer to that contract for details on how to obtain service.

How will you fix my product?

We use new and refurbished parts made by various manufacturers in performing warranty repairs and in building replacement parts and systems. Refurbished parts and systems are parts or systems that have been returned to Dell, some of which were never used by a customer. All parts and systems are inspected and tested for quality. Replacement parts and systems are covered for the remaining period of the limited warranty for the product you bought.

What do I do if I am not satisfied?

We pride ourselves on our great customer service. If you are not satisfied with the service you receive under this limited warranty, please let us know. We have found that the best way to resolve issues regarding our limited warranty is to work together. If, after those discussions, you are still not satisfied, we believe arbitration is the most expeditious way to resolve your concerns. Therefore, **ANY CLAIM, DISPUTE, OR CONTROVERSY (WHETHER IN CONTRACT, TORT, OR OTHERWISE, WHETHER PREEXISTING, PRESENT, OR FUTURE, AND INCLUDING STATUTORY, COMMON LAW, INTENTIONAL TORT, AND EQUITABLE CLAIMS) AGAINST DELL** arising from or relating to this limited warranty, its interpretation, or the breach, termination, or validity thereof, the relationships which result from this limited warranty (including, to the full extent permitted by applicable law, relationships with third parties), Dell's advertising, or any related purchase **SHALL BE RESOLVED EXCLUSIVELY AND FINALLY BY BINDING ARBITRATION ADMINISTERED BY THE NATIONAL ARBITRATION FORUM (NAF)** under its Code of Procedure then in effect (available via the Internet at www.arb-forum.com/ or via telephone at 1-800-474-2371). The arbitration will be limited solely to the dispute or controversy between you and Dell. Any award of the arbitrator(s) shall be final and binding on each of the parties, and may be entered as a judgment in any court of competent jurisdiction. Information may be obtained and claims may be filed with the NAF at P.O. Box 50191, Minneapolis, MN 55405. This provision applies only to individual home consumers and consumers who purchased through an employee purchase program. It does not apply to small, medium, large, and global commercial customers or government, education, and healthcare customers.

May I transfer the limited warranty?

Limited warranties on systems may be transferred if the current owner transfers ownership of the system and records the transfer with us. The limited warranty on Dell-branded memory may not be transferred. You may record your transfer by going to Dell's website:

- If you are an Individual Home Consumer, go to www.dell.com/us/en/dhs/topics/sbtopic_015_ccare.htm
- If you are a Small, Medium, Large, or Global Commercial Customer, go to www.dell.com/us/en/biz/topics/sbtopic_ccare_nav_015_ccare.htm
- If you are a Government, Education, or Healthcare Customer, or an Individual Consumer who purchased through an employee purchase program, go to www.dell.com/us/en/pub/topics/sbtopic_015_ccare.htm

If you do not have Internet access, please call your customer care representative or call 1-800-624-9897.

"Total Satisfaction" Return Policy (U.S. Only)

We value our relationship with you and want to make sure that you're satisfied with your purchases. That's why we offer a "Total Satisfaction" return policy for most products that you—the end-user customer—purchase directly from Dell. Under this policy, you may return to Dell products that you purchased directly from Dell for a credit or a refund of the purchase price paid, less shipping and handling and applicable restocking fees as follows:

- **New Hardware Products and Accessories** — All new hardware, accessories, parts, and unopened software still in its sealed package, excluding the products listed below, may be returned within thirty days from the invoice date. To return applications software or an operating system that has been installed by Dell, you must return the entire computer. A different return policy applies to nondefective products purchased through Dell's Software and Peripherals division by customers of our Small and Medium Business divisions. Those products may be returned within thirty days from the invoice date, but a fifteen percent (15%) restocking fee will be deducted from any refund or credit. The "Total Satisfaction" Return Policy and Software and Peripherals division return policy are not available for Dell | EMC storage products, EMC-branded products, or enterprise software.

- **Reconditioned or Refurbished Dell-Branded Hardware Products and Parts** — All reconditioned or refurbished Dell-branded server and storage products may be returned within thirty days from the invoice date. All other reconditioned or refurbished Dell-branded hardware products and parts may be returned within fourteen days of the invoice date.

To return products, e-mail or call Dell customer service to receive a Credit Return Authorization Number within the return policy period applicable to the product you want to return. You must obtain a Credit Return Authorization Number in order to return the product. See "Contacting Dell" on page 124 (or www.dell.com/us/en/gen/contact.htm) to find the appropriate contact information for obtaining customer assistance.

You must ship the products to Dell within five days of the date that Dell issues the Credit Return Authorization Number. You must also return the products to Dell in their original packaging, in as-new condition along with any media, documentation, and all other items that were included in the original shipment, prepay shipping charges, and insure the shipment or accept the risk of loss or damage during shipment.

Limited Warranty Terms for Canada

What is covered by this limited warranty?

This limited warranty covers defects in materials and workmanship in your-our end-user customer's--Dell-branded hardware products, including Dell-branded monitors, keyboards, and pointing devices (mice).

What is not covered by this limited warranty?

This limited warranty does not cover:

- Software, including the operating system and software added to the Dell-branded hardware products through our factory-integration system, or the reloading of the software
- Non-Dell branded products and accessories
- Problems that result from:
 - External causes such as accident, abuse, misuse, or problems with electrical power
 - Servicing not authorized by us
 - Usage that is not in accordance with product instructions
 - Failure to follow the product instructions or failure to perform preventive maintenance
 - Problems caused by using accessories, parts, or components not supplied by us
- Products with missing or altered service tags or serial numbers
- Products for which we have not received payment

THIS WARRANTY GIVES YOU SPECIFIC LEGAL RIGHTS, AND YOU MAY ALSO HAVE OTHER RIGHTS WHICH VARY FROM PROVINCE TO PROVINCE. DELL'S RESPONSIBILITY FOR MALFUNCTIONS AND DEFECTS IN PRODUCT IS LIMITED TO REPAIR AND REPLACEMENT AS SET FORTH IN THIS WARRANTY STATEMENT, FOR THE TERM OF THE WARRANTY PERIOD REFLECTED ON YOUR INVOICE. EXCEPT FOR THE EXPRESS WARRANTIES CONTAINED IN THIS WARRANTY STATEMENT, DELL DISCLAIMS ALL OTHER WARRANTIES AND CONDITIONS, EXPRESS OR IMPLIED, INCLUDING WITHOUT LIMITATION IMPLIED WARRANTIES AND CONDITIONS OF MERCHANTABILITY AND FITNESS FOR A PARTICULAR PURPOSE, STATUTORY OR OTHERWISE. SOME PROVINCES DO NOT ALLOW THE EXCLUSION OF CERTAIN IMPLIED WARRANTIES OR CONDITIONS, OR LIMITATIONS ON HOW LONG AN IMPLIED WARRANTY OR CONDITION LASTS. THEREFORE, THE FOREGOING EXCLUSIONS AND LIMITATIONS MAY NOT APPLY TO YOU.

WE DO NOT ACCEPT LIABILITY BEYOND THE REMEDIES PROVIDED FOR IN THIS WARRANTY STATEMENT OR FOR SPECIAL, INDIRECT, CONSEQUENTIAL, OR INCIDENTAL DAMAGES, INCLUDING, WITHOUT LIMITATION, ANY LIABILITY FOR THIRD PARTY CLAIMS AGAINST YOU FOR DAMAGES, FOR PRODUCTS NOT BEING AVAILABLE FOR USE, OR FOR LOST DATA OR LOST SOFTWARE. OUR LIABILITY WILL BE NO MORE THAN THE AMOUNT YOU PAID FOR THE PRODUCT THAT IS THE SUBJECT OF A CLAIM. THIS IS THE MAXIMUM AMOUNT FOR WHICH WE ARE RESPONSIBLE.

SOME PROVINCES DO NOT ALLOW THE EXCLUSION OR LIMITATION OF SPECIAL, INDIRECT, INCIDENTAL, OR CONSEQUENTIAL DAMAGES, SO THE ABOVE LIMITATION OR EXCLUSION MAY NOT APPLY TO YOU.

How long does this limited warranty last?

This limited warranty lasts for the time period indicated on your invoice, except that the limited warranty on Dell-branded batteries lasts only one year and the limited warranty on the lamps for Dell-branded projectors lasts only ninety days. The limited warranty begins on the date of the invoice. The warranty period is not extended if we repair or replace a warranted product or any parts. Dell may change the terms and availability of limited warranties, at its discretion, but any changes will not be retroactive (that is, the warranty terms in place at the time of purchase will apply to your purchase).

What do I do if I need warranty service?

Before the warranty expires, please call us at the relevant number listed in the following table. Please also have your Dell service tag number or order number available.

Individual Home Consumers; Home Office and Small Business Customers:	
Technical Support and Customer Service	1-800-847-4096
Medium, Large, and Global Commercial Customers; Government, Education, and Healthcare Customers; and Value Added Resellers (VARs):	
Technical Support	1-800-387-5757
Customer Service	1-800-326-9463
Government or Education Customers, or Individual Home Consumers who purchased through an Employee Purchase Program:	
Technical Support	1-800-387-5757
Customer Service	1-800-326-9463 (Extension 8221 for Individual Consumers)
Dell-Branded Memory	1-888-363-5150

What will Dell do?

During the first year of all limited warranties: During the first year of all limited warranties, we will repair any Dell-branded hardware products returned to us that prove to be defective in materials or workmanship. If we are not able to repair the product, we will replace it with a comparable product that is new or refurbished.

When you contact us, we will issue a Return Material Authorization Number for you to include with your return. You must return the products to us in their original or equivalent packaging, prepay shipping charges, and insure the shipment or accept the risk if the product is lost or damaged in shipment. We will return the repaired or replacement products to you. We will pay to ship the repaired or replaced products to you if you use an address in Canada. Otherwise, we will ship the product to you freight collect.

If we determine that the problem is not covered under this warranty, we will notify you and inform you of service alternatives that are available to you on a fee basis.

NOTE: Before you ship the product(s) to us, make sure to back up the data on the hard drive(s) and any other storage device(s) in the product(s). Remove any confidential, proprietary or personal information, removable media, such as floppy disks, CDs, or PC Cards. We are not responsible for any of your confidential, proprietary or personal information; lost or corrupted data; or damaged or lost removable media.

During the remaining years following the first year of all limited warranties: We will replace any defective part with new or refurbished parts, if we agree that it needs to be replaced. When you contact us, we will require a valid credit card number at the time you request a replacement part, but we will not charge you for the replacement part as long as you return the original part to us within thirty days after we ship the replacement part to you. If we do not receive the original part within thirty days, we will charge to your credit card the then-current standard price for that part.

We will pay to ship the part to you if you use an address in Canada. Otherwise, we will ship the part freight collect. We will also include a prepaid shipping container with each replacement part for your use in returning the replaced part to us.

NOTE: Before you replace parts, make sure to back up the data on the hard drive(s) and any other storage device(s) in the product(s). We are not responsible for lost or corrupted data.

What if I purchased an on-site service contract?

If your service contract is with Dell, service will be provided to you under the terms of the service contract. Please refer to that contract for details on how to obtain service. Dell's service contracts can be found online at www.dell.ca or by calling Customer Care at 1-800-847-4096. If you purchased through us a service contract with one of our third-party service providers, please refer to that contract (mailed to you with your invoice) for details on how to obtain service.

How will you fix my product?

We use new and refurbished parts made by various manufacturers in performing warranty repairs and in building replacement parts and systems. Refurbished parts and systems are parts or systems that have been returned to Dell, some of which were never used by a customer. All parts and systems are inspected and tested for quality. Replacement parts and systems are covered for the remaining period of the limited warranty for the product you bought. Dell owns all parts removed from repaired products.

What do I do if I am not satisfied?

We pride ourselves on our great customer service. If you are not satisfied with the service you receive under this limited warranty, please let us know. We have found that the best way to resolve issues regarding our limited warranty is to work together. If, after those discussions, you are still not satisfied, we believe arbitration is the most expeditious way to resolve your concerns. Therefore, **ANY CLAIM, DISPUTE, OR CONTROVERSY (WHETHER IN CONTRACT, TORT, OR OTHERWISE, WHETHER PREEXISTING, PRESENT OR FUTURE, AND INCLUDING STATUTORY, COMMON LAW, INTENTIONAL TORT, AND EQUITABLE CLAIMS) AGAINST DELL** arising from or relating to this limited warranty, its interpretation, or the breach, termination or validity thereof, the relationships which result from this limited warranty (including, to the full extent permitted by applicable law, relationships with third parties), Dell's advertising, or any related purchase **SHALL BE RESOLVED EXCLUSIVELY AND FINALLY BY BINDING ARBITRATION ADMINISTERED BY THE NATIONAL ARBITRATION FORUM (NAF)** under its Code of Procedure then in effect (available via the Internet at www.arb-forum.com/, or via telephone at 1-800-474-2371). The arbitration will be limited solely to the dispute or controversy between you and Dell. Any award of the arbitrator(s) shall be final and binding on each of the parties, and may be entered as a judgment in any court of competent jurisdiction. Information may be obtained and claims may be filed with the NAF at P.O. Box 50191, Minneapolis, MN 55405.

May I transfer the limited warranty?

Limited warranties on systems may be transferred if the current owner transfers ownership of the system and records the transfer with us. The limited warranty on Dell-branded memory may not be transferred. You may record your transfer by going to our website:

- If you are an Individual Home Consumer, go to www.dell.com/us/en/dhs/topics/sbtopic_016_ccare.htm
- If you are a Home Office, Small, Medium, Large, or Global Commercial Customer, go to www.dell.com/us/en/biz/topics/sbtopic_ccare_nav_016_ccare.htm
- If you are a Government, Education, or Healthcare Customer, or an Individual Home Consumer who purchased through an Employee Purchase Program, go to www.dell.com/us/en/pub/topics/sbtopic_016_ccare.htm

If you do not have Internet access, please call Dell at 1-800-326-9463.

"Total Satisfaction" Return Policy

If you are an end-user customer who bought new products directly from Dell, you may return them to Dell up to 30 days after you receive them for a refund or credit of the product purchase price. If you are an end-user customer who bought reconditioned or refurbished products from Dell, you may return them to Dell within 14 days after the date of invoice for a refund or credit of the product purchase price. In either case, the refund or credit will not include any shipping and handling charges shown on your invoice and will be subject to a fifteen percent (15%) restocking fee, unless otherwise prohibited by law. If you are an organization that bought the products under a written agreement with Dell, the agreement may contain different terms for the return of products than specified by this policy.

To return products, you must call Dell Customer Service at 1-800-387-5759 to receive a Credit Return Authorization Number. To expedite the process of your refund or credit, Dell expects you to return the products to Dell in their original packaging within five days of the date that Dell issues the Credit Return Authorization Number. You must also prepay shipping charges and insure the shipment or accept the risk of loss or damage during shipment. You may return software for a refund or credit only if the sealed package containing the floppy disk(s) or CD(s) is unopened. Returned products must be in as-new condition, and all of the manuals, floppy disk(s), CD(s), power cables, and other items included with a product must be returned with it. For customers who want to return, for refund or credit only, either application or operating system software that has been installed by Dell, the whole system must be returned, along with any media and documentation that may have been included in the original shipment.

The "Total Satisfaction" Return Policy does not apply to Dell | EMC storage products. It also does not apply to products purchased through Dell's Software and Peripherals division. For those products, please instead refer to Dell's Software and Peripheral's then-current return policy (see the following section, "Dell Software and Peripherals").

Dell Software and Peripherals

Third-Party Software and Peripherals Products

Similar to other resellers of software and peripherals, Dell does not warrant third-party products. Third-party software and peripheral products are covered by the warranties provided by the original manufacturer or publisher only. Third party manufacturer warranties vary from product to product. Consult your product documentation for specific warranty information. More information may also be available from the manufacturer or publisher.

While Dell offers a wide selection of software and peripheral products, we do not specifically test or guarantee that all of the products we offer work with any or all of the various models of Dell computers, nor do we test or guarantee all of the products we sell on the hundreds of different brands of computers available today. If you have questions about compatibility, we recommend and encourage you to contact the third-party software and peripheral product manufacturer or publisher directly.

Dell-Branded Peripheral Products

Dell does provide a limited warranty for new Dell-branded peripheral products (products for which Dell is listed as the manufacturer) such as monitors, batteries, memory, docking stations, and projectors). To determine which limited warranty applies to the product you purchased, see the Dell invoice and/or the product documentation that accompanied your product. Descriptions of Dell's limited warranties are described in preceding sections.

Return Policy

If you are an end-user customer who bought Dell Software and Peripherals products directly from a Dell company, you may return Dell Software and Peripherals products that are in as-new condition to Dell up to 30 days from the date of invoice for a refund of the product purchase price if already paid. This refund will not include any shipping and handling charges shown on your invoice; you are responsible for those.

To return products, you must call Dell Customer Service at 1-800-387-5759 to receive a Credit Return Authorization Number. You must ship the Dell Software and Peripherals products back to Dell in their original manufacturer's packaging (which must be in as-new condition), prepay shipping charges, and insure the shipment or accept the risk of loss or damage during shipment.

To qualify for refund or replacement, returned products must be in as-new condition, software products must be unopened, and all of the manuals, floppy disk(s), CD(s), power cables, and other items included with a product must be returned with it.

One-Year End-User Manufacturer Guarantee (Latin America and the Caribbean Only)

Guarantee

Dell Computer Corporation ("Dell") warrants to the end user in accordance with the following provisions that its branded hardware products, purchased by the end user from a Dell company or an authorized Dell distributor in Latin America or the Caribbean, will be free from defects in materials, workmanship, and design affecting normal use, for a period of one year from the original purchase date. Products for which proper claims are made will, at Dell's option, be repaired or replaced at Dell's expense. Dell owns all parts removed from repaired products. Dell uses new and reconditioned parts made by various manufacturers in performing repairs and building replacement products.

Exclusions

This Guarantee does not apply to defects resulting from: improper or inadequate installation, use, or maintenance; actions or modifications by unauthorized third parties or the end user; accidental or willful damage; or normal wear and tear.

Making a Claim

Claims must be made in Latin America or the Caribbean by contacting the Dell point of sale within the guarantee period. The end user must always supply proof of purchase, indicating name and address of the seller, date of purchase, model and serial number, name and address of the customer, and details of symptoms and configuration at the time of malfunction, including peripherals and software used. Otherwise, Dell may refuse the guarantee claim. Upon diagnosis of a warranted defect, Dell will make arrangements and pay for ground freight and insurance to and from Dell's repair/replacement center. The end user must ensure that the defective product is available for collection properly packed in original or equally protective packaging together with the details listed above and the return number provided to the end user by Dell.

Limitation and Statutory Rights

Dell makes no other warranty, guarantee or like statement other than as explicitly stated above, and this Guarantee is given in place of all other guarantees whatsoever, to the fullest extent permitted by law. In the absence of applicable legislation, this Guarantee will be the end user's sole and exclusive remedy against Dell or any of its affiliates, and neither Dell nor any of its affiliates shall be liable for loss of profit or contracts, or any other indirect or consequential loss arising from negligence, breach of contract, or howsoever.

This Guarantee does not impair or affect mandatory statutory rights of the end user against and/or any rights resulting from other contracts concluded by the end user with Dell and/or any other seller.

Dell World Trade LP

One Dell Way, Round Rock, TX 78682, USA

Dell Computadores do Brasil Ltda (CNPJ No. 72.381.189/0001-10)/

Dell Commercial do Brasil Ltda (CNPJ No. 03 405 822/0001-40)

Avenida Industrial Belgraf, 400

92990-000 - Eldorado do Sul – RS - Brasil

Dell Computer de Chile Ltda

Coyancura 2283, Piso 3- Of.302,

Providencia, Santiago - Chile

Dell Computer de Colombia Corporation
Carrera 7 #115-33 Oficina 603
Bogota, Colombia

Dell Computer de Mexico SA de CV
Paseo de la Reforma 2620 - 11° Piso
Col. Lomas Altas
11950 México, D.F.

Intel® Warranty Statement for Pentium® and Celeron® Processors Only (U.S. and Canada Only)

Intel's Three Year Limited Warranty

Limited Warranty

Intel warrants that its family of Pentium® and Celeron® processors, if properly used and installed, will be free from defects in materials and workmanship and will substantially conform to Intel's publicly available specifications for a period of three (3) years after the date the Pentium or Celeron processor was purchased (whether purchased separately or as part of a computer system).

If the Pentium or Celeron processor, which is the subject of this Limited Warranty, fails during the warranty period for reasons covered by this Limited Warranty, Intel, at its option, will:

- REPAIR the Pentium or Celeron processor by means of hardware and/or software; OR
 - REPLACE the Pentium or Celeron processor with another Pentium or Celeron processor; OR
- if Intel is unable to repair or replace the particular Pentium or Celeron processor,
- REFUND the then-current value of the Pentium or Celeron processor.

THIS LIMITED WARRANTY, AND ANY IMPLIED WARRANTIES THAT MAY EXIST UNDER STATE LAW, APPLY ONLY TO THE ORIGINAL PURCHASER OF THE PENTIUM OR CELERON PROCESSOR, OR PENTIUM OR CELERON PROCESSOR-BASED COMPUTER AND LAST ONLY FOR AS LONG AS SUCH PURCHASER CONTINUES TO OWN THE PROCESSOR.

Extent of Limited Warranty

Intel does not warrant that your Pentium or Celeron processor will be free from design defects or errors known as "errata". Current characterized errata are available upon request. This limited warranty is for purchasers in the United States and Canada only. The limited warranty does not cover any costs relating to removal or replacement of any Pentium or Celeron processors that are soldered or otherwise permanently affixed to your system's motherboard.

This limited warranty does not cover damages due to external causes, including accident, problems with electrical power, usage not in accordance with product instructions, misuse, neglect, alteration, repair, improper installation, or improper testing.

How to Obtain Warranty Service

To obtain warranty service for your Pentium or Celeron processor, you may contact your computer system manufacturer in accordance with its instructions, or you may contact Intel.

To request warranty service from Intel, you should call Intel at 1-800-628-8686 during the warranty period during normal business hours (Pacific Time), excluding holidays. Please be prepared to provide:

- (1) your name, address, and telephone numbers;
- (2) proof of purchase;
- (3) this Intel warranty card;
- (4) a description of the computer system including the brand and model; and
- (5) an explanation of the problem.

[Note: The Customer Service Representative may need additional information from you depending on the nature of the problem.]

The replacement processor is warranted under this written warranty and is subject to the same limitations and exclusions for the remainder of the original warranty period or one (1) year, whichever is longer.

WARRANTY LIMITATIONS AND EXCLUSIONS

THESE WARRANTIES REPLACE ALL OTHER WARRANTIES, EXPRESS OR IMPLIED INCLUDING, BUT NOT LIMITED TO, THE IMPLIED WARRANTIES OF MERCHANTABILITY AND FITNESS FOR A PARTICULAR PURPOSE. INTEL MAKES NO EXPRESS WARRANTIES BEYOND THOSE STATED HERE. INTEL DISCLAIMS ALL OTHER WARRANTIES, EXPRESS OR IMPLIED, INCLUDING, WITHOUT LIMITATION, IMPLIED WARRANTIES OF MERCHANTABILITY AND FITNESS FOR A PARTICULAR PURPOSE.

SOME LAWS DO NOT ALLOW THE EXCLUSION OF IMPLIED WARRANTIES SO THIS LIMITATION MAY NOT APPLY TO YOU. IF THESE LAWS APPLY, THEN ALL EXPRESS AND IMPLIED WARRANTIES ARE LIMITED IN DURATION TO THE LIMITED WARRANTY PERIOD. NO WARRANTIES APPLY AFTER THAT PERIOD. SOME LAWS DO NOT ALLOW LIMITATIONS ON HOW LONG AN IMPLIED WARRANTY LASTS, SO THIS LIMITATION MAY NOT APPLY TO YOU.

LIMITATIONS OF LIABILITY

INTEL'S RESPONSIBILITY UNDER THIS, OR ANY OTHER WARRANTY, IMPLIED OR EXPRESS, IS LIMITED TO REPAIR, REPLACEMENT OR REFUND, AS SET FORTH ABOVE. THESE REMEDIES ARE THE SOLE AND EXCLUSIVE REMEDIES FOR ANY BREACH OF WARRANTY. INTEL IS NOT RESPONSIBLE FOR INDIRECT, SPECIAL, INCIDENTAL, OR CONSEQUENTIAL DAMAGES RESULTING FROM ANY BREACH OF WARRANTY OR UNDER ANY OTHER LEGAL THEORY INCLUDING, BUT NOT LIMITED TO, LOST PROFITS, DOWNTIME, GOODWILL, DAMAGE TO OR REPLACEMENT OF EQUIPMENT AND PROPERTY, AND ANY COSTS OF RECOVERING, REPROGRAMMING, OR REPRODUCING ANY PROGRAM OR DATA STORED IN OR USED WITH A SYSTEM CONTAINING YOUR PENTIUM PROCESSOR. SOME JURISDICTIONS DO NOT ALLOW THE EXCLUSION OR LIMITATION OF INCIDENTAL OR CONSEQUENTIAL DAMAGES, SO THE ABOVE LIMITATIONS OR EXCLUSIONS MAY NOT APPLY TO YOU.

THIS LIMITED WARRANTY GIVES YOU SPECIFIC LEGAL RIGHTS, AND YOU MAY ALSO HAVE OTHER RIGHTS THAT VARY FROM JURISDICTION TO JURISDICTION.

**Intel Pentium® and Celeron® Processors are backed by a three-year limited warranty.
Please refer to the reverse side of this card for complete warranty details.**

Intel's Commitment to Quality

Intel is committed to producing the highest quality processors available. That's why we have hundreds of people dedicated to continuously improve our design, manufacturing, and testing technology.

We put every one of our Pentium® and Celeron® processors through a rigorous battery of tests during the design and manufacturing processes.

To verify that the new chip will correctly run the software written for Intel Architecture processors, a team of Intel engineers is dedicated to compatibility testing. In a state-of-art lab, this group runs an extensive set of operating systems, applications, network tests and stress tests repeatedly to ensure that the processor is compatible with representative software.

Just as importantly, we work with hardware and software companies in the computer industry to ensure that our processors are compatible with their products.

Additionally, a sampling of Intel processors are subjected to a rigorous "burn-in" test whereby the chip is operated at higher-than-normal temperatures and voltages. During this burn-in period, the processor experiences the equivalent of weeks of normal usage. These units are monitored for failures as part of our ongoing quality assurance process.

As a result, today's microprocessors from Intel are among the most reliable components in computers.

What are 'Errata'?

Exhaustive product testing can highlight differences between the actual behavior of the microprocessor and its specifications. Sometimes the discrepancies are caused by a design defect or error, which we call *errata*. Rigorous validation identifies most errata during the development of the processor, but we do detect additional errata during the life cycle of a microprocessor.

When an erratum is identified, our engineers work to characterize it and find a solution. We work with system designers and software developers to ensure that the discrepancy does not affect their products. If necessary, special software or hardware solutions (sometimes known as "work arounds") are implemented in the system design to prevent computer users from encountering the problem. Errata may then be corrected in future revisions of the microprocessor.

No microprocessor is perfect, and Intel recognizes that some consumers want to know about any errata, whether or not the errata affect them. Intel makes documentation of all characterized Pentium and Celeron processor errata publicly available through our Technical Documentation Service.

At Intel, our goal is to make every computer user satisfied with his or her Pentium or Celeron processor. Should you have any questions, comments or concerns about your Intel microprocessor, please call us at 1-800-628-8686.

©1997, 1998 Intel Corporation. All rights reserved.

Index

B

battery, 72
BIOS, 119

C

CD-RW drive
 blank discs, 40
 copying CDs, 39
 Easy CD Creator Basic, 40
 fixing problems, 86
characters
 unexpected, 82
computer
 crashes, 89
 error messages, 74
 specifications, 112
 turning off, 42
conflicts
 resolving software and
 hardware
 incompatibilities, 95
contact numbers, 124
crashes, 89

D

damaged computer
 testing, 91
Dell support policy, 121
docking device, 65
Dolby headphone
 setting up, 64
drivers
 about, 92
 device driver rollback, 93
 reinstalling, 93
drives
 fixing problems, 83
 replacing, 108

E

e-mail
 fixing problems, 90
error messages
 start-up, 74

F

finding solutions, 70
floppy drive
 fixing problems, 83

H

hard drive
 preventing damage, 109
 replacing, 108
 returning to Dell, 110
help file
 accessing, 72

I

infrared sensor
 enabling, 51
Internet connection
 about, 37
 fixing problems, 79
 options, 37
 setting up, 38
IRQ conflicts, 95

K

Keyboard
 shortcuts, 47
keyboard
 fixing problems, 82
 unexpected characters, 82
Keypad
 numeric, 46

M

memory
adding, 105
removing, 106

messages
start-up, 74

N

network
fixing problems, 87
setting up the docking
device, 65

P

palm rest, 104
PC Cards
fixing problems, 86
power
fixing problems, 72
protection devices, 65
turning off, 42
printer
cable, 34
connecting, 34
parallel, 34
setting up, 34
USB, 35

programs
crashes, 89
fixing problems, 89
not responding, 89

R

RAM. *See* memory
reinstalling
drivers, 93
ResourceCD, 93

S

safety instructions, 9
health considerations, 16
settings
system setup program, 119
shutdown, 42
software
fixing problems, 89
reinstalling software, 93
specifications, 112
System Restore, 96
system setup program, 119

T

Tell Me How help file
accessing, 72
Touch pad, 49

Touch pad and track stick
customizing, 50

troubleshooting
about, 70
blue screen, 89
cannot save to floppy disk, 83
CD-RW drive stops
writing, 86
drive problems, 83
dropped or damaged
computer, 91
e-mail problems, 90
error messages, 87
external keyboard
problems, 82
hardware and software
incompatibilities, 95
modem and Internet
connection problems, 79
network problems, 87
PC Card problems, 86
power problems, 72
printer problems, 78
program crash, 89
program stopped
responding, 89
scanner problems, 80
sound and speaker
problems, 77
start-up error messages, 74
touch pad or mouse
problems, 81
unexpected characters, 82
video and display problems, 75
wet computer, 90
turning off the computer, 42

TV

connecting, 52

W

warranty, 145

wet computer, 90

Windows XP

- device driver rollback, 93

- help, 72

- reinstalling, 99

DELL INFORMATION DEVELOPMENT

Postscript Imaging and Printing Specifications

	ENGLISH (Completed by Information Development)	LOCALIZATION (Heavily outlined boxes completed by Agency)
MILESTONE NAME:	Comaneci Owner's Manual	
PATH:	(S:\SYSTEMS\Comaneci\Owner\A03\English)	
LANGUAGES:	English	
-----		Agency:
PART and REVISION NUMBER:	1H018 A03	
SPEC SHEET PREPARED BY:	Gloria Salinas	
DATE SPEC SHEET COMPLETED:	08/28/02	
CONTACTS:	Cathy Brown Cathy_Brown@Dell.com 512-723-9330	Karen Johnson Karen_Johnson@Dell.com 512-728-0218
AMF PRINT VENDOR AND/OR REGIONS:	IPC, EMF, APCC, and CCC	Same as English
COMPUTER SOURCE:	<input checked="" type="checkbox"/> Dell PC Other _____	<input type="checkbox"/> Dell PC Other _____
APPLICATION SFTWR FOR BOOK:	<input checked="" type="checkbox"/> Frame ___ Word ___ Quark Other _____	<input type="checkbox"/> Frame ___ Word ___ Quark Other _____
APPLICATION SFTWR FOR COVER:	___ Frame ___ Word <input checked="" type="checkbox"/> Quark Other _____	<input type="checkbox"/> Frame ___ Word ___ Quark Other _____
FILE TYPE:	<input checked="" type="checkbox"/> Postscript Other _____	<input type="checkbox"/> Postscript Other _____
.PS DRIVER USED:	<input checked="" type="checkbox"/> Scitex Dolev400 PSM L2	<input type="checkbox"/> Scitex Dolev400 PSM L2
COLORS/ SEPARATIONS:	Book COVER: <input checked="" type="checkbox"/> CMYK ___ Gray Scale Book INTERIOR: <input checked="" type="checkbox"/> Print all as Gray Scale (Graphics Included) OTHER: ___ CMYK ___ Gray Scale Pantone #s _____	*Book COVER: ___ CMYK ___ Gray Scale Book INTERIOR: Print all as Gray Scale (Graphics Included) OTHER: ___ CMYK ___ Gray Scale Pantone #s _____
FOR PROOF ONLY PDF:	___ YES <input checked="" type="checkbox"/> NO	___ YES ___ NO
COMPRESSED & TESTED:	<input checked="" type="checkbox"/> YES	<input type="checkbox"/> YES
PAGE SIZE:	7.5 x 9	Same as English
PAGE SIZE FOLDED:	N/A	Same as English
PAPER STOCK:	<input checked="" type="checkbox"/> Dell Standard Other _____	Same as English
LINE SCREEN:	133 lpi	Same as English
FILE TRANSFER METHOD/MEDIA:	<input checked="" type="checkbox"/> FTP ___ Email ___ Disk ___ AGILE Other _____	<input type="checkbox"/> FTP ___ Email ___ Disk ___ AGILE Other _____

Owner: Mike Whaley
Last Revised: 04/19/02

* Refer to deliverables matrix in supplier tool kit

Dell Confidential

Continued on Back Page >

FILE NAME(S) & PAGE COUNT:	Section	Filename	Page Count	Page Numbers
* Localization Supplier: Revise file name, page count, and page number columns	Full Cover (AMF): Or	1H018am3.ps	2	(Inside Blank)
	Full Cover (EMF): Or	1H018em3.ps		
	Full Cover (APCC): Or	1H018ap3.ps		
	Full Cover (CCC):	1H018cc3.ps		
	Title Page:	1H018tp3.ps	2	Includes Copyright
	TOC:	1H018tc3.ps	6	3 – 8
	Safety:	1H018si3.ps	10	9 – 18
	Section 1:	1H018c13.ps	50	19 – 68
	Section 2:	1H018c23.ps	34	69 – 102
	Section 3:	1H018c33.ps	8	103 – 110
	Section 4:	1H018c43.ps	34	111 – 144
	Warranty:	1H018wr3.ps	12	145 – 156
	Index:	1H018ix3.ps	4	157 – 160
	TOTAL PAGE COUNT:			162

SPECIAL INSTRUCTIONS:	Add blank pages needed to complete signatures: Any document 3 pages or more, please add blank pages at the end of book to equal multiples of 4, 8, 16, or 32. Each new language begins on an odd numbered page and ends on an even numbered page. If this document contains Hebrew; add blank pages at the end of the Hebrew document (This would resemble the beginning of the document sections for all other languages) Keep in mind that Hebrew documents are read from RIGHT to LEFT. Any blank pages will follow the last page of the Hebrew document.
TRANSLATION INSTRUCTIONS:	Please refer to the Supplier Tool Kit. This document requires front and back Multilanguage covers. Please use the most current template to create these covers.