



# Dell™ Inspiron™ 8100

[A Tour of Your Computer](#)  
[Power Conservation](#)  
[Solving Problems](#)  
[System Specifications](#)  
[Reinstalling Software](#)  
[System Setup Program](#)  
[Ports and Connector Pin-Outs](#)  
[Removing and Replacing Parts](#)

---

## Hints, Notices, and Cautions

-  **HINT:** A HINT indicates important information that helps you make better use of your computer.
  -  **NOTICE:** A NOTICE indicates either potential damage to hardware or loss of data and tells you how to avoid the problem.
  -  **CAUTION:** A CAUTION indicates a potential for property damage, personal injury, or death.
- 

## Abbreviations and Acronyms

For a complete list of abbreviations and acronyms, see the *Tell Me How* help file (click the **Start** button on the Microsoft® Windows® desktop, point to **Programs**—> **User's Guides**, and click **Tell Me How**).

---

Information in this document is subject to change without notice.  
© 2001 Dell Computer Corporation. All rights reserved.

Reproduction in any manner whatsoever without the written permission of Dell Computer Corporation is strictly forbidden.

Trademarks used in this text: *Dell*, *Dell TravelLite*, *Inspiron*, *AccessDirect*, and *TrueMobile* are trademarks of Dell Computer Corporation; *Intel* and *Pentium* are registered trademarks; *GeForce2 Go* is a trademark of NVIDIA Corporation; *Microsoft* and *Windows* are registered trademarks of Microsoft Corporation.

Other trademarks and trade names may be used in this document to refer to either the entities claiming the marks and names or their products. Dell Computer Corporation disclaims any proprietary interest in trademarks and trade names other than its own.

This product incorporates copyright protection technology that is protected by method claims of certain U.S. patents and other intellectual property rights owned by Macrovision Corporation and other rights owners. Use of this copyright protection technology must be authorized by Macrovision Corporation, and is intended for home and other limited viewing uses only unless otherwise authorized by Macrovision Corporation. Reverse engineering or disassembly is prohibited.

August 2001

[Back to Contents Page](#)

## Reinstalling Software

Dell™ Inspiron™ 8100

- [Overview](#)
  - [Reinstalling Drivers and Utilities](#)
  - [Reinstalling Microsoft® Windows® Millennium Edition \(Me\)](#)
  - [Reinstalling Windows 2000](#)
- 

### Overview

Dell provides software utilities and drivers that help you control certain features of your computer. The utilities and drivers for Dell-installed devices are installed and operative when you receive the computer. If you ever need to reinstall any of these drivers, you can use the Dell™ *Drivers and Utilities* CD that came with your computer.

Often, device problems can be corrected by reinstalling the appropriate drivers. Also, hardware manufacturers frequently provide updated drivers that support feature enhancements or that correct problems. Obtain updated drivers for products purchased from Dell at the Dell support website, <http://support.dell.com>.

- ➡ **NOTICE:** Drivers available on the Dell support website have been validated for correct operation on Dell computers. Installing drivers obtained from other sources may cause errors or performance degradation.

To reinstall drivers and utilities, you need the following items:

- 1 Dell *Drivers and Utilities* CD
- 1 CD drive or DVD drive installed in the media bay

- 📄 **HINT:** Your *Drivers and Utilities* CD contains drivers for operating systems that may not be on your computer. Verify that the driver you are loading is under your operating system subdirectory.

Dell recommends that you print these procedures before you begin.

- 📄 **HINT:** For more information on using the operating system installed on your computer by Dell, see the operating system documentation that came with your computer. You can also access system tools and documentation from <http://support.dell.com> by entering your service tag or Express Service Code and then clicking **Go!**

To reinstall the drivers and utilities correctly, you must reinstall them in the order presented in this document.

- ➡ **NOTICE:** Make sure that the computer is undocked before you reinstall drivers.
- 

### Reinstalling Drivers and Utilities

1. Save and close any open files, and exit any open programs.
2. Insert the *Drivers and Utilities* CD into the CD or DVD drive.
3. If the CD does not start running automatically, start Microsoft Windows Explorer, click your drive directory to display the CD contents, and then double-click the **start.htm** file.
4. Click a language button to select your preferred user interface language.

The **System Software** screen appears, displaying a list of operating systems (**Software by Operating System**) and an **All Software** category.

5. Under **Software by Operating System**, click your operating system to display a list of drivers, a **Utilities** subdirectory, and a **Documentation** subdirectory.
6. Click the type of driver (for example, **Audio**) or the utility you want to reinstall.

A link appears for the specific driver or utility used by your computer.

7. Click the link to display the **Languages** screen.
8. Click your preferred language for the driver or utility (if available) or click **Multiple**.
9. Click the **Install** button (if present) to start the automatic reinstallation. At the dialog box, click **Run this program from its current location** and then follow the screen prompts to complete the reinstallation.

If the **Install** button does not exist, see "[Reinstalling the Internal Modem and Network Adapter Drivers](#)."

### Reinstalling the Internal Modem and Network Adapter Drivers

If you have an internal modem, you need to reinstall the modem driver. If you have the combination modem/network adapter, you need to reinstall *both* the modem and network adapter drivers.

To reinstall a modem or network adapter driver, use the appropriate following procedure, depending on your operating system.

## Reinstalling the Modem or Network Adapter Driver for Windows Me

1. Save and close any open files, and exit any open programs.
2. Insert the *Drivers and Utilities CD* into the CD or DVD drive.
3. Click the **Start** button, point to **Settings**, and click **Control Panel**.

 **HINT:** To see the **System** icon, you may need to click the **View all control panel options** link at the left side of the screen.

4. In the **Control Panel** window, double-click the **System** icon.
5. In the **System Properties** window, click the **Device Manager** tab, and look beneath **Other Devices**.

If you are reinstalling a modem, click **PCI Communication Device**.

If you are reinstalling a network adapter, click **PCI Ethernet Controller**.

6. Click the **Properties** button.
7. Click the **Reinstall Driver** button.
8. Verify that **Automatic search for a better driver (Recommended)** is selected, and click **Next**.

If you are reinstalling a network adapter, click **Finish**, and then click **Yes** to restart the computer. Repeat steps 1–8 if you need to reinstall both drivers.

If you are reinstalling a modem, perform the following steps:

- a. In the **Select Other Driver** window, look under the **Location** column for a path containing **WINME**.
- b. Under **Device Description**, click the name corresponding to the **WINME** line, and click **OK** to confirm.
- c. Click **Finish**, and then click **Yes** to restart the computer.
- d. Repeat steps 1–8 if you need to reinstall both drivers.

## Reinstalling the Modem or Network Adapter Driver for Windows 2000

1. Save and close any open files, and exit any open programs.
2. Insert the *Drivers and Utilities CD* into the CD or DVD drive.
3. Click the **Start** button, point to **Settings**, and double-click **Control Panel**.
4. In the **Control Panel** window, double-click the **System** icon.
5. In the **System Properties** window, click the **Hardware** tab.
6. Click the **Device Manager...** button, and look beneath **Other Devices**.

If you are reinstalling a modem driver, click **PCI Simple Communications Controller**.

If you are reinstalling a network adapter, click **Ethernet Controller**.

7. From the pull-down menu, click **Action**, and select **Properties**.
8. Click the **Reinstall Driver** button, and click **Next**.
9. Verify that **Search for a suitable driver for my device (Recommended)** is selected, and click **Next**.
10. Verify that **CD-ROM drives** is selected, and click **Next**.
11. When the search is complete and the appropriate driver found, click **Next**.
12. Click **Finish** to complete reinstallation of the driver.
13. Repeat steps 3–12 if you need to reinstall both drivers.

---

## Reinstalling Microsoft® Windows® Millennium Edition (Me)

 **NOTICE:** The *Operating System CD* provides options for reinstalling your Windows Me operating system. The options can potentially overwrite files installed by Dell and possibly affect programs installed on your hard drive. Therefore, Dell does not recommend that you reinstall your operating system unless instructed to do so by a Dell technical support representative.

 **NOTICE:** To prevent conflicts with Windows Me, you must disable any virus protection software installed on your computer before you reinstall Windows.

1. Turn on the computer, and enter the system setup program as directed by a Dell technical support representative.
2. In the system setup program **Boot** menu, change the boot sequence so that the CD or DVD drive boots first as directed by a Dell technical support representative. Then place the *Operating System CD* in the drive and close the drive tray.
3. Exit the system setup program.
4. At the **Welcome** window, click **OK**.
5. Double-click **Refresh Windows OS**.

6. Click **OK**.
7. Click **OK** again.
8. Remove the *Operating System* CD from the drive, and click **OK** to restart your computer.

The **Getting ready to run Windows for the first time** window appears.

9. If the mouse tutorial starts, press <Esc> to exit and then press <y>.
10. Click the regional setting closest to where you live, and then click **Next**.
11. Click the graphic that matches your keyboard layout, and then click **Next**.
12. In the **User Information** window, type your name and, if applicable, company name, and then click **Next**.

The **Name** field must be completed; the **Company Name** field is optional.

The **License Agreement** window appears.

13. Click **I accept the Agreement**, and then click **Next**.
14. Type the Windows Product Key in the fields provided, and then click **Next**.

The Product Key is the bar code number found on the Microsoft Windows label, which is located on the computer.

15. When the **Start Wizard** window appears, click **Finish**.

The **Enter Windows Password** window appears. To continue without creating a Windows user name and password, click **OK**. Otherwise, type your user name and password in the appropriate fields, and then click **OK**.

16. If the **Date/Time Properties** window appears, adjust the date and time properties, click **Apply**, and then click **OK**.

Windows updates the system settings and restarts your computer.

17. If you created a Windows user name and password, type your password and click **OK**.
18. Reinstall the appropriate drivers (see "[Reinstalling Drivers and Utilities](#)").
19. Reenable your virus protection software.

## Enabling Hibernate Support

1. Click the **Start** button, point to **Settings**, and click **Control Panel**.
2. Double-click the **Power Options** icon.
3. Click the **Hibernate** tab.
4. Ensure that **Enable hibernate support** is selected, and click **Apply**.
5. Click **OK** to close the **Control Panel**.

---

## Reinstalling Windows 2000

1. Insert the *Operating System* CD into the CD or DVD drive.
2. Shut down the computer.
3. Turn on the computer.
4. Press any key when the *Press any key to boot from CD* message appears on the screen.
5. When the **Windows 2000 Setup** window appears, ensure that the **To setup Win2000 now, press ENTER** option is highlighted. Then press <Enter>.
6. Read the information in the **License Agreement** window, and then press <F8> to continue.
7. When the **Windows 2000 Professional Setup** window appears, press the arrow keys to select the Windows 2000 partition option that you want. To continue, press the key specified in the partition option that you chose.
8. When the **Windows 2000 Professional Setup** window reappears, press the arrow keys to select the type of filing system that you want Windows 2000 to use, and then press <Enter>.
9. Press <Enter> again to restart your computer.
10. Click **Next** when the **Welcome to the Windows 2000 Setup Wizard** window appears.
11. When the **Regional Settings** window appears, select the settings for your locale, and then click **Next**.
12. Enter your name and organization in the **Personalize Your Software** window, and then click **Next**.
13. When prompted, enter the Windows Product Key, which is printed on the Microsoft label on your computer. Then click **Next**.
14. When the **Computer Name and Administrator Password** window appears, enter a name for your computer and a password, if desired. Then click **Next**.
15. Enter the date and time in the **Date and Time Settings** window, and then click **Next**.

Windows 2000 begins to install its components and configure the computer.

16. When the **Completing the Windows 2000 Setup Wizard** window appears, remove the CD from the drive, and then click **Finish**. The computer automatically restarts.

 **NOTICE:** Make sure that you reinstall the Intel® Chip Set Update Utility driver before you reinstall any other drivers.

## Enabling Hibernate Support

1. Click the **Start** button, point to **Settings**, and click **Control Panel**.
  2. Double-click the **Power Options** icon.
  3. Click the **Hibernate** tab.
  4. Ensure that **Enable hibernate support** is selected, and click **Apply**.
  5. Click **OK** to close the **Control Panel**.
- 

[Back to Contents Page](#)

[Back to Contents Page](#)

## Ports and Connector Pin-Outs

### Dell™ Inspiron™ 8100

- [Serial Connector](#)
  - [Parallel Connector](#)
  - [PS/2 Connector](#)
  - [USB Connectors](#)
  - [S-Video TV-Out Connector](#)
  - [Video Connector](#)
  - [Docking Connector](#)
  - [IEEE-1394 Connector](#)
- 

### Serial Connector



Pin	Signal
1	DCD
2	RXDA
3	TXDA
4	DTR
5	GND
6	DSR
7	RTS
8	CTS
9	RI
Shell	N/A

---

### Parallel Connector

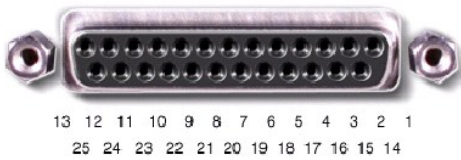

Pin	Signal	Pin	Signal
1	STB#/5V	11	BUSY/MTR#
2	PDO/INDEX#	12	PE/WDATA#
3	PD1/TRK0#	13	SLCT/WGATE#
4	PD2/WP#	14	AFDF#
5	PD3/RDATA#	15	ERROR#HSEL#

6	PD4/DSKCHG#	16	INIT#/DIR#
7	PD5F	17	SLCT_IN#STEP#
8	PD6F	18-23	GND
9	PD7F	24	NC
10	ACK#/DRV#	25	GND

## PS/2 Connector

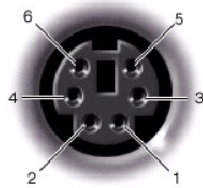

Pin	Signal
1	DAT_KBD
2	DAT_SM1
3	GND
4	PS2VCC
5	CLK_KBD
6	CLK_SM1
Shell	N/A

## USB Connectors

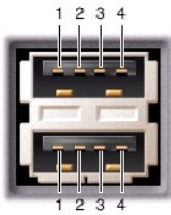

Pin	Signal
1	VCC
2	-Data
3	+Data
4	Ground

## S-Video TV-Out Connector

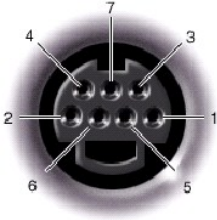

Pin	Signal
1	GND
2	GND
3	DLUMA-L
4	DCRMA-L
5	SPDIF
6	DCMPS-L
7	SPGND

## Video Connector



Pin	Signal
1	RED
2	GREEN
3	BLUE
4	NC
5	GND
6	GND
7	GND
8	GND
9	CRTVCC
10	GND
11	M-SEN#
12	DAT_DDC2
13	HSYNC
14	VSYNC
15	CLK_DDC2
Shell	N/A

## Docking Connector



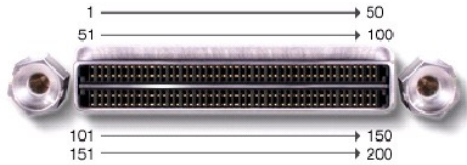

Pin	Signal	Pin	Signal	Pin	Signal	Pin	Signal
1	STRB#/5V	51	HSYNC	101	VGA_GRN	151	GND
2	PD0	52	VSYNC	102	GND	152	CLK_SPCI
3	PD1	53	GND	103	VGA_RED	153	GND
4	PD2	54	DOCKED	104	GND	154	SAD0
5	PD3	55	USB_VD1+	105	VGA_BLU	155	SAD1
6	PD4	56	USB_VD1-	106	DOCK_SD/MODE	156	SAD2
7	PD5	57	GND	107	D_IRTX	157	SAD3
8	PD6	58	USB_VD2+	108	D_IRRX	158	SAD4
9	PD7	59	USB_VD2-	109	GND	159	SAD5
10	GND	60	DOCKOC1#	110	SPIROB#	160	SAD6
11	DOCK_SPKR	61	RUN_ON#	111	SPIROC#	161	GND
12	DOCK_MIC	62	GND	112	DAT_DDC2	162	SAD7
13	DOCK_LINE	63	NC	113	CLK_DDC2	163	SAD8
14	DOCK_CDROM	64	DOCK_SCLK	114	SPAR	164	SC/BE0#
15	GND	65	DOCK_LRCK	115	SPME#	165	SAD9
16	M_SEN#	66	DOCK_MCLK	116	GND	166	SAD10
17	POWER_SW#	67	GND	117	SSERR#	167	SAD11
18	OPCIEN#	68	+12V	118	SPERR#	168	SAD12
19	S1.6M_EN#	69	AFD#	119	SLOCK#	169	GND
20	DFDD/LPT#	70	ERROR#	120	SSTOP#	170	SAD13
21	GND	71	ACK#	121	GND	171	SAD14
22	NC	72	GND	122	SDEVSEL#	172	SAD15
23	NC	73	INIT#	123	STRDY#	173	SAD16
24	D_ATCTLED	74	SLCT_IN#	124	SIRDY#	174	SC/BE1#
25	D_PWRLLED	75	BUSY	125	SFRAME#	175	CD/BE2#
26	DOCK_PWR_SRC	76	PE	126	SCLKRUN#	176	GND
27	DOCK_PWR_SRC	77	SLCT	127	GND	177	SAD17
28	DOCK_PWR_SRC	78	GND	128	SGNTA#	178	SAD18
29	GND	79	DAT_SMB	129	SREQA#	179	SAD19
30	+5VDOCK	80	DCLK_SMB	130	SGNT0#	180	SAD20
31	+5VDOCK	81	SMB_INIT#	131	SREQ0#	181	SAD21
32	+5VDOCK	82	GND	132	SPCIRST#	182	GND
33	+5VDOCK	83	DAT_DOCKSM1	133	SH1SEL#	183	SAD22
34	+5VDOCK	84	CLK_DOCKSM1	134	GND	184	SAD23
35	GND	85	DAT_DOCKKBD	135	SWRPRT#	185	SAD24
36	DOCK_PWR_SRC	86	CLK_DOCKKBD	136	SDSKCHG#/DRQ	186	SC/BE3#
37	DOCK_PWR_SRC	87	GND	137	SDIR#	187	SAD25
38	DOCK_PWR_SRC	88	RIO	138	STRKO#	188	GND
39	DOCK_PWR_SRC	89	CTS0	139	SSTEP#	189	SAD26
40	GND	90	RTS0	140	SDRV1#	190	SAD27
41	DOCK_+DC_IN	91	DSR0	141	GND	191	SAD28
42	DOCK_+DC_IN	92	GND	142	SMRT1#	192	SAD29
43	DOCK_+DC_IN	93	DTR0	143	SWRDATA#	193	SAD30
44	DOCK_+DC_IN	94	TXDO#	144	SWGATE#	194	SAD31
45	DOCK_+DC_IN	95	RXDO#	145	SRDATA#	195	GND
46	DOCK_+DC_IN	96	DCD0	146	SINDEX#	196	NC
47	DOCK_+DC_IN	97	NC	147	GND	197	NC
48	DOCK_+DC_IN	98	+5VSUS	148	NC	198	NC
49	GND	99	NC	149	+5VALW	199	NC

50	LOW_PWR	100	NC	150	NC	200	GND
----	---------	-----	----	-----	----	-----	-----

---

## IEEE-1394 Connector



Pin	Signal
1	TPB-
2	TPB+
3	TPA-
4	TPA+

---

[Back to Contents Page](#)

[Back to Contents Page](#)

## Power Conservation

Dell™ Inspiron™ 8100

- [Conservation Tips](#)
  - [Power Conservation Modes](#)
  - [Power Options Properties](#)
- 

### Conservation Tips

- 1 You automatically conserve battery power each time you attach your computer to an electrical outlet. When the AC adapter is attached, the battery is charged while the computer uses AC power. Your battery's life expectancy is largely determined by the number of times it is charged, so use an AC power source to run the computer if one is available.
  - 1 When the computer is using battery power, remove the PC Cards that you are not using.
  - 1 When possible, attach your computer to an electrical outlet when you play CDs and DVDs. Playing a CD or DVD uses a lot of battery power.
  - 1 Place the computer in standby mode or hibernate mode when you leave the computer unattended for long periods of time.
- 

### Power Conservation Modes

#### Standby Mode

Standby mode conserves power by turning off the display and the hard drive after a predetermined period of inactivity (a time-out.) When you exit standby mode, the desktop is restored to the same state that it was in before the computer entered standby mode.

To activate standby mode:

- 1 Click the **Start** button, click **Shut down**, click **Stand by**, and then click **OK**.

or

- 1 Press the power button or the power conservation key combination, <Fn><Suspend>, that you programmed (via the **Advanced** tab).

 **HINT:** You can use the **Advanced** tab to program the display-close option, the power button, and the power conservation key combination to activate standby mode.

To exit standby mode, press the power button, or if you activated standby mode by closing the display, open (raise) the display.

#### Hibernate Mode

Hibernate mode conserves power by copying system data to a reserved area on the hard drive and then completely turning off the computer. When you exit hibernate mode, the application programs and files that were open before you activated hibernate mode are still open.

Your computer enters hibernate mode if the battery charge level becomes critically low, or if either the power button, the power conservation key combination, <Fn><Suspend>, or the display-close option are programmed to activate hibernate mode in the **Advanced** tab of the **Power Options Properties** window.

 **HINT:** Some PC Cards may not operate correctly after resuming operation from hibernate mode. If you encounter problems with a PC Card, reinsert the card or restart your computer.

To exit hibernate mode, press the power button. The computer may take a short time to return to its normal operating state. Pressing a key or touching the touch pad or track stick does not bring the computer out of hibernate mode.

Hibernate mode requires a special file on your hard drive with enough disk space to store the contents of the computer memory. Dell creates an appropriately sized hibernate mode file before shipping the computer to you.

If you reinstall the operating system, you must reenable [hibernate support](#).

---

### Power Options Properties

To access the Microsoft® Windows® **Power Options Properties** window:

1. Click the **Start** button, point to **Settings**, and click **Control Panel**.
2. Double-click the **Power Options** icon.

#### Power Schemes Tab

The **Power schemes** pull-down menu displays the selected preset power scheme:

- 1 **Portable/Laptop** (default)

- 1 **Home/Office**
- 1 **Always On**
- 1 **Presentation** (Windows 2000 only)
- 1 **Minimal Power Management** (Windows 2000 only)
- 1 **Max Battery** (Windows 2000 only)

 **HINT:** Dell recommends that you continue to use the **Portable/Laptop** power scheme to maximize battery power conservation.

Each preset power scheme has different time-out settings for putting the computer into standby mode, turning off the display, and turning off the hard drive.

## Alarms Tab

 **HINT:** To enable audible alarms, click each **Alarm Action** button and select **Sound alarm**.

The **Low battery alarm** and **Critical battery alarm** settings alert you with a message when the battery charge falls below a certain percentage. When you receive your computer, the **Lower battery alarm** and **Critical battery alarm** check boxes are selected. Dell recommends that you continue to use these defaults.

## Power Meter Tab

The **Power Meter** tab displays the current power source and amount of battery charge remaining.

## Advanced Tab

The **Advanced** tab allows you to:

- 1 Set icon and standby password options.
- 1 Program the following functions:
  - o Activate standby mode (the default when you close the display).
  - o Activate hibernate mode (the default for the power button).
  - o Shut down Windows and turn off the computer.
  - o Choose no action (**None**).

 **HINT:** If you are going to connect your computer to a port replicator, click **None** when you program the display-close option. This setting ensures that your computer does not enter standby mode or hibernate mode when you close (lower) the display.

To program these functions, click an option from the corresponding pull-down menu, and then click **OK**.

## Hibernate Tab

The **Hibernate** tab lets you enable hibernate mode by clicking the **Enable hibernate support** check box.

---

[Back to Contents Page](#)

## Removing and Replacing Parts

Dell™ Inspiron™ 8100

- [Preparing to Work Inside the Computer](#)
- [Recommended Tools](#)
- [Screw Identification](#)
- [System Components](#)
- [Hard Drive](#)
- [Fixed Optical Drive](#)
- [Media Bay Devices](#)
- [Memory Modules](#)
- [Mini PCI Card Assembly](#)
- [Keyboard Assembly](#)
- [Display and Bezel Assembly](#)
- [Display Assembly Bezel and Panel](#)
- [Display Latch Assembly](#)
- [Microprocessor Thermal Cooling Assembly](#)
- [Microprocessor Module](#)
- [Video Card](#)
- [Palm Rest Assembly](#)
- [Reserve Battery](#)
- [System Board Assembly](#)
- [Battery and Media Bay Latch Assemblies](#)
- [Battery Charger Board](#)
- [LED Board](#)
- [Fan Assembly](#)
- [RJ-11/RJ-45 Board](#)

---

### Preparing to Work Inside the Computer

- ➡ **NOTICE:** Only a certified service technician should perform repairs on your computer. Damage or inoperability due to servicing not authorized by Dell is not covered by your warranty.
- ➡ **NOTICE:** Unless otherwise noted, each procedure in this manual assumes that a part can be replaced by performing the removal procedure in reverse order.
- ➡ **NOTICE:** To avoid damaging the computer, perform the following steps before you begin working inside the computer.

1. Make sure that the work surface is clean to prevent scratching the computer cover.
2. Save and close any open files, and exit any open programs.

🔧 **HINT:** Make sure the computer is turned off and not in standby or hibernate mode. If you cannot shut down the computer using the computer's operating system, press and hold the power button for 4 seconds.

3. Turn off the computer and all attached devices.
4. Make sure the computer is undocked.
5. Disconnect the computer from the electrical outlet.
6. To avoid possible damage to the system board, wait 10 to 20 seconds and then disconnect any attached devices.
7. Disconnect all other external cables from the computer.
8. Remove any installed PC Cards or plastic blanks from the PC Card slot.
9. Close the display and turn the computer upside down on a flat work surface.
10. Remove the primary battery from the battery bay and the secondary battery from the media bay, if a secondary battery is in use.

➡ **NOTICE:** To avoid damaging the system board, you must remove the main battery and secondary battery (if present) before you service the computer.

11. Remove any installed device in the media bay.
12. To dissipate any static electricity while you work, periodically touch an unpainted metal surface on the surface of the computer, such as the I/O panel on the back of the computer chassis.
13. Handle components and cards with care. Do not touch the components or contacts on a card. Hold a card by its edges or by its metal mounting bracket. Hold a component such as a microprocessor by its edges, not by its pins.

---

### Recommended Tools

- 1 Number 1 magnetized Phillips screwdriver
- 1 Small flat-blade screwdriver
- 1 Pry stick
- 1 Small plastic scribe
- 1 Microprocessor extractor
- 1 Flash BIOS update program floppy disk or CD (required only when upgrading the microprocessor, replacing the reserve battery, or replacing the system board).

**NOTICE:** If the computer is running Microsoft® Windows® Millennium Edition (Me), you need to download the operating system update utility for Windows Me from <http://support.dell.com> and install it before you upgrade the BIOS.





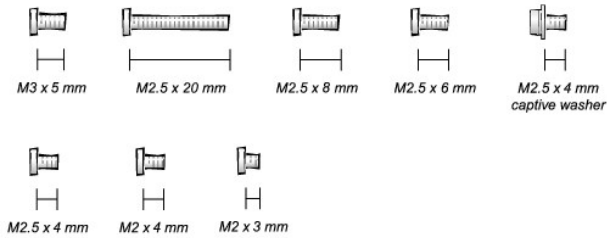









## Screw Identification

Before removing and replacing components, photocopy the screw placemat as a tool to lay out and keep track of the screws. The placemat provides the number of screws and the sizes.



**NOTICE:** When reinstalling a screw, you must use a screw of the correct diameter and length. Make sure that the screw is properly aligned with its corresponding hole, and avoid over tightening.

## Screw Placemat

<b>Hard Drive Door Security:</b> M3 x 5 mm (1 each) 	<b>Keyboard to Bottom Case Assembly:</b> M2.5 x 20 mm (4 each; plus one in memory module cover and one in Mini PCI card cover) 	<b>Display to Base:</b> M2.5 x 6 mm (3 each; 2 at back of computer; 1 at flex-cable strain relief) 
<b>Display Bezel:</b> Rubber screw covers (4 each) Plastic screw covers (2 each) M2.5 x 4 mm (6 each) 	<b>Display Panel to Display Mounting Bracket:</b> M2 x 3 mm (6 each)  <b>Flex-Cable Mounting Bracket to Top Cover:</b> M2.5 x 4 mm (1 each) 	<b>Video Card:</b> M2.5 x 8 mm (3 each) 
<b>Palm Rest to Bottom Case Assembly:</b> M2.5 x 20 mm (9 each)  <b>Palm Rest Bracket:</b> M2.5 x 4 mm (2 each) 	<b>System Board:</b> M2.5 x 4 mm captive washer (3 each)  M2.5 x 20 mm (1 each) 	<b>LED Board:</b> M2 x 4 mm (2 each) 
<b>Fan Assembly:</b> M2 x 4 mm (3 each) 	<b>RJ-11/RJ-45 Board Assembly:</b> M2.5 x 4 mm (1 each) 	

## System Components

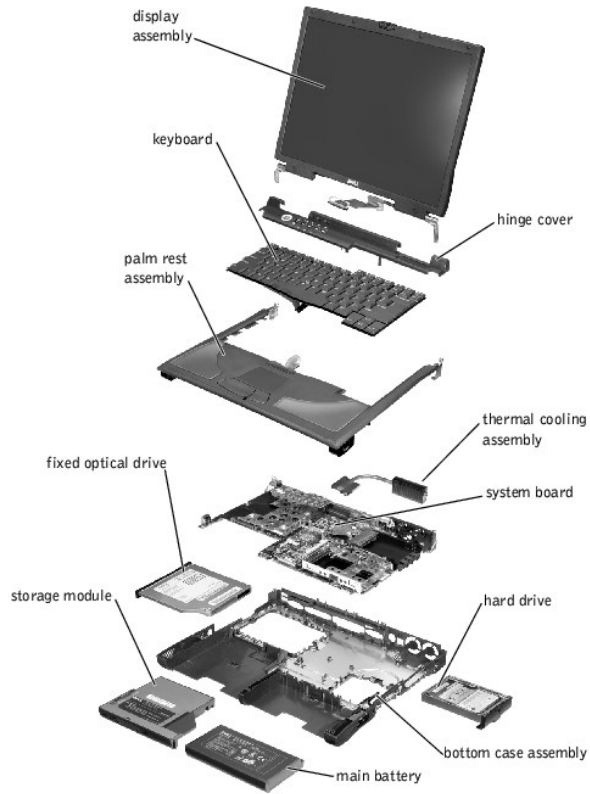

## Hard Drive

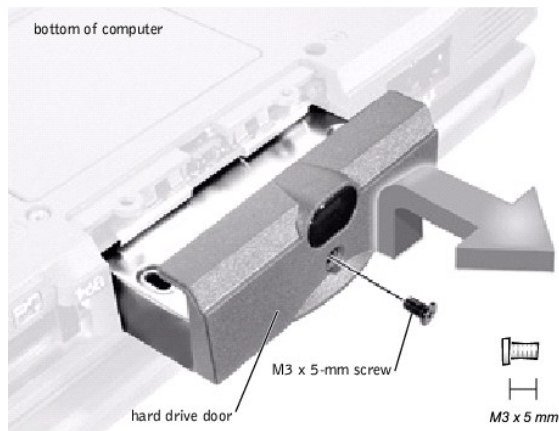

- ➔ **NOTICE:** Disconnect the computer and attached devices from electrical outlets and remove any installed batteries.
- ➔ **NOTICE:** To avoid ESD, ground yourself by using a wrist grounding strap or by periodically touching an unpainted metal surface on the computer.

## Removing the Hard Drive

- ➔ **NOTICE:** To avoid damaging the system board, you must remove the main battery before you service the computer.

- ➡ **NOTICE:** Make sure that the work surface is clean to prevent scratching the computer cover.
- ➡ **NOTICE:** The disk drive is very sensitive to shock. Handle the assembly by its edges (do not squeeze the top of the hard drive case), and avoid dropping it.

1. Follow the instructions in "[Preparing to Work Inside the Computer.](#)"
2. Close the display, turn the computer upside down on a flat work surface, and remove the main battery and secondary battery (if present).
3. Remove the M3 x 5-mm screw from the center of the hard drive door.
4. Slide the drive door up until the drive assembly tab disengages from the door slots in the bottom case assembly.
5. Carefully pull the drive assembly straight out of the bottom case assembly.

## Replacing the Hard Drive

1. Push the drive assembly into the hard drive opening on the left side of the computer.
  2. Align the drive assembly tabs with the bottom case assembly slots and push down until it clicks into place.
  3. Replace the M3 x 5-mm screw in the drive door.
- 

## Fixed Optical Drive

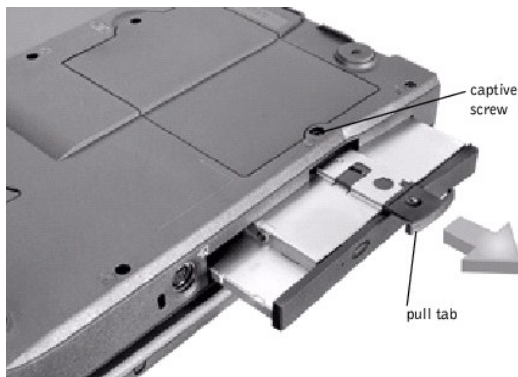

- ➡ **NOTICE:** Disconnect the computer and attached devices from electrical outlets and remove any installed batteries.
- ➡ **NOTICE:** To avoid ESD, ground yourself by using a wrist grounding strap or by periodically touching an unpainted metal surface on the computer.

## Removing the Fixed Optical Drive

1. Follow the instructions in "[Preparing to Work Inside the Computer.](#)"
  2. Loosen the captive screw on the bottom of the computer.
- ➡ **NOTICE:** To keep the pull tab from catching on the captive screw, turn the computer over before removing the fixed optical drive.
3. Turn the computer over, pull out the pull tab, and use the pull tab to remove the fixed optical drive.
- 

## Media Bay Devices

- ➡ **NOTICE:** Disconnect the computer and any attached devices from electrical outlets, and remove any installed batteries.
- ➡ **NOTICE:** To avoid ESD, ground yourself by using a wrist grounding strap or by periodically touching an unpainted metal surface on the computer.

## Removing Media Bay Devices

1. Follow the instructions in "[Preparing to Work Inside the Computer.](#)"
2. Close the display, turn the computer upside down on a flat work surface, and remove the main battery.
3. Remove the device from the media bay.



4. Push the module latch toward the right side of the computer. Keep holding the latch open while pulling the device out of the media bay with the other hand.

---

## Memory Modules

- ➔ **NOTICE:** Disconnect the computer and attached devices from electrical outlets and remove any installed batteries.
- ➔ **NOTICE:** To avoid possible damage to the memory module from ESD, ground yourself by using a wrist grounding strap or by periodically touching an unpainted metal surface on the computer.

### Removing the Memory Module Cover

- ➔ **NOTICE:** To avoid damaging the system board, you must remove the main battery before you service the computer.
- ➔ **NOTICE:** Make sure that the work surface is clean to prevent scratching the computer cover.
- ➔ **NOTICE:** Handle memory modules with care. Do not touch the components on a module. Hold a module by its edges.

1. Follow the instructions in "[Preparing to Work Inside the Computer.](#)"
2. Remove the screw.
3. Disengage the metal tabs at the opposite end of the cover.

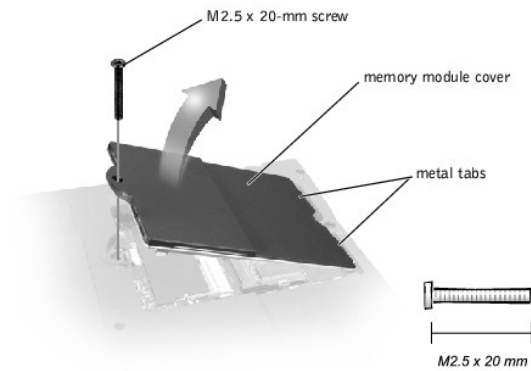

### Removing Memory Modules

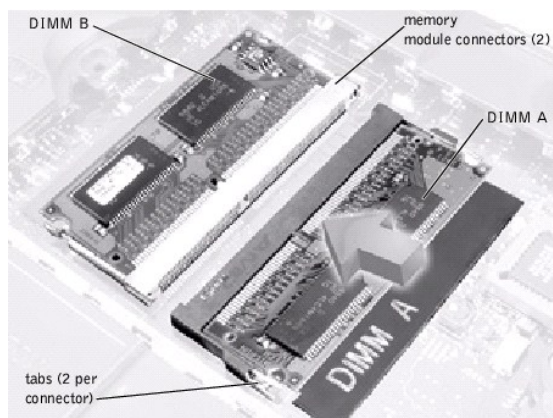

1. Remove the [memory module cover](#).
2. To release a memory module from its connector, spread apart the tabs at each side of the module until the module pops up slightly.
3. Lift the memory module out of its connector.

## Replacing Memory Modules

 **HINT:** Memory modules are keyed, or designed to fit into their connectors, in only one direction.

1. If you only have one memory module, install it in the connector labeled "DIMM A." If you have two memory modules, install the second module in the connector labeled "DIMM B."
2. Insert the memory module's edge connector with the slot at a 45-degree angle, and press the memory module firmly into the slot.
3. Pivot the memory module down until it clicks into place. If you do not hear a click, remove the module and reinstall it.
4. Insert the metal tabs on the memory module cover into the bottom case assembly. Rotate the cover down and replace the screw.

---

## Mini PCI Card Assembly

 **NOTICE:** Disconnect the computer and attached devices from electrical outlets and remove any installed batteries.

 **NOTICE:** To avoid ESD, ground yourself by using a wrist grounding strap or by periodically touching an unpainted metal surface on the computer.

You must remove the optional Mini PCI card assembly before the system board assembly can be removed. A Mini PCI card assembly may consist of a modem, a network adapter, a modem and network adapter combination, or a wireless network adapter. A modem, network adapter, or modem and network adapter combination must be connected to the wiring harness as appropriate; a wireless network adapter must be connected to the system's internal antenna.

## Removing the Mini PCI Card Assembly

1. Follow the instructions in "[Preparing to Work Inside the Computer](#)."
2. Remove the M2.5 x 20-mm screw and lift out the Mini PCI card cover.

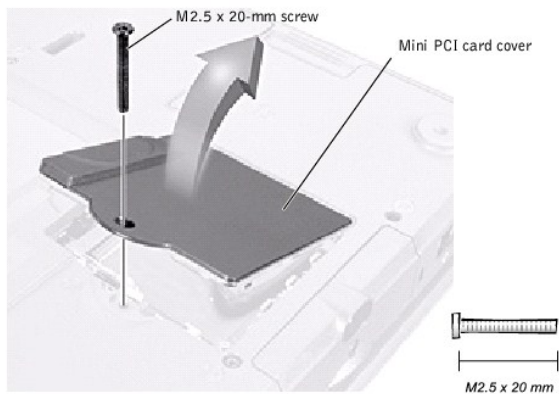

3. To release the Mini PCI card assembly, spread the metal securing tabs until the assembly pops up slightly.
4. Disconnect the assembly from the wiring harness or internal antenna.
5. Lift out the assembly and disconnect any attached cables.

## Replacing the Mini PCI Card Assembly

1. Align the Mini PCI card assembly with the connector at a 45-degree angle, and press the Mini PCI card into the connector.
2. Depending on what type of Mini PCI card you are installing, either connect the wiring harness to the Mini PCI card assembly, or connect the mini-coax antenna cable to the Mini PCI card assembly and to the internal antenna.

 **NOTICE:** The connectors are keyed for correct insertion; do not force the connections.

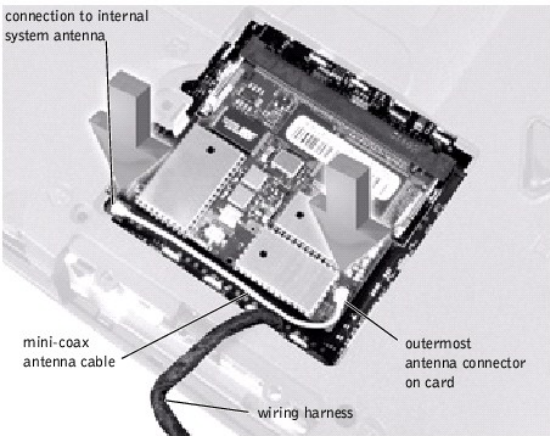
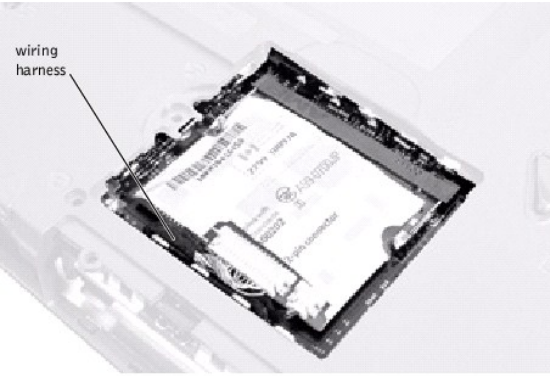

- ➔ **NOTICE:** If a wireless network adapter card contains two mini-coax antenna connectors, connect the mini-coax cable to the outermost antenna connector as shown.
  - ➔ **NOTICE:** If you are installing a wireless network adapter, fold and tuck the unused wiring harness into the slot so that it does not interfere with the cover.
3. Pivot the Mini PCI card assembly down until it clicks into place.
  4. Replace the Mini PCI card assembly cover.

---

## Keyboard Assembly

- ➔ **NOTICE:** Disconnect the computer and attached devices from electrical outlets and remove any installed batteries.
- ➔ **NOTICE:** To avoid ESD, ground yourself by using a wrist grounding strap or by periodically touching an unpainted metal surface on the computer.

## Removing the Keyboard Assembly

1. Follow the instructions in ["Preparing to Work Inside the Computer."](#)
2. Turn the computer over and remove the four screws labeled with a "circle K."

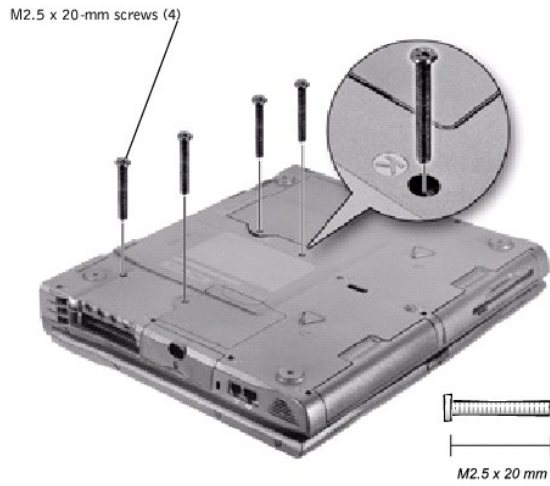

3. Turn the computer over and open the display.

➔ **NOTICE:** Be careful when handling the keyboard. The keycaps are fragile, easily dislodged, and time-consuming to replace.

4. Insert a pry stick under the blank key to pry up the keyboard.

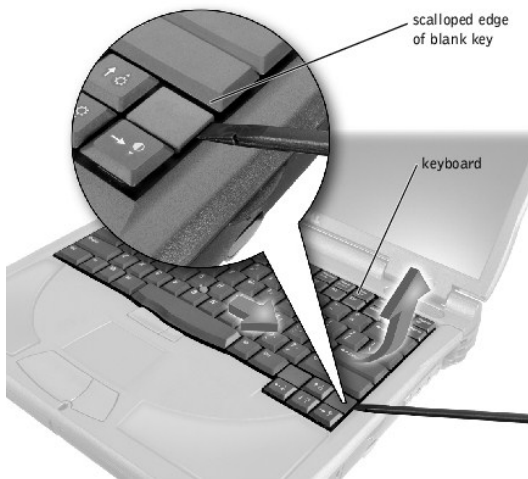

5. Lift the right end of the keyboard, and slide it slightly to the right to disengage the tabs at the left end.

6. Pivot the keyboard and balance it upright on the left side of the computer.

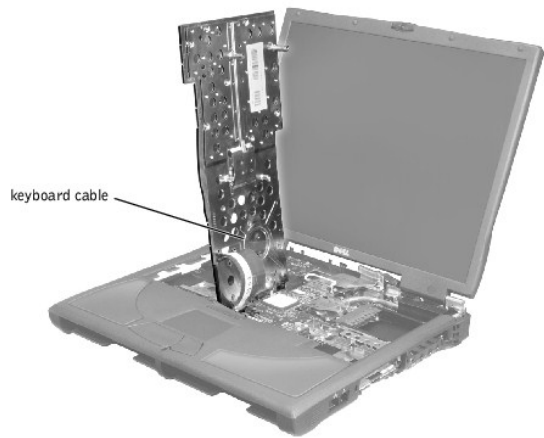

7. Disconnect the keyboard cable and lay the keyboard assembly aside.

## Replacing the Keyboard Assembly

1. While bracing the keyboard assembly upright on its left end, connect the keyboard cable to the interface connector on the system board.

**NOTICE:** Position the keyboard/track stick flex cable so that it is not pinched when you replace the keyboard in the bottom case assembly.

2. Insert the metal tabs at the left end of the keyboard under the edge of the bottom case assembly, and fit the keyboard into place.
3. Check that the keyboard is correctly installed. The keys should be flush with the left and right surfaces of the palm rest.
4. Reinstall the four screws in the holes labeled "circle K."

---

## Display and Bezel Assembly

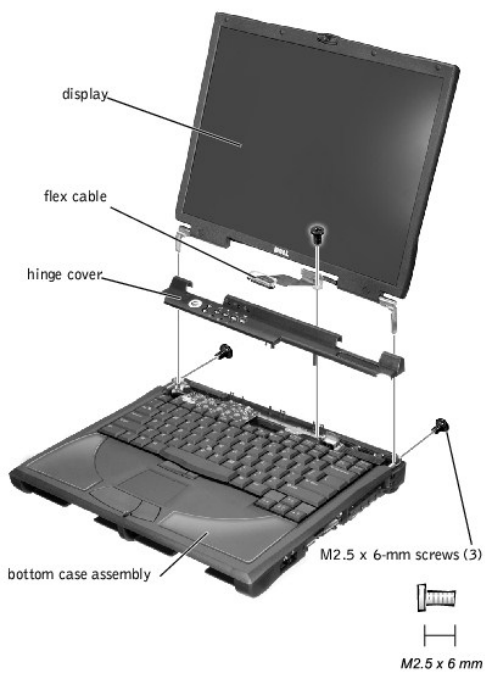

- ➔ **NOTICE:** Disconnect the computer and attached devices from electrical outlets and remove any installed batteries.
- ➔ **NOTICE:** To avoid ESD, ground yourself by using a wrist grounding strap or by periodically touching an unpainted metal surface on the computer.

## Removing the Hinge Cover

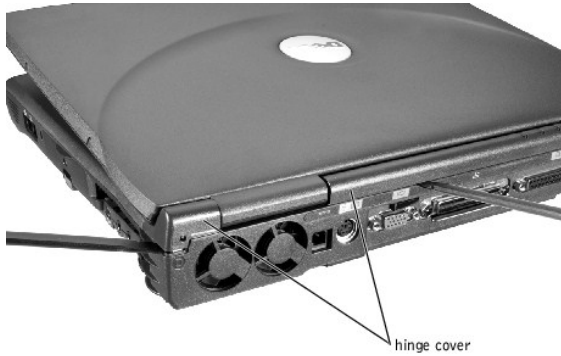

1. Follow the instructions in "[Preparing to Work Inside the Computer.](#)"
2. Use a nonmarring tool to loosen the hinge cover at the back and at each side of the computer.
3. Open the display and lift off the hinge cover.

## Removing the Display Assembly



1. Remove the [hinge cover](#).
2. Remove the M2.5 x 6-mm screw that secures the flex cable to the strain relief, and then use the pull loop to remove the flex cable from the video card.

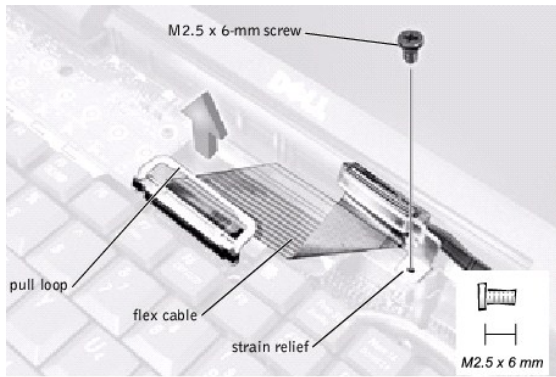

➔ **NOTICE:** When reconnecting the flex cable, press down on both ends of the connector, not in the middle. Pressing the middle of the connector can damage fragile components.

3. Open the display and remove the two screws (marked with a "circle D") that secure the display assembly to the bottom case assembly.
4. With the display in an upright position, lift the display assembly from the bottom case assembly.

## Display Assembly Bezel and Panel

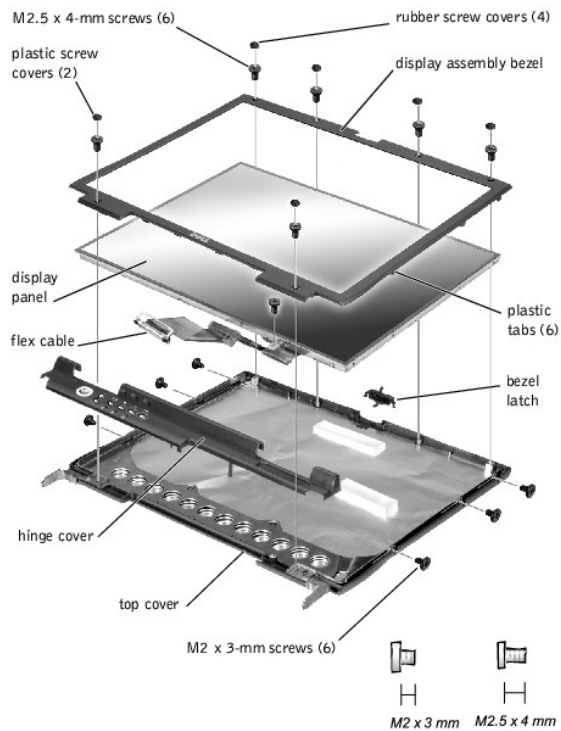

➔ **NOTICE:** Disconnect the computer and attached devices from electrical outlets and remove any installed batteries.

➔ **NOTICE:** To avoid ESD, ground yourself by using a wrist grounding strap or by periodically touching an unpainted metal surface on the computer.

## Removing the Display Assembly Bezel

1. Follow the instructions in ["Preparing to Work Inside the Computer."](#)
2. Use a scribe to pry loose the four rubber screw covers located across the top of the bezel.

 **HINT:** The 14.1-inch display panel has two M2.5 x 4-mm screws at the top of the bezel and two at the bottom.

3. Remove the four M2.5 x 4-mm screws located across the top of the bezel.
4. Use a scribe at the indentations to pry loose the plastic screw covers located at the bottom of the bezel.
5. Remove the two M2.5 x 4-mm screws located at the bottom of the bezel.
6. Separate the bezel from the display-assembly top cover.

The bezel is secured to the display assembly top cover with plastic tabs around the sides. Use a plastic scribe to help separate the bezel from the top cover.

## Removing the Display Panel

1. Remove the [hinge cover](#).
2. Remove the screw securing the flex cable to its strain relief, and then use the pull loop to remove the flex cable from the video card.

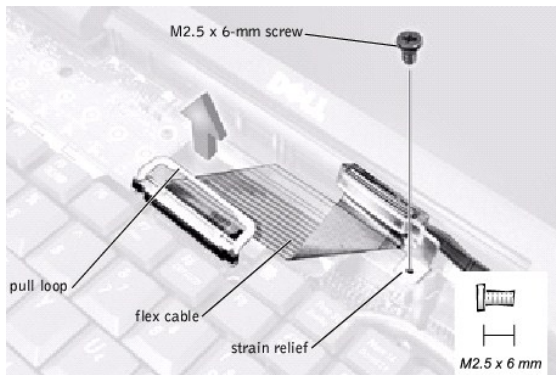

 **NOTICE:** When reconnecting the flex cable, press down on both ends of the connector, not in the middle. Pressing the middle of the connector can damage fragile components.

3. Remove the [display assembly bezel](#).
4. Remove the M2.5 x 4-mm screw securing the plastic flex-cable mounting bracket to the top cover assembly.
5. Remove the six M2 x 3-mm screws (three on each side) from the right and left sides of the panel.
6. Lift the display panel and flex cable out of the top cover assembly.
7. Disconnect the flex cable from the two connectors (a ZIF and a standard connector) on the display panel assembly.



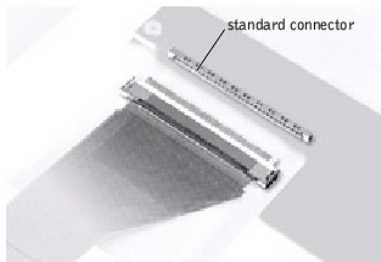
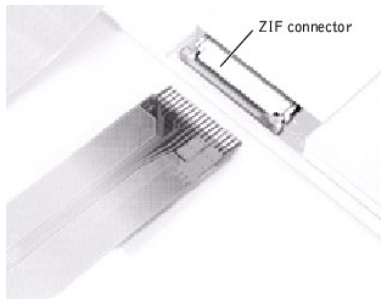

## Replacing the Display Panel

 **HINT:** Use a magnetic screwdriver to reassemble the display panel in the display.

1. Connect the flex cable to the two connectors on the back of the display panel.
2. Place the display panel assembly in the top cover, taking care that the flex cable is in place and is not crushed or crimped.
3. Reinstall the M2.5 x 4-mm screw that secures the flex-cable mounting bracket to the top cover.
4. Starting on the left side, use a magnetic screwdriver to reinstall the six M2 x 3-mm screws that secure the display panel in the top cover.
5. Reinstall the display assembly bezel.

---

## Display Latch Assembly



1. Remove the [hinge cover](#).
2. Remove the screw securing the flex cable to its strain relief, and then use the pull loop to remove the flex cable from the video card.

 **NOTICE:** When reconnecting the flex cable, press down on both ends of the connector, not in the middle. Pressing the middle of the connector can damage fragile components.

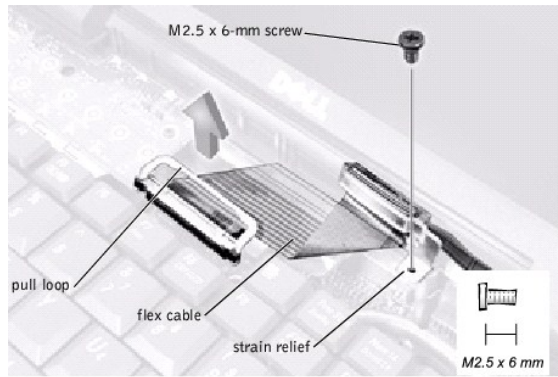

3. Remove the [display assembly bezel](#).
4. Remove the display panel from the top cover.
5. Remove the display latch by unsnapping the latch and captive spring.

👉 **NOTICE:** When replacing the display assembly latch, it may help to flex the cover slightly to allow more space while seating the latch.

---

## Microprocessor Thermal Cooling Assembly

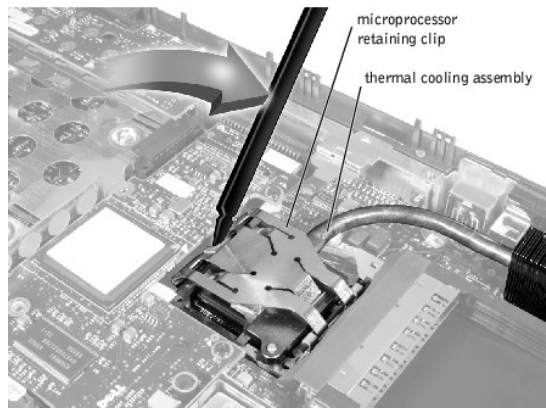

- 👉 **NOTICE:** Disconnect the computer and attached devices from electrical outlets and remove any installed batteries.
- 👉 **NOTICE:** To avoid ESD, ground yourself by using a wrist grounding strap or by periodically touching an unpainted metal surface on the computer.

## Removing the Microprocessor Thermal Cooling Assembly

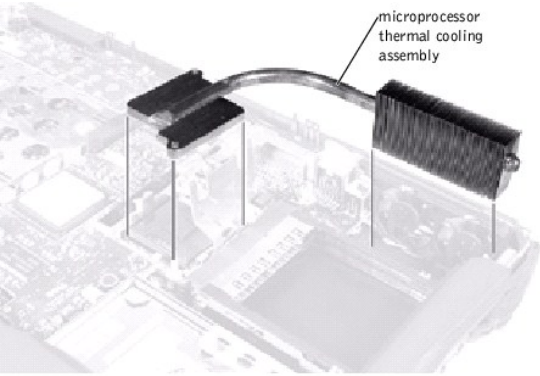

1. Follow the instructions in "[Preparing to Work Inside the Computer.](#)"
2. Remove the [keyboard assembly.](#)
3. Remove the [hinge cover.](#)

➡ **NOTICE:** To ensure maximum cooling for the microprocessor, do not touch the heat transfer areas on the thermal cooling assembly. The oils in your skin reduce the heat transfer capability of the thermal pads.

4. Insert a pry stick into the latch mechanism at the left side of the microprocessor retaining clip and pry open the clip.
5. Lift out the thermal cooling assembly.

---

## Microprocessor Module

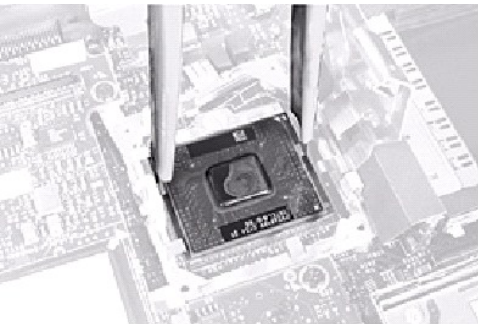

➡ **NOTICE:** Disconnect the computer and attached devices from electrical outlets and remove any installed batteries.

➡ **NOTICE:** To avoid ESD, ground yourself by using a wrist grounding strap or by periodically touching an unpainted metal surface on the computer.

## Removing the Microprocessor Module

1. Follow the instructions in "[Preparing to Work Inside the Computer.](#)"
2. Remove the [keyboard assembly.](#)
3. Remove the [hinge cover.](#)

➡ **NOTICE:** To ensure maximum cooling for the microprocessor, do not touch the heat transfer areas on the thermal cooling assembly. The oils in your skin reduce the heat transfer capability of the thermal pads.

4. Remove the [microprocessor thermal cooling assembly.](#)

➡ **NOTICE:** When removing the microprocessor module, pull the module straight up. Do not bend the pins.

5. Remove the microprocessor module.

➔ **NOTICE:** To avoid damaging the microprocessor when removing the cam lock screw, hold the screwdriver so that it is perpendicular to the microprocessor.

- a. Loosen the microprocessor socket cam lock screw. The location of the screw and the rotation direction may vary with the socket manufacturer; look for small icons indicating open and locked positions.

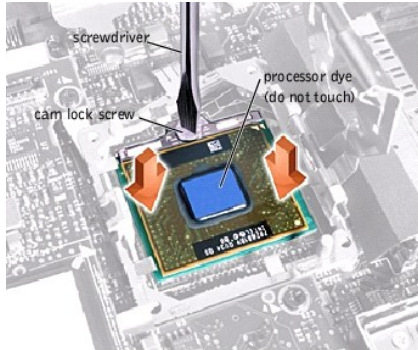

- b. Use the microprocessor extraction tool to remove the microprocessor module.

## Replacing the Microprocessor Module

➔ **NOTICE:** After replacing the microprocessor module, update the BIOS using a flash BIOS update program floppy disk or CD that came with the replacement microprocessor.

➔ **NOTICE:** If the computer is running Microsoft® Windows® Millennium Edition (Me), you need to download the operating system update utility for Windows Me from <http://support.dell.com> and install it before you upgrade the BIOS.

➔ **NOTICE:** Proper seating of the microprocessor module does not require force.

➔ **NOTICE:** A microprocessor module that is not properly seated can result in an intermittent connection and subsequent failures.

1. Align the pin-1 triangle on the microprocessor toward the pin-1 triangle in the connector, insert the microprocessor into the socket, and move it around slightly until you feel it settle into the socket.

When the microprocessor module is correctly seated, all four corners are aligned to the same height. If one or more corners of the module are higher than the others, the module is not seated correctly.

➔ **NOTICE:** Hold the microprocessor down while turning the cam lock screw to prevent intermittent contact between the cam lock screw and microprocessor.

2. Tighten the cam lock screw.

➔ **NOTICE:** Do not over or under tighten the screw. Tighten it until the screw indicator points to the "closed" or "locked" indicator on the socket.

3. Replace the microprocessor thermal cooling assembly.
4. While pressing lightly down on the center of the retaining clip, insert a pry stick into the latch mechanism and pivot the top of the pry stick away from the clip to close the latch.

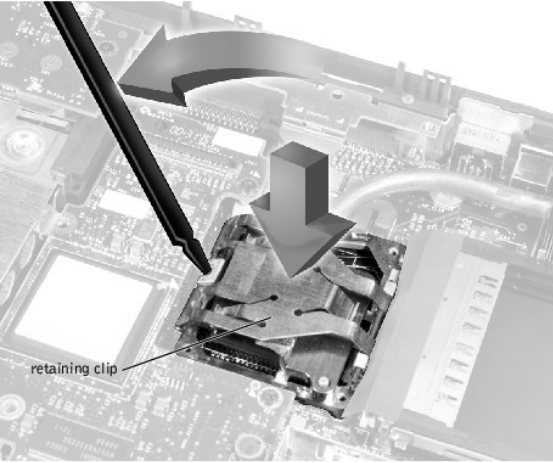

## Video Card

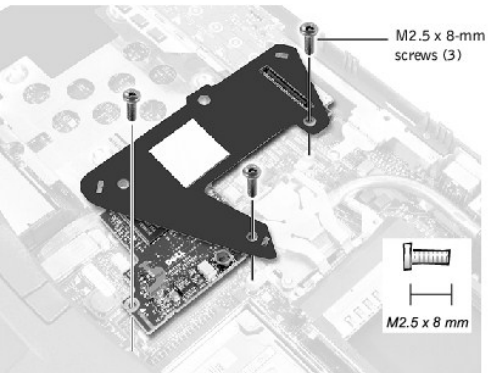

- ➡ **NOTICE:** Disconnect the computer and attached devices from electrical outlets and remove any installed batteries.
- ➡ **NOTICE:** To avoid ESD, ground yourself by using a wrist grounding strap or by periodically touching an unpainted metal surface on the computer.

## Removing the Video Card

1. Follow the instructions in "[Preparing to Work Inside the Computer.](#)"
2. Remove the [keyboard assembly.](#)
3. Remove the [hinge cover.](#)
4. Detach the display flex cable from the strain relief and the video card (see step 2 of "[Removing the Display Assembly.](#)").
5. Remove the three M2.5 x 8-mm screws that secure the video card.
6. Separate the video card from the system board connector.

- ➡ **NOTICE:** When reconnecting the flex cable, press down on both ends of the connector, not in the middle. Pressing the middle of the connector can damage fragile components.

## Replacing the Video Card

1. Align the three screw holes and press down firmly on the top of the connector to seat the card in its connector.
- ➡ **NOTICE:** Make sure the card is correctly and firmly seated before continuing. Failure to do so will cause intermittent video failures.
2. Replace the three screws (the screw lengths are marked on the card).

---

## Palm Rest Assembly

### Removing and Replacing the Palm Rests

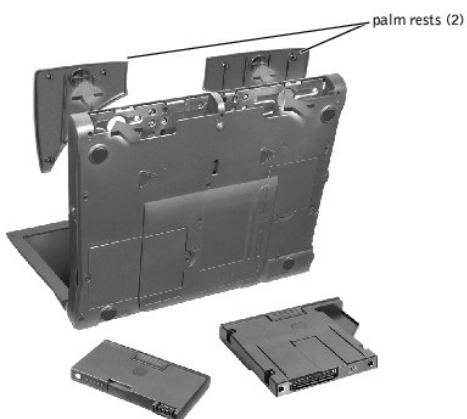

1. If the computer is connected (docked) to an advanced port replicator (APR), undock it.
2. Keep the display open, and tilt the computer back so that you can access the bottom of the computer.
3. Slide and hold the latch release on the left side, and remove any device installed in the media bay.
4. Slide and hold the latch release on the right side, and remove any battery installed in the battery bay.
5. Locate the indentation under each palm rest, place your thumbs on the indentation, and gently push to release the palm rests.



6. Remove the palm rests.
  7. To replace a palm rest, insert it into the slots on the computer. Then press along the outside edges of the palm rest until it snaps into place.
- Repeat the process on each side.

### Removing the Palm Rest Assembly

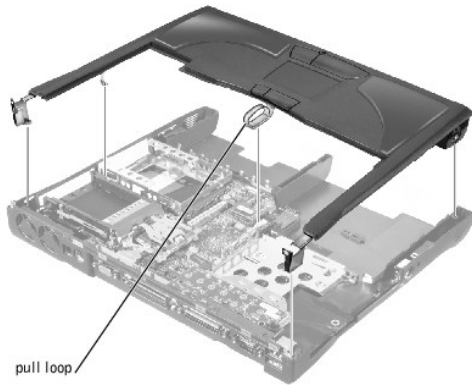

- ➔ **NOTICE:** Disconnect the computer and attached devices from electrical outlets and remove any installed batteries.
- ➔ **NOTICE:** To avoid ESD, ground yourself by using a wrist grounding strap or by periodically touching an unpainted metal surface on the computer.
- ➔ **NOTICE:** The reserve battery provides power to the computer's RTC and NVRAM when the computer is turned off. Removing the palm rest disconnects the reserve battery and causes the computer to lose the date and time information as well as all user-specified parameters in NVRAM. If possible, make a copy of this information before you disconnect the reserve battery.

1. Follow the instructions in "[Preparing to Work Inside the Computer.](#)"
2. Remove the [hard drive](#) and the [fixed optical drive](#).
3. Remove the [keyboard assembly](#).
4. Remove the [hinge cover](#).
5. Remove the [display](#).

- ➔ **NOTICE:** To avoid damaging the palm rest assembly, you must first remove the display assembly.

6. Turn the computer over.
7. Remove the nine M2.5 x 20-mm screws (labeled with a "circle P") that secure the palm rest to the computer.

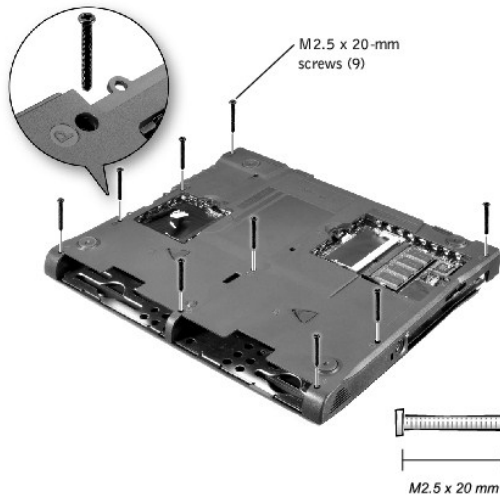

8. Turn the computer over.
  9. Use the pull loop to disconnect the palm rest flex cable from the touch-pad connector on the system board.
  10. Carefully lift out the palm rest assembly.
-

## Reserve Battery

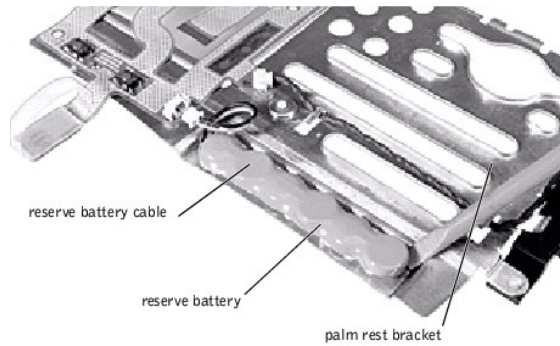

- ➔ **NOTICE:** Disconnect the computer and attached devices from electrical outlets and remove any installed batteries.
- ➔ **NOTICE:** To avoid ESD, ground yourself by using a wrist grounding strap or by periodically touching an unpainted metal surface on the computer.

## Removing the Reserve Battery

1. Follow the instructions in "[Preparing to Work Inside the Computer.](#)"
2. Remove the [keyboard assembly](#).
3. Remove the [hinge cover](#).
4. Remove the [display assembly](#).
5. Remove the [palm rest assembly](#).
6. On the underside of the palm rest, disconnect the flex cable from the ZIF connector.

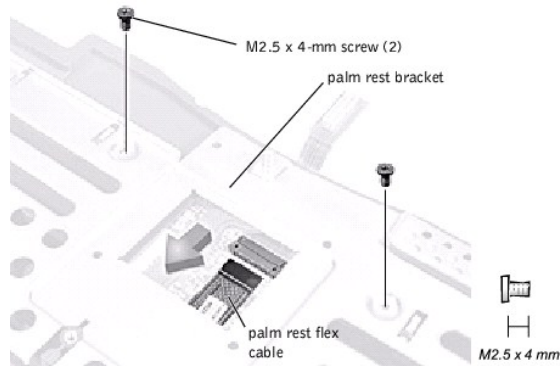

7. Remove the two M2.5 x 4-mm screws securing the palm rest bracket.
  8. While supporting the flex cable, lift out the palm rest bracket and turn it over.
- ➔ **NOTICE:** The reserve battery provides power to the computer's RTC and NVRAM when the computer is turned off. Removing the battery causes the computer to lose the date and time information as well as all user-specified parameters in NVRAM. If possible, make a copy of this information before you remove the reserve battery.
9. Disconnect the reserve battery cable.
  10. Remove the reserve battery:
    - a. Pry the reserve battery free from the metal palm rest bracket.
    - b. Remove the foam-pad remnants from the palm rest bracket.

## Replacing the Reserve Battery



1. Seat the reserve battery and press it into place.
2. Connect the reserve battery cable.
3. Place the palm rest bracket loosely in the palm rest, and connect the palm rest flex cable to the ZIF connector.
4. Replace the two M2.5 x 4-mm screws that secure the palm rest bracket to the palm rest.

---

## System Board Assembly

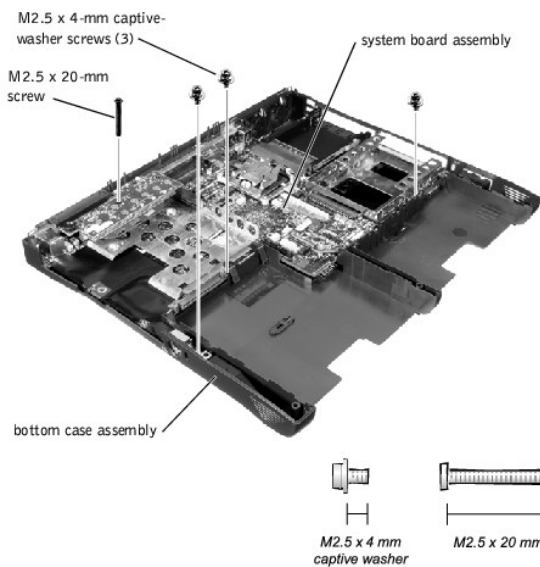

- ➡ **NOTICE:** Disconnect the computer and attached devices from electrical outlets and remove any installed batteries.
- ➡ **NOTICE:** To avoid ESD, ground yourself by using a wrist grounding strap or by periodically touching an unpainted metal surface on the computer.

The system board's BIOS contains the system service tag number, which is also visible on a bar-code label on the bottom of the computer. The replacement kit for the system board assembly includes a floppy disk or CD that provides a utility for transferring the service tag number to the replacement system board assembly.

- ➡ **NOTICE:** After replacing the microprocessor module, update the BIOS using a flash BIOS update program floppy disk or CD that came with the replacement microprocessor.

## Removing the System Board

1. Follow the instructions in "[Preparing to Work Inside the Computer.](#)"
2. Remove the [hard drive](#) and [fixed optical drive](#).
3. Remove any installed [Mini PCI cards](#).
4. If migrating the memory, remove all installed [memory modules](#).
5. Remove the [keyboard assembly](#).
6. Remove the [hinge cover](#).
7. Remove the [display assembly](#).
8. Remove the [palm rest assembly](#).
9. Remove the [video card](#).
10. Remove the [microprocessor thermal cooling assembly](#).
11. If migrating the microprocessor, remove the microprocessor module.
12. Remove the three M2.5 x 4-mm captive-washer screws from the system board.
13. Remove the M2.5 x 20-mm screw from the center of the LED board.
14. Lift the front of the system board and work it out of the back panel.



## Battery and Media Bay Latch Assemblies

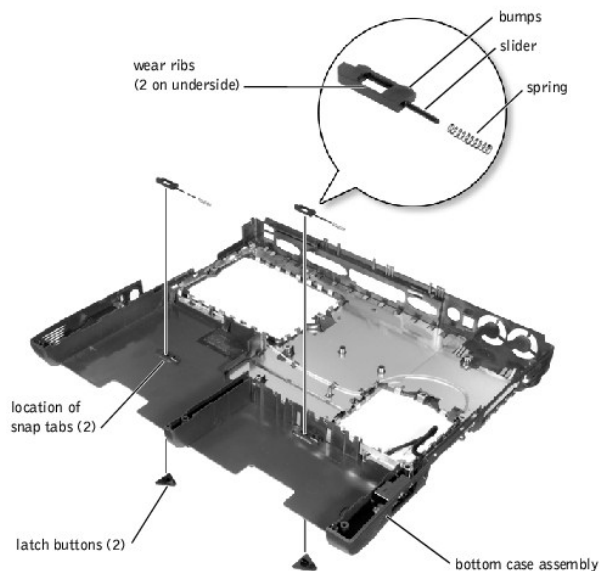

➡ **NOTICE:** Disconnect the computer and attached devices from electrical outlets and remove any installed batteries.

➡ **NOTICE:** To avoid ESD, ground yourself by using a wrist grounding strap or by periodically touching an unpainted metal surface on the computer.

## Removing and Replacing the Battery and Media Bay Latch Assemblies

1. Follow the instructions in "[Preparing to Work Inside the Computer.](#)"
2. Remove the [keyboard assembly](#).
3. Remove the [hinge cover](#).
4. Remove the [display assembly](#).
5. Remove the [palm rest assembly](#).
6. Remove a latch button from the bottom case assembly by squeezing the snap tabs in the center of the latch.

Apply downward pressure to the tabs while squeezing them together (tweezers work well) to eject the latch button from the bottom of the case without loosening the upper latch assembly (spring and slider). If the upper latch assembly does come loose:

- a. Reinsert the spring onto the slider, and reinstall both pieces in the latch housing on the inside of the case.

- b. Ensure that the slider is inserted so that the side with the two bumps is facing the back of the case, and the surface with the wear ribs is facing the bottom of the case.
  7. Hold the upper latch assembly in place while you snap the new latch button in from underneath the base, making certain the snap tabs are fully engaged in the slider.
  8. Ensure that the newly installed latch assembly moves smoothly and freely when pushed and released.
- 

## Battery Charger Board

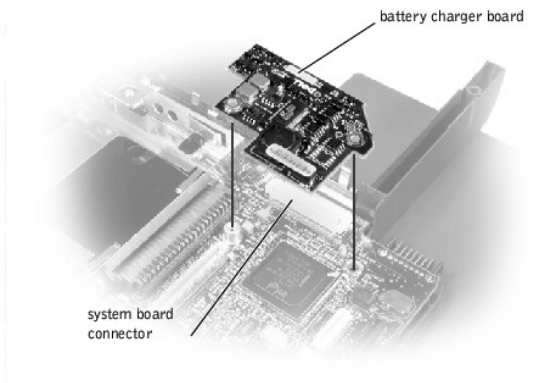

- ➔ **NOTICE:** Disconnect the computer and attached devices from electrical outlets and remove any installed batteries.
- ➔ **NOTICE:** To avoid ESD, ground yourself by using a wrist grounding strap or by periodically touching an unpainted metal surface on the computer.

## Removing the Battery Charger Board

1. Follow the instructions in "[Preparing to Work Inside the Computer.](#)"
2. Remove the [keyboard assembly](#).
3. Remove the [hinge cover](#).
4. Remove the [display assembly](#).
5. Remove the [palm rest assembly](#).
6. Lift out the video card.
7. Lift the battery charger board out of the system board connector.

## Replacing the Battery Charger Board

Align the screw holes on the battery charger board with the screw holes on the bottom case assembly, and then press the battery charger board down into its connector.

---

## LED Board

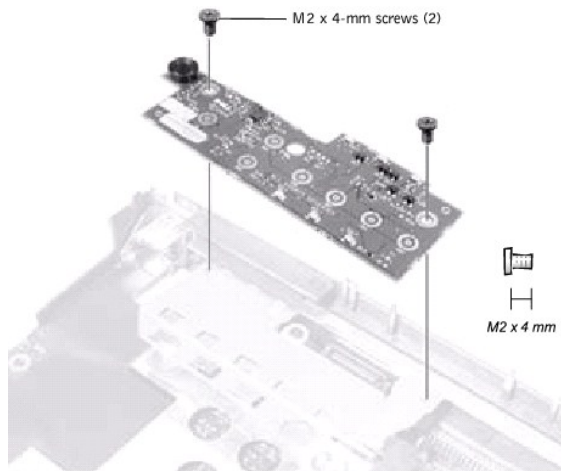

- ➔ **NOTICE:** Disconnect the computer and attached devices from electrical outlets and remove any installed batteries.
- ➔ **NOTICE:** To avoid ESD, ground yourself by using a wrist grounding strap or by periodically touching an unpainted metal surface on the computer.

## Removing the LED Board

1. Follow the instructions in "[Preparing to Work Inside the Computer.](#)"
2. Remove the [hinge cover](#).
3. Remove the two M2 x 4-mm screws.
4. Pull the LED board away from its connector.

## Replacing the LED Board

1. Align the two screw holes with the two mounting holes on the bottom case assembly, and press the board into its connector.
2. Replace the two M2 x 4-mm screws.

---

## Fan Assembly

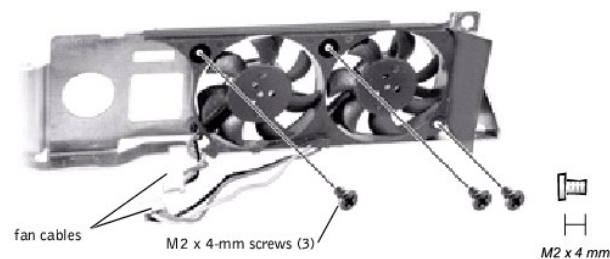

- ➔ **NOTICE:** Disconnect the computer and attached devices from electrical outlets and remove any installed batteries.
- ➔ **NOTICE:** To avoid ESD, ground yourself by using a wrist grounding strap or by periodically touching an unpainted metal surface on the computer.

## Removing the Fan Assembly

1. Follow the instructions in "[Preparing to Work Inside the Computer.](#)"
2. Remove the [system board](#).

3. Remove the three M2 x 4-mm screws from the fan assembly.
4. Disconnect the two fan cables from the system board.
5. Pull the fan assembly away from the back-panel bracket.

➔ **NOTICE:** When reconnecting the fan cables, connect the shorter cable to the connector closest to the fan assembly. Route both cables so that they will not be pinched by the thermal cooling assembly.

---

## RJ-11/RJ-45 Board

- ➔ **NOTICE:** Disconnect the computer and attached devices from electrical outlets and remove any installed batteries.
- ➔ **NOTICE:** To avoid ESD, ground yourself by using a wrist grounding strap or by periodically touching an unpainted metal surface on the computer.

### Removing the Protective Covers From the RJ-11 and RJ-45 Connectors

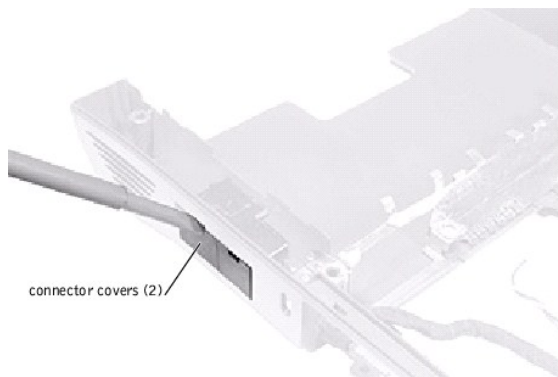

1. Follow the instructions in "[Preparing to Work Inside the Computer.](#)"
2. Remove one or both of the plastic connector covers (one or both of the covers may be installed) by slipping a nonmarring tool into the cutout at the top and pivoting the tool up to disengage the inner securing tab.

To replace a connector cover, orient the cover notch-side-up and snap it into the connector cutout.

### Removing the RJ-11/RJ-45 Board

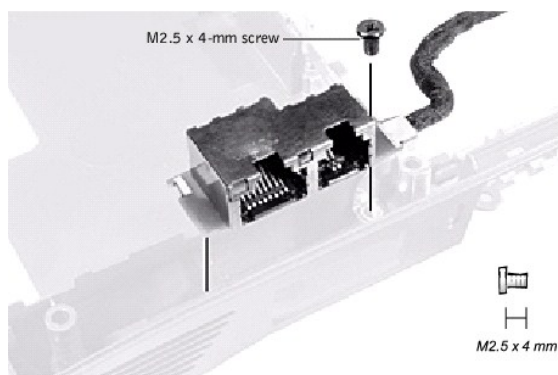

1. Follow the instructions in "[Preparing to Work Inside the Computer.](#)"
2. Remove the [system board](#).
3. Remove the M2.5 x 4-mm screw from the RJ-11/RJ-45 board.

➔ **NOTICE:** The plastic tab is fragile; pull it back only far enough to remove the board assembly.

4. Reach into the enclosure and, while pulling the tall plastic tab away from the board assembly to release it, lift out the assembly.

When replacing the RJ-11/RJ-45 board assembly, protect the wiring harness by routing it between the plastic posts as shown in the following figure.

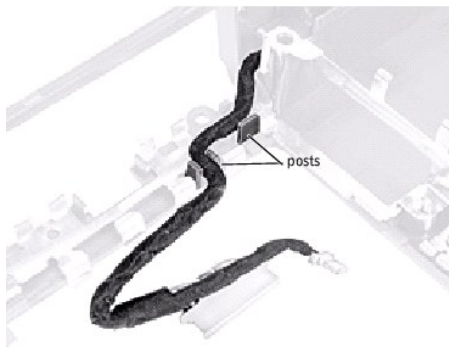

---

[Back to Contents Page](#)

[Back to Contents Page](#)

## System Setup Program

Dell™ Inspiron™ 8100

- [Standard Settings](#)
  - [System Setup Program Pages](#)
  - [Viewing the System Setup Program Pages](#)
- 

### Standard Settings

The system setup program contains the standard settings for your computer.



**NOTICE:** Unless you are an expert computer user, do not change the settings for this program. Certain changes might make your computer work incorrectly.

---

### System Setup Program Pages



**HINT:** To see information about a specific item, highlight the item and refer to the **Help** area on the screen.

The system setup program pages display the current setup information and settings for your computer. You can change settings that appear as white type on the screen.

- 1 Page 1 displays system information.
  - 1 Page 2 displays boot configuration and dock configuration settings.
  - 1 Page 3 displays basic device configuration settings.
  - 1 Page 4 displays battery charge status.
  - 1 Page 5 displays power management settings.
  - 1 Page 6 displays system security and hard drive password settings.
- 

### Viewing the System Setup Program Pages

1. Turn on (or restart) your computer.
2. When the Dell™ logo appears, press <F2> immediately.

If you wait too long and the Windows® logo appears, continue to wait until you see the Windows desktop. Then shut down your computer and try again.

---

[Back to Contents Page](#)

[Back to Contents Page](#)

## Solving Problems

Dell™ Inspiron™ 8100

- [Accessing Help Files](#)
- [Power Problems](#)
- [Start-Up Error Messages](#)
- [Video and Display Problems](#)
- [Sound and Speaker Problems](#)
- [Printer Problems](#)
- [Modem Problems](#)
- [Scanner Problems](#)
- [Touch Pad Problems](#)
- [External Keyboard Problems](#)
- [Unexpected Characters](#)
- [Drive Problems](#)
- [Network Problems](#)
- [Windows® Error Messages](#)
- [General Program Problems](#)
- [E-Mail Problems](#)
- [If Your Computer Gets Wet](#)
- [If You Drop or Damage Your Computer](#)
- [Resolving Other Technical Problems](#)

 **HINT:** If you have a problem with an external device, see the device documentation or contact the manufacturer.

---

## Accessing Help Files

### To access the *Tell Me How* help file

1. Click the **Start** button, point to **Programs—>User's Guides**, and then click **Tell Me How**.

### To access *Microsoft® Windows® 2000 Help*

1. Click the **Start** button and then click **Help**.
2. Click the **Search** tab.
3. Type a word or phrase that describes your problem and then click **List Topics**.
4. Click the topic that describes your problem and then click **Display**.
5. Follow the instructions shown on the screen.

### To access *Windows Me Help*

1. Click the **Start** button and then click **Help**.
  2. Type a word or phrase that describes your problem in the **Search** box and then click **Go**.
  3. Click the topic that describes your problem and then click **Display**.
  4. Follow the instructions shown on the screen.
- 

## Power Problems

 **HINT:** See the [Tell Me How](#) help file for information on standby mode.

**Check the power light—**When the power light is lit or blinking, the computer has power. If the power light is blinking, the computer is in standby mode—press the power button to exit standby mode. If the power light is off, press the power button.

**Check the battery—**If you are using a battery to power your computer, the battery charge may be depleted. Connect the computer to an electrical outlet using the AC adapter, and turn on the computer.

**Test the electrical outlet—**Ensure that the electrical outlet is working by testing it with another device, such as a lamp.

**Check the AC adapter—**Be sure that the power cable is firmly inserted into the electrical outlet and the green light on the AC adapter is on.

**Connect the computer directly to an electrical outlet—**Bypass power protection devices, power strips, and the extension cable to verify that the computer turns on.

**Check for interference—**Electrical appliances on the same circuit or operating near the computer can cause interference. Other causes of interference: power extension cables, too many devices on a power strip, or multiple power strips connected to the same electrical outlet.

**Adjust the Power Properties—**See the [Tell Me How](#) help file or search for the keyword *standby* in [Windows Help](#).

**Reseat the memory modules—**If your computer power light turns on but the display remains blank, you may need to [reset the memory modules](#).

---

## Start-Up Error Messages



**Operating system not found**— Contact Dell for technical assistance. See "Contacting Dell" in the Dell *Solutions Guide* that came with your computer for contact information.

**Insert bootable media**— The operating system is trying to boot to a nonbootable floppy disk or CD. Insert a bootable floppy disk or CD.

**Non-system disk error**— A floppy disk is in the floppy drive. Remove the floppy disk and restart the computer.

---

## Video and Display Problems

### If the display is blank

**Check the power light**— When the power light is lit or blinking, the computer has power. If the power light is blinking, the computer is in standby mode—press the power button to exit standby mode. If the power light is off, press the power button.

**Check the battery**— If you are using a battery to power your computer, the battery charge may be depleted. Connect the computer to an electrical outlet using the AC adapter, and turn on the computer.

**Test the electrical outlet**— Ensure that the electrical outlet is working by testing it with another device, such as a lamp.

**Check the AC adapter**— Be sure that the power cable is firmly inserted into the electrical outlet and the green light on the AC adapter is on.

**Adjust the power properties**— Search for the keyword *standby* in [Windows Help](#).

### If the display is difficult to read

**Adjust the brightness**— See the [Tell Me How](#) help file for instructions on adjusting the brightness.

**Move the subwoofer away from the computer or monitor**— If your external speaker system includes a subwoofer, ensure that the subwoofer is at least 60 cm (2 ft) away from the computer or external monitor.

**Eliminate possible interference**— Turn off nearby fans, fluorescent lights, or halogen lamps to check for interference.

**Rotate the computer to face a different direction**— Eliminate sunlight glare, which can cause poor picture quality.

**Restore the recommended settings**— Restore the original resolution and refresh rate settings. For more information, see the [Tell Me How](#) help file for instructions.

**Adjust the Windows display settings**—

1. Click the **Start** button, point to **Settings**, and then click **Control Panel**.
2. Double-click the **Display** icon and then click the **Settings** tab.
3. Try different settings for **Colors** and **Screen area**.

---

## Sound and Speaker Problems

### Integrated Speakers

**Adjust the Windows volume control**— Double-click the yellow speaker icon in the lower-right corner of your screen. Be sure that the volume is turned up and that the sound is not muted.

**Check the volume control buttons**— Press both volume control buttons simultaneously or press <Fn><End> to disable (mute) or reenable the integrated speakers.

**Reinstall the sound (audio) driver**— See "[Reinstalling Drivers and Utilities](#)."

### External Speakers

 **HINT:** The volume control in some MP3 players overrides the Windows volume setting. If you have been listening to MP3 songs, make sure that you did not turn the player volume down or off.

**Verify the speaker cable connections**— Ensure that the speakers are connected as shown on the setup diagram supplied with the speakers.

**Test the electrical outlet**— Ensure that the electrical outlet is working by testing it with another device, such as a lamp.

**Ensure that the speakers are turned on**— See the setup diagram supplied with the speakers.

**Adjust the speaker controls**— Adjust the volume, bass, or treble controls to eliminate distortion.

**Adjust the Windows volume control**— Double-click the yellow speaker icon in the lower-right corner of your screen. Be sure that the volume is turned up and that the sound is not muted.

**Test the speakers**— Plug the speaker audio cable into the headphone connector on the side of the computer. Ensure that

the headphone volume control is turned up. Play a music CD.
<b>Run the speaker self-test</b> — Some speaker systems have a self-test button on the subwoofer. See the speaker documentation for self-test instructions.
<b>Move the subwoofer away from the computer or monitor</b> — If your external speaker system includes a subwoofer, ensure that the subwoofer is at least 60 m (2 ft) away from the computer or external monitor.
<b>Eliminate possible interference</b> — Turn off nearby fans, fluorescent lights, or halogen lamps to check for interference.
<b>Reinstall the sound (audio) driver</b> — See " <a href="#">Reinstalling Drivers and Utilities</a> ."

## Printer Problems

### If you cannot print to a parallel port printer

<b>Verify the printer cable connections</b> — Ensure that the printer cable is connected (see "Connecting a Printer" in the Dell <i>Solutions Guide</i> that came with your computer).
<b>Test the electrical outlet</b> — Ensure that the electrical outlet is working by testing it with another device, such as a lamp.
<b>Ensure that the printer is turned on</b> — See the documentation supplied with the printer.
<b>Verify that the printer is recognized by Windows</b> —  <ol style="list-style-type: none"> <li>Click the <b>Start</b> button, point to <b>Settings</b>, and then click <b>Printers</b>.             If the printer is listed, right-click the printer icon, click <b>Properties</b>, and then select the <b>Details</b> tab.</li> <li>Ensure that the <b>Print to the following port</b>: setting is <b>LPT1 (Printer Port)</b>.</li> </ol>
<b>Reinstall the printer driver</b> — See "Installing the Printer Driver" in the Dell <i>Solutions Guide</i> that came with your computer.

### If you cannot print to a USB printer

<b>Verify the printer cable connections</b> — Ensure that the printer cable is connected correctly.
<b>Test the electrical outlet</b> — Ensure that the electrical outlet is working by testing it with another device, such as a lamp.
<b>Ensure that the printer is turned on</b> — See the documentation supplied with the printer.
<b>Verify that the printer is recognized by Windows</b> —  <ol style="list-style-type: none"> <li>Click the <b>Start</b> button, point to <b>Settings</b>, and then click <b>Printers</b>.             If the printer is listed, right-click the printer icon, click <b>Properties</b>, and then select the <b>Details</b> tab.</li> <li>Ensure that the <b>Print to the following port</b>: setting is <b>USB</b>.</li> </ol>
<b>Reinstall the printer driver</b> — See "Installing the Printer Driver" in the Dell <i>Solutions Guide</i> that came with your computer.

## Modem Problems

 **NOTICE:** Connect the modem to an analog telephone wall jack only. Connecting the modem to a digital telephone network damages the modem.

<b>Check the telephone jack</b> — Disconnect the telephone line from the modem and connect it to a telephone. Listen for a dial tone.
<b>Connect the modem directly to the telephone wall jack</b> — If you have other telephone devices sharing the line, such as an answering machine, fax machine, surge protector, or line splitter, then bypass them and connect the modem directly to the telephone wall jack with the telephone line.
<b>Check the connection</b> — Verify that the telephone line is connected to the modem.
<b>Check the telephone line</b> — Try using a different telephone line. If you are using a line that is 3 m (10 ft) or more in length, try a shorter one.
<b>Verify that the modem is communicating with Windows</b> —  <ol style="list-style-type: none"> <li>Click the <b>Start</b> button, point to <b>Settings</b>, and click <b>Control Panel</b>.</li> <li>In the <b>Control Panel</b> window, double-click <b>Modems</b>.             If there are multiple entries for the same modem or modems listed that are not installed, delete the entries and restart the computer.</li> <li>Click the <b>Diagnostics</b> tab.</li> <li>Click the COM port for your modem.</li> <li>Click <b>More Info</b> to verify that the modem is communicating with Windows.</li> </ol>

If all commands receive responses, the modem is operating properly.

---

## Scanner Problems

**Check the power cable connection**— Ensure that the scanner power cable is firmly connected to a working electrical power source and that the scanner is turned on.

**Check the scanner cable connection**— Ensure that the scanner cable is firmly connected to the computer and to the scanner.

**Unlock the scanner**— Ensure that your scanner is unlocked if it has a locking tab or button.

**Reinstall the scanner driver**— See the scanner documentation for instructions.

---

## Touch Pad Problems

**Check the touch pad settings**— Click the **Start** button, point to **Settings**, click **Control Panel**, and then double-click the **Mouse** icon. Try adjusting the settings.

---

## External Keyboard Problems

 **HINT:** If you connect an external PS/2 keyboard or keypad to the computer, the numeric keypad on the integrated keyboard is disabled. If you connect an external USB keyboard or keypad to the computer, the numeric keypad remains enabled.

**Disconnect the keyboard cable**— Shut down the computer. Disconnect the keyboard cable and check the cable connector for bent or broken pins.

---

## Unexpected Characters

**Disable the numeric keypad**— Press the <Num Lk> key to disable the numeric keypad. Verify that the numbers lock light is not lit.

---

## Drive Problems

 **HINT:** For information on saving files to a floppy disk, see the [Tell Me How](#) help file.

### If you cannot save a file to a floppy disk

**Ensure that Windows recognizes the drive**— Double-click the **My Computer** icon. If the floppy drive is not listed, perform a full scan with your antivirus software to check for and remove viruses. Viruses can sometimes prevent Windows from recognizing the drive.

**Cannot save files to a floppy disk**— Ensure that the floppy disk is not full or write-protected (locked). See the following figure.

**Test the drive with another floppy disk**— Insert another floppy disk to eliminate the possibility that the original floppy disk is defective.

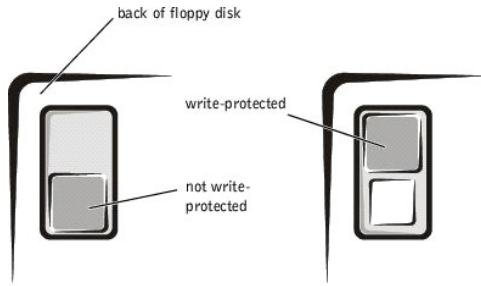

## If you cannot play a music CD or install a program from a CD

 **HINT:** High-speed CD drive vibration is normal and may cause noise. This noise does not indicate a defect in the drive or the CD.

**Ensure that Windows recognizes the drive—** Double-click the **My Computer** icon. If the CD drive is not listed, perform a full scan with your antivirus software to check for and remove viruses. Viruses can sometimes prevent Windows from recognizing the drive.

**Test the drive with another CD—** Insert another CD to eliminate the possibility that the original CD is defective.

**Clean the disc—** See the [Tell Me How](#) help file for instructions.

**Adjust the Windows volume control—** Double-click the yellow speaker icon in the lower-right corner of your screen. Be sure that the volume is turned up and that the sound is not muted.

**If you have one CD in the fixed optical drive and one CD in the media bay drive—** Identify which CD is not playing:

1. Double-click the **My Computer** icon on your desktop.
2. Double-click the drive letter of the device the you are verifying.

## If you cannot play a DVD movie

 **HINT:** Because of different worldwide file types, not all DVD titles work in all DVD drives.

**Ensure that Windows recognizes the drive—** Double-click the **My Computer** icon. If the DVD drive is not listed, perform a full scan with your antivirus software to check for and remove viruses. Viruses can sometimes prevent Windows from recognizing the drive.

**Test the drive with another DVD—** Insert another DVD to eliminate the possibility that the original DVD is defective.

**Clean the disc—** See the [Tell Me How](#) help file for instructions.

## If the CD-RW drive stops writing

 **HINT:** If you must disable standby mode to write to a CD-RW drive, remember to enable standby mode again when you finish writing the CD.

**Disable standby mode in Windows before writing to a CD-RW disk—** Search for the keyword *standby* in [Windows Help](#).

**Change the write speed to a slower rate—** The CD-RW drive must receive a steady stream of data when writing. If the stream is interrupted, an error occurs. Closing all programs before writing to the CD-RW may also alleviate the problem.

## If you have a hard drive problem

**Check the hard drive for errors—**

*Windows Me:*

Click the **Start** button, point to **Programs**—> **Accessories**—> **System Tools**, and then click **ScanDisk**.

*Windows 2000:*

1. Double-click the **My Computer** icon.
2. Right-click the **Local Disk** icon and then click **Properties**.
3. Click the **Tools** tab.
4. Click **Check Now**.

## Network Problems

**Check the network cable connector**— Ensure that the network cable connector is firmly connected to the connector on the computer and the network wall jack.

**Check the network lights on the network connector**— Green indicates that the network connection is active. If the status light is not green, try replacing the network cable. Amber indicates that the network card driver is loaded and the card is detecting activity.

**Restart the computer**— Try to log on to the network again.

**Contact your network administrator**— Verify that your network settings are correct and that the network is functioning.

---

## Windows® Error Messages

**x:\ is not accessible. The device is not ready**— Insert a disk into the drive and try again.

**A filename cannot contain any of the following characters: \ / : \* ? " < > |**— Do not use these characters in filenames.

**Not enough memory or resources. Close some programs and try again**— You have too many programs open. Close all windows and open the program that you want to use.

**The file being copied is too large for the destination drive**— The file that you are trying to copy is too large to fit on the disk, or the disk is too full. Try copying the file to a different disk or use a larger capacity disk.

**A required .DLL file was not found**— The program that you are trying to open is missing an essential file. To remove and then reinstall the program:

*Windows Me:*

1. Click the **Start** button, point to **Settings**, and then click **Control Panel**.
2. Double-click the **Add/Remove Programs** icon.
3. Select the program that you want to remove.
4. Click **Add/Remove** and follow the prompts on the screen.
5. See the program documentation for installation instructions.

*Windows 2000:*

1. Click the **Start** button, point to **Settings**, and then click **Control Panel**.
  2. Double-click the **Add/Remove Programs** icon.
  3. Select the program that you want to remove.
  4. Click **Change/Remove** and follow the prompts on the screen.
  5. See the program documentation for installation instructions.
- 

## General Program Problems

### A program crashes

**See the software documentation**— Many software manufacturers maintain websites with information that may help you to solve the problem.

### A program stops responding

**Press <Ctrl><Alt><Del>**— In the **Close Program** window, select the program that is no longer responding. Then click **End Task**.

### A solid blue screen appears

**Turn the computer off**— If the computer does not respond to a keystroke or a proper shutdown, press the power button until the computer turns off. Press the power button again to restart the computer. The solid blue screen appears because you were not able to perform a proper Windows shutdown. ScanDisk will automatically run during the start-up process. Follow the instructions on the screen.

---

## E-Mail Problems

**Review "Sending and Receiving E-mail"**— See "Setting Up" in the Dell *Solutions Guide* that came with your computer.

**Ensure that you are connected to the Internet**— With the Outlook Express e-mail program open, click **File**. If **Work Offline** has a check next to it, click the check to remove it and connect to the Internet.

---

## If Your Computer Gets Wet

 **CAUTION:** Perform this procedure only after you are certain that it is safe to do so. If the computer is connected to an electrical outlet, Dell recommends that you turn off AC power at the circuit breaker before attempting to remove the power cables from the electrical outlet. Use the utmost caution when removing wet cables from a live power source.

1. Turn off the computer, disconnect the AC adapter from the computer, and disconnect the AC adapter from the electrical outlet.
2. Turn off any attached external devices, and disconnect them from their power sources and then from the computer.
3. Ground yourself by touching one of the metal connectors on the back of the computer.
4. Remove the media bay device and any installed PC Cards, and put them in a safe place to dry.
5. Remove the [battery](#).
6. Wipe off the battery and put it in a safe place to dry.
7. Remove the [hard drive](#).
8. Remove the [memory modules](#).
9. Open the display and place the computer right-side up across two books or similar props to let air circulate all around it. Let the computer dry for at least 24 hours in a dry area at room temperature.

 **NOTICE:** Do not use artificial means, such as a hair dryer or a fan, to speed the drying process.

 **CAUTION:** To help prevent electrical shock, verify that the computer is thoroughly dry before continuing with the remainder of this procedure.

10. Ground yourself by touching one of the metal connectors on the back of the computer.
11. Replace the [memory modules](#), the memory module cover, and the screw.
12. Replace the [hard drive](#).
13. Replace the media bay device and any PC Cards you removed.
14. Replace the battery, and connect the computer to an electrical outlet.
15. Turn on the computer and verify that it is working properly.

If the computer does not start, or if you cannot identify the damaged components, contact Dell for technical assistance. See "Contacting Dell" in the Dell *Solutions Guide* that came with your computer for contact information.

---

## If You Drop or Damage Your Computer

1. Save and close any open files, exit any open programs, and shut down the computer.
2. Disconnect the AC adapter from the computer, and disconnect the AC adapter from the electrical outlet.
3. Turn off any attached external devices, and disconnect them from their power sources and then from the computer.
4. Remove and reinstall the battery.
5. Turn on the computer.

If the computer does not turn on, or if you cannot identify the damaged components, contact Dell for technical assistance. See "Contacting Dell" in the Dell *Solutions Guide* that came with your computer for contact information.

---

## Resolving Other Technical Problems

**Go to the Dell support website**— Go to <http://support.dell.com> for help with general usage, installation, and troubleshooting questions.

**E-mail Dell**— Go to <http://support.dell.com> and then click **E-Mail Dell** in the **Communicate** list. Send an e-mail message to Dell about your problem; you can expect to receive an e-mail message from Dell within hours.

**Call Dell**— If you cannot solve your problem using the Dell support website or e-mail service, contact Dell for technical assistance. See "Contacting Dell" in the Dell *Solutions Guide* that came with your computer for contact information.

---

[Back to Contents Page](#)

[Back to Contents Page](#)

## System Specifications

Dell™ Inspiron™ 8100

- [Microprocessor](#)
- [System Information](#)
- [PC Card](#)
- [Memory](#)
- [Ports and Connectors](#)
- [Video](#)
- [Audio](#)
- [Display](#)
- [Keyboard](#)
- [Touch Pad](#)
- [Track Stick](#)
- [Modem](#)
- [Battery](#)
- [AC Adapter](#)
- [Environmental](#)
- [Fixed Optical Drives](#)

Microprocessor	
Microprocessor type	Intel® Mobile Pentium® III processor-M
L1 cache	32 KB (internal)
L2 cache	512 KB
Math coprocessor	internal to microprocessor

System Information	
System chip set	Intel 815EP
Data bus width	64 bits
DRAM bus width	64 bits
Microprocessor address bus width	32 bits
Flash EPROM	4 Mb
Graphics bus width	32-bit AGP 4X cable bus

PC Card	
CardBus controller	Texas Instruments PCI 4450/4451 CardBus controller
PC Card connectors	two (supports two Type I or Type II cards or one Type III card)
Cards supported	3.3 V and 5 V
PC Card connector size	68 pins
Data width (maximum)	PCMCIA 16 bits CardBus 32 bits

Memory	
Architecture	SDRAM
Memory module connector	two user-accessible SODIMM sockets
Memory module capacities	64-, 128-, and 256-MB 3.3-V SDRAM SODIMMS
Standard memory	64 MB (non-ECC)
Maximum memory	512 MB (non-ECC)
Memory clock speed	133 MHz
Memory access time	CL2 or CL3 ( <i>NOTE: CL2 and CL3 indicate a CAS latency of two and three clocks, respectively.</i> )

Ports and Connectors	
Serial	9-pin connector; 16550C-compatible, 16-byte buffer connector
Parallel	unidirectional (standard AT), bidirectional, or ECP connector
Video	VGA connector
Audio	stereo (line-in) mini connector; microphone mini connector; headphone/speakers (line-out) mini



	connector
PS/2 keyboard/mouse	6-pin mini-DIN connector
USB	two USB-compliant connectors
Infrared	sensor compatible with both IrDA Standard 1.1 (Fast IR) and IrDA Standard 1.0 (Slow IR)
Docking	200-pin connector for Dell advanced port replicator
S-video TV-out	7-pin mini-DIN connector for S-video, composite video, and S/PDIF (TV/digital audio adapter cable supports composite video and S/PDIF)
Modem/network adapter	optional factory-configurable RJ-11/RJ-45 combination port for Mini PCI card modem/ network adapter
IEEE 1394	4-pin serial connector

<b>Video</b>	
Video type	256-bit hardware-accelerated video support
Data bus	4X AGP
Video controller	NVIDIA GeForce2 Go™
Video memory	16 MB and 32 MB (maximum)
LCD interface	LVDS
TV support	NTSC or PAL in S-video and composite modes

<b>Audio</b>	
Audio controller	ESS Technology Maestro-3i
Stereo conversion	16 bit (analog-to-digital and digital-to-analog)
Interfaces:	
Internal	PCI bus/AC 97
External	stereo (line-in), microphone, headphones/speaker (line-out)

<b>Display</b>	
Type	256-bit hardware-accelerated video support
Response time (typical)	50 ms
Operating angle	0° (closed) to 180°
Dot pitch	0.20 mm
Panel (typical)	1.3 W
Backlight	3.4 W using battery; 4.9 W using AC adapter
Controls	brightness can be controlled through key combinations

<b>Keyboard</b>	
Number of keys	87 (U.S., Canada, and locations that use traditional Chinese); 88 (Europe); 90 (Japan)
Key travel	2.7 ± 0.3 to 0.4 mm (0.11 ± 0.016 inch)
Key spacing	19.05 ± 0.3 mm (0.75 inch ± 0.012 inch)
Layout	QWERTY/AZERTY/Kanji

<b>Touch Pad</b>	
Interface	PS/2 compatible
X/Y position resolution (graphics table mode)	240 cpi
Size:	
Thickness	2.00 mm (0.08 inch) at highest component
Width	64.88 mm (2.55 inch)
Height	48.88-mm (1.92-inch) rectangle with 0.5-mm (0.02-inch) tabs
Weight	6.5 g (0.23 ounce) ± 0.5 g (0.001 ounce)

Power:	
Supply voltage	5 V ± 0.5 VDC
Supply current	25 mA (maximum operating current) for track stick and touch pad combined
ESD	in accordance with IEC-801-2

<b>Track Stick</b>	
Interface	PS/2 compatible
X/Y position resolution (graphics table mode)	250 count/sec @ 100 gf
Size	protrudes 0.5 mm higher than surrounding key caps
Power:	
Supply voltage	5 V ± 0.5 VDC
Supply current	25 mA (maximum operating current) for track stick and touch pad combined
ESD	in accordance with IEC-801-2

<b>Modem</b>	
Data/fax modem	optional 56K, V.90 Mini PCI card modem
Data/fax network adapter	optional 10/100 LAN + 56K, V.90 Mini PCI card modem

<b>Battery</b>	
Type	8-cell lithium ion (dual battery support is available via the media bay)
Dimensions:	
Depth	88.5 mm (3.48 inches)
Height	21.5 mm (0.83 inch)
Width	139.0 mm (5.47 inches)
Weight	8 cell; 0.39 kg (0.87 lb)
Voltage	14.8 VDC
Charge time (approximate):	
Computer on	2.5 hours
Computer off	1 hour
Battery life	approximately 2-3 hours minimum with 8-cell standard battery
Life span (approximate)	400 discharge/charge cycles <sup>0</sup>
Temperature range:	
Operating	0° to 45°C (32° to 113°F)
Storage	-20° to 60°C (-4° to 140°F)

<b>AC Adapter</b>	
Input voltage	90 to 135 VAC and 164 to 264 VAC
Input current (maximum)	1.5 A
Input frequency	40 to 63 Hz
Output current	4.5 A (maximum 4-second pulse); 3.5 A (continuous)
Rated output voltage	20 VDC
Dimensions:	
Height	27.94 mm (1.1 inches)
Width	58.42 mm (2.3 inches)
Depth	133.85 mm (5.25 inches)
Weight (with cables)	0.4 kg (0.9 lb)
Temperature range:	
Operating	0° to 40°C (32° to 104°F)
Storage	-40° to 65°C (-40° to 149°F)

<b>Environmental</b>	
Temperature range:	
Operating	0° to 35°C (32° to 95°F)
Storage	-40° to 65°C (-40° to 149°F)
Relative humidity (maximum):	
Operating	10% to 90% (noncondensing)
Storage	5% to 95% (noncondensing)
Maximum vibration:	
Operating	0.9 GRMS using a random-vibration spectrum that simulates user environment
Storage	1.3 GRMS using a random-vibration spectrum that simulates air/truck shipment
Maximum shock:	
Operating	1.524 cm/sec (60 inches/sec) (equal to a half-sine pulse width of 2 ms)
Storage	2.03 m/sec (80 inches/sec) (less than or equal to a pulse width of 2 ms)
Altitude (maximum):	
Operating	-15.2 to 3048 m (-50 to 10,000 ft)
Storage	-15.2 to 10,668 m (-50 to 35,000 ft)

<b>Fixed Optical Drives</b>	
Supported drives	12.5-mm drives: CD, CD-RW, and DVD

---

[Back to Contents Page](#)

[Back to Contents Page](#)

## A Tour of Your Computer

**Dell™ Inspiron™ 8100**

- [Front View](#)
  - [Left Side View](#)
  - [Right Side View](#)
  - [Back View](#)
- 

### Front View



### Display Latch

This latch keeps the display locked in place when the display is closed.



### Display

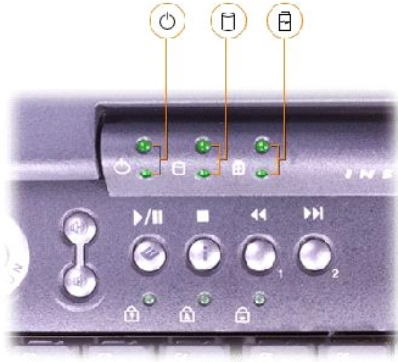

The computer has a color LCD.

### Device Status Lights



The lights below the display indicate the following:

- 1 The light labeled  turns on when the computer is turned on and blinks when the computer is in standby mode.
- 1 The light labeled  turns on when the computer reads data from or writes data to the hard drive.
- 1 The light labeled  turns on steadily or blinks to indicate the battery charge status. Indicator states include:
  - o Off, which indicates that the computer is operating on an adequately charged battery or that the computer is turned off
  - o Flashing green, which indicates that the battery is fully charged
  - o Solid green, which indicates that the battery is charging
  - o Flashing orange, which indicates that the battery charge is low
  - o Solid orange, which indicates that the battery charge is critically low

 **NOTICE:** To avoid data loss, never turn off the computer while the green light labeled  is flashing.

## Air Intake

 **HINT:** The computer turns on the fans only when the computer gets hot. They may run most of the time or very seldom, depending on your use of the computer. Because the fans spin at a high rate of speed, they may make a noise. This noise is normal and does not indicate a problem with the fans or the computer.

The fans work with the air intakes to prevent the computer from overheating. When the computer gets hot, the small internal fans turn on and draw air through the air intakes to cool the computer. Hot air is expelled through the [fan exhausts](#).

 **CAUTION:** Do not push objects into or block the air intakes. Doing so can cause fire or damage the interior components. Keep the openings free from dust and other foreign particles.

## Keyboard Status Lights

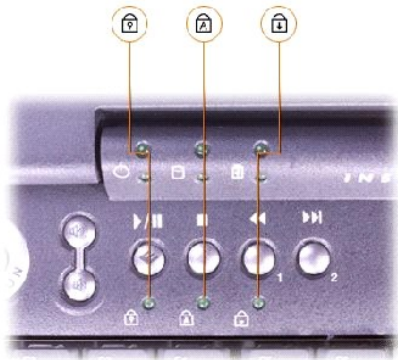

The green lights located above the keyboard indicate the following:

- 1 The light labeled  turns on when you press  to enable the numeric keypad.
- 1 The light labeled  turns on when you press  to enable the uppercase letter function.
- 1 The light labeled  turns on when you press   to enable the scroll lock function.

## Track Stick

The track stick detects the pressure and movement of your finger for moving the cursor on the display and, along with the track stick buttons, provides full mouse functionality.

## Touch Pad

The touch pad detects the position of your finger over a touch-sensitive area and provides the computer with full mouse functionality.

## Battery Bay

With a charged battery in this bay, you can use the computer without plugging it in to an electrical outlet.

## Media Bay

You can install devices such as a CD drive, DVD drive, CD-RW and CD-R drive, second battery, or Dell TravelLite™ travel module in the media bay.

## Touch Pad/Track Stick Buttons

These buttons correspond to the left and right buttons on a standard mouse.

## Keyboard

The keyboard includes a numeric keypad as well as the Microsoft® Windows® logo key that supports the Windows operating systems.

## Power Button

 **HINT:** To turn off your computer, perform a Windows shutdown.

Press the power button to turn on the computer or to initiate standby mode.

If the computer stops responding, press and hold the power button until the computer turns off completely (this may take several seconds).

## Microphone

The internal microphone allows you to record voice audio.

## Volume Control Buttons

Increase or decrease the speaker volume with the volume control buttons. You can also change the speaker volume using key combinations:

- 1 To increase the volume press, the <Fn> and the <Page Up> keys.

- 1 To decrease the volume, press the <Fn> and the <Page Dn> keys.
- 1 To enable or disable (mute) the integrated stereo speakers or external speakers, press both of the volume control buttons simultaneously.

**HINT:** If no sound comes from the speakers, press <Fn> and <End> and check the volume control buttons to make sure that the sound is not disabled.

When you mute music, the computer may take a moment to respond.

## Dell™ AccessDirect™ Buttons

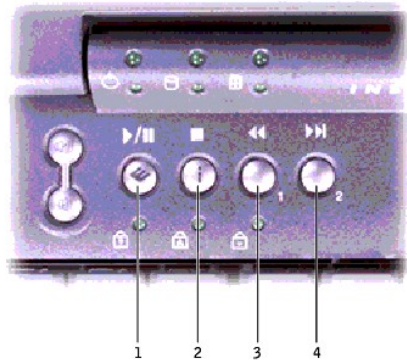

**HINT:** To launch the Dell Solution Center, the computer must be turned on and functioning properly.

- 1 Press this button to launch the Dell Solution Center, where you can find support and educational tools that Dell has installed on your computer.
- 2 Press this button to launch your default Internet browser.
- 3 Press this button to launch <http://www.dell.com>, or reprogram the button to launch a program of your choice.
- 4 Press this button to open your default e-mail program, or reprogram the button to launch a program of your choice.

You can also reprogram the button scheme to control CD or DVD player functions.

---

## Left Side View



## Security Cable Slot

The slots (one on each side of the computer) let you attach a commercially available antitheft device to the computer. Complete instructions for installing antitheft devices are usually included with the device.

**NOTICE:** Antitheft devices are of differing designs. Before you buy one, make sure it will work with the security cable slot in the computer.

## Speakers

Your computer has integrated speakers. Press the [volume control buttons](#) to adjust the speaker volume.

## S-Video TV-Out Connector

Use this connector to connect your computer to a television. If you have a TV/digital audio adapter cable, you can also connect composite video cables and S/PDIF devices to this connector.



## Fixed Optical Drive

Your computer supports a CD drive, DVD drive, or CD-RW drive.

---

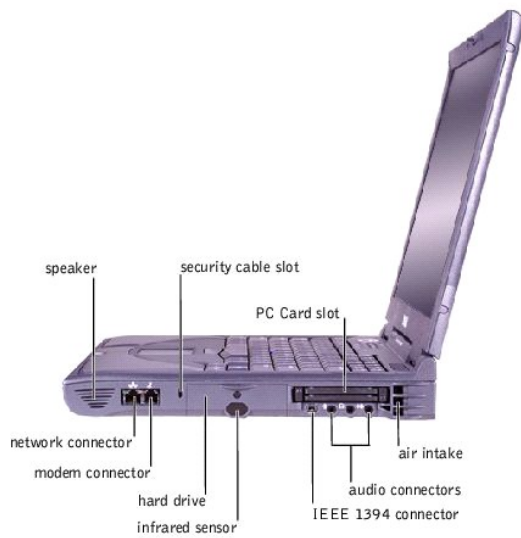

## Right Side View



## Audio Connectors





- 1 Attach record/playback devices such as a cassette player or CD player to the  connector.
- 1 Attach headphones or speakers to the  connector.
- 1 Attach a microphone to the  connector.

## IEEE 1394 Connector

Use this connector to attach IEEE 1394-compatible devices such as a digital camera to your computer.



## Infrared Sensor

The infrared sensor lets you transfer files from the computer to another infrared device without using cable connections.

 **HINT:** The infrared sensor does not function when the computer is connected to a port replicator.



## Hard Drive

The hard drive reads and writes data on a hard disk.

## Modem Connector



If you ordered the optional internal modem, use this connector to plug in the telephone connector.

## Network Connector



If you ordered the optional integrated network adapter, use this connector to connect the computer to a network.

## Security Cable Slot



The slots (one on each side of the computer) let you attach a commercially available antitheft device to the computer. Complete instructions for installing antitheft devices are usually included with the device.

**NOTICE:** Antitheft devices are of differing designs. Before you buy one, make sure it works with the security cable slot in the computer.

## PC Card Slot

The PC Card slot has two connectors that support various types of PC Cards, including modems and network adapters.

---

## Back View

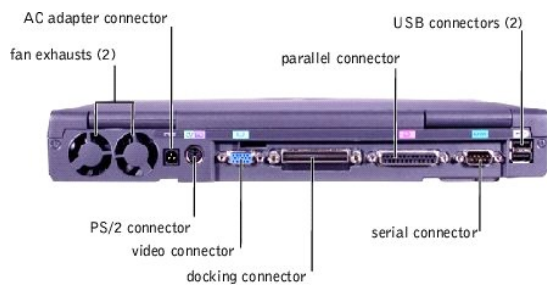

## Fan Exhausts

**HINT:** The computer turns on the fan only when the computer gets hot. It may run most of the time or very seldom, depending on your use of the computer. Because the fan spins at a high rate of speed, it may make a noise. This noise is normal and does not indicate a problem with the fan or the computer.

The fan works with the air intake to prevent the computer from overheating. When the computer gets hot, the small internal fan turns on and draws air through the air intake to cool the computer. Hot air is expelled through the fan exhaust.

**CAUTION:** Do not push objects into or block the air intake. Doing so can cause fire or damage interior components. Keep the opening free from dust and other foreign particles.

## AC Adapter Connector

Use this connector to attach an AC adapter to the computer.



**HINT:** Although the AC adapter works worldwide, power connectors vary among countries. Before using the AC adapter in a foreign country, you may need to obtain a new power cable designed for use with the electrical outlets in that country.

The AC adapter converts AC power to the DC power required by the computer. You can connect the AC adapter with your computer either turned on or off.

**NOTICE:** When you disconnect the AC adapter from the computer, grasp the adapter cable connector, not the cable itself, and pull firmly but gently to avoid damaging the cable.

## Parallel Connector



Use this connector to attach a parallel device, such as a printer, to the computer.

## USB Connectors



Use these connectors to attach USB-compatible devices such as a mouse, keyboard, printer, or scanner to your computer.

## Serial Connector



Use this connector to attach a serial device to the computer.

**HINT:** The port replicator may not be available in certain countries. Refer to the documentation that came with your port replicator for instructions on attaching external devices to the port replicator and connecting your computer to it.

## Docking Connector



Use this connector to attach your computer to the optional port replicator. A port replicator allows you to easily use an external keyboard, mouse, and monitor with your computer. An advanced port replicator also includes a network connector for connecting your computer to a network.

## Video Connector



Use this connector to attach an external monitor to the computer.

## PS/2 Connector



Use this connector to attach PS/2-compatible devices such as a mouse, keyboard, or external numeric keypad to your computer.

---

[Back to Contents Page](#)