

# Dell™ Portable Computers

# Owner's Manual

**Model PP19L**

## Notes, Notices, and Cautions



**NOTE:** A NOTE indicates important information that helps you make better use of your computer.



**NOTICE:** A NOTICE indicates either potential damage to hardware or loss of data and tells you how to avoid the problem.



**CAUTION:** A CAUTION indicates a potential for property damage, personal injury, or death.

## Abbreviations and Acronyms

For a complete list of abbreviations and acronyms, see the "Glossary" on page 163.

If you purchased a Dell™ n Series computer, any references in this document to Microsoft® Windows® operating systems are not applicable.

---

**Information in this document is subject to change without notice.**

**© 2005 Dell Inc. All rights reserved.**

Reproduction in any manner whatsoever without the written permission of Dell Inc. is strictly forbidden.

Trademarks used in this text: *Dell*, the *DELL* logo, *Inspiron*, *Dell Precision*, *Dimension*, *DellNet*, *OptiPlex*, *Latitude*, *PowerEdge*, *PowerConnect*, *PowerVault*, *PowerApp*, *Dell Travellite*, *ExpressCharge*, and *Strike Zone* are trademarks of Dell Inc.; *Intel*, *Celeron*, and *Penitium* are registered trademarks of Intel Corporation; *Microsoft*, *Outlook*, and *Windows* are registered trademarks of Microsoft Corporation; *Bluetooth* is a registered trademark owned by Bluetooth SIG, Inc. and is used by Dell under license; *IBM* is a registered trademark of International Business Machines Corporation; *EMC* is a registered trademark of EMC Corporation; *ENERGY STAR* is a registered trademark of the U.S. Environmental Protection Agency.

Other trademarks and trade names may be used in this document to refer to either the entities claiming the marks and names or their products. Dell Inc. disclaims any proprietary interest in trademarks and trade names other than its own.

Model PP19L

October 2005 Rev. A02

# Contents

	<b>Finding Information</b> . . . . .	<b>11</b>
<b>1</b>	<b>A Tour of Your Computer</b>	
	<b>Front View</b> . . . . .	<b>15</b>
	<b>Left Side View</b> . . . . .	<b>19</b>
	<b>Right Side View</b> . . . . .	<b>21</b>
	<b>Back View</b> . . . . .	<b>22</b>
	<b>Bottom View</b> . . . . .	<b>23</b>
<b>2</b>	<b>Setting Up Your Computer</b>	
	<b>Connecting to the Internet</b> . . . . .	<b>25</b>
	Setting Up Your Internet Connection . . . . .	25
	<b>Transferring Information to a New Computer</b> . . . . .	<b>26</b>
	Running the Files and Settings Transfer Wizard With the Operating System CD . . . . .	27
	Running the Files and Settings Transfer Wizard Without the Operating System CD . . . . .	27
	<b>Setting Up a Printer</b> . . . . .	<b>29</b>
	Printer Cable . . . . .	29
	Connecting a USB Printer . . . . .	30
	<b>Power Protection Devices</b> . . . . .	<b>30</b>
	Surge Protectors . . . . .	31
	Line Conditioners . . . . .	31
	Uninterruptible Power Supplies . . . . .	31

3	Using the Display	
	<b>Adjusting Brightness</b> . . . . .	33
	<b>Switching the Video Image</b> . . . . .	33
	<b>Setting Display Resolution</b> . . . . .	34
4	Using the Keyboard and Touch Pad	
	<b>Numeric Keypad</b> . . . . .	35
	<b>Key Combinations</b> . . . . .	36
	System Functions . . . . .	36
	Battery . . . . .	36
	CD or DVD Tray . . . . .	36
	Display Functions . . . . .	36
	Radios (Including Wireless Networking and an Internal Card With Bluetooth® Wireless Technology) . . . . .	36
	Power Management . . . . .	37
	Speaker Functions . . . . .	37
	Microsoft® Windows® Logo Key Functions . . . . .	37
	<b>Touch Pad</b> . . . . .	38
	Customizing the Touch Pad . . . . .	38
5	Power Management	
	<b>Power Management Tips</b> . . . . .	39
	<b>Power Management Wizard</b> . . . . .	39
	Setting Sleep Modes . . . . .	39
	Selecting a Power Scheme . . . . .	40
	Setting Battery Alarms and Actions . . . . .	41
	Completing the Power Management Wizard . . . . .	41
	<b>Power Management Modes</b> . . . . .	41
	Standby Mode . . . . .	41
	Hibernate Mode . . . . .	42
	<b>Power Options Properties</b> . . . . .	42
	Power Schemes Tab . . . . .	42
	Alarms Tab . . . . .	43



Power Meter Tab . . . . .	43
Advanced Tab . . . . .	43
Hibernate Tab . . . . .	44
<b>Dell™ QuickSet Features . . . . .</b>	<b>44</b>
Clicking the QuickSet Icon . . . . .	44
Double-Clicking the QuickSet Icon . . . . .	44
Right-Clicking the QuickSet Icon . . . . .	44
<b>6 Using a Battery</b>	
<b>Battery Types . . . . .</b>	<b>45</b>
<b>Battery Performance . . . . .</b>	<b>45</b>
<b>Checking the Battery Charge . . . . .</b>	<b>46</b>
Dell™ QuickSet Battery Meter . . . . .	46
Microsoft® Windows® Power Meter . . . . .	46
Charge Gauge . . . . .	47
Health Gauge . . . . .	47
Low-Battery Warning . . . . .	47
<b>Charging the Battery . . . . .</b>	<b>47</b>
<b>Storing a Battery . . . . .</b>	<b>48</b>
<b>7 Using CDs, DVDs, and Other Multimedia</b>	
<b>Playing a CD or DVD . . . . .</b>	<b>49</b>
<b>Adjusting the Volume . . . . .</b>	<b>51</b>
<b>Adjusting the Picture . . . . .</b>	<b>52</b>
<b>Copying CDs and DVDs. . . . .</b>	<b>52</b>
How to Copy a CD or DVD. . . . .	52
Using Blank CDs and DVDs. . . . .	53
Helpful Tips . . . . .	54
<b>Using Dell MediaDirect . . . . .</b>	<b>54</b>
<b>Connecting Your Computer to a TV or Audio Device . . . . .</b>	<b>55</b>
S-Video and Standard Audio . . . . .	56
S-Video and S/PDIF Digital Audio. . . . .	58

Composite Video and Standard Audio . . . . .	60
Composite Video and S/PDIF Digital Audio . . . . .	62
Enabling S/PDIF Digital Audio . . . . .	64
Setting Up the Cyberlink (CL) Headphones . . . . .	65
Enabling the Display Settings for a TV . . . . .	66
<b>8 Using ExpressCards</b>	
<b>ExpressCard Types</b> . . . . .	<b>67</b>
<b>ExpressCard Blanks</b> . . . . .	<b>67</b>
<b>Installing an ExpressCard</b> . . . . .	<b>67</b>
<b>Removing an ExpressCard or Blank</b> . . . . .	<b>68</b>
<b>9 Using the 5-in-1 Media Memory Card Reader</b>	
<b>Media Memory Card Types</b> . . . . .	<b>71</b>
<b>Media Memory Card Blanks</b> . . . . .	<b>71</b>
<b>Installing a Media Memory Card</b> . . . . .	<b>71</b>
<b>Removing a Media Memory Card or Blank</b> . . . . .	<b>72</b>
<b>10 Setting Up a Home and Office Network</b>	
<b>Connecting to a Network Adapter</b> . . . . .	<b>73</b>
Network Setup Wizard . . . . .	73
<b>Connecting to a Wireless Local Area Network</b> . . . . .	<b>74</b>
Determining Your Network Type . . . . .	74
Connecting to a Wireless Network in Microsoft® Windows® XP . . . . .	74
<b>11 Solving Problems</b>	
<b>Dell Diagnostics</b> . . . . .	<b>77</b>
<b>Drive Problems</b> . . . . .	<b>80</b>
CD and DVD drive problems . . . . .	81
If you cannot eject the CD, CD-RW, DVD, or DVD+RW drive tray . . . . .	81

If you hear an unfamiliar scraping or grinding sound . . . . .	81
Hard drive problems . . . . .	81
<b>E-Mail, Modem, and Internet Problems . . . . .</b>	<b>82</b>
<b>Error Messages . . . . .</b>	<b>83</b>
<b>IEEE 1394 Device Problems . . . . .</b>	<b>87</b>
<b>Keyboard Problems . . . . .</b>	<b>87</b>
External Keyboard problems . . . . .	87
Unexpected characters. . . . .	88
<b>Lockups and Software Problems . . . . .</b>	<b>88</b>
The computer does not start up . . . . .	88
The computer stops responding . . . . .	88
A program stops responding or crashes repeatedly. . . . .	88
A program is designed for an earlier Microsoft® Windows® operating system . . . . .	89
A solid blue screen appears . . . . .	89
Dell MediaDirect problems . . . . .	89
Other software problems . . . . .	90
<b>Memory Problems . . . . .</b>	<b>90</b>
<b>Network Problems . . . . .</b>	<b>91</b>
<b>ExpressCard Problems . . . . .</b>	<b>91</b>
<b>Power Problems . . . . .</b>	<b>91</b>
Ensuring Sufficient Power for Your Computer . . . . .	92
<b>Printer Problems . . . . .</b>	<b>92</b>
<b>Scanner Problems . . . . .</b>	<b>93</b>
<b>Sound and Speaker Problems . . . . .</b>	<b>94</b>
No sound from integrated speakers . . . . .	94
No sound from external speakers . . . . .	94
No sound from headphones . . . . .	94
<b>Touch Pad or Mouse Problems . . . . .</b>	<b>95</b>
<b>Video and Display Problems . . . . .</b>	<b>95</b>
If the display is blank . . . . .	95
If the display is difficult to read. . . . .	96
If only part of the display is readable. . . . .	96

<b>Drivers</b> . . . . .	<b>96</b>
What Is a Driver? . . . . .	96
Identifying Drivers . . . . .	97
Reinstalling Drivers and Utilities . . . . .	97
<b>Resolving Software and Hardware Incompatibilities</b> . . . . .	<b>99</b>
<b>Restoring Your Operating System</b> . . . . .	<b>99</b>
Using Microsoft Windows XP System Restore . . . . .	100
Using Dell PC Restore by Symantec . . . . .	101
Using the Operating System CD. . . . .	103

## 12 Adding and Replacing Parts

<b>Before You Begin</b> . . . . .	<b>105</b>
Recommended Tools . . . . .	105
Turning Off Your Computer . . . . .	105
Before Working Inside Your Computer . . . . .	106
<b>Battery</b> . . . . .	<b>108</b>
Removing a Battery . . . . .	108
Installing a Battery . . . . .	108
<b>Hard Drive</b> . . . . .	<b>108</b>
Returning a Hard Drive to Dell . . . . .	111
<b>Optical Drives</b> . . . . .	<b>111</b>
About the Device Security Screw . . . . .	111
Removing and Installing Optical Drives . . . . .	111
<b>Memory</b> . . . . .	<b>112</b>
Installing a Memory Module in Connector DIMM B . . . . .	113
Installing a Memory Module in Connector DIMM A . . . . .	115
<b>Modem (Optional)</b> . . . . .	<b>119</b>
<b>Wireless Mini PCI Card</b> . . . . .	<b>121</b>
<b>Hinge Cover</b> . . . . .	<b>123</b>
Removing the Hinge Cover . . . . .	123
Replacing the Hinge Cover . . . . .	125

<b>Keyboard</b> . . . . .	<b>125</b>
Removing the Keyboard . . . . .	126
Replacing the Keyboard . . . . .	127
<b>Internal Card With Bluetooth® Wireless Technology</b> . . . . .	<b>127</b>
<b>Coin-Cell Battery</b> . . . . .	<b>128</b>
Removing the Coin-Cell Battery . . . . .	128
Replacing the Coin-Cell Battery . . . . .	129

## 13 Appendix

<b>Specifications</b> . . . . .	<b>131</b>
<b>Using the System Setup Program</b> . . . . .	<b>137</b>
Overview . . . . .	137
Viewing the System Setup Screen . . . . .	137
System Setup Screen . . . . .	138
Commonly Used Options . . . . .	138
<b>Computer Tracking Software</b> . . . . .	<b>139</b>
<b>Traveling With Your Computer</b> . . . . .	<b>139</b>
Identifying Your Computer . . . . .	139
Packing the Computer . . . . .	139
Travel Tips . . . . .	140
Traveling by Air . . . . .	140
If Your Computer Is Lost or Stolen . . . . .	141
<b>Cleaning Your Computer</b> . . . . .	<b>141</b>
Computer, Keyboard, and Display . . . . .	141
Touch Pad . . . . .	142
Floppy Drive . . . . .	142
CDs and DVDs . . . . .	142
<b>FCC Notices (U.S. Only)</b> . . . . .	<b>142</b>
Class A . . . . .	143
Class B . . . . .	143
FCC Identification Information . . . . .	144
<b>Macrovision Product Notice</b> . . . . .	<b>144</b>

<b>Dell Technical Support Policy (U.S. Only)</b> . . . . .	<b>144</b>
Definition of "Dell-Installed" Software and Peripherals . . . . .	144
Definition of "Third-Party" Software and Peripherals. . . . .	145
<b>Contacting Dell.</b> . . . .	<b>145</b>
Glossary . . . . .	163
Index . . . . .	175

# Finding Information

 **NOTE:** Some features or media may be optional and may not ship with your computer. Some features or media may not be available in certain countries.

 **NOTE:** Additional information may ship with your computer.

---

## What Are You Looking For?

- A diagnostic program for my computer
- Drivers for my computer
- My device documentation
- Notebook System Software (NSS)

---

## Find It Here

### Drivers and Utilities CD (also known as ResourceCD)

**NOTE:** The *Drivers and Utilities* CD may be optional and may not ship with your computer.

Documentation and drivers are already installed on your computer. You can use the CD to reinstall drivers (see page 97) or to run the Dell Diagnostics (see page 77).



Readme files may be included on your CD to provide last-minute updates about technical changes to your computer or advanced technical-reference material for technicians or experienced users.

**NOTE:** Drivers and documentation updates can be found at [support.dell.com](http://support.dell.com).

- 
- How to set up my computer
  - Basic troubleshooting information
  - How to run the Dell Diagnostics
  - How to set up a printer
  - Additional information about setting up my computer
  - How to troubleshoot and solve problems
  - How to remove and install parts
  - Specifications
  - How to contact Dell

---

## Owner's Manual



**NOTE:** This document is available as a PDF at [support.dell.com](http://support.dell.com).

## What Are You Looking For?

- Warranty information
- Terms and Conditions (U.S. only)
- Safety instructions
- Regulatory information
- Ergonomics information
- End User License Agreement

## Find It Here

### Dell™ Product Information Guide

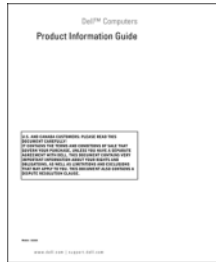

- Service Tag and Express Service Code
- Microsoft Windows License Label

### Service Tag and Microsoft® Windows® License

These labels are located on the bottom of your computer.

- Use the Service Tag to identify your computer when you use [support.dell.com](http://support.dell.com) or contact technical support.
- Enter the Express Service Code to direct your call when contacting technical support.





What Are You Looking For?	Find It Here
<ul style="list-style-type: none"> <li>• Solutions — Troubleshooting hints and tips, articles from technicians, and online courses, frequently asked questions</li> <li>• Community — Online discussion with other Dell customers</li> <li>• Upgrades — Upgrade information for components, such as memory, the hard drive, and the operating system</li> <li>• Customer Care — Contact information, service call and order status, warranty, and repair information</li> <li>• Service and support — Service call status and support history, service contract, online discussions with technical support</li> <li>• Reference — Computer documentation, details on my computer configuration, product specifications, and white papers</li> <li>• Downloads — Certified drivers, patches, and software updates</li> <li>• Notebook System Software (NSS)— If you reinstall the operating system for your computer, you should also reinstall the NSS utility. NSS provides critical updates for your operating system and support for Dell™ 3.5-inch USB floppy drives, Intel® Pentium® M processors, optical drives, and USB devices. NSS is necessary for correct operation of your Dell computer. The software automatically detects your computer and operating system and installs the updates appropriate for your configuration.</li> </ul>	<p><b>Dell Support Website — <a href="http://support.dell.com">support.dell.com</a></b></p> <p><b>NOTE:</b> Select your region to view the appropriate support site.</p> <p><b>NOTE:</b> Corporate, government, and education customers can also use the customized Dell Premier Support website at <a href="http://premier.support.dell.com">premier.support.dell.com</a>.</p> <p>To download Notebook System Software:</p> <ol style="list-style-type: none"> <li>1 Go to <a href="http://support.dell.com">support.dell.com</a> and click <b>Downloads</b>.</li> <li>2 Enter your Service Tag or product model.</li> <li>3 In the <b>Download Category</b> drop-down menu, click <b>All</b>.</li> <li>4 Select the operating system and operating system language for your computer, and click <b>Submit</b>.</li> <li>5 Under <b>Select a Device</b>, scroll to <b>System and Configuration Utilities</b>, and click <b>Dell Notebook System Software</b>.</li> </ol>
<ul style="list-style-type: none"> <li>• How to use Windows XP</li> <li>• How to work with programs and files</li> <li>• How to personalize my desktop</li> </ul>	<p><b>Windows Help and Support Center</b></p> <ol style="list-style-type: none"> <li>1 Click the <b>Start</b> button and click <b>Help and Support</b>.</li> <li>2 Type a word or phrase that describes your problem and click the arrow icon.</li> <li>3 Click the topic that describes your problem.</li> <li>4 Follow the instructions on the screen.</li> </ol>

---

**What Are You Looking For?**

- How to reinstall my operating system

**Find It Here**

---

**Operating System CD**

**NOTE:** The *Operating System CD* may be optional and may not ship with your computer.

The operating system is already installed on your computer. To reinstall your operating system, use the *Operating System CD*. See "Reinstalling Windows XP" on page 103.



After you reinstall your operating system, use the *Drivers and Utilities CD (ResourceCD)* to reinstall drivers for the devices that came with your computer.

**NOTE:** The color of your CD varies based on the operating system you ordered.

---

# A Tour of Your Computer

## Front View

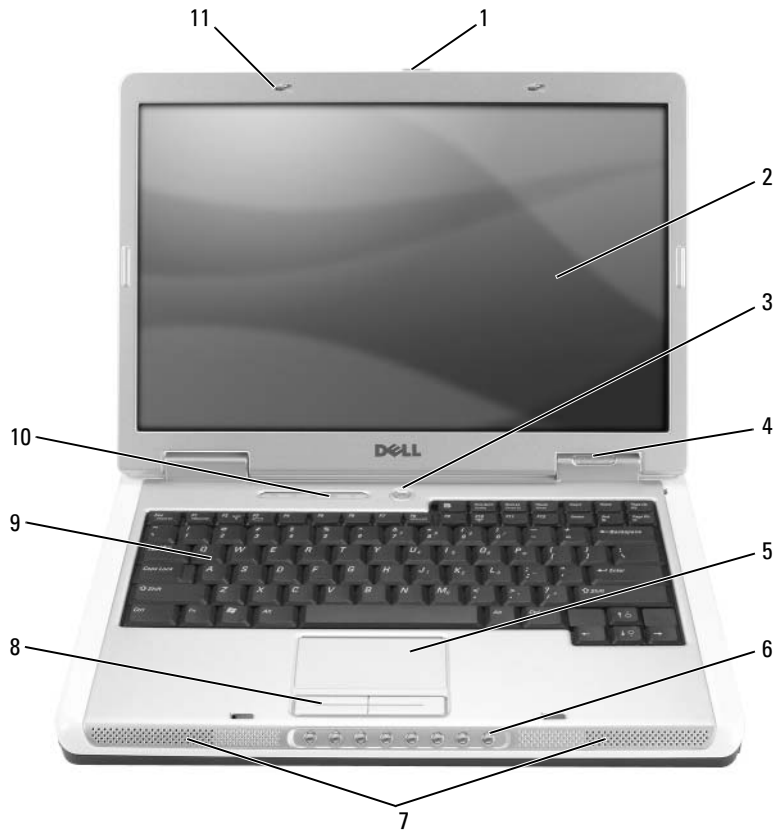

- |   |                       |   |                       |    |                                     |
|---|-----------------------|---|-----------------------|----|-------------------------------------|
| 1 | display latch release | 5 | touch pad             | 9  | keyboard                            |
| 2 | display               | 6 | media control buttons | 10 | keyboard and wireless status lights |
| 3 | power button          | 7 | speakers              | 11 | display latches (2)                 |
| 4 | device status lights  | 8 | touch pad buttons     |    |                                     |

**DISPLAY LATCH RELEASE** — Press to release the display latches and open the display.

**DISPLAY** — For more information about your display, see "Using the Display" on page 33.

**POWER BUTTON** — Press the power button to turn on the computer or to enter or exit a power management mode.

**➔ NOTICE:** To avoid losing data when you turn off your computer, shut down your computer through the Start menu instead of pressing the power button.

#### DEVICE STATUS LIGHTS

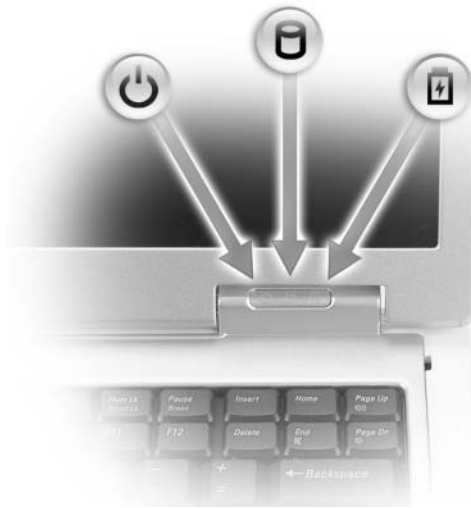

 Turns on when you turn on the computer, and blinks when the computer is in a power management mode.

 Turns on when the computer reads or writes data.

**➔ NOTICE:** To avoid loss of data, never turn off the computer while the  light is flashing.

 Turns on steadily or blinks to indicate battery charge status.

If the computer is connected to an electrical outlet, the  light operates as follows:

- Solid green: The battery is charging.
- Flashing green: The battery is almost fully charged.

If the computer is running on a battery, the  light operates as follows:

- Off: The battery is adequately charged (or the computer is turned off).
- Flashing orange: The battery charge is low.
- Solid orange: The battery charge is critically low.

**TOUCH PAD** — Provides the functionality of a mouse.

**MEDIA CONTROL BUTTONS** — Control CD, DVD, and Media Player playback.



- ✕ Mute the sound.
- 🔊 Turn the volume down.
- 🔊) Turn the volume up.
- ▶/|| Play or pause.
- ⏮ Play the previous track.
- ⏭ Play the next track.
- Stop.
- 🏠 Launch Dell MediaDirect or Microsoft® Windows® Media Center Edition. See "Using Dell MediaDirect" on page 54.

**SPEAKERS** — To adjust the volume of the integrated speakers, press the media control buttons or speaker-volume keyboard shortcuts. For more information, see "Speaker Functions" on page 37.





**TOUCH PAD BUTTONS** — Touch pad buttons provide the functionality of a mouse.

**KEYBOARD** — The keyboard includes a numeric keypad as well as the Microsoft Windows logo key. For information on supported keyboard shortcuts, see "Key Combinations" on page 36.

## KEYBOARD AND WIRELESS STATUS LIGHTS



The green lights located above the keyboard indicate the following:

-  Turns on when the numeric keypad is enabled.
-  Turns on when the uppercase letter function is enabled.
-  Turns on when the scroll lock function is enabled.
-  Turns on when wireless networking is enabled. To enable or disable wireless networking, press <Fn><F2>.
-  Turns on when a card with Bluetooth® wireless technology is enabled.

**NOTE:** The card with Bluetooth wireless technology is an optional feature, so the  light turns on only if you ordered the card with your computer. For more information, see the documentation that came with your card.

To turn off only the Bluetooth wireless technology functionality, right-click the  icon in the notification area and click **Disable Bluetooth Radio**.

To quickly enable or disable all wireless devices, press <Fn><F2>.

**DISPLAY LATCHES** — Keeps the display closed.

## Left Side View

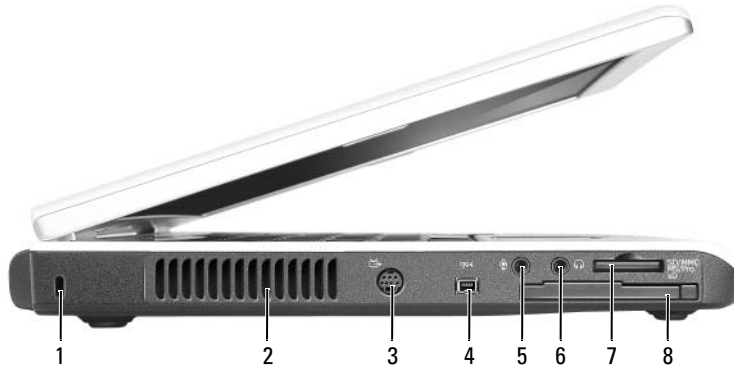

- |   |                          |   |                      |   |                                 |
|---|--------------------------|---|----------------------|---|---------------------------------|
| 1 | security cable slot      | 4 | IEEE 1394 connector  | 7 | 5-in-1 media memory card reader |
| 2 | air vent                 | 5 | microphone connector | 8 | ExpressCard slot                |
| 3 | S-video TV-out connector | 6 | headphone connector  |   |                                 |

**⚠ CAUTION:** Do not block, push objects into, or allow dust to accumulate in the air vents. Do not store your computer in a low-airflow environment, such as a closed briefcase, while it is running. Restricting the airflow can damage the computer or cause a fire.

**➡ NOTICE:** Before you buy an antitheft device, ensure that it will work with the security cable slot.

**SECURITY CABLE SLOT** — Lets you attach a commercially available antitheft device to the computer. For more information, see the instructions included with the device.



**AIR VENT** — The computer uses fans to create airflow through the vents, which prevents the computer from overheating.

**S-VIDEO TV-OUT CONNECTOR**

Connects your computer to a TV. Also connects digital audio capable devices using the TV/digital audio adapter cable.

**IEEE 1394 CONNECTOR** — Connects devices supporting IEEE 1394 high-speed transfer rates, such as some digital video cameras.

**AUDIO CONNECTORS**

Attach headphones or speakers to the  connector.

Attach a microphone to the  connector.

**5-IN-1 MEDIA MEMORY CARD READER** — Provides a fast and convenient way to view and share digital photos, music, and videos stored on a memory card. The 5-in-1 media memory card reader reads the following digital media memory cards:

- Secure Digital (SD) card/SDIO
- MultiMediaCard (MMC)
- Memory Stick
- Memory Stick PRO
- xD-Picture Card

**EXPRESSCARD SLOT** — Supports one ExpressCard. The computer ships with a plastic blank installed in the slot. For more information, see "Using ExpressCards" on page 67.



## Right Side View

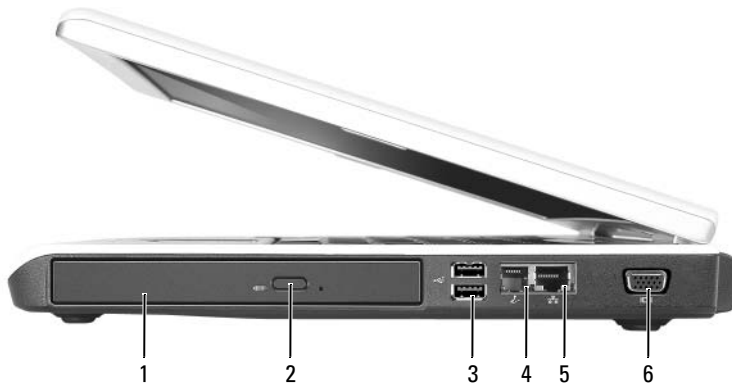

- |   |                                 |   |                         |   |                           |
|---|---------------------------------|---|-------------------------|---|---------------------------|
| 1 | optical drive bay               | 3 | USB connectors (2)      | 5 | network connector (RJ-45) |
| 2 | optical drive-tray eject button | 4 | modem connector (RJ-11) | 6 | video connector           |

**OPTICAL DRIVE BAY** — You can install devices such as a DVD drive or other optical drive in the optical drive bay. For more information, see "Optical Drives" on page 111.

**OPTICAL DRIVE-TRAY EJECT BUTTON** — Press this button to eject a CD or DVD from the optical drive.

### USB CONNECTORS



Connect USB devices, such as a mouse, keyboard, or printer. You can also connect the optional floppy drive directly to a USB connector using the optional floppy-drive cable.

### MODEM CONNECTOR (RJ-11)



To use the internal modem, connect the telephone line to the modem connector. For additional information on using the modem, see the online modem documentation supplied with your computer.



**NOTICE:** The network connector is slightly larger than the modem connector. To avoid damaging the computer, do not plug a telephone line into the network connector.

### NETWORK CONNECTOR (RJ-45)



Connects the computer to a network. The green and yellow lights next to the connector indicate activity for wired network communications.

For information on using the network adapter, see the online network adapter documentation supplied with your computer.

### VIDEO CONNECTOR



Connects an external VGA-compatible monitor.

## Back View



1 USB connectors (2)

2 AC adapter connector

### USB CONNECTORS



Connect USB devices, such as a mouse, keyboard, or printer. You can also connect the optional floppy drive directly to a USB connector using the optional floppy-drive cable.

**AC ADAPTER CONNECTOR** — Attaches an AC adapter to the computer. The AC adapter converts AC power to the DC power required by the computer. You can connect the AC adapter with your computer turned either on or off.



**CAUTION:** The AC adapter works with electrical outlets worldwide. However, power connectors and power strips vary among countries. Using an incompatible cable or improperly connecting the cable to the power strip or electrical outlet may cause fire or equipment damage.

**NOTICE:** When you disconnect the AC adapter cable from the computer, grasp the connector, not the cable itself, and pull firmly but gently to avoid damaging the cable.

## Bottom View

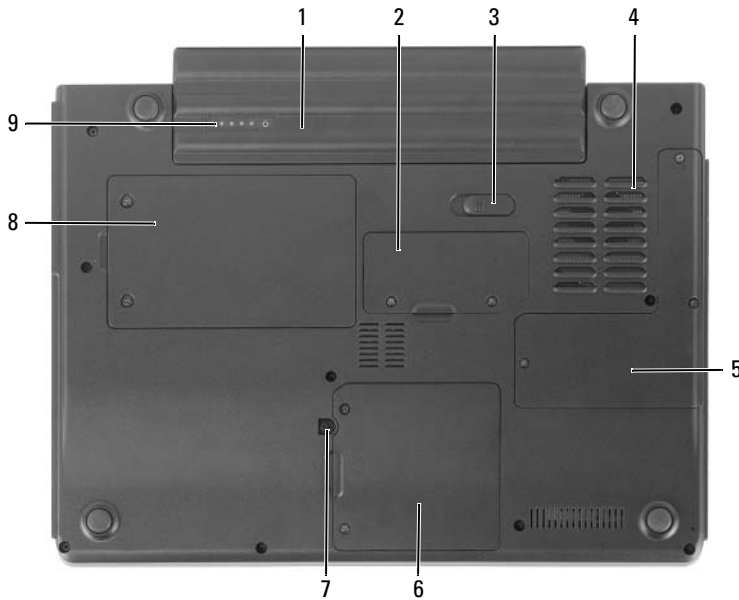

- |   |                           |   |                                    |   |                             |
|---|---------------------------|---|------------------------------------|---|-----------------------------|
| 1 | battery                   | 4 | fan                                | 7 | optical-drive locking screw |
| 2 | memory module cover       | 5 | processor and thermal module cover | 8 | hard drive                  |
| 3 | battery-bay latch release | 6 | modem/Mini PCI/wireless cover      | 9 | battery charge gauge        |

**BATTERY** — When a battery is installed, you can use the computer without connecting the computer to an electrical outlet. For more information, see "Using a Battery" on page 45.

**MEMORY MODULE COVER** — Covers the compartment that contains the memory modules. For more information, see page 112.

**BATTERY-BAY LATCH RELEASE** — Releases the battery from the battery bay. See "Battery" on page 108.

**FAN** — The computer uses a fan to create airflow through the vents, which prevents the computer from overheating.

**PROCESSOR AND THERMAL MODULE COVER** — Covers the processor and thermal module.

**MODEM/MINI PCI/WIRELESS COVER** — Covers the compartment that contains the modem, Mini PCI card, and internal card with Bluetooth wireless technology. For more information, see page 119.

**OPTICAL-DRIVE LOCKING SCREW** — Secures the optical drive in the optical drive bay. For more information, see "Optical Drives" on page 111.

**HARD DRIVE** — Stores software and data. For more information, see "Hard Drive" on page 108 and "Hard drive problems" on page 81. The size displayed for your hard drive in Windows Explorer is the capacity of the drive before any operating system or programs are installed.

**BATTERY CHARGE GAUGE** — Provides information on the battery charge status. See "Using a Battery" on page 45.

# Setting Up Your Computer

## Connecting to the Internet

 **NOTE:** ISPs and ISP offerings vary by country.

To connect to the Internet, you need a modem or network connection and an Internet service provider (ISP). Your ISP will offer one or more of the following Internet connection options:

- Dial-up connections that provide Internet access through a telephone line. Dial-up connections are considerably slower than DSL and cable modem connections.
- DSL connections that provide high-speed Internet access through your existing telephone line. With a DSL connection, you can access the Internet and use your telephone on the same line simultaneously.
- Cable modem connections that provide high-speed Internet access through your local cable TV line.

If you are using a dial-up connection, connect a telephone line to the modem connector on your computer and to the telephone wall jack before you set up your Internet connection. If you are using a DSL or cable modem connection, contact your ISP for setup instructions.

## Setting Up Your Internet Connection

To set up an Internet connection with a provided ISP desktop shortcut:

- 1 Save and close any open files, and exit any open programs.
- 2 Double-click the ISP icon on the Microsoft® Windows® desktop.
- 3 Follow the instructions on the screen to complete the setup.

If you do not have an ISP icon on your desktop or if you want to set up an Internet connection with a different ISP:

- 1 Save and close any open files, and exit any open programs.
- 2 Click the **Start** button and click **Internet Explorer**.  
The **New Connection Wizard** appears.
- 3 Click **Connect to the Internet**.
- 4 In the next window, click the appropriate option:
  - If you do not have an ISP and want to select one, click **Choose from a list of Internet service providers (ISPs)**.

- If you have already obtained setup information from your ISP but you did not receive a setup CD, click **Set up my connection manually**.
- If you have a CD, click **Use the CD I got from an ISP**.

**5** Click **Next**.

If you selected **Set up my connection manually**, continue to step 6. Otherwise, follow the instructions on the screen to complete the setup.

 **NOTE:** If you do not know which type of connection to select, contact your ISP.

**6** Click the appropriate option under **How do you want to connect to the Internet?**, and then click **Next**.

**7** Use the setup information provided by your ISP to complete the setup.

If you are having problems connecting to the Internet, see "E-Mail, Modem, and Internet Problems" on page 82. If you cannot connect to the Internet but have successfully connected in the past, the ISP might have a service outage. Contact your ISP to check the service status, or try connecting again later.

## Transferring Information to a New Computer

The Microsoft® Windows® XP operating system provides a Files and Settings Transfer Wizard to move data from a source computer to a new computer. You can transfer data, such as:

- E-mail messages
- Toolbar settings
- Window sizes
- Internet bookmarks

You can transfer the data to the new computer over a network connection, or you can store it on a removable medium, such as a writable CD or floppy, for transfer to the new computer.

 **NOTE:** For instructions on setting up a direct cable connection between two computers, see Microsoft Knowledge Base Article #305621, titled *How to Set Up a Direct Cable Connection Between Two Computers in Windows XP*. This information may not be available in some countries.

For transferring information to a new computer, you must run the Files and Settings Transfer Wizard. You can use the optional *Operating System* CD for this process or you can create a wizard disk with the Files and Settings Transfer Wizard utility.

## Running the Files and Settings Transfer Wizard With the Operating System CD

 **NOTE:** This procedure requires the *Operating System* CD. This CD is optional and may not be included with all computers.

To prepare the new computer for the file transfer:

- 1 Start the **Files and Settings Transfer Wizard**.
- 2 When the **Files and Settings Transfer Wizard** welcome screen appears, click **Next**.
- 3 On the **Which computer is this?** screen, click **New Computer** and click **Next**.
- 4 On the **Do you have a Windows XP CD?** screen, click **I will use the wizard from the Windows XP CD** and click **Next**.
- 5 When the **Now go to your old computer** screen appears, go to your old or source computer. Do *not* click **Next** at this time.

To copy data from the old computer:

- 1 On the old computer, insert the Windows XP *Operating System* CD.
- 2 On the **Welcome to Microsoft Windows XP** screen, click **Perform additional tasks**.
- 3 Under **What do you want to do?**, click **Transfer files and settings**.
- 4 On the **Files and Settings Transfer Wizard** welcome screen, click **Next**.
- 5 On the **Which computer is this?** screen, click **Old Computer** and click **Next**.
- 6 On the **Select a transfer method** screen, click the transfer method you prefer.
- 7 On the **What do you want to transfer?** screen, select the items you want to transfer and click **Next**.

After the information has been copied, the **Completing the Collection Phase** screen appears.

- 8 Click **Finish**.

To transfer data to the new computer:

- 1 On the **Now go to your old computer** screen on the new computer, click **Next**.
- 2 On the **Where are the files and settings?** screen, select the method you chose for transferring your settings and files and click **Next**.

The wizard reads the collected files and settings and applies them to your new computer.

When all of the settings and files have been applied, the **Finished** screen appears.

- 3 Click **Finished** and restart the new computer.

## Running the Files and Settings Transfer Wizard Without the Operating System CD

To run the Files and Settings Transfer Wizard without the optional *Operating System* CD, you must create a wizard disk that will allow you to create a backup image file to removable media.

To create a wizard disk, use your new computer with Windows XP and perform the following steps:

- 1 Click the **Start** button.
- 2 Click **Files and Settings Transfer Wizard**.
- 3 When the **Files and Settings Transfer Wizard** welcome screen appears, click **Next**.
- 4 On the **Which computer is this?** screen, click **New Computer** and click **Next**.
- 5 On the **Do you have a Windows XP CD?** screen, click **I want to create a Wizard Disk in the following drive:** and click **Next**.
- 6 Insert the removable media, such as a floppy disk or CD, and click **OK**.
- 7 When the disk creation completes and the **Now go to your old computer** message appears, *do not* click **Next**.
- 8 Go to the old computer.

To copy data from the old computer:

- 1 On the old computer, insert the wizard disk.
- 2 Click the **Start** button and click **Run**.
- 3 In the **Open** field on the **Run** window, browse to the path for **fastwiz** (on the appropriate removable media) and click **OK**.
- 4 On the **Files and Settings Transfer Wizard** welcome screen, click **Next**.
- 5 On the **Which computer is this?** screen, click **Old Computer** and click **Next**.
- 6 On the **Select a transfer method** screen, click the transfer method you prefer.
- 7 On the **What do you want to transfer?** screen, select the items you want to transfer and click **Next**.

After the information has been copied, the **Completing the Collection Phase** screen appears.

- 8 Click **Finish**.



To transfer data to the new computer:

- 1 On the **Now go to your old computer** screen on the new computer, click **Next**.
- 2 On the **Where are the files and settings?** screen, select the method you chose for transferring your settings and files and click **Next**. Follow the instructions on the screen.

The wizard reads the collected files and settings and applies them to your new computer.

When all of the settings and files have been applied, the **Finished** screen appears.

- 3 Click **Finished** and restart the new computer.

 **NOTE:** For more information about this procedure, search [dell.support.com](http://dell.support.com) for document #PA1089586 (*How Do I Transfer Files From My Old Computer to My New Dell Computer Using the Microsoft® Windows® XP Operating System?*).

 **NOTE:** Access to the Dell Knowledge Base document may not be available in some countries.

## Setting Up a Printer

 **NOTICE:** Complete the operating system setup before you connect a printer to the computer.

See the documentation that came with the printer for setup information, including how to:

- Obtain and install updated drivers.
- Connect the printer to the computer.
- Load paper and install the toner or ink cartridge.

For technical assistance, refer to the printer owner's manual or contact the printer manufacturer.

### Printer Cable

Your printer connects to your computer with either a USB cable or a parallel cable. Your printer may not come with a printer cable, so if you purchase a cable separately, ensure that it is compatible with your printer and computer. If you purchased a printer cable at the same time you purchased your computer, the cable may arrive in the box in which your computer was shipped.

## Connecting a USB Printer

**NOTE:** You can connect USB devices while the computer is turned on.

- 1 Complete the operating system setup if you have not already done so.
- 2 Attach the USB printer cable to the USB connectors on the computer and the printer. The USB connectors fit only one way.

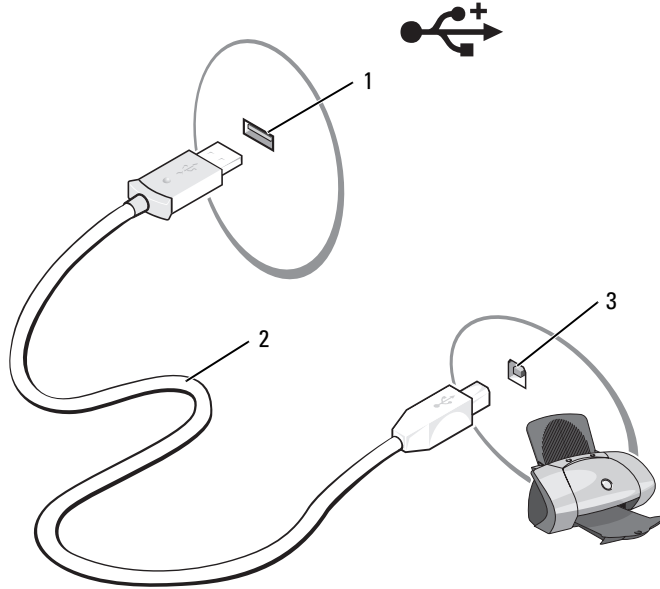

- |   |                           |   |                   |   |                      |
|---|---------------------------|---|-------------------|---|----------------------|
| 1 | USB connector on computer | 2 | USB printer cable | 3 | connector on printer |
|---|---------------------------|---|-------------------|---|----------------------|

- 3 Turn on the printer and then turn on the computer. If the **Add New Hardware Wizard** window appears, click **Cancel**.
- 4 Install the printer driver if necessary. See the documentation that came with your printer.

## Power Protection Devices

Several devices are available to protect against power fluctuations and failures:

- Surge protectors
- Line conditioners
- Uninterruptible power supplies (UPS)

## Surge Protectors

Surge protectors and power strips equipped with surge protection help prevent damage to your computer from voltage spikes that can occur during electrical storms or after power interruptions. Some surge protector manufacturers include warranty coverage for certain types of damage. Carefully read the device warranty when choosing a surge protector. A device with a higher joule rating offers more protection. Compare joule ratings to determine the relative effectiveness of different devices.

- ➔ **NOTICE:** Most surge protectors do not protect against power fluctuations or power interruptions caused by nearby lightning strikes. When lightning occurs in your area, disconnect the telephone line from the telephone wall jack and disconnect your computer from the electrical outlet.

Many surge protectors have a telephone jack for modem protection. See the surge protector documentation for modem connection instructions.

- ➔ **NOTICE:** Not all surge protectors offer network adapter protection. Disconnect the network cable from the network wall jack during electrical storms.

## Line Conditioners

- ➔ **NOTICE:** Line conditioners do not protect against power interruptions.

Line conditioners are designed to maintain AC voltage at a fairly constant level.

## Uninterruptible Power Supplies

- ➔ **NOTICE:** Loss of power while data is being saved to the hard drive may result in data loss or file damage.

- ✍ **NOTE:** To ensure maximum battery operating time, connect only your computer to a UPS. Connect other devices, such as a printer, to a separate power strip that provides surge protection.

A UPS protects against power fluctuations and interruptions. UPS devices contain a battery that provides temporary power to connected devices when AC power is interrupted. The battery charges while AC power is available. See the UPS manufacturer documentation for information on battery operating time and to ensure that the device is approved by Underwriters Laboratories (UL).



## Using the Display

### Adjusting Brightness

When a Dell™ computer is running on battery power, you can conserve power by setting the brightness to the lowest comfortable setting by pressing <Fn> and the up- or down-arrow key on the keyboard.

The Dell QuickSet Brightness Meter shows the current brightness setting for the display. Right-click the  icon in the taskbar to enable or disable the Brightness Meter on the screen.

 **NOTE:** By default, the Brightness Meter appears in the lower-right corner of the display. You can click and drag the meter to a preferred location.



 **NOTE:** Brightness key combinations only affect the display on your portable computer, not monitors that you attach to your portable computer. If your computer is connected to an external monitor and you try to change the brightness level, the Brightness Meter appears, but the brightness level on the monitor does not change.

You can enable or disable the Brightness Meter from the QuickSet taskbar menu. When the meter is enabled, press the following keys to adjust brightness:

- Press <Fn> and the up-arrow key to increase brightness on the integrated display only (not on an external monitor).
- Press <Fn> and the down-arrow key to decrease brightness on the integrated display only (not on an external monitor).

For more information on using QuickSet, right-click the  icon in the taskbar and click **Help**.

### Switching the Video Image

When you start the computer with an external device (such as an external monitor or projector) attached and turned on, the image may appear on either the computer display or the external device.

Press <Fn><F8> to switch the video image between the display only, the external device only, or the display and the external device simultaneously.

## Setting Display Resolution

To display a program at a specific resolution, both the graphics card and the display must support the program, and the necessary video drivers must be installed.

Before you change any of the default display settings, make a note of the default settings for future reference.

If you choose a resolution or color palette that is higher than the display supports, the settings adjust automatically to the closest supported values.

- 1 Click the **Start** button and click **Control Panel**.
- 2 Under **Pick a category**, click **Appearance and Themes**.
- 3 Under **Pick a task...**, click the area you want to change, or under or pick a **Control Panel** icon, click **Display**.
- 4 Try different settings for **Color quality** and **Screen resolution**.



**NOTE:** As the resolution increases, icons and text appear smaller on the screen.

# Using the Keyboard and Touch Pad

## Numeric Keypad

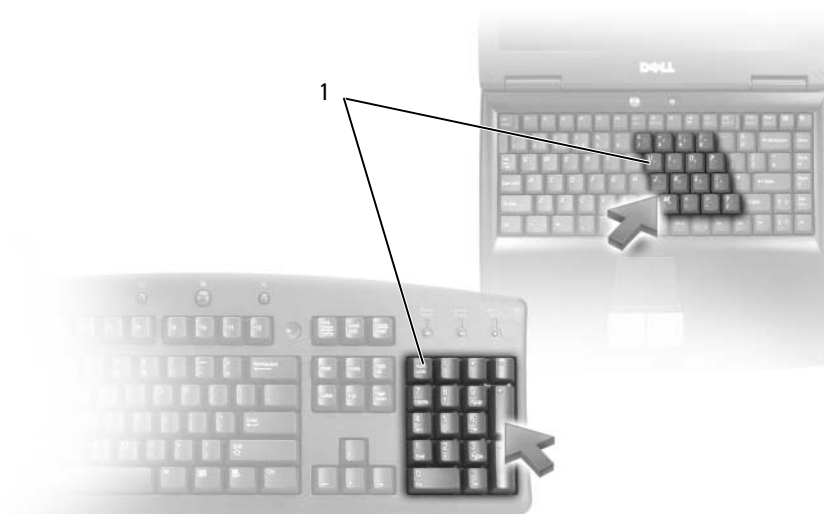

1 numeric keypad

The numeric keypad functions like the numeric keypad on an external keyboard. Each key on the keypad has multiple functions. The keypad numbers and symbols are marked in blue on the right of the keypad keys. To type a number or symbol, press <Fn> and the desired key after enabling the keypad.

- To enable the keypad, press <Num Lk>. The  light indicates that the keypad is active.
- To disable the keypad, press <Num Lk> again.

# Key Combinations

## System Functions

---

<Ctrl><Shift><Esc>	Opens the <b>Task Manager</b> window.
--------------------	---------------------------------------

---

## Battery

---

<Fn><F3>	Displays the Dell™ QuickSet Battery Meter. This feature is not supported in Dell MediaDirect. For more information, see "Dell™ QuickSet Battery Meter" on page 46.
----------	--

---

## CD or DVD Tray

---

<Fn><F10>	Ejects the tray out of the drive (if Dell QuickSet is installed). This feature is not supported in Dell MediaDirect. For more information on QuickSet, see "Dell™ QuickSet Features" on page 44.
-----------	--

---

## Display Functions

---

<Fn><F8>	Switches the video image to the next display option. The options include the integrated display, an external monitor, and both displays simultaneously.
----------	---

---

<Fn> and up-arrow key	Increases brightness on the integrated display only (not on an external monitor).
-----------------------	---

---

<Fn> and down-arrow key	Decreases brightness on the integrated display only (not on an external monitor).
-------------------------	---

---

## Radios (Including Wireless Networking and an Internal Card With Bluetooth® Wireless Technology)

---

<Fn><F2>	Enables and disables radios, including wireless networking and Bluetooth wireless technology.
----------	---

---



## Power Management

---

<Fn><Esc>	Activates a power management mode. You can reprogram this keyboard shortcut to activate a different power management mode using the <b>Advanced</b> tab in the <b>Power Options Properties</b> window. See "Power Management Modes" on page 41.
-----------	---

---

## Speaker Functions

---

<Fn><Page Up>	Increases the volume of the integrated speakers and external speakers, if attached.
<Fn><Page Dn>	Decreases the volume of the integrated speakers and external speakers, if attached.
<Fn><End>	Enables and disables the integrated speakers and external speakers, if attached.

---

## Microsoft® Windows® Logo Key Functions

---

Windows logo key and <m>	Minimizes all open windows.
Windows logo key and <Shift><m>	Maximizes all windows.
Windows logo key and <e>	Runs Windows Explorer. This opens the same window as double-clicking "My Computer" on your desktop.
Windows logo key and <r>	Opens the <b>Run</b> dialog box.
Windows logo key and <f>	Opens the <b>Search Results</b> dialog box.
Windows logo key and <Ctrl><f>	Opens the <b>Search Results-Computer</b> dialog box (if the computer is connected to a network).
Windows logo key and <Pause>	Opens the <b>System Properties</b> dialog box.

---

To adjust keyboard operation, such as the character repeat rate, open the Control Panel, click **Printers and Other Hardware**, and click **Keyboard**. For information about the Control Panel, see the Windows Help and Support Center. To access the Help and Support Center, see page 13.

## Touch Pad

The touch pad detects the pressure and movement of your finger to allow you to move the cursor on the display. Use the touch pad and touch pad buttons as you would use a mouse.

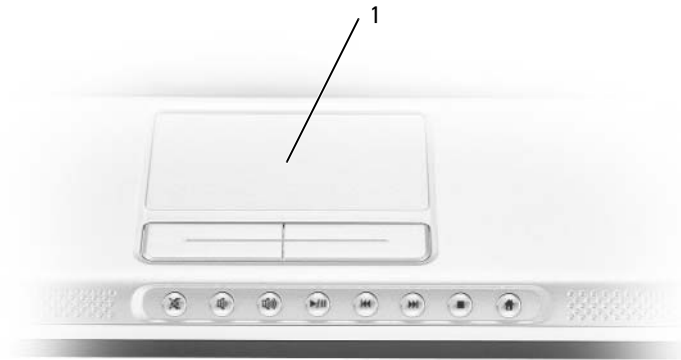

1 touch pad

- To move the cursor, lightly slide your finger over the touch pad.
- To select an object, lightly tap once on the surface of the touch pad or use your thumb to press the left touch-pad button.
- To select and move (or drag) an object, position the cursor on the object and tap twice on the touch pad. On the second tap, leave your finger on the touch pad and move the selected object by sliding your finger over the surface.
- To double-click an object, position the cursor on the object and tap twice on the touch pad or use your thumb to press the left touch-pad button twice.

### Customizing the Touch Pad

You can use the **Mouse Properties** window to disable the touch pad or adjust their settings.

- 1 Open the Control Panel, click **Printers and Other Hardware**, and then click **Mouse**. For information about the Control Panel, see the Windows Help and Support Center. To access the Help and Support Center, see page 13.
- 2 In the **Mouse Properties** window, click the **Touch Pad** tab to adjust touch pad settings.
- 3 Click **OK** to save the settings and close the window.

# Power Management

## Power Management Tips



**NOTE:** See "Using a Battery" on page 45 for more information on conserving battery power.

- Connect the computer to an electrical outlet when possible because battery life is largely determined by the number of times the battery is used and recharged.
- Place the computer in standby mode or hibernate mode when you leave the computer unattended for long periods of time.
- You can use the Power Management Wizard to select options to optimize your computer's power usage. These options can also be set to change when you press the power button, close the display, or press <Fn><Esc>.

## Power Management Wizard



**NOTE:** The Power Management Wizard is not available if you have restricted access rights.

Click or double-click the  icon to open the Power Management Wizard.

The first two screens of the wizard—**Welcome** and **What is Power Management?**—describe and define various power management options.



**NOTE:** On the **What is Power Management?** screen, you can select **Do not show this page again**. When you select this option, the **Welcome** screen also does not appear again.

Use the screens that follow the **Welcome** and **What is Power Management?** screens to set various power management options, including sleep modes, power schemes, and low battery-charge alarms.

### Setting Sleep Modes

This screen defines standby and hibernate modes. From the screen you can:

- Set the standby-mode password option.
- Enable or disable hibernate mode.
- Select how the computer will respond when you close the display:
  - Choose no action.
  - Enter standby mode.
  - Enter hibernate mode.

- Select how the computer will respond when you press the power button:
  - Choose no action.
  - Enter standby mode.
  - Enter hibernate mode.
  - Shut down Microsoft Windows and turn off the computer.
  - Prompt a user for an action (**Ask me what to do**).
- Select how the computer will respond when you press <Fn><Esc>:
  - Choose no action.
  - Enter standby mode.
  - Enter hibernate mode.
  - Shut down Microsoft Windows and turn off the computer.
  - Prompt a user for an action (**Ask me what to do**).

## Selecting a Power Scheme

 **NOTE:** The **Network Disabled** power scheme disables your internal network and wireless activity when your computer is running on battery power. When your computer is connected to an electrical outlet, the **Network Disabled** power scheme disables only your wireless activity. You must select the power scheme through QuickSet (not Microsoft® Windows®) for the **Network Disabled** power scheme to work.

The **Selecting a Power Scheme** screen allows you to create, edit, and switch between power schemes. In addition, you can delete power schemes that you create, but you cannot delete Dell™ QuickSet predefined power schemes (**Maximum Battery**, **Maximum Performance**, **Presentation**, and **Network Disabled**).

 **NOTE:** QuickSet automatically adds the word (**QuickSet**) after the names of power schemes created using QuickSet.

All QuickSet power schemes are displayed in a drop-down menu near the center of the screen. The power settings for each scheme are below the name of the current selection. The power settings are listed separately for when the computer is running on battery or connected to an electrical outlet.

The Power Management Wizard also allows you to associate the display brightness level with a power scheme. You must enable brightness-level power schemes through QuickSet in order to set the brightness level.

The display brightness, internal network-card activity, and wireless activity features are not available through the Control Panel power schemes. In order to use these features, you must set them through QuickSet power schemes.

 **NOTE:** Brightness key combinations only affect the display on your portable computer, not monitors that you attach to your portable computer. If your computer is in CRT-only mode and you try to change the brightness level, the Brightness Meter appears, but the brightness level on the monitor does not change.

## Setting Battery Alarms and Actions

This screen allows you to enable the low-battery and critical-battery alarms and to change settings for the alarms. For example, you can set the low-battery alarm to 20 percent to remind you to save work and switch to AC power, and you can set the critical-battery alarm to 10 percent to enter hibernate mode. From the screen, you can:

- Select whether the alarm will notify you by sound or text.
- Adjust the power level at which you want the alarm to notify you.
- Select how the computer will respond when the alarm notifies you:
  - Choose no action.
  - Enter standby mode.
  - Enter hibernate mode.
  - Shut down Windows and turn off the computer.

## Completing the Power Management Wizard

This screen summarizes the QuickSet power scheme, sleep mode, and battery alarm settings for your computer. Review the settings you have selected and click **Finish**.

For more information about QuickSet, right-click the  icon in the taskbar and click **Help**.

# Power Management Modes

## Standby Mode

Standby mode conserves power by turning off the display and the hard drive after a predetermined period of inactivity (a time-out). When the computer exits standby mode, it returns to the same operating state it was in before entering standby mode.

 **NOTICE:** If your computer loses AC or battery power while in standby mode, it may lose data.

To enter standby mode, click the **Start** button, click **Turn off computer**, and then click **Stand by**. Depending on how you set the power management options on the **Advanced** tab in the **Power Options Properties** window, use one of the following methods:

- Press the power button.
- Close the display.
- Press <Fn><Esc>.

To exit standby mode, press the power button or open the display depending on how you set the options on the **Advanced** tab. You cannot make the computer exit standby mode by pressing a key or touching the touch pad.

## Hibernate Mode

Hibernate mode conserves power by copying system data to a reserved area on the hard drive and then completely turning off the computer. When the computer exits hibernate mode, it returns to the same operating state it was in before entering hibernate mode.

 **NOTICE:** You cannot remove devices while your computer is in hibernate mode.

Your computer enters hibernate mode if the battery charge level becomes critically low.

To manually enter hibernate mode, click the **Start** button, click **Turn off computer**, press and hold <Shift>, and then click **Hibernate**. Depending on how you set the power management options on the **Advanced** tab in the **Power Options Properties** window, use one of the following methods to enter hibernate mode:

- Press the power button.
- Close the display.
- Press <Fn><Esc>.

 **NOTE:** Some ExpressCards may not operate correctly after the computer exits hibernate mode. Remove and reinsert the card, or simply restart (reboot) your computer. See "Installing an ExpressCard" on page 67.

To exit hibernate mode, press the power button. The computer may take a short time to exit hibernate mode. You cannot make the computer exit hibernate mode by pressing a key or touching the touch pad. For more information on hibernate mode, see the documentation that came with your operating system.

## Power Options Properties

The **Power Options Properties** window helps you to manage power consumption and monitor battery charge status. To access the Windows **Power Options Properties** window, click the **Start** button, point to **Control Panel**→**Performance and Maintenance**, and click **Power Options**.

### Power Schemes Tab

The **Power schemes** drop-down menu displays the selected preset power scheme. Keep the default **Portable/Laptop** power scheme to maximize battery power.

Windows XP controls the performance level of the processor depending on the power scheme you select. You do not need to make any further adjustments to set the performance level.

Each preset power scheme has different time-out settings for entering standby mode, turning off the display, and turning off the hard drive. For more information on power management options, see the Windows Help and Support Center. To access the Help and Support Center, see page 13.

## Alarms Tab

 **NOTE:** To enable audible alarms, click each **Alarm Action** button and select **Sound alarm**.

The **Low battery alarm** and **Critical battery alarm** settings alert you with a message when the battery charge falls below a certain percentage. When you receive your computer, the **Low battery alarm** and **Critical battery alarm** check boxes are selected. It is recommended that you continue to use these settings. See "Using a Battery" on page 45 for more information on low-battery warnings.

## Power Meter Tab

The **Power Meter** tab displays the current power source and amount of battery charge remaining.

## Advanced Tab

The **Advanced** tab allows you to:

- Set power icon and standby mode password options.
- Select how the computer will respond when you close the display:
  - Choose no action.
  - Enter standby mode.
  - Enter hibernate mode.
- Select how the computer will respond when you press the power button:
  - Choose no action.
  - Enter standby mode.
  - Enter hibernate mode.
  - Shut down Microsoft Windows and turn off the computer.
  - Prompt a user for an action (**Ask me what to do**).
- Select how the computer will respond when you press <Fn><Esc>:
  - Choose no action.
  - Enter standby mode.
  - Enter hibernate mode.
  - Shut down Microsoft Windows and turn off the computer.
  - Prompt a user for an action (**Ask me what to do**).

To program these functions, click an option from the corresponding drop-down list and then click **OK**.

## Hibernate Tab

The **Hibernate** tab lets you enable hibernate mode by clicking the **Enable hibernation** check box.

## Dell™ QuickSet Features

 **NOTE:** This feature may not be available on your computer.

Dell QuickSet is activated from the  icon on the taskbar and functions differently when you click, double-click, or right-click the icon.

### Clicking the QuickSet Icon

Click the  icon to perform the following tasks:

- Adjust power management settings using the Power Management Wizard (see page 39).
- Adjust the size of icons and toolbars.
- Select a power scheme that you set in the Power Management Wizard (see page 39).
- Turn presentation mode on or off.

### Double-Clicking the QuickSet Icon

Double-click the  icon to adjust power management settings using the Power Management Wizard (see page 39).

### Right-Clicking the QuickSet Icon

Right-click the  icon to perform the following tasks:

- Enable or disable the Brightness Meter on the screen (see page 33).
- Enable or disable the Volume Meter on the screen (see page 51).
- Turn the wireless activity indicator on or off (see page 40).
- View *Dell QuickSet Help*.
- View the version and copyright date of the QuickSet program installed on your computer.

For more information about QuickSet, right-click the  icon in the taskbar and click **Help**.



# Using a Battery

## Battery Types

See "Specifications" on page 131 for information on supported batteries.

## Battery Performance

 **CAUTION:** Before you begin any of the procedures in this section, follow the safety instructions in the *Product Information Guide*.

 **NOTE:** For information about the Dell warranty for your computer, see the *Product Information Guide* or separate paper warranty document that shipped with your computer.

For optimal computer performance and to help preserve BIOS settings, operate your Dell™ portable computer with the main battery installed at all times. Use a battery to run the computer when it is not connected to an electrical outlet. One battery is supplied as standard equipment in the battery bay.

 **NOTE:** Because the battery may not be fully charged, use the AC adapter to connect your new computer to an electrical outlet the first time you use the computer. For best results, operate the computer with the AC adapter until the battery is fully charged. To view battery charge status, access the **Control Panel**→**Power Options**→**Power Meter** tab.

Battery operating time varies depending on operating conditions.

 **NOTE:** Battery operating time (the time the battery can hold a charge) decreases over time. Depending on how often the battery is used and the conditions under which it is used, you may need to purchase a new battery during the life of your computer.

Operating time is significantly reduced when you perform operations including, but not limited to, the following:

- Using optical drives
- Using wireless communications devices, ExpressCards, or USB devices
- Using high-brightness display settings, 3D screen savers, or other power-intensive programs such as 3D games
- Running the computer in maximum performance mode (see page 40)

 **NOTE:** It is recommended that you connect your computer to an electrical outlet when writing to a CD or DVD.

You can check the battery charge before you insert the battery into the computer. You can also set power management options to alert you when the battery charge is low.

**⚠ CAUTION: Using an incompatible battery may increase the risk of fire or explosion. Replace the battery only with a compatible battery purchased from Dell. The battery is designed to work with your Dell computer. Do not use a battery from other computers with your computer.**

**⚠ CAUTION: Do not dispose of batteries with household waste. When your battery no longer holds a charge, call your local waste disposal or environmental agency for advice on disposing of a battery. See "Battery Disposal" in the *Product Information Guide*.**

**⚠ CAUTION: Misuse of the battery may increase the risk of fire or chemical burn. Do not puncture, incinerate, disassemble, or expose the battery to temperatures above 60°C (140°F). Keep the battery away from children. Handle damaged or leaking batteries with extreme care. Damaged batteries may leak and cause personal injury or equipment damage.**

## Checking the Battery Charge

The Dell QuickSet Battery Meter, the Microsoft Windows Power Meter window and  icon, the battery charge gauge, and the low-battery warning provide information on the battery charge.

### Dell™ QuickSet Battery Meter

If Dell QuickSet is installed, press <Fn><F3> to display the QuickSet Battery Meter.

The **Battery Meter** window displays status, charge level, and charge completion time for the battery in your computer.

The following icons appear in the **Battery Meter** window:



The computer is running on battery power.



The computer is connected to AC power and the battery is charging.



The computer is connected to AC power and the battery is fully charged.

---

For more information about QuickSet, right-click the  icon in the taskbar, and click **Help**.

### Microsoft® Windows® Power Meter

The Windows Power Meter indicates the remaining battery charge. To check the Power Meter, double-click the  icon on the taskbar. For more information about the **Power Meter** tab, see "Power Management" on page 39.

If the computer is connected to an electrical outlet, a  icon appears.

## Charge Gauge

Before you insert a battery, press the status button on the battery charge gauge to illuminate the charge-level lights. Each light represents approximately 20 percent of the total battery charge. For example, if the battery has 80 percent of its charge remaining, four of the lights are on. If no lights appear, the battery has no charge.

## Health Gauge

The battery operating time is largely determined by the number of times it is charged. After hundreds of charge and discharge cycles, batteries lose some charge capacity, or battery health. To check the battery health, press and hold the status button on the battery charge gauge for at least 3 seconds. If no lights appear, the battery is in good condition, and more than 80 percent of its original charge capacity remains. Each light represents incremental degradation. If five lights appear, less than 60 percent of the charge capacity remains, and you should consider replacing the battery. See "Specifications" on page 131 for more information about the battery operating time.

## Low-Battery Warning



**NOTICE:** To avoid losing or corrupting data, save your work immediately after a low-battery warning. Then connect the computer to an electrical outlet. If the battery runs completely out of power, hibernate mode begins automatically.

A pop-up window warns you when the battery charge is approximately 90 percent depleted. For more information about low-battery alarms, see "Power Management" on page 39.

## Charging the Battery



**NOTE:** Without Dell™ ExpressCharge™, the AC adapter charges a completely discharged 6-cell battery in approximately 2 hours and a 9-cell battery in approximately 3 hours with the computer turned off. Charge time is longer with the computer turned on. You can leave the battery in the computer as long as you like. The battery's internal circuitry prevents the battery from overcharging.

When you connect the computer to an electrical outlet or install a battery while the computer is connected to an electrical outlet, the computer checks the battery charge and temperature. If necessary, the AC adapter then charges the battery and maintains the battery charge.

If the battery is hot from being used in your computer or being in a hot environment, the battery may not charge when you connect the computer to an electrical outlet.

The battery is too hot to start charging if the  light flashes alternately green and orange. Disconnect the computer from the electrical outlet and allow the computer and the battery to cool to room temperature. Then connect the computer to an electrical outlet to continue charging the battery.

For more information about resolving problems with a battery, see "Power Problems" on page 91.

## Storing a Battery

Remove the battery when you store your computer for an extended period of time. A battery discharges during prolonged storage. After a long storage period, recharge the battery fully before you use it.

# Using CDs, DVDs, and Other Multimedia

## Playing a CD or DVD

- ➔ **NOTICE:** Do not press down on the CD or DVD tray when you open or close it. Keep the tray closed when you are not using the drive.
  - ➔ **NOTICE:** Do not move the computer when you are playing CDs or DVDs to prevent damage to your CD/DVD drive or discs.
- 1 Press the eject button on the front of the drive.
  - 2 Pull out the tray.



1 CD/DVD tray

- 3 Place the disc, label side up, in the center of the tray and snap the disc onto the spindle.

 **NOTE:** If you use a CD/DVD drive that shipped with another computer, you need to install the drivers and software necessary to play CDs or DVDs or write data. For more information, see the *Drivers and Utilities* CD (the *Drivers and Utilities* CD is optional and may not be available for your computer or in certain countries).









- 4 Push the tray back into the drive.

To format CDs for storing data, to create music CDs, or to copy CDs, see the CD software that came with your computer.

 **NOTE:** Ensure that you follow all copyright laws when you create CDs.

The CD player includes the following basic buttons:









---

	Play.
	Move backward within the current track.
	Move forward within the current track.
	Go to the previous track.
	Go to the next track.
	Pause.
	Stop.
	Eject.



---

The DVD player includes the following basic buttons:

---

	Play.
	Stop.
	Restart the current chapter.
	Fast forward.
	Fast reverse.
	Go to the next title or chapter.
	Go to the previous title or chapter.
	Continuously play the current title or chapter.

---

	Pause.
	Advance a single frame while in pause mode.
	Eject.

---

For more information on playing CDs or DVDs, click **Help** in the CD or DVD player program window (if available).

## Adjusting the Volume

 **NOTE:** When the speakers are muted, you do not hear the CD or DVD playing.

- 1 Click the **Start** button, point to **All Programs**→**Accessories**→**Entertainment**, and then click **Volume Control**.
- 2 In the **Volume Control** window, click and drag the bar in the **Volume Control** column and slide it up or down to increase or decrease the volume.

For more information on volume control options, click **Help** in the **Volume Control** window.

The Volume Meter displays the current volume level, including mute, on your computer. Either right-click the  icon in the taskbar or press the volume control buttons to enable or disable the Volume Meter on the screen.

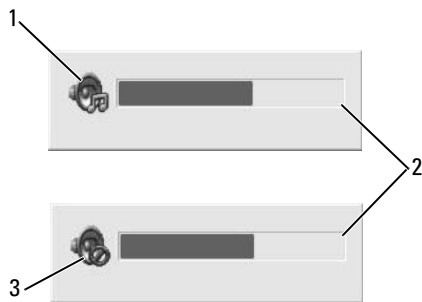

1 volume icon

2 Volume Meter

3 mute icon

When the Volume Meter is enabled, adjust the volume with the volume control buttons or by pressing the following key combinations:

- Press <Fn><PageUp> to increase the volume.
- Press <Fn><PageDn> to decrease the volume.
- Press <Fn><End> to mute the volume.

For more information about QuickSet, right-click the  icon in the taskbar and click **Help**.

## Adjusting the Picture

If an error message notifies you that the current resolution and color depth are using too much memory and preventing DVD playback, adjust the display properties.

- 1 Click the **Start** button and click **Control Panel**.
- 2 Under **Pick a category**, click **Appearance and Themes**.
- 3 Under **Pick a task...**, click **Change the screen resolution**.
- 4 In the **Display Properties** window, click and drag the bar in **Screen resolution** to reduce the screen resolution setting.
- 5 Click the drop-down menu under **Color quality**, and then click **Medium (16 bit)**.
- 6 Click **OK** to save the settings and close the window.

## Copying CDs and DVDs

 **NOTE:** Ensure that you observe all copyright laws when creating CDs or DVDs.

This section applies only to computers that have a CD-RW, DVD+/-RW, or CD-RW/DVD (combo) drive.

 **NOTE:** The types of CD or DVD drives offered by Dell may vary by country.

The following instructions explain how to make an exact copy of a CD or DVD. You can also use Sonic DigitalMedia for other purposes, such as creating music CDs from audio files stored on your computer or backing up important data. For help, open Sonic DigitalMedia and then click the question mark icon in the upper-right corner of the window.

### How to Copy a CD or DVD

 **NOTE:** CD-RW/DVD combo drives cannot write to DVD media. If you have a CD-RW/DVD combo drive and you experience recording problems, check for available software patches on the Sonic support website at [www.sonic.com](http://www.sonic.com).

The DVD-writable drives installed in Dell™ computers can write to and read DVD+/-R, DVD+/-RW and DVD+R DL (dual layer) media, but they cannot write to and may not read DVD-RAM or DVD-R DL media.

 **NOTE:** Most commercial DVDs have copyright protection and cannot be copied using Sonic DigitalMedia.

- 1 Click the **Start** button, point to **All Programs**→ **Sonic**→ **DigitalMedia Projects**, and then click **Copy**.
- 2 Under the **Copy** tab, click **Disc Copy**.



**3** To copy the CD or DVD:

- *If you have one CD or DVD drive*, ensure that the settings are correct and click the **Disc Copy** button. The computer reads your source CD or DVD and copies the data to a temporary folder on your computer hard drive.

When prompted, insert a blank CD or DVD into the drive and click **OK**.

- *If you have two CD or DVD drives*, select the drive into which you have inserted your source CD or DVD and click the **Disc Copy** button. The computer copies the data from the source CD or DVD to the blank CD or DVD.

Once you have finished copying the source CD or DVD, the CD or DVD that you have created automatically ejects.

### Using Blank CDs and DVDs

CD-RW drives can write to CD recording media only (including high-speed CD-RW) while DVD-writable drives can write to both CD and DVD recording media.

Use blank CD-Rs to record music or permanently store data files. After creating a CD-R, you cannot write to that CD-R again (see the Sonic documentation for more information). Use blank CD-RWs to write to CDs or to erase, rewrite, or update data on CDs.

Blank DVD+/-Rs can be used to permanently store large amounts of information. After you create a DVD+/-R disc, you may not be able to write to that disc again if the disc is "finalized" or "closed" during the final stage of the disc creation process. Use blank DVD+/-RWs if you plan to erase, rewrite, or update information on that disc later.

#### CD-Writable Drives

Media Type	Read	Write	Rewritable
CD-R	Yes	Yes	No
CD-RW	Yes	Yes	Yes

#### DVD-Writable Drives

Media Type	Read	Write	Rewritable
CD-R	Yes	Yes	No
CD-RW	Yes	Yes	Yes
DVD+R	Yes	Yes	No
DVD-R	Yes	Yes	No
DVD+RW	Yes	Yes	Yes
DVD-RW	Yes	Yes	Yes
DVD+R DL	Yes	Yes	No

Media Type	Read	Write	Rewritable
DVD-R DL	Maybe	No	No
DVD-RAM	Maybe	No	No

## Helpful Tips

- Use Microsoft® Windows® Explorer to drag and drop files to a CD-R or CD-RW only after you start Sonic DigitalMedia and open a DigitalMedia project.
- Use CD-Rs to burn music CDs that you want to play in regular stereos. CD-RWs do not play in most home or car stereos.
- You cannot create audio DVDs with Sonic DigitalMedia.
- Music MP3 files can be played only on MP3 players or on computers that have MP3 software installed.
- Commercially available DVD players used in home theater systems may not support all available DVD formats. For a list of formats supported by your DVD player, see the documentation provided with your DVD player or contact the manufacturer.
- Do not burn a blank CD-R or CD-RW to its maximum capacity; for example, do not copy a 650-MB file to a blank 650-MB CD. The CD-RW drive needs 1–2 MB of the blank space to finalize the recording.
- Use a blank CD-RW to practice CD recording until you are familiar with CD recording techniques. If you make a mistake, you can erase the data on the CD-RW and try again. You can also use blank CD-RWs to test music file projects before you record the project permanently to a blank CD-R.

See the Sonic website at [www.sonic.com](http://www.sonic.com) for additional information.

## Using Dell MediaDirect



**NOTE:** Dell QuickSet, which is automatically installed and enabled on your computer, is necessary for Dell MediaDirect to function. Changing or disabling QuickSet default settings can limit Dell MediaDirect functionality. For more information about Dell QuickSet, see "Dell™ QuickSet Features" on page 44.

If you have Microsoft Windows Media Center Edition or another version of Windows XP with Dell Media Experience installed, you can press the Dell MediaDirect button  to launch either media program.

- If you press the Dell MediaDirect button while you are logged in, either Windows XP Media Center Manager or Dell Media Experience launches, depending on your system setup. If both programs are present, Windows XP Media Center Manager will launch.
- When your computer is off, you can press the Dell MediaDirect button to start the computer and automatically launch the media application. The computer can either be on and running Windows or it can be in the hibernate, standby, or off mode.

**NOTE:** You cannot reinstall the Dell MediaDirect feature if you voluntarily reformat the hard drive. Contact Dell for assistance. See "Contacting Dell" on page 145.



1 Dell MediaDirect button

## Connecting Your Computer to a TV or Audio Device

**NOTE:** Video and audio cables for connecting your computer to a TV or other audio device are not included with your computer. Cables may be purchased at most consumer electronics stores. The TV/digital audio adapter cable is available for purchase from Dell.

Your computer has an S-video TV-out connector that, together with a standard S-video cable (available from Dell), enables you to connect the computer to a TV.

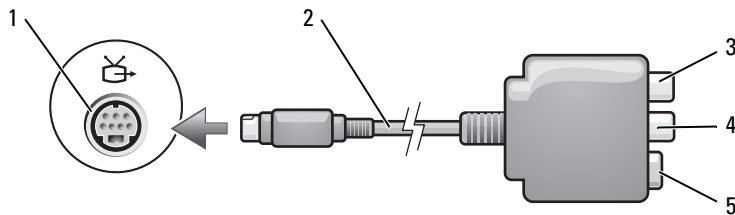

- |                                  |                                    |                     |
|----------------------------------|------------------------------------|---------------------|
| 1 S-video TV-out connector       | 3 S/PDIF digital audio connector   | 5 S-video connector |
| 2 TV/digital audio adapter cable | 4 composite video-output connector |                     |

Your TV has either an S-video input connector or a composite video-input connector. Depending on what type of connector is available on your TV, you can use a commercially available S-video cable or composite video cable to connect your computer to your TV.

It is recommended that you connect video and audio cables to your computer in one of the following combinations.

 **NOTE:** See the diagrams at the beginning of each subsection to help you determine which method of connection you should use.

- S-video and standard audio
- Composite video and standard audio

When you finish connecting the video and audio cables between your computer and your TV, you must enable your computer to work with the TV. See "Enabling the Display Settings for a TV" on page 66 to ensure that the computer recognizes and works properly with the TV. Additionally, if you are using S/PDIF digital audio, see "Enabling S/PDIF Digital Audio" on page 64.

### S-Video and Standard Audio

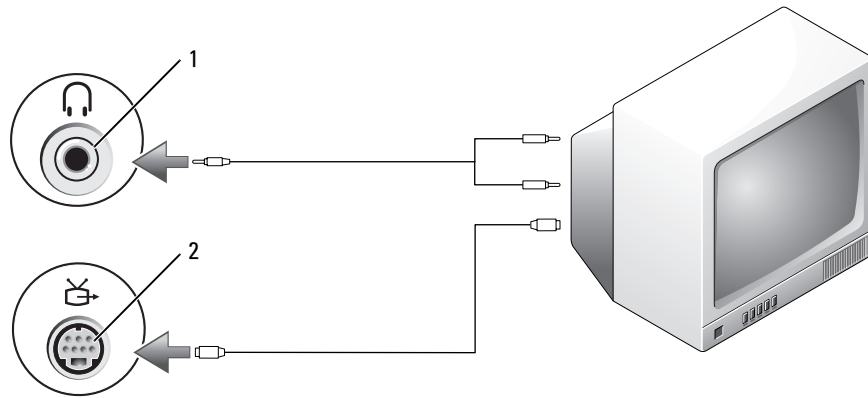

1 audio connector

2 S-video TV-out connector

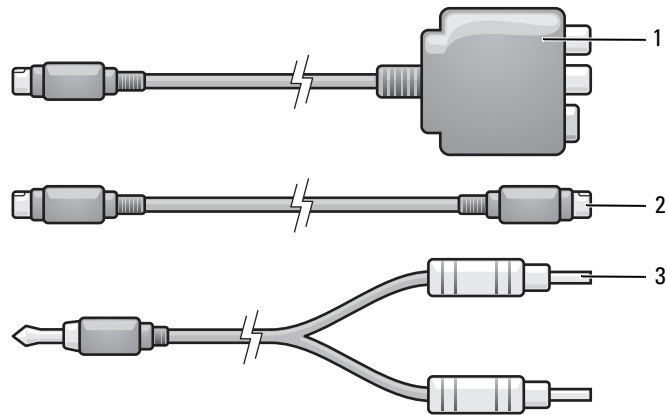

- 1 TV/digital audio adapter cable    2 standard S-video cable    3 standard audio cable

1 Turn off the computer and the TV and/or audio device that you want to connect.

**NOTE:** You can connect an S-video cable directly to the S-video TV-out connector on the computer (without the TV/digital audio adapter cable) if your TV or audio device supports S-video but not S/PDIF digital audio.

2 Plug one end of the S-video cable in to the S-video output connector on the computer.

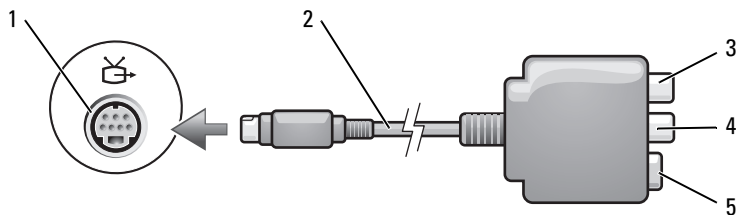

- 1 S-video TV-out connector    3 S/PDIF digital audio connector    5 S-video connector  
 2 TV/digital audio adapter cable    4 composite video-output connector

3 Plug the other end of the S-video cable in to the S-video input connector on your TV.

4 Plug the single-connector end of the audio cable in to the headphone connector on your computer.

5 Plug the two RCA connectors on the other end of the audio cable in to the audio input connectors on your TV or other audio device.

- 6 Turn on the TV and any audio device that you connected (if applicable), and then turn on the computer.
- 7 See "Enabling the Display Settings for a TV" on page 66 to ensure that the computer recognizes and works properly with the TV.

### S-Video and S/PDIF Digital Audio

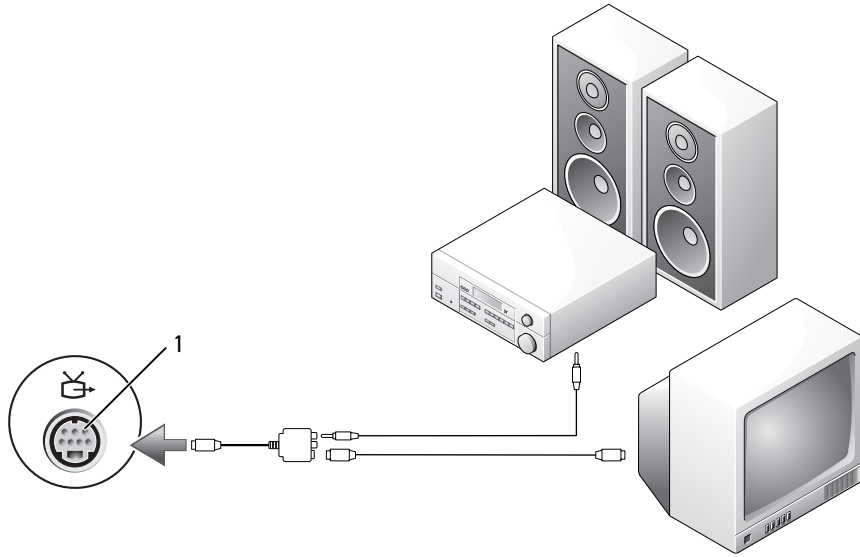

1 S-video TV-out connector

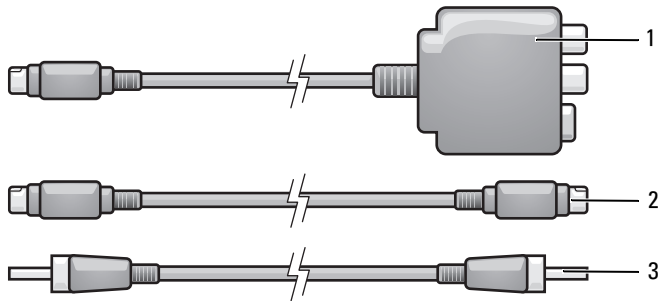

1 TV/digital audio adapter cable    2 S-video cable    3 S/PDIF digital audio cable

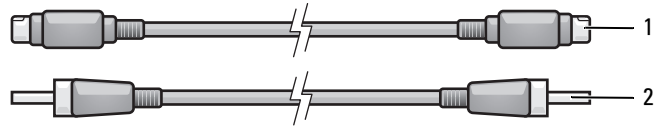

- 1 S-video cable                      2 S/PDIF digital audio cable

- 1 Turn off the computer and the TV and/or audio device that you want to connect.
- 2 Connect the TV/digital audio adapter cable to the S-video TV-out connector on your computer.
- 3 Plug one end of the S-video cable in to the S-video input connector on the TV/digital audio adapter cable.

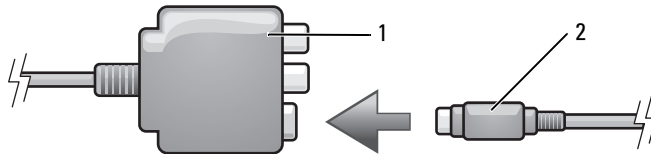

- 1 TV/digital audio adapter      2 S-video cable  
cable

- 4 Plug the other end of the S-video cable in to the S-video input connector on the TV.
- 5 Plug one end of the S/PDIF digital audio cable in to the digital audio connector on the TV/digital audio adapter cable.

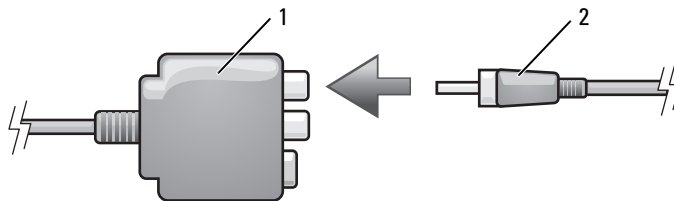

- 1 TV/digital audio adapter      2 S/PDIF digital audio cable  
cable

- 6 Plug the other end of the S/PDIF digital audio cable in to the audio input connector on your TV or other audio device.

- 7 Turn on the TV, turn on any audio device that you connected (if applicable), and then turn on the computer.
- 8 See "Enabling the Display Settings for a TV" on page 66 to ensure that the computer recognizes and works properly with the TV.

### Composite Video and Standard Audio

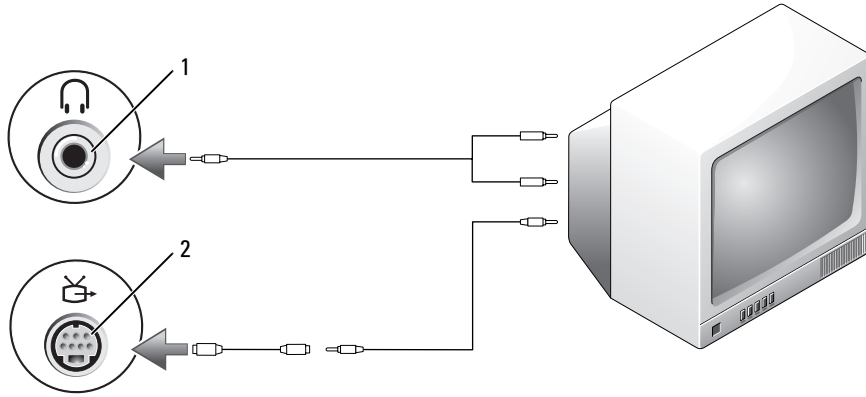

- 1 audio input connector      2 composite video-input connector

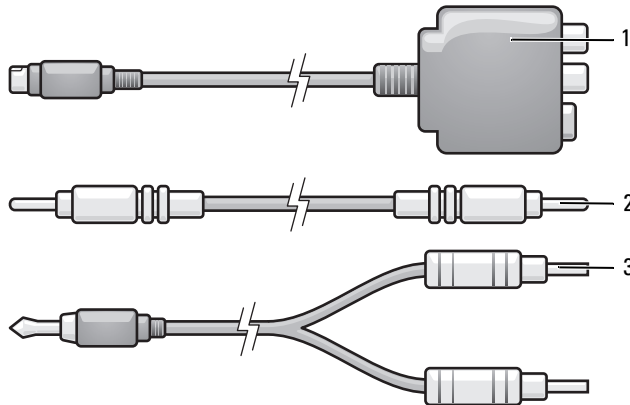

- 1 TV/digital audio adapter cable      2 composite video cable      3 standard audio cable



- 1 Turn off the computer and the TV and/or audio device that you want to connect.
- 2 Connect the standard video to composite video adapter cable to the S-video TV-out connector on the computer.
- 3 Plug one end of the composite video cable in to the composite video-input connector on the standard video to composite video cable.



- 1 standard S-video to composite video adapter  
2 composite video cable

- 4 Plug the other end of the composite video cable in to the composite video-input connector on the TV.
- 5 Plug the single-connector end of the audio cable in to the headphone connector on the computer.
- 6 Plug the two RCA connectors on the other end of the audio cable in to the audio input connectors on your TV or other audio device.
- 7 Turn on the TV, turn on any audio device that you connected (if applicable), and then turn on the computer.
- 8 See "Enabling the Display Settings for a TV" on page 66 to ensure that the computer recognizes and works properly with the TV.

## Composite Video and S/PDIF Digital Audio

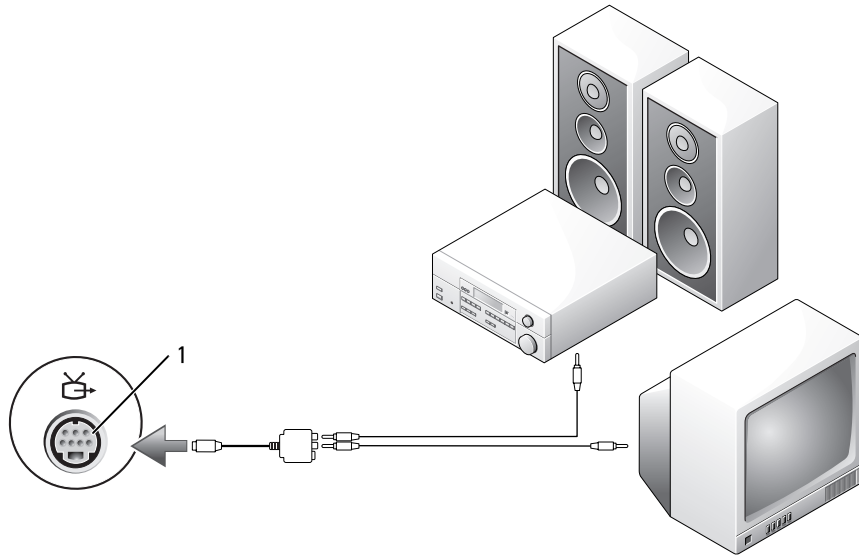

1 composite video-input connector

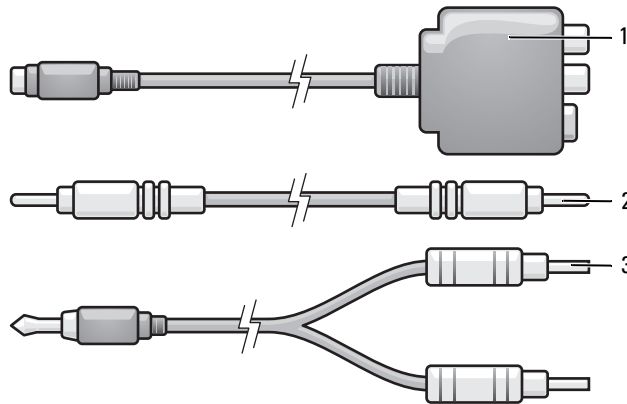

1 TV/digital audio adapter    2 composite video cable    3 standard audio cable

- 1 Turn off the computer and the TV and/or audio device that you want to connect.
- 2 Connect the TV/digital audio adapter cable to the S-video TV-out connector on the computer.
- 3 Plug one end of the composite video cable in to the composite video-input connector on the TV/digital audio adapter cable.

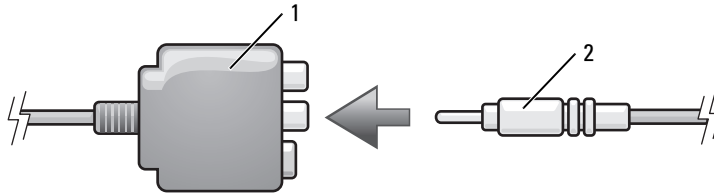

- |                                  |                                   |
|----------------------------------|-----------------------------------|
| 1 TV/digital audio adapter cable | 2 composite video-input connector |
|----------------------------------|-----------------------------------|

- 4 Plug the other end of the composite video cable in to the composite video-input connector on the TV.
- 5 Plug one end of the S/PDIF digital audio cable in to the S/PDIF audio connector on the TV/digital audio adapter cable.

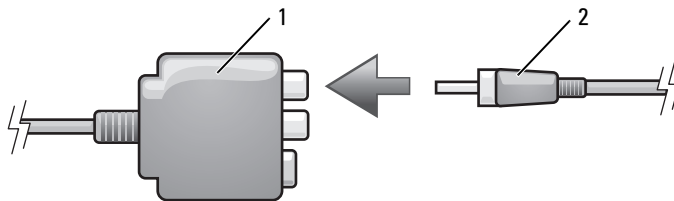

- |                                  |                              |
|----------------------------------|------------------------------|
| 1 TV/digital audio adapter cable | 2 S/PDIF digital audio cable |
|----------------------------------|------------------------------|

- 6 Plug the other end of the digital audio cable in to the S/PDIF input connector on your TV or other audio device.
- 7 Turn on the TV, turn on any audio device that you connected (if applicable), and then turn on the computer.
- 8 See "Enabling the Display Settings for a TV" on page 66 to ensure that the computer recognizes and works properly with the TV.

## Enabling S/PDIF Digital Audio

If your computer has a DVD drive, you can enable digital audio for DVD playback.

- 1 Click **Start**→ **Programs**→ **PowerDVD** to launch the Cyberlink PowerDVD application.
- 2 Insert a DVD into the DVD drive.  
If the DVD begins playing, click the stop button.
- 3 Click the **Settings** option.



- 4 Click the **DVD** option.



- 5 Click the **DVD Audio Setting** icon.

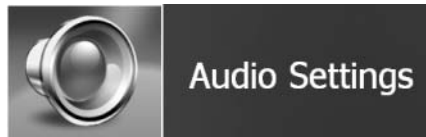

- 6 Click the arrows beside the **Speaker Configuration** setting to scroll through the options, and select the **SPDIF** option.



- 7 Click the **Back** button once, and then click the **Back** button again to return to the main menu screen.

### Enabling S/PDIF in the Windows Audio Driver

- 1 Double-click the speaker icon in the Windows notification area.
- 2 Click the **Options** menu and then click **Advanced Controls**.
- 3 Click **Advanced**.
- 4 Click **S/PDIF Interface**.
- 5 Click **Close**.
- 6 Click **OK**.

### Setting Up the Cyberlink (CL) Headphones

 **NOTE:** The CL headphone feature is available only if your computer has a DVD drive.

If your computer has a DVD drive, you can enable digital audio for DVD playback.

- 1 Click **Start**→ **Programs**→ **PowerDVD** to launch the Cyberlink PowerDVD program.
- 2 Insert a DVD into the DVD drive.  
If the DVD begins playing, click the stop button.
- 3 Click the **Settings** option.



- 4 Click the **DVD** option.



- 5 Click the **DVD Audio Setting** icon.

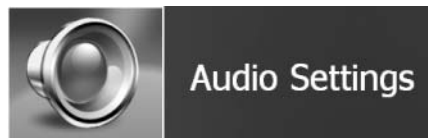

- 6 Click the arrows beside the **Speaker Configuration** setting to scroll through the options, and select the **Headphones** option.
- 7 Click the arrows beside the **Audio listening mode** setting to scroll through the options, and select the **CL Headphone** option.
- 8 Click the arrows beside the **Dynamic range compression** option to select the most suitable option.



- 9 Click the **Back** button once, and then click the **Back** button again to return to the main menu screen.

## Enabling the Display Settings for a TV

### Video Controller

 **NOTE:** To ensure that the display options appear correctly, connect the TV to the computer before you enable the display settings.

- 1 Click the **Start** button, point to **Settings**, and then click **Control Panel**.
- 2 Double-click **Display** and click the **Settings** tab.
- 3 Click **Advanced**.
- 4 Click the tab for your video card.
- 5 In the display devices section, select the appropriate option for using either a single display or multiple displays, ensuring that the display settings are correct for your selection.

 **NOTE:** To determine the type of video card installed in your computer, click the **Start** button and click **Help and Support**. Under **Pick a Task**, click **Use Tools** to view your computer information and diagnose problems and click **My Computer Information**.

# Using ExpressCards

## ExpressCard Types

See "Specifications" on page 131 for information on supported ExpressCards.

 **NOTE:** An ExpressCard is not a bootable device.

## ExpressCard Blanks

Your computer shipped with a plastic blank installed in the ExpressCard slot. Blanks protect unused slots from dust and other particles. Save the blank for use when no ExpressCard is installed in the slot; blanks from other computers may not fit your computer.

To remove the blank, see "Removing an ExpressCard or Blank" on page 68.

## Installing an ExpressCard

You can install an ExpressCard in the computer while the computer is running. The computer automatically detects the card.

ExpressCards are generally marked with a symbol (such as a triangle or an arrow) or a label to indicate which end to insert into the slot. The cards are keyed to prevent incorrect insertion. If card orientation is not clear, see the documentation that came with the card.

 **CAUTION:** Before you begin any of the procedures in this section, follow the safety instructions in the *Product Information Guide*.

To install an ExpressCard:

- 1 Hold the card with the top side of the card facing up. The latch may need to be in the "in" position before you insert the card.
- 2 Slide the card into the slot until the card is completely seated in its connector.  
If you encounter too much resistance, do not force the card. Check the card orientation and try again.



## 1 ExpressCard

The computer recognizes the ExpressCard and automatically loads the appropriate device driver. If the configuration program tells you to load the manufacturer's drivers, use the floppy disk or CD that came with the ExpressCard.

## Removing an ExpressCard or Blank

**➡ NOTICE:** Use the ExpressCard configuration utility (click the  icon in the taskbar) to select a card and stop it from functioning before you remove it from the computer. If you do not stop the card in the configuration utility, you could lose data.

**⚠ CAUTION:** Before you begin any of the procedures in this section, follow the safety instructions in the *Product Information Guide*.

Press the latch and remove the card or blank. For some latches, you must press the latch twice: once to pop the latch out, and then a second time to pop the card out.

Save a blank to use when no ExpressCard is installed in a slot. Blanks protect unused slots from dust and other particles.





1 release button

2 ExpressCard



# Using the 5-in-1 Media Memory Card Reader

## Media Memory Card Types

The 5-in-1 media memory card reader provides a fast and convenient way to view and share digital photos, music, and videos stored on a memory card.

 **NOTE:** A media memory card is not a bootable device.

The 5-in-1 media memory card reader reads the following media memory cards:

- Secure Digital (SD) card/SDIO
- MultiMediaCard (MMC)
- Memory Stick
- Memory Stick PRO
- xD-Picture Card

## Media Memory Card Blanks

Your computer shipped with a plastic blank installed in the 5-in-1 media memory card slot. Blanks protect unused slots from dust and other particles. Save the blank for use when no card is installed in the slot; blanks from other computers may not fit your computer.

To remove the blank, see "Removing a Media Memory Card or Blank" on page 72.

## Installing a Media Memory Card

You can install a media memory card in the computer while the computer is running. The computer automatically detects the card.

Media memory cards are generally marked with a symbol (such as a triangle or an arrow) or a label to indicate which end to insert into the slot. The cards are keyed to prevent incorrect insertion. If card orientation is not clear, see the documentation that came with the card.

 **CAUTION:** Before you begin any of the procedures in this section, follow the safety instructions in the *Product Information Guide*.

To install a media memory card:

- 1 Hold the card with the top side of the card facing up.
- 2 Slide the card into the slot until the card is completely seated in its connector.  
If you encounter too much resistance, do not force the card. Check the card orientation and try again.

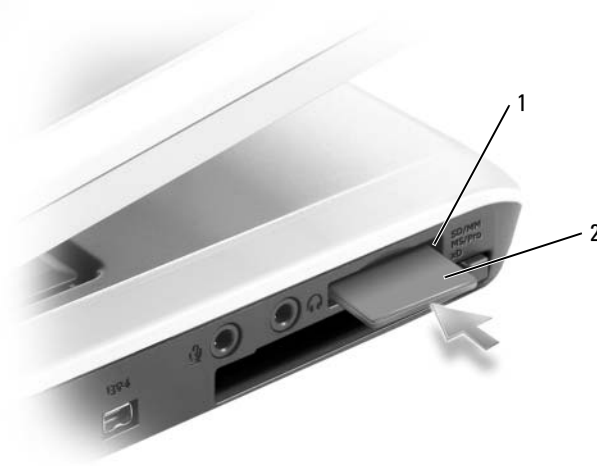

- 1 5-in-1 media memory card 2 media memory card slot

The computer recognizes the media memory card and automatically loads the appropriate device driver. If the configuration program tells you to load the manufacturer's drivers, use the CD that came with the media memory card, if applicable.

## Removing a Media Memory Card or Blank

**NOTICE:** Use the media memory card configuration utility (click the  icon in the taskbar) to select a card and stop it from functioning before you remove it from the computer. If you do not stop the card in the configuration utility, you could lose data.

**CAUTION:** Before you begin any of the procedures in this section, follow the safety instructions in the *Product Information Guide*.

Press the card in to release and remove the card or blank.

Save a blank to use when no media memory card is installed in the slot. Blanks protect unused slots from dust and other particles.

# Setting Up a Home and Office Network

## Connecting to a Network Adapter

Before you connect your computer to a network, the computer must have a network adapter installed and a network cable connected to it.

To connect a network cable:

- 1 Connect the network cable to the network adapter connector on the back of your computer.

 **NOTE:** Insert the cable until it clicks into place, and then gently pull it to ensure that it is secure.

- 2 Connect the other end of the network cable to a network connection device, such as a network wall connector.

 **NOTE:** Do not use a network cable with a telephone wall connector.



## Network Setup Wizard

The Microsoft® Windows® XP operating system provides a Network Setup Wizard to guide you through the process of sharing files, printers, or an Internet connection between computers in a home or small office.

- 1 Click the **Start** button, point to **All Programs**→**Accessories**→**Communications**, and then click **Network Setup Wizard**.
- 2 On the **Network Setup Wizard** welcome screen, click **Next**.
- 3 Click **Checklist for creating a network**.

- ✍
**NOTE:** Selecting the connection method **This computer connects directly to the Internet** enables the integrated firewall provided with Windows XP Service Pack 1 (SP1) or later.
- 4 Complete the checklist and required preparations.
- 5 Return to the Network Setup Wizard and follow the instructions on the screen.

## Connecting to a Wireless Local Area Network

- ✍
**NOTE:** These networking instructions do not apply to internal cards with Bluetooth® wireless technology or cellular products.

### Determining Your Network Type

- ✍
**NOTE:** Most wireless networks are of the infrastructure type.

Wireless networks fall into two categories—infrastructure networks and ad-hoc networks. An infrastructure network uses routers or access points to connect several computers. An ad-hoc network does not use routers or access points and consists of computers that broadcast to one another. For additional assistance with setting up your wireless connection, go to [support.dell.com](http://support.dell.com) and search for the keyword *wireless setup*.

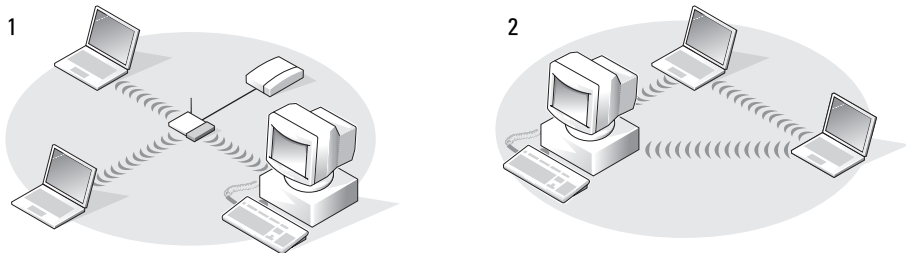

1 infrastructure network      2 ad-hoc network

### Connecting to a Wireless Network in Microsoft® Windows® XP

Your wireless network card requires specific software and drivers in order to connect to a network. The software is already installed. If the software is removed or corrupted, follow the instructions included in the user's guide for your wireless network card.

The user's guide is located on the optional *Drivers and Utilities* CD in the "User's Guides-Network User's Guides" category. The user's guide is also available on the Dell Support website at [support.dell.com](http://support.dell.com) and may also be located on your computer desktop.

- ✍
**NOTE:** The *Drivers and Utilities* CD is optional and may not be available for your computer or in certain countries.

When you turn on your computer, a pop-up appears from the network icon in the notification area (located in the lower-right corner of the Windows desktop) when a network, for which your computer is not configured, is detected in the area.

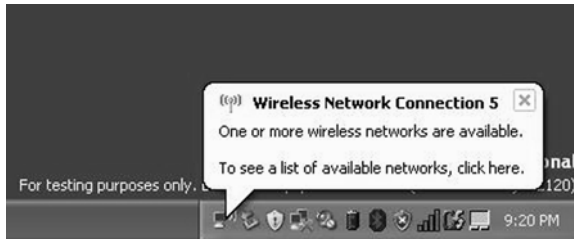



**NOTE:** The following instructions apply if you use the Windows operating system to manage your network devices. For information about other wireless configuration utilities, see your wireless network documentation.

- 1 Click either the pop-up or the network icon to configure your computer for one of the available wireless networks.

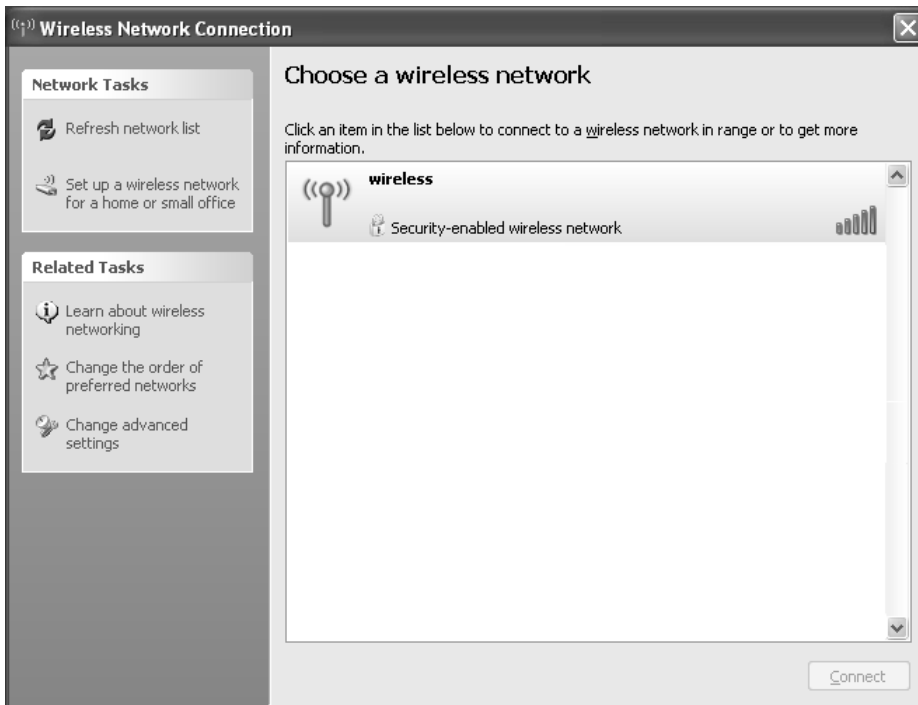
The **Wireless Network Connections** window lists the wireless networks available in your area.



- 2 Click to select the network you want to configure, and then click **Connect** or double-click the network name in the list. If you select a secure network (identified by a  icon), you must enter a password when prompted.

 **NOTE:** Network security settings are unique to your network. Dell cannot provide this information.

 **NOTE:** Your computer can take up to 1 minute to connect to a network.

After your computer is configured for the wireless network you selected, another pop-up notifies you that your computer is connected to the network you selected.



Thereafter, whenever you log on to your computer in the area of the wireless network, the same pop-up notifies you of the wireless network connection.



# Solving Problems

## Dell Diagnostics

 **CAUTION:** Before you begin any of the procedures in this section, follow the safety instructions in the *Product Information Guide*.

### When to Use the Dell Diagnostics

If you experience a problem with your computer, perform the checks in "Lockups and Software Problems" on page 88 and run the Dell Diagnostics before you contact Dell for technical assistance.

 **NOTICE:** The Dell Diagnostics works only on Dell computers.

 **NOTE:** The *Drivers and Utilities* CD is optional and may not ship with your computer.

Start the Dell Diagnostics from either your hard drive or from the *Drivers and Utilities* CD (also known as the *ResourceCD*).

### Starting the Dell Diagnostics From Your Hard Drive

The Dell Diagnostics is located on a hidden diagnostic utility partition on your hard drive.

 **NOTE:** If your computer cannot display a screen image, contact Dell. See "Contacting Dell" on page 145.

- 1 Shut down the computer.
- 2 Connect the computer to an electrical outlet.
- 3 Diagnostics can be invoked one of two ways:
  - a Turn on the computer. When the DELL™ logo appears, press <F12> immediately. Select **Diagnostics** from the boot menu and press <Enter>.

 **NOTE:** If you wait too long and the operating system logo appears, continue to wait until you see the Microsoft® Windows® desktop. Then shut down your computer and try again.

- b Press and hold the <Fn> key while powering the system on.

 **NOTE:** If you see a message stating that no diagnostics utility partition has been found, run the Dell Diagnostics from the *Drivers and Utilities CD*.

The computer runs the Pre-boot System Assessment, a series of initial tests of your system board, keyboard, hard drive, and display.

- During the assessment, answer any questions that appear.
- If a failure is detected, the computer stops and beeps. To stop the assessment and restart the computer, press <n>; to continue to the next test, press <y>; to retest the component that failed, press <r>.
- If failures are detected during the Pre-boot System Assessment, write down the error code(s) and contact Dell.

If the Pre-boot System Assessment completes successfully, you receive the message `Booting Dell Diagnostic Utility Partition. Press any key to continue.`

- 4 Press any key to start the Dell Diagnostics from the diagnostics utility partition on your hard drive.

### Starting the Dell Diagnostics From the Drivers and Utilities CD

 **NOTE:** The *Drivers and Utilities* CD may be optional and may not ship with your computer.

- 1 Insert the *Drivers and Utilities* CD.
- 2 Shut down and restart the computer.

When the DELL logo appears, press <F12> immediately.

If you wait too long and the Windows logo appears, continue to wait until you see the Windows desktop. Then shut down your computer and try again.

 **NOTE:** The next steps change the boot sequence for one time only. On the next start-up, the computer boots according to the devices specified in the system setup program.

- 3 When the boot device list appears, highlight `CD/DVD/CD-RW Drive` and press <Enter>.
- 4 Select the **Boot from CD-ROM** option from the menu that appears and press <Enter>.
- 5 Type 1 to start the *ResourceCD* menu and press <Enter> to proceed.
- 6 Select **Run the 32 Bit Dell Diagnostics** from the numbered list. If multiple versions are listed, select the version appropriate for your computer.
- 7 When the Dell Diagnostics **Main Menu** appears, select the test you want to run.

## Dell Diagnostics Main Menu

- 1 After the Dell Diagnostics loads and the **Main Menu** screen appears, click the button for the option you want.

Option	Function
Express Test	Performs a quick test of devices. This test typically takes 10 to 20 minutes and requires no interaction on your part. Run <b>Express Test</b> first to increase the possibility of tracing the problem quickly.
Extended Test	Performs a thorough check of devices. This test typically takes 1 hour or more and requires you to answer questions periodically.
Custom Test	Tests a specific device. You can customize the tests you want to run.
Symptom Tree	Lists the most common symptoms encountered and allows you to select a test based on the symptom of the problem you are having.

- 2 If a problem is encountered during a test, a message appears with an error code and a description of the problem. Write down the error code and problem description and follow the instructions on the screen.

If you cannot resolve the error condition, contact Dell.



**NOTE:** The Service Tag for your computer is located at the top of each test screen. If you contact Dell, technical support will ask for your Service Tag.

- 3 If you run a test from the **Custom Test** or **Symptom Tree** option, click the applicable tab described in the following table for more information.

Tab	Function
Results	Displays the results of the test and any error conditions encountered.
Errors	Displays error conditions encountered, error codes, and the problem description.
Help	Describes the test and may indicate requirements for running the test.

Tab	Function
Configuration	<p>Displays your hardware configuration for the selected device.</p> <p>The Dell Diagnostics obtains configuration information for all devices from the system setup program, memory, and various internal tests, and it displays the information in the device list in the left pane of the screen. The device list may not display the names of all the components installed on your computer or all devices attached to your computer.</p>
Parameters	Allows you to customize the test by changing the test settings.

- 4 When the tests are completed, if you are running the Dell Diagnostics from the *Drivers and Utilities* CD, remove the CD.
- 5 When the tests are complete, close the test screen to return to the **Main Menu** screen. To exit the Dell Diagnostics and restart the computer, close the **Main Menu** screen.

## Drive Problems

 **CAUTION:** Before you begin any of the procedures in this section, follow the safety instructions in the *Product Information Guide*.

**ENSURE THAT MICROSOFT® WINDOWS® RECOGNIZES THE DRIVE** — Click the **Start** button and click **My Computer**. If the floppy, CD, or DVD drive is not listed, perform a full scan with your antivirus software to check for and remove viruses. Viruses can sometimes prevent Windows from recognizing the drive.

**TEST THE DRIVE** —

- Insert another floppy disk, CD, or DVD to eliminate the possibility that the original one is defective.
- Insert a bootable floppy disk and restart the computer.

**CLEAN THE DRIVE OR DISK** — See "Cleaning Your Computer" on page 141.

**ENSURE THAT THE CD IS SNAPPED ONTO THE SPINDLE**

**CHECK THE CABLE CONNECTIONS**

**CHECK FOR HARDWARE INCOMPATIBILITIES** — (See "Resolving Software and Hardware Incompatibilities" on page 99.)

**RUN THE DELL DIAGNOSTICS** — See "Dell Diagnostics" on page 77.

## CD and DVD drive problems

 **NOTE:** High-speed CD or DVD drive vibration is normal and may cause noise, which does not indicate a defect in the drive or the CD or DVD.

 **NOTE:** Because of different regions worldwide and different disc formats, not all DVD titles work in all DVD drives.

### Problems writing to a CD/DVD-RW drive

**CLOSE OTHER PROGRAMS** — The CD/DVD-RW drive must receive a steady stream of data when writing. If the stream is interrupted, an error occurs. Try closing all programs before you write to the CD/DVD-RW.

**TURN OFF STANDBY MODE IN WINDOWS BEFORE WRITING TO A CD/DVD-RW DISC** — See "Power Management Modes" on page 41 for information on standby mode.

**CHANGE THE WRITE SPEED TO A SLOWER RATE** — See the help files for your CD or DVD creation software.

### If you cannot eject the CD, CD-RW, DVD, or DVD+RW drive tray

- 1 Ensure that the computer is shut down.
- 2 Straighten a paper clip and insert one end into the eject hole at the front of the drive; push firmly until the tray is partially ejected.
- 3 Gently pull out the tray until it stops.

### If you hear an unfamiliar scraping or grinding sound

- Ensure that the sound is not caused by the program that is running.
- Ensure that the disk or disc is inserted properly.

## Hard drive problems

**ALLOW THE COMPUTER TO COOL BEFORE TURNING IT ON** — A hot hard drive may prevent the operating system from starting. Try allowing the computer to return to room temperature before turning it on.

### RUN CHECK DISK —

- 1 Click the **Start** button and click **My Computer**.
- 2 Right-click **Local Disk C:**.
- 3 Click **Properties**.
- 4 Click the **Tools** tab.
- 5 Under **Error-checking**, click **Check Now**.
- 6 Click **Scan for and attempt recovery of bad sectors**.
- 7 Click **Start**.

## E-Mail, Modem, and Internet Problems



**CAUTION:** Before you begin any of the procedures in this section, follow the safety instructions in the *Product Information Guide*.



**NOTE:** Connect the modem to an analog telephone jack only. The modem does not operate while it is connected to a digital telephone network.

**CHECK THE MICROSOFT OUTLOOK® EXPRESS SECURITY SETTINGS** — If you cannot open your e-mail attachments:

- 1 In Outlook Express, click **Tools**, click **Options**, and then click **Security**.
- 2 Click **Do not allow attachments** to remove the checkmark.

**CHECK THE TELEPHONE LINE CONNECTION**

**CHECK THE TELEPHONE JACK**

**CONNECT THE MODEM DIRECTLY TO THE TELEPHONE WALL JACK**

**USE A DIFFERENT TELEPHONE LINE** —

- Verify that the telephone line is connected to the jack on the modem. (The jack has either a green label or a connector-shaped icon next to it.)
- Ensure that you hear a click when you insert the telephone line connector into the modem.
- Disconnect the telephone line from the modem and connect it to a telephone. Listen for a dial tone.
- If you have other telephone devices sharing the line, such as an answering machine, fax machine, surge protector, or line splitter, then bypass them and connect the modem directly to the telephone wall jack. If you are using a line that is 3 m (10 ft) or more in length, try a shorter one.

**RUN THE MODEM HELPER DIAGNOSTICS** — Click the **Start** button, point to **All Programs** and then click **Modem Helper**. Follow the instructions on the screen to identify and resolve modem problems. (Modem Helper is not available on all computers.)

**VERIFY THAT THE MODEM IS COMMUNICATING WITH WINDOWS** —

- 1 Click the **Start** button and click **Control Panel**.
- 2 Click **Printers and Other Hardware**.
- 3 Click **Phone and Modem Options**.
- 4 Click the **Modems** tab.
- 5 Click the COM port for your modem.
- 6 Click **Properties**, click the **Diagnostics** tab, and then click **Query Modem** to verify that the modem is communicating with Windows.

If all commands receive responses, the modem is operating properly.

**ENSURE THAT YOU ARE CONNECTED TO THE INTERNET** — Ensure that you have subscribed to an Internet provider. With the Outlook Express e-mail program open, click **File**. If **Work Offline** has a checkmark next to it, click the checkmark to remove it and connect to the Internet. For help, contact your Internet service provider.

**SCAN THE COMPUTER FOR SPYWARE** — If you are experiencing slow computer performance, you frequently receive pop-up advertisements, or you are having problems connecting to the Internet, your computer might be infected with spyware. Use an anti-virus program that includes anti-spyware protection (your program may require an upgrade) to scan the computer and remove spyware. For more information, go to [support.dell.com](http://support.dell.com) and search for the keyword *spyware*.

## Error Messages



**CAUTION:** Before you begin any of the procedures in this section, follow the safety instructions in the *Product Information Guide*.

If the message is not listed, see the documentation for the operating system or the program that was running when the message appeared.

**AUXILIARY DEVICE FAILURE** — The touch pad, track stick, or external mouse may be faulty. For an external mouse, check the cable connection. Enable the **Pointing Device** option in the system setup program. If the problem persists, contact Dell. See "Contacting Dell" on page 145.

**BAD COMMAND OR FILE NAME** — Ensure that you have spelled the command correctly, put spaces in the proper place, and used the correct pathname.

**CACHE DISABLED DUE TO FAILURE** — The primary cache internal to the microprocessor has failed. Contact Dell. See "Contacting Dell" on page 145.

**CD DRIVE CONTROLLER FAILURE** — The CD drive does not respond to commands from the computer. See "Drive Problems" on page 80.

**DATA ERROR** — The hard drive cannot read the data. See "Drive Problems" on page 80.

**DECREASING AVAILABLE MEMORY** — One or more memory modules may be faulty or improperly seated. Reinstall the memory modules and, if necessary, replace them. See "Memory" on page 112.

**DISK C: FAILED INITIALIZATION** — The hard drive failed initialization. Run the hard drive tests in the Dell Diagnostics. See "Dell Diagnostics" on page 77.

**DRIVE NOT READY** — The operation requires a hard drive in the bay before it can continue. Install a hard drive in the hard drive bay. See "Hard Drive" on page 108.

**ERROR READING PCMCIA CARD** — The computer cannot identify the ExpressCard. Reinsert the card or try another card. See "Using ExpressCards" on page 67.

**EXTENDED MEMORY SIZE HAS CHANGED** — The amount of memory recorded in NVRAM does not match the memory installed in the computer. Restart the computer. If the error appears again, contact Dell. See "Contacting Dell" on page 145.

**THE FILE BEING COPIED IS TOO LARGE FOR THE DESTINATION DRIVE** — The file that you are trying to copy is too large to fit on the disk, or the disk is too full. Try copying the file to a different disk or use a larger capacity disk.

**A FILENAME CANNOT CONTAIN ANY OF THE FOLLOWING CHARACTERS: \ / : \* ? " < > |** — Do not use these characters in filenames.

**GATE A20 FAILURE** — A memory module may be loose. Reinstall the memory modules and, if necessary, replace them. See "Memory" on page 112.

**GENERAL FAILURE** — The operating system is unable to carry out the command. The message is usually followed by specific information—for example, *Printer out of paper*. Take the appropriate action.

**HARD-DISK DRIVE CONFIGURATION ERROR** — The computer cannot identify the drive type. Shut down the computer, remove the hard drive (see page 108), and boot the computer from a CD. Then shut down the computer, reinstall the hard drive, and restart the computer. Run the Hard-Disk Drive tests in the Dell Diagnostics (see page 77).

**HARD-DISK DRIVE CONTROLLER FAILURE 0** — The hard drive does not respond to commands from the computer. Shut down the computer, remove the hard drive (see page 108), and boot the computer from a CD. Then shut down the computer, reinstall the hard drive, and restart the computer. If the problem persists, try another drive. Run the Hard-Disk Drive tests in the Dell Diagnostics (see page 77).

**HARD-DISK DRIVE FAILURE** — The hard drive does not respond to commands from the computer. Shut down the computer, remove the hard drive (see page 108), and boot the computer from a CD. Then shut down the computer, reinstall the hard drive, and restart the computer. If the problem persists, try another drive. Run the Hard-Disk Drive tests in the Dell Diagnostics (see page 77).

**HARD-DISK DRIVE READ FAILURE** — The hard drive may be defective. Shut down the computer, remove the hard drive (see page 108), and boot the computer from a CD. Then shut down the computer, reinstall the hard drive, and restart the computer. If the problem persists, try another drive. Run the Hard-Disk Drive tests in the Dell Diagnostics (see page 77).

**INSERT BOOTABLE MEDIA** — The operating system is trying to boot to a nonbootable CD. Insert a bootable CD.

**INVALID CONFIGURATION INFORMATION-PLEASE RUN SYSTEM SETUP PROGRAM** — The system configuration information does not match the hardware configuration. The message is most likely to occur after a memory module is installed. Correct the appropriate options in the system setup program (see "Using the System Setup Program" on page 137).

**KEYBOARD CLOCK LINE FAILURE** — For external keyboards, check the cable connection. Run the Keyboard Controller test in the Dell Diagnostics (see page 77).

**KEYBOARD CONTROLLER FAILURE** — For external keyboards, check the cable connection. Restart the computer, and avoid touching the keyboard or the mouse during the boot routine. Run the Keyboard Controller test in the Dell Diagnostics (see page 77).



**KEYBOARD DATA LINE FAILURE** — For external keyboards, check the cable connection. Run the Keyboard Controller test in the Dell Diagnostic (see page 77)s.

**KEYBOARD STUCK KEY FAILURE** — For external keyboards or keypads, check the cable connection. Restart the computer, and avoid touching the keyboard or keys during the boot routine. Run the Stuck Key test in the Dell Diagnostics (see page 77).

**LICENSED CONTENT IS NOT ACCESSIBLE IN MEDIADIRECT** — Dell MediaDirect cannot verify the Digital Rights Management (DRM) restrictions on the file, so the file cannot be played. See "Dell MediaDirect problems" on page 89.

**MEMORY ADDRESS LINE FAILURE AT ADDRESS, READ VALUE EXPECTING VALUE** — A memory module may be faulty or improperly seated. Reinstall the memory modules and, if necessary, replace them (see page 112).

**MEMORY ALLOCATION ERROR** — The software you are attempting to run is conflicting with the operating system, another program, or a utility. Shut down the computer, wait 30 seconds, and then restart it. Try to run the program again. If the error message still appears, see the software documentation.

**MEMORY DATA LINE FAILURE AT ADDRESS, READ VALUE EXPECTING VALUE** — A memory module may be faulty or improperly seated. Reinstall the memory modules and, if necessary, replace them (see page 112).

**MEMORY DOUBLE WORD LOGIC FAILURE AT ADDRESS, READ VALUE EXPECTING VALUE** — A memory module may be faulty or improperly seated. Reinstall the memory modules and, if necessary, replace them (see page 112).

**MEMORY ODD/EVEN LOGIC FAILURE AT ADDRESS, READ VALUE EXPECTING VALUE** — A memory module may be faulty or improperly seated. Reinstall the memory modules and, if necessary, replace them (see page 112).

**MEMORY WRITE/READ FAILURE AT ADDRESS, READ VALUE EXPECTING VALUE** — A memory module may be faulty or improperly seated. Reinstall the memory modules and, if necessary, replace them (see page 112).

**NO BOOT DEVICE AVAILABLE** — The computer cannot find the hard drive. If the hard drive is your boot device, ensure that the drive is installed, properly seated, and partitioned as a boot device.

**NO BOOT SECTOR ON HARD DRIVE** — The operating system may be corrupted. Contact Dell. See "Contacting Dell" on page 145.

**NO TIMER TICK INTERRUPT** — A chip on the system board may be malfunctioning. Run the System Set tests in the Dell Diagnostics (see page 77).

**NOT ENOUGH MEMORY OR RESOURCES. EXIT SOME PROGRAMS AND TRY AGAIN** — You have too many programs open. Close all windows and open the program that you want to use.

**OPERATING SYSTEM NOT FOUND** — Reinstall the hard drive (see "Hard Drive" on page 108). If the problem persists, contact Dell. See "Contacting Dell" on page 145.

**OPTIONAL ROM BAD CHECKSUM** — The optional ROM apparently failed. Contact Dell. See "Contacting Dell" on page 145.

**A REQUIRED .DLL FILE WAS NOT FOUND** — The program that you are trying to open is missing an essential file. Remove and then reinstall the program.

- 1 Click the **Start** button and click **Control Panel**.
- 2 Click **Add or Remove Programs**.
- 3 Select the program you want to remove.
- 4 Click **Remove** or **Change/Remove** and follow the prompts on the screen.
- 5 See the program documentation for installation instructions.

**SECTOR NOT FOUND** — The operating system cannot locate a sector on the hard drive. You may have a defective sector or corrupted FAT on the hard drive. Run the Windows error-checking utility to check the file structure on the hard drive. See the Windows Help and Support Center for instructions. To access the Help and Support Center, see "Windows Help and Support Center" on page 13. If a large number of sectors are defective, back up the data (if possible), and then reformat the hard drive.

**SEEK ERROR** — The operating system cannot find a specific track on the hard drive.

**SHUTDOWN FAILURE** — A chip on the system board may be malfunctioning. Run the System Set tests in the Dell Diagnostics (see page 77).

**TIME-OF-DAY CLOCK LOST POWER** — System configuration settings are corrupted. Connect your computer to an electrical outlet to charge the battery. If the problem persists, try to restore the data by entering the system setup program. Then immediately exit the program. See "Using the System Setup Program" on page 137. If the message reappears, contact Dell. See "Contacting Dell" on page 145.

**TIME-OF-DAY CLOCK STOPPED** — The reserve battery that supports the system configuration settings may require recharging. Connect your computer to an electrical outlet to charge the battery. If the problem persists, contact Dell. See "Contacting Dell" on page 145.

**TIME-OF-DAY NOT SET-PLEASE RUN THE SYSTEM SETUP PROGRAM** — The time or date stored in the system setup program does not match the system clock. Correct the settings for the **Date** and **Time** options. See "Using the System Setup Program" on page 137.

**TIMER CHIP COUNTER 2 FAILED** — A chip on the system board may be malfunctioning. Run the System Set tests in the Dell Diagnostics (see page 77).

**UNEXPECTED INTERRUPT IN PROTECTED MODE** — The keyboard controller may be malfunctioning, or a memory module may be loose. Run the System Memory tests and the Keyboard Controller test in the Dell Diagnostics (see page 77).

**X:\ IS NOT ACCESSIBLE. THE DEVICE IS NOT READY** — Insert a disk into the drive and try again.

**WARNING: BATTERY IS CRITICALLY LOW** — The battery is running out of charge. Replace the battery, or connect the computer to an electrical outlet. Otherwise, activate hibernate mode or shut down the computer.

## IEEE 1394 Device Problems

 **CAUTION:** Before you begin any of the procedures in this section, follow the safety instructions in the *Product Information Guide*.

**ENSURE THAT THE IEEE 1394 DEVICE IS RECOGNIZED BY WINDOWS** —

- 1 Click the Start button and click Control Panel.
- 2 Click Printers and Other Hardware.

If your IEEE 1394 device is listed, Windows recognizes the device.

**IF YOU HAVE PROBLEMS WITH A DELL-PROVIDED IEEE 1394 DEVICE** — Contact Dell or the IEEE 1394 device manufacturer. See "Contacting Dell" on page 145.

**IF YOU HAVE PROBLEMS WITH AN IEEE 1394 DEVICE NOT PROVIDED BY DELL** — Contact Dell or the IEEE 1394 device manufacturer. See "Contacting Dell" on page 145.

**ENSURE THAT THE IEEE 1394 DEVICE IS PROPERLY INSERTED INTO THE CONNECTOR**

## Keyboard Problems

 **CAUTION:** Before you begin any of the procedures in this section, follow the safety instructions in the *Product Information Guide*.

 **NOTE:** Use the integrated keyboard when running the Dell Diagnostics or the system setup program. When you attach an external keyboard, the integrated keyboard remains fully functional.

### External Keyboard problems

 **NOTE:** When you attach an external keyboard, the integrated keyboard remains fully functional.

**CHECK THE KEYBOARD CABLE** — Shut down the computer. Disconnect the keyboard cable and check it for damage, and firmly reconnect the cable.

If you are using a keyboard extension cable, disconnect it and connect the keyboard directly to the computer.

**CHECK THE EXTERNAL KEYBOARD** —

- 1 Shut down the computer, wait 1 minute, and turn it on again.
- 2 Verify that the numbers, capitals, and scroll lock lights on the keyboard blink during the boot routine.
- 3 From the Windows desktop, click the Start button, point to Programs→ Accessories, and then click Notepad.
- 4 Type some characters on the external keyboard and verify that they appear on the display. If you cannot verify these steps, you may have a defective external keyboard.

**TO VERIFY THAT THE PROBLEM IS WITH THE EXTERNAL KEYBOARD, CHECK THE INTEGRATED KEYBOARD —**

- 1 Shut down the computer.
- 2 Disconnect the external keyboard.
- 3 Turn on the computer.
- 4 From the Windows desktop, click the **Start** button, point to **Programs**→**Accessories**, and click **Notepad**.
- 5 Type some characters on the internal keyboard and verify that they appear on the display.  
If the characters appear now but did not with the external keyboard, you may have a defective external keyboard. Contact Dell. See "Contacting Dell" on page 145.

**RUN THE KEYBOARD DIAGNOSTICS TESTS —** Run the PC-AT Compatible Keyboards tests in the Dell Diagnostics (see page 77). If the tests indicate a defective external keyboard, contact Dell. See "Contacting Dell" on page 145.

**Unexpected characters**

**DISABLE THE NUMERIC KEYPAD —** Press <Num Lk> to disable the numeric keypad if numbers are displayed instead of letters. Verify that the numbers lock light is not lit.

## Lockups and Software Problems



**CAUTION:** Before you begin any of the procedures in this section, follow the safety instructions in the *Product Information Guide*.

**The computer does not start up**

**ENSURE THAT THE AC ADAPTER IS FIRMLY CONNECTED TO THE COMPUTER AND TO THE ELECTRICAL OUTLET**

**The computer stops responding**

**NOTICE:** You might lose data if you are unable to perform an operating system shutdown.

**TURN THE COMPUTER OFF —** If you are unable to get a response by pressing a key on your keyboard or moving your mouse, press and hold the power button for at least 8 to 10 seconds until the computer turns off. Then restart your computer.

**A program stops responding or crashes repeatedly**

**END THE PROGRAM —**

- 1 Press <Ctrl><Shift><Esc> simultaneously.
- 2 Click the **Applications** tab and select the program that is no longer responding.
- 3 Click **End Task**.



**NOTE:** The chkdsk program may run when you restart the computer. Follow the instructions on the screen.

**CHECK THE SOFTWARE DOCUMENTATION** — If necessary, uninstall and then reinstall the program. Software usually includes installation instructions in its documentation or on a floppy disk or CD.

### **A program is designed for an earlier Microsoft® Windows® operating system**

**RUN THE PROGRAM COMPATIBILITY WIZARD** — The Program Compatibility Wizard configures a program so it runs in an environment similar to non-Windows XP operating system environments.

- 1 Click the **Start** button, point to **All Programs**→**Accessories**, and then click **Program Compatibility Wizard**.
- 2 In the welcome screen, click **Next**.
- 3 Follow the instructions on the screen.

### **A solid blue screen appears**

**TURN THE COMPUTER OFF** — If you are unable to get a response by pressing a key on your keyboard or moving your mouse, press and hold the power button for at least 8 to 10 seconds until the computer turns off. Then restart your computer.

### **Dell MediaDirect problems**

**CHECK THE DELL MEDIADIRECT HELP FILE FOR INFORMATION** — Click the ? icon at the bottom of the Dell MediaDirect screen to access Help.

**TO PLAY MOVIES WITH DELL MEDIADIRECT, YOU MUST HAVE A DVD DRIVE AND THE DELL DVD PLAYER** — If you purchased a DVD drive with your computer, this software should already be installed.

**VIDEO QUALITY PROBLEMS** — Turn off the **Use Hardware Acceleration** option. This feature takes advantage of the special processing in some graphics cards to reduce processor requirements when playing DVDs and certain types of video files.

**CANNOT PLAY SOME MEDIA FILES** — Because Dell MediaDirect provides access to media files outside the Windows XP environment, access to licensed content is restricted. Licensed content is digital content that has Digital Rights Management (DRM) applied to it. The Dell MediaDirect environment cannot verify the DRM restrictions, so the licensed files cannot be played. Licensed music and video files have a lock icon next to them. You can access licensed files in the Windows XP environment.

**ADJUSTING THE COLOR SETTINGS FOR MOVIES THAT CONTAIN SCENES THAT ARE TOO DARK OR TOO BRIGHT** — Click **EagleVision** to use a video enhancement technology that detects video content and dynamically adjusts the brightness/contrast/saturation ratios.



**NOTICE:** You cannot reinstall the Dell MediaDirect feature if you voluntarily reformat the hard drive. Contact Dell for assistance. See "Contacting Dell" on page 145.

## Other software problems

### CHECK THE SOFTWARE DOCUMENTATION OR CONTACT THE SOFTWARE MANUFACTURER FOR TROUBLESHOOTING INFORMATION —

- Ensure that the program is compatible with the operating system installed on your computer.
- Ensure that your computer meets the minimum hardware requirements needed to run the software. See the software documentation for information.
- Ensure that the program is installed and configured properly.
- Verify that the device drivers do not conflict with the program.
- If necessary, uninstall and then reinstall the program.

### BACK UP YOUR FILES IMMEDIATELY

### USE A VIRUS-SCANNING PROGRAM TO CHECK THE HARD DRIVE, FLOPPY DISKS, OR CDs

### SAVE AND CLOSE ANY OPEN FILES OR PROGRAMS AND SHUT DOWN YOUR COMPUTER THROUGH THE Start MENU

**SCAN THE COMPUTER FOR SPYWARE** — If you are experiencing slow computer performance, you frequently receive pop-up advertisements, or you are having problems connecting to the Internet, your computer might be infected with spyware. Use an anti-virus program that includes anti-spyware protection (your program may require an upgrade) to scan the computer and remove spyware. For more information, go to [support.dell.com](http://support.dell.com) and search for the keyword *spyware*.

**RUN THE DELL DIAGNOSTICS** — If all tests run successfully, the error condition is related to a software problem. See "Dell Diagnostics" on page 77.

## Memory Problems

 **CAUTION:** Before you begin any of the procedures in this section, follow the safety instructions in the *Product Information Guide*.

### IF YOU RECEIVE AN INSUFFICIENT MEMORY MESSAGE —

- Save and close any open files and exit any open programs you are not using to see if that resolves the problem.
- See the software documentation for minimum memory requirements. If necessary, install additional memory (see "Memory" on page 112).
- Reseat the memory modules to ensure that your computer is successfully communicating with the memory (see "Memory" on page 112).
- Run the Dell Diagnostics (see page 77).

### IF YOU EXPERIENCE OTHER MEMORY PROBLEMS —

- Reseat the memory modules to ensure that your computer is successfully communicating with the memory (see "Memory" on page 112).

- Ensure that you are following the memory installation guidelines (see "Memory" on page 112).
- Run the Dell Diagnostics (see page 77).

## Network Problems

 **CAUTION:** Before you begin any of the procedures in this section, follow the safety instructions in the *Product Information Guide*.

**CHECK THE NETWORK CABLE CONNECTOR** — Ensure that the network cable is firmly inserted into both the network connector on the back of the computer and the network jack.

**CHECK THE NETWORK LIGHTS ON THE NETWORK CONNECTOR** — No light indicates that no network communication exists. Replace the network cable.

**RESTART THE COMPUTER AND LOG ON TO THE NETWORK AGAIN**

**CHECK YOUR NETWORK SETTINGS** — Contact your network administrator or the person who set up your network to verify that your network settings are correct and that the network is functioning.

## ExpressCard Problems

 **CAUTION:** Before you begin any of the procedures in this section, follow the safety instructions in the *Product Information Guide*.

**CHECK THE EXPRESSCARD** — Ensure that the ExpressCard is properly inserted into the connector.

**ENSURE THAT THE CARD IS RECOGNIZED BY WINDOWS** — Double-click the Safely Remove Hardware icon in the Windows taskbar. Ensure that the card is listed.

**IF YOU HAVE PROBLEMS WITH A DELL-PROVIDED EXPRESSCARD** — Contact Dell. See "Contacting Dell" on page 145.

**IF YOU HAVE PROBLEMS WITH AN EXPRESSCARD NOT PROVIDED BY DELL** — Contact the ExpressCard manufacturer.

## Power Problems

 **CAUTION:** Before you begin any of the procedures in this section, follow the safety instructions in the *Product Information Guide*.

**CHECK THE POWER LIGHT** — When the power light is lit or blinking, the computer has power. If the power light is blinking, the computer is in standby mode—press the power button to exit standby mode. If the light is off, press the power button to turn on the computer.

 **NOTE:** For information on standby mode, see "Power Management Modes" on page 41.

**CHARGE THE BATTERY** — The battery charge may be depleted.

- 1 Reinstall the battery.
- 2 Use the AC adapter to connect the computer to an electrical outlet.
- 3 Turn on the computer.

 **NOTE:** Battery operating time (the time the battery can hold a charge) decreases over time. Depending on how often the battery is used and the conditions under which it is used, you may need to purchase a new battery during the life of your computer.

**CHECK THE BATTERY STATUS LIGHT** — If the battery status light flashes orange or is a steady orange the battery charge is low or depleted. Connect the computer to an electrical outlet.

If the battery status light flashes green and orange, the battery is too hot to charge. Shut down the computer, disconnect the computer from the electrical outlet, and then let the battery and computer cool to room temperature.

If the battery status light rapidly flashes orange, the battery may be defective. Contact Dell. See "Contacting Dell" on page 145.

**CHECK THE BATTERY TEMPERATURE** — If the battery temperature is below 0°C (32°F), the computer will not start up.

**TEST THE ELECTRICAL OUTLET** — Ensure that the electrical outlet is working by testing it with another device, such as a lamp.

**CHECK THE AC ADAPTER** — Check the AC adapter cable connections. If the AC adapter has a light, ensure that the light is on.

**CONNECT THE COMPUTER DIRECTLY TO AN ELECTRICAL OUTLET** — Bypass power protection devices, power strips, and the extension cable to verify that the computer turns on.

**ELIMINATE POSSIBLE INTERFERENCE** — Turn off nearby fans, fluorescent lights, halogen lamps, or other appliances.

**ADJUST THE POWER PROPERTIES** — See "Power Management Modes" on page 41.

**RESEAT THE MEMORY MODULES** — If the computer power light turns on but the display remains blank, reinstall the memory modules (see "Memory" on page 112).

## Ensuring Sufficient Power for Your Computer

Your computer is designed to use the 90-W AC adapter; for optimum system performance, you should always use this adapter.

The 65-W AC adapters used in other Dell™ portable computers can be used with your computer, but they will decrease system performance. Using less-powerful AC adapters, including the 65-W AC adapter, will cause you to receive a WARNING message.

## Printer Problems

 **CAUTION:** Before you begin any of the procedures in this section, follow the safety instructions in the *Product Information Guide*.

 **NOTE:** If you need technical assistance for your printer, contact the printer's manufacturer.



**ENSURE THAT THE PRINTER IS TURNED ON**

**CHECK THE PRINTER CABLE CONNECTIONS —**

- See the printer documentation for cable connection information.
- Ensure that the printer cables are securely connected to the printer and the computer.

**TEST THE ELECTRICAL OUTLET —** Ensure that the electrical outlet is working by testing it with another device, such as a lamp.

**VERIFY THAT THE PRINTER IS RECOGNIZED BY WINDOWS —**

- 1 Click the **Start** button, click **Control Panel**, and then click **Printers and Other Hardware**.
- 2 Click **View installed printers or fax printers**.  
If the printer is listed, right-click the printer icon.
- 3 Click **Properties** and click the **Ports** tab. For a parallel printer, ensure that the **Print to the following port(s)**: setting is **LPT1 (Printer Port)**. For a USB printer, ensure that the **Print to the following port(s)**: setting is **USB**.

**REINSTALL THE PRINTER DRIVER —** See the printer documentation for instructions

## Scanner Problems



**CAUTION:** Before you begin any of the procedures in this section, follow the safety instructions in the *Product Information Guide*.



**NOTE:** If you need technical assistance for your scanner, contact the scanner's manufacturer.

**CHECK THE PRINTER DOCUMENTATION —** See the printer documentation for setup and troubleshooting information.

**CHECK THE SCANNER DOCUMENTATION —** See the scanner documentation for setup and troubleshooting information.

**UNLOCK THE SCANNER —** Ensure that your scanner is unlocked if it has a locking tab or button.

**RESTART THE COMPUTER AND TRY THE SCANNER AGAIN**

**CHECK THE CABLE CONNECTIONS —**

- See the scanner documentation for cable connection information.
- Ensure that the scanner cables are securely connected to the scanner and the computer.

**VERIFY THAT THE SCANNER IS RECOGNIZED BY MICROSOFT WINDOWS —**

- 1 Click the **Start** button, click **Control Panel**, and then click **Printers and Other Hardware**.
- 2 Click **Scanners and Cameras**.  
If your scanner is listed, Windows recognizes the scanner.

**REINSTALL THE SCANNER DRIVER —** See the scanner documentation for instructions.

## Sound and Speaker Problems



**CAUTION:** Before you begin any of the procedures in this section, follow the safety instructions in the *Product Information Guide*.

### No sound from integrated speakers

**ADJUST THE WINDOWS VOLUME CONTROL** — Double-click the speaker icon in the lower-right corner of your screen. Ensure that the volume is turned up and that the sound is not muted. Adjust the volume, bass, or treble controls to eliminate distortion.

**ADJUST THE VOLUME USING KEYBOARD SHORTCUTS** — Press <Fn><End> to disable (mute) or reenable the integrated speakers.

**REINSTALL THE SOUND (AUDIO) DRIVER** — See "Reinstalling Drivers and Utilities" on page 97.

### No sound from external speakers

**ENSURE THAT THE SUBWOOFER AND THE SPEAKERS ARE TURNED ON** — See the setup diagram supplied with the speakers. If your speakers have volume controls, adjust the volume, bass, or treble to eliminate distortion.

**ADJUST THE WINDOWS VOLUME CONTROL** — Click or double-click the speaker icon in the lower-right corner of your screen. Ensure that the volume is turned up and that the sound is not muted.

**DISCONNECT HEADPHONES FROM THE HEADPHONE CONNECTOR** — Sound from the speakers is automatically disabled when headphones are connected to the computer's front-panel headphone connector.

**TEST THE ELECTRICAL OUTLET** — Ensure that the electrical outlet is working by testing it with another device, such as a lamp.

**ELIMINATE POSSIBLE INTERFERENCE** — Turn off nearby fans, fluorescent lights, or halogen lamps to check for interference.

**REINSTALL THE AUDIO DRIVER** — See "Reinstalling Drivers and Utilities" on page 97.

**RUN THE DELL DIAGNOSTICS** (see page 77)



**NOTE:** The volume control in some MP3 players overrides the Windows volume setting. If you have been listening to MP3 songs, ensure that you did not turn the player volume down or off.

### No sound from headphones

**CHECK THE HEADPHONE CABLE CONNECTION** — Ensure that the headphone cable is securely inserted into the headphone connector (see "audio connectors" on page 20).

**ADJUST THE WINDOWS VOLUME CONTROL** — Click or double-click the speaker icon in the lower-right corner of your screen. Ensure that the volume is turned up and that the sound is not muted.

## Touch Pad or Mouse Problems

### CHECK THE TOUCH PAD SETTINGS —

- 1 Click the **Start** button, click **Control Panel**, and then click **Printers and Other Hardware**.
- 2 Click **Mouse**.
- 3 Try adjusting the settings.

**CHECK THE MOUSE CABLE** — Shut down the computer. Disconnect the mouse cable, check it for damage, and firmly reconnect the cable.

If you are using a mouse extension cable, disconnect it and connect the mouse directly to the computer.

### TO VERIFY THAT THE PROBLEM IS WITH THE MOUSE, CHECK THE TOUCH PAD —

- 1 Shut down the computer.
- 2 Disconnect the mouse.
- 3 Turn on the computer.
- 4 At the Windows desktop, use the touch pad to move the cursor around, select an icon, and open it.

If the touch pad operates correctly, the mouse may be defective.

**REINSTALL THE TOUCH PAD DRIVER** — See "Reinstalling Drivers and Utilities" on page 97.

## Video and Display Problems



**CAUTION:** Before you begin any of the procedures in this section, follow the safety instructions in the *Product Information Guide*.

### If the display is blank



**NOTE:** If you are using a program that requires a higher resolution than your computer supports, it is recommended that you attach an external monitor to your computer.

**CHECK THE BATTERY** — If you are using a battery to power your computer, the battery charge may be depleted. Connect the computer to an electrical outlet using the AC adapter, and turn on the computer.

**TEST THE ELECTRICAL OUTLET** — Ensure that the electrical outlet is working by testing it with another device, such as a lamp.

**CHECK THE AC ADAPTER** — Check the AC adapter cable connections. If the AC adapter has a light, ensure that the light is on.

**CONNECT THE COMPUTER DIRECTLY TO AN ELECTRICAL OUTLET** — Bypass power protection devices, power strips, and the extension cable to verify that the computer turns on.

**ADJUST THE POWER PROPERTIES** — Search for the keyword *standby* in the Windows Help and Support Center. To access the Help and Support Center, see page 13.

**SWITCH THE VIDEO IMAGE** — If your computer is attached to an external monitor, press <Fn><F8> to switch the video image to the display.

### **If the display is difficult to read**

**ADJUST THE BRIGHTNESS** — Press <Fn> and the up- or down-arrow key

**MOVE THE EXTERNAL SUBWOOFER AWAY FROM THE COMPUTER OR MONITOR** — If your external speaker system includes a subwoofer, ensure that the subwoofer is at least 60 cm (2 ft) away from the computer or external monitor.

**ELIMINATE POSSIBLE INTERFERENCE** — Turn off nearby fans, fluorescent lights, halogen lamps, or other appliances.

**ROTATE THE COMPUTER TO FACE A DIFFERENT DIRECTION** — Eliminate sunlight glare, which can cause poor picture quality.

#### **ADJUST THE WINDOWS DISPLAY SETTINGS** —

- 1 Click the **Start** button and then click **Control Panel**.
- 2 Click **Appearance and Themes**.
- 3 Click the area you want to change or click the **Display** icon.
- 4 Try different settings for **Color quality** and **Screen resolution**.

**SEE "ERROR MESSAGES"** — If an error message appears, see page 83.

### **If only part of the display is readable**

#### **CONNECT AN EXTERNAL MONITOR** —

- 1 Shut down your computer and connect an external monitor to the computer.
- 2 Turn on the computer and the monitor and adjust the monitor brightness and contrast controls.

If the external monitor works, the computer display or video controller may be defective. Contact Dell. See "Contacting Dell" on page 145.

## **Drivers**

### **What Is a Driver?**

A driver is a program that controls a device such as a printer, mouse, or keyboard. All devices require a driver program.

A driver acts like a translator between the device and any other programs that use the device. Each device has its own set of specialized commands that only its driver recognizes.

Dell ships your computer to you with required drivers already installed—no further installation or configuration is needed.

 **NOTICE:** The *Drivers and Utilities* CD may contain drivers for operating systems that are not on your computer. Ensure that you are installing software appropriate for your operating system.

Many drivers, such as the keyboard driver, come with your Microsoft® Windows® operating system. You may need to install drivers if you:

- Upgrade your operating system.
- Reinstall your operating system.
- Connect or install a new device.

## Identifying Drivers

If you experience a problem with any device, identify whether the driver is the source of your problem and, if necessary, update the driver.

- 1 Click the **Start** button and click **Control Panel**.
- 2 Under **Pick a Category**, click **Performance and Maintenance**.
- 3 Click **System**.
- 4 In the **System Properties** window, click the **Hardware** tab.
- 5 Click **Device Manager**.
- 6 Scroll down the list to see if any device has an exclamation point (a yellow circle with a [!]) on the device icon.

If an exclamation point is next to the device name, you may need to reinstall the driver or install a new driver. See "Reinstalling Drivers and Utilities" on page 97.

## Reinstalling Drivers and Utilities

 **NOTICE:** The Dell Support website at [support.dell.com](http://support.dell.com) and your *Drivers and Utilities* CD provide approved drivers for Dell™ computers. If you install drivers obtained from other sources, your computer might not work correctly.

## Using Windows XP Device Driver Rollback

If a problem occurs on your computer after you install or update a driver, use Windows XP Device Driver Rollback to replace the driver with the previously installed version.

- 1 Click the **Start** button and click **Control Panel**.
- 2 Under **Pick a Category**, click **Performance and Maintenance**.
- 3 Click **System**.
- 4 In the **System Properties** window, click the **Hardware** tab.
- 5 Click **Device Manager**.
- 6 Right-click the device for which the new driver was installed and click **Properties**.

- 7 Click the **Drivers** tab.
- 8 Click **Roll Back Driver**.

If Device Driver Rollback does not resolve the problem, then use System Restore to return your computer to the operating state that existed before you installed the new driver.

### Using the Drivers and Utilities CD

 **NOTE:** The *Drivers and Utilities* CD is optional and may not ship with your computer.

If using Device Driver Rollback or System Restore does not resolve the problem, then reinstall the driver from the *Drivers and Utilities* CD.

- 1 Save and close any open files, and exit any open programs.
- 2 Insert the *Drivers and Utilities* CD.

In most cases, the CD starts running automatically. If it does not, start Windows Explorer, click your CD drive directory to display the CD contents, and then double-click the **autorcd.exe** file. The first time that you run the CD, it might prompt you to install setup files. Click **OK**, and follow the instructions on the screen to continue.

- 3 From the **Language** drop-down menu in the toolbar, select your preferred language for the driver or utility (if available). A welcome screen appears.
- 4 Click **Next**.

The CD automatically scans your hardware to detect drivers and utilities used by your computer.

- 5 After the CD completes the hardware scan, you can also detect other drivers and utilities. Under **Search Criteria**, select the appropriate categories from the **System Model**, **Operating System**, and **Topic** drop-down menus.

A link or links appear(s) for the specific drivers and utilities used by your computer.

- 6 Click the link of a specific driver or utility to display information about the driver or utility that you want to install.
- 7 Click the **Install** button (if present) to begin installing the driver or utility. At the welcome screen, follow the screen prompts to complete the installation.

If no **Install** button is present, automatic installation is not an option. For installation instructions, either see the appropriate instructions in the following subsections, or click **Extract**, follow the extracting instructions, and then read the readme file.

If instructed to navigate to the driver files, click the CD directory on the driver information window to display the files associated with that driver.

## Manually Reinstalling Drivers



**NOTE:** If you are reinstalling an infrared sensor driver, you must first enable the infrared sensor in the system setup program before continuing with the driver installation. See "Reinstalling Drivers and Utilities" on page 97.

- 1 After extracting the driver files to your hard drive as described in the previous section, click the **Start** button and right-click **My Computer**.
- 2 Click **Properties**.
- 3 Click the **Hardware** tab and click **Device Manager**.
- 4 Double-click the type of device for which you are installing the driver (for example, **Modems** or **Infrared devices**).
- 5 Double-click the name of the device for which you are installing the driver.
- 6 Click the **Driver** tab and click **Update Driver**.
- 7 Click **Install from a list or specific location (Advanced)** and click **Next**.
- 8 Click **Browse** and browse to the location to which you previously copied the driver files.
- 9 When the name of the appropriate driver appears, click **Next**.
- 10 Click **Finish** and restart your computer.

## Resolving Software and Hardware Incompatibilities

If a device is either not detected during the operating system setup or is detected but incorrectly configured, you can use the Hardware Troubleshooter to resolve the incompatibility.

To start the Hardware Troubleshooter:

- 1 Click the **Start** button and click **Help and Support**.
- 2 Type `hardware troubleshooter` in the **Search** field and click the arrow to start the search.
- 3 Click **Hardware Troubleshooter** in the **Search Results** list.
- 4 In the **Hardware Troubleshooter** list, click **I need to resolve a hardware conflict on my computer**, and click **Next**.

## Restoring Your Operating System

You can restore your operating system in the following ways:

- Microsoft® Windows® XP System Restore returns your computer to an earlier operating state without affecting data files. Use System Restore as the first solution for restoring your operating system and preserving data files.

- Dell PC Restore by Symantec restores your hard drive to the operating state it was in when you purchased the computer. Dell PC Restore permanently deletes all data on the hard drive and removes any applications installed after you received the computer. Use PC Restore only if System Restore did not resolve your operating system problem.
- If you received an *Operating System* CD with your computer, you can use it to restore your operating system. However, using the *Operating System* CD also deletes all data on the hard drive. Use the CD *only* if System Restore did not resolve your operating system problem.

## Using Microsoft Windows XP System Restore

The Microsoft Windows XP operating system provides System Restore to allow you to return your computer to an earlier operating state (without affecting data files) if changes to the hardware, software, or other system settings have left the computer in an undesirable operating state. See the Windows Help and Support Center for information on using System Restore. To access help, see page 13.



**NOTICE:** Make regular backups of your data files. System Restore does not monitor your data files or recover them.



**NOTE:** The procedures in this document were written for the Windows default view, so they may not apply if you set your Dell™ computer to the Windows Classic view.

### Creating a Restore Point

- 1 Click the **Start** button and click **Help and Support**.
- 2 Click the task for **System Restore**.
- 3 Follow the instructions on the screen.

### Restoring the Computer to an Earlier Operating State

If problems occur after you install a device driver, use Device Driver Rollback (see page 97) to resolve the problem. If that is unsuccessful, then use System Restore.



**NOTICE:** Before you restore the computer to an earlier operating state, save and close any open files and exit any open programs. Do not alter, open, or delete any files or programs until the system restoration is complete.

- 1 Click the **Start** button, point to **All Programs**→**Accessories**→**System Tools**, and then click **System Restore**.
- 2 Ensure that **Restore my computer to an earlier time** is selected and click **Next**.
- 3 Click a calendar date to which you want to restore your computer.

The **Select a Restore Point** screen provides a calendar that allows you to see and select restore points. All calendar dates with available restore points appear in boldface type.



- 4 Select a restore point and click **Next**.

If a calendar date has only one restore point, then that restore point is automatically selected. If two or more restore points are available, click the restore point that you prefer.

- 5 Click **Next**.

The **Restoration Complete** screen appears after System Restore finishes collecting data and then the computer restarts.

- 6 After the computer restarts, click **OK**.

To change the restore point, you can either repeat the steps using a different restore point, or you can undo the restoration.

### Undoing the Last System Restore



**NOTICE:** Before you undo the last system restore, save and close all open files and exit any open programs. Do not alter, open, or delete any files or programs until the system restoration is complete.

- 1 Click the **Start** button, point to **All Programs**→**Accessories**→**System Tools**, and then click **System Restore**.
- 2 Click **Undo my last restoration** and click **Next**.

### Enabling System Restore

If you reinstall Windows XP with less than 200 MB of free hard-disk space available, System Restore is automatically disabled. To see if System Restore is enabled:

- 1 Click the **Start** button and click **Control Panel**.
- 2 Click **Performance and Maintenance**.
- 3 Click **System**.
- 4 Click the **System Restore** tab.
- 5 Ensure that **Turn off System Restore** is unchecked.

### Using Dell PC Restore by Symantec



**NOTICE:** Using Dell PC Restore permanently deletes all data on the hard drive and removes any applications or drivers installed after you received your computer. If possible, back up the data before using PC Restore. Use PC Restore only if System Restore did not resolve your operating system problem.



**NOTE:** Dell PC Restore by Symantec may not be available in certain countries nor on certain computers.

Use Dell PC Restore by Symantec only as the last method to restore your operating system. PC Restore restores your hard drive to the operating state it was in when you purchased the computer. Any programs or files added since you received your computer—including data files—are permanently deleted from the hard drive. Data files include documents, spreadsheets, e-mail messages, digital photos, music files, and so on. If possible, back up all data before using PC Restore.

To use PC Restore:

- 1 Turn on the computer.

During the boot process, a blue bar with **www.dell.com** appears at the top of the screen.

- 2 Immediately upon seeing the blue bar, press <Ctrl><F11>.

If you do not press <Ctrl><F11> in time, let the computer finish starting, and then restart the computer again.

 **NOTICE:** If you do not want to proceed with PC Restore, click **Reboot** in the following step.

- 3 On the next screen that appears, click **Restore**.

- 4 On the next screen, click **Confirm**.

The restore process takes approximately 6–10 minutes to complete.

- 5 When prompted, click **Finish** to reboot the computer.

 **NOTE:** Do not manually shut down the computer. Click **Finish** and let the computer completely reboot.

- 6 When prompted, click **Yes**.

The computer restarts. Because the computer is restored to its original operating state, the screens that appear, such as the End User License Agreement, are the same ones that appeared the first time the computer was turned on.

- 7 Click **Next**.

The **System Restore** screen appears and the computer restarts.

- 8 After the computer restarts, click **OK**.

### Removing Dell PC Restore

 **NOTICE:** Removing Dell PC Restore from the hard drive permanently deletes the PC Restore utility from your computer. After you have removed Dell PC Restore, you will not be able to use it to restore your computer's operating system.

Dell PC Restore enables you to restore your hard drive to the operating state it was in when you purchased your computer. It is recommended that you *do not* remove PC Restore from your computer, even to gain additional hard-drive space. If you remove PC Restore from the hard drive, you cannot ever recall it, and you will never be able to use PC Restore to return your computer's operating system to its original state.

To remove PC Restore:

- 1 Log on to the computer as a local administrator.
- 2 In Windows Explorer, go to `c:\dell\utilities\DSR`.

3 Double-click the filename **DSRIRRemv2.exe**.

 **NOTE:** If you do not log on as a local administrator, a message appears stating that you must log on as administrator. Click **Quit**, and then log on as a local administrator.

 **NOTE:** If the partition for PC Restore does not exist on your computer's hard drive, a message appears stating that the partition was not found. Click **Quit**; there is no partition to delete.

4 Click **OK** to remove the PC Restore partition on the hard drive.

5 Click **Yes** when a confirmation message appears.

The PC Restore partition is deleted and the newly available disk space is added to the free space allocation on the hard drive.

6 Right-click **Local Disk (C)** in Windows Explorer, click **Properties**, and verify that the additional disk space is available as indicated by the increased value for **Free Space**.

7 Click **Finish** to close the **PC Restore Removal** window.

8 Restart the computer.

## Using the Operating System CD

### Before You Begin

If you are considering reinstalling the Windows XP operating system to correct a problem with a newly installed driver, first try using Windows XP Device Driver Rollback (see page 97). If Device Driver Rollback does not resolve the problem, then use System Restore to return your operating system to the operating state it was in before you installed the new device driver. See "Using Microsoft Windows XP System Restore" on page 100.

 To reinstall Windows XP, you need the following items:

- Dell™ *Operating System* CD
- Dell *Drivers and Utilities* CD

 **NOTE:** The *Drivers and Utilities* CD contains drivers that were installed during assembly of the computer. Use the *Drivers and Utilities* CD to load any required drivers. Depending on the region from where you ordered your computer, or whether you requested the CDs, the *ResourceCD* and *Operating System* CD may not ship with your system.

### Reinstalling Windows XP

To reinstall Windows XP, perform all the steps in the following sections in the order in which they are listed.

The reinstallation process can take 1 to 2 hours to complete. After you reinstall the operating system, you must also reinstall the device drivers, virus protection program, and other software.

 **NOTICE:** The *Operating System* CD provides options for reinstalling Windows XP. The options can overwrite files and possibly affect programs installed on your hard drive. Therefore, do not reinstall Windows XP unless a Dell technical support representative instructs you to do so.

-  **NOTICE:** To prevent conflicts with Windows XP, disable any virus protection software installed on your computer before you reinstall Windows XP. See the documentation that came with the software for instructions.
- 1 Save and close any open files and exit any open programs.
  - 2 Insert the *Operating System* CD. Click **Exit** if the **Install Windows XP** message appears.
  - 3 Restart the computer.
  - 4 Press <F2> immediately after the DELL™ logo appears.  
If the operating system logo appears, wait until you see the Windows desktop, and then shut down the computer and try again.
  - 5 Press the arrow keys to select **CD-ROM**, and press <Enter>.
  - 6 When the **Press any key to boot from CD** message appears, press any key.
  - 7 When the **Windows XP Setup** screen appears, press <Enter>.
  - 8 Follow the instructions on the screen to complete the reinstallation.
  - 9 When the operating system reinstallation completes, reinstall drivers and applications as necessary.

# Adding and Replacing Parts

## Before You Begin

This chapter provides procedures for removing and installing the components in your computer. Unless otherwise noted, each procedure assumes that the following conditions exist:

- You have performed the steps in "Turning Off Your Computer" (see this page) and "Before Working Inside Your Computer" (see page 106).
- You have read the safety information in your Dell™ *Product Information Guide*.
- A component can be replaced—or if purchased separately—installed by performing the removal procedure in reverse order.

## Recommended Tools

The procedures in this document may require the following tools:

- Small flat-blade screwdriver
- Phillips screwdriver
- Small plastic scribe
- Flash BIOS update (see the Dell Support website at [support.dell.com](http://support.dell.com))

## Turning Off Your Computer





**NOTICE:** To avoid losing data, save and close any open files and exit any open programs before you turn off your computer.

- 1 Shut down the operating system:
  - a Save and close any open files, exit any open programs, click the **Start** button, and then click **Turn Off Computer**.
  - b In the **Turn off computer** window, click **Turn off**.  
The computer turns off after the operating system shutdown process finishes.
- 2 Ensure that the computer and any attached devices are turned off. If your computer and attached devices did not automatically turn off when you shut down your operating system, press and hold the power button for 4 seconds.

## Before Working Inside Your Computer

Use the following safety guidelines to help protect your computer from potential damage and to help ensure your own personal safety.

 **CAUTION:** Before you begin any of the procedures in this section, follow the safety instructions in the *Product Information Guide*.

 **CAUTION:** Handle components and cards with care. Do not touch the components or contacts on a card. Hold a card by its edges or by its metal mounting bracket. Hold a component such as a processor by its edges, not by its pins.

 **NOTICE:** Only a certified service technician should perform repairs on your computer. Damage due to servicing that is not authorized by Dell is not covered by your warranty.

 **NOTICE:** When you disconnect a cable, pull on its connector or on its strain-relief loop, not on the cable itself. Some cables have a connector with locking tabs; if you are disconnecting this type of cable, press in on the locking tabs before you disconnect the cable. As you pull connectors apart, keep them evenly aligned to avoid bending any connector pins. Also, before you connect a cable, ensure that both connectors are correctly oriented and aligned.

 **NOTICE:** To avoid damaging the computer, perform the following steps before you begin working inside the computer.

- 1 Ensure that the work surface is flat and clean to prevent the computer cover from being scratched.
- 2 Turn off your computer. See "Turning Off Your Computer" on page 105.

 **NOTICE:** To disconnect a network cable, first unplug the cable from your computer and then unplug it from the network wall jack.

- 3 Disconnect any telephone or network cables from the computer.

 **NOTICE:** To avoid damaging the system board, you must remove the main battery before you service the computer.

- 4** Disconnect your computer and all attached devices from their electrical outlets.
- 5** Remove the battery.  
Slide and hold the battery-bay latch release on the bottom of the computer, and then pull the battery out of the battery bay.

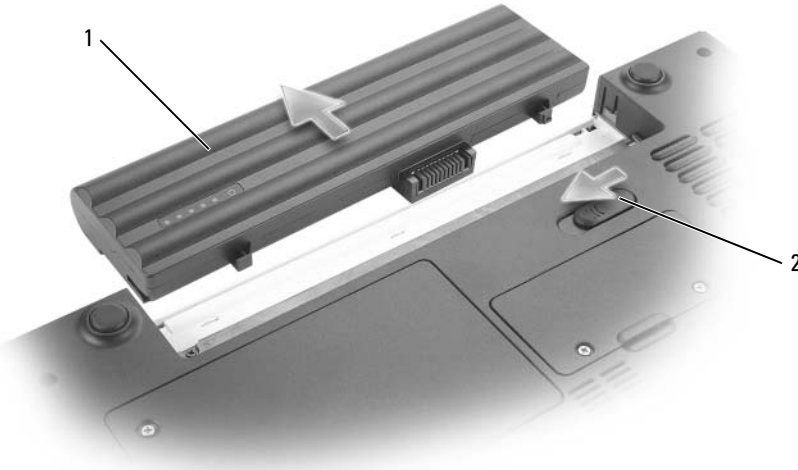

1 battery                      2 battery-bay latch release

- 6** Remove the optical drive, if installed, from the optical drive bay. See "Optical Drives" on page 111.
- 7** Press the power button to ground the system board.
- 8** Remove any installed ExpressCards from the ExpressCard slot. See "Removing an ExpressCard or Blank" on page 68.
- 9** Remove any installed media memory cards from the 5-in-1 media memory card reader. See "Removing a Media Memory Card or Blank" on page 72.
- 10** Close the display and turn the computer upside down on a flat work surface.
- 11** Remove the hard drive. See "Hard Drive" on page 108.

# Battery

## Removing a Battery

 **CAUTION:** Before performing these procedures, disconnect the modem from the telephone wall jack.

 **NOTICE:** If you choose to replace the battery with the computer in standby mode, you have up to 1 minute to complete the battery replacement before the computer shuts down and loses any unsaved data.

- 1 Ensure that the computer is turned off or suspended in a power management mode.
- 2 Slide and hold the battery-bay latch release on the bottom of the computer, and then remove the battery from the bay by pulling it straight out from the computer.

 **NOTE:** The 6-cell battery is flush with the back of the computer. The 9-cell battery extends beyond the back of the computer.

## Installing a Battery

 **CAUTION:** Using an incompatible battery may increase the risk of fire or explosion. Replace the battery only with a compatible battery purchased from Dell. The battery is designed to work with your Dell computer. Do not use a battery from other computers with your computer.

Slide the battery into the bay until the latch release clicks.

# Hard Drive

 **CAUTION:** If you remove the hard drive from the computer when the drive is hot, *do not touch* the metal housing of the hard drive.

 **CAUTION:** Before you begin any of the procedures in this section, follow the safety instructions in the *Product Information Guide*.

 **NOTICE:** To prevent data loss, turn off your computer (see page 105) before removing the hard drive. Do not remove the hard drive while the computer is on, in standby mode, or in hibernate mode.

 **NOTICE:** Hard drives are extremely fragile; even a slight bump can damage the drive.

 **NOTE:** Dell does not guarantee compatibility or provide support for hard drives from sources other than Dell.

 **NOTE:** If you are installing a hard drive from a source other than Dell, you need to install an operating system, drivers, and utilities on the new hard drive.

To replace the hard drive in the hard drive bay:

- 1 Follow the procedures in "Before You Begin" on page 105.
- 2 Turn the computer over, and loosen the two captive screws in the hard drive cover.



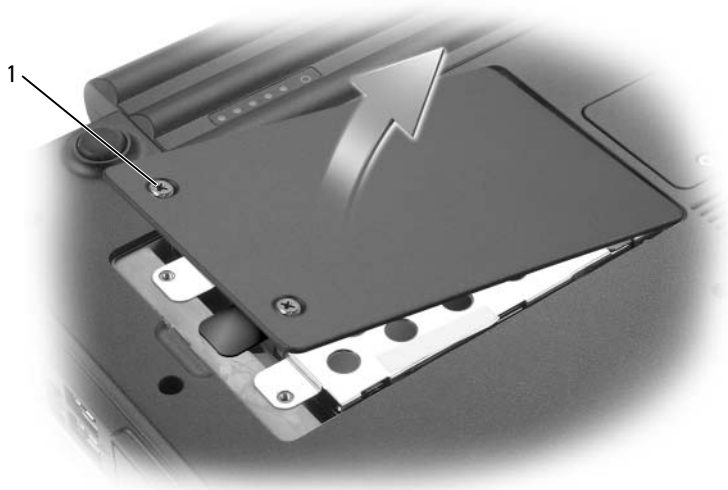

1 screws (2)

- ➔ **NOTICE:** When the hard drive is not in the computer, store it in protective antistatic packaging. See "Protecting Against Electrostatic Discharge" in the *Product Information Guide*.
- 3 Lift the cover off the computer and set it aside.
  - 4 Use the pull-tab to slide the hard drive toward the screw holes, and then lift the hard drive straight up to remove it from the computer.

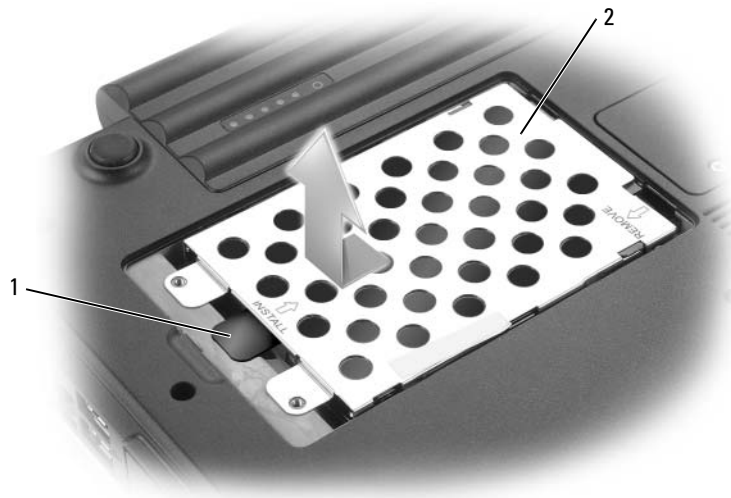

- 1 pull-tab                      2 hard drive

- 5 Remove the new drive from its packaging.  
Save the original packaging for storing or shipping the hard drive.
- ➔ **NOTICE:** Use firm and even pressure to slide the drive into place. If you use excessive force, you may damage the connector.
- 6 Seat the new hard drive into the bay, and then slide it into the connector by sliding it away from the screw holes until it is fully seated.
- 7 Replace the cover and tighten the screws.
- 8 Install the operating system for your computer. See "Restoring Your Operating System" on page 99.
- 9 Install the drivers and utilities for your computer. See "Reinstalling Drivers and Utilities" on page 97.

## Returning a Hard Drive to Dell

Return your old hard drive to Dell in its original or comparable foam packaging. Otherwise, the hard drive may be damaged in transit.

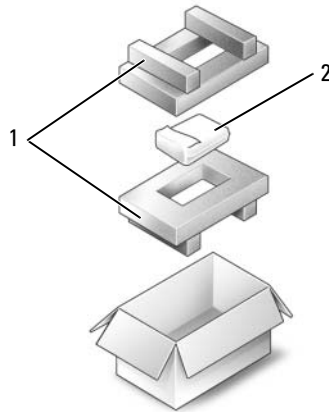

1 foam packaging

2 hard drive

## Optical Drives

### About the Device Security Screw

 **NOTE:** You do not need to install the device security screw unless you want to prevent the module from being easily removed.

Your Dell™ computer ships with an optical drive installed in the module bay and a device security screw, which may not be installed in the optical drive but packaged separately. When you install a module in the bay, you can install the device security screw to prevent the module from being easily removed.

### Removing and Installing Optical Drives

 **NOTICE:** To prevent damage to drives, store them in a safe, dry place when they are not installed in the computer. Avoid pressing down on them or placing heavy objects on top of them.

- 1 While the computer is turned on, double-click the **Safely Remove Hardware** icon on the taskbar, click the device that you want to eject, and click **Stop**.
- 2 Close your display and turn the computer upside-down.
- 3 Use a Phillips screwdriver to remove the device security screw from the bottom of the computer.

- 4 Insert a Phillips screwdriver into the screw hole to push the drive out of the module bay.

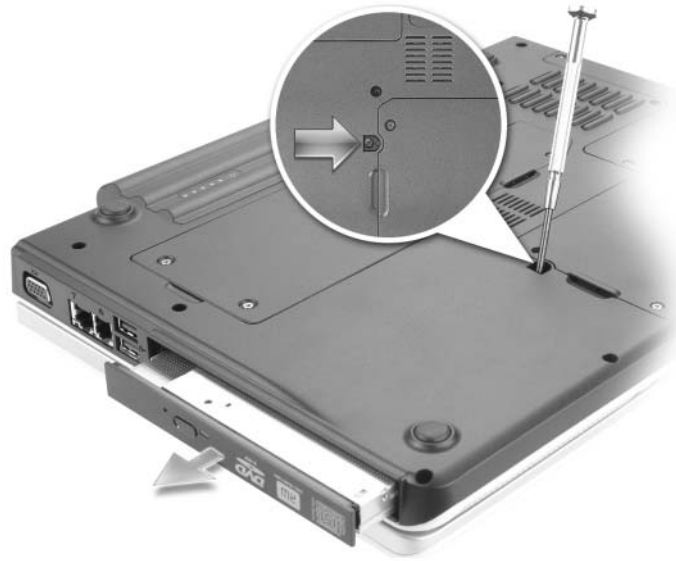

- 5 Pull the drive straight out of the module bay.
- 6 Push the new drive straight into the module bay until it clicks.
- 7 Replace the security device screw.
- 8 Turn the computer right-side up and open the display.
- 9 The operating system automatically recognizes the drive. If necessary, enter your password to unlock your computer.

## Memory

You can increase your computer memory by installing memory modules on the system board. See "Specifications" on page 131 for information on the memory supported by your computer. Install only memory modules that are intended for your computer.

 **NOTE:** Memory modules purchased from Dell are covered under your computer warranty.

 **CAUTION:** Before you begin any of the procedures in this section, follow the safety instructions in the *Product Information Guide*.

The computer has two memory module connectors labeled "DIMM A" and "DIMM B." Connector DIMM A (located under the keyboard) holds the basic memory module as configured from the factory. If you did not order additional memory, connector DIMM B (located on the bottom of the computer under the memory module cover) will be empty. Generally, if you are adding memory,

you will install a memory module in connector DIMM B. If you are upgrading memory, you may need to install memory in both the DIMM A and B connectors, depending on the extent of the upgrade.

### Installing a Memory Module in Connector DIMM B

- 1 Follow the procedures in "Before You Begin" on page 105.
  - 2 Ground yourself by touching one of the metal connectors on the back of the computer.
-  **NOTE:** If you leave the area, ground yourself again when you return to the computer.
- 3 Turn the computer over, loosen the captive screws on the memory module cover, and then remove the memory module cover.

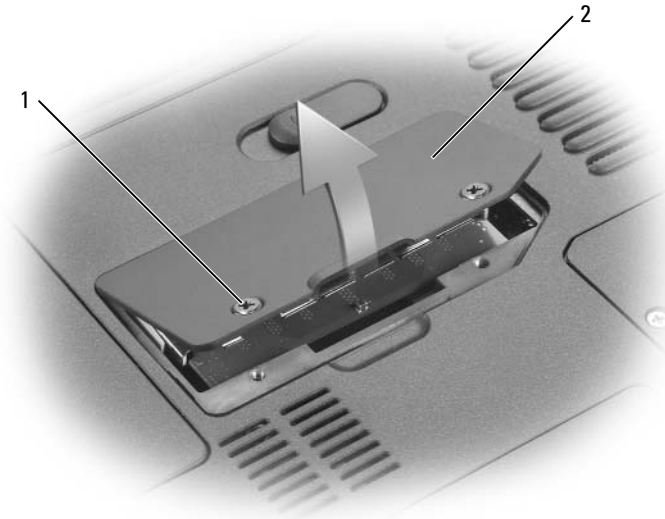

1 screws (2)

2 memory module cover

- ➔ NOTICE:** To prevent damage to the memory module connector, do not use tools to spread the memory-module securing clips.
- 4** If you are replacing a memory module, remove the existing module:
- a** Use your fingertips to carefully spread apart the securing clips on each end of the memory module connector until the module pops up.
  - b** Remove the module from the connector.

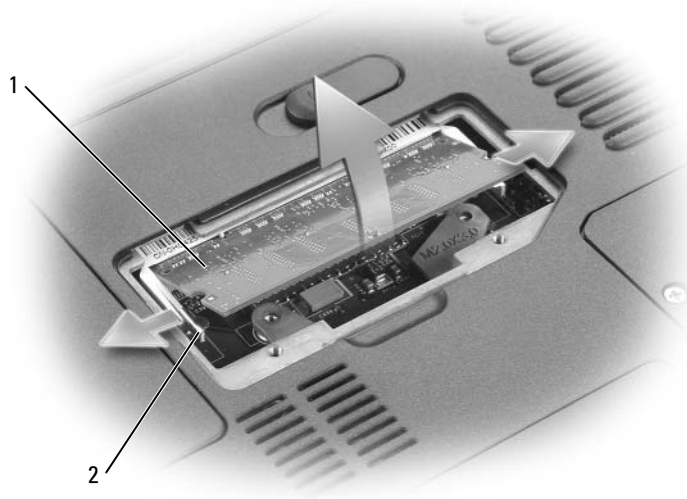

- 1 memory module                      2 securing clips  
(2 per connector)

- ➔ NOTICE:** If you need to install memory modules in two connectors, install a memory module in the connector labeled “DIMM A” before you install a module in the connector labeled “DIMM B.” Insert memory modules at a 45-degree angle to avoid damaging the connector.
- 🔧 NOTE:** If the memory module is not installed properly, the computer may not boot properly. No error message indicates this failure.
- 5** Ground yourself and install the new memory module:
- a** Align the notch in the module edge connector with the tab in the connector slot.
  - b** Slide the module firmly into the slot at a 45-degree angle, and rotate the module down until it clicks into place. If you do not feel the click, remove the module and reinstall it.

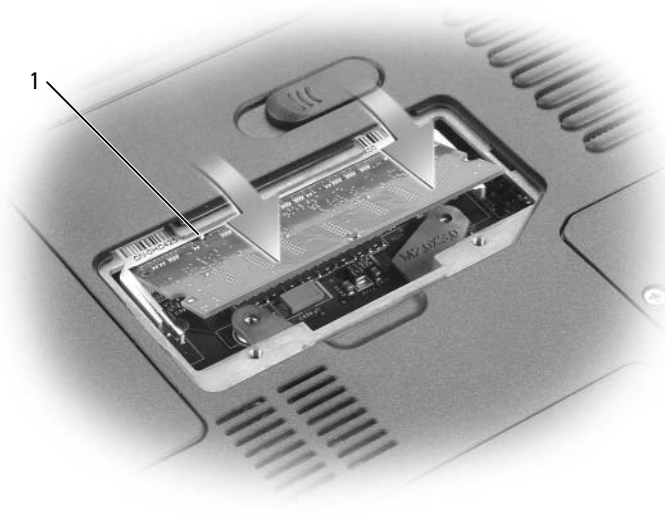

1 tab in connector slot

6 Replace the memory module cover and tighten the screws.

➔ **NOTICE:** If the cover is difficult to close, remove the module and reinstall it. Forcing the cover to close may damage your computer.

7 Insert the battery into the battery bay, or connect the AC adapter to your computer and an electrical outlet.

8 Reinstall the hard drive. See "Hard Drive" on page 108.

9 Turn on the computer.

As the computer boots, it detects the additional memory and automatically updates the system configuration information.

To confirm the amount of memory installed in the computer, click the **Start** button, click **Help and Support**, and then click **Computer Information**.

### Installing a Memory Module in Connector DIMM A

The memory module connector labeled "DIMM A" is located under the keyboard.

1 Follow the procedures in "Before You Begin" on page 105.

2 Ground yourself by touching one of the metal connectors on the back of the computer.

🔧 **NOTE:** If you leave the area, ground yourself again when you return to the computer.

- 3 Remove the hinge cover. See "Hinge Cover" on page 123.

 **NOTE:** Ensure that you remove the two screws in the battery bay as part of the hinge removal procedure.

- 4 Remove the keyboard. See "Keyboard" on page 125.
- 5 Loosen the captive screws on the memory module cover, and then remove the memory module cover.

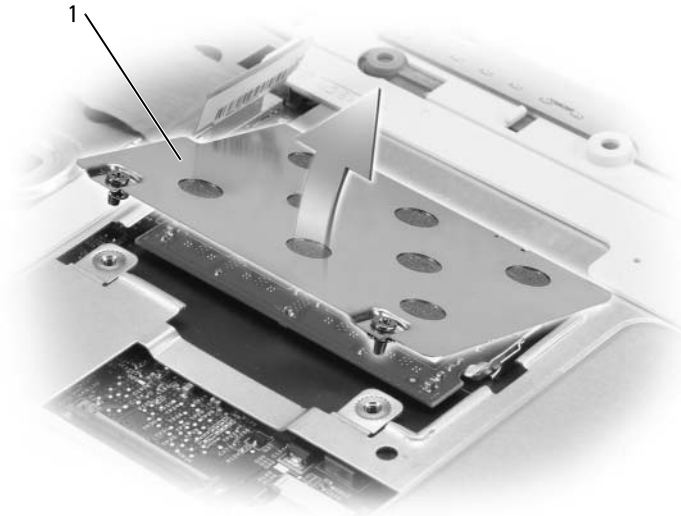

1 tab in connector slot

 **NOTICE:** To prevent damage to the memory module connector, do not use tools to spread the memory-module securing clips.

- 6 If you are replacing a memory module, remove the existing module:
  - a Use your fingertips to carefully spread apart the securing clips on each end of the memory module connector until the module pops up.
  - b Remove the module from the connector.



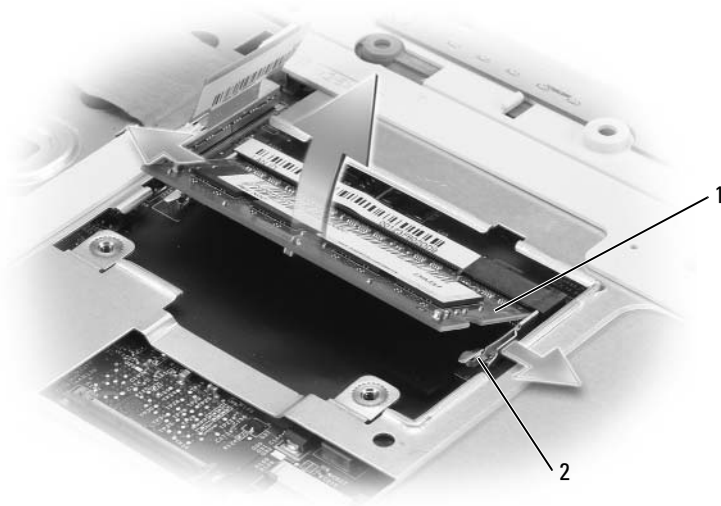

- 1 memory module                      2 securing clips  
(2 per connector)

**➔ NOTICE:** If you need to install memory modules in two connectors, install a memory module in the connector labeled “DIMM A” before you install a module in the connector labeled “DIMM B.” Insert memory modules at a 45-degree angle to avoid damaging the connector.

**🔧 NOTE:** If the memory module is not installed properly, the computer may not boot properly. No error message indicates this failure.

**7** Ground yourself and install the new memory module:

- a** Align the notch in the module edge connector with the tab in the connector slot.
- b** Slide the module firmly into the slot at a 45-degree angle, and rotate the module down until it clicks into place. If you do not feel the click, remove the module and reinstall it.

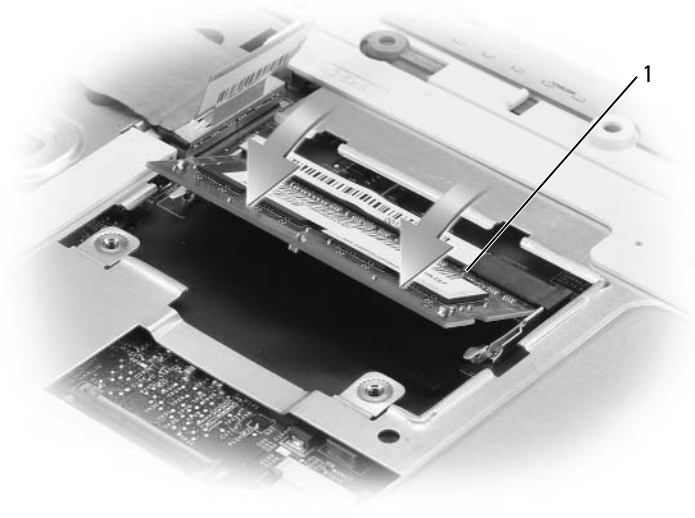

1 tab in connector slot

- 8 Replace the memory module cover and tighten the screws.
- ➔ **NOTICE:** If the cover is difficult to close, remove the module and reinstall it. Forcing the cover to close may damage your computer.
- 9 Replace the keyboard. See "Keyboard" on page 125.
- 10 Replace the hinge cover. See "Hinge Cover" on page 123.
  - 🔩 **NOTE:** Ensure that you replace the two screws inside the battery bay as part of the hinge replacement procedure.
- 11 Insert the battery into the battery bay, or connect the AC adapter to your computer and an electrical outlet.
- 12 Reinstall the hard drive. See "Hard Drive" on page 108.
- 13 Turn on the computer.

As the computer boots, it detects the additional memory and automatically updates the system configuration information.

To confirm the amount of memory installed in the computer, click the **Start** button, click **Help and Support**, and then click **Computer Information**.

## Modem (Optional)

If you ordered the optional modem at the same time that you ordered your computer, the modem is already installed.

**⚠ CAUTION:** Before you begin any of the procedures in this section, follow the safety instructions in the *Product Information Guide*.

- 1 Follow the procedures in "Before You Begin" on page 105.
- 2 Turn the computer over, loosen the captive screws on the modem/Mini PCI/wireless cover, and then remove the cover.

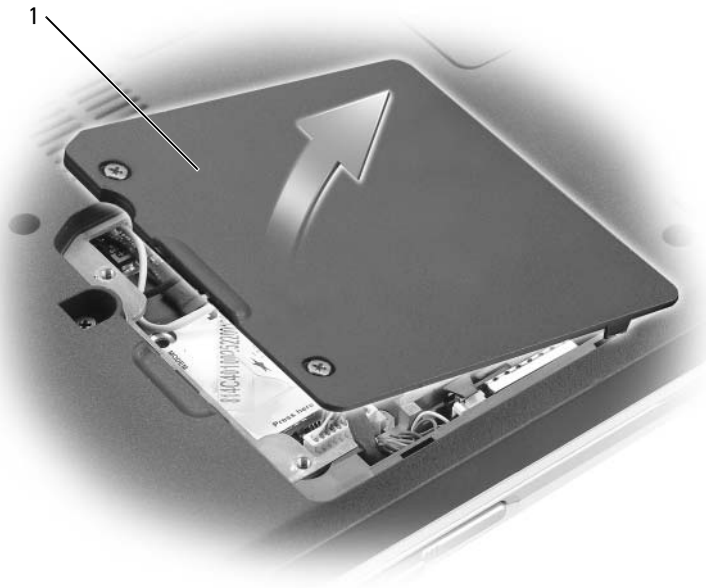

- 1 modem/Mini  
PCI/wireless cover

- 3** Remove the existing modem:
- Remove the screw securing the modem to the system board, and set it aside.
  - Pull straight up on the attached pull-tab to lift the modem out of its connector on the system board, and disconnect the modem cable.

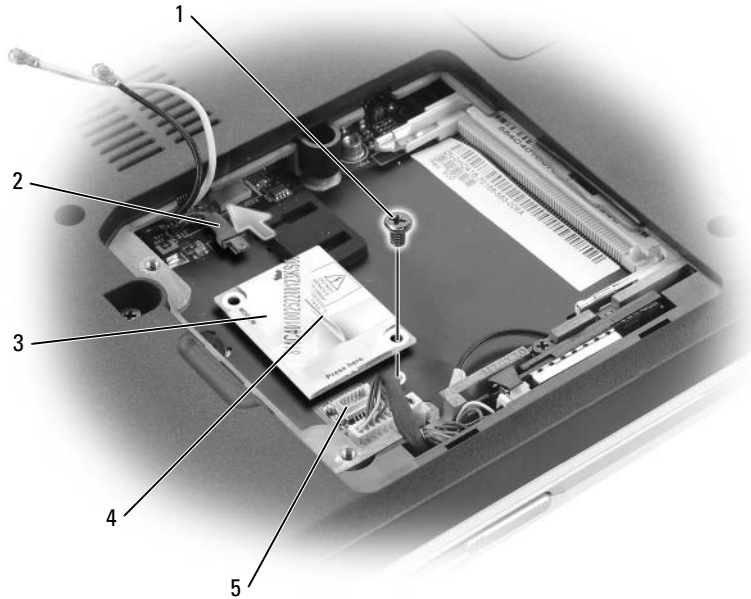

- |   |             |   |          |   |                        |
|---|-------------|---|----------|---|------------------------|
| 1 | screw       | 3 | modem    | 5 | system board connector |
| 2 | modem cable | 4 | pull-tab |   |                        |

- 4** Install the replacement modem:
- Connect the modem cable to the modem.
- ➔ NOTICE:** The connectors are keyed to ensure correct insertion. If you feel resistance, check the connectors and realign the card.
- Align the modem with the screw holes and press the modem into the connector on the system board.
  - Replace the screw that secures the modem to the system board.
- 5** Replace the modem/Mini PCI/wireless cover.

## Wireless Mini PCI Card

If you ordered a Mini PCI card with your computer, the card is already installed.

**⚠ CAUTION:** Before you begin any of the procedures in this section, follow the safety instructions in the *Product Information Guide*.

- 1 Follow the procedures in "Before You Begin" on page 105.
- 2 If a Mini PCI card is not already installed, go to step . If you are replacing a Mini PCI card, remove the existing card:
  - a Disconnect the antenna cables from the Mini PCI card.

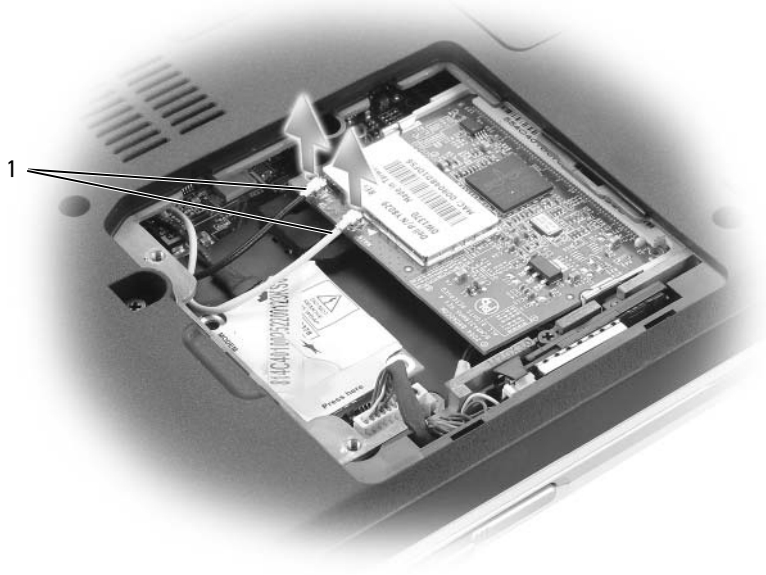

1 antenna cables

- b Release the Mini PCI card by spreading the metal securing tabs until the card pops up slightly.
- c Lift the Mini PCI card out of its connector.

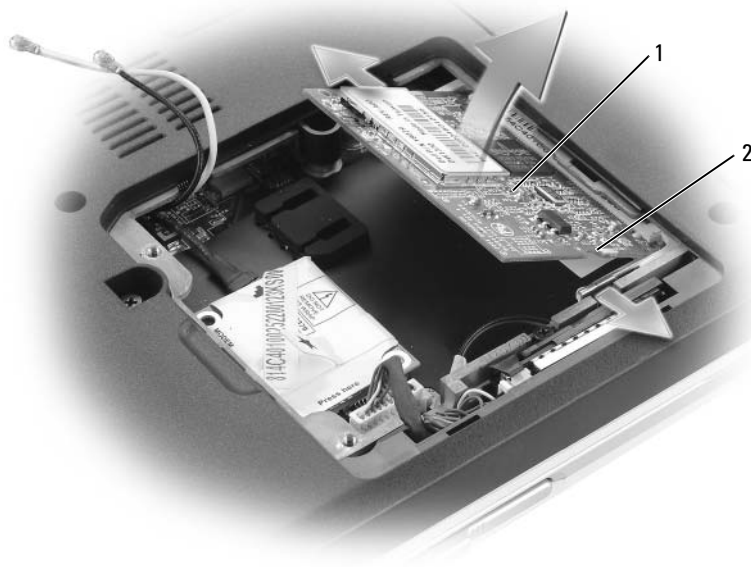

- 1 Mini PCI card                      2 metal securing tabs (2)

➔ **NOTICE:** The connectors are keyed to ensure correct insertion. If you feel resistance, check the connectors and realign the card.

3 Install the replacement Mini PCI card:

➔ **NOTICE:** To avoid damaging the Mini PCI card, make sure the antenna cables are not under the card when you click the card into place.

- a Align the Mini PCI card with the connector at a 45-degree angle, and press the Mini PCI card into the connector until it clicks.
- b Connect the antenna cables to the Mini PCI card. Make sure the cables snap onto the tiny connectors on the Mini PCI card.

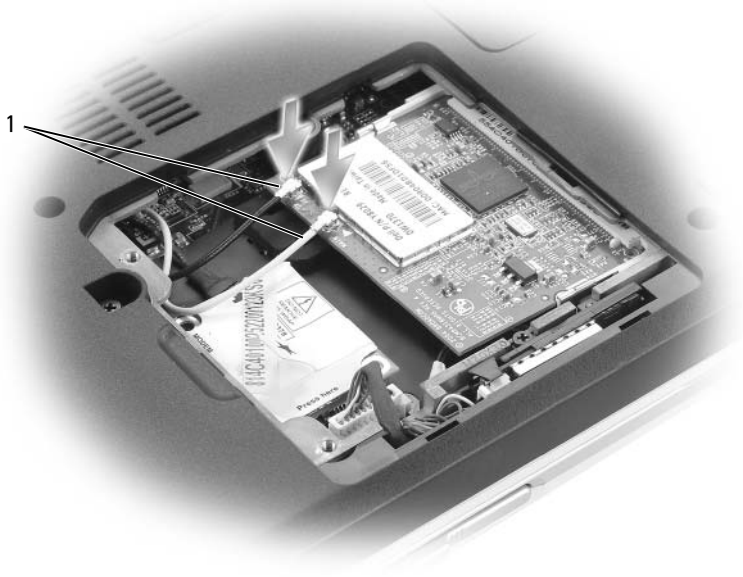

1 antenna cables

## Hinge Cover

### Removing the Hinge Cover

 **CAUTION:** Before you begin any of the procedures in this section, follow the safety instructions in the *Product Information Guide*.

 **NOTICE:** To avoid electrostatic discharge, ground yourself by using a wrist grounding strap or by periodically touching an unpainted metal surface (such as a connector on the back of the computer).

➔ **NOTICE:** To avoid damaging the system board, you must remove the main battery before you begin working inside the computer.

➔ **NOTICE:** The hinge cover is fragile and can be damaged if extreme force is used. Be careful when removing the hinge cover.

- 1 Follow the procedures in "Before You Begin" on page 105.
- 2 Remove the battery (see page 108).
- 3 Remove the two screws inside the battery bay.



1 screws (2)

4 Turn the computer right-side up, and then open the display all the way (180 degrees) so that it rests on your work surface.

➔ **NOTICE:** To avoid damaging the hinge cover, do not lift the cover on both sides simultaneously.

5 Insert a scribe into the indent to lift the hinge cover on the right side.



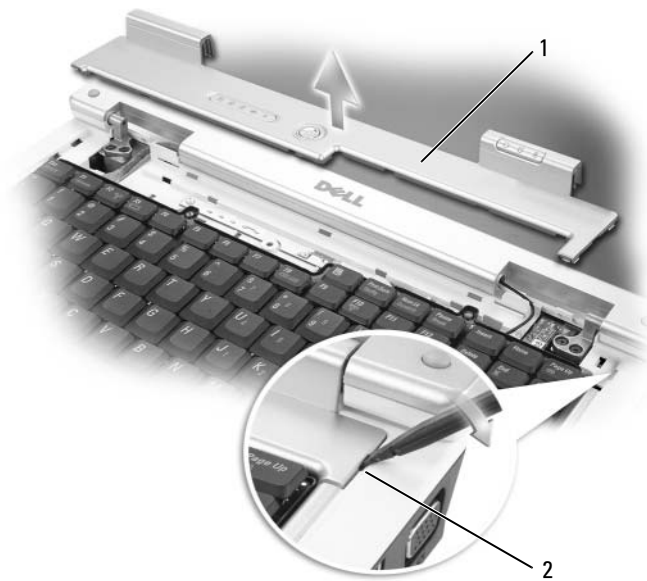

1 hinge cover

2 indent

- 6 Ease the hinge cover up, moving from right to left, and remove it.

## Replacing the Hinge Cover

- 1 Insert the left edge of the cover into place.
- 2 Press from left to right until the cover snaps into place.
- 3 Close the display and turn the computer upside down.
- 4 Replace the two screws in the battery bay.
- 5 Replace the battery (see page 108).

## Keyboard

**⚠ CAUTION:** Before you begin any of the procedures in this section, follow the safety instructions in the *Product Information Guide*.

**➡ NOTICE:** To avoid electrostatic discharge, ground yourself by using a wrist grounding strap or by periodically touching an unpainted metal surface (such as a connector on the back of the computer).

**➡ NOTICE:** To avoid damaging the system board, you must remove the main battery before you begin working inside the computer.

## Removing the Keyboard

- 1 Follow the procedures in "Before You Begin" on page 105.
- 2 Remove the hinge cover. See "Hinge Cover" on page 123.
-  **NOTICE:** The keycaps on the keyboard are fragile, easily dislodged, and time-consuming to replace. Be careful when removing and handling the keyboard.
- 3 Lift the keyboard and hold it up and slightly forward to allow access to the keyboard connector.
- 4 Release the lever on the system board connector to disconnect the keyboard cable from the system board.

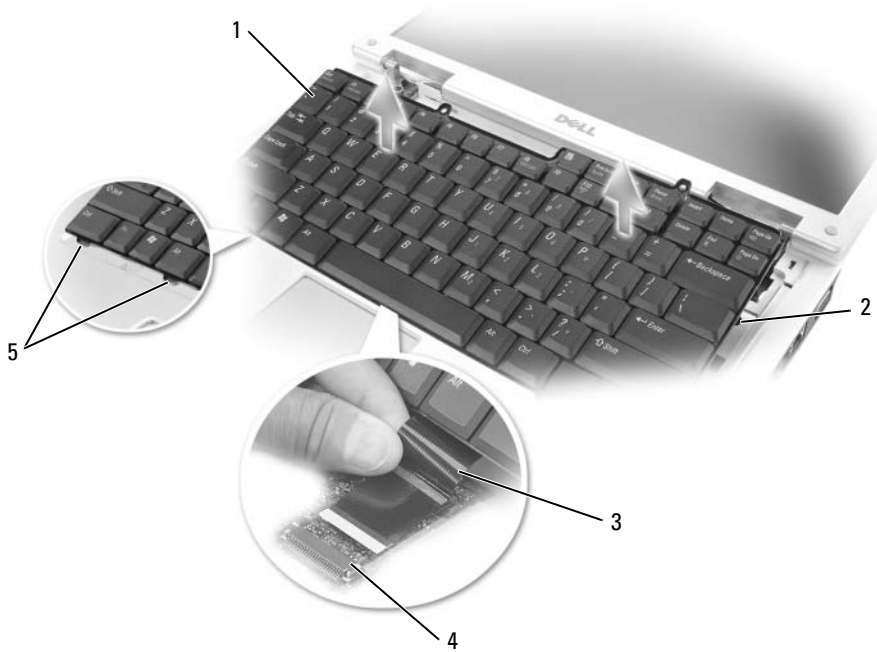

- |   |               |   |                                 |   |          |
|---|---------------|---|---------------------------------|---|----------|
| 1 | keyboard      | 3 | keyboard cable                  | 5 | tabs (6) |
| 2 | side tabs (2) | 4 | lever on system board connector |   |          |

## Replacing the Keyboard

- ➔ **NOTICE:** To avoid scratching the palm rest when replacing the keyboard, hook the six tabs along the front edge of the keyboard into the palm rest, and then secure the keyboard in place.
- 1 Connect the keyboard cable to the system board.
- 2 Place the six tabs along the front edge of the keyboard into the palm rest.
- 3 Fasten the keyboard cable with the lever on the system board connector.
- 4 Snap the keyboard into place under the two side tabs.

## Internal Card With Bluetooth<sup>®</sup> Wireless Technology

 **CAUTION:** Before you begin any of the procedures in this section, follow the safety instructions in the *Product Information Guide*.

- ➔ **NOTICE:** To avoid electrostatic discharge, ground yourself by using a wrist grounding strap or by periodically touching an unpainted metal surface (such as a connector on the back of the computer).
- ➔ **NOTICE:** To avoid damaging the system board, you must remove the main battery before you begin working inside the computer.

If you ordered a card with Bluetooth wireless technology with your computer, the card is already installed.

- 1 Follow the procedures in "Before You Begin" on page 105.
- 2 Loosen the captive screws in the modem/Mini PCI/wireless cover, and then remove the cover.
- 3 Remove the screw securing the card carrier.
- 4 Pull the carrier out of the compartment so that you can disconnect the card from its cable and remove the card from the computer.
- 5 To replace the card, connect the card to the cable.
- 6 Then carefully insert the card into the carrier and insert the carrier into the compartment.
- 7 Replace the screw securing the card carrier into place.

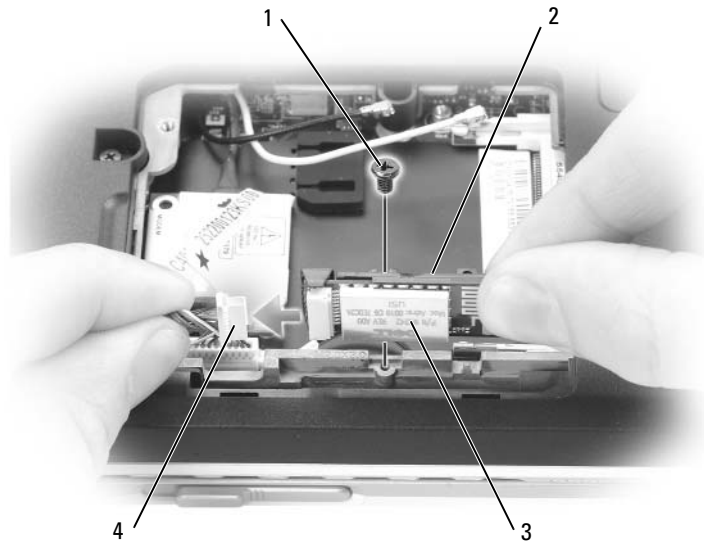

- |   |              |   |                |
|---|--------------|---|----------------|
| 1 | screw        | 3 | card           |
| 2 | card carrier | 4 | card connector |

## Coin-Cell Battery

### Removing the Coin-Cell Battery

**⚠ CAUTION:** Before you perform the following procedures, see the safety instructions in the *Product Information Guide*.

**➡ NOTICE:** To avoid electrostatic discharge, ground yourself by using a wrist grounding strap or by periodically touching an unpainted metal surface (such as the back panel) on the computer.

**➡ NOTICE:** To avoid damaging the system board, you must remove the main battery before you begin working inside the computer.

- 1 Follow the procedures in "Before You Begin" on page 105.
- 2 Remove the hinge cover (see page 123).
- 3 Remove the keyboard (see page 125).
- 4 Use a plastic scribe to lift the battery upward to remove it from the system board.

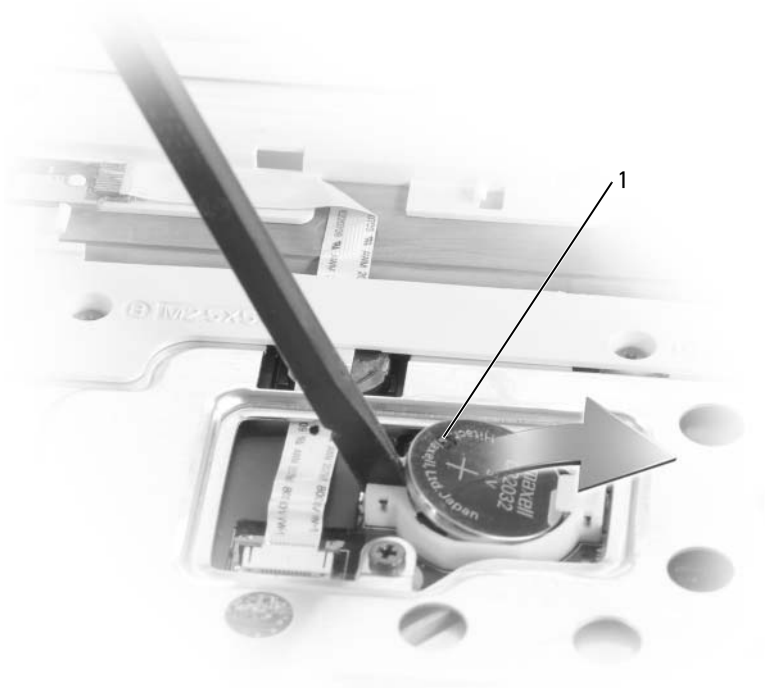

1 coin-cell battery

### **Replacing the Coin-Cell Battery**

When you replace the battery, insert it into the circular socket with the positive side up, and then push it into place.



# Appendix

## Specifications

---

### Processor

---

Processor type	Intel® Pentium® M or Intel Celeron® M
L1 cache	32-KB I-cache 32-KB D-cache
L2 cache	2 MB
External bus frequency (front side bus)	400 MHz and 533 MHz

---

### System Information

---

System chip set	Mobile Intel 915 GM Express
Data bus width	64 bits
DRAM bus width	dual-channel (2) 64-bit buses
Processor address bus width	32 bits
Flash EPROM	1 MB
Graphics bus	internal
PCI bus	32 bits

---

### ExpressCard

---

ExpressCard controller	Intel ICH6
ExpressCard connector	one ExpressCard slot (54 mm)
Cards supported	ExpressCard/34 (34 mm) and ExpressCard/54 (54 mm) 1.5 V and 3.3 V
ExpressCard connector size	28 pins

---

**5-in-1 Media Memory Card Reader**

---

5-in-1 media memory card controller	Ricoh R5C832
5-in-1 media memory card connector	5-in-1 combo card connector
Cards supported	MS MS Pro SD/SDIO MMC xD CD Type I/II & IBM® Microdrive through ExpressCard adapter
5-in-1 media memory card connector size	36.8 x 29.3 x 4.75 mm

---

**Memory**

---

Memory module connector	two SODIMM connectors
Memory module capacities	256 MB, 512 MB, and 1 GB
Memory type	1.8-V SODIMM DDR-2
Minimum memory	256 MB
Maximum memory	2 GB

---

**Ports and Connectors**

---

Audio	microphone connector, stereo headphone/speaker connector
IEEE 1394a	4-pin serial connector
Mini PCI	one Type IIIA Mini PCI card slot
Modem	RJ-11 port
Network adapter	RJ-45 port
S-video TV-out	7-pin mini-DIN connector (optional S-video to composite video adapter cable)
USB	four 4-pin USB 2.0-compliant connectors
Video	15-hole connector



---

**Communications**

---

## Modem:

Type	v.92 56K MDC
Controller	softmodem
Interface	internal HDA bus

Network adapter 10/100 Ethernet LAN on system board

Wireless internal Mini PCI Wi-Fi and Bluetooth® wireless technology support

---

**Video**

---

Video type: integrated on system board

Video controller Intel® Graphics Media Accelerator (GMA) 900

Video memory Up to 64 MB of shared memory

LCD interface LVDS

TV support NTSC/PAL

---

**Audio**

---

Audio type High Definition Audio (HDA) bus

Audio controller Sigmatel STAC9200

Stereo conversion 24-bit (analog-to-digital and digital-to-analog)

## Interfaces:

Internal HDA bus

External microphone-in connector, stereo headphones/speakers connector

Speaker two 4-ohm speakers

Internal speaker amplifier 1-W channel into 4 ohms

Volume controls keyboard shortcuts, program menus, media control buttons

---

<b>Display</b>	
Type (active-matrix TFT)	14.1-inch WXGA
Dimensions:	
Height	206 mm (8.11 inches)
Width	320 mm (12.59 inches)
Diagonal	357.74 mm (14.1 inches)
Maximum resolutions:	
WXGA	1280 x 800 at 262,144 colors
Refresh rate	60 Hz
Operating angle	0° (closed) to 180°
Viewing angles:	
Horizontal	±40° (WXGA) typical
Vertical	+15°/-30° (WXGA)
Pixel pitch:	
WXGA	0.237 mm
Controls	brightness can be controlled through keyboard shortcuts

---

<b>Keyboard</b>	
Number of keys	87 (U.S. and Canada); 88 (Europe); 91 (Japan)
Layout	QWERTY/AZERTY/Kanji

---

<b>Touch Pad</b>	
X/Y position resolution (graphics table mode)	240 cpi
Size:	
Width	73.0-mm (2.9-inch) sensor-active area
Height	42.9-mm (1.7-inch) rectangle

---

**Battery**

---

Type	9-cell "smart" lithium ion 6-cell "smart" lithium ion
Dimensions:	
Depth	60.1 mm (2.37 inches) (9 cell) 49 mm (1.93 inches) (6 cell)
Height	24 mm (0.94 inch)
Width	206.8 mm (8.14 inches)
Weight	0.48 kg (1.06 lb) (9 cell) 0.32 kg (0.7 lb) (6 cell)
Voltage	11.1 VDC
Charge time (approximate):	
Computer off	2 hours
Operating time	Battery operating time varies depending on operating conditions and can be significantly reduced under certain power-intensive conditions. See "Power Problems" on page 91. See "Using a Battery" on page 45 for more information on battery life.
Life span (approximate)	500 discharge/charge cycles
Temperature range:	
Operating	0° to 35°C (32° to 95°F)
Storage	-40° to 60°C (-40° to 140°F)
Coin-cell battery	CR-2032

---

**AC Adapter**

---

Input voltage	90–264 VAC
Input current (maximum)	1.5 A
Input frequency	47–63 Hz
Output current	4.34 A (maximum at 4-second pulse); 3.34 A (continuous)
Output power	65 W
Rated output voltage	19.5 +/-1.0 VDC

---

**AC Adapter (continued)**

---

## Dimensions:

Height 28.2 mm (1.11 inches)

Width 57.9 mm (2.28 inches)

Depth 137.2 mm (5.4 inches)

Weight (with cables) 0.4 kg (0.9 lb)

## Temperature range:

Operating 0° to 35°C (32° to 95°F)

Storage -40° to 65°C (-40° to 149°F)

---

**Physical**

---

Height 38.6 mm (1.52 inches)

Width 330 mm (12.99 inches)

Depth 243 mm (9.56 inches)

Weight (with 6-cell battery,  
CDRW/DVD combo, and 40G hard  
drive):

Configurable to less than 2.5 kg (5.5 lb)

---

**Environmental**

---

## Temperature range:

Operating 0° to 35°C (32° to 95°F)

Storage -40° to 65°C (-40° to 149°F)

## Relative humidity (maximum):

Operating 10% to 90% (noncondensing)

Storage 5% to 95% (noncondensing)

Maximum vibration (using a  
random-vibration spectrum that  
simulates user environment):

Operating 0.66 GRMS

Storage 1.3 GRMS

Maximum shock (measured with  
hard drive in head-parked position  
and a 2-ms half-sine pulse):

Operating 122 G

---

**Environmental (continued)**

---

Storage	163 G
Altitude (maximum):	
Operating	-15.2 to 3048 m (-50 to 10,000 ft)
Storage	-15.2 to 10,668 m (-50 to 35,000 ft)

## Using the System Setup Program

### Overview

 **NOTE:** Your operating system may automatically configure most of the options available in the system setup program, thus overriding options that you set through the system setup program. (An exception is the **External Hot Key** option, which you can disable or enable only through the system setup program.) For more information on configuring features for your operating system, see the Windows Help and Support Center. To access the Help and Support Center, see page 13.

The system setup screens display the current setup information and settings for your computer, such as:

- System configuration
- Basic device-configuration settings
- System security and hard-drive password settings
- Power management settings
- Boot (start-up) configuration and display settings
- Docking-device settings
- Wireless control settings

 **NOTICE:** Unless you are an expert computer user or are directed to do so by Dell technical support, do not change the system setup program settings. Certain changes might make your computer work incorrectly.

### Viewing the System Setup Screen

- 1 Turn on (or restart) your computer.
- 2 When the DELL™ logo appears, press <F2> immediately. If you wait too long and the Windows logo appears, continue to wait until you see the Windows desktop. Then shut down your computer and try again.

## System Setup Screen

The system setup screen consists of three windows of information. The window on the left contains an expandable hierarchy of control categories. If you select (highlight) a category (such as **System**, **Onboard Devices**, or **Video**) and press <Enter>, you can show or hide the related subcategories. The window on the right contains information about the category or subcategory selected in the window on the left.

The window at the bottom tells you how to control the system setup program with key functions. Use these keys to select a category, modify its settings, or exit the system setup program.

## Commonly Used Options

Certain options require that you reboot the computer for new settings to take effect.

### Changing the Boot Sequence

The *boot sequence*, or *boot order*, tells the computer where to look to find the software needed to start the operating system. You can control the boot sequence and enable/disable devices using the **Boot Order** page of the system setup program.

 **NOTE:** To change the boot sequence on a one-time-only basis, see "Performing a One-Time Boot" on page 139.

The **Boot Order** page displays a general list of the bootable devices that may be installed in your computer, including but not limited to the following:

- Diskette Drive
- Internal HDD
- USB Storage Device
- CD/DVD/CD-RW drive
- Modular bay HDD

 **NOTE:** Only devices that are preceded by a number are bootable.

During the boot routine, the computer starts at the top of the list and scans each enabled device for the operating system start-up files. When the computer finds the files, it stops searching and starts the operating system.

To control the boot devices, select (highlight) a device by pressing the down-arrow or up-arrow key, and then enable or disable the device or change its order in the list.

- To enable or disable a device, highlight the item and press the space bar. Enabled items are preceded by a number; disabled items are not preceded by a number.
- To reorder a device in the list, highlight the device and press either <u> to move the device up the list or <d> to move a device down the list.

Boot sequence changes take effect as soon as you save the changes and exit the system setup program.

### ***Performing a One-Time Boot***

You can set a one-time-only boot sequence without entering the system setup program. (You can also use this procedure to boot the Dell Diagnostics on the diagnostics utility partition on your hard drive.)

- 1 Shut down the computer through the **Start** menu.
- 2 Connect the computer to an electrical outlet.
- 3 Turn on the computer. When the DELL logo appears, press <F2> immediately. If you wait too long and the Windows logo appears, continue to wait until you see the Windows desktop. Then shut down your computer and try again.
- 4 When the boot device list appears, highlight the device from which you want to boot and press <Enter>.

The computer boots to the selected device.

The next time you reboot the computer, the previous boot order is restored.

## **Computer Tracking Software**

Computer tracking software may enable you to locate your computer if it is lost or stolen. The software is either preinstalled on your computer, or you can purchase it from [www.dell.com](http://www.dell.com). To use tracking software, activate the setting, if necessary, in the system setup program (BIOS). To access the system setup program, start your computer and press <F2> immediately when the blue DELL™ logo appears.

## **Traveling With Your Computer**

### **Identifying Your Computer**

- Attach a name tag or business card to the computer.
- Write down your Service Tag and store it in a safe place away from the computer or carrying case. Use the Service Tag if you need to report a loss or theft to law enforcement officials and to Dell.
- Create a file on the Microsoft® Windows® desktop called **if\_found**. Place information such as your name, address, and phone number in this file.
- Contact your credit card company and ask if it offers coded identification tags.

### **Packing the Computer**

- Remove any external devices attached to the computer and store them in a safe place.
- To make the computer as light as possible, replace any devices installed in the module bay with the Dell TravelLite™ module.
- Fully charge the main battery and any spare batteries that you plan to carry with you.

- Shut down the computer.
- Disconnect the AC adapter.
- ➔ **NOTICE:** When the display is closed, extraneous items on the keyboard or palm rest could damage the display.
- Remove any extraneous items, such as paper clips, pens, and paper, from the keyboard and palm rest and close the display.
- Use the optional Dell™ carrying case to pack the computer and its accessories together safely.
- Avoid packing the computer with items such as shaving cream, colognes, perfumes, or food.
- ➔ **NOTICE:** If the computer has been exposed to extreme temperatures, allow it to acclimate to room temperature for 1 hour before turning it on.
- Protect the computer, the batteries, and the hard drive from hazards such as extreme temperatures and overexposure to sunlight, dirt, dust, or liquids.
- Pack the computer so that it does not slide around in the trunk of your car or in an overhead storage compartment.

### Travel Tips

- ➔ **NOTICE:** Do not move the computer while using the optical drive to prevent loss of data.
- ➔ **NOTICE:** Do not check the computer as baggage.
- Consider disabling wireless activity on your computer to maximize battery operating time. To disable wireless activity, press <Fn> <F2>.
- Consider changing your power management options to maximize battery operating time. See "Power Management" on page 39.
- If you are the system setup program internationally, carry proof of ownership—or of your right to use the computer if it is company-owned—to speed your passage through customs. Investigate the customs regulations of the countries you plan to visit, and consider acquiring an international carnet (also known as a *merchandise passport*) from your government.
- Find out what type of electrical outlets are used in the countries you will visit, and have appropriate power adapters.
- Check with your credit card company for information about the kinds of emergency travel assistance it offers to users of portable computers.

### Traveling by Air

- ➔ **NOTICE:** Do not walk the computer through a metal detector. Send the computer through an X-ray machine or have it hand-inspected.
- Ensure that you have a charged battery available in case you are asked to turn on the computer.



- Prior to entering the airplane, verify that using a computer is permitted. Some airlines forbid the use of electronic devices during flight. All airlines forbid the use of electronic devices during takeoff and landing.

## If Your Computer Is Lost or Stolen

- Call a law enforcement agency to report the lost or stolen computer. Include the Service Tag in your description of the computer. Ask that a case number be assigned and write down the number, along with the name, address, and phone number of the law enforcement agency. If possible, obtain the name of the investigating officer.



**NOTE:** If you know where the computer was lost or stolen, call a law enforcement agency in that area. If you do not know, call a law enforcement agency where you live.

- If the computer belongs to a company, notify the security office of the company.
- Contact Dell customer service to report the missing computer. Provide the computer Service Tag, the case number, and the name, address, and phone number of the law enforcement agency to which you reported the missing computer. If possible, give the name of the investigating officer.

The Dell customer service representative will log your report under the computer Service Tag and record the computer as missing or stolen. If someone calls Dell for technical assistance and gives your Service Tag, the computer is identified automatically as missing or stolen. The representative will attempt to get the phone number and address of the caller. Dell will then contact the law enforcement agency to which you reported of the missing computer.

## Cleaning Your Computer



**CAUTION:** Before you begin any of the procedures in this section, follow the safety instructions located in the *Product Information Guide*.

### Computer, Keyboard, and Display



**CAUTION:** Before you clean your computer, disconnect the computer from the electrical outlet and remove any installed batteries. Clean your computer with a soft cloth dampened with water. Do not use liquid or aerosol cleaners, which may contain flammable substances.

- Use a can of compressed air to remove dust from between the keys on the keyboard and to remove any dirt or lint from the display.
-  **NOTICE:** To avoid damaging the computer or display, do not spray cleaning solution directly onto the display. Only use products specifically designed for cleaning displays, and follow the instructions that are included with the product.
- Moisten a soft, lint-free cloth with either water or a display cleaner. Do not use alcohol or an ammonia-based cleaner. Wipe the display gently working from the center to the edges until it is clean and any fingerprints are removed. Do not use excessive pressure.

- Moisten a soft, lint-free cloth with water and wipe the computer and keyboard. Do not allow water from the cloth to seep between the touch pad and the surrounding palm rest.

### Touch Pad

- 1 Shut down and turn off your computer. See "Turning Off Your Computer" on page 105.
- 2 Disconnect any attached devices from the computer and from their electrical outlets.
- 3 Remove any installed batteries. See "Battery" on page 108.
- 4 Moisten a soft, lint-free cloth with water, and wipe it gently across the surface of the touch pad. Do not allow water from the cloth to seep between the touch pad and the surrounding palm rest.

### Floppy Drive

- ➔ **NOTICE:** Do not attempt to clean drive heads with a swab. You might accidentally misalign the heads which prevents the drive from operating.

Clean your floppy drive using a commercially available cleaning kit. These kits contain pretreated floppies to remove contaminants that accumulate during normal operation.

### CDs and DVDs

- ➔ **NOTICE:** Always use compressed air to clean the lens in the CD/DVD drive, and follow the instructions that come with the compressed-air product. Never touch the lens in the drive.

If you notice problems, such as skipping, with the playback quality of your CDs or DVDs, try cleaning the discs.

- 1 Hold the disc by its outer edge. You can also touch the inside edge of the center hole.

- ➔ **NOTICE:** To avoid damaging the surface, do not wipe in a circular motion around the disc.

- 2 With a soft, lint-free cloth, gently wipe the bottom of the disc (the unlabeled side) in a straight line from the center to the outer edge of the disc.

For stubborn dirt, try using water or a diluted solution of water and mild soap. You can also purchase commercial products that clean discs and provide some protection from dust, fingerprints, and scratches. Cleaning products for CDs are also safe to use on DVDs.

## FCC Notices (U.S. Only)

Most Dell computers are classified by the Federal Communications Commission (FCC) as Class B digital devices. To determine which classification applies to your computer, examine all FCC registration labels located on the bottom, side, or back panel of your computer, on card-mounting brackets, and on the cards themselves. If any one of the labels carries a Class A rating, your entire computer is considered to be a Class A digital device. If *all* labels carry an FCC Class B rating as distinguished by either an FCC ID number or the FCC logo, (**FC**), your computer is considered to be a Class B digital device.

Once you have determined your computer's FCC classification, read the appropriate FCC notice. Note that FCC regulations provide that changes or modifications not expressly approved by Dell could void your authority to operate this equipment.

This device complies with Part 15 of the FCC Rules. Operation is subject to the following two conditions:

- This device may not cause harmful interference.
- This device must accept any interference received, including interference that may cause undesired operation.

### **Class A**

This equipment has been tested and found to comply with the limits for a Class A digital device pursuant to Part 15 of the FCC Rules. These limits are designed to provide reasonable protection against harmful interference when the equipment is operated in a commercial environment. This equipment generates, uses, and can radiate radio frequency energy and, if not installed and used in accordance with the manufacturer's instruction manual, may cause harmful interference with radio communications. Operation of this equipment in a residential area is likely to cause harmful interference, in which case you will be required to correct the interference at your own expense.

### **Class B**

This equipment has been tested and found to comply with the limits for a Class B digital device pursuant to Part 15 of the FCC Rules. These limits are designed to provide reasonable protection against harmful interference in a residential installation. This equipment generates, uses, and can radiate radio frequency energy and, if not installed and used in accordance with the manufacturer's instruction manual, may cause interference with radio communications. However, there is no guarantee that interference will not occur in a particular installation. If this equipment does cause harmful interference to radio or television reception, which can be determined by turning the equipment off and on, you are encouraged to try to correct the interference by one or more of the following measures:

- Reorient or relocate the receiving antenna.
- Increase the separation between the equipment and the receiver.
- Connect the equipment into an outlet on a circuit different from that to which the receiver is connected.
- Consult the dealer or an experienced radio/television technician for help.

## FCC Identification Information

The following information is provided on the device or devices covered in this document in compliance with FCC regulations:

- Model number: PP19L
- Company name:

Dell Inc.  
One Dell Way  
Round Rock, Texas 78682 USA  
512-338-4400

## Macrovision Product Notice

This product incorporates copyright protection technology that is protected by U.S. patents and other intellectual property rights. Use of this copyright protection technology must be authorized by Macrovision, and is intended for home and other limited viewing uses only unless otherwise authorized by Macrovision. Reverse engineering or disassembly is prohibited.

## Dell Technical Support Policy (U.S. Only)

Technician-assisted technical support requires the cooperation and participation of the customer in the troubleshooting process and provides for restoration of the operating system, software programs, and hardware drivers to the original default configuration as shipped from Dell, as well as the verification of appropriate functionality of the computer and all Dell-installed hardware. In addition to this technician-assisted technical support, online technical support is available at [support.dell.com](http://support.dell.com). Additional technical support options may be available for purchase.

Dell provides limited technical support for the computer and any "Dell-installed" software and peripherals<sup>1</sup>. Support for third-party software and peripherals is provided by the original manufacturer, including those purchased and/or installed through Dell Software and Peripherals, Readyware, and Custom Factory Integration<sup>2</sup>.

<sup>1</sup> Repair services are provided pursuant to the terms and conditions of your limited warranty and any optional support service contract purchased with the computer.

<sup>2</sup> All Dell-standard components included in a Custom Factory Integration (CFI) project are covered by the standard Dell limited warranty for your computer. However, Dell also extends a parts replacement program to cover all nonstandard, third-party hardware components integrated through CFI for the duration of the computer's service contract.

## Definition of "Dell-Installed" Software and Peripherals

Dell-installed software includes the operating system and some of the software programs that are installed on the computer during the manufacturing process (Microsoft® Office, Norton Antivirus, and so on).

Dell-installed peripherals include any internal expansion cards, or Dell-branded module bay or ExpressCard accessories. In addition, any Dell-branded monitors, keyboards, mice, speakers, microphones for telephonic modems, docking stations/port replicators, networking products, and all associated cabling are included.

### Definition of "Third-Party" Software and Peripherals

Third-party software and peripherals include any peripheral, accessory, or software program sold by Dell not under the Dell brand (printers, scanners, cameras, games, and so on). Support for all third-party software and peripherals is provided by the original manufacturer of the product.

## Contacting Dell

To contact Dell electronically, you can access the following websites:

- [www.dell.com](http://www.dell.com)
- [support.dell.com](http://support.dell.com) (technical support)
- [premiersupport.dell.com](http://premiersupport.dell.com) (technical support for educational, government, healthcare, and medium/large business customers, including Premier, Platinum, and Gold customers)

For specific web addresses for your country, find the appropriate country section in the table below.

**NOTE:** Toll-free numbers are for use within the country for which they are listed.

**NOTE:** In certain countries, technical support specific to Dell XPS portable computers is available at a separate telephone number listed for participating countries. If you do not see a telephone number listed that is specific for XPS portable computers, you may contact Dell through the technical support number listed and your call will be routed appropriately.

When you need to contact Dell, use the electronic addresses, telephone numbers, and codes provided in the following table. If you need assistance in determining which codes to use, contact a local or an international operator.

<b>Country (City) International Access Code Country Code City Code</b>	<b>Department Name or Service Area, Website and E-Mail Address</b>	<b>Area Codes, Local Numbers, and Toll-Free Numbers</b>
Anguilla	General Support	toll-free: 800-335-0031
Antigua and Barbuda	General Support	1-800-805-5924

<b>Country (City) International Access Code Country Code City Code</b>	<b>Department Name or Service Area, Website and E-Mail Address</b>	<b>Area Codes, Local Numbers, and Toll-Free Numbers</b>
Argentina (Buenos Aires) International Access Code: 00 Country Code: 54 City Code: 11	Website: <a href="http://www.dell.com.ar">www.dell.com.ar</a> E-mail: <a href="mailto:us_latin_services@dell.com">us_latin_services@dell.com</a> E-mail for desktop and portable computers: <a href="mailto:la-techsupport@dell.com">la-techsupport@dell.com</a> E-mail for servers and EMC <sup>®</sup> storage products: <a href="mailto:la_enterprise@dell.com">la_enterprise@dell.com</a>	Customer Care toll-free: 0-800-444-0730 Tech Support toll-free: 0-800-444-0733 Tech Support Services toll-free: 0-800-444-0724 Sales 0-810-444-3355
Aruba	General Support	toll-free: 800-1578
Australia (Sydney) International Access Code: 0011 Country Code: 61 City Code: 2	E-mail (Australia): <a href="mailto:au_tech_support@dell.com">au_tech_support@dell.com</a> E-mail Customer Care (Australia and New Zealand): <a href="mailto:apcustserv@dell.com">apcustserv@dell.com</a> Home and Small Business Government and Business Preferred Accounts Division (PAD) Customer Care (after sales) Technical Support (portables and desktops) Technical Support (servers and workstations) Corporate Sales Transaction Sales Fax	1-300-655-533 toll-free: 1-800-633-559 toll-free: 1-800-060-889 toll-free 1-333-55(option 3) toll-free: 1-300-655-533 toll-free: 1-800-733-314 toll-free: 1-800-808-385 toll-free: 1-800-808-312 toll-free: 1-800-818-341

<b>Country (City) International Access Code Country Code City Code</b>	<b>Department Name or Service Area, Website and E-Mail Address</b>	<b>Area Codes, Local Numbers, and Toll-Free Numbers</b>
<b>Austria (Vienna)</b>	Website: <a href="http://support.euro.dell.com">support.euro.dell.com</a>	
International Access Code: 900	E-mail: <a href="mailto:tech_support_central_europe@dell.com">tech_support_central_europe@dell.com</a>	
Country Code: 43	Home/Small Business Sales	0820 240 530 00
City Code: 1	Home/Small Business Fax	0820 240 530 49
	Home/Small Business Customer Care	0820 240 530 14
	Preferred Accounts/Corporate Customer Care	0820 240 530 16
	Technical Support for XPS portable computers only	0820 240 530 81
	Home/Small Business Technical Support for all other Dell computers	0820 240 530 14
	Preferred Accounts/Corporate Technical Support	0660 8779
	Switchboard	0820 240 530 00
<b>Bahamas</b>	General Support	toll-free: 1-866-278-6818
<b>Barbados</b>	General Support	1-800-534-3066
<b>Belgium (Brussels)</b>	Website: <a href="http://support.euro.dell.com">support.euro.dell.com</a>	
International Access Code: 00	E-mail for French-speaking Customers: <a href="http://support.euro.dell.com/be/fr/emaildell/">support.euro.dell.com/be/fr/emaildell/</a>	
Country Code: 32	Technical Support for XPS portable computers only	02 481 92 96
City Code: 2	Technical Support for all other Dell computers	02 481 92 88
	Technical Support Fax	02 481 92 95
	Customer Care	02 713 15 65
	Corporate Sales	02 481 91 00
	Fax	02 481 92 99
	Switchboard	02 481 91 00
<b>Bermuda</b>	General Support	1-800-342-0671
<b>Bolivia</b>	General Support	toll-free: 800-10-0238
<b>Brazil</b>	Website: <a href="http://www.dell.com/br">www.dell.com/br</a>	
International Access Code: 00	Customer Support, Technical Support	0800 90 3355
Country Code: 55	Technical Support Fax	51 481 5470
City Code: 51	Customer Care Fax	51 481 5480
	Sales	0800 90 3390
<b>British Virgin Islands</b>	General Support	toll-free: 1-866-278-6820

<b>Country (City) International Access Code Country Code City Code</b>	<b>Department Name or Service Area, Website and E-Mail Address</b>	<b>Area Codes, Local Numbers, and Toll-Free Numbers</b>
Brunei Country Code: 673	Customer Technical Support (Penang, Malaysia)	604 633 4966
	Customer Care (Penang, Malaysia)	604 633 4888
	Transaction Sales (Penang, Malaysia)	604 633 4955
Canada (North York, Ontario) International Access Code: 011	Online Order Status: <a href="http://www.dell.ca/ostatus">www.dell.ca/ostatus</a>	
	AutoTech (automated technical support)	toll-free: 1-800-247-9362
	Customer Care (Home Sales/Small Business)	toll-free: 1-800-847-4096
	Customer Care (med./large business, government)	toll-free: 1-800-326-9463
	Technical Support (Home Sales/Small Business)	toll-free: 1-800-847-4096
	Technical Support (med./large bus., government)	toll-free: 1-800-387-5757
	Technical Support (printers, projectors, televisions, handhelds, digital jukebox, and wireless)	1-877-335-5767
	Sales (Home Sales/Small Business)	toll-free: 1-800-387-5752
	Sales (med./large bus., government)	toll-free: 1-800-387-5755
Spare Parts Sales & Extended Service Sales	1 866 440 3355	
Cayman Islands	General Support	1-800-805-7541
Chile (Santiago) Country Code: 56 City Code: 2	Sales, Customer Support, and Technical Support	toll-free: 1230-020-4823



<b>Country (City) International Access Code Country Code City Code</b>	<b>Department Name or Service Area, Website and E-Mail Address</b>	<b>Area Codes, Local Numbers, and Toll-Free Numbers</b>
China (Xiamen) Country Code: 86 City Code: 592	Technical Support website: <a href="http://support.dell.com.cn">support.dell.com.cn</a> Technical Support E-mail: <a href="mailto:cn_support@dell.com">cn_support@dell.com</a> Customer Care E-mail: <a href="mailto:customer_cn@dell.com">customer_cn@dell.com</a>	
	Technical Support Fax	592 818 1350
	Technical Support (Dell™ Dimension™ and Inspiron)	toll-free: 800 858 2969
	Technical Support (OptiPlex™, Latitude™, and Dell Precision™)	toll-free: 800 858 0950
	Technical Support (servers and storage)	toll-free: 800 858 0960
	Technical Support (projectors, PDAs, switches, routers, and so on)	toll-free: 800 858 2920
	Technical Support (printers)	toll-free: 800 858 2311
	Customer Care	toll-free: 800 858 2060
	Customer Care Fax	592 818 1308
	Home and Small Business	toll-free: 800 858 2222
	Preferred Accounts Division	toll-free: 800 858 2557
	Large Corporate Accounts GCP	toll-free: 800 858 2055
	Large Corporate Accounts Key Accounts	toll-free: 800 858 2628
	Large Corporate Accounts North	toll-free: 800 858 2999
	Large Corporate Accounts North Government and Education	toll-free: 800 858 2955
	Large Corporate Accounts East	toll-free: 800 858 2020
	Large Corporate Accounts East Government and Education	toll-free: 800 858 2669
	Large Corporate Accounts Queue Team	toll-free: 800 858 2572
	Large Corporate Accounts South	toll-free: 800 858 2355
	Large Corporate Accounts West	toll-free: 800 858 2811
	Large Corporate Accounts Spare Parts	toll-free: 800 858 2621
Colombia	General Support	980-9-15-3978
Costa Rica	General Support	0800-012-0435

<b>Country (City) International Access Code Country Code City Code</b>	<b>Department Name or Service Area, Website and E-Mail Address</b>	<b>Area Codes, Local Numbers, and Toll-Free Numbers</b>
<b>Czech Republic (Prague)</b>	Website: <a href="http://support.euro.dell.com">support.euro.dell.com</a>	
International Access Code: 00	E-mail: <a href="mailto:czech_dell@dell.com">czech_dell@dell.com</a>	
Country Code: 420	Technical Support	22537 2727
	Customer Care	22537 2707
	Fax	22537 2714
	Tech Fax	22537 2728
	Switchboard	22537 2711
<b>Denmark (Copenhagen)</b>	Website: <a href="http://support.euro.dell.com">support.euro.dell.com</a>	
International Access Code: 00	E-mail: <a href="mailto:support.euro.dell.com/dk/da/emaildell/">support.euro.dell.com/dk/da/emaildell/</a>	
Country Code: 45	Technical Support for XPS portable computers only	7010 0074
	Technical Support for all other Dell computers	7023 0182
	Customer Care (Relational)	7023 0184
	Home/Small Business Customer Care	3287 5505
	Switchboard (Relational)	3287 1200
	Switchboard Fax (Relational)	3287 1201
	Switchboard (Home/Small Business)	3287 5000
	Switchboard Fax (Home/Small Business)	3287 5001
<b>Dominica</b>	General Support	toll-free: 1-866-278-6821
<b>Dominican Republic</b>	General Support	1-800-148-0530
<b>Ecuador</b>	General Support	toll-free: 999-119
<b>El Salvador</b>	General Support	01-899-753-0777
<b>Finland (Helsinki)</b>	Website: <a href="http://support.euro.dell.com">support.euro.dell.com</a>	
International Access Code: 990	E-mail: <a href="mailto:support.euro.dell.com/fi/fi/emaildell/">support.euro.dell.com/fi/fi/emaildell/</a>	
Country Code: 358	Technical Support	09 253 313 60
City Code: 9	Customer Care	09 253 313 38
	Fax	09 253 313 99
	Switchboard	09 253 313 00

<b>Country (City) International Access Code Country Code City Code</b>	<b>Department Name or Service Area, Website and E-Mail Address</b>	<b>Area Codes, Local Numbers, and Toll-Free Numbers</b>
France (Paris) (Montpellier) International Access Code: 00 Country Code: 33 City Codes: (1) (4)	Website: <a href="http://support.euro.dell.com">support.euro.dell.com</a> E-mail: <a href="mailto:support.euro.dell.com/fr/fr/emaildell/">support.euro.dell.com/fr/fr/emaildell/</a> <b>Home and Small Business</b> Technical Support for XPS portable computers only Technical Support for all other Dell computers Customer Care Switchboard Switchboard (calls from outside of France) Sales Fax Fax (calls from outside of France) <b>Corporate</b> Technical Support Customer Care Switchboard Sales Fax	    0825 387 129 0825 387 270 0825 823 833 0825 004 700 04 99 75 40 00 0825 004 700 0825 004 701 04 99 75 40 01  0825 004 719 0825 338 339 01 55 94 71 00 01 55 94 71 00 01 55 94 71 01
Germany (Langen) International Access Code: 00 Country Code: 49 City Code: 6103	Website: <a href="http://support.euro.dell.com">support.euro.dell.com</a> E-mail: <a href="mailto:tech_support_central_europe@dell.com">tech_support_central_europe@dell.com</a> Technical Support for XPS portable computers only Technical Support for all other Dell computers Home/Small Business Customer Care Global Segment Customer Care Preferred Accounts Customer Care Large Accounts Customer Care Public Accounts Customer Care Switchboard	   06103 766-7222 06103 766-7200 0180-5-224400 06103 766-9570 06103 766-9420 06103 766-9560 06103 766-9555 06103 766-7000

<b>Country (City) International Access Code Country Code City Code</b>	<b>Department Name or Service Area, Website and E-Mail Address</b>	<b>Area Codes, Local Numbers, and Toll-Free Numbers</b>
<b>Greece</b>	Website: <a href="http://support.euro.dell.com">support.euro.dell.com</a>	
International Access Code: 00	E-mail: <a href="mailto:support.euro.dell.com/gr/en/emaildell/">support.euro.dell.com/gr/en/emaildell/</a>	
Country Code: 30	Technical Support	00800-44 14 95 18
	Gold Service Technical Support	00800-44 14 00 83
	Switchboard	2108129810
	Gold Service Switchboard	2108129811
	Sales	2108129800
	Fax	2108129812
<b>Grenada</b>	General Support	toll-free: 1-866-540-3355
<b>Guatemala</b>	General Support	1-800-999-0136
<b>Guyana</b>	General Support	toll-free: 1-877-270-4609
<b>Hong Kong</b>	Website: <a href="http://support.ap.dell.com">support.ap.dell.com</a>	
International Access Code: 001	Technical Support E-mail: <a href="mailto:apsupport@dell.com">apsupport@dell.com</a>	
Country Code: 852	Technical Support (Dimension and Inspiron)	2969 3188
	Technical Support (OptiPlex, Latitude, and Dell Precision)	2969 3191
	Technical Support (PowerApp™, PowerEdge™, PowerConnect™, and PowerVault™)	2969 3196
	Customer Care	3416 0910
	Large Corporate Accounts	3416 0907
	Global Customer Programs	3416 0908
	Medium Business Division	3416 0912
	Home and Small Business Division	2969 3105
<b>India</b>	E-mail: <a href="mailto:india_support_desktop@dell.com">india_support_desktop@dell.com</a> <a href="mailto:india_support_notebook@dell.com">india_support_notebook@dell.com</a> <a href="mailto:india_support_Server@dell.com">india_support_Server@dell.com</a>	
	Technical Support	1600338045 and 1600448046
	Sales (Large Corporate Accounts)	1600 33 8044
	Sales (Home and Small Business)	1600 33 8046

<b>Country (City) International Access Code Country Code City Code</b>	<b>Department Name or Service Area, Website and E-Mail Address</b>	<b>Area Codes, Local Numbers, and Toll-Free Numbers</b>
<b>Ireland (Cherrywood)</b>	Website: <a href="http://support.euro.dell.com">support.euro.dell.com</a>	
International Access Code: 16	E-mail: <a href="mailto:dell_direct_support@dell.com">dell_direct_support@dell.com</a>	
Country Code: 353	Technical Support for XPS portable computers only	1850 200 722
City Code: 1	Technical Support for all other Dell computers	1850 543 543
	U.K. Technical Support (dial within U.K. only)	0870 908 0800
	Home User Customer Care	01 204 4014
	Small Business Customer Care	01 204 4014
	U.K. Customer Care (dial within U.K. only)	0870 906 0010
	Corporate Customer Care	1850 200 982
	Corporate Customer Care (dial within U.K. only)	0870 907 4499
	Ireland Sales	01 204 4444
	U.K. Sales (dial within U.K. only)	0870 907 4000
	Fax/Sales Fax	01 204 0103
	Switchboard	01 204 4444
<b>Italy (Milan)</b>	Website: <a href="http://support.euro.dell.com">support.euro.dell.com</a>	
International Access Code: 00	E-mail: <a href="mailto:support.euro.dell.com/it/it/emaildell/">support.euro.dell.com/it/it/emaildell/</a>	
Country Code: 39	<b>Home and Small Business</b>	
City Code: 02	Technical Support	02 577 826 90
	Customer Care	02 696 821 14
	Fax	02 696 821 13
	Switchboard	02 696 821 12
	<b>Corporate</b>	
	Technical Support	02 577 826 90
	Customer Care	02 577 825 55
	Fax	02 575 035 30
	Switchboard	02 577 821
<b>Jamaica</b>	General Support (dial from within Jamaica only)	1-800-682-3639

<b>Country (City) International Access Code Country Code City Code</b>	<b>Department Name or Service Area, Website and E-Mail Address</b>	<b>Area Codes, Local Numbers, and Toll-Free Numbers</b>
Japan (Kawasaki)	Website: <a href="http://support.jp.dell.com">support.jp.dell.com</a>	
International Access Code: 001	Technical Support (servers)	toll-free: 0120-198-498
Country Code: 81	Technical Support outside of Japan (servers)	81-44-556-4162
City Code: 44	Technical Support (Dimension and Inspiron)	toll-free: 0120-198-226
	Technical Support outside of Japan (Dimension and Inspiron)	81-44-520-1435
	Technical Support (Dell Precision, OptiPlex, and Latitude)	toll-free:0120-198-433
	Technical Support outside of Japan (Dell Precision, OptiPlex, and Latitude)	81-44-556-3894
	Technical Support (PDAs, projectors, printers, routers)	toll-free: 0120-981-690
	Technical Support outside of Japan (PDAs, projectors, printers, routers)	81-44-556-3468
	Faxbox Service	044-556-3490
	24-Hour Automated Order Service	044-556-3801
	Customer Care	044-556-4240
	Business Sales Division (up to 400 employees)	044-556-1465
	Preferred Accounts Division Sales (over 400 employees)	044-556-3433
	Large Corporate Accounts Sales (over 3500 employees)	044-556-3430
	Public Sales (government agencies, educational institutions, and medical institutions)	044-556-1469
	Global Segment Japan	044-556-3469
	Individual User	044-556-1760
	Switchboard	044-556-4300
Korea (Seoul)	E-mail: <a href="mailto:krsupport@dell.com">krsupport@dell.com</a>	
International Access Code: 001	Technical Support	toll-free: 080-200-3800
Country Code: 82	Technical Support (Dimension, PDA, Electronics and Accessories)	toll-free: 080-200-3801
City Code: 2	Sales	toll-free: 080-200-3600
	Fax	2194-6202
	Switchboard	2194-6000

<b>Country (City) International Access Code Country Code City Code</b>	<b>Department Name or Service Area, Website and E-Mail Address</b>	<b>Area Codes, Local Numbers, and Toll-Free Numbers</b>
Latin America	Customer Technical Support (Austin, Texas, U.S.A.)	512 728-4093
	Customer Service (Austin, Texas, U.S.A.)	512 728-3619
	Fax (Technical Support and Customer Service) (Austin, Texas, U.S.A.)	512 728-3883
	Sales (Austin, Texas, U.S.A.)	512 728-4397
	SalesFax (Austin, Texas, U.S.A.)	512 728-4600 or 512 728-3772
<b>Luxembourg</b>	Website: <a href="http://support.euro.dell.com">support.euro.dell.com</a>	
International Access Code: 00	Technical Support	342 08 08 075
Country Code: 352	Home/Small Business Sales	+32 (0)2 713 15 96
	Corporate Sales	26 25 77 81
	Customer Care	+32 (0)2 481 91 19
	Fax	26 25 77 82
<b>Macao</b>	Technical Support	toll-free: 0800 105
Country Code: 853	Customer Service (Xiamen, China)	34 160 910
	Transaction Sales (Xiamen, China)	29 693 115
<b>Malaysia (Penang)</b>	Website: <a href="http://support.ap.dell.com">support.ap.dell.com</a>	
International Access Code: 00	Technical Support (Dell Precision, OptiPlex, and Latitude)	toll-free: 1 800 880 193
Country Code: 60	Technical Support (Dimension, Inspiron, and Electronics and Accessories)	toll-free: 1 800 881 306
City Code: 4	Technical Support (PowerApp, PowerEdge, PowerConnect, and PowerVault)	toll-free: 1800 881 386
	Customer Care	toll-free: 1800 881 306 (option 6)
	Transaction Sales	toll-free: 1 800 888 202
	Corporate Sales	toll-free: 1 800 888 213

<b>Country (City) International Access Code Country Code City Code</b>	<b>Department Name or Service Area, Website and E-Mail Address</b>	<b>Area Codes, Local Numbers, and Toll-Free Numbers</b>
Mexico International Access Code: 00 Country Code: 52	Customer Technical Support  Sales  Customer Service  Main	001-877-384-8979 or 001-877-269-3383 50-81-8800 or 01-800-888-3355 001-877-384-8979 or 001-877-269-3383 50-81-8800 or 01-800-888-3355
Montserrat	General Support	toll-free: 1-866-278-6822
Netherlands Antilles	General Support	001-800-882-1519
Netherlands (Amsterdam) International Access Code: 00 Country Code: 31 City Code: 20	Website: <a href="http://support.euro.dell.com">support.euro.dell.com</a> Technical Support for XPS portable computers only Technical Support for all other Dell computers Technical Support Fax Home/Small Business Customer Care Relational Customer Care Home/Small Business Sales Relational Sales Home/Small Business Sales Fax Relational Sales Fax Switchboard Switchboard Fax	020 674 45 94 020 674 45 00 020 674 47 66 020 674 42 00 020 674 4325 020 674 55 00 020 674 50 00 020 674 47 75 020 674 47 50 020 674 50 00 020 674 47 50



<b>Country (City) International Access Code Country Code City Code</b>	<b>Department Name or Service Area, Website and E-Mail Address</b>	<b>Area Codes, Local Numbers, and Toll-Free Numbers</b>
New Zealand	E-mail (New Zealand): nz_tech_support@dell.com	
International Access Code: 00	E-mail Customer Care (Australia and	
Country Code: 64	New Zealand): apcustserv@dell.com	
	Customer Care	toll-free: 0800-289-335 (option 3)
	Technical Support (for desktop and portable computers)	toll-free: 0800 446 255
	Technical Support (for servers and workstations)	toll-free: 0800 443 563
	Home and Small Business	0800 446 255
	Government and Business	0800 444 617
	Sales	0800 441 567
	Fax	0800 441 566
<b>Nicaragua</b>	General Support	001-800-220-1006
<b>Norway (Lysaker)</b>	Website: support.euro.dell.com	
International Access Code: 00	E-mail: support.euro.dell.com/no/no/emaildell/	
Country Code: 47	Technical Support for XPS portable computers only	815 35 043
	Technical Support for all other Dell products	671 16882
	Relational Customer Care	671 17575
	Home/Small Business Customer Care	23162298
	Switchboard	671 16800
	Fax Switchboard	671 16865
<b>Panama</b>	General Support	001-800-507-0962
<b>Peru</b>	General Support	0800-50-669
<b>Poland (Warsaw)</b>	Website: support.euro.dell.com	
International Access Code: 011	E-mail: pl_support_tech@dell.com	
Country Code: 48	Customer Service Phone	57 95 700
City Code: 22	Customer Care	57 95 999
	Sales	57 95 999
	Customer Service Fax	57 95 806
	Reception Desk Fax	57 95 998
	Switchboard	57 95 999

<b>Country (City) International Access Code Country Code City Code</b>	<b>Department Name or Service Area, Website and E-Mail Address</b>	<b>Area Codes, Local Numbers, and Toll-Free Numbers</b>
<b>Portugal</b>	Website: <a href="http://support.euro.dell.com">support.euro.dell.com</a>	
International Access Code: 00	E-mail: <a href="mailto:support.euro.dell.com/pt/en/emaildell/">support.euro.dell.com/pt/en/emaildell/</a>	
Country Code: 351	Technical Support	707200149
	Customer Care	800 300 413
	Sales	800 300 410 or 800 300 411 or 800 300 412 or 21 422 07 10
	Fax	21 424 01 12
<b>Puerto Rico</b>	General Support	1-800-805-7545
<b>St. Kitts and Nevis</b>	General Support	toll-free: 1-877-441-4731
<b>St. Lucia</b>	General Support	1-800-882-1521
<b>St. Vincent and the Grenadines</b>	General Support	toll-free: 1-877-270-4609
<b>Singapore (Singapore)</b>	Website: <a href="http://support.ap.dell.com">support.ap.dell.com</a>	
International Access Code: 005	Technical Support (Dimension, Inspiron, and Electronics and Accessories)	toll-free: 1800 394 7430
Country Code: 65	Technical Support (OptiPlex, Latitude, and Dell Precision)	toll-free: 1800 394 7488
	Technical Support (PowerApp, PowerEdge, PowerConnect, and PowerVault)	toll-free: 1800 394 7478
	Customer Care	toll-free: 1 800 394 7430 (option 6)
	Transaction Sales	toll-free: 1 800 394 7412
	Corporate Sales	toll-free: 1 800 394 7419
<b>Slovakia (Prague)</b>	Website: <a href="http://support.euro.dell.com">support.euro.dell.com</a>	
International Access Code: 00	E-mail: <a href="mailto:czech_dell@dell.com">czech_dell@dell.com</a>	
Country Code: 421	Technical Support	02 5441 5727
	Customer Care	420 22537 2707
	Fax	02 5441 8328
	Tech Fax	02 5441 8328
	Switchboard (Sales)	02 5441 7585

<b>Country (City) International Access Code Country Code City Code</b>	<b>Department Name or Service Area, Website and E-Mail Address</b>	<b>Area Codes, Local Numbers, and Toll-Free Numbers</b>
South Africa (Johannesburg)	Website: <a href="http://support.euro.dell.com">support.euro.dell.com</a>	
International Access Code: 09/091	E-mail: <a href="mailto:dell_za_support@dell.com">dell_za_support@dell.com</a>	
Country Code: 27	Gold Queue	011 709 7713
City Code: 11	Technical Support	011 709 7710
	Customer Care	011 709 7707
	Sales	011 709 7700
	Fax	011 706 0495
	Switchboard	011 709 7700
<b>Southeast Asian and Pacific Countries</b>	Customer Technical Support, Customer Service, and Sales (Penang, Malaysia)	604 633 4810
Spain (Madrid)	Website: <a href="http://support.euro.dell.com">support.euro.dell.com</a>	
International Access Code: 00	E-mail: <a href="mailto:support.euro.dell.com/es/es/emaildell/">support.euro.dell.com/es/es/emaildell/</a>	
Country Code: 34	<b>Home and Small Business</b>	
City Code: 91	Technical Support	902 100 130
	Customer Care	902 118 540
	Sales	902 118 541
	Switchboard	902 118 541
	Fax	902 118 539
	<b>Corporate</b>	
	Technical Support	902 100 130
	Customer Care	902 115 236
	Switchboard	91 722 92 00
	Fax	91 722 95 83

<b>Country (City) International Access Code Country Code City Code</b>	<b>Department Name or Service Area, Website and E-Mail Address</b>	<b>Area Codes, Local Numbers, and Toll-Free Numbers</b>
Sweden (Upplands Vasby)	Website: <a href="http://support.euro.dell.com">support.euro.dell.com</a>	
International Access Code: 00	E-mail: <a href="mailto:support.euro.dell.com/se/sv/emaildell/">support.euro.dell.com/se/sv/emaildell/</a>	
Country Code: 46	Technical Support for XPS portable computers only	0771 340 340
City Code: 8	Technical Support for all other Dell products	08 590 05 199
	Relational Customer Care	08 590 05 642
	Home/Small Business Customer Care	08 587 70 527
	Employee Purchase Program (EPP) Support	20 140 14 44
	Technical Support Fax	08 590 05 594
	Sales	08 590 05 185
Switzerland (Geneva)	Website: <a href="http://support.euro.dell.com">support.euro.dell.com</a>	
International Access Code: 00	E-mail: <a href="mailto:Tech_support_central_Europe@dell.com">Tech_support_central_Europe@dell.com</a>	
Country Code: 41	E-mail for French-speaking HSB and Corporate Customers: <a href="http://support.euro.dell.com/ch/fr/emaildell/">support.euro.dell.com/ch/fr/emaildell/</a>	
City Code: 22	Technical Support for XPS portable computers only	0848 33 88 57
	Technical Support (Home and Small Business) for all other Dell products	0844 811 411
	Technical Support (Corporate)	0844 822 844
	Customer Care (Home and Small Business)	0848 802 202
	Customer Care (Corporate)	0848 821 721
	Fax	022 799 01 90
	Switchboard	022 799 01 01
Taiwan	Website: <a href="http://support.ap.dell.com">support.ap.dell.com</a>	
International Access Code: 002	E-mail: <a href="mailto:ap_support@dell.com">ap_support@dell.com</a>	
Country Code: 886	Technical Support (OptiPlex, Latitude, Inspiron, Dimension, and Electronics and Accessories)	toll-free: 00801 86 1011
	Technical Support (PowerApp, PowerEdge, PowerConnect, and PowerVault)	toll-free: 00801 60 1256
	Customer Care	toll-free: 00801 60 1250 (option 5)
	Transaction Sales	toll-free: 00801 65 1228
	Corporate Sales	toll-free: 00801 651 227

<b>Country (City) International Access Code Country Code City Code</b>	<b>Department Name or Service Area, Website and E-Mail Address</b>	<b>Area Codes, Local Numbers, and Toll-Free Numbers</b>
Thailand	Website: <a href="http://support.ap.dell.com">support.ap.dell.com</a>	
International Access Code: 001 Country Code: 66	Technical Support (OptiPlex, Latitude, and Dell Precision)	toll-free: 1800 0060 07
	Technical Support (PowerApp, PowerEdge, PowerConnect, and PowerVault)	toll-free: 1800 0600 09
	Customer Care	toll-free: 1800 006 007 (option 7)
	Corporate Sales	toll-free: 1800 006 009
	Transaction Sales	toll-free: 1800 006 006
Trinidad/Tobago	General Support	1-800-805-8035
Turks and Caicos Islands	General Support	toll-free: 1-866-540-3355
U.K. (Bracknell)	Website: <a href="http://support.euro.dell.com">support.euro.dell.com</a>	
International Access Code: 00 Country Code: 44 City Code: 1344	Customer Care website: <a href="http://support.euro.dell.com/uk/en/ECare/Form/Home.asp">support.euro.dell.com/uk/en/ECare/Form/Home.asp</a> E-mail: <a href="mailto:dell_direct_support@dell.com">dell_direct_support@dell.com</a>	
	Technical Support (Corporate/Preferred Accounts/PAD [1000+ employees])	0870 908 0500
	Technical Support for XPS portable computers only	0870 366 4180
	Technical Support (direct and general) for all other products	0870 908 0800
	Global Accounts Customer Care	01344 373 186
	Home and Small Business Customer Care	0870 906 0010
	Corporate Customer Care	01344 373 185
	Preferred Accounts (500–5000 employees) Customer Care	0870 906 0010
	Central Government Customer Care	01344 373 193
	Local Government & Education Customer Care	01344 373 199
	Health Customer Care	01344 373 194
	Home and Small Business Sales	0870 907 4000
	Corporate/Public Sector Sales	01344 860 456
	Home and Small Business Fax	0870 907 4006
Uruguay	General Support	toll-free: 000-413-598-2521

<b>Country (City) International Access Code Country Code City Code</b>	<b>Department Name or Service Area, Website and E-Mail Address</b>	<b>Area Codes, Local Numbers, and Toll-Free Numbers</b>
U.S.A. (Austin, Texas)	Automated Order-Status Service	toll-free: 1-800-433-9014
International Access Code: 011	AutoTech (portable and desktop computers)	toll-free: 1-800-247-9362
Country Code: 1	Technical Support (Dell TV, Printers, and Projectors) for Relationship customers	toll-free 1-877-459-7298
	Consumer (Home and Home Office) Technical Support for all other Dell products	toll-free: 1-800-624-9896
	Customer Service	toll-free: 1-800-624-9897
	DellNet™ Service and Support	toll-free: 1-877-Dellnet (1-877-335-5638)
	Employee Purchase Program (EPP) Customers	toll-free: 1-800-695-8133
	Financial Services website: <a href="http://www.dellfinancialservices.com">www.dellfinancialservices.com</a>	
	Financial Services (lease/loans)	toll-free: 1-877-577-3355
	Financial Services (Dell Preferred Accounts [DPA])	toll-free: 1-800-283-2210
	<b>Business</b>	
	Customer Service and Technical Support	toll-free: 1-800-456-3355
	Employee Purchase Program (EPP) Customers	toll-free: 1-800-695-8133
	Printers and Projectors Technical Support	toll-free: 1-877-459-7298
	<b>Public</b> (government, education, and healthcare)	
	Customer Service and Technical Support	toll-free: 1-800-456-3355
	Employee Purchase Program (EPP) Customers	toll-free: 1-800-695-8133
	Dell Sales	toll-free: 1-800-289-3355 or toll-free: 1-800-879-3355
	Dell Outlet Store (Dell refurbished computers)	toll-free: 1-888-798-7561
	Software and Peripherals Sales	toll-free: 1-800-671-3355
	Spare Parts Sales	toll-free: 1-800-357-3355
	Extended Service and Warranty Sales	toll-free: 1-800-247-4618
	Fax	toll-free: 1-800-727-8320
	Dell Services for the Deaf, Hard-of-Hearing, or Speech-Impaired	toll-free: 1-877-DELLTTY (1-877-335-5889)
U.S. Virgin Islands	General Support	1-877-673-3355
Venezuela	General Support	8001-3605

# Glossary

Terms in this Glossary are provided for informational purposes only and may or may not describe features included with your particular computer.

## A

**AC** — alternating current — The form of electricity that powers your computer when you plug the AC adapter power cable in to an electrical outlet.

**ACPI** — advanced configuration and power interface — A power management specification that enables Microsoft® Windows® operating systems to put a computer in standby or hibernate mode to conserve the amount of electrical power allocated to each device attached to the computer.

**AGP** — accelerated graphics port — A dedicated graphics port that allows system memory to be used for video-related tasks. AGP delivers a smooth, true-color video image because of the faster interface between the video circuitry and the computer memory.

**antivirus software** — A program designed to identify, quarantine, and/or delete viruses from your computer.

**APR** — advanced port replicator — A docking device that allows you to conveniently use an external monitor, keyboard, mouse, and other devices with your portable computer.

**ASF** — alert standards format — A standard to define a mechanism for reporting hardware and software alerts to a management console. ASF is designed to be platform- and operating system-independent.

## B

**backup** — A copy of a program or data file on a floppy, CD, DVD, or hard drive. As a precaution, back up the data files from your hard drive regularly.

**battery** — A rechargeable internal power source used to operate portable computers when not connected to an AC adapter and an electrical outlet.

**battery life span** — The length of time (years) during which a portable computer battery is able to be depleted and recharged.

**battery operating time** — The length of time (minutes or hours) that a portable computer battery holds a charge while powering the computer.

**BIOS** — basic input/output system — A program (or utility) that serves as an interface between the computer hardware and the operating system. Unless you understand what effect these settings have on the computer, do not change them. Also referred to as the *system setup program*.

**bit** — The smallest unit of data interpreted by your computer.

**Bluetooth® wireless technology** — A wireless technology standard for short-range (9 m [29 feet]) networking devices that allows for enabled devices to automatically recognize each other.

**boot sequence** — Specifies the order of the devices from which the computer attempts to boot.

**bootable CD** — A CD that you can use to start your computer. In case your hard drive is damaged or your computer has a virus, ensure that you always have a bootable CD or floppy disk available. Your *Drivers and Utilities* or *ResourceCD* is a bootable CD.

**bootable disk** — A disk that you can use to start your computer. In case your hard drive is damaged or your computer has a virus, ensure that you always have a bootable CD or floppy disk available.

**bps** — bits per second — The standard unit for measuring data transmission speed.

**BTU** — British thermal unit — A measurement of heat output.

**bus** — A communication pathway between the components in your computer.

**bus speed** — The speed, given in MHz, that indicates how fast a bus can transfer information.

**byte** — The basic data unit used by your computer. A byte is usually equal to 8 bits.

## C

**C** — Celsius — A temperature measurement scale where 0° is the freezing point and 100° is the boiling point of water.

**cache** — A special high-speed storage mechanism which can be either a reserved section of main memory or an independent high-speed storage device. The cache enhances the efficiency of many processor operations.

**L1 cache** — Primary cache stored inside the processor.

**L2 cache** — Secondary cache which can either be external to the processor or incorporated into the processor architecture.

**carnet** — An international customs document that facilitates temporary imports into foreign countries. Also known as a *merchandise passport*.

**CD** — compact disc — An optical form of storage media, typically used for audio and software programs.

**CD drive** — A drive that uses optical technology to read data from CDs.

**CD player** — The software used to play music CDs. The CD player displays a window with buttons that you use to play a CD.

**CD-R** — CD recordable — A recordable version of a CD. Data can be recorded only once onto a CD-R. Once recorded, the data cannot be erased or written over.

**CD-RW** — CD rewritable — A rewritable version of a CD. Data can be written to a CD-RW disc, and then erased and written over (rewritten).

**CD-RW drive** — A drive that can read CDs and write to CD-RW (rewritable CDs) and CD-R (recordable CDs) discs. You can write to CD-RW discs multiple times, but you can write to CD-R discs only once.

**CD-RW/DVD drive** — A drive, sometimes referred to as a combo drive, that can read CDs and DVDs and write to CD-RW (rewritable CDs) and CD-R (recordable CDs) discs. You can write to CD-RW discs multiple times, but you can write to CD-R discs only once.

**clock speed** — The speed, given in MHz, that indicates how fast computer components that are connected to the system bus operate.

**COA** — Certificate of Authenticity — The Windows alpha-numeric code located on a sticker on your computer. Also referred to as the *Product Key* or *Product ID*.

**Control Panel** — A Windows utility that allows you to modify operating system and hardware settings, such as display settings.

**controller** — A chip that controls the transfer of data between the processor and memory or between the processor and devices.

**CRIMM** — continuity rambus in-line memory module — A special module that has no memory chips and is used to fill unused RIMM slots.

**cursor** — The marker on a display or screen that shows where the next keyboard, touch pad, or mouse action will occur. It often is a blinking solid line, an underline character, or a small arrow.

## D

**DDR SDRAM** — double-data-rate SDRAM — A type of SDRAM that doubles the data burst cycle, improving system performance.

**DDR2 SDRAM** — double-data-rate 2 SDRAM — A type of DDR SDRAM that uses a 4-bit prefetch and other architectural changes to boost memory speed to over 400 MHz.

**device** — Hardware such as a disk drive, printer, or keyboard that is installed in or connected to your computer.

**device driver** — See *driver*.

**DIMM** — Dual Inline Memory Module.



**DIN connector** — A round, six-pin connector that conforms to DIN (Deutsche Industrie-Norm) standards; it is typically used to connect PS/2 keyboard or mouse cable connectors.

**disk striping** — A technique for spreading data over multiple disk drives. Disk striping can speed up operations that retrieve data from disk storage. Computers that use disk striping generally allow the user to select the data unit size or stripe width.

**DMA** — direct memory access — A channel that allows certain types of data transfer between RAM and a device to bypass the processor.

**docking device** — See *APR*.

**DMTF** — Distributed Management Task Force — A consortium of hardware and software companies who develop management standards for distributed desktop, network, enterprise, and Internet environments.

**domain** — A group of computers, programs, and devices on a network that are administered as a unit with common rules and procedures for use by a specific group of users. A user logs on to the domain to gain access to the resources.

**DRAM** — dynamic random-access memory — Memory that stores information in integrated circuits containing capacitors.

**driver** — Software that allows the operating system to control a device such as a printer. Many devices do not work properly if the correct driver is not installed in the computer.

**DSL** — Digital Subscriber Line — A technology that provides a constant, high-speed Internet connection through an analog telephone line.

**dual display mode** — A display setting that allows you to use a second monitor as an extension of your display. Also referred to as *extended display mode*.

**DVD** — digital versatile disc — A high-capacity disc usually used to store movies. DVD drives read most CD media as well.

**DVD drive** — A drive that uses optical technology to read data from DVDs and CDs.

**DVD player** — The software used to watch DVD movies. The DVD player displays a window with buttons that you use to watch a movie.

**DVD-R** — DVD recordable — A recordable version of a DVD. Data can be recorded only once onto a DVD-R. Once recorded, the data cannot be erased or written over.

**DVD+RW** — DVD rewritable — A rewritable version of a DVD. Data can be written to a DVD+RW disc, and then erased and written over (rewritten). (DVD+RW technology is different from DVD-RW technology.)

**DVD+RW drive** — A drive that can read DVDs and most CD media and write to DVD+RW (rewritable DVDs) discs.

**DVI** — digital video interface — A standard for digital transmission between a computer and a digital video display.

## E

**ECC** — error checking and correction — A type of memory that includes special circuitry for testing the accuracy of data as it passes in and out of memory.

**ECP** — extended capabilities port — A parallel connector design that provides improved bidirectional data transmission. Similar to EPP, ECP uses direct memory access to transfer data and often improves performance.

**EIDE** — enhanced integrated device electronics — An improved version of the IDE interface for hard drives and CD drives.

**EMI** — electromagnetic interference — Electrical interference caused by electromagnetic radiation.

**ENERGY STAR®** — Environmental Protection Agency requirements that decrease the overall consumption of electricity.

**EPP** — enhanced parallel port — A parallel connector design that provides bidirectional data transmission.

**ESD** — electrostatic discharge — A rapid discharge of static electricity. ESD can damage integrated circuits found in computer and communications equipment.

**expansion card** — A circuit board that installs in an expansion slot on the system board in some computers, expanding the capabilities of the computer. Examples include video, modem, and sound cards.

**expansion slot** — A connector on the system board (in some computers) where you insert an expansion card, connecting it to the system bus.

**ExpressCard** — A removable I/O card adhering to the PCMCIA standard. Modems and network adapters are common types of ExpressCards. ExpressCards support both the PCI Express and USB 2.0 standard.

**Express Service Code** — A numeric code located on a sticker on your Dell™ computer. Use the Express Service Code when contacting Dell for assistance. Express Service Code service may not be available in some countries.

**extended display mode** — A display setting that allows you to use a second monitor as an extension of your display. Also referred to as *dual display mode*.

**extended PC Card** — A PC Card that extends beyond the edge of the PC Card slot when installed.

## F

**Fahrenheit** — A temperature measurement scale where 32° is the freezing point and 212° is the boiling point of water.

**FCC** — Federal Communications Commission — A U.S. agency responsible for enforcing communications-related regulations that state how much radiation computers and other electronic equipment can emit.

**floppy** — An electromagnetic form of storage media. Also known as a *floppy diskette* or a *floppy disk*.

**floppy drive** — A disk drive that can read and write to floppy disks.

**folder** — A term used to describe space on a disk or drive where files are organized and grouped. Files in a folder can be viewed and ordered in various ways, such as alphabetically, by date, and by size.

**format** — The process that prepares a drive or disk for file storage. When a drive or disk is formatted, the existing information on it is lost.

**FSB** — front side bus — The data path and physical interface between the processor and RAM.

**FTP** — file transfer protocol — A standard Internet protocol used to exchange files between computers connected to the Internet.

## G

**G** — gravity — A measurement of weight and force.

**GB** — gigabyte — A measurement of data storage that equals 1024 MB (1,073,741,824 bytes). When used to refer to hard drive storage, the term is often rounded to 1,000,000,000 bytes.

**GHz** — gigahertz — A measurement of frequency that equals one thousand million Hz, or one thousand MHz. The speeds for computer processors, buses, and interfaces are often measured in GHz.

**graphics mode** — A video mode that can be defined as  $x$  horizontal pixels by  $y$  vertical pixels by  $z$  colors. Graphics modes can display an unlimited variety of shapes and fonts.

**GUI** — graphical user interface — Software that interacts with the user by means of menus, windows, and icons. Most programs that operate on the Windows operating systems are GUIs.

## H

**hard drive** — A drive that reads and writes data on a hard disk. The terms hard drive and hard disk are often used interchangeably.

**heat sink** — A metal plate on some processors that helps dissipate heat.

**help file** — A file that contains descriptive or instructional information about a product. Some help files are associated with a particular program, such as *Help* in Microsoft Word. Other help files function as stand-alone reference sources. Help files typically have a filename extension of **.hlp** or **.chm**.

**hibernate mode** — A power management mode that saves everything in memory to a reserved space on the hard drive and then turns off the computer. When you restart

the computer, the memory information that was saved to the hard drive is automatically restored.

**HTML** — hypertext markup language — A set of codes inserted into an Internet web page intended for display on an Internet browser.

**HTTP** — hypertext transfer protocol — A protocol for exchanging files between computers connected to the Internet.

**Hz** — hertz — A unit of frequency measurement that equals 1 cycle per second. Computers and electronic devices are often measured in kilohertz (kHz), megahertz (MHz), gigahertz (GHz), or terahertz (THz).

## I

**IC** — Industry Canada — The Canadian regulatory body responsible for regulating emissions from electronic equipment, much as the FCC does in the United States.

**IC** — integrated circuit — A semiconductor wafer, or chip, on which thousands or millions of tiny electronic components are fabricated for use in computer, audio, and video equipment.

**IDE** — integrated device electronics — An interface for mass storage devices in which the controller is integrated into the hard drive or CD drive.

**IEEE 1394** — Institute of Electrical and Electronics Engineers, Inc. — A high-performance serial bus used to connect IEEE 1394-compatible devices, such as digital cameras and DVD players, to the computer.

**infrared sensor** — A port that allows you to transfer data between the computer and infrared-compatible devices without using a cable connection.

**integrated** — Usually refers to components that are physically located on the computer's system board. Also referred to as *built-in*.

**I/O** — input/output — An operation or device that enters and extracts data from your computer. Keyboards and printers are I/O devices.

**I/O address** — An address in RAM that is associated with a specific device (such as a serial connector, parallel connector, or expansion slot) and allows the processor to communicate with that device.

**IrDA** — Infrared Data Association — The organization that creates international standards for infrared communications.

**IRQ** — interrupt request — An electronic pathway assigned to a specific device so that the device can communicate with the processor. Each device connection must be assigned an IRQ. Although two devices can share the same IRQ assignment, you cannot operate both devices simultaneously.

**ISP** — Internet service provider — A company that allows you to access its host server to connect directly to the Internet, send and receive e-mail, and access websites. The ISP typically provides you with a software package, user name, and access phone numbers for a fee.

## K

**Kb** — kilobit — A unit of data that equals 1024 bits. A measurement of the capacity of memory integrated circuits.

**KB** — kilobyte — A unit of data that equals 1024 bytes but is often referred to as 1000 bytes.

**key combination** — A command requiring you to press multiple keys at the same time.

**kHz** — kilohertz — A measurement of frequency that equals 1000 Hz.

## L

**LAN** — local area network — A computer network covering a small area. A LAN usually is confined to a building or a few nearby buildings. A LAN can be connected to another LAN over any distance through telephone lines and radio waves to form a wide area network (WAN).

**LCD** — liquid crystal display — The technology used by portable computer and flat-panel displays.

**LED** — light-emitting diode — An electronic component that emits light to indicate the status of the computer.

**local bus** — A data bus that provides a fast throughput for devices to the processor.

**LPT** — line print terminal — The designation for a parallel connection to a printer or other parallel device.

## M

**Mb** — megabit — A measurement of memory chip capacity that equals 1024 Kb.

**Mbps** — megabits per second — One million bits per second. This measurement is typically used for transmission speeds for networks and modems.

**MB** — megabyte — A measurement of data storage that equals 1,048,576 bytes. 1 MB equals 1024 KB. When used to refer to hard drive storage, the term is often rounded to 1,000,000 bytes.

**MB/sec** — megabytes per second — One million bytes per second. This measurement is typically used for data transfer ratings.

**memory** — A temporary data storage area inside your computer. Because the data in memory is not permanent, it is recommended that you frequently save your files while you are working on them, and always save your files before you shut down the computer. Your computer can contain several different forms of memory, such as RAM, ROM, and video memory. Frequently, the word memory is used as a synonym for RAM.

**memory address** — A specific location where data is temporarily stored in RAM.

**memory mapping** — The process by which the computer assigns memory addresses to physical locations at start-up. Devices and software can then identify information that the processor can access.

**memory module** — A small circuit board containing memory chips, which connects to the system board.

**MHz** — megahertz — A measure of frequency that equals 1 million cycles per second. The speeds for computer processors, buses, and interfaces are often measured in MHz.

**Mini PCI** — A standard for integrated peripherals with an emphasis on communications such as modems and NICs. Mini PCI is a small card that is functionally equivalent to a standard PCI expansion card.

**modem** — A device that allows your computer to communicate with other computers over analog telephone lines. Three types of modems include: external, PC Card or ExpressCard, and internal. You typically use your modem to connect to the Internet and exchange e-mail.

**module bay** — A bay that supports devices such as optical drives, a second battery, or a Dell TravelLite™ module.

**monitor** — The high-resolution TV-like device that displays computer output.

**mouse** — A pointing device that controls the movement of the cursor on your screen. Typically you roll the mouse over a hard, flat surface to move the pointer or cursor on your screen.

**ms** — millisecond — A measure of time that equals one thousandth of a second. Access times of storage devices are often measured in ms.

## N

**network adapter** — A chip that provides network capabilities. A computer may include a network adapter on its system board, or it may contain a PC Card with an adapter on it. A network adapter is also referred to as a NIC (network interface controller).

**NIC** — See *network adapter*.

**notification area** — The section of the Windows taskbar that contains icons for providing quick access to programs and computer functions, such as the clock, volume control, and print status. Also referred to as *system tray*.

**ns** — nanosecond — A measure of time that equals one billionth of a second.

**NVRAM** — nonvolatile random access memory — A type of memory that stores data when the computer is turned off or loses its external power source. NVRAM is used for maintaining computer configuration information such as date, time, and other system setup options that you can set.

## O

**optical drive** — A drive that uses optical technology to read or write data from CDs, DVDs, or DVD+RWs. Example of optical drives include CD drives, DVD drives, CD-RW drives, and CD-RW/DVD combo drives.

## P

**parallel connector** — An I/O port often used to connect a parallel printer to your computer. Also referred to as an *LPT port*.

**partition** — A physical storage area on a hard drive that is assigned to one or more logical storage areas known as logical drives. Each partition can contain multiple logical drives.

**PC Card** — A removable I/O card adhering to the PCMCIA standard. Modems and network adapters are common types of PC Cards.

**PCI** — peripheral component interconnect — PCI is a local bus that supports 32- and 64-bit data paths, providing a high-speed data path between the processor and devices such as video, drives, and networks.

**PCI Express** — A modification to the PCI interface that boosts the data transfer rate between the processor and the devices attached to it. PCI Express can transfer data at speeds from 250 MB/sec to 4 GB/sec. If the PCI Express chip set and the device are capable of different speeds, they will operate at the slower speed.

**PCMCIA** — Personal Computer Memory Card International Association — The organization that establishes standards for PC Cards.

**PIN** — personal identification number — A sequence of numerals and/or letters used to restrict unauthorized access to computer networks and other secure systems.

**PIO** — programmed input/output — A method of transferring data between two devices through the processor as part of the data path.

**pixel** — A single point on a display screen. Pixels are arranged in rows and columns to create an image. A video resolution, such as 800 x 600, is expressed as the number of pixels across by the number of pixels up and down.

**Plug-and-Play** — The ability of the computer to automatically configure devices. Plug and Play provides automatic installation, configuration, and compatibility with existing hardware if the BIOS, operating system, and all devices are Plug and Play compliant.

**POST** — power-on self-test — Diagnostics programs, loaded automatically by the BIOS, that perform basic tests on the major computer components, such as memory, hard drives, and video. If no problems are detected during POST, the computer continues the start-up.

**processor** — A computer chip that interprets and executes program instructions. Sometimes the processor is referred to as the *CPU* (central processing unit).

**program** — Any software that processes data for you, including spreadsheet, word processor, database, and game packages. Programs require an operating system to run.

**PS/2** — personal system/2 — A type of connector for attaching a PS/2-compatible keyboard, mouse, or keypad.

**PXE** — pre-boot execution environment — A WfM (Wired for Management) standard that allows networked computers that do not have an operating system to be configured and started remotely.

## R

**RAID** — redundant array of independent disks — A method of providing data redundancy. Some common implementations of RAID include RAID 0, RAID 1, RAID 5, RAID 10, and RAID 50.

**RAM** — random-access memory — The primary temporary storage area for program instructions and data. Any information stored in RAM is lost when you shut down your computer.

**readme file** — A text file included with a software package or hardware product. Typically, readme files provide installation information and describe new product enhancements or corrections that have not yet been documented.

**read-only** — Data and/or files you can view but cannot edit or delete. A file can have read-only status if:

- It resides on a physically write-protected floppy disk, CD, or DVD.
- It is located on a network in a directory and the system administrator has assigned rights only to specific individuals.

**refresh rate** — The frequency, measured in Hz, at which your screen's horizontal lines are recharged (sometimes also referred to as its *vertical frequency*). The higher the refresh rate, the less video flicker can be seen by the human eye.

**resolution** — The sharpness and clarity of an image produced by a printer or displayed on a monitor. The higher the resolution, the sharper the image.

**RFI** — radio frequency interference — Interference that is generated at typical radio frequencies, in the range of 10 kHz to 100,000 MHz. Radio frequencies are at the lower end of the electromagnetic frequency spectrum and are more likely to have interference than the higher frequency radiations, such as infrared and light.

**ROM** — read-only memory — Memory that stores data and programs that cannot be deleted or written to by the computer. ROM, unlike RAM, retains its contents after you shut down your computer. Some programs essential to the operation of your computer reside in ROM.

**RPM** — revolutions per minute — The number of rotations that occur per minute. Hard drive speed is often measured in rpm.

**RTC** — real time clock — Battery-powered clock on the system board that keeps the date and time after you shut down the computer.

**RTCST** — real-time clock reset — A jumper on the system board of some computers that can often be used for troubleshooting problems.

## S

**ScanDisk** — A Microsoft utility that checks files, folders, and the hard disk's surface for errors. ScanDisk often runs when you restart the computer after it has stopped responding.

**SDRAM** — synchronous dynamic random-access memory — A type of DRAM that is synchronized with the optimal clock speed of the processor.

**serial connector** — An I/O port often used to connect devices such as a handheld digital device or digital camera to your computer.

**Service Tag** — A bar code label on your computer that identifies your computer when you access Dell Support at [support.dell.com](http://support.dell.com) or when you call Dell for customer service or technical support.

**setup program** — A program that is used to install and configure hardware and software. The **setup.exe** or **install.exe** program comes with most Windows software packages. *Setup program* differs from the *system setup program*.

**shortcut** — An icon that provides quick access to frequently used programs, files, folders, and drives. When you place a shortcut on your Windows desktop and double-click the icon, you can open its corresponding folder or file without having to find it first. Shortcut icons do not change the location of files. If you delete a shortcut, the original file is not affected. Also, you can rename a shortcut icon.

**shutdown** — The process of closing windows and exiting programs, exiting the operating system, and turning off your computer. You can lose data if you turn off your computer before completing a shutdown.

**smart card** — A card that is embedded with a processor and a memory chip. Smart cards can be used to authenticate a user on computers equipped for smart cards.

**software** — Anything that can be stored electronically, such as computer files or programs.

**S/PDIF** — Sony/Philips Digital Interface — An audio transfer file format that allows the transfer of audio from one file to another without converting it to and from an analog format, which could degrade the quality of the file.

**standby mode** — A power management mode that shuts down all unnecessary computer operations to save energy.

**Strike Zone™** — Reinforced area of the platform base that protects the hard drive by acting as a dampening device when a computer experiences resonating shock or is dropped (whether the computer is on or off).

**surge protectors** — Prevent voltage spikes, such as those that may occur during an electrical storm, from entering the computer through the electrical outlet. Surge protectors do not protect against lightning strikes or against brownouts, which occur when the voltage drops more than 20 percent below the normal AC-line voltage level.

Network connections cannot be protected by surge protectors. Always disconnect the network cable from the network connector during electrical storms.

**SVGA** — super-video graphics array — A video standard for video cards and controllers. Typical SVGA resolutions are 800 x 600 and 1024 x 768.

The number of colors and resolution that a program displays depends on the capabilities of the monitor, the video controller and its drivers, and the amount of video memory installed in the computer.

**S-video TV-out** — A connector used to attach a TV or digital audio device to the computer.

**SXGA** — super-extended graphics array — A video standard for video cards and controllers that supports resolutions up to 1280 x 1024.

**SXGA+** — super-extended graphics array plus — A video standard for video cards and controllers that supports resolutions up to 1400 x 1050.

**system board** — The main circuit board in your computer. Also known as the *motherboard*.

**system setup** — A utility that serves as an interface between the computer hardware and the operating system. System setup allows you to configure user-selectable options in the BIOS, such as date and time or system password. Unless you understand what effect the settings have on the computer, do not change the settings for this program.

**system tray** — See *notification area*.

## T

**TAPI** — telephony application programming interface — Enables Windows programs to operate with a wide variety of telephony devices, including voice, data, fax, and video.

**text editor** — A program used to create and edit files that contain only text; for example, Windows Notepad uses a text editor. Text editors do not usually provide word wrap or formatting functionality (the option to underline, change fonts, and so on).

**travel module** — A plastic device designed to fit inside the module bay of a portable computer to reduce the weight of the computer.

## U

**UMA** — unified memory allocation — System memory dynamically allocated to video.

**UPS** — uninterruptible power supply — A backup power source used when the electrical power fails or drops to an unacceptable voltage level. A UPS keeps a computer running for a limited amount of time when there is no electrical power. UPS systems typically provide surge suppression and may also provide voltage regulation. Small UPS systems provide battery power for a few minutes to enable you to shut down your computer.

**USB** — universal serial bus — A hardware interface for a low-speed device such as a USB-compatible keyboard, mouse, joystick, scanner, set of speakers, printer, broadband devices (DSL and cable modems), imaging devices, or storage devices. Devices are plugged directly into a 4-pin socket on your computer or into a multi-port hub that plugs into your computer. USB devices can be connected and disconnected while the computer is turned on, and they can also be daisy-chained together.

**UTP** — unshielded twisted pair — Describes a type of cable used in most telephone networks and some computer networks. Pairs of unshielded wires are twisted to protect against electromagnetic interference, rather than relying on a metal sheath around each pair of wires to protect against interference.

**UXGA** — ultra extended graphics array — A video standard for video cards and controllers that supports resolutions up to 1600 x 1200.

## V

**video controller** — The circuitry on a video card or on the system board (in computers with an integrated video controller) that provides the video capabilities—in combination with the monitor—for your computer.

**video memory** — Memory that consists of memory chips dedicated to video functions. Video memory is usually faster than system memory. The amount of video memory installed primarily influences the number of colors that a program can display.

**video mode** — A mode that describes how text and graphics are displayed on a monitor. Graphics-based software, such as Windows operating systems, displays in video modes that can be defined as  $x$  horizontal pixels by  $y$  vertical pixels by  $z$  colors. Character-based software, such as text editors, displays in video modes that can be defined as  $x$  columns by  $y$  rows of characters.

**video resolution** — See *resolution*.

**virus** — A program that is designed to inconvenience you or to destroy data stored on your computer. A virus program moves from one computer to another through an infected disk, software downloaded from the Internet, or e-mail attachments. When an infected program starts, its embedded virus also starts.

A common type of virus is a boot virus, which is stored in the boot sectors of a floppy disk. If the floppy disk is left in the drive when the computer is shut down and then turned on, the computer is infected when it reads the boot sectors of the floppy disk expecting to find the operating system. If the computer is infected, the boot virus may replicate itself onto all the floppy disks that are read or written in that computer until the virus is eradicated.

**V** — volt — The measurement of electric potential or electromotive force. One V appears across a resistance of 1 ohm when a current of 1 ampere flows through that resistance.

## W

**W** — watt — The measurement of electrical power. One W is 1 ampere of current flowing at 1 volt.

**WHr** — watt-hour — A unit of measure commonly used to indicate the approximate capacity of a battery. For example, a 66-WHr battery can supply 66 W of power for 1 hour or 33 W for 2 hours.

**wallpaper** — The background pattern or picture on the Windows desktop. Change your wallpaper through the Windows Control Panel. You can also scan in your favorite picture and make it wallpaper.

**write-protected** — Files or media that cannot be changed. Use write-protection when you want to protect data from being changed or destroyed. To write-protect a 3.5-inch floppy disk, slide its write-protect tab to the open position.

**WXGA** — wide-aspect extended graphics array — A video standard for video cards and controllers that supports resolutions up to 1280 x 800.

## X

**XGA** — extended graphics array — A video standard for video cards and controllers that supports resolutions up to 1024 x 768.

## Z

**ZIF** — zero insertion force — A type of socket or connector that allows a computer chip to be installed or removed with no stress applied to either the chip or its socket.

**Zip** — A popular data compression format. Files that have been compressed with the Zip format are called Zip files and usually have a filename extension of **.zip**. A special kind of zipped file is a self-extracting file, which has a filename extension of **.exe**. You can unzip a self-extracting file by double-clicking it.



**Zip drive** — A high-capacity floppy drive developed by Iomega Corporation that uses 3.5-inch removable disks called Zip disks. Zip disks are slightly larger than regular floppy disks, about twice as thick, and hold up to 100 MB of data.



# Index

## Numbers

5-in-1 media memory card reader, 71

## A

audio connectors, 20

audio device

connecting, 55

enabling, 64

audio. *See sound*

## B

battery

charge gauge, 47

charging, 47

checking the charge, 46

description, 23

health gauge, 47

installing, 108

life expectancy, 39

low-battery warning, 47

low-charge warning, 43

performance, 45

power conservation, 39

power meter, 46

removing, 108

storing, 48

battery-bay latch release, 23

blanks

ExpressCards, 67

removing, 68, 72

Bluetooth wireless technology

card

device status light, 18

installing, 127

boot sequence, 138

brightness

adjusting, 33

## C

CardBus technology

ExpressCards, 45, 67

media memory cards, 71

carnet, 140

CD drive

problems, 81

CD-RW drive

problems, 81

CDs, 52

operating system, 14

playing, 49

Check Disk, 81

cleaning

touch pad, 142

computer

crashes, 88-89

restore to previous operating state, 100

restore to previous state, 99

slow performance, 83, 90

specifications, 131

stops responding, 88

conflicts

software and hardware

incompatibilities, 99

connecting

audio device, 55

TV, 55

Control Panel

power options, 42

copying CDs

general information, 52

helpful tips, 54

how to, 52

copying DVDs

general information, 52

helpful tips, 54

how to, 52

## D

Dell

contacting, 145

support policy, 142

support site, 13

- Dell Diagnostics, 77
  - starting from the Drivers and Utilities CD, 78
  - starting from your hard drive, 77
- Dell MediaDirect, 17, 54
  - problems, 89
- Dell Premier Support website, 12
- device security screw
  - about, 111
- device status lights, 16
- diagnostics
  - Dell, 77
- display
  - adjusting brightness, 33
  - adjusting the size of icons, 44
  - adjusting the size of toolbars, 44
  - description, 16
  - resolution, 34
  - switching the video image, 33
- display latch, 18
- display settings for a TV
  - enabling in Windows XP, 66
- display. See *monitor*
- documentation
  - End User License Agreement, 12
  - ergonomics, 12
  - online, 13
  - Product Information Guide, 12
  - regulatory, 12

- documentation (*continued*)
  - safety, 12
  - warranty, 12
- Dolby headphones, setting up, 65
- drivers, 96
  - about, 96
  - identifying, 97
  - reinstalling, 97
- Drivers and Utilities CD, 98
- drives
  - problems, 80
  - See *hard drive*
- DVD drive
  - problems, 81
- DVDs, 52
  - playing, 49
- E**
- End User License Agreement, 12
- ergonomics information, 12
- error messages, 83
- ExpressCard slot
  - description, 20
- ExpressCards
  - blanks, 67-68
  - CardBus technology, 45, 67
  - extended, 45, 67
  - installing, 67
  - removing, 68
  - slots, 45, 67
  - types, 45, 67

- F**
- fan
  - description, 19, 23
- FCC notice, 142
- Files and Settings Transfer Wizard, 26
- floppy drive
  - connecting to a USB connector, 21-22
- H**
- hard drive
  - description, 24
  - problems, 81
  - replacing, 108
  - returning to Dell, 111
- hardware
  - conflicts, 99
  - Dell Diagnostics, 77
- Hardware Troubleshooter, 99
- Help and Support Center, 13
- help file
  - Windows Help and Support Center, 13
- hibernate mode, 42-43
- hinge cover
  - removing, 123
- I**
- icons
  - adjusting the size, 44

IEEE 1394 connector  
description, 20  
problems, 87

Internet connection  
about, 25  
options, 25  
setting up, 25

IRQ conflicts, 99

## K

keyboard  
description, 17  
numeric keypad, 35  
problems, 87  
removing, 125  
shortcuts, 36

keyboard status lights  
description, 18

keypad  
numeric, 35

## L

labels  
Microsoft Windows, 12  
Service Tag, 12

lost computer, 141

## M

media control buttons  
Dell MediaDirect button, 54  
description, 17

media control buttons  
(*continued*)  
play/pause/Dell  
MediaDirect, 17

media memory cards  
blanks, 72  
CardBus technology, 71  
installing, 71  
removing, 72  
slots, 71  
types, 71

memory  
adding, 113, 115  
installing, 112  
removing, 114, 116

memory module cover, 23

messages  
error, 83

Microsoft Windows label, 12

Mini PCI card  
installing, 121

modem  
installing, 119

modem connector  
description, 21

modem cover  
description, 24

module bay  
device security screw, 111  
swapping devices, 111

monitor  
problems, 95  
switching the video image, 33

## N

network  
Network Setup Wizard, 73  
problems, 91  
setting up, 73

network connector  
description, 22

Network Setup Wizard, 73

## O

operating system  
CD, 14  
reinstalling, 14  
reinstalling Windows XP, 100

Operating System CD, 14

optical drive  
description, 21

optical-drive-tray eject  
button  
description, 21

## P

PC Restore, 101

playing CDs, 49

playing DVDs, 49

power  
hibernate mode, 42  
line conditioners, 30  
management, 39  
power options properties, 42  
problems, 91

power (*continued*)  
  protection devices, 30  
  settings, 39  
  standby mode, 41  
  surge protectors, 30  
  UPS, 30

power light  
  conditions, 91

power management  
  adjusting settings, 44  
  QuickSet, 44

power management. See  
  *power*

printer  
  cable, 29  
  connecting, 29  
  problems, 92  
  setting up, 29  
  USB, 30

problems  
  blue screen, 89  
  CD drive, 81  
  CD-RW drive, 81  
  computer crashes, 88-89  
  computer does not start up, 88  
  computer stops responding, 88  
  conflicts, 99  
  Dell Diagnostics, 77  
  Dell MediaDirect, 89  
  drives, 80  
  DVD drive, 81  
  error messages, 83  
  hard drive, 81  
  IEEE 1394 connector, 87  
  keyboard, 87  
  lockups, 88  
  network, 91

problems (*continued*)  
  power, 91  
  power light conditions, 91  
  printer, 92  
  program crashes repeatedly, 88  
  program stops responding, 88  
  programs and Windows  
    compatibility, 89  
  restore computer to previous  
    operating state, 100  
  restore operating system to  
    previous state, 99  
  scanner, 93  
  slow computer  
    performance, 83, 90  
  software, 88-90  
  sound and speakers, 94  
  speaker, 94  
  spyware, 83, 90  
  technical support policy, 142  
  video and monitor, 95

Product Information  
  Guide, 12

**Q**  
QuickSet, 36, 44, 54

**R**  
RAM. See *memory*  
regulatory information, 12  
regulatory notice  
  FCC, 142  
reinstalling  
  Windows XP, 100

resolution  
  setting, 34  
ResourceCD  
  Dell Diagnostics, 77

**S**  
S/PDIF digital audio  
  enabling, 64  
safety instructions, 12  
scanner  
  problems, 93  
screen. See *monitor*  
security  
  device security screw, 111  
security cable slot  
  description, 19  
Service Tag, 12  
software  
  conflicts, 99  
  problems, 89-90  
sound  
  problems, 94  
  volume, 94  
speaker  
  problems, 94  
  volume, 94  
speakers  
  description, 17  
specifications, 131  
spyware, 83, 90  
standby mode  
  about, 41, 43  
  password options, 43

stolen computer, 141  
support  
    contacting Dell, 145  
    policy, 142  
support website, 13  
S-video TV-out connector  
    description, 20  
System Restore, 99-100  
system setup program  
    commonly used options, 138  
    purpose, 137  
    screens, 138  
    viewing, 137

## T

taskbar  
    QuickSet icon, 44  
technical support  
    policy, 142  
toolbars  
    adjusting the size, 44  
touch pad  
    cleaning, 142  
    customizing, 38  
    description, 17  
transferring information to a  
    new computer, 26  
traveling with the computer  
    by air, 140  
    identification tag, 139  
    packing, 139  
    tips, 140

troubleshooting  
    conflicts, 99  
    Dell Diagnostics, 77  
    external keyboard  
        problems, 87  
    Hardware Troubleshooter, 99  
    Help and Support Center, 13  
    restore computer to previous  
        operating state, 100  
    restore to previous state, 99

## TV

connecting, 55  
enabling display settings in  
    Windows XP, 66

## U

uninterruptible power supply.  
    See *UPS*  
UPS, 30  
USB connectors  
    description, 21-22

## V

video  
    problems, 95  
video connector  
    description, 22  
volume  
    adjusting, 94

## W

warranty information, 12  
Windows XP  
    Device Driver Rollback, 97  
    enabling display settings for a  
        TV, 66  
    Files and Settings Transfer  
        Wizard, 26  
    Hardware Troubleshooter, 99  
    Help and Support Center, 13  
    hibernate mode, 42  
    Network Setup Wizard, 73  
    power options properties, 42  
    Program Compatibility  
        Wizard, 89  
    reinstalling, 14, 100  
    standby mode, 41  
    System Restore, 99-100  
wireless  
    turning activity on and off, 44  
wizards  
    Files and Settings Transfer  
        Wizard, 26  
    Network Setup Wizard, 73  
    Program Compatibility  
        Wizard, 89

