

Dell™ Inspiron™ 510m

# Owner's Manual

Model PP10L

[www.dell.com](http://www.dell.com) | [support.dell.com](http://support.dell.com)

## Notes, Notices, and Cautions

 **NOTE:** A NOTE indicates important information that helps you make better use of your computer.

 **NOTICE:** A NOTICE indicates either potential damage to hardware or loss of data and tells you how to avoid the problem.

 **CAUTION:** A CAUTION indicates a potential for property damage, personal injury, or death.

## Abbreviations and Acronyms

For a complete list of abbreviations and acronyms, see the *Dell Inspiron Help* file. To access the help file, see page 9.

If you purchased a Dell™ n Series computer, any references in this document to Microsoft® Windows® operating systems are not applicable.

---

**Information in this document is subject to change without notice.**

© 2004–2005 Dell Inc. All rights reserved.

Reproduction in any manner whatsoever without the written permission of Dell Inc. is strictly forbidden.

Trademarks used in this text: *Dell*, the *DELL* logo, *Latitude*, *Inspiron*, *Dimension*, *OptiPlex*, *Dell Precision*, *Dell TravelLite*, *PowerApp*, *PowerEdge*, *PowerConnect*, *PowerVault*, and *TrueMobile* are trademarks of Dell Inc.; *Intel* and *Pentium* are registered trademarks and *Centrino* is a trademark of Intel Corporation; *Microsoft* and *Windows* are registered trademarks Microsoft Corporation; *Bluetooth* is a registered trademark owned by Bluetooth SIG, Inc. and is used by Dell Inc. under license.

Other trademarks and trade names may be used in this document to refer to either the entities claiming the marks and names or their products. Dell Inc. disclaims any proprietary interest in trademarks and trade names other than its own.

Model PP10L

April 2005

P/N D7898

Rev. A02

# Contents

	<b>Finding Information</b> . . . . .	<b>9</b>
<b>1</b>	<b>A Tour of Your Computer</b>	
	<b>Front View</b> . . . . .	<b>13</b>
	<b>Left View</b> . . . . .	<b>16</b>
	<b>Right View</b> . . . . .	<b>18</b>
	<b>Back View</b> . . . . .	<b>19</b>
	<b>Bottom View</b> . . . . .	<b>23</b>
<b>2</b>	<b>Setting Up Your Computer</b>	
	<b>Connecting to the Internet</b> . . . . .	<b>25</b>
	Setting Up Your Internet Connection . . . . .	25
	<b>Modem and Internet Connection Problems</b> . . . . .	<b>26</b>
	<b>E-Mail Problems</b> . . . . .	<b>28</b>
	<b>Setting Up a Printer</b> . . . . .	<b>28</b>
	Printer Cable . . . . .	28
	Connecting a Parallel Printer . . . . .	28
	Connecting a USB Printer . . . . .	29
	<b>Printer Problems</b> . . . . .	<b>30</b>
	<b>Power Protection Devices</b> . . . . .	<b>31</b>
	Surge Protectors . . . . .	31
	Line Conditioners . . . . .	31
	Uninterruptible Power Supplies . . . . .	32
	<b>Turning Off Your Computer</b> . . . . .	<b>32</b>

3	Using a Battery	
	<b>Battery Performance</b>	<b>33</b>
	<b>Checking the Battery Charge</b>	<b>34</b>
	Dell™ QuickSet Battery Meter	34
	Microsoft® Windows® Power Meter	35
	Charge Gauge	35
	Low-Battery Warning	35
	<b>Charging the Battery</b>	<b>35</b>
	<b>Removing a Battery</b>	<b>36</b>
	<b>Installing a Battery</b>	<b>36</b>
	<b>Removing and Installing a Reserve Battery</b>	<b>37</b>
	<b>Storing a Battery</b>	<b>38</b>
	<b>Power Problems</b>	<b>38</b>
4	Using the Module Bay	
	<b>About the Module Bay</b>	<b>41</b>
	<b>Removing and Installing Devices While the Computer Is Turned Off</b>	<b>41</b>
	<b>Removing and Installing Devices While the Computer Is Running</b>	<b>42</b>
5	Using the Keyboard and Touch Pad	
	<b>Numeric Keypad</b>	<b>43</b>
	<b>Keyboard Shortcuts</b>	<b>44</b>
	System Functions	44
	Battery	44
	CD or DVD Tray	44
	Display Functions	44
	Radios (Including Wireless Networking and Bluetooth®)	
	Wireless Technology)	44
	Power Management	44
	Speaker Functions	45
	Microsoft® Windows® Logo Key Functions	45

<b>Touch Pad</b> . . . . .	<b>46</b>
<b>Customizing the Touch Pad</b> . . . . .	<b>47</b>
<b>Touch Pad or Mouse Problems</b> . . . . .	<b>47</b>
<b>External Keyboard Problems</b> . . . . .	<b>48</b>
<b>Unexpected Characters</b> . . . . .	<b>48</b>
<b>6 Using CDs, DVDs, and other Multimedia</b>	
<b>Using CDs and DVDs</b> . . . . .	<b>49</b>
<b>Drive Problems</b> . . . . .	<b>49</b>
If you cannot save a file to a floppy disk drive . . . . .	49
If you cannot play a CD, CD-RW, or DVD . . . . .	50
If you cannot eject the CD, CD-RW, or DVD drive tray . . . . .	51
If you hear an unfamiliar scraping or grinding sound . . . . .	52
If the CD-RW drive stops writing . . . . .	52
If you have problems with a hard drive. . . . .	52
<b>Sound and Speaker Problems</b> . . . . .	<b>53</b>
If you have a problem with integrated speakers . . . . .	53
If you have a problem with external speakers . . . . .	53
<b>Copying CDs and DVDs</b> . . . . .	<b>54</b>
How to Copy a CD or DVD. . . . .	54
Using Blank CD-Rs and CD-RWs . . . . .	55
Helpful Tips . . . . .	55
<b>Connecting a Television to the Computer</b> . . . . .	<b>56</b>
S-Video Connection. . . . .	56
Composite Video Connection . . . . .	58
Enabling the Display Settings for a Television . . . . .	60
<b>7 Setting Up a Home and Office Network</b>	
<b>Connecting to a Network Adapter</b> . . . . .	<b>63</b>
<b>Network Setup Wizard</b> . . . . .	<b>64</b>
<b>Network Problems</b> . . . . .	<b>64</b>

<b>Connecting to a Wireless Local Area Network . . . . .</b>	<b>64</b>
Determining Your Network Type . . . . .	65
Connecting to a Wireless Network in Microsoft® Windows® XP . . . . .	65

## 8 Solving Problems

<b>Error Messages . . . . .</b>	<b>69</b>
<b>Video and Display Problems. . . . .</b>	<b>70</b>
If the display is blank . . . . .	70
If the display is difficult to read . . . . .	70
If only part of the display is readable. . . . .	71
<b>Modem and Internet Connection Problems . . . . .</b>	<b>72</b>
<b>Scanner Problems . . . . .</b>	<b>73</b>
If you cannot save a file to a floppy disk drive . . . . .	74
If you have problems with a hard drive. . . . .	75
<b>PC Card Problems . . . . .</b>	<b>75</b>
<b>General Program Problems . . . . .</b>	<b>76</b>
A program crashes . . . . .	76
A program stops responding . . . . .	76
A solid blue screen appears . . . . .	76
Error messages appear. . . . .	76
<b>Resolving Other Technical Problems . . . . .</b>	<b>76</b>
<b>If Your Dell™ Computer Gets Wet . . . . .</b>	<b>77</b>
<b>If You Drop or Damage Your Computer . . . . .</b>	<b>78</b>
<b>Drivers . . . . .</b>	<b>78</b>
What Is a Driver? . . . . .	78
Identifying Drivers . . . . .	79
Reinstalling Drivers and Utilities . . . . .	79
<b>Resolving Software and Hardware Incompatibilities . . . . .</b>	<b>80</b>
<b>Restoring Your Operating System . . . . .</b>	<b>81</b>
Using Microsoft Windows XP System Restore . . . . .	81
Using Dell PC Restore by Symantec . . . . .	83

<b>Dell Diagnostics</b> . . . . .	<b>84</b>
When to Use the Dell Diagnostics . . . . .	84
<b>9 Adding and Replacing Parts</b>	
<b>Before You Begin</b> . . . . .	<b>87</b>
Recommended Tools . . . . .	87
Shutting Down Your Computer . . . . .	87
<b>Adding Memory</b> . . . . .	<b>89</b>
<b>Adding a Mini PCI Card</b> . . . . .	<b>91</b>
<b>Replacing the Hard Drive</b> . . . . .	<b>94</b>
Returning a Hard Drive to Dell . . . . .	95
<b>Keyboard</b> . . . . .	<b>96</b>
<b>Internal Card With Bluetooth® Wireless Technology</b> . . . . .	<b>98</b>
<b>10 Appendix</b>	
<b>Specifications</b> . . . . .	<b>101</b>
<b>Viewing the System Setup Screens</b> . . . . .	<b>107</b>
<b>System Setup Screens</b> . . . . .	<b>107</b>
<b>Commonly Used Options</b> . . . . .	<b>108</b>
Changing the Boot Sequence . . . . .	108
Changing Printer Modes . . . . .	109
Changing COM Ports . . . . .	109
<b>Enabling the Infrared Sensor</b> . . . . .	<b>109</b>
<b>FCC Notices (U.S. Only)</b> . . . . .	<b>110</b>
NOM Information (Mexico Only) . . . . .	112
<b>Contacting Dell</b> . . . . .	<b>112</b>
<b>Index</b> . . . . .	<b>131</b>







# Finding Information

 **NOTE:** Some features may not be available for your computer or in certain countries.

 **NOTE:** Additional information may ship with your computer.

What Are You Looking For?	Find It Here
<ul style="list-style-type: none"><li>• Warranty information</li><li>• Terms and Conditions (U.S. only)</li><li>• Safety instructions</li><li>• Regulatory information</li><li>• Ergonomics information</li><li>• End User License Agreement</li></ul>	<p data-bbox="725 413 1043 435"><b>Dell™ Product Information Guide</b></p> 
<ul style="list-style-type: none"><li>• How to set up my computer</li></ul>	<p data-bbox="725 760 868 782"><b>Setup Diagram</b></p> 
<ul style="list-style-type: none"><li>• Tips on using Microsoft® Windows®</li><li>• How to play CDs and DVDs</li><li>• How to use standby mode and hibernate mode</li><li>• How to change my display resolution</li><li>• How to clean my computer</li></ul>	<p data-bbox="725 1272 811 1295"><b>Help File</b></p> <ol style="list-style-type: none"><li data-bbox="733 1307 1243 1329">1 Click the <b>Start</b> button and click <b>Help and Support</b>.</li><li data-bbox="733 1341 1265 1364">2 Click <b>User and system guides</b> and click <b>User's guides</b>.</li><li data-bbox="733 1376 1001 1399">3 Click <b>Dell Inspiron Help</b>.</li></ol>

---

**What Are You Looking For?**

---

- Service Tag and Express Service Code
- Microsoft Windows License Label

**Find It Here**

---

**Service Tag and Microsoft Windows License**

These labels are located on the bottom of your computer.

- Use the Service Tag to identify your computer when you use [support.dell.com](http://support.dell.com) or contact technical support.
- Enter the Express Service Code to direct your call when contacting technical support.



- 
- How to use Windows XP
  - Documentation for my computer
  - Documentation for devices (such as a modem)

**Windows Help and Support Center**

- 1** Click the **Start** button and click **Help and Support**.
- 2** Type a word or phrase that describes your problem and click the arrow icon.
- 3** Click the topic that describes your problem.
- 4** Follow the instructions on the screen.

What Are You Looking For?	Find It Here
<ul style="list-style-type: none"> <li>• Solutions — Troubleshooting hints and tips, articles from technicians, online courses, frequently asked questions</li> <li>• Community — Online discussion with other Dell customers</li> <li>• Upgrades — Upgrade information for components, such as memory, the hard drive, and the operating system</li> <li>• Customer Care — Contact information, service call and order status, warranty, and repair information</li> <li>• Service and support — Service call status and support history, service contract, online discussions with technical support</li> <li>• Reference — Computer documentation, details on my computer configuration, product specifications, and white papers</li> <li>• Downloads — Certified drivers, patches, and software updates</li> <li>• Notebook System Software (NSS)— If you reinstall the operating system for your computer, you should also reinstall the NSS utility. NSS provides critical updates for your operating system and support for Dell™ 3.5-inch USB floppy drives, Intel® Pentium® M processors, optical drives, and USB devices. NSS is necessary for correct operation of your Dell computer. The software automatically detects your computer and operating system and installs the updates appropriate for your configuration.</li> </ul>	<p><b>Dell Support Website</b> — <a href="http://support.dell.com">support.dell.com</a></p> <p><b>NOTE:</b> Select your region to view the appropriate support site.</p> <p><b>NOTE:</b> Corporate, government, and education customers can also use the customized Dell Premier Support website at <a href="http://premier.support.dell.com">premier.support.dell.com</a>. The website may not be available in all regions.</p>
<p>To download Notebook System Software:</p> <ol style="list-style-type: none"> <li><b>1</b> Go to <a href="http://support.dell.com">support.dell.com</a> and click <b>Downloads</b>.</li> <li><b>2</b> Enter your Service Tag or product model.</li> <li><b>3</b> In the <b>Download Category</b> drop-down menu, click <b>All</b>.</li> <li><b>4</b> Select the operating system and operating system language for your computer, and click <b>Submit</b>.</li> <li><b>5</b> Under <b>Select a Device</b>, scroll to <b>System and Configuration Utilities</b>, and click <b>Dell Notebook System Software</b>.</li> </ol>	



# A Tour of Your Computer

## Front View

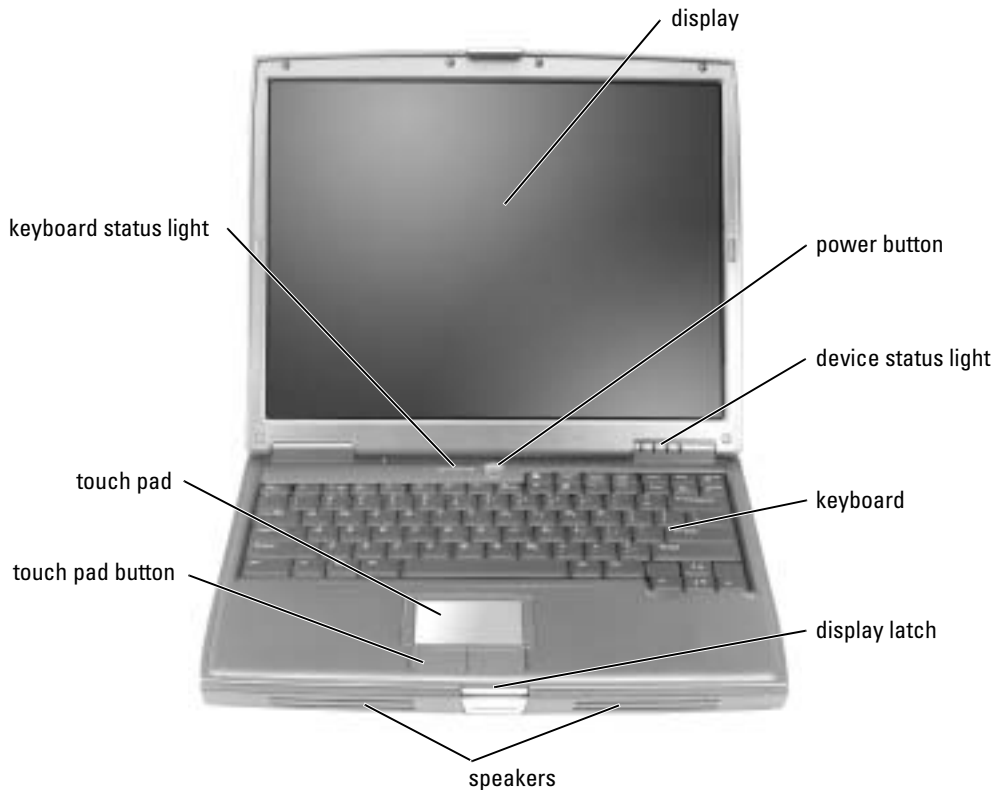

**DISPLAY** — For more information about your display, see the *Dell Inspiron Help* file. To access the help file, see page 9.

**POWER BUTTON** — Press the power button to turn on the computer or exit a power management mode.



**NOTICE:** To avoid losing data, turn off your computer by performing a Microsoft® Windows® operating system shutdown rather than by pressing the power button.

If the computer stops responding, press and hold the power button until the computer turns off completely (which may take several seconds).

#### DEVICE STATUS LIGHTS





---

 Turns on when you turn on the computer and blinks when the computer is in a power management mode.

---



 Turns on when the computer reads or writes data.

 **NOTICE:** To avoid loss of data, never turn off the computer while the  light is flashing.

---

 Turns on steadily or blinks to indicate battery charge status.

---

 Turns on when Bluetooth® wireless technology is enabled.  
**NOTE:** Bluetooth wireless technology is an optional feature, so the  light turns on only if you ordered Bluetooth wireless technology with your computer. For more information, see the documentation that came with your Bluetooth wireless technology.

To turn off only the Bluetooth wireless technology functionality, right-click the  icon in the notification area and select **Disable Bluetooth Radio**.

To quickly enable or disable all wireless devices, press <Fn><F2>.

---

If the computer is connected to an electrical outlet, the  light operates as follows:

- Solid green: The battery is charging.
- Flashing green: The battery is almost fully charged.

If the computer is running on a battery, the  light operates as follows:

- Off: The battery is adequately charged (or the computer is turned off).
- Flashing orange: The battery charge is low.
- Solid orange: The battery charge is critically low.

**KEYBOARD** — The keyboard includes a numeric keypad as well as the Windows logo key. For information on supported keyboard shortcuts, see page 43.

**DISPLAY LATCH** — Keeps the display closed.

**SPEAKERS** — To adjust the volume of the integrated speakers, press the volume control buttons, mute button, or volume-control keyboard shortcuts. For more information, see page 43.



**TOUCH PAD BUTTONS** — Provide the functionality of a mouse. For more information, see page 43.

**TOUCH PAD** — Provides the functionality of a mouse. For more information, see page 43.

#### **KEYBOARD STATUS LIGHTS**





The green lights located above the keyboard indicate the following:

-  Turns on when the numeric keypad is enabled.
-  Turns on when the uppercase letter function is enabled.
-  Turns on when the scroll lock function is enabled.

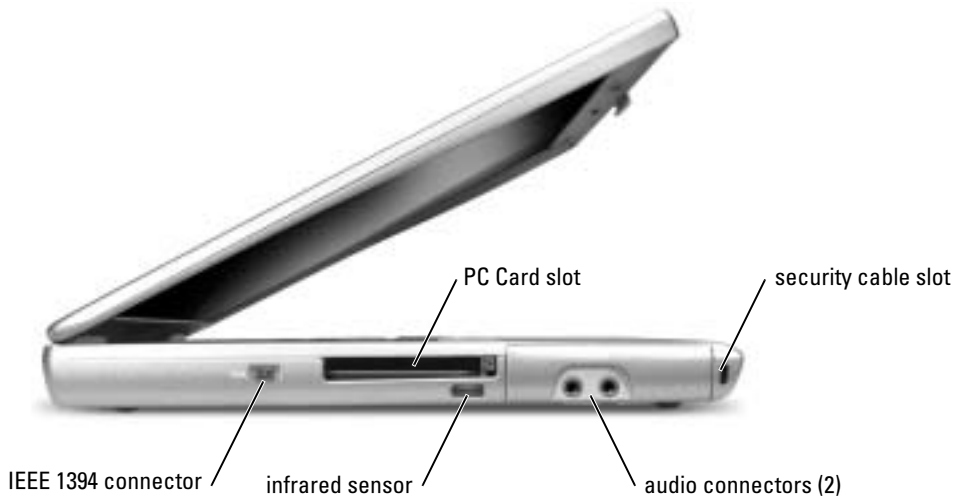
## Left View



 **NOTE:** The computer turns on the fan when the computer gets hot. Fan noise is normal and does not indicate a problem with the fan or the computer.

 **CAUTION:** Do not store your computer in a low-airflow environment, such as a closed briefcase, while it is running. Restricting the airflow can damage the computer or cause a fire.

**PC CARD SLOT** — Supports one PC Card, such as a modem or network adapter. For more information, see the *Dell Inspiron Help* file. To access the help file, see page 9.

**INFRARED SENSOR** — Lets you transfer files from your computer to another infrared-compatible device without using cable connections.

**IEEE 1394 CONNECTOR** — Use to attach devices supporting IEEE 1394 high-speed transfer rates, such as some digital video cameras.

When you receive your computer, the sensor is disabled. You can use the system setup program to enable the sensor. For information on transferring data, see the Help and Support Center or the documentation that came with your infrared-compatible device.



## AUDIO CONNECTORS



Attach a microphone to the  connector.

Attach headphones or speakers to the  connector.

**SECURITY CABLE SLOT** — Lets you attach a commercially available antitheft device to the computer. For more information, see the instructions included with the device.

 **NOTICE:** Before you buy an antitheft device, ensure that it will work with the security cable slot.



## Right View

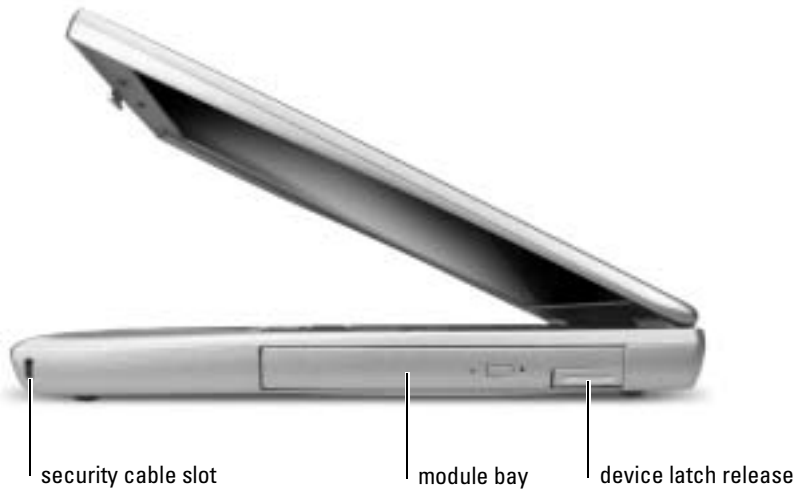

**SECURITY CABLE SLOT** — Lets you attach a commercially available antitheft device to the computer. For more information, see the instructions included with the device.

**NOTICE:** Before you buy an antitheft device, ensure that it will work with the security cable slot.



**MODULE BAY** — You can install devices such as an optical drive or a Dell TravelLite™ module in the module bay. For more information, see page 41.

**DEVICE LATCH RELEASE** — Releases the module bay device. See page 41 for instructions.

## Back View

 **CAUTION:** Do not store your computer in a low-airflow environment, such as a closed briefcase, while it is running. Restricting the airflow can damage the computer or cause a fire.

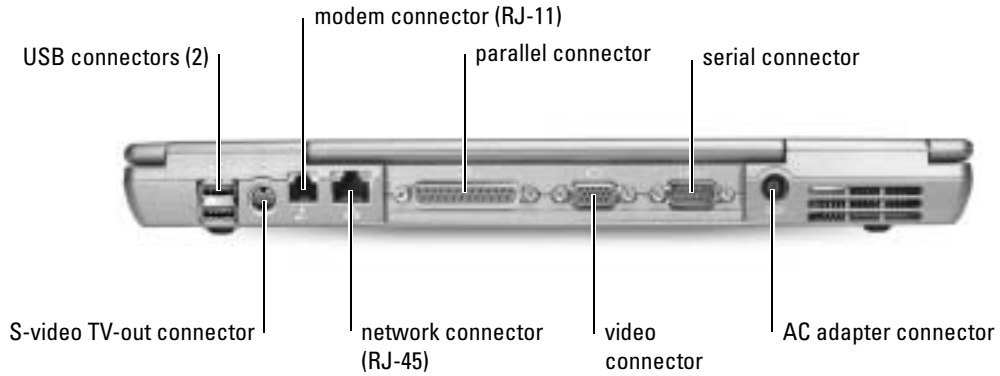

## USB CONNECTORS

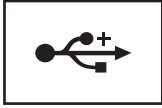

Connect USB devices, such as a mouse, keyboard, or printer. You can also connect the optional floppy drive directly to a USB connector using the optional floppy-drive cable.



## S-VIDEO TV-OUT CONNECTOR



Connects your computer to a TV. For more information, see page 56.

## MODEM CONNECTOR (RJ-11)



Connect the telephone line to the modem connector. For information on using the modem, see the online modem documentation supplied with your computer. See page 10.

### NETWORK CONNECTOR (RJ-45)

 **NOTICE:** The network connector is slightly larger than the modem connector. To avoid damaging the computer, do not plug a telephone line in to the network connector.

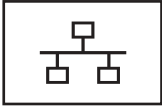

Connects the computer to a network. The green and yellow lights next to the connector indicate activity for both wired and wireless network communications.

For information on using the network adapter, see the device user's guide supplied with your computer. See page 10.

### PARALLEL CONNECTOR



Connects a parallel device, such as a printer.

### VIDEO CONNECTOR



Connects an external monitor. For more information, see the *Dell Inspiron Help* file. To access the help file, see page 9.

### SERIAL CONNECTOR







Connects serial devices, such as a mouse or handheld device.

**AC ADAPTER CONNECTOR** — Attach an AC adapter to the computer.



The AC adapter converts AC power to the DC power required by the computer. You can connect the AC adapter with your computer turned either on or off.

-  **CAUTION:** The AC adapter works with electrical outlets worldwide. However, power connectors and power strips vary among countries. Using an incompatible cable or improperly connecting the cable to the power strip or electrical outlet may cause fire or equipment damage.
-  **NOTICE:** When you disconnect the AC adapter cable from the computer, grasp the connector, not the cable itself, and pull firmly but gently to avoid damaging the cable.
-  **NOTE:** The computer turns on the fan when the computer gets hot. Fan noise is normal and does not indicate a problem with the fan or the computer.
-  **CAUTION:** Do not store your computer in a low-airflow environment, such as a closed briefcase, while it is running. Restricting the airflow can damage the computer or cause a fire.

## Bottom View

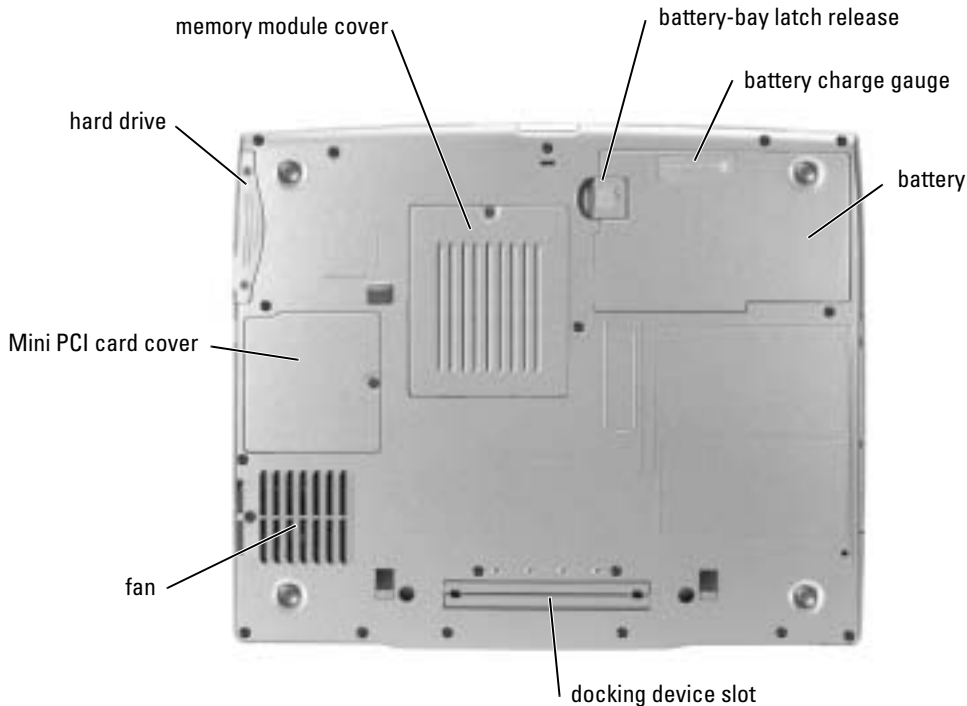

**MEMORY MODULE COVER** — Covers the compartment that contains the memory module(s). See page 89.

**BATTERY-BAY LATCH RELEASE** — Releases the battery. See page 36 for instructions.

**BATTERY CHARGE GAUGE** — Provides information on the battery charge. See page 35.

**BATTERY** — When a battery is installed, you can use the computer without connecting the computer to an electrical outlet. See page 36.

**DOCKING DEVICE SLOT** — Lets you attach your computer to a docking device. See the documentation that came with your docking device for additional information.

**FAN** — The computer uses an internal fan to create airflow through the vents, which prevents the computer from overheating.

 **NOTE:** The computer turns on the fan when the computer gets hot. Fan noise is normal and does not indicate a problem with the fan or the computer.

 **CAUTION:** Do not store your computer in a low-airflow environment, such as a closed briefcase, while it is running. Restricting the airflow can damage the computer or cause a fire.

**MINI PCI CARD COVER** — Covers the compartment that contains the Mini PCI card. See page 91.

**HARD DRIVE** — Stores software and data.





# Setting Up Your Computer

## Connecting to the Internet

 **NOTE:** ISPs and ISP offerings vary by country.

To connect to the Internet, you need a modem or network connection and an Internet service provider (ISP), such as AOL or MSN. Your ISP will offer one or more of the following Internet connection options:

- Dial-up connections that provide Internet access through a telephone line. Dial-up connections are considerably slower than DSL and cable modem connections.
- DSL connections that provide high-speed Internet access through your existing telephone line. With a DSL connection, you can access the Internet and use your telephone on the same line simultaneously.
- Cable modem connections that provide high-speed Internet access through your local cable TV line.

If you are using a dial-up connection, connect a telephone line to the modem connector on your computer and to the telephone wall jack before you set up your Internet connection. If you are using a DSL or cable modem connection, contact your ISP for setup instructions.

### Setting Up Your Internet Connection

To set up an AOL or MSN connection:

- 1 Save and close any open files, and exit any open programs.
- 2 Double-click the **MSN Explorer** or **AOL** icon on the Microsoft® Windows® desktop.
- 3 Follow the instructions on the screen to complete the setup.

If you do not have an **MSN Explorer** or **AOL** icon on your desktop or if you want to set up an Internet connection with a different ISP:

- 1 Save and close any open files, and exit any open programs.
- 2 Click the **Start** button and click **Internet Explorer**.  
The **New Connection Wizard** appears.
- 3 Click **Connect to the Internet**.

- 4 In the next window, click the appropriate option:
  - If you do not have an ISP and want to select one, click **Choose from a list of Internet service providers (ISPs)**.
  - If you have already obtained setup information from your ISP but you did not receive a setup CD, click **Set up my connection manually**.
  - If you have a CD, click **Use the CD I got from an ISP**.

- 5 Click **Next**.

If you selected **Set up my connection manually**, continue to step 6. Otherwise, follow the instructions on the screen to complete the setup.

 **NOTE:** If you do not know which type of connection to select, contact your ISP.

- 6 Click the appropriate option under **How do you want to connect to the Internet?**, and then click **Next**.

- 7 Use the setup information provided by your ISP to complete the setup.

If you are having problems connecting to the Internet, see "Internet, Modem, and E-Mail Problems." If you cannot connect to the Internet but have successfully connected in the past, the ISP might have a service outage. Contact your ISP to check the service status, or try connecting again later.

## Modem and Internet Connection Problems

 **NOTICE:** Connect the modem to an analog telephone wall jack only. Connecting the modem to a digital telephone network damages the modem.

 **NOTICE:** Modem and network connectors look similar. Do not plug a telephone line into the network connector.

 **NOTE:** If you can connect to your Internet service provider (ISP), your modem is functioning properly. If you are sure that your modem is working properly and you still experience problems, contact your ISP.

**CHECK THE TELEPHONE WALL JACK** — Disconnect the telephone line from the modem and connect it to a telephone. Listen for a dial tone. Ensure that you have touchtone telephone service. Try connecting the modem to a different telephone wall jack.

Slow connection speeds can be caused by telephone noise as well as by telephone line or network conditions. Contact your telephone company or network administrator for more information.

**CONNECT THE MODEM DIRECTLY TO THE TELEPHONE WALL JACK** — If you have other telephone devices sharing the line, such as an answering machine, fax machine, surge protector, or line splitter, then bypass them and use the telephone line to connect the modem directly to the telephone wall jack.

**CHECK THE CONNECTION** — Verify that the telephone line is connected to the modem.

**CHECK THE TELEPHONE LINE** — Try using a different telephone line. If you are using a line that is 3 m (10 ft) or more in length, try a shorter one.

**IRREGULAR DIAL TONE** — If you have voice mail service, you might hear an irregular dial tone when you have messages. Contact your telephone company for instructions on restoring a dial tone.

**TURN OFF CALL WAITING (CATCH-PHONE)** — See your telephone directory for instructions on deactivating this feature. Then adjust the dial-up networking connection properties.

- 1 Click the **Start** button and click **Control Panel**.
- 2 Click **Printers and Other Hardware**, click **Phone and Modem Options**, click the **Dialing Rules** tab, and then click **Edit...**
- 3 In the **Edit Location** window, ensure that **To disable call waiting, dial:** is checked, and then select the proper code as listed in your telephone directory.
- 4 Click **Apply** and click **OK**.
- 5 Close the **Phone and Modems Options** window.
- 6 Close the **Control Panel** window.

#### **VERIFY THAT THE MODEM IS COMMUNICATING WITH WINDOWS**

- 1 Click the **Start** button and click **Control Panel**.
- 2 Click **Printers and Other Hardware** and click **Phone and Modem Options**.
- 3 Click the **Modems** tab.
- 4 Click the COM port for your modem.
- 5 Click **Properties**, click the **Diagnostics** tab, and then click **Query Modem** to verify that the modem is communicating with Windows.

If all commands receive responses, the modem is operating properly.

## E-Mail Problems

**ENSURE THAT YOU ARE CONNECTED TO THE INTERNET** — With the Outlook Express e-mail program open, click **File**. If **Work Offline** has a check mark next to it, click the check mark to remove it and connect to the Internet.

## Setting Up a Printer

 **NOTICE:** Complete the operating system setup before you connect a printer to the computer.

See the documentation that came with the printer for setup information, including how to:

- Obtain and install updated drivers.
- Connect the printer to the computer.
- Load paper and install the toner or ink cartridge.
- Contact the printer manufacturer for technical assistance.

### Printer Cable

Your printer connects to your computer with either a USB cable or a parallel cable. Your printer may not come with a printer cable, so if you purchase a cable separately, ensure that it is compatible with your printer. If you purchased a printer cable at the same time you purchased your computer, the cable may arrive in the computer box.

### Connecting a Parallel Printer

- 1 Complete the operating system setup, if you have not already done so.
- 2 Turn off the computer.

 **NOTICE:** For best results, use a 3-m (10-ft) or shorter parallel cable.

- 3 Attach the parallel printer cable to the parallel connector on the computer and tighten the two screws. Attach the cable to the connector on the printer and snap the two clips into the two notches.

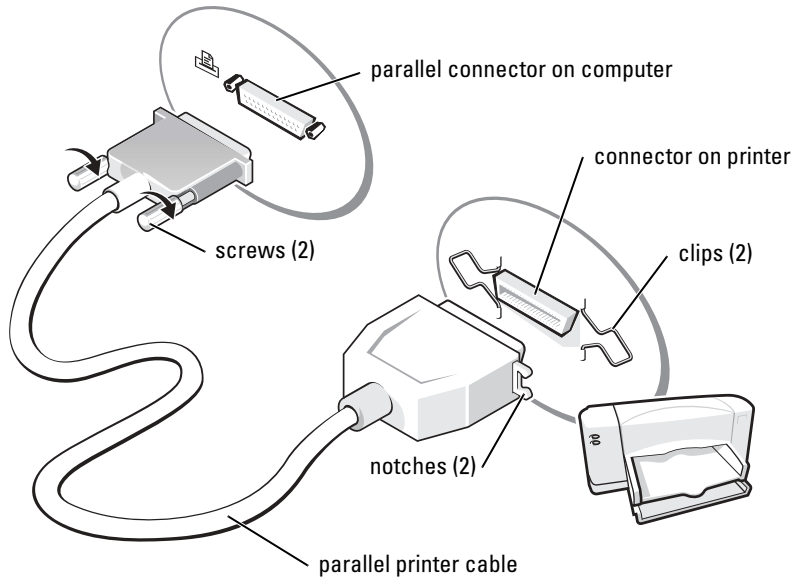

- 4 Turn on the printer and then turn on the computer. If the **Add New Hardware Wizard** window appears, click **Cancel**.
- 5 Install the printer driver if necessary. See the documentation that came with your printer.

### Connecting a USB Printer

 **NOTE:** You can connect USB devices while the computer is turned on.

- 1 Complete the operating system setup if you have not already done so.
- 2 Install the printer driver if necessary. See the documentation that came with your printer.

- 3 Attach the USB printer cable to the USB connectors on the computer and the printer. The USB connectors fit only one way.

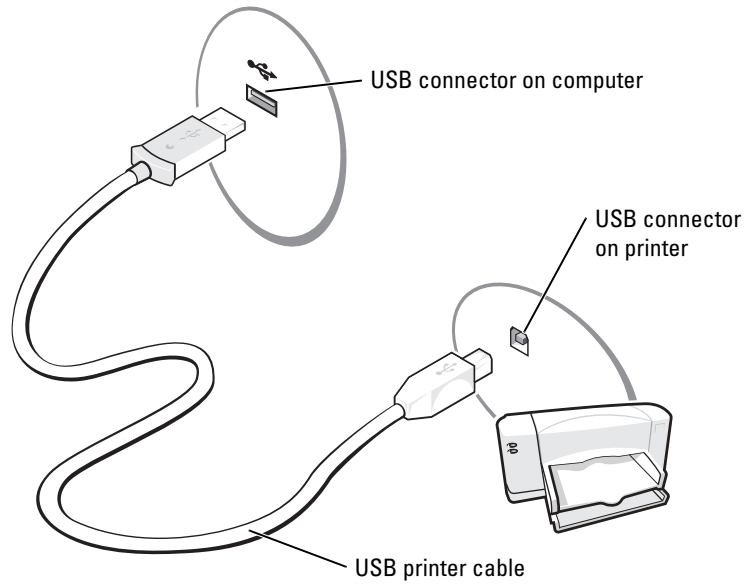

## Printer Problems

**CHECK THE PRINTER CABLE CONNECTIONS** — Ensure that the printer cable is properly connected to the computer (see page 28).

**TEST THE ELECTRICAL OUTLET** — Ensure that the electrical outlet is working by testing it with another device, such as a lamp.

**ENSURE THAT THE PRINTER IS TURNED ON** — See the documentation supplied with the printer.

### VERIFY THAT WINDOWS® RECOGNIZES THE PRINTER

- 1 Click the **Start** button.
- 2 Click **Control Panel**.
- 3 Click **Printers and Other Hardware**.
- 4 Click **View installed printers or fax printers**. If the printer model is listed, right-click the printer icon.
- 5 Click **Properties**, and then click the **Ports** tab. Ensure that the **Print to the following port(s)**: setting is **LPT1 (Printer Port)**.

**REINSTALL THE PRINTER DRIVER** — See page 78.

## Power Protection Devices

Several devices are available to protect against power fluctuations and failures:

- Surge protectors
- Line conditioners
- Uninterruptible power supplies (UPS)

### Surge Protectors

Surge protectors and power strips equipped with surge protection help to prevent damage to your computer from voltage spikes that can occur during electrical storms or following power interruptions. The level of protection is usually commensurate with the cost of the surge protector. Some surge protector manufacturers include warranty coverage for certain types of damage. Carefully read the device warranty when choosing a surge protector. A device with a higher joule rating offers more protection. Compare joule ratings to determine the relative effectiveness of different devices.

 **NOTICE:** Most surge protectors do not protect against power fluctuations or power interruptions caused by nearby lightning strikes. When lightning occurs in your area, disconnect the telephone line from the telephone wall jack and disconnect your computer from the electrical outlet.

Many surge protectors have a telephone jack for modem protection. See the surge protector documentation for modem connection instructions.

 **NOTICE:** Not all surge protectors offer network adapter protection. Disconnect the network cable from the network wall jack during electrical storms.

### Line Conditioners

 **NOTICE:** Line conditioners do not protect against power interruptions.

Line conditioners are designed to maintain AC voltage at a fairly constant level.

## Uninterruptible Power Supplies

 **NOTICE:** Loss of power while data is being saved to the hard drive may result in data loss or file damage.

 **NOTE:** To ensure maximum battery operating time, connect only your computer to a UPS. Connect other devices, such as a printer, to a separate power strip that provides surge protection.

A UPS protects against power fluctuations and interruptions. UPS devices contain a battery that provides temporary power to connected devices when AC power is interrupted. The battery charges while AC power is available. See the UPS manufacturer documentation for information on battery operating time and to ensure that the device is approved by Underwriters Laboratories (UL).

## Turning Off Your Computer

 **NOTICE:** To avoid losing data, turn off your computer by performing a Microsoft® Windows® operating system shutdown, as described next, rather than by pressing the power button.

 **NOTE:** As an alternative to turning off your computer, you can set your computer to enter standby or hibernate mode.

- 1 Save and close any open files, exit any open programs, click the **Start** button, and then click **Turn Off Computer**.
- 2 In the **Turn off computer** window, click **Turn off**.

The computer turns off after the shutdown process finishes.



# Using a Battery

## Battery Performance

 **CAUTION:** Before you begin any of the procedures in this section, follow the safety instructions in the *Product Information Guide*.

For optimal computer performance and to help preserve BIOS settings, operate your Dell™ portable computer with the main battery installed at all times. Use a battery to run the computer when it is not connected to an electrical outlet. One battery is supplied as standard equipment in the battery bay.

 **NOTE:** Battery operating time (the time a battery can hold a charge) decreases over time. Depending on how often the battery is used and the conditions under which it is used, you may need to purchase a new battery during the life of your computer.

Battery operating time varies depending on operating conditions. You can install an optional second battery in the module bay to significantly increase operating time. For more information about the second battery, see page 41.

Operating time is significantly reduced when you perform operations including, but not limited to, the following:

- Using DVD, DVD-R, and CD-RW drives
- Using wireless communications devices, PC Cards, or USB devices
- Using high-brightness display settings, 3D screen savers, or other power-intensive programs such as 3D games
- Running the computer in maximum performance mode

 **NOTE:** It is recommended that you connect your computer to an electrical outlet when writing to a CD.

You can check the battery charge before you insert the battery into the computer. You can also set power management options to alert you when the battery charge is low.

 **CAUTION:** Using an incompatible battery may increase the risk of fire or explosion. Replace the battery only with a compatible battery purchased from Dell. The lithium-ion battery is designed to work with your Dell computer. Do not use a battery from other computers with your computer.

 **CAUTION:** Do not dispose of batteries with household waste. When your battery no longer holds a charge, call your local waste disposal or environmental agency for advice on disposing of a lithium-ion battery. See "Battery Disposal."

 **CAUTION: Misuse of the battery may increase the risk of fire or chemical burn. Do not puncture, incinerate, disassemble, or expose the battery to temperatures above 65°C (149°F). Keep the battery away from children. Handle damaged or leaking batteries with extreme care. Damaged batteries may leak and cause personal injury or equipment damage.**

## Checking the Battery Charge

The Dell QuickSet Battery Meter, the Microsoft® Windows® **Power Meter** window and  icon, the battery charge gauge, and the low-battery warning provide information on the battery charge.

For more information about checking the charge on the second battery, see page 41.

### Dell™ QuickSet Battery Meter

If Dell QuickSet is installed, press <Fn><F3> to display the QuickSet Battery Meter.

The **Battery Meter** window displays status, charge level, and charge completion time for the battery in your computer.

In addition, when your computer is connected to a docking device (docked), the **Battery Meter** window includes a **Dock Battery** tab, which displays the charge level and current status of the docking device battery.

The following icons appear in the **Battery Meter** window:



The computer or docking device is running on battery power.



The computer is connected to AC power and the battery is charging.





The computer is connected to AC power and the battery is fully charged.

---

For more information about QuickSet, right-click the  icon in the taskbar, and click **Help**.

## Microsoft® Windows® Power Meter

The Windows Power Meter indicates the remaining battery charge. To check the Power Meter, double-click the  icon on the taskbar. For more information about the **Power Meter** tab, see "Power Management" in the *Dell Inspiron Help* file. To access the help file, see page 9.

If the computer is connected to an electrical outlet, a  icon appears.

## Charge Gauge

Before you insert a battery, press the status button on the battery charge gauge to illuminate the charge-level lights. Each light represents approximately 20 percent of the total battery charge. For example, if the battery has 80 percent of its charge remaining, four of the lights are on. If no lights appear, the battery has no charge.

## Low-Battery Warning



**NOTICE:** To avoid losing or corrupting data, save your work immediately after a low-battery warning. Then connect the computer to an electrical outlet, or install a second battery in the module bay. If the battery runs completely out of power, hibernate mode begins automatically.

A low-battery warning occurs when the battery charge is approximately 90 percent depleted. The computer beeps once, indicating that minimal battery operating time remains. During that time, the speaker beeps periodically. If two batteries are installed, the low-battery warning means that the combined charge of both batteries is approximately 90 percent depleted. The computer enters hibernate mode when the battery charge is at a critically low level. For more information about low-battery alarms and to access "Power Management," see the *Dell Inspiron Help* file. To access the help file, see page 9.

## Charging the Battery



**NOTE:** The AC adapter charges a completely discharged battery in approximately 1 hour with the computer turned off. Charge time is longer with the computer turned on. You can leave the battery in the computer as long as you like. The battery's internal circuitry prevents the battery from overcharging.

When you connect the computer to an electrical outlet or install a battery while the computer is connected to an electrical outlet, the computer checks the battery charge and temperature. If necessary, the AC adapter then charges the battery and maintains the battery charge.

If the battery is hot from being used in your computer or being in a hot environment, the battery may not charge when you connect the computer to an electrical outlet.

The battery is too hot to start charging if the  light flashes alternately green and orange. Disconnect the computer from the electrical outlet and allow the computer and the battery to cool to room temperature. Then connect the computer to an electrical outlet to continue charging the battery.

For more information about resolving problems with a battery, and to access "Power Management", see the *Dell Inspiron Help* file. To access the help file, see page 9.

## Removing a Battery

**⚠ CAUTION:** Before performing these procedures, disconnect the modem from the telephone wall jack.

For information about removing the second battery, see "Using the Module Bay" on page 41.

**🔄 NOTICE:** If you choose to replace the battery with the computer in standby mode, you have up to 30 seconds to complete the battery replacement before the computer shuts down and loses any unsaved data.

- 1 Ensure that the computer is turned off, suspended in a power management mode, or connected to an electrical outlet.
- 2 If the computer is connected to a docking device (docked), undock it. See the documentation that came with your docking device for instructions.
- 3 Slide and hold the battery-bay latch release on the bottom of the computer, and then remove the battery from the bay.



## Installing a Battery

**⚠ CAUTION:** Using an incompatible battery may increase the risk of fire or explosion. Replace the battery only with a compatible battery purchased from Dell. The lithium-ion battery is designed to work with your Dell computer. Do not use a battery from other computers with your computer.

Slide the battery into the bay until the latch release clicks.

For information about installing the second battery, see page 41.

## Removing and Installing a Reserve Battery

- 1 Remove the battery.
- 2 Remove the reserve battery cover.



- 3 Slide the reserve battery toward the connector, and pull the battery out of its compartment.
- 4 Disconnect the reserve battery cable from the connector.

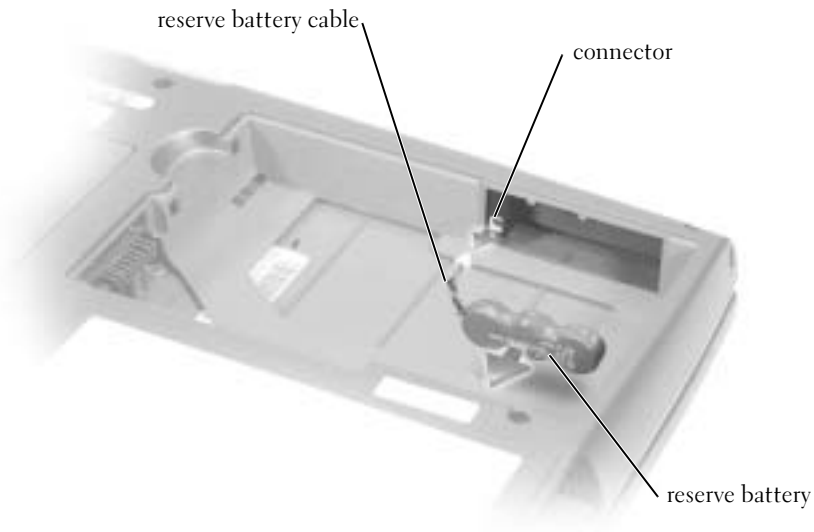

- 5 Connect the reserve battery cable to the connector in the reserve battery compartment.
- 6 Place the reserve battery in the compartment, and replace the reserve battery cover.



## Storing a Battery

Remove the battery when you store your computer for an extended period of time. A battery discharges during prolonged storage. After a long storage period, recharge the battery fully before you use it.

## Power Problems

 **NOTE:** For information on standby mode, see the *Dell Inspiron Help* file. To access the help file, see page 9.

**CHECK THE POWER LIGHT** — When the power light is lit or blinking, the computer has power. If the power light is blinking, the computer is in standby mode—press the power button to exit standby mode. If the light is off, press the power button to turn on the computer.

**CHARGE THE BATTERY** — The battery charge may be depleted.

- 1 Reinstall the battery.
- 2 Use the AC adapter to connect the computer to an electrical outlet.
- 3 Turn on the computer.

**CHECK THE BATTERY STATUS LIGHT** — If the battery status light flashes orange or is a steady orange the battery charge is low or depleted. Connect the computer to an electrical outlet.

If the battery status light flashes green and orange, the battery is too hot to charge. Turn off the computer (see page 32), disconnect the computer from the electrical outlet, and then let the battery and computer cool to room temperature.

If the battery status light rapidly flashes orange, the battery may be defective. Contact Dell (see page 112).

**TEST THE ELECTRICAL OUTLET** — Ensure that the electrical outlet is working by testing it with another device, such as a lamp.

**CHECK THE AC ADAPTER** — Check the AC adapter cable connections. If the AC adapter has a light, ensure that the light is on.

**CONNECT THE COMPUTER DIRECTLY TO AN ELECTRICAL OUTLET** — Bypass power protection devices, power strips, and the extension cable to verify that the computer turns on.

**ELIMINATE POSSIBLE INTERFERENCE** — Turn off nearby fans, fluorescent lights, halogen lamps, or other appliances.

**ADJUST THE POWER PROPERTIES** — See the *Dell Inspiron Help* file or search for the keyword *standby* in the Help and Support Center. To access the help file, see page 9.

**RESEAT THE MEMORY MODULES** — If the computer power light turns on but the display remains blank, reseat the memory modules.





# Using the Module Bay

## About the Module Bay

 **CAUTION:** Before you begin any of the procedures in this section, follow the safety instructions in the *Product Information Guide*.

You can install devices such as a floppy drive, CD drive, CD-RW drive, DVD drive, CD-RW/DVD drive, DVD+RW, second battery, or second hard drive in the module bay.

## Removing and Installing Devices While the Computer Is Turned Off

 **NOTE:** You can remove and install devices while the computer is running and connected to a docking device (docked).

 **NOTICE:** To prevent damage to devices, store them in a safe, dry place when they are not installed in the computer. Avoid pressing down on them or placing heavy objects on top of them.

- 1 Press the device latch release.
- 2 Pull the device out of the module bay.



- 3 Push the new device into the bay until it clicks.

## Removing and Installing Devices While the Computer Is Running

- 1 Before ejecting the device, double-click the **Safely Remove Hardware** icon on the taskbar, click the device you want to eject, and click **Stop**.

**NOTICE:** To prevent damage to devices, store them in a safe, dry place when they are not installed in the computer. Avoid pressing down on them or placing heavy objects on top of them.

- 2 Press the device latch release.



- 3 Pull the device out of the module bay.



- 4 Push the new device into the bay until it clicks.  
The operating system automatically recognizes the device.
- 5 If necessary, enter your password to unlock your computer.

## Using the Keyboard and Touch Pad

### Numeric Keypad



**NOTE:** When you connect an external keyboard or keypad to the computer, the keypad is disabled.

The numeric keypad functions like the numeric keypad on an external keyboard. Each key on the keypad has multiple functions. The keypad numbers and symbols are marked in blue on the right of the keypad keys. To type a number or symbol, enable the keypad, hold down <Fn> and press the desired key.

- To enable the keypad, press <Num Lk>. The  light indicates that the keypad is active.
- To disable the keypad, press <Num Lk> again.

# Keyboard Shortcuts

## System Functions

<Ctrl><Shift><Esc>	Opens the <b>Windows Task Manager</b> window
<Num Lk>	Enables and disables the numeric keypad (on an external keyboard only)
<Fn><Num Lk>	Enables and disables the scroll lock

## Battery

<Fn><F3>	Displays the Dell™ QuickSet <b>Battery Meter</b> .
----------	--

## CD or DVD Tray

<Fn><F10>	Ejects the tray out of the drive.
-----------	-----------------------------------

## Display Functions

<Fn><F8>	Switches the video image to the next display in the following sequence: the integrated display only, the integrated display and an external CRT monitor simultaneously, an external CRT monitor only, the integrated display and an external DVI monitor simultaneously, and an external DVI monitor only.
<Fn> and up-arrow key	Increases brightness on the integrated display only (not on an external monitor)
<Fn> and down-arrow key	Decreases brightness on the integrated display only (not on an external monitor)

## Radios (Including Wireless Networking and Bluetooth® Wireless Technology)

<Fn><F2>	Enables and disables radios, including wireless networking and Bluetooth wireless technology.
----------	---

## Power Management

<Fn><Esc>	Activates the power management mode of your choice. You can program this keyboard shortcut on the <b>Advanced</b> tab in the <b>Power Options Properties</b> window
-----------	---

## Speaker Functions

If no sound comes from the speakers, press <Fn><End> and adjust the volume.

---

<Fn><Page Up>	Increases the volume of the integrated speakers and external speakers, if attached
<Fn><Page Dn>	Decreases the volume of the integrated speakers and external speakers, if attached
<Fn><End>	Enables and disables the integrated speakers and external speakers, if attached

---

## Microsoft® Windows® Logo Key Functions

---

Windows logo key and <m>	Minimizes all open windows
Windows logo key and <Shift><m>	Maximizes all windows
Windows logo key and <e>	Runs Windows Explorer
Windows logo key and <r>	Opens the <b>R</b> un dialog box
Windows logo key and <f>	Opens the <b>S</b> earch <b>R</b> esults dialog box
Windows logo key and <Ctrl><f>	Opens the <b>S</b> earch <b>R</b> esults- <b>C</b> omputer dialog box (if the computer is connected to a network)
Windows logo key and <Pause>	Opens the <b>S</b> ystem <b>P</b> roperties dialog box

---

To adjust keyboard operation, such as the character repeat rate, open the Control Panel, and click **Printers and Other Hardware**.

## Touch Pad

The touch pad detects the pressure and movement of your finger to allow you to move the cursor on the display. Use the touch pad and touch pad buttons as you would use a mouse.

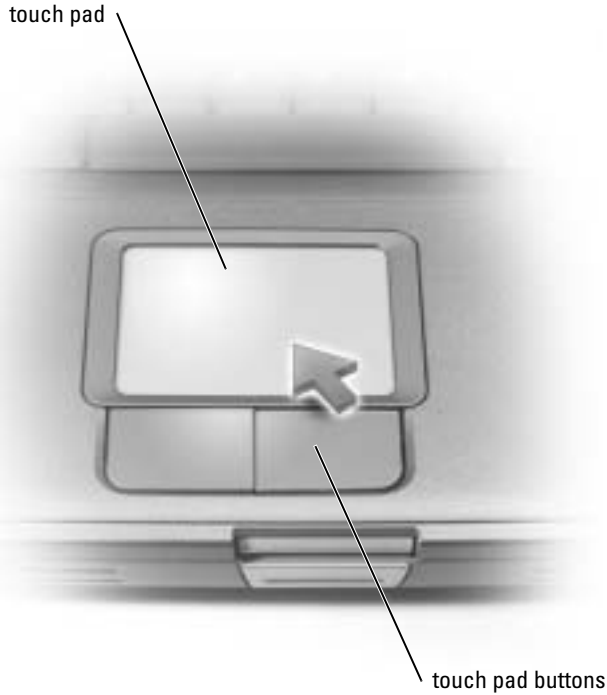

- To move the cursor, lightly slide your finger over the touch pad.
- To select an object, lightly tap once on the surface of the touch pad or use your thumb to press the left touch-pad button.
- To select and move (or drag) an object, position the cursor on the object and tap down-up-down on the touch pad. On the second down motion, leave your finger on the touch pad and move the selected object by sliding your finger across the surface.
- To double-click an object, position the cursor on the object and then tap twice on the touch pad, or use your thumb to press the left touch-pad button twice.

## Customizing the Touch Pad

You can disable the touch pad or adjust its settings by using the **Mouse Properties** window.

- 1 Open the Control Panel, click **Printers and Other Hardware**, and then click **Mouse**.
- 2 On the **Mouse Properties** window:
  - Click the **Device Select** tab to disable the touch pad.
  - Click the **Pointer** tab to adjust touch pad settings.
- 3 Select the desired settings and click **Apply**.
- 4 Click **OK** to save the settings and close the window.

## Touch Pad or Mouse Problems

### CHECK THE TOUCH PAD SETTINGS

- 1 Click the **Start** button, click **Control Panel**, and then click **Printers and Other Hardware**.
- 2 Click **Mouse**.
- 3 Try adjusting the settings.

### CHECK THE MOUSE CABLE

Shut down the computer (see page 32). Disconnect the mouse cable and check it for damage. For PS/2 cables, check the cable connector for bent or broken pins. Firmly reconnect the cable.

If you are using a mouse extension cable, disconnect it and connect the mouse directly to the computer.

### TO VERIFY THAT THE PROBLEM IS WITH THE MOUSE, CHECK THE TOUCH PAD

- 1 Turn off the computer.
- 2 Disconnect the mouse.
- 3 Turn on the computer.
- 4 At the Windows desktop, use the touch pad to move the cursor around, select an icon, and open it.

If the touch pad operates correctly, the mouse may be defective.

**REINSTALL THE TOUCH PAD DRIVER** — See page 78.

## External Keyboard Problems

 **NOTE:** When you attach an external keyboard, the integrated keyboard remains fully functional.

**CHECK THE KEYBOARD CABLE** — Shut down the computer (see page 32). Disconnect the keyboard cable and check it for damage. For PS/2 cables, check the cable connector for bent or broken pins. Firmly reconnect the cable.

If you are using a keyboard extension cable, disconnect it and connect the keyboard directly to the computer.

### CHECK THE EXTERNAL KEYBOARD

- 1 Turn off the computer, wait 1 minute, and turn it on again.
- 2 Verify that the numbers, capitals, and scroll lock lights on the keyboard blink during the boot routine.
- 3 From the Windows® desktop, click the **Start** button, point to **Programs**, point to **Accessories**, and click **Notepad**.
- 4 Type some characters on the external keyboard and verify that they appear on the display.

If you cannot verify these steps, you may have a defective external keyboard.

### TO VERIFY THAT THE PROBLEM IS WITH THE EXTERNAL KEYBOARD, CHECK THE INTEGRATED KEYBOARD

- 1 Turn off the computer.
- 2 Disconnect the external keyboard.
- 3 Turn on the computer.
- 4 From the Windows desktop, click the **Start** button, point to **Programs**, point to **Accessories**, and click **Notepad**.
- 5 Type some characters on the external keyboard and verify that they appear on the display.

If the characters appear now but did not with the external keyboard, you may have a defective external keyboard. Contact Dell (see page 112).

## Unexpected Characters

**DISABLE THE NUMERIC KEYPAD** — Press <Num Lk> to disable the numeric keypad if numbers are displayed instead of letters. Verify that the numbers lock light is not lit.



# Using CDs, DVDs, and other Multimedia

## Using CDs and DVDs

For information about using CDs and DVDs in your computer, see the *Dell™ Inspiron™ Help* file. To access the help file, see page 9.

## Drive Problems

 **NOTE:** For information on saving files to a floppy disk, see the *Dell Inspiron Help* file. To access the help file, see page 9.

### If you cannot save a file to a floppy disk drive

**ENSURE THAT WINDOWS® RECOGNIZES THE DRIVE** — Click the **Start** button and click **My Computer**. If the drive is not listed, perform a full scan with your antivirus software to check for and remove viruses. Viruses can sometimes prevent Windows from recognizing the drive. Insert a bootable disk and restart the computer. Verify that the  light is blinking, indicating normal operation.

**ENSURE THAT THE DISK IS NOT WRITE-PROTECTED** — You cannot save data to a write-protected disk. See the following figure.

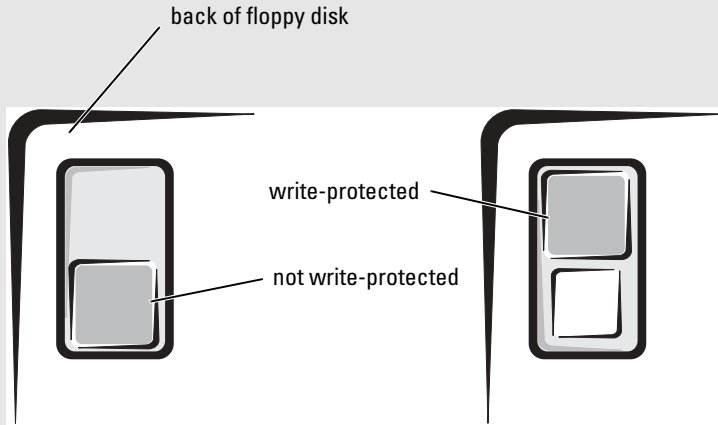

**TRY ANOTHER FLOPPY DISK** — Insert another disk to eliminate the possibility that the original disk is defective.

#### **REINSTALL THE DRIVE**

- 1 Save and close any open files, exit any open programs, and shut down the computer.
- 2 Remove the drive. See page 41 for instructions.
- 3 Reinstall the drive.
- 4 Turn on the computer.

**CLEAN THE DRIVE** — See "Cleaning Your Computer" in the *Dell Inspiron Help* file for instructions. To access the help file, see page 9.

### **If you cannot play a CD, CD-RW, or DVD**

 **NOTE:** Because of different worldwide file types, not all DVD titles work in all DVD drives.

High-speed CD drive vibration is normal and may cause noise. This noise does not indicate a defect with the drive or the CD.

**ENSURE THAT WINDOWS® RECOGNIZES THE DRIVE** — Click the **Start** button and click **My Computer**. If the drive is not listed, perform a full scan with your antivirus software to check for and remove viruses. Viruses can sometimes prevent Windows from recognizing the drive. Insert a bootable disk and restart the computer. Verify that the  light is blinking, indicating normal operation.

**TRY ANOTHER DISC** — Insert another disc to eliminate the possibility that the original disc is defective.

**ADJUST THE WINDOWS VOLUME CONTROL** — Double-click the speaker icon in the lower-right corner of your screen. Ensure that the volume is turned up and that the sound is not muted.

**IDENTIFY THE DISC THAT IS NOT PLAYING** — If you have one CD, CD-RW, or DVD in the fixed drive device and one in the module bay device:

- 1 Click the **Start** button and click **My Computer**.
- 2 Double-click the drive letter of the device that you are verifying.

#### **REINSTALL THE DRIVE**

- 1 Save and close any open files, exit any open programs, and shut down the computer.
- 2 Remove the drive. See page 41 for instructions.
- 3 Reinstall the drive.
- 4 Turn on the computer.

**CLEAN THE DRIVE OR DISC** — See "Cleaning Your Computer" in the *Dell Inspiron Help* file for instructions. To access the help file, see page 9.

### **If you cannot eject the CD, CD-RW, or DVD drive tray**

- 1 Ensure that the computer is turned off.
- 2 Straighten a paper clip and insert one end into the eject hole at the front of the drive; push firmly until the tray is partially ejected.
- 3 Gently pull out the tray until it stops.

## If you hear an unfamiliar scraping or grinding sound

- Ensure that the sound is not caused by the program that is running.
- Ensure that the disk or disc is inserted properly.

## If the CD-RW drive stops writing

### **DISABLE STANDBY MODE IN WINDOWS BEFORE WRITING TO A CD-RW —**

Search for the keyword *standby* in the Help and Support Center. To access *the Help and Support Center*, see page 10.

**CHANGE THE WRITE SPEED TO A SLOWER RATE —** See the help files for your CD creation software.

**EXIT ALL OTHER OPEN PROGRAMS —** Exiting all other open programs before writing to the CD-RW may alleviate the problem.

## If you have problems with a hard drive

**ALLOW THE COMPUTER TO COOL BEFORE TURNING IT ON —** A hot hard drive may prevent the operating system from starting. Try allowing the computer to return to room temperature before turning it on.

### **CHECK THE DRIVE FOR ERRORS**

- 1 Click the **Start** button and click **My Computer**.
- 2 Right-click the drive letter (local disk) that you want to scan for errors, and then click **Properties**.
- 3 Click the **Tools** tab.
- 4 Under **Error-checking**, click **Check Now**.
- 5 Click **Start**.

# Sound and Speaker Problems

## If you have a problem with integrated speakers

**ADJUST THE WINDOWS VOLUME CONTROL** — Double-click the speaker icon in the lower-right corner of your screen. Ensure that the volume is turned up and that the sound is not muted. Adjust the volume, bass, or treble controls to eliminate distortion.

**ADJUST THE VOLUME USING KEYBOARD SHORTCUTS** — Press <Fn><End> to disable (mute) or reenable the integrated speakers.

**REINSTALL THE SOUND (AUDIO) DRIVER** — See "Reinstalling Software" on page 79.

## If you have a problem with external speakers

 **NOTE:** The volume control in some MP3 players overrides the Windows volume setting. If you have been listening to MP3 songs, make sure that you did not turn the player volume down or off.

**CHECK THE SPEAKER CABLE CONNECTIONS** — See the setup diagram supplied with the speakers.

**TEST THE ELECTRICAL OUTLET** — Ensure that the electrical outlet is working by testing it with another device, such as a lamp.

**ENSURE THAT THE SPEAKERS ARE TURNED ON** — See the setup diagram supplied with the speakers.

**ADJUST THE WINDOWS VOLUME CONTROL** — Double-click the speaker icon in the lower-right corner of your screen. Ensure that the volume is turned up and that the sound is not muted. Adjust the volume, bass, or treble controls to eliminate distortion.

**TEST THE SPEAKERS** — Plug the speaker audio cable in to the  connector on the computer. Ensure that the headphone volume control is turned up. Play a music CD.

**RUN THE SPEAKER SELF-TEST** — Some speaker systems have a self-test button on the subwoofer. See the speaker documentation for self-test instructions.

**ELIMINATE POSSIBLE INTERFERENCE** — Turn off nearby fans, fluorescent lights, or halogen lamps to check for interference.

**REINSTALL THE SOUND (AUDIO) DRIVER** — See "Reinstalling Software" on page 79.

## Copying CDs and DVDs

 **NOTE:** Ensure that you follow all copyright laws when you create CDs.

This section applies only to computers that have a CD-R, CD-RW, DVD+RW, DVD+R, or DVD/CD-RW combo drive.

The following instructions show how to make an exact copy of a CD or DVD. You can also use Sonic RecordNow for other purposes, including creating CDs from audio files on your computer and creating MP3 CDs. For instructions, see the Sonic RecordNow documentation that came with your computer. Open Sonic RecordNow, click the question mark icon in the upper-right corner of the window, and click **RecordNow Help** or **RecordNow Tutorial**.

### How to Copy a CD or DVD

 **NOTE:** If you have a DVD/CD-RW combo drive and you experience recording problems, check for available software patches at the Sonic support website at [support.sonic.com](http://support.sonic.com).

 **NOTE:** Most commercial DVDs have copyright protection and cannot be copied using Sonic RecordNow.

- 1 Click the **Start** button, point to **All Programs**→ **Sonic**→ **RecordNow!**→ **RecordNow!**.
- 2 Click either the audio tab or the data tab, depending on the kind of CD you are planning to copy.
- 3 Click **Exact Copy**.
- 4 To copy the CD or DVD:
  - *If you have one CD or DVD drive*, ensure that the settings are correct and click **Copy**. The computer reads your source CD or DVD and copies it to a temporary folder on your computer hard drive.

When prompted, insert a blank CD or DVD into the CD or DVD drive and click **OK**.

- *If you have two CD or DVD drives, select the drive into which you have inserted your source CD or DVD and click **Copy**. The computer copies the data on the CD or DVD to the blank CD or DVD.*

Once you have finished copying the source CD or DVD, the CD or DVD that you have created automatically ejects.

## **Using Blank CD-Rs and CD-RWs**

Your CD-RW drive can write to two different types of recording media—CD-Rs and CD-RWs. Use blank CD-Rs to record music or permanently store data files. After creating a CD-R, you cannot write to that CD-R again without changing your method of recording (see the Sonic documentation for more information). Use blank CD-RWs to write to CDs or to erase, rewrite, or update data on CDs.

## **Helpful Tips**

- Use Microsoft® Windows® Explorer to drag and drop files to a CD-R or CD-RW only after you start Sonic RecordNow and open a RecordNow project.
- You must use CD-Rs to burn music CDs that you want to play in regular stereos. CD-RWs do not play in most home or car stereos.
- You cannot create audio DVDs with Sonic RecordNow.
- Music MP3 files can be played only on MP3 players or on computers that have MP3 software installed.
- Do not burn a blank CD-R or CD-RW to its maximum capacity; for example, do not copy a 650-MB file to a 650-MB blank CD. The CD-RW drive needs 1 or 2 MB of the blank CD to finalize the recording.
- Use a blank CD-RW to practice CD recording until you are familiar with CD recording techniques. If you make a mistake, you can erase the data on the CD-RW and try again. You can also use blank CD-RWs to test music file projects before you record the project permanently to a blank CD-R.
- See the Sonic support website at [support.sonic.com](http://support.sonic.com) for additional information.

## Connecting a Television to the Computer

**NOTE:** Video and audio cables for connecting your computer to a television are not included with your computer. Cables may be purchased at most consumer electronics stores.

Your computer has an S-video TV-out connector that enables you to connect the computer to a television. Using a commercially available S-video cable or composite video cable, you can connect the computer to a television in one of two ways:

- S-video (for a television with S-video input)
- Composite video (for a television with only a composite video input; also uses a composite TV-out adapter cable)

**NOTE:** Diagrams for each connection combination appear at the beginning of each subsection to help you determine which method you should use.

The audio connector on the side of the computer enables you to connect the computer to your television or audio device, using a commercially available audio cable.

When you complete the cable connection, see "Enabling the Display Settings for a Television" on page 60 to ensure that the computer recognizes and works properly with the television.

### S-Video Connection

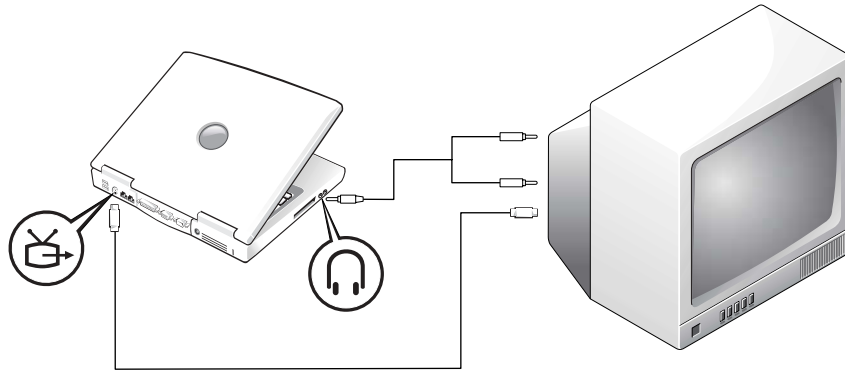



Before you begin, ensure that you have the following cables:

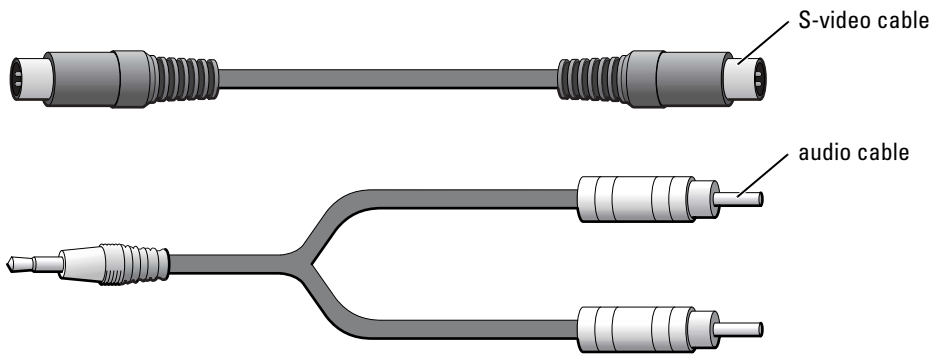

- 1 Shut down the computer and the television and/or audio device you want to connect.
- 2 Plug one end of the S-video cable in to the S-video connector on the computer.

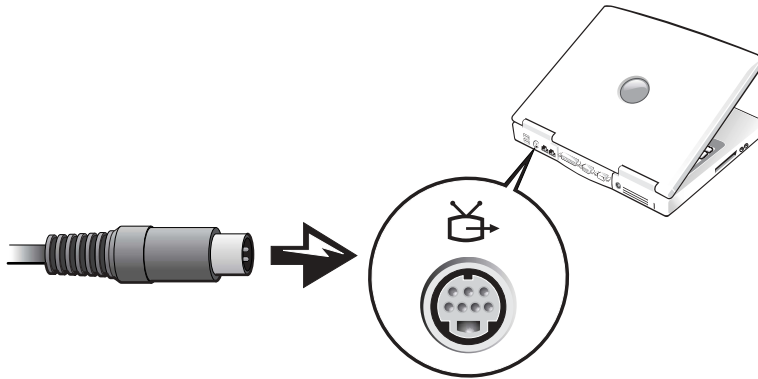

- 3 Plug the other end of the S-video cable in to your television.

- 4 Plug the single-connector end of the audio cable in to the headphone connector on your computer.

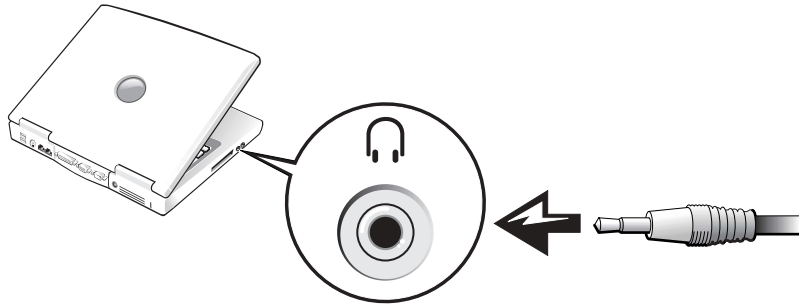

- 5 Plug the two RCA connectors on the other end of the audio cable in to the audio input connectors on your television or audio device.
- 6 Turn on the television, turn on any audio device you connected, and then turn on the computer.
- 7 See "Enabling the Display Settings for a Television" on page 60 to ensure that the computer recognizes and works properly with the television.

### Composite Video Connection

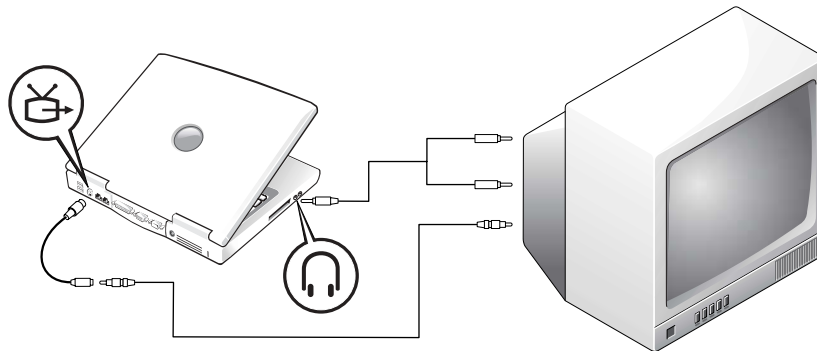

To connect the computer to a television that has a composite video input only, use a composite TV-out adapter cable available from Dell. Before you begin, ensure that you have the following cables:

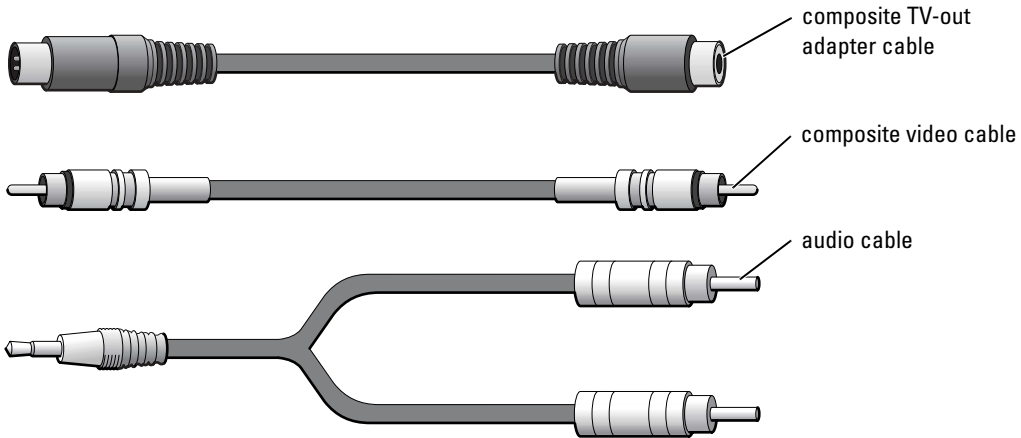

- 1 Turn off the computer and the television and/or audio device you want to connect.
- 2 Connect the composite TV-out adapter cable to the S-video TV-out connector on the computer.

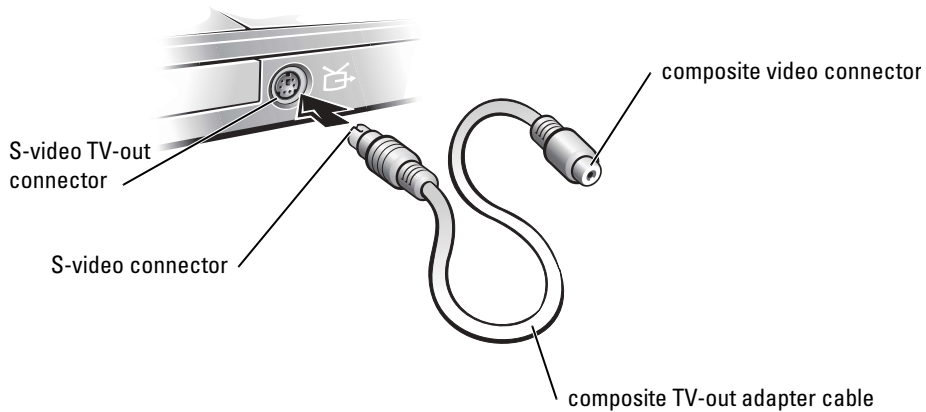

- 3 Plug one end of the composite video cable in to the composite video connector on the composite TV-out adapter cable.



- 4 Plug the other end of the composite video cable in to the composite video connector on the television.
- 5 Plug the single-connector end of the audio cable in to the headphone connector on the computer.

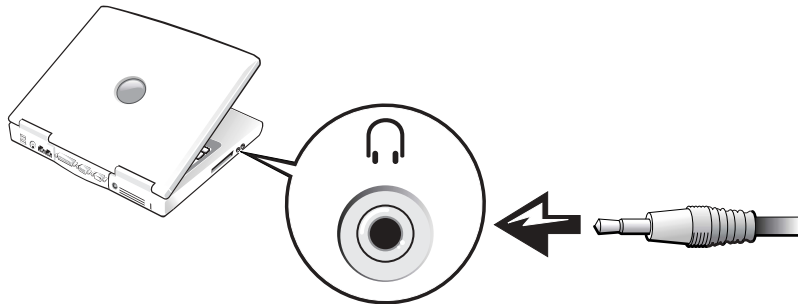

- 6 Plug the two RCA connectors on the other end of the audio cable in to the audio input connectors on your television or audio device.

## Enabling the Display Settings for a Television

### Intel UMA Integrated Video Controller

 **NOTE:** Ensure that you properly connect the television before you enable the display settings.

- 1 Click the **Start** button and click the **Control Panel** icon. Under **Pick a Category**, click **Appearance and Themes**.
- 2 Double-click the **Display** icon, click the **Settings** tab, and then click **Advanced**.
- 3 Click the **Intel (R) Extreme Graphics** tab.
- 4 Click the **Graphic Properties** button.

- 5** If you want to use only a television without using the computer display or any other display options:
  - a** In the new window, click **Television** so that a red check mark appears over the television icon.
  - b** Ensure that the settings are correct.
- 6** If you want to use a television and the computer display at the same time:
  - a** In the new window, click **Intel (R) Dual Display Clone** and ensure that one of the devices listed is a television.
  - b** Click **Device Settings**.
  - c** In the new window, ensure that the display resolution settings are correct.
- 7** Click **Apply** to view the new settings.





# Setting Up a Home and Office Network

## Connecting to a Network Adapter

Before you connect your computer to a network, the computer must have a network adapter installed and a network cable connected to it.

To connect a network cable:

-  **NOTE:** Insert the cable until it clicks into place, and then gently pull it to ensure that it is secure.
- 1** Connect the network cable to the network adapter connector on the back of your computer.
-  **NOTE:** Do not use a network cable with a telephone wall jack.
- 2** Connect the other end of the network cable to a network connection device, such as a network wall jack.

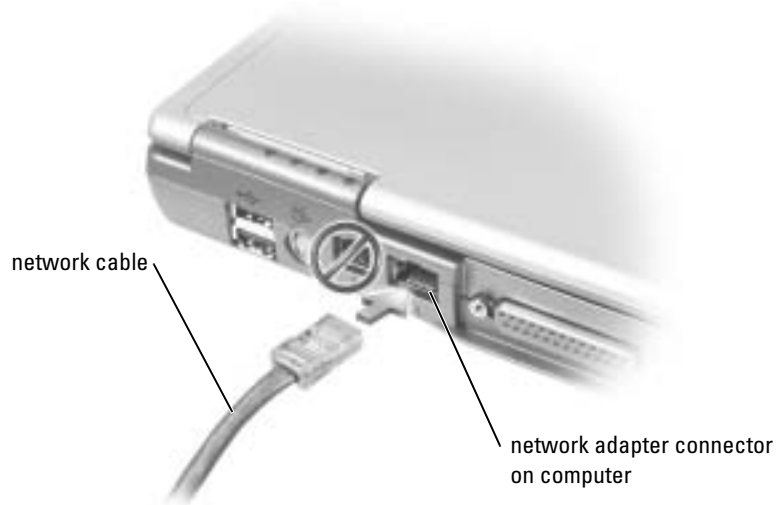

## Network Setup Wizard

The Microsoft® Windows® XP operating system provides a Network Setup Wizard to guide you through the process of sharing files, printers, or an Internet connection between computers in a home or small office.

- 1 Click the **Start** button, point to **All Programs**→ **Accessories**→ **Communications**, and then click **Network Setup Wizard**.
- 2 On the welcome screen, click **Next**.
- 3 Click **Checklist for creating a network**.



**NOTE:** Selecting the connection method **This computer connects directly to the Internet** enables the integrated firewall provided with Windows XP.

- 4 Complete the checklist and required preparations. Return to the Network Setup Wizard and follow the instructions on the screen.

## Network Problems

**CHECK THE NETWORK CABLE CONNECTOR** — Ensure that the network cable connector is firmly connected to the optional connector on the computer and the network wall jack.

**CHECK THE NETWORK LIGHTS ON THE NETWORK CONNECTOR** — Green indicates that the network connection is active. If the status light is not green, try replacing the network cable. Amber indicates that the optional network adapter driver is loaded and the adapter is detecting activity.

**RESTART THE COMPUTER** — Try to log on to the network again.

**CONTACT YOUR NETWORK ADMINISTRATOR** — Verify that your network settings are correct and that the network is functioning.

## Connecting to a Wireless Local Area Network



**NOTE:** These networking instructions do not apply to internal cards with Bluetooth® wireless technology or cellular products.



## Determining Your Network Type

 **NOTE:** Most wireless networks are of the infrastructure type.

Wireless networks fall into two categories—infrastructure networks and ad-hoc networks. An infrastructure network uses routers or access points to connect several computers. An ad-hoc network does not use routers or access points and consists of computers that broadcast to one another. For additional assistance with setting up your wireless connection, go to [support.dell.com](http://support.dell.com) and search for the keyword *wireless setup*.

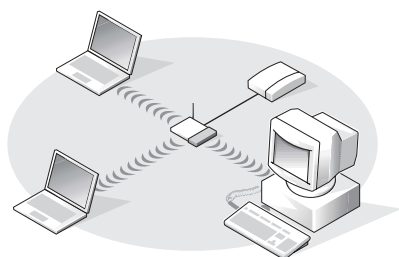

infrastructure network

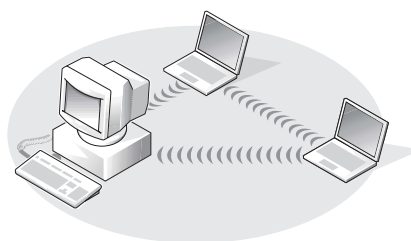

ad-hoc network

## Connecting to a Wireless Network in Microsoft® Windows® XP

Your wireless network card requires specific software and drivers in order to connect to a network. The software is already installed. If the software is removed or corrupted, follow the instructions included in the user's guide for your wireless network card. The user's guide is available on the Dell Support website at [support.dell.com](http://support.dell.com).

When you turn on your computer, a pop-up appears from the network icon in the notification area (located in the lower-right corner of the Windows desktop) whenever a network, for which your computer is not configured, is detected in the area.

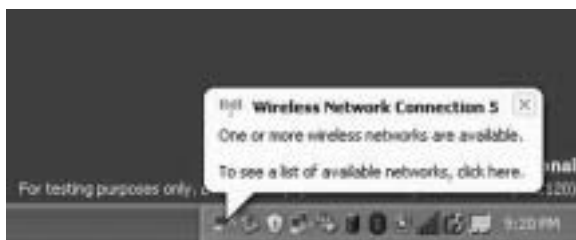

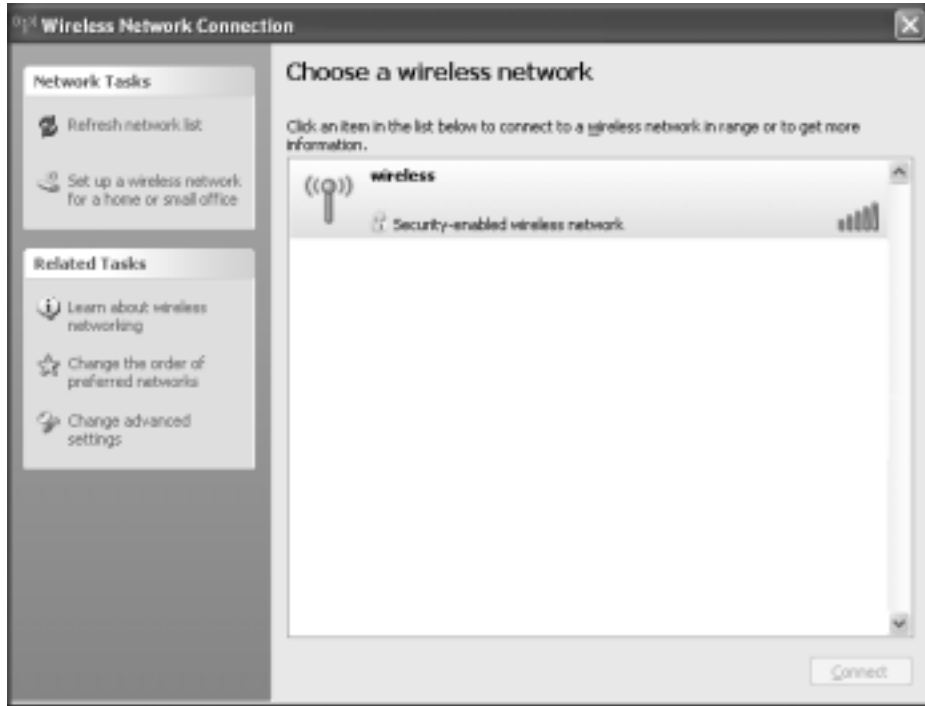

- 1 Click either the pop-up or the network icon to configure your computer for one of the available wireless networks.

The **Wireless Network Connections** window lists the wireless networks available in your area.



- 2 Click to select the network you want to configure, and then click **Connect** or double-click the network name in the list. If you select a secure network (identified by a  icon), you must enter a WEP or WPA key when prompted.

 **NOTE:** Network security settings are unique to your network. Dell cannot provide this information. Your network is configured automatically.

 **NOTE:** Your computer can take up to 1 minute to connect to the network.

After your computer is configured for the wireless network you selected, another pop-up notifies you that your computer is connected to the network you selected.



Thereafter, whenever you log on to your computer in the area of the wireless network, the same pop-up notifies you of the wireless network connection.



# Solving Problems

## Error Messages

If the message is not listed, see the documentation for the operating system or the program that was running at the time the message appeared.

**THE FILE BEING COPIED IS TOO LARGE FOR THE DESTINATION DRIVE** — The file that you are trying to copy is too large to fit on the disk, or the disk is too full. Try copying the file to a different disk or use a larger capacity disk.

**A FILENAME CANNOT CONTAIN ANY OF THE FOLLOWING CHARACTERS: \ / : \* ? " < > |** — Do not use these characters in filenames.

**INSERT BOOTABLE MEDIA** — The operating system is trying to boot to a nonbootable floppy disk or CD. Insert a bootable floppy disk or CD.

**NON-SYSTEM DISK OR DISK ERROR** — A floppy disk is in the floppy drive. Remove the floppy disk and restart the computer.

**NOT ENOUGH MEMORY OR RESOURCES. EXIT SOME PROGRAMS AND TRY AGAIN** — You have too many programs open. Close all windows and open the program that you want to use.

**OPERATING SYSTEM NOT FOUND** — Contact Dell. See page 112.

**A REQUIRED .DLL FILE WAS NOT FOUND** — The program that you are trying to open is missing an essential file. Remove and then reinstall the program.

- 1 Click the **Start** button and click **Control Panel**.
- 2 Click **Add or Remove Programs**.
- 3 Select the program you want to remove.
- 4 Click **Remove** or **Change/Remove** and follow the prompts on the screen.
- 5 See the program documentation for installation instructions.

**x:\ IS NOT ACCESSIBLE. THE DEVICE IS NOT READY** — Insert a disk into the drive and try again.

## Video and Display Problems

### If the display is blank



**NOTE:** If you are using a program that requires a higher resolution than your computer supports, Dell recommends that you attach an external monitor to your computer.

**CHECK THE BATTERY** — If you are using a battery to power your computer, the battery charge may be depleted. Connect the computer to an electrical outlet using the AC adapter, and turn on the computer.

**TEST THE ELECTRICAL OUTLET** — Ensure that the electrical outlet is working by testing it with another device, such as a lamp.

**CHECK THE AC ADAPTER** — Check the AC adapter cable connections. If the AC adapter has a light, ensure that the light is on.

**CONNECT THE COMPUTER DIRECTLY TO AN ELECTRICAL OUTLET** — Bypass power protection devices, power strips, and the extension cable to verify that the computer turns on. To access the help file, see page 9.

**ADJUST THE POWER PROPERTIES** — Search for the keyword *standby* in the Windows Help and Support Center. For instructions on accessing help files, see page 9.

**SWITCH THE VIDEO IMAGE** — If your computer is attached to an external monitor, press <Fn><F8> to switch the video image to the display.

### If the display is difficult to read

**ADJUST THE BRIGHTNESS** — See the *Dell Inspiron Help* file for instructions on adjusting the brightness. To access the help file, see page 9.

**MOVE THE SUBWOOFER AWAY FROM THE COMPUTER OR MONITOR** — If your external speaker system includes a subwoofer, ensure that the subwoofer is at least 60 cm (2 ft) away from the computer or external monitor.

**ELIMINATE POSSIBLE INTERFERENCE** — Turn off nearby fans, fluorescent lights, halogen lamps, or other appliances.

**ROTATE THE COMPUTER TO FACE A DIFFERENT DIRECTION** — Eliminate sunlight glare, which can cause poor picture quality.

**ADJUST THE WINDOWS DISPLAY SETTINGS** —

- 1 Click the **Start** button and then click **Control Panel**.
- 2 Click **Appearance and Themes**.
- 3 Click the area you want to change or click the **Display** icon.
- 4 Try different settings for **Color quality** and **Screen resolution**.

**SEE "ERROR MESSAGES"** — If an error message appears, see page 69.

## **If only part of the display is readable**

**CONNECT AN EXTERNAL MONITOR** —

- 1 Shut down your computer and connect an external monitor to the computer.
- 2 Turn on the computer and the monitor and adjust the monitor brightness and contrast controls.

If the external monitor works, the computer display or video controller may be defective. Contact Dell (see page 112).

## Modem and Internet Connection Problems

 **NOTE:** If you can connect to your Internet service provider (ISP), your modem is functioning properly. If you are sure that your modem is working properly and you still experience problems, contact your ISP.

**CHECK THE TELEPHONE WALL JACK** — Disconnect the telephone line from the modem and connect it to a telephone. Listen for a dial tone. Ensure that you have touchtone telephone service. Try connecting the modem to a different telephone wall jack.

Slow connection speeds can be caused by telephone noise as well as by telephone line or network conditions. Contact your telephone company or network administrator for more information.

**CONNECT THE MODEM DIRECTLY TO THE TELEPHONE WALL JACK** — If you have other telephone devices sharing the line, such as an answering machine, fax machine, surge protector, or line splitter, then bypass them and use the telephone line to connect the modem directly to the telephone wall jack.

**CHECK THE CONNECTION** — Verify that the telephone line is connected to the modem.

**CHECK THE TELEPHONE LINE** — Try using a different telephone line. If you are using a line that is 3 m (10 ft) or more in length, try a shorter one.

**IRREGULAR DIAL TONE** — If you have voice mail service, you might hear an irregular dial tone when you have messages. Contact your telephone company for instructions on restoring a dial tone.

**TURN OFF CALL WAITING (CATCH-PHONE)** — See your telephone directory for instructions on deactivating this feature. Then adjust the dial-up networking connection properties.

- 1 Click the **Start** button and click **Control Panel**.
- 2 Click **Printers and Other Hardware**, click **Phone and Modem Options**, click the **Dialing Rules** tab, and then click **Edit...**
- 3 In the **Edit Location** window, ensure that **To disable call waiting, dial:** is checked, and then select the proper code as listed in your telephone directory.
- 4 Click **Apply** and click **OK**.
- 5 Close the **Phone and Modems Options** window.
- 6 Close the **Control Panel** window.



**VERIFY THAT THE MODEM IS COMMUNICATING WITH WINDOWS —**

- 1 Click the **Start** button and click **Control Panel**.
- 2 Click **Printers and Other Hardware** and click **Phone and Modem Options**.
- 3 Click the **Modems** tab.
- 4 Click the **COM** port for your modem.
- 5 Click **Properties**, click the **Diagnostics** tab, and then click **Query Modem** to verify that the modem is communicating with Windows.

If all commands receive responses, the modem is operating properly.

## Scanner Problems

**CHECK THE POWER CABLE CONNECTION —** Ensure that the scanner power cable is firmly connected to a working electrical power source and that the scanner is turned on.

**CHECK THE SCANNER CABLE CONNECTION —** Ensure that the scanner cable is firmly connected to the computer and to the scanner.

**UNLOCK THE SCANNER —** Ensure that your scanner is unlocked if it has a locking tab or button.

**REINSTALL THE SCANNER DRIVER —** See the scanner documentation for instructions.

# Floppy Disk and Hard Drive Problems

 **NOTE:** For information on saving files to a floppy disk, see the *Dell Inspiron Help* file. To access the help file, see page 9.

## If you cannot save a file to a floppy disk drive

**ENSURE THAT WINDOWS RECOGNIZES THE DRIVE** — Click the **Start** button and click **My Computer**. If the drive is not listed, perform a full scan with your antivirus software to check for and remove viruses. Viruses can sometimes prevent Windows from recognizing the drive. Insert a bootable disk and restart the computer.

**ENSURE THAT THE DISK IS NOT WRITE-PROTECTED** — You cannot save data to a write-protected disk. See the following figure.

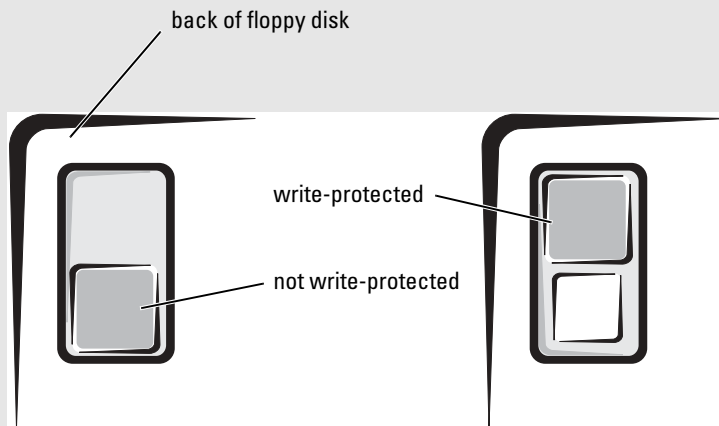

**TRY ANOTHER FLOPPY DISK** — Insert another disk to eliminate the possibility that the original disk is defective.

### **REINSTALL THE DRIVE** —

- 1 Save and close any open files, exit any open programs, and shut down the computer.
- 2 Remove the drive from the module bay. See page 41 for instructions.
- 3 Reinstall the drive.
- 4 Turn on the computer.

**CLEAN THE DRIVE** — See "Cleaning Your Computer" in the *Dell Inspiron Help* file for instructions. To access the help file, see page 9.

## If you have problems with a hard drive

**ALLOW THE COMPUTER TO COOL BEFORE TURNING IT ON** — A hot hard drive may prevent the operating system from starting. Try allowing the computer to return to room temperature before turning it on.

### **CHECK THE DRIVE FOR ERRORS** —

- 1 Click the **Start** button and click **My Computer**.
- 2 Right-click the drive letter (local disk) that you want to scan for errors, and then click **Properties**.
- 3 Click the **Tools** tab.
- 4 Under **Error-checking**, click **Check Now**.
- 5 Click **Start**.

## PC Card Problems

**CHECK THE PC CARD** — Ensure that the PC Card is properly inserted into the connector.

**ENSURE THAT THE CARD IS RECOGNIZED BY WINDOWS** — Double-click the **Safely Remove Hardware** icon in the Windows taskbar. Ensure that the card is listed.

**IF YOU HAVE PROBLEMS WITH A DELL-PROVIDED PC CARD** — Contact Dell. See page 112.

**IF YOU HAVE PROBLEMS WITH A PC CARD NOT PROVIDED BY DELL** — Contact the PC Card manufacturer.

## General Program Problems

### A program crashes

 **NOTE:** Software usually includes installation instructions in its documentation or on a floppy disk or CD.

**SEE THE SOFTWARE DOCUMENTATION** — Many software manufacturers maintain websites with information that may help you solve the problem. Ensure that you properly installed and configured the program. Reinstall the program if necessary.

### A program stops responding

#### END THE PROGRAM

- 1 Simultaneously press <Ctrl><Shift><Esc>.
- 2 Click the **Applications** tab, and then select the program that is no longer responding.
- 3 Click **End Task**.

### A solid blue screen appears

**TURN THE COMPUTER OFF** — If the computer does not respond to a keystroke or a proper shutdown (see page 32), press the power button until the computer turns off. Press the power button again to restart the computer.

The computer restarts.

### Error messages appear

**REVIEW "ERROR MESSAGES" ON PAGE 69** — Look up the message and take the appropriate action. See the software documentation.

## Resolving Other Technical Problems

**GO TO THE DELL SUPPORT WEBSITE** — Go to [support.dell.com](http://support.dell.com) for help with general usage, installation, and troubleshooting questions.

**E-MAIL DELL** — Go to [support.dell.com](http://support.dell.com) and then click **E-Mail Dell** in the **Communicate** list. Send an e-mail message to Dell about your problem; you can expect to receive an e-mail message from Dell within hours.

**CONTACT DELL** — If you cannot solve your problem using the Dell Support website ([support.dell.com](http://support.dell.com)) or e-mail service, call Dell for technical assistance (see page 112).

## If Your Dell™ Computer Gets Wet



**CAUTION:** Perform this procedure only after you are certain that it is safe to do so. If the computer is connected to an electrical outlet, it is recommended that you turn off AC power at the circuit breaker before attempting to remove the power cables from the electrical outlet. Use the utmost caution when removing wet cables from a live power source.

- 1 Shut down the computer (see page 32), disconnect the AC adapter from the computer, and then disconnect the AC adapter from the electrical outlet.
- 2 Turn off any attached external devices, and disconnect them from their power sources and then from the computer.
- 3 Ground yourself by touching one of the metal connectors on the back of the computer.
- 4 Remove the module bay device (see page 41) and any installed PC Cards, and put them in a safe place to dry.
- 5 Remove the battery.
- 6 Wipe off the battery and put it in a safe place to dry.
- 7 Remove the hard drive (see page 94).
- 8 Remove the memory module(s) (see page 41).
- 9 Open the display and place the computer right-side up across two books or similar props to let air circulate all around it. Let the computer dry for at least 24 hours in a dry area at room temperature.



**NOTICE:** Do not use artificial means, such as a hair dryer or a fan, to speed the drying process.



**CAUTION:** To help prevent electrical shock, verify that the computer is thoroughly dry before continuing with the rest of this procedure.

- 10 Ground yourself by touching one of the metal connectors on the back of the computer.
- 11 Replace the memory module(s), the memory module cover, and the screw(s).
- 12 Replace the hard drive.
- 13 Replace the module bay device and any PC Cards you removed.

- 14 Replace the battery.
- 15 Turn on the computer and verify that it is working properly.

 **NOTE:** For information on your warranty coverage, see the separate paper warranty document that shipped with your computer.

If the computer does not start, or if you cannot identify the damaged components, see page 112.

## If You Drop or Damage Your Computer

- 1 Save and close any open files, exit any open programs, and shut down the computer (see page 32).
- 2 Disconnect the AC adapter from the computer and from the electrical outlet.
- 3 Turn off any attached external devices, and disconnect them from their power sources and then from the computer.
- 4 Remove and reinstall the battery.
- 5 Turn on the computer.

 **NOTE:** For information on your warranty coverage, see the separate paper warranty document that shipped with your computer.

If the computer does not start, or if you cannot identify the damaged components, see page 112.

## Drivers

### What Is a Driver?

A driver is a program that controls a device such as a printer, mouse, or keyboard. All devices require a driver program.

A driver acts like a translator between the device and any other programs that use the device. Each device has its own set of specialized commands that only its driver recognizes.

Dell ships your computer to you with required drivers already installed—no further installation or configuration is needed.

Many drivers, such as the keyboard driver, come with your Microsoft® Windows® operating system. You may need to install drivers if you:

- Upgrade your operating system.
- Reinstall your operating system.
- Connect or install a new device.

## Identifying Drivers

If you experience a problem with any device, identify whether the driver is the source of your problem and, if necessary, update the driver.

- 1 Click the **Start** button and click **Control Panel**.
- 2 Under **Pick a Category**, click **Performance and Maintenance**.
- 3 Click **System**.
- 4 In the **System Properties** window, click the **Hardware** tab.
- 5 Click **Device Manager**.
- 6 Scroll down the list to see if any device has an exclamation point (a yellow circle with a [!]) on the device icon.

If an exclamation point is next to the device name, you may need to reinstall the driver or install a new driver.

## Reinstalling Drivers and Utilities



**NOTICE:** The Dell Support website at [support.dell.com](http://support.dell.com) provides approved drivers for Dell™ computers. If you install drivers obtained from other sources, your computer might not work correctly.

## Using Windows XP Device Driver Rollback

If a problem occurs on your computer after you install or update a driver, use Windows XP Device Driver Rollback to replace the driver with the previously installed version.

- 1 Click the **Start** button and click **Control Panel**.
- 2 Under **Pick a Category**, click **Performance and Maintenance**.
- 3 Click **System**.
- 4 In the **System Properties** window, click the **Hardware** tab.
- 5 Click **Device Manager**.
- 6 Right-click the device for which the new driver was installed and click **Properties**.
- 7 Click the **Drivers** tab.
- 8 Click **Roll Back Driver**.

If Device Driver Rollback does not resolve the problem, then use System Restore to return your computer to the operating state that existed before you installed the new driver.

## Manually Reinstalling Drivers

 **NOTE:** If you are reinstalling an infrared sensor driver, you must first enable the infrared sensor in the system setup program before continuing with the driver installation. For information on the system setup program, see page 107.

- 1 Extract the driver files to your hard drive.
- 2 Click the **Start** button and right-click **My Computer**.
- 3 Click **Properties**.
- 4 Click the **Hardware** tab and click **Device Manager**.
- 5 Double-click the type of device for which you are installing the driver (for example, **Modems** or **Infrared devices**).
- 6 Double-click the name of the device for which you are installing the driver.
- 7 Click the **Driver** tab and click **Update Driver**.
- 8 Click **Install from a list or specific location (Advanced)** and click **Next**.
- 9 Click **Browse** and browse to the location to which you previously extracted the driver files.
- 10 When the name of the appropriate driver appears, click **Next**.
- 11 Click **Finish** and restart your computer.

## Resolving Software and Hardware Incompatibilities

If a device either is not detected during the operating system setup or is detected but incorrectly configured, you can use Device Manager or the Hardware Troubleshooter to resolve the incompatibility.

To resolve incompatibilities using Device Manager:

- 1 Click the **Start** button and click **Control Panel**.
- 2 Click **Performance and Maintenance** and click **System**.
- 3 Click the **Hardware** tab and click **Device Manager**.
- 4 In the **Device Manager** list, check for devices that are incorrectly configured.  
Incorrectly configured devices are indicated by a yellow exclamation point (!) or a red X if the device has been disabled.
- 5 Double-click any device marked with an exclamation point to display the **Properties** window.  
The **Device** status area in the **Properties** window reports the cards or devices that need to be reconfigured.
- 6 Reconfigure the devices or remove the devices from the **Device Manager**. See the documentation that came with the device for information on configuring the device.



To resolve incompatibilities using the Hardware Troubleshooter:

- 1 Click the **Start** button and click **Help and Support**.
- 2 Type `hardware troubleshooter` in the **Search** field and click the arrow to start the search.
- 3 Click **Hardware Troubleshooter** in the **Search Results** list.
- 4 In the **Hardware Troubleshooter** list, click **I need to resolve a hardware conflict on my computer**, and click **Next**.

## Restoring Your Operating System

You can restore your operating system in the following ways:

- Microsoft Windows XP System Restore returns your computer to an earlier operating state without affecting data files.
- Dell PC Restore by Symantec restores your hard drive to the operating state it was in when you purchased the computer. Dell PC Restore permanently deletes all data on the hard drive and removes any applications installed after you received the computer.



**NOTE:** Dell PC Restore is available only on computers purchased in certain regions.

### Using Microsoft Windows XP System Restore

The Microsoft Windows XP operating system provides System Restore to allow you to return your computer to an earlier operating state (without affecting data files) if changes to the hardware, software, or other system settings have left the computer in an undesirable operating state. See the Windows Help and Support Center for information on using System Restore. To access help, see page 9.



**NOTICE:** Make regular backups of your data files. System Restore does not monitor your data files or recover them.



**NOTE:** The procedures in this document were written for the Windows default view, so they may not work if you set your Dell™ computer to the Windows Classic view.

### Creating a Restore Point

- 1 Click the **Start** button and click **Help and Support**.
- 2 Click **System Restore**.
- 3 Follow the instructions on the screen.

### Restoring the Computer to an Earlier Operating State

If problems occur after you install a device driver, use Device Driver Rollback (see page 81) to resolve the problem. If that is unsuccessful, then use System Restore.

 **NOTICE:** Before you restore the computer to an earlier operating state, save and close any open files and exit any open programs. Do not alter, open, or delete any files or programs until the system restoration is complete.

**1** Click the **Start** button, point to **All Programs**→**Accessories**→**System Tools**, and then click **System Restore**.

**2** Ensure that **Restore my computer to an earlier time** is selected and click **Next**.

**3** Click a calendar date to which you want to restore your computer.

The **Select a Restore Point** screen provides a calendar that allows you to see and select restore points. All calendar dates with available restore points appear in boldface type.

**4** Select a restore point and click **Next**.

If a calendar date has only one restore point, then that restore point is automatically selected. If two or more restore points are available, click the restore point that you prefer.

**5** Click **Next**.

The **Restoration Complete** screen appears after System Restore finishes collecting data and then the computer restarts.

**6** After the computer restarts, click **OK**.

To change the restore point, you can either repeat the steps using a different restore point, or you can undo the restoration.

### Undoing the Last System Restore

 **NOTICE:** Before you undo the last system restore, save and close all open files and exit any open programs. Do not alter, open, or delete any files or programs until the system restoration is complete.

**1** Click the **Start** button, point to **All Programs**→**Accessories**→**System Tools**, and then click **System Restore**.

**2** Click **Undo my last restoration** and click **Next**.

### Enabling System Restore

If you reinstall Windows XP with less than 200 MB of free hard-disk space available, System Restore is automatically disabled. To see if System Restore is enabled:

**1** Click the **Start** button and click **Control Panel**.

**2** Click **Performance and Maintenance**.

**3** Click **System**.

**4** Click the **System Restore** tab.

**5** Ensure that **Turn off System Restore** is unchecked.

## Using Dell PC Restore by Symantec

 **NOTE:** Dell PC Restore is available only on computers purchased in certain regions.

Use Dell PC Restore by Symantec only as the last method to restore your operating system. PC Restore restores your hard drive to the operating state it was in when you purchased the computer. Any programs or files added since you received your computer—including data files—are permanently deleted from the hard drive. Data files include documents, spreadsheets, e-mail messages, digital photos, music files, and so on. If possible, back up all data before using PC Restore.

 **NOTICE:** Using PC Restore permanently deletes all data on the hard drive and removes any applications or drivers installed after you received your computer. If possible, back up the data before using PC Restore.

To use PC Restore:

- 1 Turn on the computer.

During the boot process, a blue bar with [www.dell.com](http://www.dell.com) appears at the top of the screen.

- 2 Immediately upon seeing the blue bar, press <Ctrl><F11>.

If you do not press <Ctrl><F11> in time, let the computer finish restarting, and then restart the computer again.

 **NOTICE:** If you do not want to proceed with PC Restore, click **Reboot** in the following step.

- 3 On the next screen that appears, click **Restore**.

- 4 On the next screen, click **Confirm**.

The restore process takes approximately 6–10 minutes to complete.

- 5 When prompted, click **Finish** to reboot the computer.

 **NOTE:** Do not manually shut down the computer. Click **Finish** and let the computer completely reboot.

- 6 When prompted, click **Yes**.

The computer restarts. Because the computer is restored to its original operating state, the screens that appear, such as the End User License Agreement, are the same ones that appeared the first time the computer was turned on.

- 7 Click **Next**.

The **System Restore** screen appears and the computer restarts.

- 8 After the computer restarts, click **OK**.

## Removing PC Restore

 **NOTICE:** PC Restore enables you to restore your computer's operating system to the condition it was in when you purchased your computer. It is recommended that you *do not* remove PC Restore from your computer, even to gain additional hard drive space. If you remove PC Restore from the hard drive, you cannot ever recall it, and you will never be able to use PC Restore to return your computer's operating system to its original state.

- 1 Log on to the computer as a local administrator.
- 2 In Windows Explorer, go to `c:\dell\utilities\DSR`.
- 3 Double-click the filename `DSRIRRemv2.exe`.

 **NOTE:** If you do not log on as a local administrator, a message appears stating that you that you must do so. Click **Quit** and log on as a local administrator.

If the partition for PC Restore does not exist, a message appears stating that the partition was not found. Click **Quit**; there is no partition to delete.

- 4 Click **OK** to remove the partition.
- 5 Click **Yes** when a confirmation message appears.

The partition is deleted and the `c:\` partition expands to include the newly available disk space. To check the available space, right-click the `c:\` drive in Windows Explorer and select **Properties**.

- 6 Click **Finish** to close the **PC Restore Removal** window.
- 7 Restart the computer.

## Dell Diagnostics



**CAUTION:** Before you begin any of the procedures in this section, follow the safety instructions in the *Product Information Guide*.

### When to Use the Dell Diagnostics

If you experience a problem with your computer, perform the checks in "Solving Problems" on page 69 and run the Dell Diagnostics before you contact Dell for technical assistance.

 **NOTICE:** The Dell Diagnostics works only on Dell™ computers.

The Dell Diagnostics is located on a hidden diagnostic utility partition on your hard drive.

 **NOTE:** If your computer cannot display a screen image, contact Dell. See page 112.

- 1 Shut down the computer. See page 32.
- 2 If the computer is connected to a docking device (docked), undock it. See the documentation that came with your docking device for instructions.
- 3 Connect the computer to an electrical outlet.

4 Turn on the computer. When the DELL™ logo appears, press <F12> immediately.

 **NOTE:** If you cannot see anything on your display, hold down the mute button and press the computer's power button to begin the Dell Diagnostics. The computer automatically runs the Pre-boot System Assessment.

If you wait too long and the Microsoft® Windows® logo appears, continue to wait until you see the Windows desktop. Then shut down your computer through the **Start** menu and try again.

5 When the boot device list appears, highlight **Diagnostics** and press <Enter>.

The computer runs the Pre-boot System Assessment, a series of initial tests of your system board, keyboard, hard drive, and display.

- During the assessment, answer any questions that appear.
- If a failure is detected, the computer stops and beeps. To stop the assessment and restart the computer, press <n>; to continue to the next test, press <y>; to retest the component that failed, press <r>.
- If failures are detected during the Pre-boot System Assessment, write down the error code(s) and contact Dell, before continuing on to the Dell Diagnostics. For information on Contacting Dell, see page 112.

If the Pre-boot System Assessment completes successfully, you receive the message **Booting Dell Diagnostic Utility Partition**. Press any key to continue.

6 Press any key to start the Dell Diagnostics from the diagnostics utility partition on your hard drive.

7 When the Dell Diagnostics **Main Menu** appears, select the test you want to run.

### Dell Diagnostics Main Menu

1 After the Dell Diagnostics loads and the **Main Menu** screen appears, click the button for the option you want.

Option	Function
Express Test	Performs a quick test of devices. This test typically takes 10 to 20 minutes and requires no interaction on your part. Run <b>Express Test</b> first to increase the possibility of tracing the problem quickly.
Extended Test	Performs a thorough check of devices. This test typically takes an hour or more and requires you to answer questions periodically.
Custom Test	Tests a specific device. You can customize the tests you want to run.

Option	Function
Symptom Tree	Lists the most common symptoms encountered and allows you to select a test based on the symptom of the problem you are having.

- 2** If a problem is encountered during a test, a message appears with an error code and a description of the problem. Write down the error code and problem description and follow the instructions on the screen.

If you cannot resolve the error condition, contact Dell. For information on Contacting Dell, see page 112.



**NOTE:** The Service Tag for your computer is located at the top of each test screen. If you contact Dell, technical support will ask for your Service Tag.

- 3** If you run a test from the **Custom Test** or **Symptom Tree** option, click the applicable tab described in the following table for more information.

Tab	Function
Results	Displays the results of the test and any error conditions encountered.
Errors	Displays error conditions encountered, error codes, and the problem description.
Help	Describes the test and may indicate requirements for running the test.
Configuration	Displays your hardware configuration for the selected device.  The Dell Diagnostics obtains configuration information for all devices from system setup, memory, and various internal tests, and it displays the information in the device list in the left pane of the screen. The device list may not display the names of all the components installed on your computer or all devices attached to your computer.
Parameters	Allows you to customize the test by changing the test settings.

- 4** When the tests are complete, close the test screen to return to the **Main Menu** screen. To exit the Dell Diagnostics and restart the computer, close the **Main Menu** screen.

# Adding and Replacing Parts

## Before You Begin

This section provides procedures for removing and installing the components in your computer. Unless otherwise noted, each procedure assumes that the following conditions exist:

- You have performed the steps in "Shutting Down Your Computer."
- You have read the safety information in the *Product Information Guide*.

## Recommended Tools

The procedures in this document may require the following tools:

- Small flat-blade screwdriver
- Phillips screwdriver
- Small plastic scribe
- Flash BIOS update program floppy disk or CD

## Shutting Down Your Computer

Use the following safety guidelines to help protect your computer from potential damage and to ensure your own personal safety.



**CAUTION:** Before you begin any of the procedures in this section, follow the safety instructions in the *Product Information Guide*.



**NOTICE:** Only a certified service technician should perform repairs on your computer. Damage due to servicing that is not authorized by Dell is not covered by your warranty.



**CAUTION:** Handle components and cards with care. Do not touch the components or contacts on a card. Hold a card by its edges or by its metal mounting bracket. Hold a component such as a processor by its edges, not by its pins.



**NOTICE:** When you disconnect a cable, pull on its connector or on its strain-relief loop, not on the cable itself. Some cables have a connector with locking tabs; if you are disconnecting this type of cable, press in on the locking tabs before you disconnect the cable. As you pull connectors apart, keep them evenly aligned to avoid bending any connector pins. Also, before you connect a cable, ensure that both connectors are correctly oriented and aligned.

- ➡ **NOTICE:** To avoid damaging the computer, perform the following steps before you begin working inside the computer.
- 1 Ensure that the work surface is flat and clean to prevent the computer cover from being scratched.
  - 2 Shut down the computer.
  - 3 Ensure that the computer and any attached devices are turned off. If your computer and attached devices did not automatically turn off when you shut down your computer, press and hold the power button for 4 seconds.
  - 4 If the computer is connected to a docking device (docked), undock it. See the documentation that came with your docking device for instructions.
- ➡ **NOTICE:** To disconnect a network cable, first unplug the cable from your computer and then unplug it from the network wall jack.
- 5 Disconnect any telephone or telecommunication lines from the computer.
  - 6 Disconnect your computer and all attached devices from their electrical outlets, and then press the power button to ground the system board.
- ➡ **NOTICE:** To connect a network cable, first plug the cable into the network wall jack and then plug it into the computer.
- 7 Remove any installed PC Cards from the PC Card slot.
  - 8 Close the display and turn the computer upside down on a flat work surface.
- ➡ **NOTICE:** To avoid damaging the system board, you must remove the main battery before you service the computer.
- 9 Slide and hold the battery-bay latch release on the bottom of the computer, and then remove the battery from the bay.

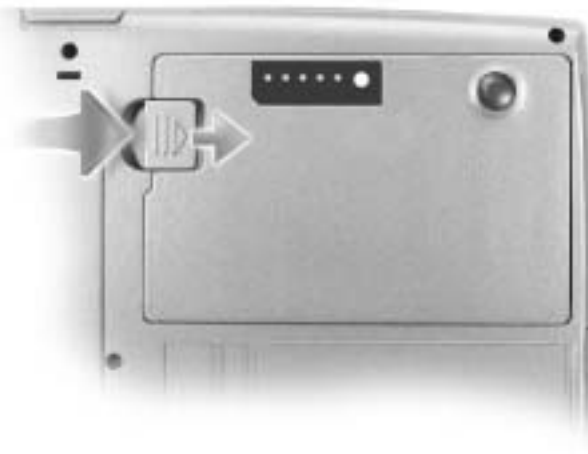



- 10 Remove any installed modules, including a second battery, if installed.
- 11 Remove the hard drive.

## Adding Memory

You can increase your computer memory by installing memory modules on the system board. See "Specifications" on page 101 for information on the memory supported by your computer. Install only memory modules that are intended for your computer.

 **NOTE:** Memory modules purchased from Dell are covered under your computer warranty.

 **CAUTION:** Before working inside your computer, read the safety instructions in the *Product Information Guide*.

- 1 Follow the procedures in "Before You Begin" on page 87.
- 2 Turn the computer over, loosen the captive screw from the memory module cover, and then remove the cover.

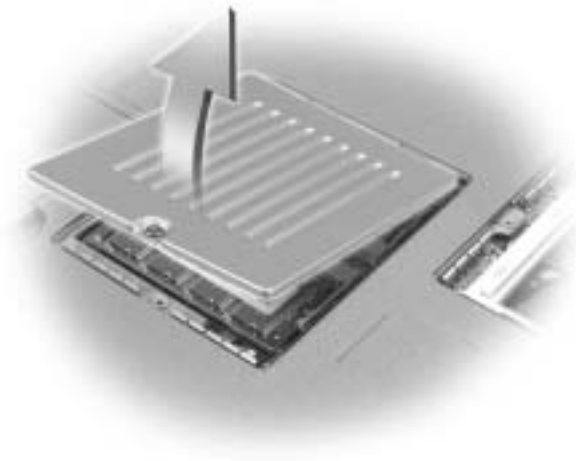

- NOTICE:** To prevent damage to the memory module connector, do not use tools to spread the memory-module securing clips.
- 3** If you are replacing a memory module, remove the existing module:
- Use your fingertips to carefully spread apart the securing clips on each end of the memory module connector until the module pops up.
  - Remove the module from the connector.

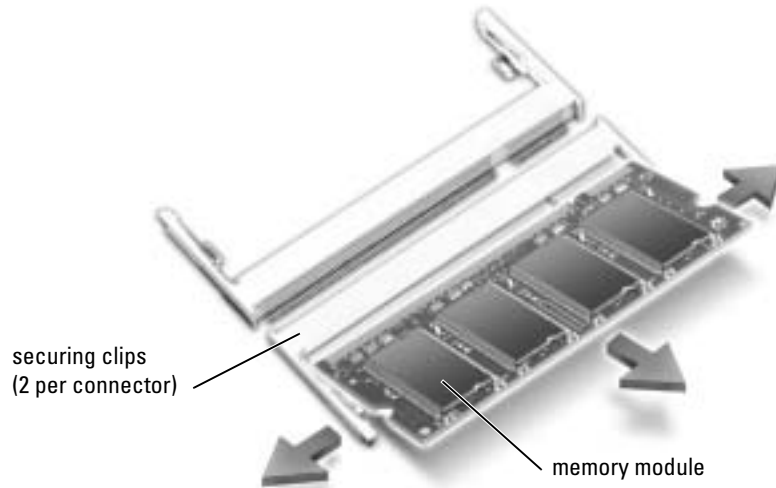

- NOTICE:** If you need to install memory modules in two connectors, install a memory module in the connector labeled "DIMMA" before you install a module in the connector labeled "DIMMB." Insert memory modules at a 45-degree angle to avoid damaging the connector.
- 4** Ground yourself and install the new memory module:
- NOTE:** If the memory module is not installed properly, the computer may not boot properly. No error message indicates this failure.
- Align the notch in the module edge connector with the tab in the connector slot.
  - Slide the module firmly into the slot at a 45-degree angle, and rotate the module down until it clicks into place. If you do not feel the click, remove the module and reinstall it.



5 Replace the cover.

**NOTICE:** If the cover is difficult to close, remove the module and reinstall it. Forcing the cover to close may damage your computer.

6 Insert the battery into the battery bay, or connect the AC adapter to your computer and an electrical outlet.

7 Turn on the computer.

As the computer boots, it detects the additional memory and automatically updates the system configuration information.

To confirm the amount of memory installed in the computer, click the **Start** button, click **Help and Support**, and then click **Computer Information**.

## Adding a Mini PCI Card

**CAUTION:** FCC rules strictly prohibit users from installing 5-GHz (802.11a, 802.11a/b, 802.11a/b/g) Wireless LAN Mini PCI cards. Under no circumstances should the user install such a device. Only trained Dell service personnel are authorized to install a 5-GHz Wireless LAN Mini PCI card.

If you are removing and/or installing a 2.4-GHz (802.11b, 802.11b/g) Mini PCI card, follow the instructions noted below. Only products approved for use in your portable computer may be installed. Approved Mini PCI cards may be purchased only from Dell.

**NOTE:** 2.4-GHz Wireless LAN PC Cards may be removed and installed by the user.

If you ordered a Mini PCI card with your computer, the card is already installed.

 **CAUTION:** Before working inside your computer, read the safety instructions in the *Product Information Guide*.

- 1 Follow the procedures in "Before You Begin" on page 87.
- 2 Turn the computer over.
- 3 Loosen the captive screw in the cover, and remove the cover.



- 4 If a Mini PCI card is not already installed, go to step 5. If you are replacing a Mini PCI card, remove the existing card:
  - a Disconnect the Mini PCI card from any attached cables.
  - b Release the Mini PCI card by spreading the metal securing tabs until the card pops up slightly.
  - c Lift the Mini PCI card out of its connector.

 **NOTICE:** To avoid damaging the Mini PCI card, never place cables on top of or under the card.

 **NOTICE:** The connectors are keyed to ensure correct insertion. If you feel resistance, check the connectors and realign the card.

- 5 Align the Mini PCI card with the connector at a 45-degree angle, and press the Mini PCI card into the connector until you hear a click.
- 6 Connect the antenna cables to the Mini PCI card.

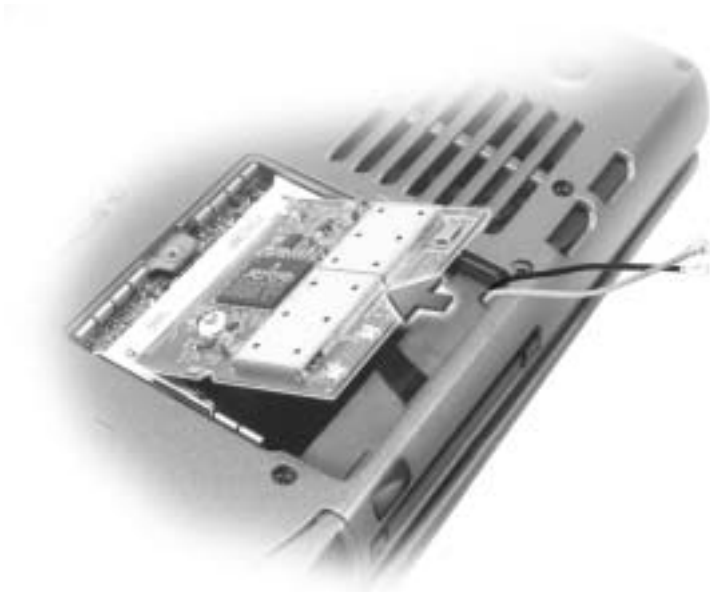



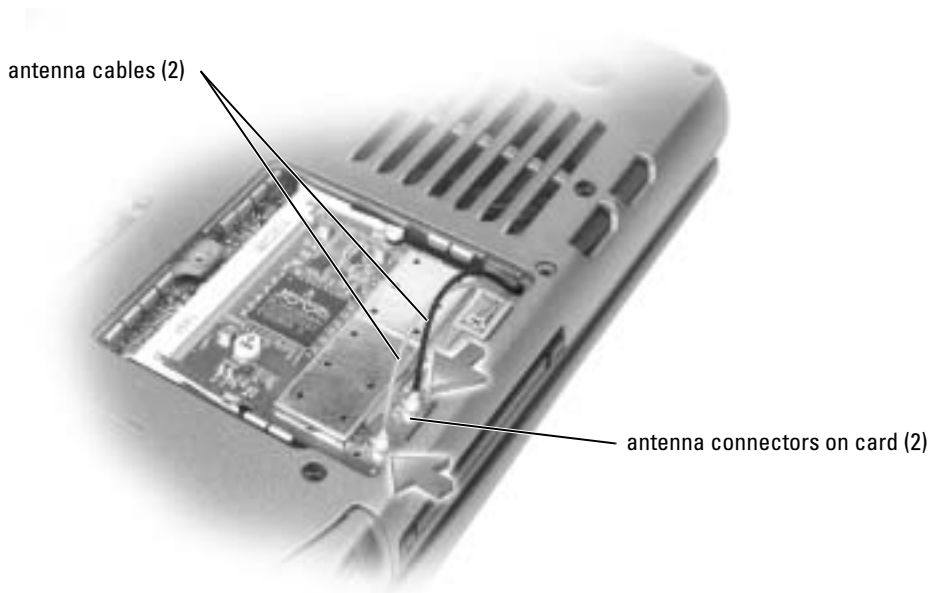



**7** Tuck in the antenna cables.



**8** Replace the cover and screw(s).

## Replacing the Hard Drive

-  **NOTE:** If your hard drive is not pre-imaged, you need to reinstall the Microsoft® Windows® operating system and the drivers and utilities.
-  **CAUTION:** If you remove the hard drive from the computer when the drive is hot, *do not touch* the metal housing of the hard drive.
-  **CAUTION:** Before working inside your computer, read the safety instructions in the *Product Information Guide*.
-  **NOTICE:** To prevent data loss, turn off your computer before removing the hard drive. Do not remove the hard drive while the computer is on, in standby mode, or in hibernate mode.
-  **NOTICE:** Hard drives are extremely fragile; even a slight bump can damage the drive.
-  **NOTE:** Dell does not guarantee compatibility or provide support for hard drives from sources other than Dell.

To replace the hard drive in the hard drive bay:

- 1 Follow the procedures in "Before You Begin" on page 87.
- 2 Turn the computer over, and remove the hard drive screws.

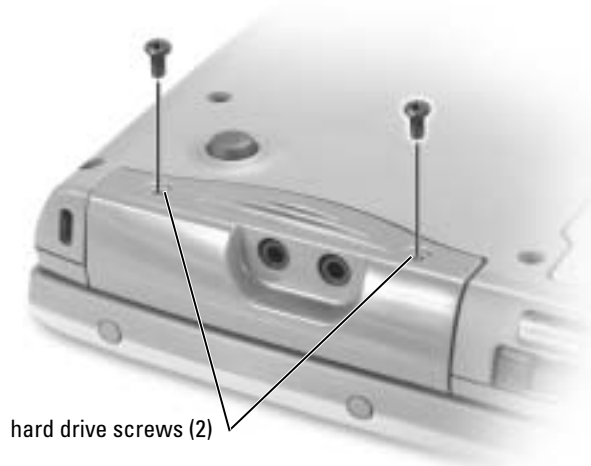

-  **NOTICE:** When the hard drive is not in the computer, store it in protective antistatic packaging. See the *Product Information Guide* for information about protecting against electrostatic discharge.
- 3 Slide the hard drive out of the computer.
  - 4 Remove the new drive from its packaging.  
Save the original packaging for storing or shipping the hard drive.

**NOTICE:** Use firm and even pressure to slide the drive into place. If you use excessive force, you may damage the connector.

- 5 Insert the drive into the bay, and lift the hard drive door. Push the hard drive until it is fully seated in the bay. Press the hard drive door down.
- 6 Replace and tighten the screw(s).
- 7 Install the operating system for your computer.
- 8 Install the drivers and utilities for your computer.

### Returning a Hard Drive to Dell

Return your old hard drive to Dell in its original or comparable foam packaging. Otherwise, the hard drive may be damaged in transit.

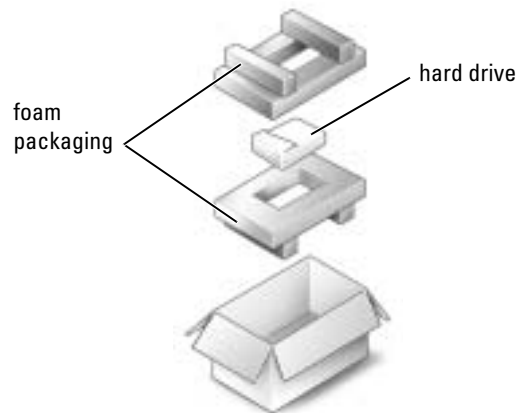

## Keyboard

**⚠ CAUTION:** Before performing the following procedures, read the safety instructions in the *Product Information Guide*.

**🔄 NOTICE:** To avoid electrostatic discharge, ground yourself by using a wrist grounding strap or by periodically touching an unpainted metal surface (such as the back panel) on the computer.

- 1 Turn the computer top-side up and open it.





**2** Remove the center control cover:

- a** Open the display all the way (180 degrees) so that it lies flat against your work surface.
- b** Starting on the right side of the computer, use a plastic scribe to pry up the center control cover. Lift it away from the computer, and lay it aside.

center control cover



**3** Remove the keyboard:

- a** Remove the two M2.5 x 5-mm screws across the top of the keyboard.

**ⓘ NOTICE:** The keycaps on the keyboard are fragile, easily dislodged, and time-consuming to replace. Be careful when removing and handling the keyboard.

- b** Rotate the keyboard up and slide it forward.
- c** Hold the keyboard up and slightly forward to allow access to the keyboard connector.

- d Pull up on the keyboard connector tab to disconnect the keyboard connector from the system board.



**NOTE:** When you replace the keyboard, ensure that the keyboard tabs are completely in place to avoid scratching the palm rest.

## Internal Card With Bluetooth® Wireless Technology

If you ordered an internal card with Bluetooth wireless technology with your computer, the card is already installed.

**CAUTION:** Before working inside your computer, read the safety instructions in the *Product Information Guide*.

- 1 Ensure that the work surface is flat and clean to prevent scratching the computer cover.
- 2 Save and close any open files, exit any open programs, and then shut down the computer (see page 32).
- 3 If the computer is connected to a docking device (docked), undock it. See the documentation that came with your docking device for instructions.
- 4 Disconnect the computer from the electrical outlet.
- 5 Wait 10 to 20 seconds, and then disconnect any attached devices.
- 6 Remove any installed PC Cards, batteries, and module bay devices.

**NOTICE:** Handle components and cards by their edges, and avoid touching pins and contacts. Ground yourself by touching a metal connector on the back of the computer. Continue to ground yourself periodically during this procedure.

- 7 Remove the hard drive.
- 8 Pull the Bluetooth card connector out of the system board connector.
- 9 Pull the cable to remove the Bluetooth card from the computer.

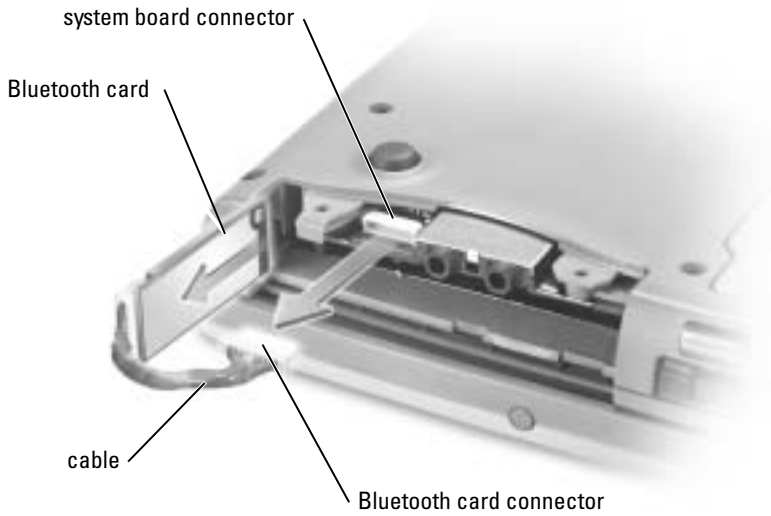

 **NOTE:** When replacing the Bluetooth card, ensure the Bluetooth cable is routed correctly so that you do not damage the cable when you install the hard drive.



# Appendix

## Specifications

---

**Microprocessor**

---

Microprocessor type	Intel® Centrino™ Mobile Technology or Intel® Pentium® M Processor
L1 cache	64 KB (internal); 32-KB instruction and 32-KB write-back data
L2 cache	1 MB
External bus frequency	400 MHz, source synchronous processor system bus

---

**System Information**

---

Data bus width	64 bits
DRAM bus width	64 bits
Microprocessor address bus width	32 bits
Flash EPROM	1MB
PCI bus	32 bits

---

**PC Card**

---

CardBus controller	PCI4510 CardBus controller
PC Card connector	supports one Type I or Type II card
Cards supported	3.3 V and 5 V
PC Card connector size	68 pins
Data width (maximum)	PCMCIA 16 bits CardBus 32 bits

---

**Memory**

---

Minimum speed requirement	266 MHz
Memory module connector	two user-accessible DDR SDRAM connectors
Memory module capacities	128 MB, 256 MB, 512 MB, and 1024MB
Memory type	2.5V DDR SDRAM
Standard memory	128 MB
Maximum memory	2 GB

---

**Ports and Connectors**

---

Serial	9-pin connector; 16550C-compatible, 16-byte buffer connector
Parallel	25-hole connector; unidirectional, bidirectional, or ECP
Video	15-hole connector
Audio	microphone miniconnector, stereo headphones/speakers miniconnector
USB	two 4-pin USB 2.0-compliant connectors
Infrared sensor	sensor compatible with IrDA Standard 1.1 (Fast IR) and IrDA Standard 1.0 (Slow IR)
S-video TV-out	7-pin mini-DIN connector (optional S-video to composite video adapter cable)
Mini PCI	Type IIIA Mini PCI card slot
Modem	RJ-11 port
Network adapter	RJ-45 port
IEEE 1394	4-pin serial connector

---

**Communications**

---

Modem:	
Type	v.92 56K MDC
Controller	softmodem
Interface	internal AC'97 bus

---

**Communications (continued)**

---

Network adapter	10/100 Ethernet LAN on system board
Wireless	internal Mini PCI Wi-Fi wireless support; internal card with Bluetooth® wireless technology (optional, available at point of sale only)

---

**Video**

---

Video type	Intel UMA Integrated
Video controller	Intel 855GME Integrated chip set
Video memory	8 MB or 1 MB with Intel DVMT up to 32-MB (with 128 MB of system memory) or 64-MB (with 256 MB or more of system memory)
LCD interface	LVDS

---

**Audio**

---

Audio type	compatible with Soundblaster and Microsoft® Windows® Sound System
Audio controller	Intel AC'97
Stereo conversion	20-bit (stereo digital-to-analog), 18-bit (stereo analog-to-digital)
Interfaces:	
Internal	AC'97
External	microphone miniconnector, stereo headphones/speakers miniconnector
Speaker	two 4-ohm speakers
Internal speaker amplifier	2-W channel into 4 ohms
Volume controls	keyboard shortcuts or program menus

---

**Display**

---

Type (active-matrix TFT)	XGA; UXGA
Dimensions:	
Height	228.1 mm (9 inches)
Width	304.1 mm (12 inches)
Diagonal	380.1 mm (15 inches)

---

**Display (continued)**

---

Maximum resolutions	1024 x 768 at 16.8 million colors
Response time (typical)	25-ms rise (maximum), 35-ms fall (maximum)
Refresh rate	60 Hz
Operating angle	0° (closed) to 180°
Viewing angles:	
Horizontal	±60°
Vertical	±45°
Pixel pitch	0.2172 x 0.2172 mm
Power Consumption:	
Panel with backlight (typical)	4.6 W
Controls	brightness can be controlled through keyboard shortcuts

---

**Keyboard**

---

Number of keys	87 (U.S. and Canada); 88 (Europe); 91 (Japan)
Key travel	2.7 mm ± 0.3 mm (0.11 inch ± 0.016 inch)
Key spacing	19.05 mm ± 0.3 mm (0.75 inch ± 0.012 inch)
Layout	QWERTY/AZERTY/Kanji

---

**Touch Pad**

---

X/Y position resolution (graphics table mode)	240 cpi
Size:	
Width	64.88-mm (2.55-inch) sensor-active area
Height	48.88-mm (1.92-inch) rectangle



---

**Battery**

---

Type	6-cell "smart" lithium ion (48 WHr) 4-cell "smart" lithium ion (32 WHr)
Dimensions:	
Depth	77.5 mm (3.05 inches)
Height	19.5 mm (0.76 inch)
Width	123.4 mm (4.86 inches)
Weight	0.32 kg (0.7 lb) (6-cell battery) 0.23 kg (0.52 lb) (4-cell battery)
Voltage	11.1 VDC (6-cell battery) 14.8 VDC (4-cell battery)
Charge time with computer off (approximate)	1 hour for eighty percent charge
Operating time	approximately 3.5 to 4 hours (6-cell battery); approximately 2 to 2.5 hours (4-cell battery); can be significantly reduced under certain power-intensive conditions
Life span (approximate)	300 discharge/charge cycles
Temperature range:	
Operating	0° to 35°C (32° to 95°F)
Storage	-20° to 65°C (-4° to 149°F)

---

**AC Adapter**

---

Input voltage	90–264 VAC
Input current (maximum)	1.7 A
Input frequency	47–63 Hz
Output current	3.34A (65 W) 4.62A (90 W)
Output power	65 W or 90 W
Rated output voltage	19.5 VDC

---

**AC Adapter (continued)**

---

## Dimensions:

Height	28.2 mm (1.11 inches) (65 W)
	34.2 mm (1.35 inches) (90 W)
Width	57.9 mm (2.28 inches) (65 W)
	60.8 mm (2.39 inches) (90 W)
Depth	137.2 mm (5.40 inches) (65 W)
	153.4 mm (6.04 inches) (90 W)
Weight (with cables)	0.4 kg (1 lb) (90 W)
	0.3 kg (.69 lb) (65 W)

## Temperature range:

Operating	0° to 35°C (32° to 95°F)
Storage	-40° to 65°C (-40° to 149°F)

---

**Computer Dimensions and Weight**

---

Height	35.5 mm (1.40 inches)
Width	338.4 mm (13.32 inches)
Depth	273 mm (10.75 inches)

## Weight:

With travel module and standard battery	2.51 kg (5.53 lb)
With CD drive and standard battery	2.72 kg (5.99 lb)

---

**Computer Environmental**

---

## Temperature range:

Operating	0° to 35°C (32° to 95°F)
Storage	-40° to 65°C (-40° to 149°F)

## Relative humidity (maximum):

Operating	10% to 90% (noncondensing)
Storage	5% to 95% (noncondensing)

## Maximum vibration (using a random-vibration spectrum that simulates user environment):

Operating	0.66 GRMS
Storage	1.30 GRMS

---

## Computer Environmental *(continued)*

---

Maximum shock (measured with hard drive in head-parked position and a 2-ms half-sine pulse):

Operating	122 G
Storage	163 G

Altitude (maximum):

Operating	-15.2 to 3048 m (-50 to 10,000 ft)
Storage	-15.2 to 10,668 m (-50 to 35,000 ft)

## Using the System Setup Program

 **NOTE:** Your operating system may automatically configure most of the options available in system setup, thus overriding options that you set through system setup. (An exception is the **External Hot Key** option, which you can disable or enable only through system setup.) For more information on configuring features for your operating system, see the Help and Support Center.

The system setup screens display the current setup information and settings for your computer, such as:

- System configuration
- Boot order
- Boot (start-up) configuration and docking-device configuration settings
- Basic device-configuration settings
- System security and hard-drive password settings

 **NOTICE:** Unless you are an expert computer user or are directed to do so by Dell technical support, do not change the system setup settings. Certain changes might make your computer work incorrectly.

## Viewing the System Setup Screens

- 1 Turn on (or restart) your computer.
- 2 When the DELL™ logo appears, press <F2> immediately. If you wait too long and the Windows logo appears, continue to wait until you see the Windows desktop. Then shut down your computer and try again.

## System Setup Screens

 **NOTE:** For information about a specific item on a system setup screen, highlight the item and see the Help area on the screen.

On each screen, the system setup options are listed at the left. To the right of each option is the setting or value for that option. You can change settings that appear as white type on the screen. Options or values that you cannot change (because they are determined by the computer) appear less bright.

The upper-right corner of the screen displays help information for the currently highlighted option; the lower-right corner displays information about the computer. System-setup key functions are listed across the bottom of the screen.

## Commonly Used Options

Certain options require that you reboot the computer for new settings to take effect.

### Changing the Boot Sequence

The *boot sequence*, or *boot order*, tells the computer where to look to find the software needed to start the operating system. You can control the boot sequence and enable/disable devices using the **Boot Order** page of system setup.

 **NOTE:** To change the boot sequence on a one-time-only basis, see "Performing a One-Time Boot."

The **Boot Order** page displays a general list of the bootable devices that may be installed in your computer, including but not limited to the following:

- Diskette Drive
- Modular bay HDD
- Internal HDD
- CD/DVD/CD-RW drive

 **NOTE:** You can only boot (start up) your computer from a CD, CD-RW, or DVD drive installed as a fixed drive. You cannot boot from one of these modules if it is installed in the module bay.

During the boot routine, the computer starts at the top of the list and scans each enabled device for the operating system start-up files. When the computer finds the files, it stops searching and starts the operating system.

To control the boot devices, select (highlight) a device by pressing the down-arrow or up-arrow key, and then enable or disable the device or change its order in the list.

- To enable or disable a device, highlight the item and press the space bar. Enabled items appear as white and display a small triangle to the left; disabled items appear blue or dimmed without a triangle.
- To reorder a device in the list, highlight the device, and then press <u> or <d> (not case-sensitive) to move the highlighted device up or down.

Boot sequence changes take effect as soon as you save the changes and exit system setup.

## Performing a One-Time Boot

You can set a one-time-only boot sequence without entering system setup. (You can also use this procedure to boot the Dell Diagnostics on the diagnostics utility partition on your hard drive.)

- 1 Shut down the computer through the **Start** menu.
- 2 If the computer is connected to a docking device (docked), undock it. See the documentation that came with your docking device for instructions.
- 3 Connect the computer to an electrical outlet.
- 4 Turn on the computer. When the DELL logo appears, press <F12> immediately. If you wait too long and the Windows logo appears, continue to wait until you see the Windows desktop. Then shut down your computer and try again.
- 5 When the boot device list appears, highlight the device from which you want to boot and press <Enter>.

The computer boots to the selected device.

The next time you reboot the computer, the previous boot order is restored.

## Changing Printer Modes

Set the **Parallel Mode** option according to the type of printer or device connected to the parallel connector. To determine the correct mode to use, see the documentation that came with the device.

Setting **Parallel Mode** to **Disabled** disables the parallel port and the port's LPT address, which frees computer resources for another device to use.

## Changing COM Ports

**Serial Port** allows you to map the serial port COM address or disable the serial port and its address, which frees computer resources for another device to use.

## Enabling the Infrared Sensor

- 1 Enter system setup:
    - a Turn on your computer.
    - b Press <F2> when the Dell™ logo appears.
  - 2 Press <Alt><P> until you locate **Infrared Data Port** under **Basic Device Configuration**.
-  **NOTE:** Ensure that the COM port that you select is different from the COM port assigned to the serial connector.
- 3 Press the down-arrow key to select the **Infrared Data Port** setting, and press the right-arrow key to change the setting to a COM port.

- 4 Press the down-arrow key to select the **Infrared Mode** setting, and press the right-arrow key to change the setting to **Fast IR** or **Slow IR**.

It is recommended that you use **Fast IR**. If the infrared device cannot communicate with your computer, shut down the computer and repeat steps 1 through 5 to change the setting to **Slow IR**.

- 5 Press <Esc> and then click **Yes** to save the changes and exit the system setup program. If you are prompted to restart your computer, click **Yes**.
- 6 Follow the instructions on the screen.
- 7 After the infrared sensor has been enabled, click **Yes** to restart the computer.

 **NOTE:** If neither **Fast IR** nor **Slow IR** work, contact the infrared device manufacturer.

After you enable the infrared sensor, you can use it to establish a link to an infrared device. To set up and use an infrared device, see the infrared device documentation and the Microsoft® Windows® XP Help and Support Center.

## FCC Notices (U.S. Only)

Most Dell computers are classified by the Federal Communications Commission (FCC) as Class B digital devices. To determine which classification applies to your computer, examine all FCC registration labels located on the bottom, side, or back panel of your computer, on card-mounting brackets, and on the cards themselves. If any one of the labels carries a Class A rating, your entire computer is considered to be a Class A digital device. If *all* labels carry an FCC Class B rating as distinguished by either an FCC ID number or the FCC logo, (FCC), your computer is considered to be a Class B digital device.

Once you have determined your computer's FCC classification, read the appropriate FCC notice. Note that FCC regulations provide that changes or modifications not expressly approved by Dell could void your authority to operate this equipment.

This device complies with Part 15 of the FCC Rules. Operation is subject to the following two conditions:

- This device may not cause harmful interference.
- This device must accept any interference received, including interference that may cause undesired operation.

### Class A

This equipment has been tested and found to comply with the limits for a Class A digital device pursuant to Part 15 of the FCC Rules. These limits are designed to provide reasonable protection against harmful interference when the equipment is operated in a commercial environment. This equipment generates, uses, and can radiate radio frequency energy and, if not installed and used in accordance with the manufacturer's instruction manual, may cause

harmful interference with radio communications. Operation of this equipment in a residential area is likely to cause harmful interference, in which case you will be required to correct the interference at your own expense.

### **Class B**

This equipment has been tested and found to comply with the limits for a Class B digital device pursuant to Part 15 of the FCC Rules. These limits are designed to provide reasonable protection against harmful interference in a residential installation. This equipment generates, uses, and can radiate radio frequency energy and, if not installed and used in accordance with the manufacturer's instruction manual, may cause interference with radio communications. However, there is no guarantee that interference will not occur in a particular installation. If this equipment does cause harmful interference to radio or television reception, which can be determined by turning the equipment off and on, you are encouraged to try to correct the interference by one or more of the following measures:

- Reorient or relocate the receiving antenna.
- Increase the separation between the equipment and the receiver.
- Connect the equipment into an outlet on a circuit different from that to which the receiver is connected.
- Consult the dealer or an experienced radio/television technician for help.

### **FCC Identification Information**

The following information is provided on the device or devices covered in this document in compliance with FCC regulations:

- Model number: PP10L
- Company name:

Dell Inc.  
One Dell Way  
Round Rock, Texas 78682 USA  
512-338-4400

## NOM Information (Mexico Only)

The following information is provided on the device(s) described in this document in compliance with the requirements of the official Mexican standards (NOM):

Exporter:	Dell Inc. One Dell Way Round Rock, TX 78682
Importer:	Dell Computer de México, S.A. de C.V. Paseo de la Reforma 2620 - 11° Piso Col. Lomas Altas 11950 México, D.F.
Ship to:	Dell Computer de México, S.A. de C.V. al Cuidado de Kuehne & Nagel de México S. de R.L. Avenida Soles No. 55 Col. Peñon de los Baños 15520 México, D.F.
Model number:	PP10L
Supply voltage:	100–240 VAC
Frequency:	50–60 Hz
Current Consumption:	1.5 A
Output voltage:	19.5 VDC
Output current:	4.62 A

## Contacting Dell

To contact Dell electronically, you can access the following websites:

- [www.dell.com](http://www.dell.com)
- [support.dell.com](http://support.dell.com) (technical support)
- [premiersupport.dell.com](http://premiersupport.dell.com) (technical support for educational, government, healthcare, and medium/large business customers, including Premier, Platinum, and Gold customers)

For specific web addresses for your country, find the appropriate country section in the table below.

**NOTE:** Toll-free numbers are for use within the country for which they are listed.

**NOTE:** In certain countries, technical support specific to Dell Inspiron™ XPS computers is available at a separate telephone number listed for participating countries. If you do not see a telephone number listed that is specific for Inspiron XPS computers, you may contact Dell through the technical support number listed and your call will be routed appropriately.



When you need to contact Dell, use the electronic addresses, telephone numbers, and codes provided in the following table. If you need assistance in determining which codes to use, contact a local or an international operator.

<b>Country (City) International Access Code Country Code City Code</b>	<b>Department Name or Service Area, Website and E-Mail Address</b>	<b>Area Codes, Local Numbers, and Toll-Free Numbers</b>
Anguilla	General Support	toll-free: 800-335-0031
Antigua and Barbuda	General Support	1-800-805-5924
Argentina (Buenos Aires) International Access Code: 00 Country Code: 54 City Code: 11	Website: <a href="http://www.dell.com.ar">www.dell.com.ar</a> E-mail: <a href="mailto:us_latin_services@dell.com">us_latin_services@dell.com</a> E-mail for desktop and portable computers: <a href="mailto:la-techsupport@dell.com">la-techsupport@dell.com</a> E-mail for servers and EMC <sup>®</sup> storage products: <a href="mailto:la_enterprise@dell.com">la_enterprise@dell.com</a> Customer Care Tech Support Tech Support Services Sales	toll-free: 0-800-444-0730 toll-free: 0-800-444-0733 toll-free: 0-800-444-0724 0-810-444-3355
Aruba	General Support	toll-free: 800-1578
Australia (Sydney) International Access Code: 0011 Country Code: 61 City Code: 2	E-mail (Australia): <a href="mailto:au_tech_support@dell.com">au_tech_support@dell.com</a> E-mail (New Zealand): <a href="mailto:nz_tech_support@dell.com">nz_tech_support@dell.com</a> Home and Small Business Government and Business Preferred Accounts Division (PAD) Customer Care Technical Support (portables and desktops) Technical Support (servers and workstations) Corporate Sales Transaction Sales Fax	1-300-655-533 toll-free: 1-800-633-559 toll-free: 1-800-060-889 toll-free: 1-800-819-339 toll-free: 1-300-655-533 toll-free: 1-800-733-314 toll-free: 1-800-808-385 toll-free: 1-800-808-312 toll-free: 1-800-818-341

<b>Country (City) International Access Code Country Code City Code</b>	<b>Department Name or Service Area, Website and E-Mail Address</b>	<b>Area Codes, Local Numbers, and Toll-Free Numbers</b>
<b>Austria (Vienna)</b>	Website: <a href="http://support.euro.dell.com">support.euro.dell.com</a>	
International Access Code: 900	E-mail: <a href="mailto:tech_support_central_europe@dell.com">tech_support_central_europe@dell.com</a>	
Country Code: 43	Home/Small Business Sales	0820 240 530 00
City Code: 1	Home/Small Business Fax	0820 240 530 49
	Home/Small Business Customer Care	0820 240 530 14
	Preferred Accounts/Corporate Customer Care	0820 240 530 16
	Home/Small Business Technical Support	0820 240 530 14
	Preferred Accounts/Corporate Technical Support	0660 8779
	Switchboard	0820 240 530 00
<b>Bahamas</b>	General Support	toll-free: 1-866-278-6818
<b>Barbados</b>	General Support	1-800-534-3066
<b>Belgium (Brussels)</b>	Website: <a href="http://support.euro.dell.com">support.euro.dell.com</a>	
International Access Code: 00	E-mail for French-speaking Customers: <a href="http://support.euro.dell.com/be/fr/emaildell/">support.euro.dell.com/be/fr/emaildell/</a>	
Country Code: 32	Technical Support for Inspiron XPS computers only	02 481 92 96
City Code: 2	Technical Support for all other Dell computers	02 481 92 88
	Technical Support Fax	02 481 92 95
	Customer Care	02 713 15 .65
	Corporate Sales	02 481 91 00
	Fax	02 481 92 99
	Switchboard	02 481 91 00
<b>Bermuda</b>	General Support	1-800-342-0671
<b>Bolivia</b>	General Support	toll-free: 800-10-0238
<b>Brazil</b>	Website: <a href="http://www.dell.com/br">www.dell.com/br</a>	
International Access Code: 00	Customer Support, Technical Support	0800 90 3355
Country Code: 55	Technical Support Fax	51 481 5470
City Code: 51	Customer Care Fax	51 481 5480
	Sales	0800 90 3390
<b>British Virgin Islands</b>	General Support	toll-free: 1-866-278-6820

<b>Country (City) International Access Code Country Code City Code</b>	<b>Department Name or Service Area, Website and E-Mail Address</b>	<b>Area Codes, Local Numbers, and Toll-Free Numbers</b>
Brunei	Customer Technical Support (Penang, Malaysia)	604 633 4966
Country Code: 673	Customer Service (Penang, Malaysia)	604 633 4949
	Transaction Sales (Penang, Malaysia)	604 633 4955
Canada (North York, Ontario)	Online Order Status: <a href="http://www.dell.ca/ostatus">www.dell.ca/ostatus</a>	
International Access Code: 011	AutoTech (automated technical support)	toll-free: 1-800-247-9362
	Customer Care (Home Sales/Small Business)	toll-free: 1-800-847-4096
	Customer Care (med./large business, government)	toll-free: 1-800-326-9463
	Technical Support (Home Sales/Small Business)	toll-free: 1-800-847-4096
	Technical Support (med./large bus., government)	toll-free: 1-800-387-5757
	Technical Support (printers, projectors, televisions, handhelds, digital jukebox, and wireless)	1-877-335-5767
	Sales (Home Sales/Small Business)	toll-free: 1-800-387-5752
	Sales (med./large bus., government)	toll-free: 1-800-387-5755
	Spare Parts Sales & Extended Service Sales	1 866 440 3355
Cayman Islands	General Support	1-800-805-7541
Chile (Santiago)	Sales, Customer Support, and Technical Support	toll-free: 1230-020-4823
Country Code: 56		
City Code: 2		

<b>Country (City) International Access Code Country Code City Code</b>	<b>Department Name or Service Area, Website and E-Mail Address</b>	<b>Area Codes, Local Numbers, and Toll-Free Numbers</b>
China (Xiamen) Country Code: 86 City Code: 592	Technical Support website: support.dell.com.cn Technical Support E-mail: cn_support@dell.com Customer Care E-mail: customer_cn@dell.com Technical Support Fax Technical Support (Dell™ Dimension™ and Inspiron) Technical Support (OptiPlex™, Latitude™, and Dell Precision™) Technical Support (servers and storage) Technical Support (projectors, PDAs, switches, routers, and so on) Technical Support (printers) Customer Care Customer Care Fax Home and Small Business Preferred Accounts Division Large Corporate Accounts GCP Large Corporate Accounts Key Accounts Large Corporate Accounts North Large Corporate Accounts North Government and Education Large Corporate Accounts East Large Corporate Accounts East Government and Education Large Corporate Accounts Queue Team Large Corporate Accounts South Large Corporate Accounts West Large Corporate Accounts Spare Parts	592 818 1350 toll-free: 800 858 2969 toll-free: 800 858 0950 toll-free: 800 858 0960 toll-free: 800 858 2920 toll-free: 800 858 2311 toll-free: 800 858 2060 592 818 1308 toll-free: 800 858 2222 toll-free: 800 858 2557 toll-free: 800 858 2055 toll-free: 800 858 2628 toll-free: 800 858 2999 toll-free: 800 858 2955 toll-free: 800 858 2020 toll-free: 800 858 2669 toll-free: 800 858 2572 toll-free: 800 858 2355 toll-free: 800 858 2811 toll-free: 800 858 2621
Colombia	General Support	980-9-15-3978
Costa Rica	General Support	0800-012-0435

<b>Country (City) International Access Code Country Code City Code</b>	<b>Department Name or Service Area, Website and E-Mail Address</b>	<b>Area Codes, Local Numbers, and Toll-Free Numbers</b>
Czech Republic (Prague)	Website: support.euro.dell.com	
International Access Code: 00	E-mail: czech_dell@dell.com	
Country Code: 420	Technical Support	22537 2727
	Customer Care	22537 2707
	Fax	22537 2714
	Tech Fax	22537 2728
	Switchboard	22537 2711
Denmark (Copenhagen)	Website: support.euro.dell.com	
International Access Code: 00	E-mail: support.euro.dell.com/dk/da/emaildell/	
Country Code: 45	Technical Support for Inspiron XPS computers only	7010 0074
	Technical Support for all other Dell computers	7023 0182
	Customer Care (Relational)	7023 0184
	Home/Small Business Customer Care	3287 5505
	Switchboard (Relational)	3287 1200
	Switchboard Fax (Relational)	3287 1201
	Switchboard (Home/Small Business)	3287 5000
	Switchboard Fax (Home/Small Business)	3287 5001
Dominica	General Support	toll-free: 1-866-278-6821
Dominican Republic	General Support	1-800-148-0530
Ecuador	General Support	toll-free: 999-119
El Salvador	General Support	01-899-753-0777
Finland (Helsinki)	Website: support.euro.dell.com	
International Access Code: 990	E-mail: support.euro.dell.com/fi/fi/emaildell/	
Country Code: 358	Technical Support	09 253 313 60
City Code: 9	Customer Care	09 253 313 38
	Fax	09 253 313 99
	Switchboard	09 253 313 00

<b>Country (City) International Access Code Country Code City Code</b>	<b>Department Name or Service Area, Website and E-Mail Address</b>	<b>Area Codes, Local Numbers, and Toll-Free Numbers</b>
France (Paris) (Montpellier) International Access Code: 00 Country Code: 33 City Codes: (1) (4)	Website: support.euro.dell.com	
	E-mail: support.euro.dell.com/fr/fr/emaildell/	
	<b>Home and Small Business</b>	
	Technical Support for Inspiron XPS computers only	0825 387 129
	Technical Support for all other Dell computers	0825 387 270
	Customer Care	0825 823 833
	Switchboard	0825 004 700
	Switchboard (calls from outside of France)	04 99 75 40 00
	Sales	0825 004 700
	Fax	0825 004 701
	Fax (calls from outside of France)	04 99 75 40 01
	<b>Corporate</b>	
	Technical Support	0825 004 719
	Customer Care	0825 338 339
	Switchboard	01 55 94 71 00
Sales	01 55 94 71 00	
Fax	01 55 94 71 01	
Germany (Langen) International Access Code: 00 Country Code: 49 City Code: 6103	Website: support.euro.dell.com	
	E-mail: tech_support_central_europe@dell.com	
	Technical Support for Inspiron XPS computers only	06103 766-7222
	Technical Support for all other Dell computers	06103 766-7200
	Home/Small Business Customer Care	0180-5-224400
	Global Segment Customer Care	06103 766-9570
	Preferred Accounts Customer Care	06103 766-9420
	Large Accounts Customer Care	06103 766-9560
	Public Accounts Customer Care	06103 766-9555
	Switchboard	06103 766-7000

<b>Country (City) International Access Code Country Code City Code</b>	<b>Department Name or Service Area, Website and E-Mail Address</b>	<b>Area Codes, Local Numbers, and Toll-Free Numbers</b>
<b>Greece</b>	Website: <a href="http://support.euro.dell.com">support.euro.dell.com</a>	
International Access Code: 00	E-mail: <a href="mailto:support.euro.dell.com/gr/en/emaildell/">support.euro.dell.com/gr/en/emaildell/</a>	
Country Code: 30	Technical Support	00800-44 14 95 18
	Gold Service Technical Support	00800-44 14 00 83
	Switchboard	2108129810
	Gold Service Switchboard	2108129811
	Sales	2108129800
	Fax	2108129812
<b>Grenada</b>	General Support	toll-free: 1-866-540-3355
<b>Guatemala</b>	General Support	1-800-999-0136
<b>Guyana</b>	General Support	toll-free: 1-877-270-4609
<b>Hong Kong</b>	Website: <a href="http://support.ap.dell.com">support.ap.dell.com</a>	
International Access Code: 001	Technical Support E-mail: <a href="mailto:apsupport@dell.com">apsupport@dell.com</a>	
Country Code: 852	Technical Support (Dimension and Inspiron)	2969 3188
	Technical Support (OptiPlex, Latitude, and Dell Precision)	2969 3191
	Technical Support (PowerApp™, PowerEdge™, PowerConnect™, and PowerVault™)	2969 3196
	Customer Care	3416 0910
	Large Corporate Accounts	3416 0907
	Global Customer Programs	3416 0908
	Medium Business Division	3416 0912
	Home and Small Business Division	2969 3105
<b>India</b>	Technical Support	1600 33 8045
	Sales (Large Corporate Accounts)	1600 33 8044
	Sales (Home and Small Business)	1600 33 8046

<b>Country (City) International Access Code Country Code City Code</b>	<b>Department Name or Service Area, Website and E-Mail Address</b>	<b>Area Codes, Local Numbers, and Toll-Free Numbers</b>
<b>Ireland (Cherrywood)</b>	Website: <a href="http://support.euro.dell.com">support.euro.dell.com</a>	
International Access Code: 16	E-mail: <a href="mailto:dell_direct_support@dell.com">dell_direct_support@dell.com</a>	
Country Code: 353	Technical Support for Inspiron XPS computers only	1850 200 722
City Code: 1	Technical Support for all other Dell computers	1850 543 543
	U.K. Technical Support (dial within U.K. only)	0870 908 0800
	Home User Customer Care	01 204 4014
	Small Business Customer Care	01 204 4014
	U.K. Customer Care (dial within U.K. only)	0870 906 0010
	Corporate Customer Care	1850 200 982
	Corporate Customer Care (dial within U.K. only)	0870 907 4499
	Ireland Sales	01 204 4444
	U.K. Sales (dial within U.K. only)	0870 907 4000
	Fax/Sales Fax	01 204 0103
	Switchboard	01 204 4444
<b>Italy (Milan)</b>	Website: <a href="http://support.euro.dell.com">support.euro.dell.com</a>	
International Access Code: 00	E-mail: <a href="http://support.euro.dell.com/it/it/emaildell/">support.euro.dell.com/it/it/emaildell/</a>	
Country Code: 39	<b>Home and Small Business</b>	
City Code: 02	Technical Support	02 577 826 90
	Customer Care	02 696 821 14
	Fax	02 696 821 13
	Switchboard	02 696 821 12
	<b>Corporate</b>	
	Technical Support	02 577 826 90
	Customer Care	02 577 825 55
	Fax	02 575 035 30
	Switchboard	02 577 821
<b>Jamaica</b>	General Support (dial from within Jamaica only)	1-800-682-3639



<b>Country (City) International Access Code Country Code City Code</b>	<b>Department Name or Service Area, Website and E-Mail Address</b>	<b>Area Codes, Local Numbers, and Toll-Free Numbers</b>
Japan (Kawasaki)	Website: support.jp.dell.com	
International Access Code: 001	Technical Support (servers)	toll-free: 0120-198-498
Country Code: 81	Technical Support outside of Japan (servers)	81-44-556-4162
City Code: 44	Technical Support (Dimension and Inspiron)	toll-free: 0120-198-226
	Technical Support outside of Japan (Dimension and Inspiron)	81-44-520-1435
	Technical Support (Dell Precision, OptiPlex, and Latitude)	toll-free:0120-198-433
	Technical Support outside of Japan (Dell Precision, OptiPlex, and Latitude)	81-44-556-3894
	Technical Support (PDAs, projectors, printers, routers)	toll-free: 0120-981-690
	Technical Support outside of Japan (PDAs, projectors, printers, routers)	81-44-556-3468
	Faxbox Service	044-556-3490
	24-Hour Automated Order Service	044-556-3801
	Customer Care	044-556-4240
	Business Sales Division (up to 400 employees)	044-556-1465
	Preferred Accounts Division Sales (over 400 employees)	044-556-3433
	Large Corporate Accounts Sales (over 3500 employees)	044-556-3430
	Public Sales (government agencies, educational institutions, and medical institutions)	044-556-1469
	Global Segment Japan	044-556-3469
	Individual User	044-556-1760
	Switchboard	044-556-4300
<b>Korea (Seoul)</b>	Technical Support	toll-free: 080-200-3800
International Access Code: 001	Sales	toll-free: 080-200-3600
Country Code: 82	Customer Service (Penang, Malaysia)	604 633 4949
City Code: 2	Fax	2194-6202
	Switchboard	2194-6000
	Technical Support (Electronics and Accessories)	toll-free: 080-200-3801

<b>Country (City) International Access Code Country Code City Code</b>	<b>Department Name or Service Area, Website and E-Mail Address</b>	<b>Area Codes, Local Numbers, and Toll-Free Numbers</b>
<b>Latin America</b>	Customer Technical Support (Austin, Texas, U.S.A.)	512 728-4093
	Customer Service (Austin, Texas, U.S.A.)	512 728-3619
	Fax (Technical Support and Customer Service) (Austin, Texas, U.S.A.)	512 728-3883
	Sales (Austin, Texas, U.S.A.)	512 728-4397
	SalesFax (Austin, Texas, U.S.A.)	512 728-4600 or 512 728-3772
<b>Luxembourg</b>	Website: <a href="http://support.euro.dell.com">support.euro.dell.com</a>	
International Access Code: 00	E-mail: <a href="mailto:tech_be@dell.com">tech_be@dell.com</a>	
Country Code: 352	Technical Support (Brussels, Belgium)	3420808075
	Home/Small Business Sales (Brussels, Belgium)	toll-free: 080016884
	Corporate Sales (Brussels, Belgium)	02 481 91 00
	Customer Care (Brussels, Belgium)	02 481 91 19
	Fax (Brussels, Belgium)	02 481 92 99
	Switchboard (Brussels, Belgium)	02 481 91 00
<b>Macao</b>	Technical Support	toll-free: 0800 105
Country Code: 853	Customer Service (Xiamen, China)	34 160 910
	Transaction Sales (Xiamen, China)	29 693 115
<b>Malaysia (Penang)</b>	Website: <a href="http://support.ap.dell.com">support.ap.dell.com</a>	
International Access Code: 00	Technical Support (Dell Precision, OptiPlex, and Latitude)	toll-free: 1 800 88 0193
Country Code: 60	Technical Support (Dimension, Inspiron, and Electronics and Accessories)	toll-free: 1 800 88 1306
City Code: 4	Technical Support (PowerApp, PowerEdge, PowerConnect, and PowerVault)	toll-free: 1800 88 1386
	Customer Service (Penang, Malaysia)	04 633 4949
	Transaction Sales	toll-free: 1 800 888 202
	Corporate Sales	toll-free: 1 800 888 213

<b>Country (City) International Access Code Country Code City Code</b>	<b>Department Name or Service Area, Website and E-Mail Address</b>	<b>Area Codes, Local Numbers, and Toll-Free Numbers</b>
Mexico	Customer Technical Support	001-877-384-8979
International Access Code: 00		or 001-877-269-3383
Country Code: 52	Sales	50-81-8800
		or 01-800-888-3355
	Customer Service	001-877-384-8979
		or 001-877-269-3383
	Main	50-81-8800
		or 01-800-888-3355
Montserrat	General Support	toll-free: 1-866-278-6822
Netherlands Antilles	General Support	001-800-882-1519
Netherlands (Amsterdam)	Website: <a href="http://support.euro.dell.com">support.euro.dell.com</a>	
International Access Code: 00	Technical Support for Inspiron XPS computers only	020 674 45 94
Country Code: 31	Technical Support for all other Dell computers	020 674 45 00
City Code: 20	Technical Support Fax	020 674 47 66
	Home/Small Business Customer Care	020 674 42 00
	Relational Customer Care	020 674 4325
	Home/Small Business Sales	020 674 55 00
	Relational Sales	020 674 50 00
	Home/Small Business Sales Fax	020 674 47 75
	Relational Sales Fax	020 674 47 50
	Switchboard	020 674 50 00
	Switchboard Fax	020 674 47 50
New Zealand	E-mail (New Zealand): <a href="mailto:nz_tech_support@dell.com">nz_tech_support@dell.com</a>	
International Access Code: 00	E-mail (Australia): <a href="mailto:au_tech_support@dell.com">au_tech_support@dell.com</a>	
Country Code: 64	Technical Support (for desktop and portable computers)	toll-free: 0800 446 255
	Technical Support (for servers and workstations)	toll-free: 0800 443 563
	Home and Small Business	0800 446 255
	Government and Business	0800 444 617
	Sales	0800 441 567
	Fax	0800 441 566

<b>Country (City) International Access Code Country Code City Code</b>	<b>Department Name or Service Area, Website and E-Mail Address</b>	<b>Area Codes, Local Numbers, and Toll-Free Numbers</b>
Nicaragua	General Support	001-800-220-1006
Norway (Lysaker)	Website: <a href="http://support.euro.dell.com">support.euro.dell.com</a>	
International Access Code: 00	E-mail: <a href="mailto:support.euro.dell.com/no/no/emaildell/">support.euro.dell.com/no/no/emaildell/</a>	
Country Code: 47	Technical Support	671 16882
	Relational Customer Care	671 17575
	Home/Small Business Customer Care	23162298
	Switchboard	671 16800
	Fax Switchboard	671 16865
Panama	General Support	001-800-507-0962
Peru	General Support	0800-50-669
Poland (Warsaw)	Website: <a href="http://support.euro.dell.com">support.euro.dell.com</a>	
International Access Code: 011	E-mail: <a href="mailto:pl_support_tech@dell.com">pl_support_tech@dell.com</a>	
Country Code: 48	Customer Service Phone	57 95 700
City Code: 22	Customer Care	57 95 999
	Sales	57 95 999
	Customer Service Fax	57 95 806
	Reception Desk Fax	57 95 998
	Switchboard	57 95 999
Portugal	Website: <a href="http://support.euro.dell.com">support.euro.dell.com</a>	
International Access Code: 00	E-mail: <a href="mailto:support.euro.dell.com/pt/en/emaildell/">support.euro.dell.com/pt/en/emaildell/</a>	
Country Code: 351	Technical Support	707200149
	Customer Care	800 300 413
	Sales	800 300 410 or 800 300 411 or 800 300 412 or 21 422 07 10
	Fax	21 424 01 12
Puerto Rico	General Support	1-800-805-7545
St. Kitts and Nevis	General Support	toll-free: 1-877-441-4731
St. Lucia	General Support	1-800-882-1521
St. Vincent and the Grenadines	General Support	toll-free: 1-877-270-4609

<b>Country (City) International Access Code Country Code City Code</b>	<b>Department Name or Service Area, Website and E-Mail Address</b>	<b>Area Codes, Local Numbers, and Toll-Free Numbers</b>
Singapore (Singapore)	Website: support.ap.dell.com	
International Access Code: 005	Technical Support (Dimension, Inspiron, and Electronics and Accessories)	toll-free: 1800 394 7430
Country Code: 65	Technical Support (OptiPlex, Latitude, and Dell Precision)	toll-free: 1800 394 7488
	Technical Support (PowerApp, PowerEdge, PowerConnect, and PowerVault)	toll-free: 1800 394 7478
	Customer Service (Penang, Malaysia)	604 633 4949
	Transaction Sales	toll-free: 1 800 394 7412
	Corporate Sales	toll-free: 1 800 394 7419
Slovakia (Prague)	Website: support.euro.dell.com	
International Access Code: 00	E-mail: czech_dell@dell.com	
Country Code: 421	Technical Support	02 5441 5727
	Customer Care	420 22537 2707
	Fax	02 5441 8328
	Tech Fax	02 5441 8328
	Switchboard (Sales)	02 5441 7585
South Africa (Johannesburg)	Website: support.euro.dell.com	
International Access Code: 09/091	E-mail: dell_za_support@dell.com	
Country Code: 27	Gold Queue	011 709 7713
City Code: 11	Technical Support	011 709 7710
	Customer Care	011 709 7707
	Sales	011 709 7700
	Fax	011 706 0495
	Switchboard	011 709 7700
Southeast Asian and Pacific Countries	Customer Technical Support, Customer Service, and Sales (Penang, Malaysia)	604 633 4810

<b>Country (City) International Access Code Country Code City Code</b>	<b>Department Name or Service Area, Website and E-Mail Address</b>	<b>Area Codes, Local Numbers, and Toll-Free Numbers</b>
Spain (Madrid)	Website: <a href="http://support.euro.dell.com">support.euro.dell.com</a>	
International Access Code: 00	E-mail: <a href="mailto:support.euro.dell.com/es/es/emaildell/">support.euro.dell.com/es/es/emaildell/</a>	
Country Code: 34	<b>Home and Small Business</b>	
City Code: 91	Technical Support	902 100 130
	Customer Care	902 118 540
	Sales	902 118 541
	Switchboard	902 118 541
	Fax	902 118 539
	<b>Corporate</b>	
	Technical Support	902 100 130
	Customer Care	902 115 236
	Switchboard	91 722 92 00
	Fax	91 722 95 83
Sweden (Upplands Vasby)	Website: <a href="http://support.euro.dell.com">support.euro.dell.com</a>	
International Access Code: 00	E-mail: <a href="mailto:support.euro.dell.com/se/sv/emaildell/">support.euro.dell.com/se/sv/emaildell/</a>	
Country Code: 46	Technical Support	08 590 05 199
City Code: 8	Relational Customer Care	08 590 05 642
	Home/Small Business Customer Care	08 587 70 527
	Employee Purchase Program (EPP) Support	20 140 14 44
	Technical Support Fax	08 590 05 594
	Sales	08 590 05 185
Switzerland (Geneva)	Website: <a href="http://support.euro.dell.com">support.euro.dell.com</a>	
International Access Code: 00	E-mail: <a href="mailto:Tech_support_central_Europe@dell.com">Tech_support_central_Europe@dell.com</a>	
Country Code: 41	E-mail for French-speaking HSB and Corporate Customers: <a href="mailto:support.euro.dell.com/ch/fr/emaildell/">support.euro.dell.com/ch/fr/emaildell/</a>	
City Code: 22	Technical Support (Home and Small Business)	0844 811 411
	Technical Support (Corporate)	0844 822 844
	Customer Care (Home and Small Business)	0848 802 202
	Customer Care (Corporate)	0848 821 721
	Fax	022 799 01 90
	Switchboard	022 799 01 01

<b>Country (City) International Access Code Country Code City Code</b>	<b>Department Name or Service Area, Website and E-Mail Address</b>	<b>Area Codes, Local Numbers, and Toll-Free Numbers</b>
Taiwan	Website: <a href="http://support.ap.dell.com">support.ap.dell.com</a>	
International Access Code: 002	E-mail: <a href="mailto:ap_support@dell.com">ap_support@dell.com</a>	
Country Code: 886	Technical Support (OptiPlex, Latitude, Inspiron, Dimension, and Electronics and Accessories)	toll-free: 00801 86 1011
	Technical Support (PowerApp, PowerEdge, PowerConnect, and PowerVault)	toll-free: 00801 60 1256
	Transaction Sales	toll-free: 00801 65 1228
	Corporate Sales	toll-free: 00801 651 227
Thailand	Website: <a href="http://support.ap.dell.com">support.ap.dell.com</a>	
International Access Code: 001	Technical Support (OptiPlex, Latitude, and Dell Precision)	toll-free: 1800 0060 07
Country Code: 66	Technical Support (PowerApp, PowerEdge, PowerConnect, and PowerVault)	toll-free: 1800 0600 09
	Customer Service (Penang, Malaysia)	604 633 4949
	Corporate Sales	toll-free: 1800 006 009
	Transaction Sales	toll-free: 1800 006 006
Trinidad/Tobago	General Support	1-800-805-8035
Turks and Caicos Islands	General Support	toll-free: 1-866-540-3355

<b>Country (City) International Access Code Country Code City Code</b>	<b>Department Name or Service Area, Website and E-Mail Address</b>	<b>Area Codes, Local Numbers, and Toll-Free Numbers</b>
U.K. (Bracknell)	Website: <a href="http://support.euro.dell.com">support.euro.dell.com</a>	
International Access Code: 00	Customer Care website: <a href="http://support.euro.dell.com/uk/en/ECare/Form/Home.asp">support.euro.dell.com/uk/en/ECare/Form/Home.asp</a>	
Country Code: 44		
City Code: 1344	E-mail: <a href="mailto:dell_direct_support@dell.com">dell_direct_support@dell.com</a>	
	Technical Support (Corporate/Preferred Accounts/PAD [1000+ employees])	0870 908 0500
	Technical Support (direct and general)	0870 908 0800
	Global Accounts Customer Care	01344 373 186
	Home and Small Business Customer Care	0870 906 0010
	Corporate Customer Care	01344 373 185
	Preferred Accounts (500–5000 employees) Customer Care	0870 906 0010
	Central Government Customer Care	01344 373 193
	Local Government & Education Customer Care	01344 373 199
	Health Customer Care	01344 373 194
	Home and Small Business Sales	0870 907 4000
	Corporate/Public Sector Sales	01344 860 456
	Home and Small Business Fax	0870 907 4006
Uruguay	General Support	toll-free: 000-413-598-2521



<b>Country (City) International Access Code Country Code City Code</b>	<b>Department Name or Service Area, Website and E-Mail Address</b>	<b>Area Codes, Local Numbers, and Toll-Free Numbers</b>
U.S.A. (Austin, Texas)	Automated Order-Status Service	toll-free: 1-800-433-9014
International Access Code: 011 Country Code: 1	AutoTech (portable and desktop computers) <b>Consumer</b> (Home and Home Office) Technical Support Customer Service DellNet™ Service and Support  Employee Purchase Program (EPP) Customers Financial Services website: <a href="http://www.dellfinancialservices.com">www.dellfinancialservices.com</a> Financial Services (lease/loans) Financial Services (Dell Preferred Accounts [DPA]) <b>Business</b> Customer Service and Technical Support Employee Purchase Program (EPP) Customers Printers and Projectors Technical Support <b>Public</b> (government, education, and healthcare) Customer Service and Technical Support Employee Purchase Program (EPP) Customers Dell Sales  Dell Outlet Store (Dell refurbished computers) Software and Peripherals Sales Spare Parts Sales Extended Service and Warranty Sales Fax Dell Services for the Deaf, Hard-of-Hearing, or Speech-Impaired	toll-free: 1-800-247-9362  toll-free: 1-800-624-9896 toll-free: 1-800-624-9897 toll-free: 1-877-Dellnet (1-877-335-5638) toll-free: 1-800-695-8133  toll-free: 1-877-577-3355 toll-free: 1-800-283-2210  toll-free: 1-800-822-8965 toll-free: 1-800-695-8133 toll-free: 1-877-459-7298  toll-free: 1-800-456-3355 toll-free: 1-800-234-1490 toll-free: 1-800-289-3355 or toll-free: 1-800-879-3355 toll-free: 1-888-798-7561 toll-free: 1-800-671-3355 toll-free: 1-800-357-3355 toll-free: 1-800-247-4618 toll-free: 1-800-727-8320 toll-free: 1-877-DELLTTY (1-877-335-5889)
U.S. Virgin Islands	General Support	1-877-673-3355
Venezuela	General Support	8001-3605



# Index

## A

- audio connectors
  - description, 17
  - system view, 17

## B

- battery
  - charge gauge, 35
  - charging, 35
  - checking the charge, 34
  - description, 23
  - installing, 36
  - performance, 33
  - power meter, 35
  - removing, 36
  - storing, 38
  - system view, 23
- Bluetooth card
  - replacing, 98

## C

- CD, 54
  - using, 49
- CD-RW drive
  - fixing problems, 52
- characters
  - unexpected, 48

- computer
  - crashes, 76
  - restore to previous state, 81
  - specifications, 101
- conflicts
  - software and hardware incompatibilities, 80
- copying CDs
  - general information, 54
  - helpful tips, 55
  - how to copy a CD, 54
- crashes, 76

## D

- damaged computer
  - testing, 78
- Dell
  - contacting, 112
  - support site, 11
- Dell Diagnostics, 84
- Dell Premier Support
  - website, 9, 11
- device latch release
  - description, 18, 23
  - system view, 18, 23
- device status lights, 14
  - description, 14
- diagnostics
  - Dell, 84

- display
  - description, 13
  - system view, 13
- display latch
  - description, 15
  - system view, 15
- docking device latch
  - description, 23
  - system view, 23
- documentation
  - help file, 9
  - online, 11
  - Setup Diagram, 9
  - System Information Guide, 9
- drivers, 78
  - about, 78
  - identifying, 79
  - reinstalling, 79
- drives
  - fixing problems, 49, 74
  - See hard drive, 94
- DVD, 54
  - using, 49

## F

- fan
  - description, 23
  - system view, 23

- floppy drive
  - connecting to the parallel port, 20
  - fixing problems, 49, 74

## H

- hard drive
  - description, 23
  - replacing, 94
  - returning to Dell, 95
  - system view, 23
- hardware
  - conflicts, 80
  - Dell Diagnostics, 84
- Hardware Troubleshooter, 80
- Help and Support Center, 10
- help file, 9

## I

- Infrared Sensor
  - enabling, 109
- infrared sensor
  - description, 16
  - system view, 16
- installing parts
  - before you begin, 87
  - recommended tools, 87
  - shutting down your computer, 87
- Internet connection
  - about, 25
  - options, 25
  - setting up, 25

- IR sensor
  - description, 16
  - system view, 16
- IRQ conflicts, 80

## K

- keyboard
  - description, 15
  - fixing problems, 48
  - replacing, 96
  - shortcuts, 44
  - system view, 15
  - unexpected characters, 48
- keyboard status lights
  - description, 15
  - system view, 15
- keypad
  - numeric, 43

## L

- labels
  - Microsoft Windows, 10
  - Service Tag, 10

## M

- memory
  - adding, 89
  - removing, 90
- Microsoft Windows label, 10
- Mini PCI card
  - installing, 91

- Mini PCI card, modem, and memory module cover
  - description, 23
  - system view, 23

- modem connector
  - description, 20
  - system view, 20

- module bay
  - about, 41
  - description, 18
  - swapping devices while the computer is running, 42
  - swapping devices while the computer is turned off, 41
  - system view, 18

## N

- network
  - fixing problems, 64
- network connector
  - description, 21
  - system view, 21

## O

- operating system
  - restoring, 81

## P

- parallel connector
  - description, 21
  - system view, 21

- PC Card slot
  - description, 16
  - system view, 16
- pc cards
  - fixing problems, 75
- power
  - fixing problems, 38
  - line conditioners, 31
  - protection devices, 31
  - surge protectors, 31
  - UPS, 31
- power button
  - description, 13
  - system view, 13
- printer
  - cable, 28
  - connecting, 28
  - parallel, 28
  - setting up, 28
  - USB, 29
- problems
  - conflicts, 80
  - Dell Diagnostics, 84
  - restore to previous state, 81
- programs
  - crashes, 76
  - fixing problems, 76
  - not responding, 76

## R

RAM. *See* memory

## S

- safety instructions, 9
- security cable slot
  - description, 17-18
  - system view, 17-18
- serial connector
  - description, 21
  - system view, 21
- Service Tag, 10
- Setup Diagram, 9
- software
  - conflicts, 80
  - fixing problems, 76
- speakers
  - description, 15
  - system view, 15
- specifications, system, 101
- support
  - contacting Dell, 112
- S-video TV-out connector
  - description, 20
  - system view, 20
- System Restore, 81
- system setup program
  - commonly used options, 108
  - purpose, 107
  - screens, 107-108
  - viewing, 107
- system specifications, 101
- system view, 14

- system views
  - back, 19
  - bottom, 19, 23
  - front, 13
  - left side, 16
  - right side, 18

## T

- touch pad, 46
  - description, 15
  - system view, 15
- touch pad and track stick
  - customizing, 47
- track stick/touch pad buttons
  - description, 15
  - system view, 15
- troubleshooting
  - blue screen, 76
  - cannot save to floppy disk, 49, 74
  - CD-RW drive stops
    - writing, 52
  - conflicts, 80
  - Dell Diagnostics, 84
  - dropped or damaged computer, 78
  - external keyboard
    - problems, 48
  - Hardware Troubleshooter, 80
  - Help and Support Center, 10
  - network problems, 64
  - PC Card problems, 75
  - power problems, 38

- troubleshooting
  - program crash, 76
  - program stopped
    - responding, 76
  - restore to previous state, 81
  - scanner problems, 72
  - unexpected characters, 48
  - wet computer, 77

## **U**

- USB connector
  - description, 20
  - system view, 20

## **V**

- video connector
  - description, 21
  - system view, 21

## **W**

- warranty, 9
- wet computer, 77
- Windows XP
  - Device Driver Rollback, 79
  - Hardware Troubleshooter, 80
  - Help and Support Center, 10
  - printer, 31
  - System Restore, 81