



# Dell™ Inspiron™ 2500 Systems

[A Tour of Your Computer](#)  
[Power Conservation](#)  
[Solving Problems](#)  
[System Specifications](#)  
[Drivers and Utilities](#)  
[Reinstalling Microsoft® Windows®](#)  
[System Setup Program](#)  
[Ports and Connector Pin-Outs](#)  
[Removing and Replacing Parts](#)

---

## Hints, Notices, and Cautions

-  **HINT:** A HINT indicates important information that helps you make better use of your computer.
  -  **NOTICE:** A NOTICE indicates either potential damage to hardware or loss of data and tells you how to avoid the problem.
  -  **CAUTION:** A CAUTION indicates a potential for property damage, personal injury, or death.
- 

## Abbreviations and Acronyms

For a complete list of abbreviations and acronyms, see the *Tell Me How* help file (click the **Start** button on the Microsoft® Windows® desktop, point to **Programs**—> **User's Guides**, and click **Tell Me How**).

Information in this document is subject to change without notice.  
© 2000–2002 Dell Computer Corporation. All rights reserved.

Reproduction in any manner whatsoever without the written permission of Dell Computer Corporation is strictly forbidden.

Trademarks used in this text: *Dell*, the *DELL* logo, and *Inspiron* are trademarks of Dell Computer Corporation; *Intel* and *Pentium* are registered trademarks and *Celeron* is a trademark of Intel Corporation; *Microsoft* and *Windows* are registered trademarks of Microsoft Corporation.

Other trademarks and trade names may be used in this document to refer to either the entities claiming the marks and names or their products. Dell Computer Corporation disclaims any proprietary interest in trademarks and trade names other than its own.

This product incorporates copyright protection technology that is protected by method claims of certain U.S. patents and other intellectual property rights owned by Macrovision Corporation and other rights owners. Use of this copyright protection technology must be authorized by Macrovision Corporation, and is intended for home and other limited viewing uses only unless otherwise authorized by Macrovision Corporation. Reverse engineering or disassembly is prohibited.

February 2002 Rev. A03

[Back to Contents Page](#)

## Drivers and Utilities

### Dell™ Inspiron™ 2500 Systems

- [Overview](#)
  - [Reinstalling Drivers and Utilities](#)
  - [Using Windows Me System Restore](#)
- 

## Overview

Dell provides software utilities and drivers that help you control certain features of your computer. The utilities and drivers for Dell-installed devices are installed and operative when you receive the computer. If you ever need to reinstall any of these drivers, you can use the Dell Drivers and Utilities CD that came with your computer.

Often, device problems can be corrected by reinstalling the appropriate drivers. Also, hardware manufacturers frequently provide updated drivers that support feature enhancements or that correct problems. Obtain updated drivers for products purchased from Dell at the Dell support website, <http://support.dell.com>.

- ➔ **NOTICE:** Drivers available on the Dell support website have been validated for correct operation on Dell computers. Installing drivers obtained from other sources may cause errors or performance degradation.

To install drivers and utilities, you need the following items:

- 1 Dell Drivers and Utilities CD
- 1 CD or DVD drive

Dell recommends that you print these procedures before you begin.

- ➔ **NOTICE:** Make sure that the computer is disconnected from any USB port replicator before you reinstall drivers.

- 🔍 **HINT:** For more information on using the operating system installed on your computer by Dell, see the operating system documentation that came with your computer. You can also access system tools and documentation from <http://support.dell.com> by entering your service tag or Express Service Code and then clicking Go!
- 

## Reinstalling Drivers and Utilities

- ➔ **NOTICE:** The Dell support website, <http://support.dell.com>, and the *Drivers and Utilities* CD provide approved drivers for Dell computers. If you install drivers obtained from other sources, your computer might not work correctly.
- ➔ **NOTICE:** Make sure that you reinstall the Intel® Chip Set Update Utility driver before you reinstall any other drivers.

1. Insert the *Drivers and Utilities* CD into the CD or DVD drive.
2. When the Dell Resource CD Launcher window appears, click the button for the driver or utility you wish to install.
3. Follow the screen prompts until the driver or utility is installed.

For detailed information on installing specific drivers and utilities for your computer, see the Dell support website at <http://support.dell.com>.

## Installing the Internal Modem Driver (Optional)

If you ordered the internal modem, you need to reinstall the modem driver.

If you ordered the combination modem/network adapter, you need to reinstall both the modem and [network adapter drivers](#).

### Windows® Millennium Edition (Me)

1. Insert your Drivers and Utilities CD into the CD or DVD drive.
2. Click the Start button, point to Settings, and click Control Panel.
3. At the Control Panel window, double-click the System icon.
4. In the System Properties window, click the Device Manager tab, and look under Other Devices.

- 🔍 **HINT:** To see the System icon, you may need to click the View all control panel options link at the left side of the screen.

5. Click PCI Communication Device.
6. Click Properties.
7. Click Reinstall Driver.
8. Verify that Automatic search for a better driver (Recommended) is selected, and click Next.

9. In the Select Other Driver window, look under the Location column for a path containing WINME.
10. Under Device Description, click the name corresponding to the WINME line, and click OK to confirm.
11. Click Finish, and then click Yes to restart the computer.

## Windows 2000

1. Insert the Drivers and Utilities CD into the CD or DVD drive.
2. Click the Start button, point to Settings, and double-click Control Panel.
3. Double-click the System icon.
4. At the System Properties window, click the Hardware tab.
5. Click Device Manager.
6. Under Other Devices, click PCI Simple Communications Controller.
7. On the tool bar, click Action, and click Properties.
8. Click Reinstall Driver, and click Next.
9. Verify that Search for a suitable driver for my device (Recommended) is selected, and click Next.
10. Verify that CD-ROM drives is selected, and click Next.
11. When the appropriate driver is found, click Next.
12. Click Finish to complete installation of the modem driver.

## Installing the Network Adapter Driver (Optional)

If you ordered the combination modem/network adapter, you need to reinstall both the [modem driver](#) and the network adapter driver.

### Windows Me

1. Insert the Drivers and Utilities CD into the CD or DVD drive.
2. Click the Start button, point to Settings, and click Control Panel.
3. In the Control Panel window, double-click the System icon.

 **HINT:** To see the System icon, you may need to click the View all control panel options link at the left side of the screen.

4. At the System Properties window, click the Device Manager tab.
5. Under Other Devices, click PCI Ethernet Controller.
6. Click Properties.
7. Click Reinstall Driver.
8. Verify that Automatic search for a better driver (Recommended) is selected, and click Next.
9. Click Finish to complete installation of the driver.

### Windows 2000

1. Insert the Drivers and Utilities CD into the CD or DVD drive.
2. Click the Start button, point to Settings, and double-click Control Panel.
3. In the Control Panel window, double-click the System icon.
4. In the System Properties window, click the Hardware tab.
5. Click Device Manager.
6. Under Other Devices, click Ethernet Controller.
7. On the tool bar, click Action, and click Properties.
8. Click Reinstall Driver, and click Next.
9. Verify that Search for a suitable driver for my device (Recommended) is selected, and click Next.
10. Verify that CD-ROM drives is selected, and click Next.
11. When the appropriate driver is found, click Next.
12. Click Finish to complete installation of the driver.

---

## Using Windows Me System Restore

Windows Me System Restore allows you to return your computer to an earlier operating state if changes to the computer's hardware or software (including new hardware or program installations) or other system settings have left the computer in an undesirable operating state. You can also undo the last System Restore operation.

System Restore automatically creates system checkpoints every 10 hours that the computer remains turned on and every 24 hours of real time. You can also manually create your own checkpoints by creating Restore Points.

System Restore does not cause you to lose personal files stored in the **My Documents** folder, data files, or e-mail messages after restoring the computer to an earlier operating state. If you restore the computer to a point before which you installed a program, the program's data files won't be lost, but you will have to reinstall the actual program again.

System Restore is enabled on your new computer. However, if you reinstall Windows Me with less than 200 MB of free hard-disk space available, System Restore is automatically disabled. To see if System Restore is enabled:

1. Click the **Start** button, point to **Settings**, and then click **Control Panel**.
2. Double-click the **System** icon.
3. Click the **Performance** tab.
4. Click **File System**.
5. Click the **Troubleshooting** tab, and make sure that **Disable System Restore** is unchecked.

Before proceeding with any System Restore function, Dell recommends that you thoroughly read Microsoft's information about using System Restore. To access this information:

1. Turn on your computer.
2. Click the **Start** button, point to **Programs—> Accessories—> System Tools**, and then click **System Restore**.
3. Click **Help** in the upper-right corner of the **Welcome to System Restore** screen.

## Creating a Restore Point

1. Turn on your computer.
2. Click the **Start** button, point to **Programs—> Accessories—> System Tools**, and then click **System Restore**.
3. Click **Create a restore point**.
4. Click **Next**.
5. Type a name for your new restore point in the **Restore point description** field.

The present date and time are automatically added to your restore point.

6. Click **Next**.
7. Click **OK**.

## Restoring the Computer to an Earlier Operating State

1. Turn on your computer.

 **NOTICE:** Before restoring the computer to an earlier operating state, save and close all open files and exit all open programs. Do not alter, open, or delete any files or programs until the system restoration is complete.

2. Click the **Start** button, point to **Programs—> Accessories—> System Tools**, and then click **System Restore**.
3. Be sure **Restore my computer to an earlier time** is selected, and then click **Next**.
4. Click a calendar date to which you want to restore your computer.

The **Choose a Restore Point** screen provides a calendar that allows you to see and select restore points. All calendar dates with available restore points appear in bold.

5. Select a restore point, and then click **Next**.

If a calendar date has only one restore point, then that restore point is automatically selected. If two or more restore points are available, click the restore point that you want to use.

 **NOTICE:** Save and close all open files and exit all open programs. Do not alter, open, or delete any files or programs until the system restoration is complete.

6. A message with instructions to save and close all open files and exit all programs appears—click **OK**.
7. Click **Next**.
8. The **Restoration In Progress** screen appears, and then the computer automatically restarts.
9. After the computer restarts, click **OK**.

## Undoing the Last System Restore

1. Turn on your computer.

 **NOTICE:** Before undoing the last system restore, save and close all open files and exit all open programs. Do not alter, open, or delete any files or programs until the system restoration is complete.

2. Click the **Start** button, point to **Programs—> Accessories—> System Tools**, and then click **System Restore**.

3. Click **Undo my last restoration**.

4. Click **Next**.

 **NOTICE:** Save and close all open files and exit all open programs. Do not alter, open, or delete any files or programs until the system restoration is complete.

5. A message with instructions to save and close all open files and exit all programs appears—click **OK**.

6. Click **Next**.

7. The **Undoing Last Restoration** screen appears, and then the computer automatically restarts.

8. After the computer restarts, click **OK**.

---

[Back to Contents Page](#)

## Ports and Connector Pin-Outs

### Dell™ Inspiron™ 2500 Systems

- [Serial Connector](#)
- [Parallel Connector](#)
- [PS/2 Connector](#)
- [USB Connectors](#)
- [Video Connector](#)

### Serial Connector

Use the 9-pin serial connector to attach a serial device to the computer. The serial port passes data in serial format (1 bit at a time over one line). This port supports a variety of devices, including a serial mouse, that require serial data transmission. If you reconfigure your hardware, you may need pin number and signal information for the serial connector.



Pin	Signal	I/O	Definition
1	DCD	I	Data carrier detect
2	RXDA	I	Receive data
3	TXDA	O	Transmit data
4	DTR	O	Data terminal ready
5	GND	N/A	Signal ground
6	DSR	I	Data set ready
7	RTS	O	Request to send
8	CTS	I	Clear to send
9	RI	I	Ring indicator
Shell	N/A	N/A	Frame ground

### Parallel Connector

Use the 25-hole parallel connector to attach a parallel device to the computer. The parallel connector is used primarily for printers. The parallel connector transmits data in parallel format, where 8 data bits (one byte) are sent simultaneously over eight separate lines.

The parallel connector can also be configured for compatibility with the PS/2 standard. Support for the EPP feature improves network adapter performance (adapters connect to the computer's parallel connector and require the appropriate software drivers from the adapter's manufacturer).

If you reconfigure your hardware, you may need pin number and signal information for the parallel connector.

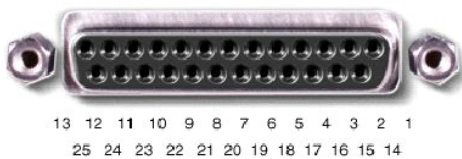

Pin	Signal	I/O	Definition
1	STB#	I/O	Strobe
2	D0	I/O	Printer data bit 0
3	PD1	I/O	Printer data bit 1

4	PD2	I/O	Printer data bit 2
5	PD3	I/O	Printer data bit 3
6	PD4	I/O	Printer data bit 4
7	PD5	I/O	Printer data bit 5
8	PD6	I/O	Printer data bit 6
9	PD7	I/O	Printer data bit 7
10	ACK#	I	Acknowledge
11	BUSY	I	Busy
12	PE	I	Paper end
13	SLCT	I	Select
14	AFD#	O	Automatic feed
15	ERR#	I	Error
16	INIT#	O	Initialize printer
17	SLIN#	O	Select in
18-25	N/A	N/A	Ground signal
Shell	N/A	N/A	Frame ground

## PS/2 Connector

Use the 6-hole, miniature DIN PS/2 connector to attach PS/2-compatible devices such as a mouse, keyboard, or external numeric keypad. If you reconfigure your hardware, you may need pin number and signal information for the PS/2 connector.

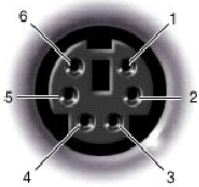

Pin	Signal	I/O	Definition
1	EXK_MSDATA	I/O	External keyboard/keypad/mouse data
2	KBD_DATA	I	Keyboard data
3	GND	N/A	Signal ground
4	EXK_MSPWR	N/A	External keyboard/keypad/mouse supply voltage
5	EXK_MSCLK	I/O	External keyboard/keypad/mouse clock
6	KBD_CLK	I	Keyboard clock
Shell	N/A	N/A	Chassis ground

## USB Connectors

Use the USB connectors to attach one or more USB devices, such as a mouse, to the computer. USB is a peripheral standard that enables automatic detection of USB-compliant peripheral devices.

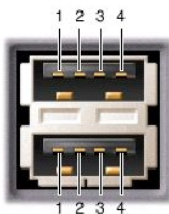

Pin	Signal	Definition
1	VCC	Cable power
2	-Data	N/A
3	+Data	N/A
4	Ground	Cable ground

## Video Connector

Use the 15-pin video connector to attach an external monitor to the computer. If the image does not appear on the monitor immediately, press <Fn><F8>.



Pin	Signal	I/O	Definition
1	RED	O	Red video
2	GREEN	O	Green video
3	BLUE	O	Blue video
4	DDC2_MONID2	I	Monitor detect ID2
5	GND	N/A	Signal ground
6	GND	N/A	Signal ground
7	GND	N/A	Signal ground
8	GND	N/A	Signal ground
9	CRTVCC	O	5-V power source for CRT
10	GND	N/A	Signal ground
11	M-SEN#	I	Digital monitor sense/monitor detect ID1
12	DDC_DATA	I	Monitor detect serial data
13	HSYNC	O	Horizontal synchronization
14	VSYNC	O	Vertical synchronization
15	DDC_CLK	1	Monitor Detect serial clock
Shell	N/A	N/A	Frame ground

[Back to Contents Page](#)



[Back to Contents Page](#)

## Power Conservation

Dell™ Inspiron™ 2500 Systems

- [Conservation Tips](#)
  - [Power Conservation Modes](#)
  - [Power Options Properties](#)
- 

### Conservation Tips

- 1 You automatically conserve battery power each time you attach your computer to an electrical outlet. When the AC adapter is attached, the battery is charged while the computer uses AC power. Your battery's life expectancy is largely determined by the number of times it is charged, so use an AC power source to run the computer if one is available.
  - 1 When the computer is using battery power, remove the PC Cards that you are not using.
  - 1 When possible, attach your computer to an electrical outlet when you play CDs and DVDs. Playing a CD or DVD uses a lot of battery power.
  - 1 Place the computer in standby mode or hibernate mode when you leave the computer unattended for long periods of time.
- 

### Power Conservation Modes

#### Standby Mode

Standby mode conserves power by turning off the display and the hard drive after a predetermined period of inactivity (a time-out.) When you resume computer operation from standby mode, the desktop is restored to the same state that it was in before the computer entered standby mode.

To activate standby mode:

- 1 Click the **Start** button, click **Shutdown**, click **Standby**, and then click **OK**.

or

- 1 Press the power button or the power conservation key combination, <Fn><Suspend>, that you programmed (via the **Advanced** tab).

 **HINT:** You can use the **Advanced** tab to program the display-close option, the power button, and the power conservation key combination to activate standby mode.

To resume operation from standby mode, press the power button, or if you activated standby mode by closing the display, open (raise) the display.

#### Hibernate Mode

Hibernate mode conserves power by copying system data to a reserved area on the hard drive and then completely turning off the computer. When you resume computer operation, the application programs and files that were open before you activated hibernate mode are still open.

Your computer enters hibernate mode if the battery charge level becomes critically low, or if either the power button, the power conservation key combination, <Fn><Suspend>, or the display-close option are programmed to activate hibernate mode in the **Advanced** tab of the **Power Options Properties** window.

 **HINT:** Some PC Cards may not operate correctly after resuming operation from hibernate mode. If you encounter problems with a PC Card, reinsert the card or restart your computer.

To resume computer operation from hibernate mode, press the power button. The computer may take a short time to return to its normal operating state. Pressing a key or touching the touch pad will not bring the computer out of hibernate mode.

Hibernate mode requires a special file on your hard drive with enough disk space to store the contents of the computer memory. Dell creates an appropriately sized hibernate mode file before shipping the computer to you.

If you reinstall the operating system, you must [reenable hibernate mode support](#).

---

### Power Options Properties

To access the Microsoft® Windows® **Power Options Properties** window:

1. Click the **Start** button, point to **Settings**, and click **Control Panel** (double-click **Control Panel** in Windows 2000).
2. Double-click the **Power Options** icon.

#### Power Schemes Tab

The **Power schemes** pull-down menu displays the selected preset power scheme:

- 1 **Home/Office**

- 1 **Portable/Laptop** (default)
- 1 **Presentation** (Windows 2000 only)
- 1 **Always On**
- 1 **Minimal Power Management** (Windows 2000 only)
- 1 **Max Battery** (Windows 2000 only)

 **HINT:** Dell recommends that you continue to use the **Portable/Laptop** power scheme to maximize battery power conservation.

Each preset power scheme has different time-out settings for putting the computer into standby mode, turning off the display, and turning off the hard drive.

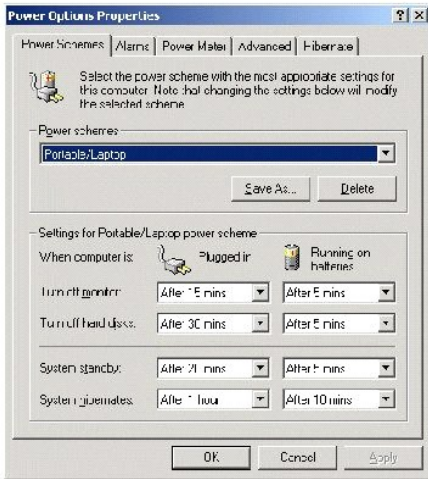

## Alarms Tab

 **HINT:** To enable audible alarms, click each **Alarm Action** button and select **Sound alarm**.

The Low battery alarm and Critical battery alarm settings alert you with a message when the battery charge falls below a certain percentage. When you receive your computer, the Low battery alarm and Critical battery alarm check boxes are selected. The Power Mode in the Low battery alarm is set to none and the Power Mode if the **Critical battery alarm** is set to **hibernate**. Dell recommends that you continue to use these defaults.

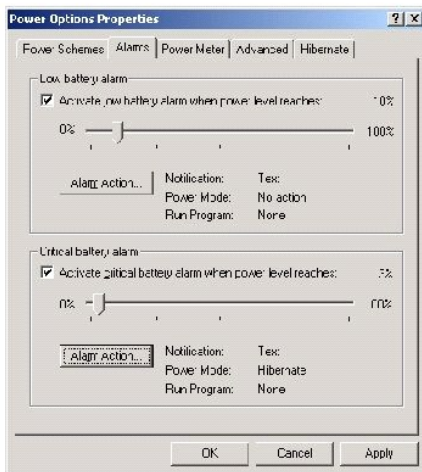

## Power Meter Tab

The **Power Meter** tab displays the current power source and amount of battery charge remaining.

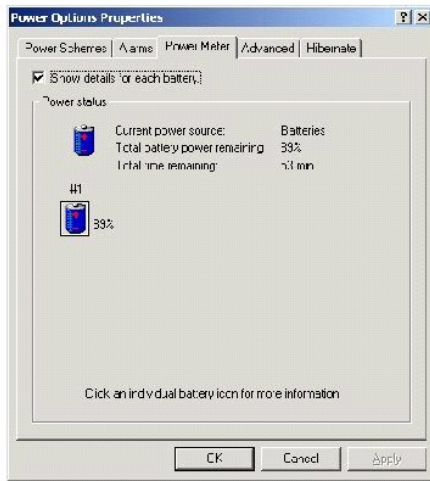

## Advanced Tab

The **Advanced** tab allows you to:

1. Set icon and standby password options.
1. Program the following functions:
  - o Activate standby mode (the default when you close the display).
  - o Activate hibernate mode (the default for the power button).
  - o Shut down Windows and turn off the computer.
  - o No action (None).

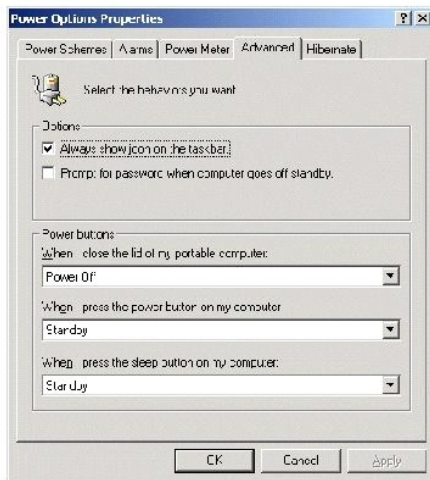

 **HINT:** If you are going to connect your computer to a USB port replicator, click **None** when you program the display-close option. This setting ensures that your computer does not enter standby mode or hibernate mode when you close (lower) the display.

To program these functions, click an option from the corresponding pull-down menu, and then click **OK**.

## Hibernate Tab

The **Hibernate** tab lets you enable hibernate mode by clicking the **Enable hibernate support** check box.

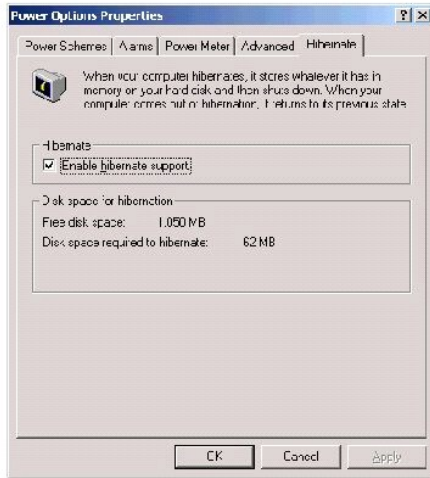

## Intel® SpeedStep™ Tab

If your computer has a Mobile Intel Pentium® III processor, the **Power Options Properties** window includes the **Intel® SpeedStep™** tab.

To change the Intel SpeedStep options, click the **Advanced** button and then click one of the following options:

 **HINT:** If you disable the Intel SpeedStep feature, the processor always operates at its maximum speed.

- 1 **Disable Intel SpeedStep technology control**
- 1 **Remove flag icon**
- 1 **Disable audio notification when performance changes**

Click **Apply** to accept any changes, and then click **OK** to close the Intel SpeedStep technology window.

---

[Back to Contents Page](#)

## Removing and Replacing Parts

### Dell™ Inspiron™ 2500 Systems

- [Preparing to Work Inside the Computer](#)
  - [Recommended Tools](#)
  - [Screw Identification](#)
  - [System Components](#)
  - [Hard Drive](#)
  - [Fixed Optical Drive](#)
  - [Media Bay Devices](#)
  - [Memory Modules](#)
  - [Mini PCI Card Assembly](#)
  - [Keyboard Assembly](#)
  - [Display and Bezel Assembly](#)
  - [Display Assembly Bezel and Panel](#)
  - [Display Latch Assembly](#)
  - [Microprocessor Thermal Cooling Assembly](#)
  - [Microprocessor Module](#)
  - [Video Memory Cache Card \(Optional\)](#)
  - [Palm Rest Assembly](#)
  - [LED Board](#)
  - [System Board Assembly](#)
  - [Battery and Media Bay Latch Assemblies](#)
  - [Fan Assembly](#)
  - [RJ-11/RJ-45 Board](#)
- 

## Preparing to Work Inside the Computer

- ➔ **NOTICE:** Only a certified service technician should perform repairs on your computer. Damage or inoperability due to servicing not authorized by Dell is not covered by your warranty.
  - 🔧 **HINT:** Unless otherwise noted, each procedure in this document assumes that a part can be replaced by performing the removal procedure in reverse order.
  - ➔ **NOTICE:** To dissipate any static electricity while you work, periodically touch an unpainted metal surface on the surface of the computer, such as the I/O panel on the back of the computer chassis.
  - ➔ **NOTICE:** Handle components and cards with care. Do not touch the components or contacts on a card. Hold a card by its edges or by its metal mounting bracket. Hold a component such as a microprocessor by its edges, not by its pins.
1. To avoid damaging the computer, perform the following steps before you begin working inside the computer.
  2. Make sure that the work surface is clean to prevent scratching the computer cover.
  3. Save any work in progress and close all open programs.
- 🔧 **HINT:** Make sure the computer is turned off and not in standby or hibernate mode. If you cannot shut down the computer using the computer's operating system, press and hold the power button for 4 seconds.
4. Turn off the computer and all attached devices.
  5. Make sure the computer is not connected to a port replicator.
  6. Disconnect the computer from the electrical outlet.
- ➔ **NOTICE:** To avoid possible damage to the system board, wait 10 to 20 seconds before you disconnect any attached devices.
7. Disconnect all external cables and attached devices from the computer.
  8. Remove any installed PC Cards or plastic blanks from the PC Card slot.
  9. Close the display and turn the computer upside down on a flat work surface.
  10. Remove the battery from the battery bay.
- ➔ **NOTICE:** To avoid damaging the system board, you must remove the battery before you service the computer.
11. Remove any installed device in the media bay.
- 

## Recommended Tools

- 1 #1 magnetized Phillips-head screwdriver
  - 1 Small flat-blade screwdriver
  - 1 Pry stick
  - 1 Small plastic scribe
  - 1 Microprocessor extractor
  - 1 Flash BIOS update program floppy disk or CD (required only when upgrading the microprocessor or replacing the system board)
-





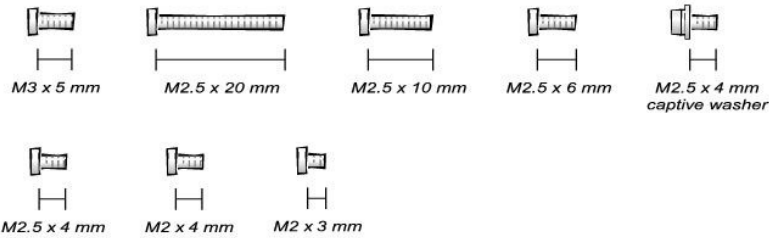









## Screw Identification

Before removing and replacing components, photocopy the screw placemat as a tool to help keep track of the screws. The placemat provides the number of screws and the sizes.



**NOTICE:** When reinstalling a screw, you must use a screw of the correct diameter and length. Make sure that the screw is properly aligned with its corresponding hole, and avoid over tightening.

## Screw Placemat

<b>Hard Drive Door Security:</b> M3.0 x 5 mm (1 each) 	<b>Keyboard to Bottom Case Assembly:</b> M2.5 x 20 mm (4 each; one in memory door and one in Mini PCI card door) 	<b>Display to Base:</b> M2.5 x 6 mm (3 each; 2 at back of system; 1 at flex-cable strain relief) 
<b>Display Bezel:</b> Rubber screw covers (4 each) Plastic screw covers (2 each) M2.5 x 4 mm (6 each) 	<b>Display Panel to Display Mounting Bracket: 15-inches</b> M2.0 x 3 mm (6 each)  <b>Flex-Cable Mounting Bracket to Top Cover:</b> M2.5 x 4 mm (1 each) 	<b>Display Panel to Display Mounting Bracket: 14.1-inches</b> M2.0 x 3 mm (4 each)  <b>Flex-Cable Mounting Bracket to Top Cover:</b> M2.5 x 4 mm (1 each) 
<b>Video Memory Cache Card:</b> M2.5 x 4 mm (2 each) 	<b>Palm Rest to Bottom Case Assembly:</b> M2.5 x 20 mm (9 each) 	<b>LED Board:</b> M2.0 x 4 mm (2 each) 
<b>System Board:</b> M2.5 x 4 mm captive washer (3 each)  M2.5 x 20 mm (1 each) 	<b>Fan Assembly:</b> M2.0 x 4 mm (3 each) 	<b>RJ-11/RJ-45 Board Assembly:</b> M2.5 x 4 mm (1 each) 

## System Components

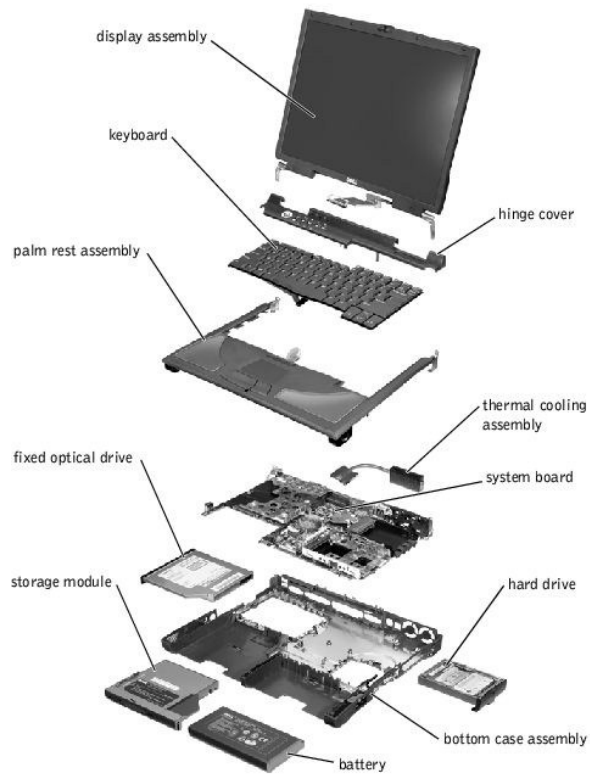

## Hard Drive

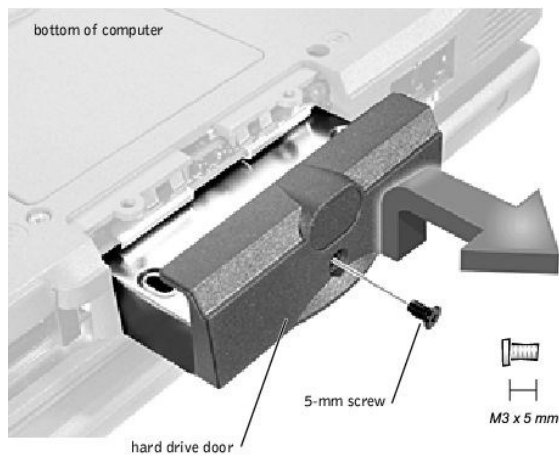

- ➔ **NOTICE:** Disconnect the computer and attached devices from electrical outlets and remove any installed battery.
- ➔ **NOTICE:** To avoid ESD, ground yourself by using a wrist grounding strap or by periodically touching an unpainted metal surface on the computer.

## Removing the Hard Drive

- ➔ **NOTICE:** To avoid damaging the system board, you must remove the battery before you service the computer.
- ➔ **NOTICE:** Make sure that the work surface is clean to prevent scratching the computer cover.
- ➔ **NOTICE:** The disk drive is very sensitive to shock. Handle the assembly by its edges (do not squeeze the top of the hard drive case), and avoid dropping it.

1. Follow the instructions in "[Preparing to Work Inside the Computer.](#)"
2. Close the display, turn the computer upside down on a flat work surface, and remove the battery.
3. Remove the 5-mm screw from the center of the hard drive door.
4. Slide the drive door up until the drive assembly tab disengages from the door slots in the bottom case assembly.
5. Carefully pull the drive assembly straight out of the bottom case assembly.

## Replacing the Hard Drive

1. Push the drive assembly into the hard drive opening on the left side of the computer.
  2. Align the drive assembly tabs with the bottom case assembly slots and push down until it clicks into place.
  3. Replace the 5-mm screw in the drive door.
- 

## Fixed Optical Drive

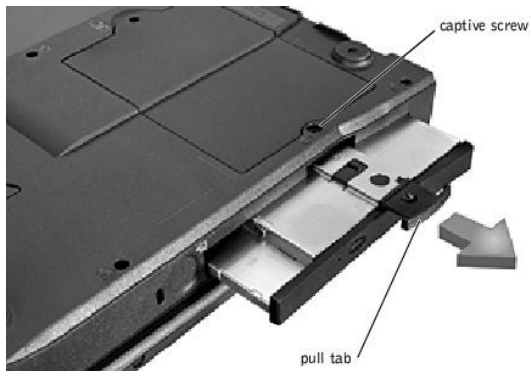

- ➔ **NOTICE:** Disconnect the computer and attached devices from electrical outlets and remove any installed battery.
- ➔ **NOTICE:** To avoid ESD, ground yourself by using a wrist grounding strap or by periodically touching an unpainted metal surface on the computer.

## Removing the Fixed Optical Drive

1. Follow the instructions in "[Preparing to Work Inside the Computer.](#)"
  2. Loosen the captive screw on the bottom of the computer.
  3. Turn the computer over, loosen the captive screw marked "C," and pull out the pull tab to remove the fixed optical drive.
- 

## Media Bay Devices

- ➔ **NOTICE:** Disconnect the computer and any attached devices from electrical outlets, and remove any installed battery.
- ➔ **NOTICE:** To avoid ESD, ground yourself by using a wrist grounding strap or by periodically touching an unpainted metal surface on the computer.

## Removing Media Bay Devices

1. Follow the instructions in "[Preparing to Work Inside the Computer.](#)"
2. Close the display, turn the computer upside down on a flat work surface, and remove the battery.
3. Remove the device from the media bay.
4. Push the module latch toward the right side of the computer. Keep holding the latch open while pulling the device out of the media bay with the other hand.



---

## Memory Modules

- ➔ **NOTICE:** Disconnect the computer and attached devices from electrical outlets and remove any installed battery.
- ➔ **NOTICE:** To avoid possible damage to the memory module from ESD, ground yourself by using a wrist grounding strap or by periodically touching an unpainted metal surface on the computer.

### Removing the Memory Module Cover

- ➔ **NOTICE:** To avoid damaging the system board, you must remove the battery before you service the computer.
- ➔ **NOTICE:** Handle memory modules with care. Don't touch the components on a module. Hold a module by its edges.

1. Follow the instructions in ["Preparing to Work Inside the Computer."](#)
2. Remove the screw.
3. Disengage the metal tabs at the opposite end of the cover.

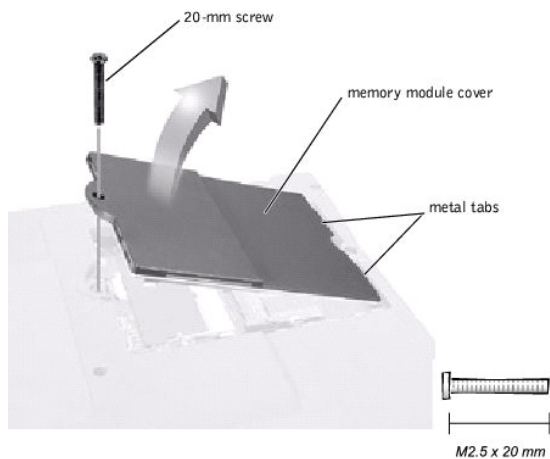

### Removing Memory Modules

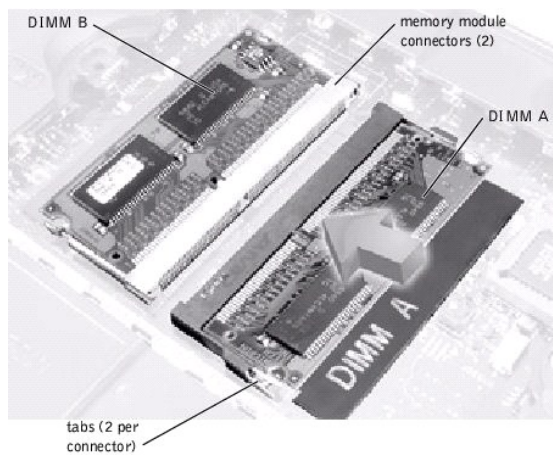

1. Remove the [memory module cover](#).
2. To release a memory module from its connector, spread apart the tabs at each side of the module until the module pops up slightly.
3. Lift the memory module out of its connector.

## Replacing Memory Modules

 **HINT:** Memory modules are keyed, or designed to fit into their connectors, in only one direction.

1. If you only have one memory module, install it in the connector labeled "DIMM A." If you have two memory modules, install the second module in the connector labeled "DIMM B."
2. Insert the memory module's edge connector with the slot at a 45-degree angle, and press the memory module firmly into the slot.
3. Pivot the memory module down until it clicks into place. If you do not hear a click, remove the module and reinstall it.
4. Insert the metal tabs on the memory module cover into the bottom case assembly. Rotate the cover down and replace the screw.

---

## Mini PCI Card Assembly

 **NOTICE:** Disconnect the computer and attached devices from electrical outlets and remove any installed battery.

 **NOTICE:** To avoid ESD, ground yourself by using a wrist grounding strap or by periodically touching an unpainted metal surface on the computer.

You must remove the optional Mini PCI card assembly before the system board assembly can be removed. A Mini PCI card assembly may consist of a modem or a modem and network adapter combination. A modem or modem and network adapter combination must be connected to the wiring harness as appropriate.

## Removing the Mini PCI Card Assembly

1. Follow the instructions in "[Preparing to Work Inside the Computer](#)."
2. Remove the 20-mm screw and lift out the Mini PCI card cover.

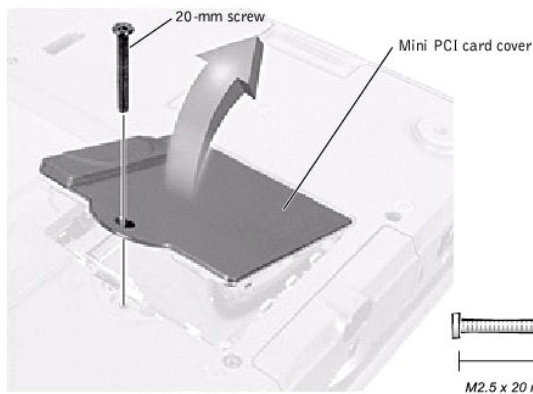

3. To release the Mini PCI card assembly, spread the metal securing tabs until the assembly pops up slightly.
4. Disconnect the assembly from the wiring harness.
5. Lift out the assembly and disconnect any attached cables.

## Replacing the Mini PCI Card Assembly

1. Align the Mini PCI card assembly with the socket at a 45-degree angle, and press the Mini PCI card into the socket.
2. Connect the wiring harness to the Mini PCI card assembly.

 **NOTICE:** The connectors are keyed for correct insertion; do not force the connections.

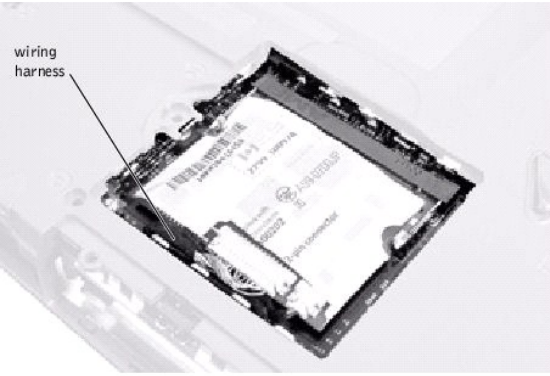

➔ **NOTICE:** If you are installing a modem card, fold and tuck the unused wiring harness under the card so that it does not interfere with the cover.

3. Pivot the Mini PCI card assembly down until it clicks into place.
4. Replace the Mini PCI card assembly cover.

---

## Keyboard Assembly

➔ **NOTICE:** Disconnect the computer and attached devices from electrical outlets and remove any installed battery.

➔ **NOTICE:** To avoid ESD, ground yourself by using a wrist grounding strap or by periodically touching an unpainted metal surface on the computer.

## Removing the Keyboard Assembly

1. Follow the instructions in "[Preparing to Work Inside the Computer.](#)"
2. Turn the computer over and remove the four screws labeled with a "circle K."

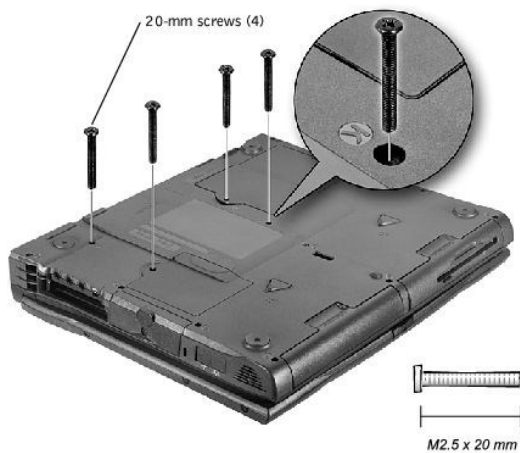

3. Turn the computer over and open the display.

➔ **NOTICE:** Be careful when handling the keyboard. The keycaps are fragile, easily dislodged, and time-consuming to replace.

4. Insert a pry stick under the blank key to pry up the keyboard.

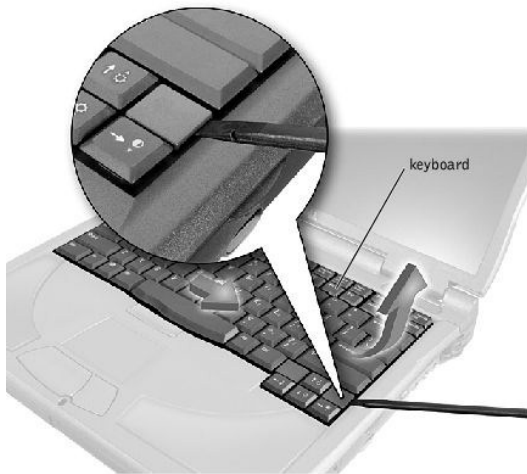

5. Lift the right end of the keyboard, and slide it slightly to the right to disengage the tabs at the left end.
6. Pivot the keyboard and balance it upright on the left side of the computer.



7. Disconnect the keyboard cable and lay the keyboard assembly aside.

## Replacing the Keyboard Assembly

 **HINT:** The cable connector on the system board is outlined in white to help you orient.

1. While bracing the keyboard assembly upright on its left end, connect the keyboard cable to the interface connector on the system board.

 **NOTICE:** Position the keyboard flex cable so that it is not pinched when you replace the keyboard in the bottom case assembly.

2. Insert the metal tabs at the left end of the keyboard under the edge of the bottom case assembly, and fit the keyboard into place.
3. Check that the keyboard is correctly installed. The keys should be flush with the left and right surfaces of the palm rest.
4. Reinstall the four screws in the holes labeled "K."

---

## Display and Bezel Assembly

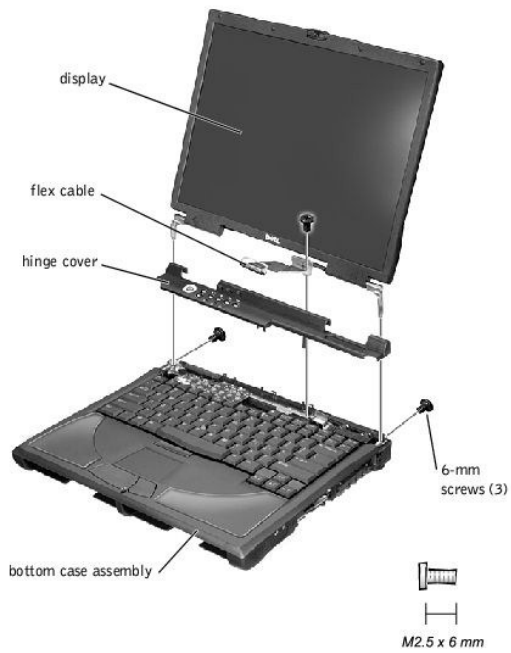

➔ **NOTICE:** Disconnect the computer and attached devices from electrical outlets and remove any installed battery.

➔ **NOTICE:** To avoid ESD, ground yourself by using a wrist grounding strap or by periodically touching an unpainted metal surface on the computer.

## Removing the Hinge Cover

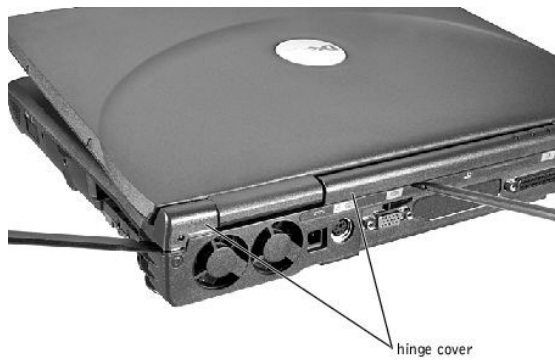

1. Follow the instructions in "[Preparing to Work Inside the Computer.](#)"
2. Use a nonmarring tool to loosen the hinge cover at the back and at each side of the computer.
3. Open the display and lift off the hinge cover.

## Removing the Display Assembly

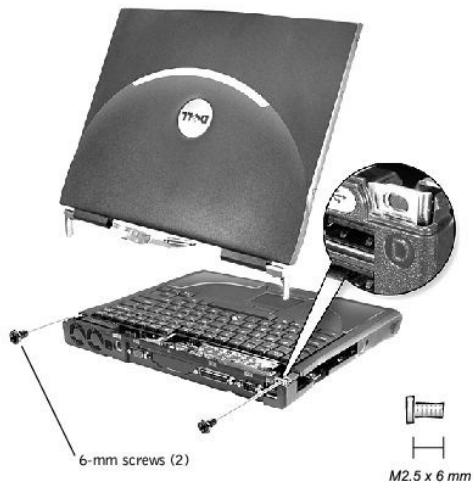

1. Remove the [hinge cover](#).
2. Remove the 6-mm screws that secures the flex cable to the strain relief, and then use the pull loop to remove the flex cable from the system board.

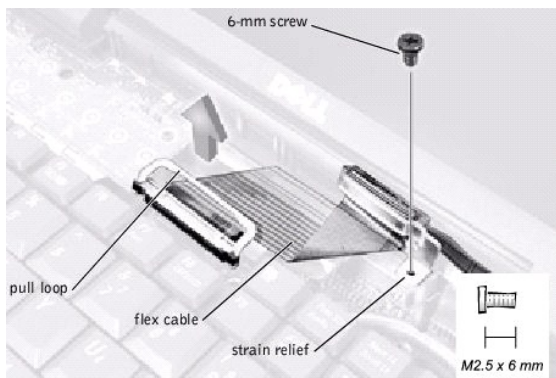

➡ **NOTICE:** When reconnecting the flex cable, press down on both ends of the connector, not in the middle. Pressing the middle of the connector can damage fragile components.

3. Open the display and remove the two screws (marked with a "circle D") that secure the display assembly to the bottom case assembly.
4. With the display in an upright position, lift the display assembly from the bottom case assembly.

---

## Display Assembly Bezel and Panel

### 12.1-Inch Display Bezel

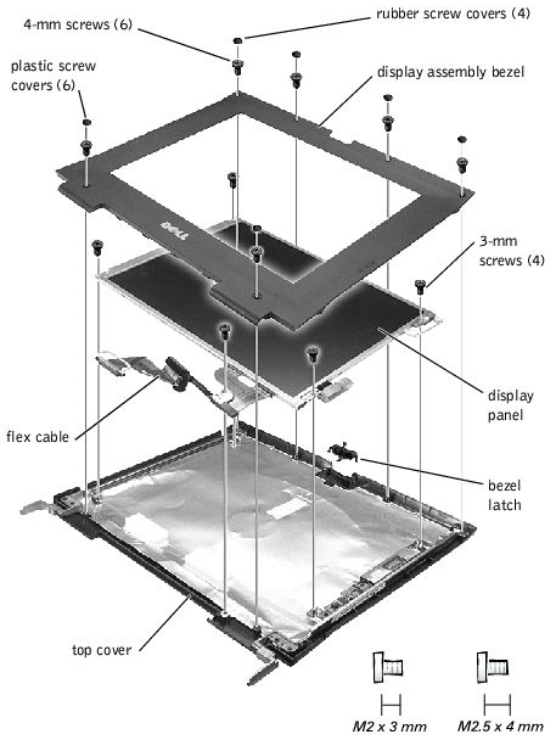

## 14.1-Inch Display Bezel

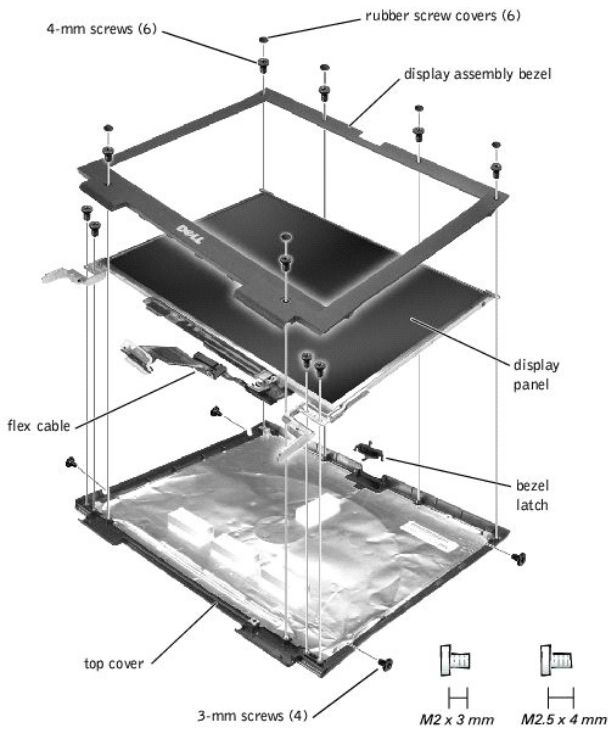

➡ **NOTICE:** Disconnect the computer and attached devices from electrical outlets and remove any installed battery.

➡ **NOTICE:** To avoid ESD, ground yourself by using a wrist grounding strap or by periodically touching an unpainted metal surface on the computer.

## Removing the Display Assembly Bezel

1. Follow the instructions in "[Preparing to Work Inside the Computer](#)."
2. Use a scribe to pry loose the four rubber screw covers located across the top of the bezel.
3. Remove the four 4-mm screws located across the top of the bezel.
4. Use a scribe at the indentations to pry loose the two rubber screw covers located at the bottom of the bezel.
5. Remove the two 4-mm screws located at the bottom of the bezel.
6. Separate the bezel from the display-assembly top cover.

The bezel is secured to the display assembly top cover with plastic tabs around the sides. Use a plastic scribe to help separate the bezel from the top cover.

## Removing the Display Panel

1. Remove the [hinge cover](#).
2. Remove the screw securing the flex cable to its strain relief, and then use the pull loop to remove the flex cable from the system board.

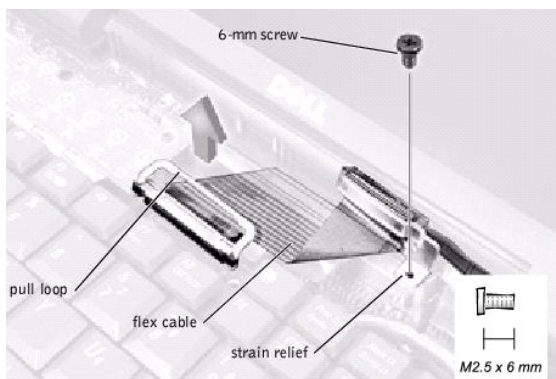

👉 **NOTICE:** When reconnecting the flex cable, press down on both ends of the connector, not in the middle. Pressing the middle of the connector can damage fragile components.

3. Remove the [display assembly bezel](#).
4. Remove the 6-mm screw securing the plastic flex-cable mounting bracket to the top cover assembly.
5. Remove the four 3-mm screws (two on each side) from the right and left sides of the panel.
6. Lift the display panel and flex cable out of the top cover assembly.
7. Disconnect the flex cable from the two connectors (a ZIF and a standard connector) on the display panel assembly.

🔧 **HINT:** If you find a kaption tape on the standard connector, remove it.



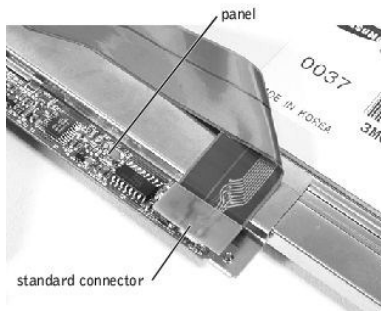
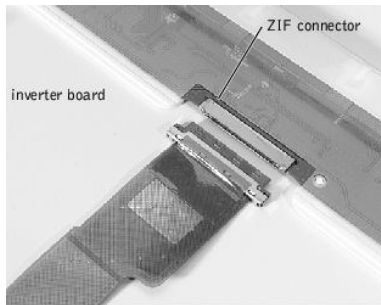

## Replacing the Display Panel

 **HINT:** Use a magnetic screwdriver to reassemble the display panel in the display.

1. Connect the flex cable to the two connectors (ensure that the ZIF connector is locked into place) on the back of the display panel.
2. Place the display panel assembly in the top cover, taking care that the flex cable is in place and is not crushed or crimped.
3. Reinstall the 4-mm screw that secures the flex-cable mounting bracket to the top cover.
4. Starting on the left side, use a magnetic screwdriver to reinstall the four 3-mm screws that secure the display panel in the top cover.
5. Reinstall the display assembly bezel.

## 15-Inch Display Assembly

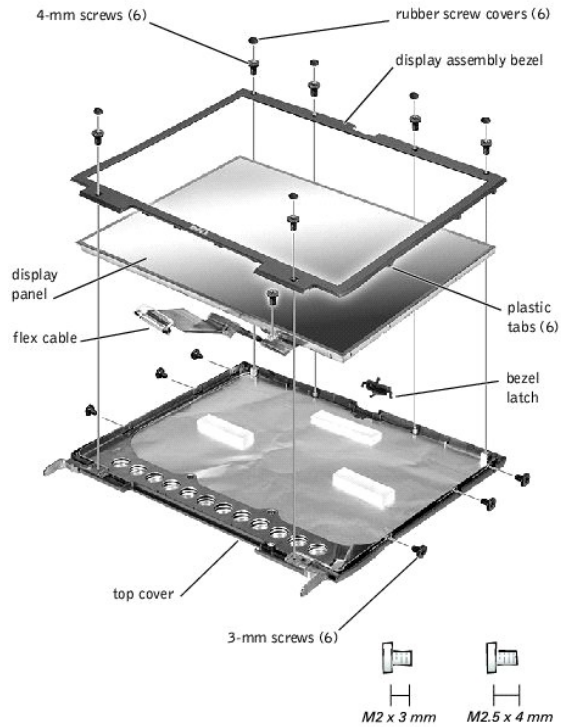

➔ **NOTICE:** Disconnect the computer and attached devices from electrical outlets and remove any installed battery.

➔ **NOTICE:** To avoid ESD, ground yourself by using a wrist grounding strap or by periodically touching an unpainted metal surface on the computer.

## Removing the Display Assembly Bezel

1. Follow the instructions in "[Preparing to Work Inside the Computer.](#)"
2. Use a scribe to pry loose the four rubber screw covers located across the top of the bezel.
3. Remove the four 4-mm screws located across the top of the bezel.
4. Use a scribe at the indentations to pry loose the two rubber screw covers located at the bottom of the bezel.
5. Remove the two 4-mm screws located at the bottom of the bezel.
6. Separate the bezel from the display-assembly top cover.

The bezel is secured to the display assembly top cover with plastic tabs around the sides. Use a plastic scribe to help separate the bezel from the top cover.

## Removing the Display Panel

1. Remove the [hinge cover](#).
2. Remove the screw securing the flex cable to its strain relief, and then use the pull loop to remove the flex cable from the system board.

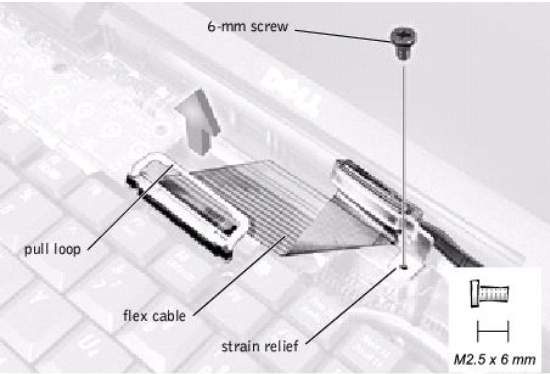

➡ **NOTICE:** When reconnecting the flex cable, press down on both ends of the connector, not in the middle. Pressing the middle of the connector can damage fragile components.

3. Remove the [display assembly bezel](#).
4. Remove the 4-mm screw securing the plastic flex-cable mounting bracket to the top cover assembly.
5. Remove the six 3-mm screws (three on each side) from the right and left sides of the panel.
6. Lift the display panel and flex cable out of the top cover assembly.

🔧 **HINT:** If you find a kaption tape on the standard connector, remove it.

7. Disconnect the flex cable from the two connectors (a ZIF and a standard connector) on the display panel assembly.

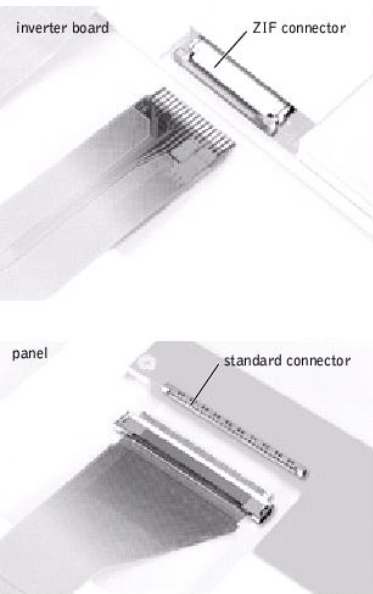

## Replacing the Display Panel

🔧 **HINT:** Use a magnetic screwdriver to reassemble the display panel in the display.

1. Connect the flex cable to the two connectors (ensure that the ZIF connector is locked into place) on the back of the display panel.
2. Place the display panel assembly in the top cover, taking care that the flex cable is in place and is not crushed or crimped.
3. Reinstall the 4-mm screw that secures the flex-cable mounting bracket to the top cover.
4. Starting on the left side, use a magnetic screwdriver to reinstall the six 3-mm screws that secure the display panel in the top cover.
5. Reinstall the display assembly bezel.

---

## Display Latch Assembly

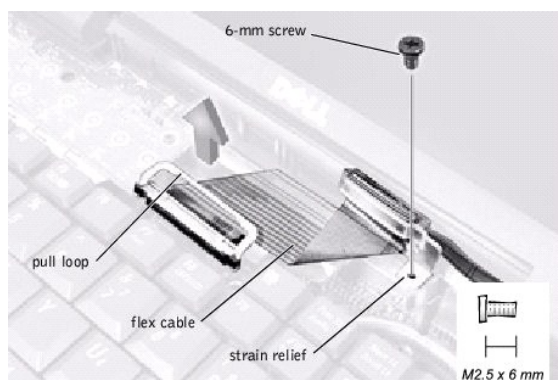

1. Remove the [hinge cover](#).
2. Remove the screw securing the flex cable to its strain relief, and then use the pull loop to remove the flex cable from the system board memory cache card.

➡ **NOTICE:** When reconnecting the flex cable, press down on both ends of the connector, not in the middle. Pressing the middle of the connector can damage fragile components.



3. Remove the [display assembly bezel](#).
4. Remove the display panel from the top cover.
5. Remove the display latch by unsnapping the latch and captive spring.

➡ **NOTICE:** When replacing the display assembly latch, it may help to flex the cover slightly to allow more space while seating the latch.

---

## Microprocessor Thermal Cooling Assembly

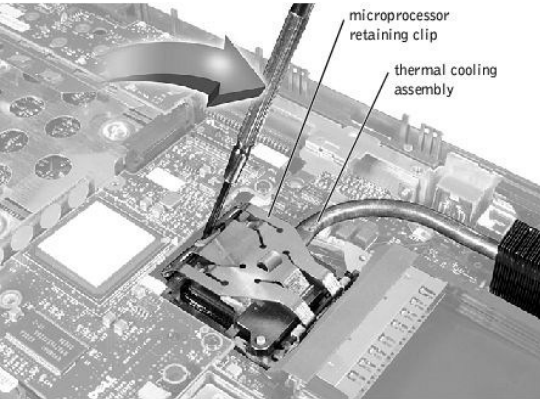

- ➔ **NOTICE:** Disconnect the computer and attached devices from electrical outlets and remove any installed battery.
- ➔ **NOTICE:** To avoid ESD, ground yourself by using a wrist grounding strap or by periodically touching an unpainted metal surface on the computer.

## Removing the Microprocessor Thermal Cooling Assembly

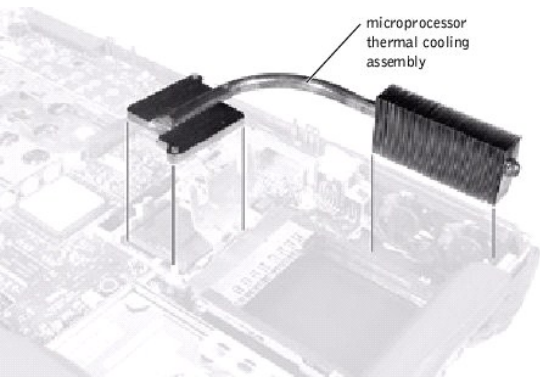

1. Follow the instructions in "[Preparing to Work Inside the Computer.](#)"
  2. Remove the [keyboard assembly](#).
  3. Remove the [hinge cover](#).
- ➔ **NOTICE:** To ensure maximum cooling for the microprocessor, do not touch the heat transfer areas on the thermal cooling assembly. The oils in your skin reduce the heat transfer capability of the thermal pads.
4. Insert a pry stick into the latch mechanism at the left side of the microprocessor retaining clip, and pry open the clip.
  5. Lift out the thermal cooling assembly.

---

## Microprocessor Module

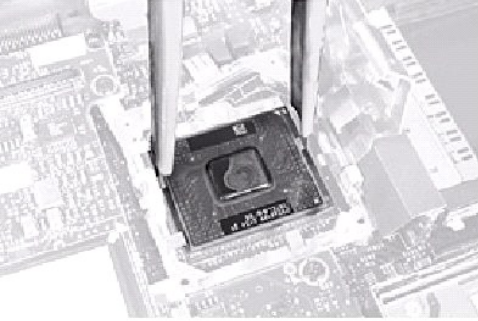

- ➔ **NOTICE:** Disconnect the computer and attached devices from electrical outlets and remove any installed battery.
- ➔ **NOTICE:** To avoid ESD, ground yourself by using a wrist grounding strap or by periodically touching an unpainted metal surface on the computer.

## Removing the Microprocessor Module

1. Follow the instructions in "[Preparing to Work Inside the Computer.](#)"
2. Remove the [keyboard assembly](#).
3. Remove the [hinge cover](#).
4. Remove the [microprocessor thermal cooling assembly](#).

- ➔ **NOTICE:** To ensure maximum cooling for the microprocessor, do not touch the heat transfer areas on the thermal cooling assembly. The oils in your skin reduce the heat transfer capability of the thermal pads.

5. Remove the microprocessor module.

- ➔ **NOTICE:** When removing the microprocessor module, pull the module straight up. Do not bend the pins.

- a. Loosen the microprocessor socket cam lock screw. The location of the screw and the rotation direction may vary with the socket manufacturer; look for small icons indicating open and locked positions.

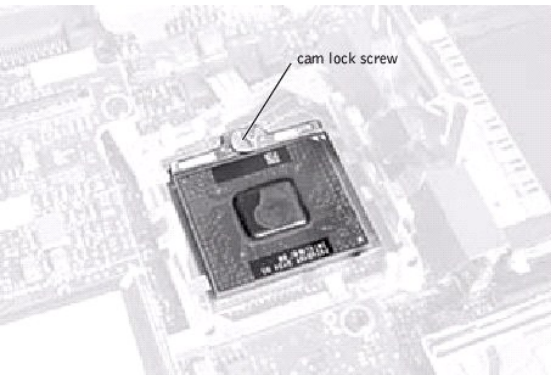

- b. Use the microprocessor extraction tool to remove the microprocessor module.
- c. To remove the microprocessor module, pull the module straight up. Do not bend the pins.

## Replacing the Microprocessor Module

- ➔ **NOTICE:** After replacing the microprocessor module, update the BIOS using a flash BIOS update program floppy disk or CD that came with the replacement microprocessor.

- ➔ **NOTICE:** Proper seating of the microprocessor module does not require force.

- ➔ **NOTICE:** A microprocessor module that is not properly seated can result in an intermittent connection and subsequent failures.

1. Align the pin-1 triangle on the microprocessor toward the pin-1 triangle in the socket, insert the microprocessor into the socket, and move it around slightly until you feel it settle into the socket.

When the microprocessor module is correctly seated, all four corners are aligned to the same height. If one or more corners of the module are higher than the others, the module is not seated correctly.

2. Tighten the cam lock screw.

🔗 **NOTICE:** Do not over or under tighten the screw. Tighten it until the screw indicator points to the "closed" or "locked" indicator on the socket.

3. Replace the microprocessor thermal cooling assembly.
4. While pressing lightly down on the center of the retaining clip, insert a pry stick into the latch mechanism and pivot the top of the pry stick away from the clip to close the latch.



---

## Video Memory Cache Card (Optional)

🔗 **NOTICE:** Disconnect the computer and attached devices from electrical outlets and remove any installed battery.

🔗 **NOTICE:** To avoid ESD, ground yourself by using a wrist grounding strap or by periodically touching an unpainted metal surface on the computer.

### Removing the Video Memory Cache Card

1. Follow the instructions in "[Preparing to Work Inside the Computer.](#)"
2. Remove the [keyboard assembly](#).
3. Remove the [hinge cover](#).
4. Remove the two 4-mm screws that secure the video memory cache card.
5. Lift the video memory cache card out of the system board connector.

### Replacing the Video Memory Cache Card

1. Align the two screw holes and press down firmly to seat the card in its connector.
2. Replace the two screws.

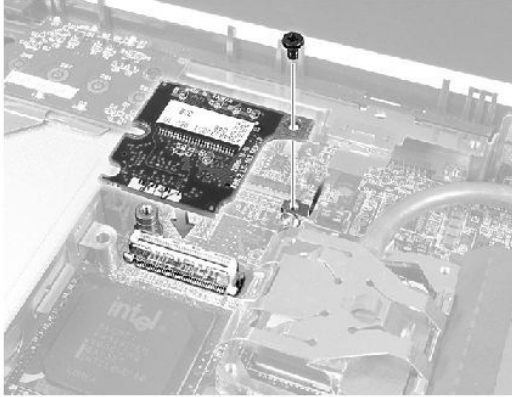

---

## Palm Rest Assembly

### Removing and Replacing the Palm Rest Inserts

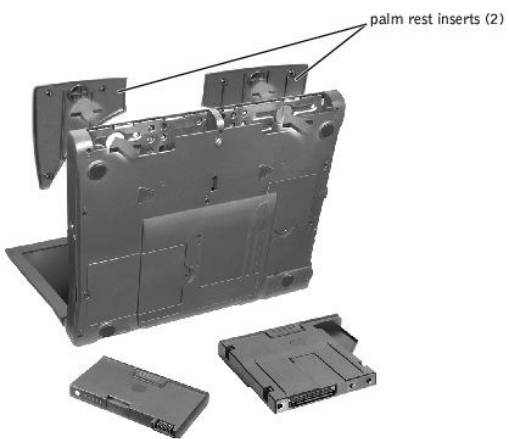

1. Keep the display open, and tilt the computer back so that you can access the bottom of the computer.
2. Slide and hold the latch release on the left side, and remove any device installed in the media bay.
3. Slide and hold the latch release on the right side, and remove any battery installed in the battery bay.
4. Locate the indentation under each palm rest insert, place your thumbs on the indentation, and gently push to release the palm rest inserts.





5. Remove the palm rest inserts.
6. To replace a palm rest insert, align it with the slots on the computer. Then press along the outside edges of the palm rest insert until it snaps into place.

Repeat the process on each side.

## Removing the Palm Rest Assembly

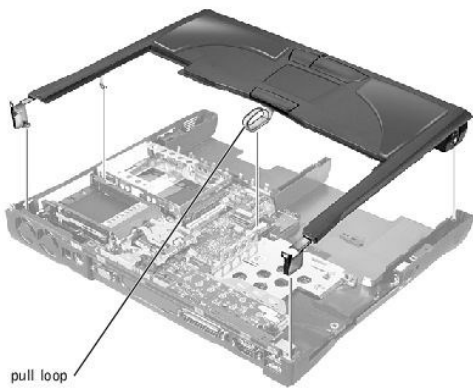

- ➔ **NOTICE:** Disconnect the computer and attached devices from electrical outlets and remove any installed battery.
  - ➔ **NOTICE:** To avoid ESD, ground yourself by using a wrist grounding strap or by periodically touching an unpainted metal surface on the computer.
1. Follow the instructions in "[Preparing to Work Inside the Computer.](#)"
  2. Remove the [hard drive](#) and the [fixed optical drive](#).
  3. Remove the [keyboard assembly](#).
  4. Remove the [hinge cover](#).
  5. Remove the [display](#).
- ➔ **NOTICE:** To avoid damaging the palm rest assembly, you must first remove the display assembly.
6. Turn the computer over.
  7. Remove the nine 20-mm screws (labeled with a "circle P") that secure the palm rest assembly to the computer.

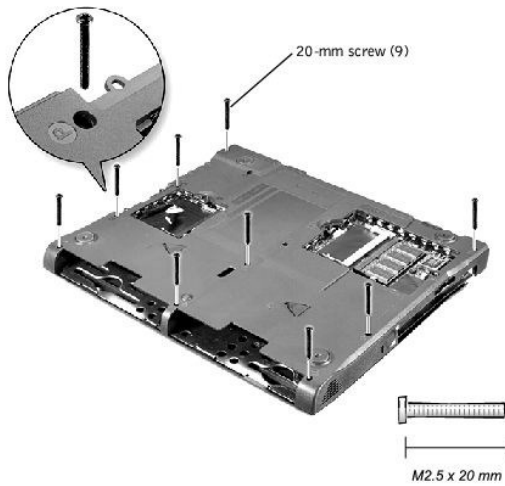

8. Turn the computer over.
9. Use the pull loop to disconnect the palm rest flex cable from the touch-pad connector on the system board.
10. Carefully lift out the palm rest assembly.

---

## LED Board

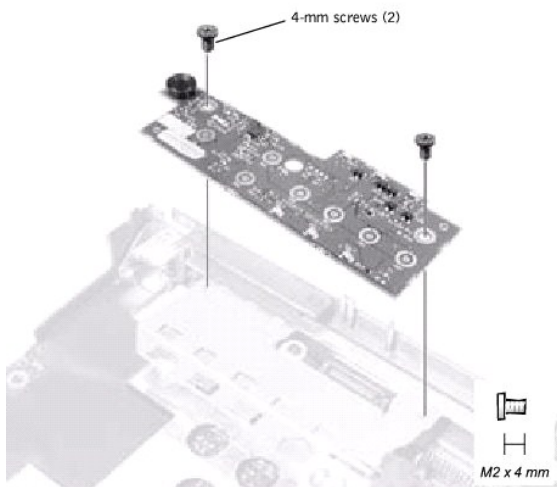

- ➔ **NOTICE:** Disconnect the computer and attached devices from electrical outlets and remove any installed battery.
- ➔ **NOTICE:** To avoid ESD, ground yourself by using a wrist grounding strap or by periodically touching an unpainted metal surface on the computer.

## Removing the LED Board

1. Follow the instructions in "[Preparing to Work Inside the Computer.](#)"
2. Remove the [hinge cover](#).
3. Remove the two 4-mm screws.
4. Lift the LED board out of connector.

## Replacing the LED Board

1. Align the two screw holes with the two mounting holes on the bottom case assembly, and press the board into its connector.
  2. Replace the two 4-mm screws.
- 

## System Board Assembly

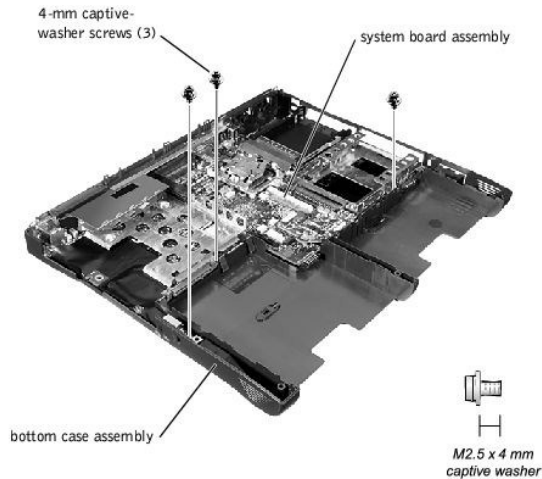

- ➔ **NOTICE:** Disconnect the computer and attached devices from electrical outlets and remove any installed battery.
- ➔ **NOTICE:** To avoid ESD, ground yourself by using a wrist grounding strap or by periodically touching an unpainted metal surface on the computer.

The system board's BIOS contains the system service tag number, which is also visible on a bar-code label on the bottom of the computer. The replacement kit for the system board assembly includes a floppy disk or CD that provides a utility for transferring the service tag number to the replacement system board assembly.

- ➔ **NOTICE:** After replacing the microprocessor module, update the BIOS using a flash BIOS update program floppy disk or CD that came with the replacement microprocessor.

## Removing the System Board

1. Follow the instructions in "[Preparing to Work Inside the Computer.](#)"
2. Remove the [hard drive](#) and [fixed optical drive](#).
3. Remove any installed [Mini PCI cards](#).
4. If migrating the memory, remove all installed [memory modules](#).
5. Remove the [keyboard assembly](#).
6. Remove the [hinge cover](#).
7. Remove the [display assembly](#).
8. Remove the [palm rest assembly](#).
9. Remove the [video memory cache card](#), if present.
10. Remove the [microprocessor thermal cooling assembly](#).
11. If migrating the microprocessor, remove the [microprocessor module](#).
12. Remove the three 4-mm captive-washer screws from the system board.
13. Remove the 20-mm screw from the center of the LED board.
14. If migrating the [LED board](#), remove it.
15. Lift the front of the system board and work it out of the back panel.

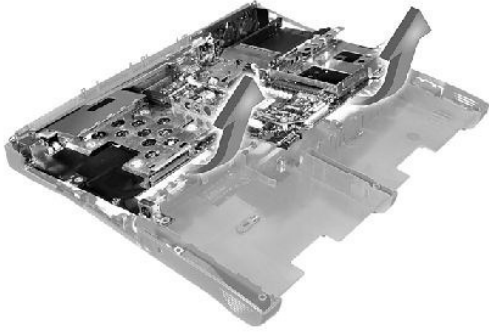

---

## Battery and Media Bay Latch Assemblies

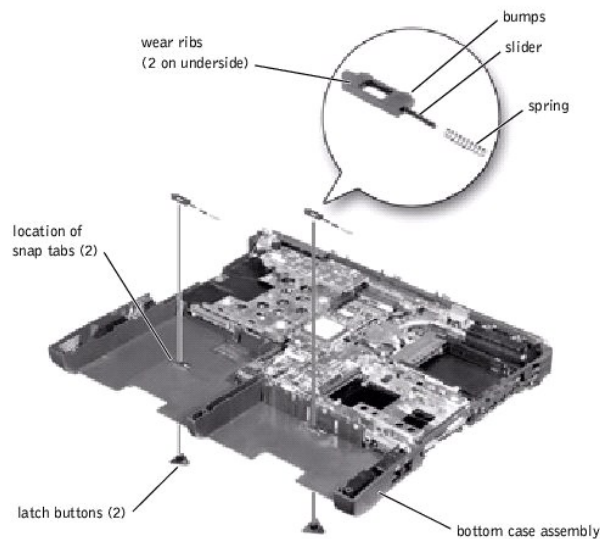

- ➔ **NOTICE:** Disconnect the computer and attached devices from electrical outlets and remove any installed battery.
- ➔ **NOTICE:** To avoid ESD, ground yourself by using a wrist grounding strap or by periodically touching an unpainted metal surface on the computer.

## Removing and Replacing the Battery and Media Bay Latch Assemblies

1. Follow the instructions in "[Preparing to Work Inside the Computer.](#)"
2. Remove the [keyboard assembly](#).
3. Remove the [hinge cover](#).
4. Remove the [display assembly](#).
5. Remove the [palm rest assembly](#).
6. Remove a latch button from the bottom case assembly by squeezing the snap tabs in the center of the latch.

Apply downward pressure to the tabs while squeezing them together (tweezers work well) to eject the latch button from the bottom of the case without loosening the upper latch assembly (spring and slider). If the upper latch assembly does come loose:

- a. Reinsert the spring onto the slider, and reinstall both pieces in the latch housing on the inside of the case.
- b. Ensure that the slider is inserted so that the side with the two bumps is facing the back of the case, and the surface with the wear ribs is facing the bottom of the case.

7. Hold the upper latch assembly in place while you snap the new latch button in from underneath the base, making certain the snap tabs are fully engaged in the slider.
  8. Ensure that the newly installed latch assembly moves smoothly and freely when pushed and released.
- 

## Fan Assembly

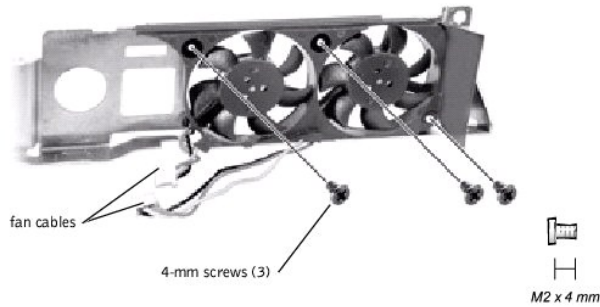

- ➔ **NOTICE:** Disconnect the computer and attached devices from electrical outlets and remove any installed battery.
- ➔ **NOTICE:** To avoid ESD, ground yourself by using a wrist grounding strap or by periodically touching an unpainted metal surface on the computer.

## Removing the Fan Assembly

1. Follow the instructions in "[Preparing to Work Inside the Computer.](#)"
2. Remove the [system board](#).
3. Remove the three 4-mm screws from the fan assembly.
4. Disconnect the two fan cables from the system board.
5. Pull the fan assembly away from the back-panel bracket.

- ➔ **NOTICE:** When reconnecting the fan cables, connect the shorter cable to the connector closest to the fan assembly. Route both cables so that they will not be pinched by the thermal cooling assembly.
- 

## RJ-11/RJ-45 Board

- ➔ **NOTICE:** Disconnect the computer and attached devices from electrical outlets and remove any installed battery.
- ➔ **NOTICE:** To avoid ESD, ground yourself by using a wrist grounding strap or by periodically touching an unpainted metal surface on the computer.

## Removing the Protective Covers From the RJ-11 and RJ-45 Connectors

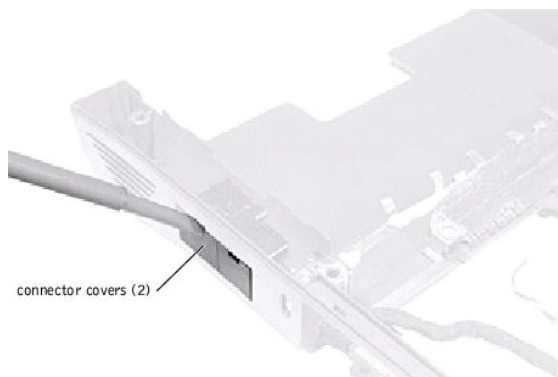

1. Follow the instructions in "[Preparing to Work Inside the Computer.](#)"
2. Remove one or both of the plastic connector covers (one or both of the covers may be installed) by slipping a nonmarring tool into the cutout at the top and pivoting the tool up to disengage the inner securing tab.

To replace a connector cover, orient the cover notch-side-up and snap it into the connector cutout.

## Removing the RJ-11/RJ-45 Board

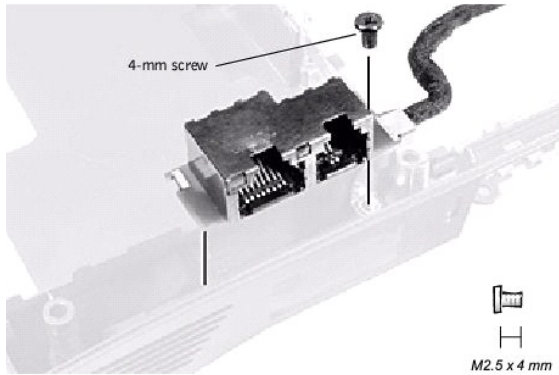

1. Follow the instructions in "[Preparing to Work Inside the Computer.](#)"
2. Remove the [system board](#).
3. Remove the 4-mm screw from the RJ-11/RJ-45 board.

➔ **NOTICE:** The plastic tab is fragile; pull it back only far enough to remove the board assembly.

4. Reach into the enclosure and, while pulling the tall plastic tab away from the board assembly to release it, lift out the assembly.

When replacing the RJ-11/RJ-45 board assembly, protect the wiring harness by routing it between the plastic posts as shown in the following figure.

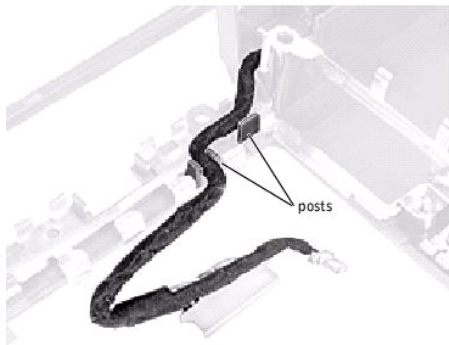

[Back to Contents Page](#)

## System Setup Program

Dell™ Inspiron™ 2500 Systems

- [Standard Settings](#)
- [System Setup Program Pages](#)
- [Viewing the System Setup Program Pages](#)

### Standard Settings

The system setup program contains the standard settings for your computer.

 **NOTICE:** Unless you are an expert computer user, don't change the settings for this program. Certain changes might make your computer work incorrectly.

### System Setup Program Pages

The system setup screens are organized into the following sections:

- 1 The menu bar at the top provides access to the main program screens:
  - o Main provides settings for the basic computer configuration.
  - o System Devices provides detailed settings for some computer features.
  - o Security provides indications and settings for user and setup passwords.
  - o Boot provides information about how the computer starts.
  - o Exit provides selections for saving and loading the program settings.
- 1 The left side lists configuration options and their settings for the hardware installed in your computer.

 **HINT:** To see information about a specific item, highlight the item and refer to the **Item Specific Help** area on the screen.

You can change settings enclosed in brackets, but not those that are grayed out. Options identified by an arrowhead (>) provide access to submenus.

See the following figure for an example of the Main screen of the program.

PhoenixBIOS Setup Utility							
Main	System Devices	Security	Boot	Exit			
System Time [00:06:57]				<b>Item Specific Help</b>  <Tab>, <Shift-Tab>, or <Enter> selects field. Select appropriate field [HH:MM:SS] and enter value in 24-hour format.			
System Date: [11/09/99]							
Floppy Drive: 1.44/1,25 MB 31/2"							
Hard Disk: [2004MB]							
S/N: 10WWEF							
Quiet Boot: [Enabled]							
Video Display Device: [Simul Mode]							
System Memory: 640 KB							
Extended Memory: 126 MB							
Service Tag Number:							
Visit our Website http://www.dell.com							
F1	Help	↓↑ Select Item	F5/F6		Change Values	F9	Setup Defaults
ESC	Exit	↔ Select Menu	Enter		Select > Sub-Menu	F10	Save and Exit

### Viewing the System Setup Program Pages

1. Turn on (or restart) your computer.

 **HINT:** External USB keyboards function only when a Windows® operating system is running.

2. When the blue Dell logo appears, press <F2> immediately.

If you wait too long and the operating system logo appears, continue to wait until you see the Windows desktop. Then shut down your computer and try again.

---

[Back to Contents Page](#)



[Back to Contents Page](#)

## Solving Problems

Dell™ Inspiron™ 2500 Systems

- [Accessing Help Files](#)
- [Power Problems](#)
- [Start-Up Error Messages](#)
- [Video and Display Problems](#)
- [Sound and Speaker Problems](#)
- [Printer Problems](#)
- [Modem Problems](#)
- [Scanner Problems](#)
- [Touch Pad Problems](#)
- [External Keyboard Problems](#)
- [Unexpected Characters](#)
- [Drive Problems](#)
- [Network Problems](#)
- [Windows® Error Messages](#)
- [General Program Problems](#)
- [E-Mail Problems](#)
- [If Your Computer Gets Wet](#)
- [If You Drop or Damage Your Computer](#)
- [Resolving Other Technical Problems](#)

---

## Accessing Help Files

To access the *Tell Me How* help file

1. Click the **Start** button, point to **Programs**, point to **User's Guides**, and then click **Tell Me How**.

To access *Microsoft® Windows® 2000 Help*

1. Click the **Start** button and then click **Help**.
2. Click the **Search** tab.
3. Type a word or phrase that describes your problem and then click **List Topics**.
4. Click the topic that describes your problem and then click **Display**.
5. Follow the instructions shown on the screen.

To access *Windows Millennium Edition (Me) Help*

1. Click the **Start** button and then click **Help**.
2. Type a word or phrase that describes your problem in the **Search** box and then click **Go**.
3. Click the topic that describes your problem and then click **Display**.
4. Follow the instructions shown on the screen.

---

## Power Problems

 **HINT:** See the [Tell Me How](#) help file for information on standby mode.

**Check the power light**— When the power light is lit or blinking, the computer has power. If the power light is blinking, the computer is in standby mode—press the power button to exit standby mode. If the power light is off, press the power button.

**Check the battery**— If you are using a battery to power your computer, the battery charge may be depleted. Connect the computer to an electrical outlet using the AC adapter, and turn on the computer.

**Test the electrical outlet**— Ensure that the electrical outlet is working by testing it with another device, such as a lamp.

**Check the AC adapter**— Be sure that the power cable is firmly inserted into the electrical outlet and the green light on the AC adapter is on.

**Connect the computer directly to an electrical outlet**— Bypass power protection devices, power strips, and the extension cable to verify that the computer turns on.

**Check for interference**— Electrical appliances on the same circuit or operating near the computer can cause interference. Other causes of interference: power extension cables, too many devices on a power strip, or multiple power strips connected to the same electrical outlet.

**Adjust the Power Properties**— See the [Tell Me How](#) help file or search for the keyword *standby* in [Windows Help](#).

**Reseat the memory modules**— If your computer power light turns on but the display remains blank, you may need to [reseat the memory modules](#).

---

## Start-Up Error Messages

---

<b>Operating system not found</b> — Contact Dell for technical assistance. See "Contacting Dell" in the Dell <i>Solutions Guide</i> that came with your computer for the correct contact information.
<b>Insert bootable media</b> — The operating system is trying to boot to a nonbootable floppy disk or CD. Insert a bootable floppy disk or CD.
<b>Non-system disk error</b> — A floppy disk is in the floppy drive. Remove the floppy disk and restart the computer.

## Video and Display Problems

### If the display is blank

<b>Check the power light</b> — When the power light is lit or blinking, the computer has power. If the power light is blinking, the computer is in standby mode—press the power button to exit standby mode. If the power light is off, press the power button.
<b>Check the battery</b> — If you are using a battery to power your computer, the battery charge may be depleted. Connect the computer to an electrical outlet using the AC adapter, and turn on the computer.
<b>Test the electrical outlet</b> — Ensure that the electrical outlet is working by testing it with another device, such as a lamp.
<b>Check the AC adapter</b> — Be sure that the power cable is firmly inserted into the electrical outlet and the green light on the AC adapter is on.
<b>Adjust the power properties</b> — Search for the keyword <i>standby</i> in <a href="#">Windows Help</a> .

### If the display is difficult to read

<b>Adjust the brightness</b> — See the <a href="#">Tell Me How</a> help file for instructions on adjusting the brightness.
<b>Move the subwoofer away from the computer or monitor</b> — If your external speaker system includes a subwoofer, ensure that the subwoofer is at least 60 cm (2 ft) away from the computer or external monitor.
<b>Eliminate possible interference</b> — Turn off nearby fans, fluorescent lights, or halogen lamps to check for interference.
<b>Rotate the computer to face a different direction</b> — Eliminate sunlight glare, which can cause poor picture quality.
<b>Restore the recommended settings</b> — Restore the original resolution and refresh rate settings. See the <a href="#">Tell Me How</a> help file for instructions.
<b>Adjust the Windows display settings</b> <ol style="list-style-type: none"> <li>1. Click the <b>Start</b> button, point to <b>Settings</b>, and then click <b>Control Panel</b> (double-click <b>Control Panel</b> in Windows 2000).</li> <li>2. Double-click the Display icon and then click the Settings tab.</li> <li>3. Try different settings for Colors and Screen area.</li> </ol>

## Sound and Speaker Problems

### Integrated Speakers

<b>Adjust the Windows volume control</b> — Double-click the yellow speaker icon in the lower-right corner of your screen. Be sure that the volume is turned up and that the sound is not muted.
<b>Check the volume control buttons</b> — Press both volume control buttons simultaneously or press <Fn><End> to disable (mute) or reenable the integrated speakers.
<b>Reinstall the sound (audio) driver</b> — See " <a href="#">Reinstalling Drivers and Utilities</a> ."

### External Speakers

 **HINT:** The volume control in some MP3 players overrides the Windows volume setting. If you have been listening to MP3 songs, make sure that you did not turn the player volume down or off.

<b>Verify the speaker cable connections</b> — Ensure that the speakers are connected as shown on the setup diagram supplied with the speakers.
<b>Test the electrical outlet</b> — Ensure that the electrical outlet is working by testing it with another device, such as a lamp.
<b>Ensure that the speakers are turned on</b> — See the setup diagram supplied with the speakers.
<b>Adjust the speaker controls</b> — Adjust the volume, bass, or treble controls to eliminate distortion.
<b>Adjust the Windows volume control</b> — Double-click the yellow speaker icon in the lower-right corner of your screen. Be sure that the volume is turned up and that the sound is not muted.
<b>Test the speakers</b> — Plug the speaker audio cable in to the headphone connector on the side of the computer. Ensure that the headphone volume is turned up. Play a music CD.

<b>Run the speaker self-test</b> — Some speaker systems have a self-test button on the subwoofer. See the speaker documentation for self-test instructions.
<b>Move the subwoofer away from the computer or monitor</b> — If your external speaker system includes a subwoofer, ensure that the subwoofer is at least 60 cm (2 ft) away from the computer or external monitor.
<b>Eliminate possible interference</b> — Turn off nearby fans, fluorescent lights, or halogen lamps to check for interference.
<b>Reinstall the sound (audio) driver</b> — See " <a href="#">Reinstalling Drivers and Utilities</a> ."

## Printer Problems

### If you cannot print to a parallel port printer

<b>Verify the printer cable connections</b> — Ensure that the printer cable is connected (see "Connecting a Printer" in the Dell Solutions Guide that came with your computer).
<b>Test the electrical outlet</b> — Ensure that the electrical outlet is working by testing it with another device, such as a lamp.
<b>Ensure that the printer is turned on</b> — See the documentation supplied with the printer.
<b>Verify that the printer is recognized by Windows</b> <ol style="list-style-type: none"> <li>Click the <b>Start</b> button, point to <b>Settings</b>, and then click <b>Printers</b>.  If the printer is listed, right-click the printer icon, click <b>Properties</b>, and then select the <b>Details</b> tab.</li> <li>Ensure that the <b>Print to the following port</b>: setting is <b>LPT1 (Printer Port)</b>.</li> </ol>
<b>Reinstall the printer driver</b> — See "Installing the Printer Driver" in the Dell Solutions Guide that came with your computer.

### If you cannot print to a USB printer

<b>Verify the printer cable connections</b> — Ensure that the printer cable is connected correctly.
<b>Test the electrical outlet</b> — Ensure that the electrical outlet is working by testing it with another device, such as a lamp.
<b>Ensure that the printer is turned on</b> — See the documentation supplied with the printer.
<b>Verify that the printer is recognized by Windows</b> <ol style="list-style-type: none"> <li>Click the <b>Start</b> button, point to <b>Settings</b>, and then click <b>Printers</b>.  If the printer is listed, right-click the printer icon, click <b>Properties</b>, and then select the <b>Details</b> tab.</li> <li>Ensure that the <b>Print to the following port</b>: setting is <b>USB</b>.</li> </ol>
<b>Reinstall the printer driver</b> — See "Installing the Printer Driver" in the Dell Solutions Guide that came with your computer.

## Modem Problems

 **NOTICE:** Connect the modem to an analog telephone wall jack only. Connecting the modem to a digital telephone network damages the modem.

<b>Check the telephone jack</b> — Disconnect the telephone cable from the modem and connect it to a telephone. Listen for a dial tone.
<b>Connect the modem directly to the telephone wall jack</b> — If you have other telephone devices sharing the line, such as an answering machine, fax machine, surge protector, or line splitter, then bypass them and connect the modem directly to the telephone wall jack with the telephone cable.
<b>Check the connection</b> — Verify that the telephone cable is connected to the modem.
<b>Check the telephone cable</b> — Try using a different telephone cable. If you are using a line that is 3 m (10 ft) or more in length, try a shorter one.
<b>Verify that the modem is communicating with Windows</b> <ol style="list-style-type: none"> <li>Click the Start button, point to Settings, and click Control Panel (double-click <b>Control Panel</b> in Windows 2000).</li> <li>In the Control Panel window, double-click Modems.  If there are multiple entries for the same modem or modems listed that are not installed, delete the entries and restart the computer.</li> <li>Click the Diagnostics tab.</li> <li>Click the COM port for your modem.</li> <li>Click More Info to verify that the modem is communicating with Windows. If all commands receive responses, the modem is operating properly.</li> </ol>

---

## Scanner Problems

**Check the power cable connection**— Ensure that the scanner power cable is firmly connected to a working electrical power source and that the scanner is turned on.

**Check the scanner cable connection**— Ensure that the scanner cable is firmly connected to the computer and to the scanner.

**Unlock the scanner**— Ensure that your scanner is unlocked if it has a locking tab or button.

**Reinstall the scanner driver**— See the scanner documentation for instructions.

---

## Touch Pad Problems

**Check the touch pad settings**— Click the **Start** button, point to **Settings**, click **Control Panel** (double-click **Control Panel** in Windows 2000), and then double-click the **Mouse** icon. Try adjusting the settings.

---

## External Keyboard Problems

**Disconnect the keyboard cable**— Shut down the computer. Disconnect the keyboard cable and check the cable connector for bent or broken pins.

---

## Unexpected Characters

**Disable the numeric keypad**— Press the <Num Lk> key to disable the numeric keypad. Verify that the numbers lock light is not lit.

---

## Drive Problems

 **HINT:** For information on saving files to a floppy disk, see the [Tell Me How](#) help file.

### If you cannot save a file to a floppy disk

**Ensure that Windows recognizes the drive**— Double-click the My Computer icon. If the floppy drive is not listed, perform a full scan with your antivirus software to check for and remove viruses. Viruses can sometimes prevent Windows from recognizing the drive.

**Cannot save files to a floppy disk**— Ensure that the floppy disk is not full or write-protected (locked). See the following illustration.

**Test the drive with another floppy disk**— Insert another floppy disk to eliminate the possibility that the original floppy disk is defective.

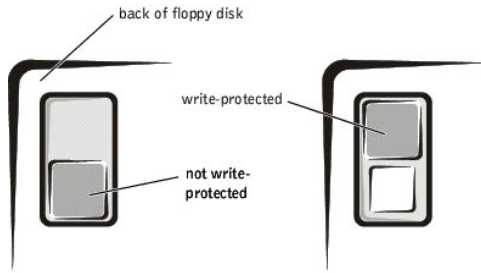

## If you cannot play a music CD or install a program from a CD

**HINT:** High-speed CD drive vibration is normal and may cause noise. This noise does not indicate a defect in the drive or the CD.

**Ensure that Windows recognizes the drive—** Double-click the My Computer icon. If the CD drive is not listed, perform a full scan with your antivirus software to check for and remove viruses. Viruses can sometimes prevent Windows from recognizing the drive.

**Test the drive with another CD—** Insert another CD to eliminate the possibility that the original CD is defective.

**Clean the disc—** See the [Tell Me How](#) help file for instructions.

**Adjust the Windows volume control—** Double-click the yellow speaker icon in the lower-right corner of your screen. Be sure that the volume is turned up and that the sound is not muted.

## If you cannot play a DVD movie

**HINT:** Because of different worldwide file types, not all DVD titles work in all DVD drives.

**Ensure that Windows recognizes the drive—** Double-click the My Computer icon. If the DVD drive is not listed, perform a full scan with your antivirus software to check for and remove viruses. Viruses can sometimes prevent Windows from recognizing the drive.

**Test the drive with another DVD—** Insert another DVD to eliminate the possibility that the original DVD is defective.

**Clean the disc—** See the [Tell Me How](#) help file for instructions.

## If the CD-RW drive stops writing

**HINT:** If you must disable standby mode to write to a CD-RW drive, remember to enable standby mode again when you finish writing the CD.

**Disable standby mode in Windows before writing to a CD-RW disk—** Search for the keyword *standby* in [Windows Help](#).

**Change the write speed to a slower rate—** The CD-RW drive must receive a steady stream of data when writing. If the stream is interrupted, an error occurs. Closing all programs before writing to the CD-RW may also alleviate the problem.

## If you have a hard drive problem

### Check the hard drive for errors

*Windows Me:*

Click the **Start** button, point to **Programs**—> **Accessories**—> **System Tools**, and then click **ScanDisk**.

*Windows 2000:*

1. Double-click the **My Computer** icon.
2. Right-click the **Local Disk** icon and then click **Properties**.
3. Click the **Tools** tab.
4. Click **Check Now**.

## Network Problems

**Check the network cable connector—** Ensure that the network cable connector is firmly connected to the connector on the

computer and the network wall jack.

**Check the network lights on the network connector**— Green indicates that the network connection is active. If the status light is not green, try replacing the network cable. Amber indicates that the network card driver is loaded and the card is detecting activity.

**Restart the computer**— Try to log on to the network again.

**Contact your network administrator**— Verify that your network settings are correct and that the network is functioning.

---

## Windows® Error Messages

**x:\ is not accessible. The device is not ready**— Insert a disk into the drive and try again.

**A filename cannot contain any of the following characters: \ / : \* ? " < > |**— Do not use these characters in filenames.

**Not enough memory or resources. Close some programs and try again**— You have too many programs open. Close all windows and open the program that you want to use.

**The file being copied is too large for the destination drive**— The file that you are trying to copy is too large to fit on the disk, or the disk is too full. Try copying the file to a different disk or use a larger capacity disk.

**A required .DLL file was not found**— The program that you are trying to open is missing an essential file. To remove and then reinstall the program:

*Windows Me:*

1. Click the **Start** button, point to **Settings**, and then click **Control Panel**.
2. Double-click the **Add/Remove Programs** icon.
3. Select the program that you want to remove.
4. Click **Add/Remove** and follow the prompts on the screen.
5. See the program documentation for installation instructions.

*Windows 2000:*

1. Click the **Start** button, point to **Settings**, and then double-click **Control Panel**.
  2. Double-click the **Add/Remove Programs** icon.
  3. Select the program that you want to remove.
  4. Click **Change/Remove** and follow the prompts on the screen.
  5. See the program documentation for installation instructions.
- 

## General Program Problems

### A program crashes

**See the software documentation**— Many software manufacturers maintain websites with information that may help you to solve the problem.

### A program stops responding

Press <Ctrl><Alt><Delete>

*Windows Me:*

In the **Close Program** window, select the program that is no longer responding. Then click **End Task**.

*Windows 2000:*

In the **Task Manager** window, select the program that is no longer responding. Then click **End Task**.

### A solid blue screen appears

**Turn the computer off**— If the computer does not respond to a keystroke or a proper shutdown, press the power button until the computer turns off. Press the power button again to restart the computer. The solid blue screen appears because you were not able to perform a proper Windows shutdown. ScanDisk will automatically run during the start-up process. Follow the instructions on the screen.

---

## E-Mail Problems

**Ensure that you are connected to the Internet**— With the Outlook Express e-mail program open, click **File**. If **Work Offline** has a check next to it, click the check to remove it and connect to the Internet.

---

## If Your Computer Gets Wet

**⚠ CAUTION:** Perform this procedure only after you are certain that it is safe to do so. If the computer is connected to an electrical outlet, Dell recommends that you turn off AC power at the circuit breaker before attempting to remove the power cables from the electrical outlet. Use the utmost caution when removing wet cables from a live power source.

1. Turn off the computer, disconnect the AC adapter from the computer, and disconnect the AC adapter from the electrical outlet.
2. Turn off any attached external devices, and disconnect them from their power sources and then from the computer.
3. Ground yourself by touching one of the metal connectors on the back of the computer.
4. Remove the media bay device and any installed PC Cards, and put them in a safe place to dry.
5. Remove the [battery](#).
6. Wipe off the battery and put it in a safe place to dry.
7. Remove the [hard drive](#).
8. Remove the [memory modules](#).
9. Open the display and place the computer right-side up across two books or similar props to let air circulate all around it. Let the computer dry for at least 24 hours in a dry area at room temperature.

**🔊 NOTICE:** Do not use artificial means, such as a hair dryer or a fan, to speed up the drying process.

**⚠ CAUTION:** To help prevent electrical shock, verify that the computer is thoroughly dry before continuing with the remainder of this procedure.

10. Ground yourself by touching one of the metal connectors on the back of the computer.
11. Replace the [memory modules](#), the memory module cover, and the screw.
12. Replace the [hard drive](#).
13. Replace the media bay device and any PC Cards you removed.
14. Replace the battery.
15. Turn on the computer and verify that it is working properly.

If the computer does not start, or if you cannot identify the damaged components, contact Dell for technical assistance. Locate the correct contact information in "Contacting Dell" of the Dell *Solutions Guide* that came with your computer.

---

## If You Drop or Damage Your Computer

1. Save and close any open files, exit any open programs, and shut down the computer.
2. Disconnect the AC adapter from the computer, and disconnect the AC adapter from the electrical outlet.
3. Turn off any attached external devices, and disconnect them from their power sources and then from the computer.
4. Remove and reinstall the battery.
5. Turn on the computer.

If the computer does not turn on, or if you cannot identify the damaged components, contact Dell for technical assistance. Locate the correct contact information in "Contacting Dell" of the Dell *Solutions Guide* that came with your computer.

---

## Resolving Other Technical Problems

**Go to the Dell support website**— Go to <http://support.dell.com> for help with general usage, installation, and troubleshooting questions.

**E-mail Dell**— Go to <http://support.dell.com> and then click **E-Mail Dell** in the **Communicate** list. Send an e-mail message to Dell about your problem; you can expect to receive an e-mail message from Dell within hours.

**Call Dell**— If you cannot solve your problem using the Dell support website or e-mail service, contact Dell for technical assistance. Locate the correct contact information in "Contacting Dell" of the Dell *Solutions Guide* that came with your computer.

---

[Back to Contents Page](#)



[Back to Contents Page](#)

## System Specifications

### Dell™ Inspiron™ 2500 Systems

- [Microprocessor](#)
- [System Information](#)
- [PC Card](#)
- [Memory](#)
- [Ports and Connectors](#)
- [Video](#)
- [Audio](#)
- [Display](#)
- [Keyboard](#)
- [Touch Pad](#)
- [Modem](#)
- [Battery](#)
- [AC Adapter](#)
- [Environmental](#)
- [Fixed Optical Drives](#)

Microprocessor	
Microprocessor type	Intel® Mobile Pentium® III or Mobile Celeron™
L1 cache	32 KB (Internal)
L2 cache	256 KB or 128 KB
Math coprocessor	internal to microprocessor

System Information	
System chip set	Intel 815EM
Data bus width	64 bits
DRAM bus width	64 bits
Microprocessor address bus width	32 bits
Flash EPROM	2 MB
Graphics bus width	Integrated Intel 3D AGP Graphics

PC Card	
CardBus controller	O2Micro OZ6933 CardBus controller
PC Card connectors	two (supports two Type I or Type II cards or one Type III card)
Cards supported	3.3 V and 5 V
PC Card connector size	68 pins
Data width (maximum)	PCMCIA: 16 bits CardBus: 32 bits

Memory	
Architecture	SDRAM
Memory module socket	two user-accessible SODIMM sockets
Memory module capacities	32-, 64-, 128-, and 256-MB 3.3-V SDRAM SODIMMS
Standard memory	64 MB (non-ECC)
Maximum memory	512 MB (non-ECC)
Memory clock speed	100 MHz
Memory access time	CL2/3 (NOTE: CL2/3 indicates a CAS latency of two or three clocks.)

Ports and Connectors	
Serial	9-pin connector, RS232; 16550-compatible, 16-byte buffer connector
Parallel	unidirectional (standard AT), bidirectional, or ECP connector
Video	VGA connector
Audio	stereo (line-in) mini connector; microphone mini connector; headphone/speakers (line-out) mini connector

PS/2 keyboard/mouse	6-pin mini-DIN connector
USB	two USB-compliant connectors
Modem/network adapter	optional factory-configurable RJ-11/RJ-45 (optional) connectors for Mini PCI card modem/network adapter

<b>Video</b>	
Video type	128-bit hardware-accelerated video support
Data bus	Integrated Intel 3D AGP Graphics
Video controller	Integrated graphics (Intel 815EM)
Display cache	optional factory-configurable 4-MB display cache card
LCD interface	LVDS

<b>Audio</b>	
Audio controller	AC97 link audio
Stereo conversion	16-bit (analog-to-digital and digital-to-analog)
Interfaces:	
Internal	PCI bus/AC 97
External	stereo (line-in), microphone, headphones/speaker (line-out)

<b>Display</b>	
Type	128-bit hardware-accelerated video support
Response time (typical)	50 ms
Operating angle	0° (closed) to 180°
Dot pitch	0.20 mm
Panel (typical)	1.3 W
Backlight	3.4 W using battery; 4.9 W using AC adapter
Controls	brightness can be controlled through key combinations

<b>Keyboard</b>	
Number of keys	87 (U.S., Canada, and locations that use traditional Chinese); 88 (Europe); 90 (Japan)
Key travel	2.7 ± 0.3 to 0.4 mm (0.11 ± 0.016 inch)
Key spacing	19.05 ± 0.3 mm (0.75 inch ± 0.012 inch)
Layout	QWERTY/AZERTY/Kanji

<b>Touch Pad</b>	
Interface	PS/2 compatible
X/Y position resolution (graphics table mode)	240 cpi
Size:	
Thickness	2.00 mm (0.08 inch) at highest component
Width	64.88 mm (2.55 inch)
Height	48.88-mm (1.92-inch) rectangle with 0.5-mm (0.02-inch) tabs
Weight	6.5 g (0.23 ounce) ± 0.5 g (0.001 ounce)
Power:	
Supply voltage	5 V ± 0.5 VDC
Supply current	25 mA (maximum operating current)
ESD	in accordance with IEC-801-2

<b>Modem</b>	
Data/fax modem	optional 56K, V.90 mini-PCI card modem

Data/fax network adapter	optional 10/100 LAN + 56K, V.90 mini-PCI card modem
--------------------------	---

<b>Battery</b>	
Type	4-cell and 8-cell lithium ion
Dimensions:	
Depth	88.5 mm (3.48 inches)
Height	21.5 mm (0.83 inch)
Width	139.0 mm (5.47 inches)
Weight	8 cell; 0.39 kg (0.87 lb)
Voltage	14.8 VDC
Charge time (approximate):	
Computer on	2.5 hours
Computer off	1 hour
Battery life	up to 1.5 hours with a 4-cell battery up to 3 hours with an 8-cell battery
Life span (approximate)	400 discharge/charge cycles <sup>0</sup>
Temperature range:	
Operating	0° to 45°C (32° to 113°F)
Storage	-20° to 60°C (-4° to 140°F)

<b>AC Adapter</b>	
Input voltage	90 to 135 VAC and 164 to 264 VAC
Input current (maximum)	1.5 A
Input frequency	40 to 63 Hz
Output current	4.5 A (maximum 4-second pulse); 3.5 A (continuous)
Rated output voltage	20 VDC
Dimensions:	
Height	27.94 mm (1.1 inches)
Width	58.42 mm (2.3 inches)
Depth	133.85 mm (5.25 inches)
Weight (with cables)	0.4 kg (0.9 lb)
Temperature range:	
Operating	0° to 40°C (32° to 104°F)
Storage	-4° to 65°C (24.8° to 149°F)

<b>Environmental</b>	
Temperature range:	
Operating	0° to 35°C (32° to 95°F)
Storage	-4° to 65°C (24.8° to 149°F)
Relative humidity (maximum):	
Operating	10% to 90% (noncondensing)
Storage	5% to 95% (noncondensing)
Maximum vibration:	
Operating	0.9 GRMS using a random-vibration spectrum that simulates user environment
Storage	1.3 GRMS using a random-vibration spectrum that simulates air/truck shipment
Maximum shock:	
Operating	152.4 cm/sec (60 inches/sec) (equal to a half-sine pulse width of 2 ms)
Storage	2.03 m/sec (80 inches/sec) (less than or equal to a pulse width of 2 ms)
Altitude (maximum):	
Operating	-15.2 to 3048 m (-50 to 10,000 ft)
Storage	-15.2 to 10,668 m (-50 to 35,000 ft)

<b>Fixed Optical Drives</b>	
Supported drives	12.5-mm drives: CD, CD-RW, and DVD

---

[Back to Contents Page](#)

[Back to Contents Page](#)

## A Tour of Your Computer

Dell™ Inspiron™ 2500 Systems

- [Front View](#)
  - [Left Side View](#)
  - [Right Side View](#)
  - [Back View](#)
- 

### Front View

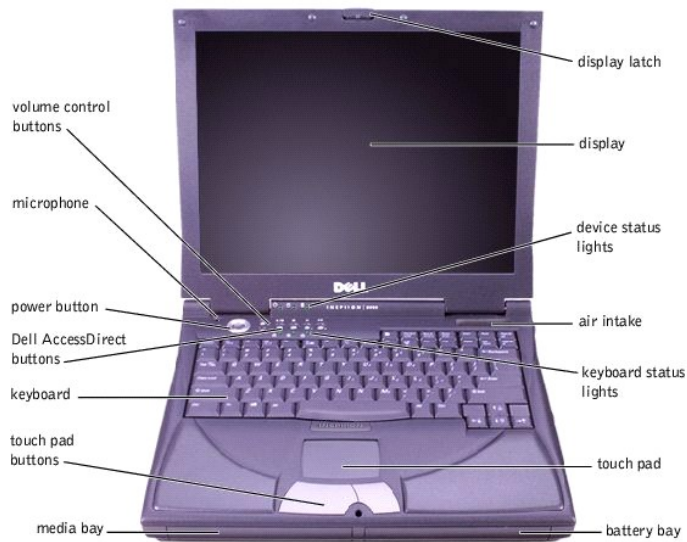

### Display Latch

This latch keeps the display locked in place when the display is closed.



### Display

The computer has a color LCD.

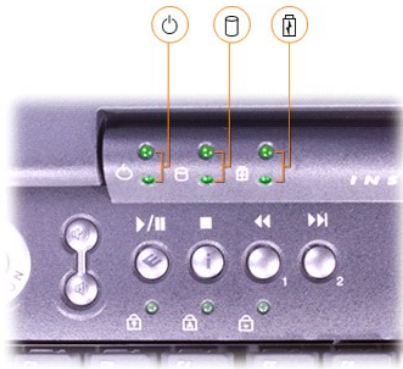
### Device Status Lights



The lights below the display indicate the following:

- 1 The light labeled  turns on when the computer is turned on and blinks when the computer is in standby mode.
- 1 The light labeled  turns on steadily or blinks to indicate the battery charge status. Indicator states include:
  - o Off, which indicates that the computer is operating on battery power or that the computer is turned off
  - o Flashing green, which indicates that the battery is charging or that the battery power is low
  - o Solid green, which indicates that the battery is fully charged and that the computer is operating on AC power
  - o Flashing amber, which indicates that the battery power is critically low
- 1 The light labeled  turns on when the computer reads data from or writes data to any drive.



**NOTICE:** To avoid data loss, never turn off the computer while the green light labeled  is flashing.

## Air Intake

 **HINT:** The computer turns on the fans only when the computer gets hot. They may run most of the time or very seldom, depending on your use of the computer. Because the fans spin at a high rate of speed, they may make a noise. This noise is normal and does not indicate a problem with the fans or the computer.

The fans work with the air intakes to prevent the computer from overheating. When the computer gets hot, the small internal fans turn on and draw air through the air intakes to cool the computer. Hot air is expelled through the [fan exhausts](#).

 **CAUTION:** Do not push objects into or block the air intakes. Doing so can cause fire or damage the interior components. Keep the openings free from dust and other foreign particles.

## Keyboard Status Lights

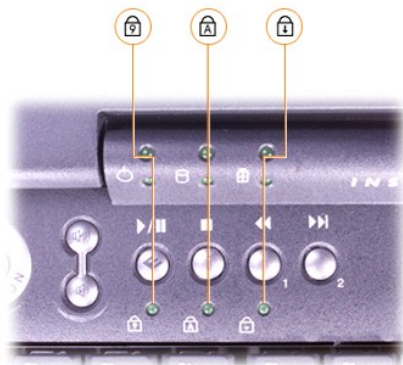

The green lights located above the keyboard indicate the following:

- 1 The light labeled  turns on when you press  to enable the numeric keypad.
- 1 The light labeled  turns on when you press  to enable the uppercase letter function.
- 1 The light labeled  turns on when you press   to enable the scroll lock function.

## Touch Pad

The touch pad detects the position of your finger over a touch-sensitive area and provides the computer with full mouse functionality.

## Battery Bay

With a charged battery in this bay, you can use the computer without plugging it in to an electrical outlet.

## Media Bay

You can install devices such as a floppy drive, an internal Zip drive, or a Dell TravelLite™ travel module in the media bay.

## Touch Pad Buttons

These buttons correspond to the left and right buttons on a standard mouse.

## Keyboard

The keyboard includes a numeric keypad as well as the Microsoft® Windows® logo key that supports the Windows operating systems.

## Dell AccessDirect™ Buttons

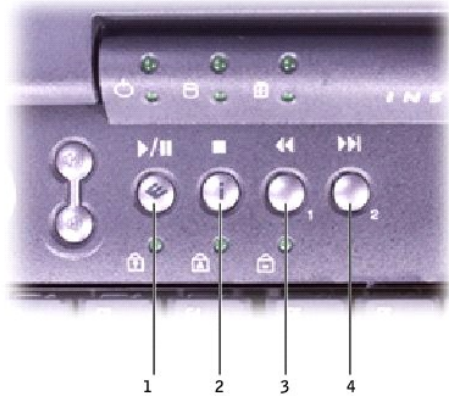

 **HINT:** To launch the Dell Solution Center, the computer must be turned on and functioning properly.

1	Press this button to launch the Dell Solution Center, where you can find support and educational tools that Dell has installed on your computer.
2	Press this button to launch your default Internet browser.
3	Press this button to launch <a href="http://www.dell.com">http://www.dell.com</a> , or reprogram the button to launch a program of your choice.
4	Press this button to open your default e-mail program, reprogram the button to launch a program of your choice.

You can also reprogram the button scheme to control CD or DVD player functions.

## Power Button

 **HINT:** To turn off your computer, perform a Windows shutdown.

Press the power button to turn on the computer.

If the computer stops responding, press and hold the power button until the computer turns off completely (this may take several seconds).

## Microphone

The internal microphone allows you to record voice audio.

## Volume Control Buttons

Increase or decrease the speaker volume with the volume control buttons. You can also change the speaker volume using key combinations:

- 1 To increase the volume, press the <Fn> and the <Page Up> keys.
- 1 To decrease the volume, press the <Fn> and the <Page Dn> keys.
- 1 To enable or disable (mute) the integrated stereo speakers or external speakers, press <Fn> and the <End> keys.

 **HINT:** If no sound comes from the speakers, press <Fn> and <End> and check the volume control buttons to make sure that the sound is not disabled.

When you mute music, the computer may take a moment to respond.

---

## Left Side View



## Security Cable Slot

The slots (one on each side of the computer) let you attach a commercially available antitheft device to the computer. Complete instructions for installing antitheft devices are usually included with the device.

 **NOTICE:** Antitheft devices are of differing designs. Before you buy one, make sure it will work with the security cable slot in the computer.

## Speakers

Your computer has integrated speakers. Press the volume control buttons to adjust the speaker volume.

## Fixed Optical Drive

Your computer supports a CD drive, DVD drive, or CD-RW drive.

---



## Right Side View

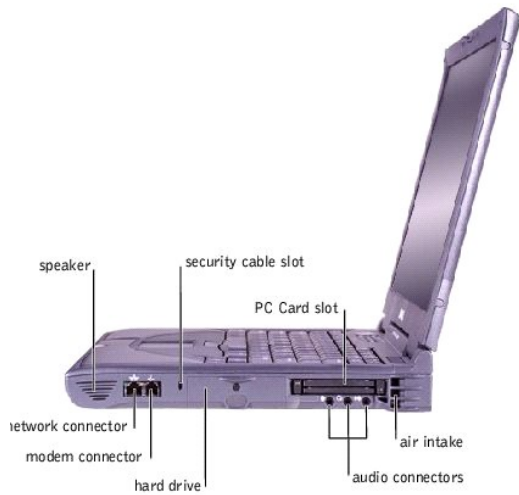



## Audio Connectors



- 1 Attach record/playback devices such as a cassette player or CD player to the  connector.
- 1 Attach headphones or speakers to  connector.
- 1 Attach a microphone to the  connector.

## Hard Drive

The hard drive reads and writes data on a hard disk.

## Modem Connector



If you ordered the optional internal modem, use this connector to plug in the telephone cable.

## Network Connector (Optional)



If you ordered the optional integrated network adapter, use this connector to connect the computer to a network. If a network cable is connected to the network connector, the green light indicates that the network connection is active. If you do not see a green light after connecting a network cable, try replacing the network cable. An amber light indicates that the network adapter driver is loaded and the adapter is detecting activity.

## Security Cable Slot



The slots (one on each side of the computer) let you attach a commercially available antitheft device to the computer. Complete instructions for installing antitheft devices are usually included with the device.

**NOTICE:** Antitheft devices are of differing designs. Before you buy one, make sure it will work with the security cable slot in the computer.

## PC Card Slot

The PC Card slot has two connectors that support various types of PC Cards, including modems and network cards.

## Back View

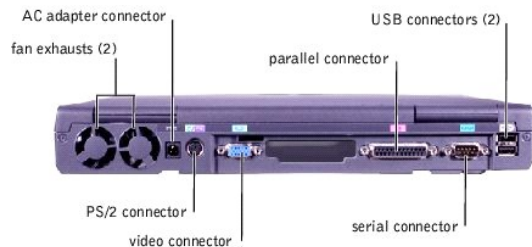

## Fan Exhausts

**HINT:** The computer turns on the fan only when the computer gets hot. It may run most of the time or very seldom, depending on your use of the computer. Because the fan spins at a high rate of speed, it may make a noise. This noise is normal and does not indicate a problem with the fan or the computer.

The fan works with the air intake to prevent the computer from overheating. When the computer gets hot, the small internal fan turns on and draws air through the air intake to cool the computer. Hot air is expelled through the fan exhaust.

**CAUTION:** Do not push objects into or block the air intake. Doing so can cause fire or damage interior components. Keep the opening free from dust and other foreign particles.

## AC Adapter Connector

Use this connector to attach an AC adapter to the computer.



**HINT:** Although the AC adapter works worldwide, power connectors vary among countries. Before using the AC adapter in a foreign country, you may need to obtain a new power cable designed for use with the electrical outlets in that country.

The AC adapter converts AC power to the DC power required by the computer. You can connect the AC adapter with your computer either turned on or off.

**NOTICE:** When you disconnect the AC adapter from the computer, grasp the adapter cable connector, not the cable itself, and pull firmly but gently to avoid damaging the cable.

### PS/2 Connector

	Use this connector to attach PS/2-compatible devices such as a mouse, keyboard, or external numeric keypad to your computer.
---	--

### Video Connector

	Use this connector to attach an external monitor to the computer.
---	---

### Parallel Connector

	Use this connector to attach a parallel device, such as a printer, to the computer.
---	---

### USB Connectors

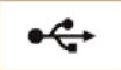
	Use these connectors to attach USB-compatible devices such as a mouse, docking device, keyboard, printer, or scanner to your computer.
---	--

### Serial Connector

	Use this connector to attach a serial device, such as a palmtop, to the computer.
---	---



## Reinstalling Microsoft® Windows®

### Dell™ Inspiron™ 2500 Systems

- [Reinstalling Windows Me](#)
- [Reinstalling Windows 2000](#)
- [Reenabling Hibernate Mode Support](#)

 **HINT:** For more information on using the operating system installed on your computer by Dell, see the operating system documentation that came with your computer. You can also access system tools and documentation from <http://support.dell.com> by entering your service tag or Express Service Code and then clicking Go!

---

## Reinstalling Windows Me

 **NOTICE:** The *Operating System* CD provides options for reinstalling your Windows Millennium Edition (Me) operating system. The options can potentially overwrite files installed by Dell and possibly affect programs installed on your hard drive. Therefore, Dell does not recommend that you reinstall your operating system unless instructed to do so by a Dell technical support representative.

 **NOTICE:** To prevent conflicts with Windows Me, you must disable any virus protection software installed on your computer before you reinstall Windows.

1. Turn on the computer, and enter the [system setup program](#) as directed by a Dell technical support representative.
2. In the system setup program **Boot** menu, change the boot sequence so that the CD or DVD drive boots first as directed by a Dell technical support representative. Then place the *Operating System* CD in the CD or DVD drive and close the drive tray.
3. Exit the system setup program.
4. At the **Welcome** window, click **OK**.
5. Double-click **Refresh Windows OS**.
6. Click **OK**.
7. Click **OK** again.
8. Remove the *Operating System* CD from the CD or DVD drive, and click **OK** to restart your computer.

The **Getting ready to run Windows for the first time** window appears.

9. If the mouse tutorial starts, press <Esc> to exit and then press <y>.
10. Click the regional setting closest to where you live, and then click **Next**.
11. Click the graphic that matches your keyboard layout, and then click **Next**.
12. In the **User Information** window, type your name and, if applicable, company name, and then click **Next**.

The **Name** field must be completed; the **Company Name** field is optional.

The **License Agreement** window appears.

13. Click **I accept the Agreement**, and then click **Next**.
14. Type the Windows product key in the fields provided, and then click **Next**.

The product key is the bar code number found on the Microsoft Windows label, which is located on the computer.

15. When the **Start Wizard** window appears, click **Finish**.

The **Enter Windows Password** window appears. To continue without creating a Windows user name and password, click **OK**. Otherwise, type your user name and password in the appropriate fields, and then click **OK**.

16. If the **Date/Time Properties** window appears, adjust the date and time properties, click **Apply**, and then click **OK**.

Windows updates the system settings and restarts your computer.

17. If you created a Windows user name and password, type your password and click **OK**.
  18. Reinstall the appropriate drivers.
  19. Reenable your virus protection software.
  20. [Reenable hibernate mode support](#).
- 

## Reinstalling Windows 2000

1. Insert the *Operating System* CD into the CD or DVD drive.
2. Shut down the computer.
3. Turn on the computer.

4. Press any key when the **Press any key to boot from CD** message appears on the screen.
  5. When the **Windows 2000 Setup** window appears, ensure that the **To setup Win2000 now, press ENTER** option is highlighted. Then press <Enter>.
  6. Read the information in the **License Agreement** window, and then press <F8> to continue.
  7. When the **Windows 2000 Professional Setup** window appears, press the arrow keys to select the Windows 2000 partition option that you want. To continue, press the key specified in the partition option that you chose.
  8. When the **Windows 2000 Professional Setup** window reappears, press the arrow keys to select the type of filing system that you want Windows 2000 to use, and then press <Enter>.
  9. Press <Enter> again to restart your computer.
  10. Click **Next** when the **Welcome to the Windows 2000 Setup Wizard** window appears.
  11. When the **Regional Settings** window appears, select the settings for your locale, and then click **Next**.
  12. Enter your name and organization in the **Personalize Your Software** window, and then click **Next**.
  13. When prompted, enter the Windows product key, which is printed on the Microsoft label on your computer. Then click **Next**.
  14. When the **Computer Name and Administrator Password** window appears, enter a name for your computer and a password, if desired. Then click **Next**.
  15. Enter the date and time in the **Date and Time Settings** window, and then click **Next**.
- Windows 2000 begins to install its components and configure the computer.
16. When the **Completing the Windows 2000 Setup Wizard** window appears, remove the CD from the drive, and then click **Finish**. The computer automatically restarts.
  17. [Reenable hibernate mode support](#).
- 

## Reenabling Hibernate Mode Support

1. Click the **Start** button, point to **Settings**, and click **Control Panel**.
  2. Double-click the Power Options icon.
  3. Click the **Hibernate** tab.
  4. Ensure that **Enable hibernate support** is selected, and click **Apply**.
  5. Click **OK** to close the **Control Panel**.
- 

[Back to Contents Page](#)