

Inspiron 17

5000 Series

Service Manual

Computer Model: Inspiron 17-5759
Regulatory Model: P28E
Regulatory Type: P28E004



Notes, cautions, and warnings



NOTE: A NOTE indicates important information that helps you make better use of your computer.



CAUTION: A CAUTION indicates either potential damage to hardware or loss of data and tells you how to avoid the problem.



WARNING: A WARNING indicates a potential for property damage, personal injury, or death.

Copyright © 2015 Dell Inc. All rights reserved. This product is protected by U.S. and international copyright and intellectual property laws. Dell™ and the Dell logo are trademarks of Dell Inc. in the United States and/or other jurisdictions. All other marks and names mentioned herein may be trademarks of their respective companies.

2015–08

Rev. A00

Contents

Before working inside your computer.....	10
Before you begin	10
Safety instructions.....	10
Recommended tools.....	11
After working inside your computer.....	13
Removing the battery.....	14
Procedure.....	14
Replacing the battery.....	15
Procedure.....	15
Removing the base cover.....	16
Prerequisites.....	16
Procedure.....	16
Replacing the base cover.....	18
Procedure.....	18
Post-requisites.....	18
Removing the hard drive.....	19
Prerequisites.....	19
Procedure.....	19
Replacing the hard drive.....	22
Procedure.....	22
Post-requisites.....	22

Removing the memory modules.....	23
Prerequisites.....	23
Procedure.....	23
Replacing the memory modules.....	25
Procedure.....	25
Post-requisites.....	26
Removing the wireless card.....	27
Prerequisites.....	27
Procedure.....	27
Replacing the wireless card.....	29
Procedure.....	29
Post-requisites.....	29
Removing the coin-cell battery.....	30
Prerequisites.....	30
Procedure.....	30
Replacing the coin-cell battery.....	32
Procedure.....	32
Post-requisites.....	32
Removing the keyboard.....	33
Prerequisites.....	33
Procedure.....	33
Replacing the keyboard.....	36
Procedure.....	36
Post-requisites.....	36

Removing the optical drive.....	37
Prerequisites.....	37
Procedure.....	37
Replacing the optical drive.....	40
Procedure.....	40
Post-requisites.....	40
Removing the computer base.....	41
Prerequisites.....	41
Procedure.....	41
Replacing the computer base.....	46
Procedure.....	46
Post-requisites.....	46
Removing the speakers.....	47
Prerequisites.....	47
Procedure.....	47
Replacing the speakers.....	49
Procedure.....	49
Post-requisites.....	49
Removing the optical-drive interposer.....	50
Prerequisites.....	50
Procedure.....	50
Replacing the optical-drive interposer.....	52
Procedure.....	52
Post-requisites.....	52

Removing the I/O board.....	53
Prerequisites.....	53
Procedure.....	53
Replacing the I/O board.....	55
Procedure.....	55
Post-requisites.....	55
Removing the heat-sink assembly.....	56
Prerequisites.....	56
Procedure (discrete graphics card).....	56
Procedure (integrated graphics card).....	57
Replacing the heat-sink assembly.....	59
Procedure.....	59
Post-requisites.....	59
Removing the system board.....	61
Prerequisites.....	61
Procedure.....	62
Replacing the system board.....	66
Procedure.....	66
Post-requisites.....	67
Removing the battery-connector board.....	68
Prerequisites.....	68
Procedure.....	68
Replacing the battery-connector board.....	70
Procedure.....	70
Post-requisites.....	70

Removing the power-adapter port.....	71
Prerequisites.....	71
Procedure.....	71
Replacing the power-adapter port.....	73
Procedure.....	73
Post-requisites.....	73
Removing the display assembly.....	74
Prerequisites.....	74
Procedure.....	74
Replacing the display assembly.....	77
Procedure.....	77
Post-requisites.....	77
Removing the power-button board.....	79
Prerequisites.....	79
Procedure.....	79
Replacing the power-button board.....	81
Procedure.....	81
Post-requisites.....	81
Removing the palm-rest assembly.....	83
Prerequisites.....	83
Procedure.....	83
Replacing the palm-rest assembly.....	85
Procedure.....	85
Post-requisites.....	85

Removing the display bezel.....	86
Prerequisites.....	86
Procedure.....	86
Replacing the display bezel.....	88
Procedure.....	88
Post-requisites.....	88
Removing the display panel.....	89
Prerequisites.....	89
Procedure.....	89
Replacing the display panel.....	93
Procedure.....	93
Post-requisites.....	93
Removing the display hinges.....	95
Prerequisites.....	95
Procedure.....	95
Replacing the display hinges.....	97
Procedure.....	97
Post-requisites.....	97
Removing the camera.....	98
Prerequisites.....	98
Procedure.....	98
Replacing the camera.....	100
Procedure.....	100
Post-requisites.....	100



Removing the display cable.....	101
Prerequisites.....	101
Procedure.....	101
Replacing the display cable.....	103
Procedure.....	103
Post-requisites.....	103
Removing the display back-cover and antenna assembly.....	104
Prerequisites.....	104
Procedure.....	105
Replacing the display back-cover and antenna assembly.....	106
Procedure.....	106
Post-requisites.....	106
Flashing the BIOS.....	107
Getting help and contacting Dell.....	108
Self-help resources.....	108
Contacting Dell.....	109

Before working inside your computer

 **CAUTION:** To avoid damaging the components and cards, handle them by their edges and avoid touching pins and contacts.









 **NOTE:** The images in this document may differ from your computer depending on the configuration you ordered.

Before you begin

- 1 Save and close all open files and exit all open applications.
 - 2 Shut down your computer.
 - Windows 10: Click or tap **Start** →  **Power** → **Shut down**.
 - Windows 8.1: On the **Start** screen, click or tap the power icon  → **Shut down**.
 - Windows 7: Click or tap **Start** → **Shut down**.
-  **NOTE:** If you are using a different operating system, see the documentation of your operating system for shut-down instructions.
- 3 Disconnect your computer and all attached devices from their electrical outlets.
 - 4 Disconnect all cables such as telephone cables, network cables and so on, from your computer.
 - 5 Disconnect all attached devices and peripherals, such as keyboard, mouse, monitor, and so on, from your computer.
 - 6 Remove any media card and optical disc from your computer, if applicable.

Safety instructions

Use the following safety guidelines to protect your computer from potential damage and ensure your personal safety.

-  **WARNING:** Before working inside your computer, read the safety information that shipped with your computer. For more safety best practices, see the Regulatory Compliance home page at www.dell.com/regulatory_compliance.
-  **WARNING:** Disconnect all power sources before opening the computer cover or panels. After you finish working inside the computer, replace all covers, panels, and screws before connecting to the power source.
-  **CAUTION:** To avoid damaging the computer, ensure that the work surface is flat and clean.
-  **CAUTION:** To avoid damaging the components and cards, handle them by their edges and avoid touching pins and contacts.
-  **CAUTION:** You should only perform troubleshooting and repairs as authorized or directed by the Dell technical assistance team. Damage due to servicing that is not authorized by Dell is not covered by your warranty. See the safety instructions that shipped with the product or at www.dell.com/regulatory_compliance.
-  **CAUTION:** Before touching anything inside your computer, ground yourself by touching an unpainted metal surface, such as the metal at the back of the computer. While you work, periodically touch an unpainted metal surface to dissipate static electricity, which could harm internal components.
-  **CAUTION:** When you disconnect a cable, pull on its connector or on its pull tab, not on the cable itself. Some cables have connectors with locking tabs or thumb-screws that you must disengage before disconnecting the cable. When disconnecting cables, keep them evenly aligned to avoid bending any connector pins. When connecting cables, ensure that the ports and connectors are correctly oriented and aligned.
-  **CAUTION:** Press and eject any installed card from the media-card reader.

Recommended tools

The procedures in this document may require the following tools:

- Phillips screwdriver

- Plastic scribe

After working inside your computer



CAUTION: Leaving stray or loose screws inside your computer may severely damage your computer.

- 1 Replace all screws and ensure that no stray screws remain inside your computer.
- 2 Connect any external devices, peripherals, and cables you removed before working on your computer.
- 3 Replace any media cards, discs, and any other parts that you removed before working on your computer.
- 4 Connect your computer and all attached devices to their electrical outlets.
- 5 Turn on your computer.

Removing the battery

⚠ WARNING: Before working inside your computer, read the safety information that shipped with your computer and follow the steps in [Before working inside your computer](#). After working inside your computer, follow the instructions in [After working inside your computer](#). For more safety best practices, see the Regulatory Compliance home page at www.dell.com/regulatory_compliance.

Procedure

- 1 Close the display and turn the computer over.
- 2 Slide the battery-release latch to the unlocked position.
You hear a click sound when the battery is unlocked.
- 3 Lift the battery off the computer base.

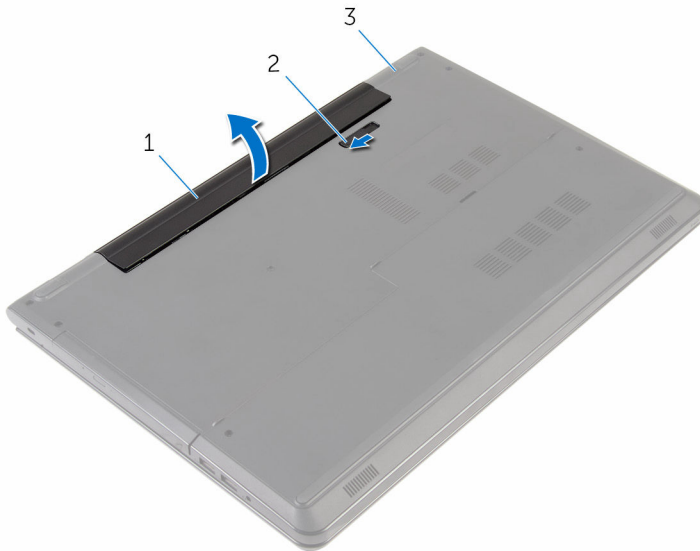

- | | | | |
|---|---------------|---|-----------------------|
| 1 | battery | 2 | battery-release latch |
| 3 | computer base | | |

- 4 Turn the computer over, open the display, and press the power button for five seconds to ground the system board.

Replacing the battery



WARNING: Before working inside your computer, read the safety information that shipped with your computer and follow the steps in [Before working inside your computer](#). After working inside your computer, follow the instructions in [After working inside your computer](#). For more safety best practices, see the Regulatory Compliance home page at www.dell.com/regulatory_compliance.

Procedure

Place the battery in the battery bay and snap the battery into place.

Removing the base cover



WARNING: Before working inside your computer, read the safety information that shipped with your computer and follow the steps in [Before working inside your computer](#). After working inside your computer, follow the instructions in [After working inside your computer](#). For more safety best practices, see the Regulatory Compliance home page at www.dell.com/regulatory_compliance.

Prerequisites

Remove the [battery](#).

Procedure

- 1 Close the display and turn the computer over.
- 2 Remove the screws that secure the base cover to the computer base.

- 3** Using a plastic scribe, pry up the base cover starting from the inner edge, and lift it off the computer base.

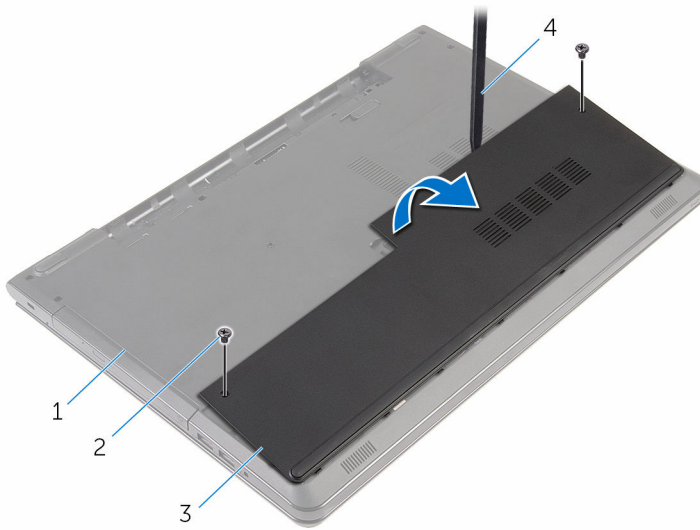

1 computer base

2 screws (2)

3 base cover

4 plastic scribe

Replacing the base cover



WARNING: Before working inside your computer, read the safety information that shipped with your computer and follow the steps in [Before working inside your computer](#). After working inside your computer, follow the instructions in [After working inside your computer](#). For more safety best practices, see the Regulatory Compliance home page at www.dell.com/regulatory_compliance.

Procedure

- 1 Slide the tabs on the base cover into the slots on the computer base and snap the base cover into place.
- 2 Replace the screws that secure the base cover to the computer base.

Post-requisites

Replace the [battery](#).

Removing the hard drive

 **WARNING:** Before working inside your computer, read the safety information that shipped with your computer and follow the steps in [Before working inside your computer](#). After working inside your computer, follow the instructions in [After working inside your computer](#). For more safety best practices, see the Regulatory Compliance home page at www.dell.com/regulatory_compliance.

 **CAUTION:** Hard drives are fragile. Exercise care when handling the hard drive.

 **CAUTION:** To avoid data loss, do not remove the hard drive while the computer is in sleep or on state.

Prerequisites

- 1 Remove the [battery](#).
- 2 Remove the [base cover](#).

Procedure

- 1 Lift the latch and disconnect the hard-drive cable from the system board.
- 2 Remove the screws that secure the hard-drive assembly to the computer base.

3 Using the pull tab, lift the hard-drive assembly out of the computer base.

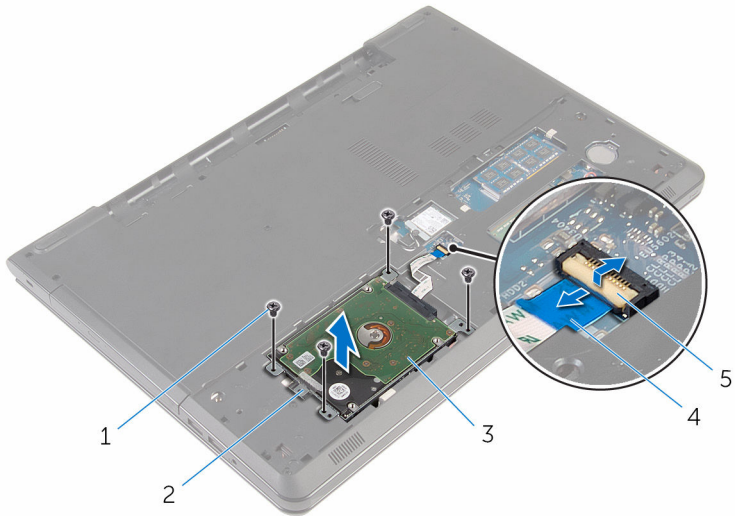

- | | | | |
|---|---------------------|---|------------------|
| 1 | screws (4) | 2 | pull tab |
| 3 | hard-drive assembly | 4 | hard-drive cable |
| 5 | latch | | |

4 Disconnect the interposer from the hard drive.

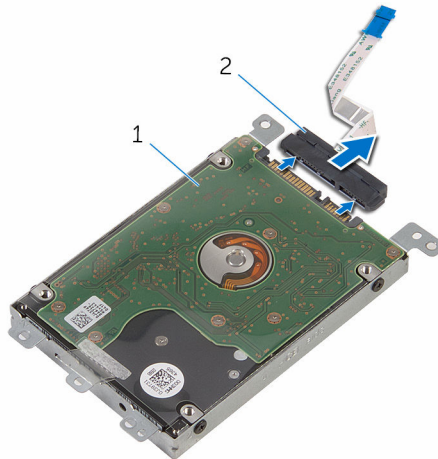

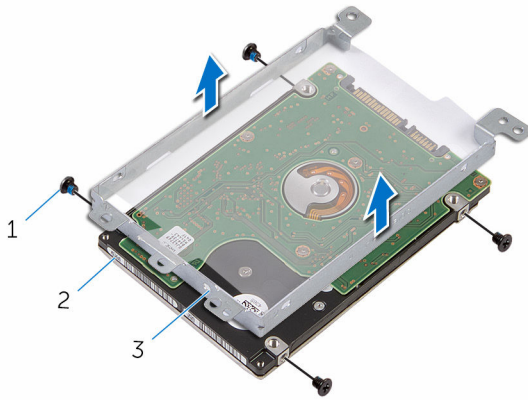

- | | | | |
|---|---------------------|---|------------|
| 1 | hard-drive assembly | 2 | interposer |
|---|---------------------|---|------------|

- 5 Remove the screws that secure the hard-drive bracket to the hard drive.
- 6 Lift the hard-drive bracket off the hard drive.



- | | | | |
|---|--------------------|---|------------|
| 1 | screws (4) | 2 | hard drive |
| 3 | hard-drive bracket | | |

Replacing the hard drive

-  **WARNING:** Before working inside your computer, read the safety information that shipped with your computer and follow the steps in [Before working inside your computer](#). After working inside your computer, follow the instructions in [After working inside your computer](#). For more safety best practices, see the Regulatory Compliance home page at www.dell.com/regulatory_compliance.
-  **CAUTION:** Hard drives are fragile. Exercise care when handling the hard drive.

Procedure

- 1 Align the screw holes on the hard-drive bracket with the screw holes on the hard drive.
- 2 Replace the screws that secure the hard-drive bracket to the hard drive.
- 3 Connect the interposer to the hard drive.
- 4 Place the hard-drive assembly in the computer base and align the screw holes on the hard-drive assembly with the screw holes on the computer base.
- 5 Replace the screws that secure the hard-drive assembly to the computer base.
- 6 Slide the hard-drive cable in the connector and press down the latch to secure the cable.

Post-requisites

- 1 Replace the [base cover](#).
- 2 Replace the [battery](#).

Removing the memory modules

 **WARNING:** Before working inside your computer, read the safety information that shipped with your computer and follow the steps in [Before working inside your computer](#). After working inside your computer, follow the instructions in [After working inside your computer](#). For more safety best practices, see the Regulatory Compliance home page at www.dell.com/regulatory_compliance.

Prerequisites

- 1 Remove the [battery](#).
- 2 Remove the [base cover](#).

Procedure

- 1 Use your fingertips to carefully spread apart the securing clips on each end of the memory-module slot until the memory module pops up.

2 Slide and remove the memory module from the memory-module slot.

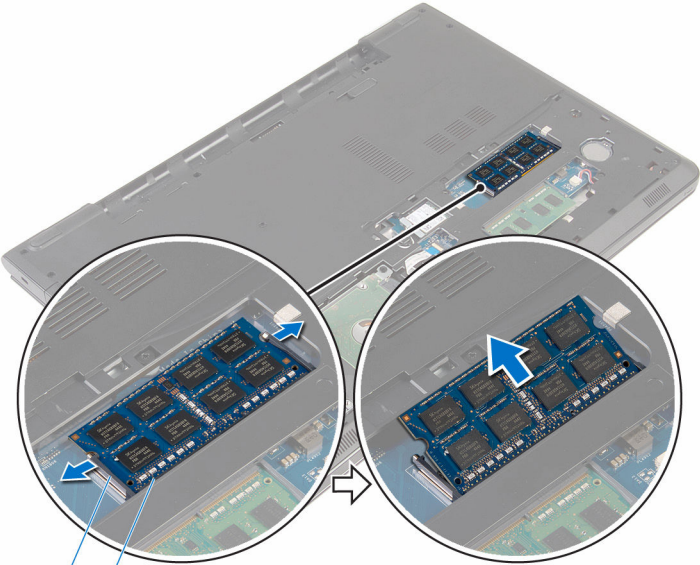

1 2
1 securing clips (2)

2 memory module

Replacing the memory modules

 **WARNING:** Before working inside your computer, read the safety information that shipped with your computer and follow the steps in [Before working inside your computer](#). After working inside your computer, follow the instructions in [After working inside your computer](#). For more safety best practices, see the Regulatory Compliance home page at www.dell.com/regulatory_compliance.

Procedure

- 1 Align the notch on the memory module with the tab on the memory-module slot.

- Slide the memory module firmly into the slot at an angle and press the memory module down until it clicks into place.

 **NOTE:** If you do not hear the click, remove the memory module and reinstall it.

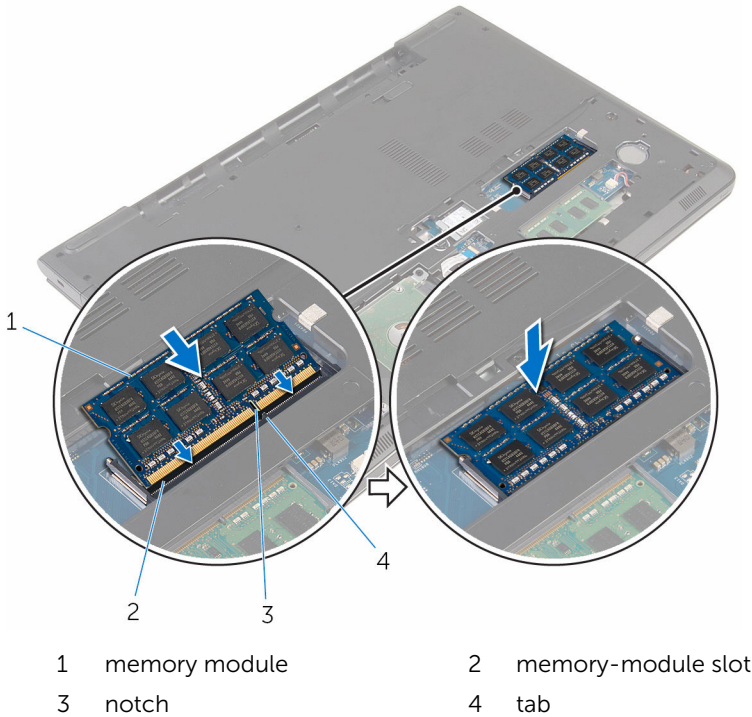

Post-requisites

- Replace the [base cover](#).
- Replace the [battery](#).

Removing the wireless card



WARNING: Before working inside your computer, read the safety information that shipped with your computer and follow the steps in [Before working inside your computer](#). After working inside your computer, follow the instructions in [After working inside your computer](#). For more safety best practices, see the Regulatory Compliance home page at www.dell.com/regulatory_compliance.

Prerequisites

- 1 Remove the [battery](#).
- 2 Remove the [base cover](#).

Procedure

- 1 Remove the screw that secures the wireless-card bracket and the wireless card to the system board.
- 2 Lift the wireless-card bracket off the wireless card.
- 3 Disconnect the antenna cables from the wireless card.

4 Slide and remove the wireless card from the system board.

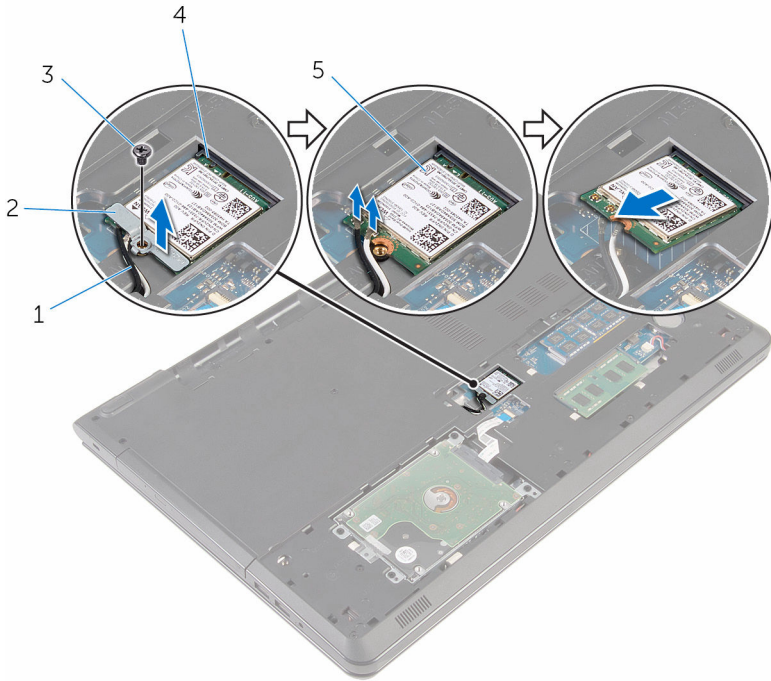

1 antenna cables (2)

3 screw

5 wireless card

2 wireless-card bracket

4 wireless-card slot

Replacing the wireless card

 **WARNING:** Before working inside your computer, read the safety information that shipped with your computer and follow the steps in [Before working inside your computer](#). After working inside your computer, follow the instructions in [After working inside your computer](#). For more safety best practices, see the Regulatory Compliance home page at www.dell.com/regulatory_compliance.

Procedure

 **CAUTION:** To avoid damage to the wireless card, do not place any cables under it.

- 1 Align the notch on the wireless card with the tab on the wireless-card slot and slide the card into the slot.
- 2 Align the screw hole on the wireless card with the screw hole on the system board.
- 3 Connect the antenna cables to the wireless card.

The following table provides the antenna-cable color scheme for the wireless card supported by your computer.



Connectors on the wireless card	Antenna-cable color
Main (white triangle)	white
Auxiliary (black triangle)	black

- 4 Align the screw hole on the wireless-card bracket with the screw hole on the system board.
- 5 Replace the screw that secures the wireless-card bracket and the wireless card to the system board.

Post-requisites

- 1 Replace the [base cover](#).
- 2 Replace the [battery](#).

Removing the coin-cell battery

-  **WARNING:** Before working inside your computer, read the safety information that shipped with your computer and follow the steps in [Before working inside your computer](#). After working inside your computer, follow the instructions in [After working inside your computer](#). For more safety best practices, see the Regulatory Compliance home page at www.dell.com/regulatory_compliance.
-  **CAUTION:** Removing the coin-cell battery resets the BIOS setup program's settings to default. It is recommended that you note the BIOS setup program's settings before removing the coin-cell battery.

Prerequisites

- 1 Remove the [battery](#).
- 2 Remove the [base cover](#).

Procedure

Using a plastic scribe, gently pry the coin-cell battery out of the coin-cell battery socket.



1 plastic scribe

2 coin-cell battery

3 coin-cell battery socket

Replacing the coin-cell battery



WARNING: Before working inside your computer, read the safety information that shipped with your computer and follow the steps in [Before working inside your computer](#). After working inside your computer, follow the instructions in [After working inside your computer](#). For more safety best practices, see the Regulatory Compliance home page at www.dell.com/regulatory_compliance.

Procedure

With the positive-side facing up, slide and snap the coin-cell battery into the coin-cell battery socket.

Post-requisites

- 1 Replace the [base cover](#).
- 2 Replace the [battery](#).

Removing the keyboard



WARNING: Before working inside your computer, read the safety information that shipped with your computer and follow the steps in [Before working inside your computer](#). After working inside your computer, follow the instructions in [After working inside your computer](#). For more safety best practices, see the Regulatory Compliance home page at www.dell.com/regulatory_compliance.

Prerequisites

Remove the [battery](#).

Procedure

- 1 Turn the computer over and open the display as far as possible.

- 2 Using a plastic scribe, gently release the tabs that secure the keyboard to the palm-rest assembly.



- 1 plastic scribe
- 2 keyboard
- 3 palm-rest assembly

- 3 Carefully turn the keyboard over and place it on the palm-rest assembly.

- 4 Lift the latches and disconnect the keyboard cable and keyboard-backlight cable (optional) from the system board.

 **NOTE:** The keyboard-backlight cable is present only if the laptop shipped with a backlit keyboard.

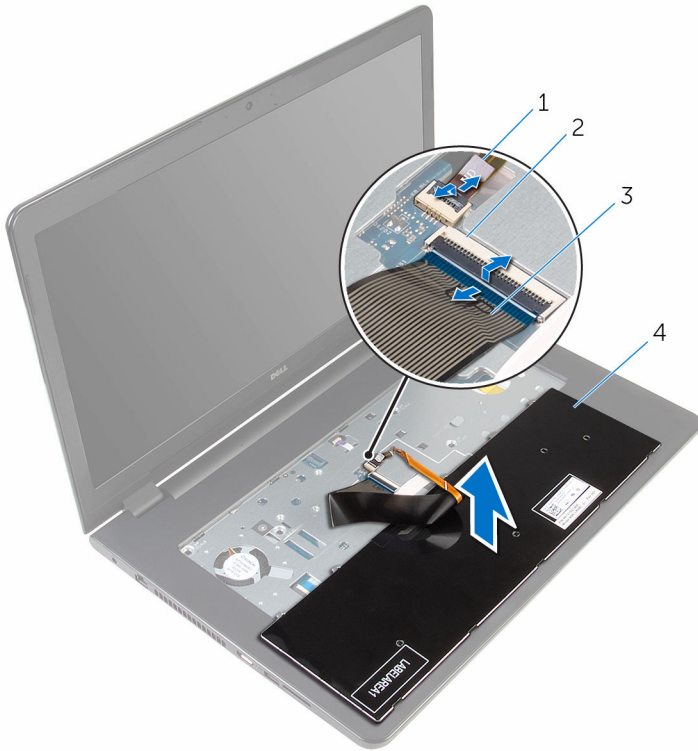

- | | | | |
|---|--------------------------|---|----------|
| 1 | keyboard-backlight cable | 2 | latch |
| 3 | keyboard cable | 4 | keyboard |

- 5 Lift the keyboard, along with the cables, off the palm-rest assembly.

Replacing the keyboard



WARNING: Before working inside your computer, read the safety information that shipped with your computer and follow the steps in [Before working inside your computer](#). After working inside your computer, follow the instructions in [After working inside your computer](#). For more safety best practices, see the Regulatory Compliance home page at www.dell.com/regulatory_compliance.

Procedure

- 1 Slide the keyboard cable and the keyboard-backlight cable (optional) into the respective connectors and press down the latches to secure the cables.
- 2 Turn the keyboard over.
- 3 Slide the tabs on the keyboard into the slots on the palm-rest assembly and snap the keyboard into place.

Post-requisites

Replace the [battery](#).

Removing the optical drive

 **WARNING:** Before working inside your computer, read the safety information that shipped with your computer and follow the steps in [Before working inside your computer](#). After working inside your computer, follow the instructions in [After working inside your computer](#). For more safety best practices, see the Regulatory Compliance home page at www.dell.com/regulatory_compliance.

Prerequisites

- 1 Remove the [battery](#).
- 2 Remove the [keyboard](#).

Procedure

- 1 Remove the screw that secures the optical-drive assembly to the computer base.

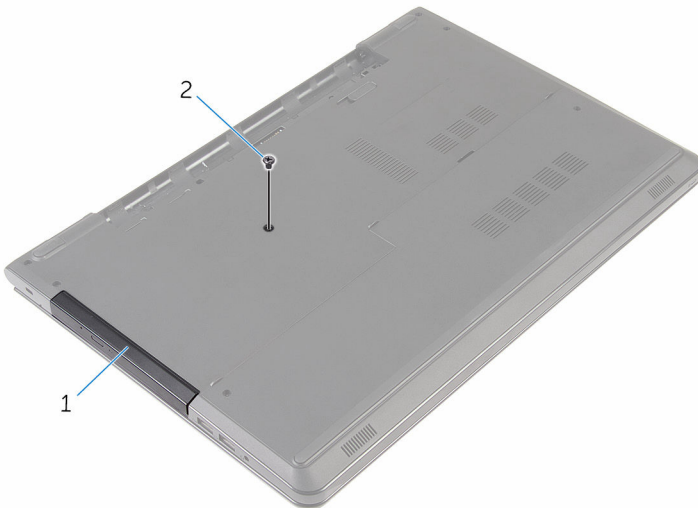

- 1 optical-drive assembly 2 screw

- 2 Turn the computer over and open the display.

- 3 Using a plastic scribe, push the optical-drive assembly out of the optical-drive bay.
- 4 Pull the optical-drive assembly out of the optical-drive bay.



- | | | | |
|---|------------------------|---|-----------|
| 1 | optical-drive assembly | 2 | palm rest |
| 3 | plastic scribe | | |

- 5 Carefully pry the optical-drive bezel off the optical drive.

- 6 Remove the screws that secure the optical-drive bracket to the optical drive.

 **NOTE:** Note the orientation of the optical-drive bracket so that you can replace it correctly.

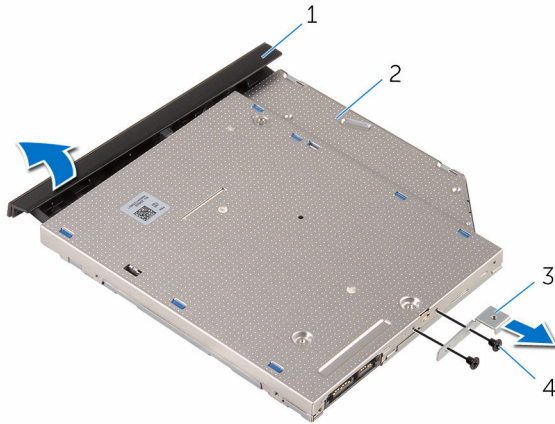

- | | | | |
|---|-----------------------|---|---------------|
| 1 | optical-drive bezel | 2 | optical drive |
| 3 | optical-drive bracket | 4 | screws (2) |

Replacing the optical drive



WARNING: Before working inside your computer, read the safety information that shipped with your computer and follow the steps in [Before working inside your computer](#). After working inside your computer, follow the instructions in [After working inside your computer](#). For more safety best practices, see the Regulatory Compliance home page at www.dell.com/regulatory_compliance.

Procedure

- 1 Align the screw holes on the optical-drive bracket with the screw holes on the optical drive.



NOTE: You must correctly align the optical-drive bracket to ensure that the optical drive can be properly secured to the computer. For correct orientation, see step 6 in "[Removing the optical drive](#)".

- 2 Replace the screws that secure the optical-drive bracket to the optical drive.
- 3 Align the tabs on the optical-drive bezel with the slots on the optical drive and snap the optical-drive bezel into place.
- 4 Slide the optical-drive assembly into the optical-drive bay.
- 5 Close the display and turn the computer over.
- 6 Replace the screw that secures the optical-drive assembly to the computer base.

Post-requisites

- 1 Replace the [keyboard](#).
- 2 Replace the [battery](#).

Removing the computer base



WARNING: Before working inside your computer, read the safety information that shipped with your computer and follow the steps in [Before working inside your computer](#). After working inside your computer, follow the instructions in [After working inside your computer](#). For more safety best practices, see the Regulatory Compliance home page at www.dell.com/regulatory_compliance.

Prerequisites

- 1 Remove the [battery](#).
- 2 Remove the [base cover](#).
- 3 Follow the procedure from step 1 to step 3 in "[Removing the hard drive](#)".
- 4 Remove the [wireless card](#).
- 5 Remove the [keyboard](#).
- 6 Follow the procedure from step 1 to step 4 in "[Removing the optical drive](#)".

Procedure

- 1 Lift the latch and disconnect the optical-drive cable from the system board.

- 2 Remove the screws that secure the computer base to the palm-rest assembly.



1 screws (4)

2 connector latch

3 optical-drive cable

- 3 Close the display and turn the computer over.
- 4 Disconnect the speaker cable from the system board.
- 5 Remove the antenna cables from the routing guides on the computer base.

- 6 Remove the screws that secure the computer base to the palm-rest assembly.

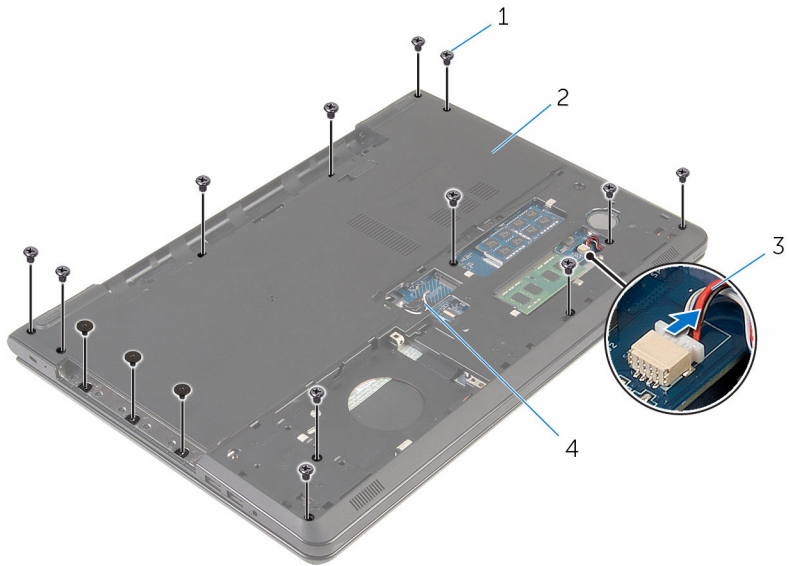

1 screws (15)

2 computer base

3 speaker cable

4 antenna cables (2)

- 7 Using your fingertips, starting from the rear, pry the computer base off the palm-rest assembly.

 **NOTE:** Ensure the antenna cables are completely removed from the routing guides on the computer base.



1 computer base

- 8 Turn the computer base over.
- 9 Remove the [optical-drive interposer](#).

10 Remove the [speakers](#).

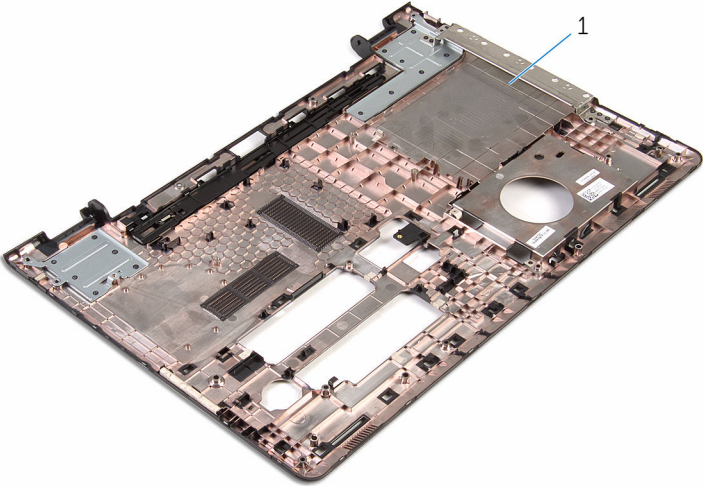

1 computer base

Replacing the computer base



WARNING: Before working inside your computer, read the safety information that shipped with your computer and follow the steps in [Before working inside your computer](#). After working inside your computer, follow the instructions in [After working inside your computer](#). For more safety best practices, see the Regulatory Compliance home page at www.dell.com/regulatory_compliance.

Procedure

- 1 Replace the [optical-drive interposer](#).
- 2 Replace the [speakers](#).
- 3 Slide the antenna cables and speaker cable through their respective slots on the computer base.
- 4 Align the tabs on the computer base with the slots on the palm-rest assembly and snap the computer base into place.
- 5 Replace the screws that secure the computer base to the palm-rest assembly.
- 6 Connect the speaker cable to the system board.
- 7 Turn the computer over and open the display.
- 8 Replace the screws that secure the computer base to the palm-rest assembly.
- 9 Slide the optical-drive cable into the connector on the system board and press down on the latch to secure the cable.

Post-requisites

- 1 Follow the procedure from step 4 to step 7 in "[Replacing the optical drive](#)".
- 2 Replace the [keyboard](#).
- 3 Replace the [wireless card](#).
- 4 Follow the procedure from step 4 to step 6 in "[Replacing the hard drive](#)".
- 5 Replace the [base cover](#).
- 6 Replace the [battery](#).

Removing the speakers



WARNING: Before working inside your computer, read the safety information that shipped with your computer and follow the steps in [Before working inside your computer](#). After working inside your computer, follow the instructions in [After working inside your computer](#). For more safety best practices, see the Regulatory Compliance home page at www.dell.com/regulatory_compliance.

Prerequisites

- 1 Remove the [battery](#).
- 2 Remove the [base cover](#).
- 3 Follow the procedure from step 1 to step 3 in "[Removing the hard drive](#)".
- 4 Remove the [wireless card](#).
- 5 Remove the [keyboard](#).
- 6 Follow the procedure from step 1 to step 4 in "[Removing the optical drive](#)".
- 7 Follow the procedure from step 1 to step 7 in "[Removing the computer base](#)".

Procedure

- 1 Note the speaker-cable routing on the computer base and release the cable from the routing guides.

2 Lift the speakers, along with the cable, off the computer base.

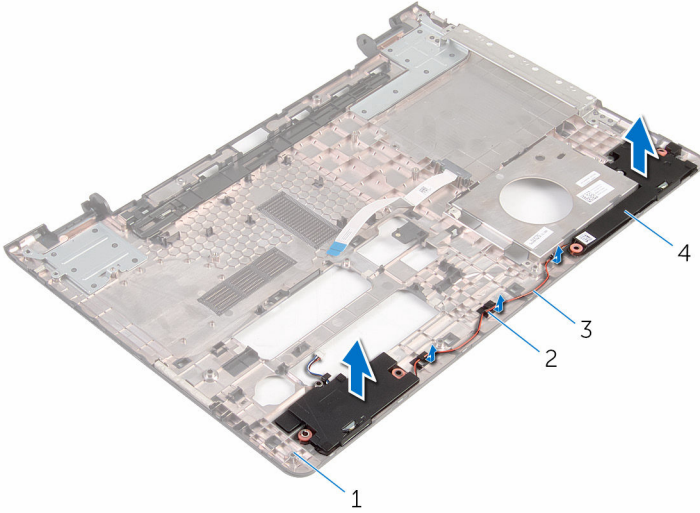

1 computer base

3 speaker cable

2 routing guides

4 speakers (2)

Replacing the speakers



WARNING: Before working inside your computer, read the safety information that shipped with your computer and follow the steps in [Before working inside your computer](#). After working inside your computer, follow the instructions in [After working inside your computer](#). For more safety best practices, see the Regulatory Compliance home page at www.dell.com/regulatory_compliance.

Procedure

- 1 Using the alignment posts, align and place the speakers on the computer base.
- 2 Route the speaker cable through the routing guides on the computer base.

Post-requisites

- 1 Follow the procedure from step 3 to step 8 in "[Replacing the computer base](#)".
- 2 Follow the procedure from step 4 to step 7 in "[Replacing the optical drive](#)".
- 3 Replace the [keyboard](#).
- 4 Replace the [wireless card](#).
- 5 Follow the procedure from step 4 to step 6 in "[Replacing the hard drive](#)".
- 6 Replace the [base cover](#).
- 7 Replace the [battery](#).

Removing the optical-drive interposer

 **WARNING:** Before working inside your computer, read the safety information that shipped with your computer and follow the steps in [Before working inside your computer](#). After working inside your computer, follow the instructions in [After working inside your computer](#). For more safety best practices, see the Regulatory Compliance home page at www.dell.com/regulatory_compliance.

Prerequisites

- 1 Remove the [battery](#).
- 2 Remove the [base cover](#).
- 3 Follow the procedure from step 1 to step 3 in "[Removing the hard drive](#)".
- 4 Remove the [wireless card](#).
- 5 Remove the [keyboard](#).
- 6 Follow the procedure from step 1 to step 4 in "[Removing the optical drive](#)".
- 7 Follow the procedure from step 1 to step 7 in "[Removing the computer base](#)".

Procedure

Release the optical-drive interposer from the tabs on the computer base.

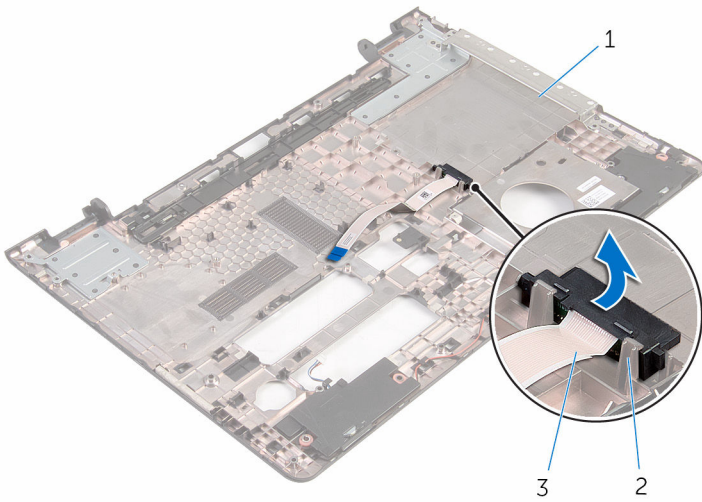

- 1 computer base
- 3 optical-drive interposer

- 2 tabs (2)

Replacing the optical-drive interposer

 **WARNING:** Before working inside your computer, read the safety information that shipped with your computer and follow the steps in [Before working inside your computer](#). After working inside your computer, follow the instructions in [After working inside your computer](#). For more safety best practices, see the Regulatory Compliance home page at www.dell.com/regulatory_compliance.

Procedure

Align the optical-drive interposer with the tabs on the computer base and snap it into place.

Post-requisites

- 1 Follow the procedure from step 3 to step 8 in "[Replacing the computer base](#)".
- 2 Follow the procedure from step 4 to step 7 in "[Replacing the optical drive](#)".
- 3 Replace the [keyboard](#).
- 4 Replace the [wireless card](#).
- 5 Follow the procedure from step 4 to step 6 in "[Replacing the hard drive](#)".
- 6 Replace the [base cover](#).
- 7 Replace the [battery](#).

Removing the I/O board



WARNING: Before working inside your computer, read the safety information that shipped with your computer and follow the steps in [Before working inside your computer](#). After working inside your computer, follow the instructions in [After working inside your computer](#). For more safety best practices, see the Regulatory Compliance home page at www.dell.com/regulatory_compliance.

Prerequisites

- 1 Remove the [battery](#).
- 2 Remove the [base cover](#).
- 3 Follow the procedure from step 1 to step 3 in "[Removing the hard drive](#)".
- 4 Remove the [wireless card](#).
- 5 Remove the [keyboard](#).
- 6 Follow the procedure from step 1 to step 4 in "[Removing the optical drive](#)".
- 7 Follow the procedure from step 1 to step 6 in "[Removing the computer base](#)".

Procedure

- 1 Remove the screw that secures the I/O board to the palm-rest assembly.
- 2 Lift the I/O board and turn it over.

3 Lift the latch and disconnect the I/O-board cable from the I/O board.

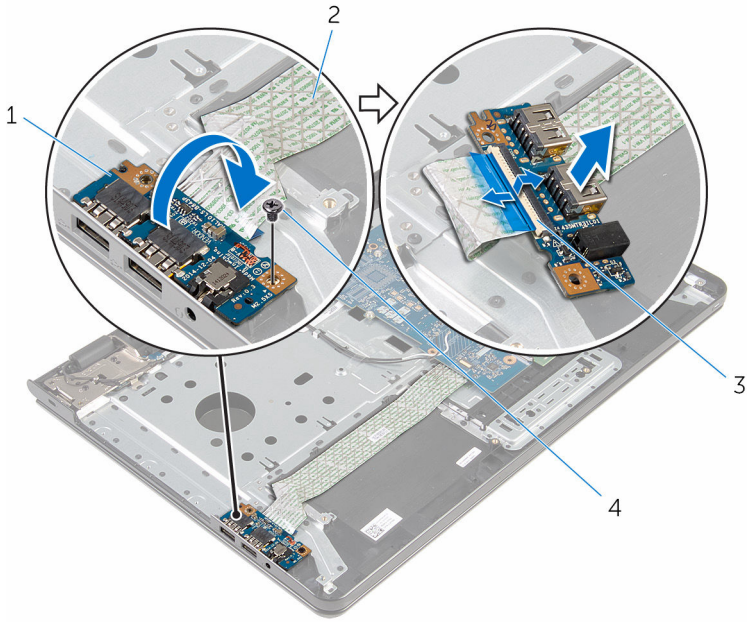

1 I/O board

2 I/O-board cable

3 latch

4 screw

Replacing the I/O board



WARNING: Before working inside your computer, read the safety information that shipped with your computer and follow the steps in [Before working inside your computer](#). After working inside your computer, follow the instructions in [After working inside your computer](#). For more safety best practices, see the Regulatory Compliance home page at www.dell.com/regulatory_compliance.



Procedure

- 1 Slide the I/O-board cable into the I/O-board cable connector and press down the latch to secure the cable.
- 2 Turn the I/O board over and align the screw hole on the I/O board with the screw hole on the palm-rest assembly.
- 3 Replace the screw that secures the I/O board to the palm-rest assembly.

Post-requisites

- 1 Follow the procedure from step 3 to step 8 in "[Replacing the computer base](#)".
- 2 Follow the procedure from step 4 to step 7 in "[Replacing the optical drive](#)".
- 3 Replace the [keyboard](#).
- 4 Replace the [wireless card](#).
- 5 Follow the procedure from step 4 to step 6 in "[Replacing the hard drive](#)".
- 6 Replace the [base cover](#).
- 7 Replace the [battery](#).

Removing the heat-sink assembly

-  **WARNING:** Before working inside your computer, read the safety information that shipped with your computer and follow the steps in [Before working inside your computer](#). After working inside your computer, follow the instructions in [After working inside your computer](#). For more safety best practices, see the Regulatory Compliance home page at www.dell.com/regulatory_compliance.
-  **WARNING:** The heat sink may become hot during normal operation. Allow sufficient time for the heat sink to cool before you touch it.
-  **CAUTION:** For maximum cooling of the processor, do not touch the heat transfer areas on the heat sink. The oils in your skin can reduce the heat transfer capability of the thermal grease.

Prerequisites

- 1 Remove the [battery](#).
- 2 Remove the [base cover](#).
- 3 Follow the procedure from step 1 to step 3 in "[Removing the hard drive](#)".
- 4 Remove the [wireless card](#).
- 5 Remove the [keyboard](#).
- 6 Follow the procedure from step 1 to step 4 in "[Removing the optical drive](#)".
- 7 Follow the procedure from step 1 to step 6 in "[Removing the computer base](#)".

Procedure (discrete graphics card)

- 1 Disconnect the fan cable from the system board.
- 2 In sequential order, as indicated on the heat-sink assembly, loosen the captive screws that secure the heat-sink assembly to the system board.
- 3 Remove the screws that secure the heat-sink assembly to the system board.

- 4 Lift the heat-sink assembly off the system board.

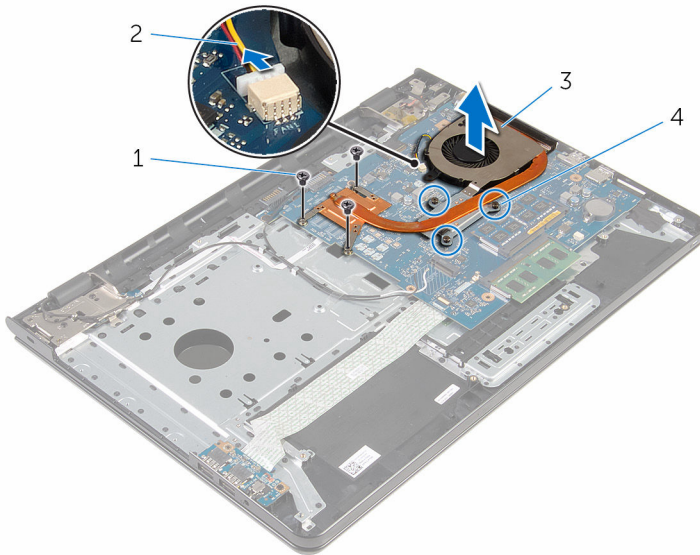

- | | | | |
|---|--------------------|---|--------------------|
| 1 | screws (3) | 2 | fan cable |
| 3 | heat-sink assembly | 4 | captive screws (3) |

Procedure (integrated graphics card)

- 1 Disconnect the fan cable from the system board.
- 2 In sequential order, as indicated on the heat-sink assembly, loosen the captive screws that secure the heat-sink assembly to the system board.
- 3 Remove the screws that secure the heat-sink assembly to the system board.

4 Lift the heat-sink assembly off the system board.

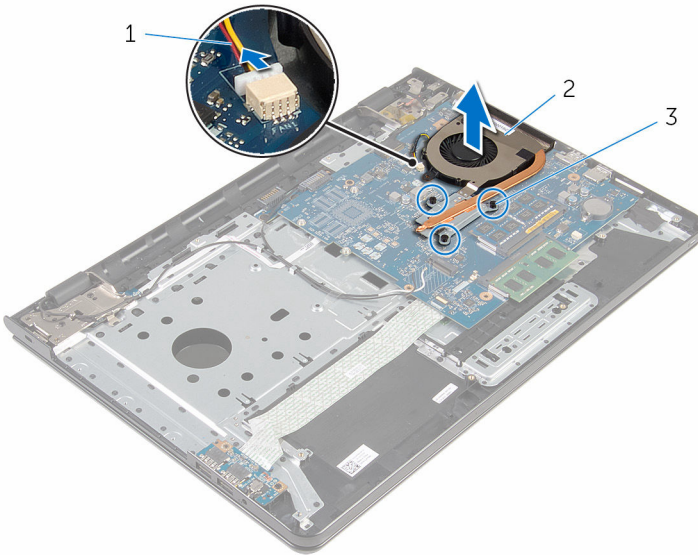



1 fan cable

2 heat-sink assembly

3 captive screws (3)

Replacing the heat-sink assembly

 **WARNING:** Before working inside your computer, read the safety information that shipped with your computer and follow the steps in [Before working inside your computer](#). After working inside your computer, follow the instructions in [After working inside your computer](#). For more safety best practices, see the Regulatory Compliance home page at www.dell.com/regulatory_compliance.

 **CAUTION:** Incorrect alignment of the heat sink can damage the system board and processor.

 **NOTE:** The original thermal grease can be reused if the original system board and fan are reinstalled together. If either the system board or the fan is replaced, use the thermal pad provided in the kit to ensure that thermal conductivity is achieved.

Procedure

 **NOTE:** The original thermal grease can be reused, if the original system board and fan are reinstalled together. If either the system board or the fan is replaced, use the thermal pad provided in the kit to make sure that thermal conductivity is achieved.

- 1 Align the screw holes on the heat-sink assembly with the screw holes on the system board.
- 2 In sequential order, as indicated on the heat-sink assembly, tighten the captive screws that secure the heat-sink assembly to the system board.
- 3 Replace the screws that secure the heat-sink assembly to the system board.
- 4 Connect the fan cable to the system board.

Post-requisites

- 1 Follow the procedure from step 3 to step 8 in "[Replacing the computer base](#)".
- 2 Follow the procedure from step 4 to step 7 in "[Replacing the optical drive](#)".

- 3 Replace the [keyboard](#).
- 4 Replace the [wireless card](#).
- 5 Follow the procedure from step 4 to step 6 in "[Replacing the hard drive](#)".
- 6 Replace the [base cover](#).
- 7 Replace the [battery](#).

Removing the system board



WARNING: Before working inside your computer, read the safety information that shipped with your computer and follow the steps in [Before working inside your computer](#). After working inside your computer, follow the instructions in [After working inside your computer](#). For more safety best practices, see the Regulatory Compliance home page at www.dell.com/regulatory_compliance.



NOTE: Your computer's Service Tag is stored in the system board. You must enter the Service Tag in the BIOS setup program after you replace the system board.



NOTE: Replacing the system board removes any changes you have made to the BIOS using the BIOS setup program. You must make the desired changes again after you replace the system board.



NOTE: Before disconnecting the cables from the system board, note the location of the connectors so that you can reconnect the cables correctly after you replace the system board.

Prerequisites

- 1 Remove the [battery](#).
- 2 Remove the [base cover](#).
- 3 Follow the procedure from step 1 to step 3 in "[Removing the hard drive](#)".
- 4 Remove the [wireless card](#).
- 5 Remove the [memory modules](#).
- 6 Remove the [coin-cell battery](#).
- 7 Remove the [keyboard](#).
- 8 Follow the procedure from step 1 to step 4 in "[Removing the optical drive](#)".
- 9 Follow the procedure from step 1 to step 6 in "[Removing the computer base](#)".
- 10 Remove the [I/O board](#).
- 11 Remove the [heat-sink assembly](#).

Procedure

- 1 Turn the computer over and open the display as far as possible.
- 2 Lift the connector latches and disconnect the power-button board cable and the touchpad cable from the system board.



1 power-button board cable 2 touchpad cable

- 3 Close the display and turn the computer over.
- 4 Lift the latch and disconnect the display cable from the system board.
- 5 Remove the screw that secures the system board to the palm-rest assembly.

- 6 Peel the I/O board cable off the palm-rest assembly.

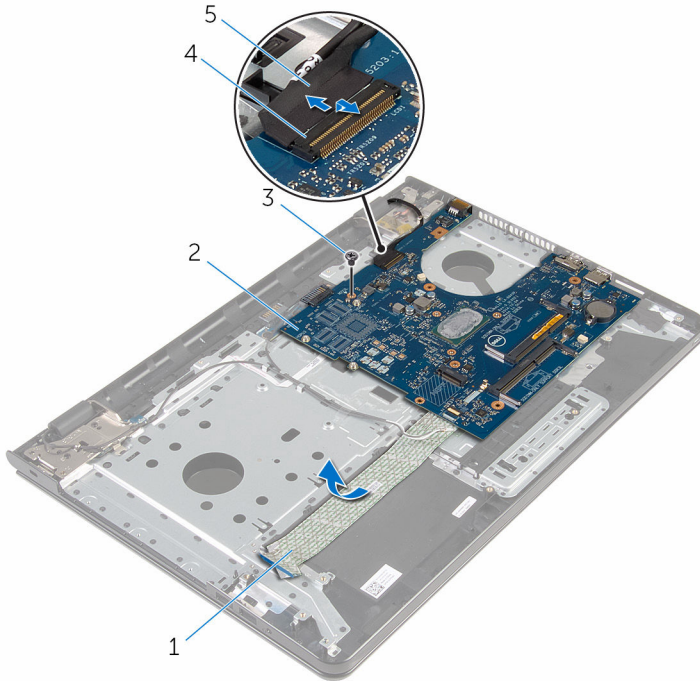

- | | | | |
|---|-----------------|---|-----------------|
| 1 | I/O board cable | 2 | system board |
| 3 | screw | 4 | connector latch |
| 5 | display cable | | |

- 7 Carefully lift the system board from the inner edge to release the system board from the system-board connector on the palm-rest assembly.

8 Turn the system board over.

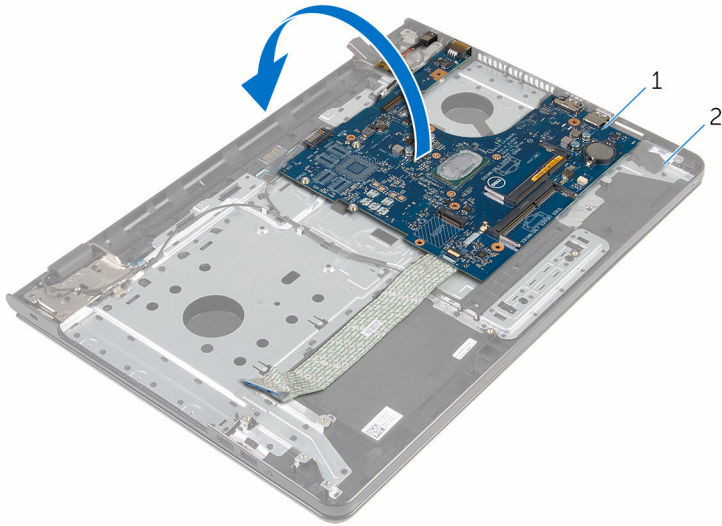

1 system board

2 palm-rest assembly

9 Disconnect the power-adaptor port cable from the system board.

10 Lift the latch and disconnect the I/O-board cable from the system board.

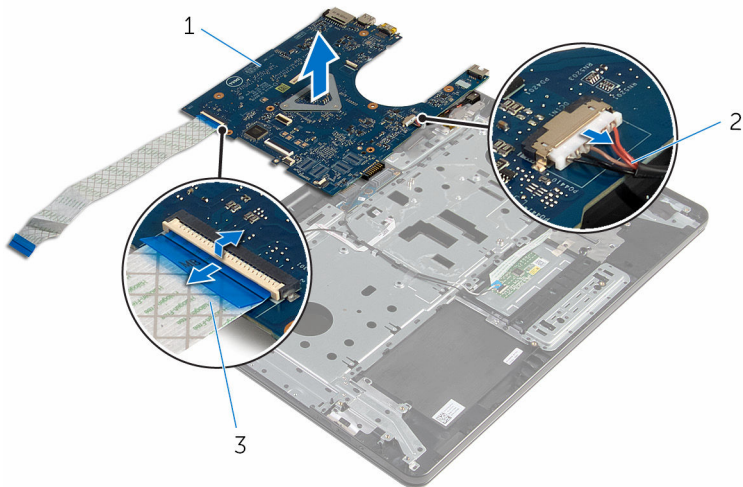

1 system board

2 power-adaptor port cable

3 I/O-board cable

11 Lift the system board off the computer base.

Replacing the system board

 **WARNING:** Before working inside your computer, read the safety information that shipped with your computer and follow the steps in [Before working inside your computer](#). After working inside your computer, follow the instructions in [After working inside your computer](#). For more safety best practices, see the Regulatory Compliance home page at www.dell.com/regulatory_compliance.

 **NOTE:** Your computer's Service Tag is stored in the system board. You must enter the Service Tag in the BIOS setup program after you replace the system board.

 **NOTE:** Replacing the system board removes any changes you have made to the BIOS using the BIOS setup program. You must make the desired changes again after you replace the system board.

Procedure

 **CAUTION:** To avoid damaging the system board, ensure that no cables are placed under it.

- 1 Connect the power-adaptor port cable to the system board.
- 2 Slide the I/O-board cable into the connector and press down the latch to secure the cable.
- 3 Turn the system board over.
- 4 Slide the ports on the system board into the slots on the palm-rest assembly.
- 5 Align the screw hole on the system board with the screw hole on the palm-rest assembly.
- 6 Replace the screw that secures the system board to the palm-rest assembly.
- 7 Adhere the I/O board cable to the palm-rest assembly.
- 8 Slide the display cable into the connector and press down the latch to secure the cable to the system board.
- 9 Turn the computer over and open the display.
- 10 Slide the power-button board cable and touchpad cable into the respective connectors and press down the latches to secure the cables.

Post-requisites

- 1 Replace the [heat-sink assembly](#).
- 2 Replace the [I/O board](#).
- 3 Follow the procedure from step 3 to step 8 in "[Replacing the computer base](#)".
- 4 Follow the procedure from step 4 to step 7 in "[Replacing the optical drive](#)".
- 5 Replace the [keyboard](#).
- 6 Replace the [coin-cell battery](#).
- 7 Replace the [memory modules](#).
- 8 Replace the [wireless card](#).
- 9 Follow the procedure from step 4 to step 6 in "[Replacing the hard drive](#)".
- 10 Replace the [base cover](#).
- 11 Replace the [battery](#).

Removing the battery-connector board

 **WARNING:** Before working inside your computer, read the safety information that shipped with your computer and follow the steps in [Before working inside your computer](#). After working inside your computer, follow the instructions in [After working inside your computer](#). For more safety best practices, see the Regulatory Compliance home page at www.dell.com/regulatory_compliance.

Prerequisites

- 1 Remove the [battery](#).
- 2 Remove the [base cover](#).
- 3 Follow the procedure from step 1 to step 3 in "[Removing the hard drive](#)".
- 4 Remove the [wireless card](#).
- 5 Remove the [memory modules](#).
- 6 Remove the [keyboard](#).
- 7 Follow the procedure from step 1 to step 4 in "[Removing the optical drive](#)".
- 8 Follow the procedure from step 1 to step 6 in "[Removing the computer base](#)".
- 9 Remove the [I/O board](#).
- 10 Remove the [heat-sink assembly](#).
- 11 Remove the [system board](#).

Procedure

- 1 Peel off the tapes that secure the antenna cable to the palm-rest assembly.
- 2 Remove the antenna cable from the routing guides on the battery-connector board.
- 3 Remove the screws that secure the battery-connector board to the palm-rest assembly.

4 Lift the battery-connector board off the palm-rest assembly.

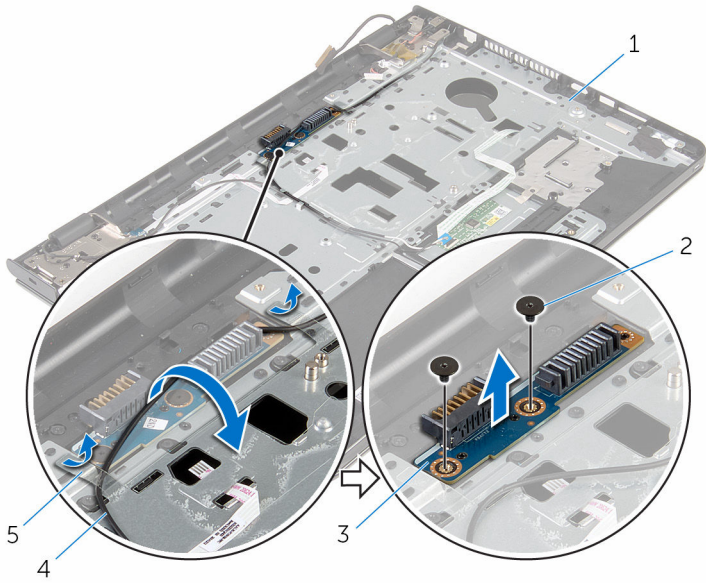

1 palm-rest assembly

3 battery-connector board

5 tapes (2)

2 screws (2)

4 antenna cable

Replacing the battery-connector board

 **WARNING:** Before working inside your computer, read the safety information that shipped with your computer and follow the steps in [Before working inside your computer](#). After working inside your computer, follow the instructions in [After working inside your computer](#). For more safety best practices, see the Regulatory Compliance home page at www.dell.com/regulatory_compliance.

Procedure

- 1 Align the screw holes on the battery-connector board with the screw holes on the palm-rest assembly.
- 2 Replace the screws that secure the battery-connector board to the palm-rest assembly.
- 3 Route the antenna cable through the routing guides on the battery-connector board.
- 4 Adhere the tapes that secure the antenna cable to the palm-rest assembly.

Post-requisites

- 1 Replace the [system board](#).
- 2 Replace the [heat-sink assembly](#).
- 3 Replace the [I/O board](#).
- 4 Follow the procedure from step 3 to step 8 in "[Replacing the computer base](#)".
- 5 Follow the procedure from step 4 to step 7 in "[Replacing the optical drive](#)".
- 6 Replace the [keyboard](#).
- 7 Replace the [memory modules](#).
- 8 Replace the [wireless card](#).
- 9 Follow the procedure from step 4 to step 6 in "[Replacing the hard drive](#)".
- 10 Replace the [base cover](#).
- 11 Replace the [battery](#).

Removing the power-adapter port

 **WARNING:** Before working inside your computer, read the safety information that shipped with your computer and follow the steps in [Before working inside your computer](#). After working inside your computer, follow the instructions in [After working inside your computer](#). For more safety best practices, see the Regulatory Compliance home page at www.dell.com/regulatory_compliance.

Prerequisites

- 1 Remove the [battery](#).
- 2 Remove the [base cover](#).
- 3 Follow the procedure from step 1 to step 3 in "[Removing the hard drive](#)".
- 4 Remove the [wireless card](#).
- 5 Remove the [memory modules](#).
- 6 Remove the [keyboard](#).
- 7 Follow the procedure from step 1 to step 4 in "[Removing the optical drive](#)".
- 8 Follow the procedure from step 1 to step 6 in "[Removing the computer base](#)".
- 9 Remove the [I/O board](#).
- 10 Remove the [heat-sink assembly](#).
- 11 Remove the [system board](#).

Procedure

- 1 Note the power-adapter-port cable routing and remove it from the routing guides on the palm-rest assembly.
- 2 Remove the screw that secures the power-adapter port to the palm-rest assembly.
- 3 Peel off the tape that secures the power-adapter port to the palm-rest assembly.

- 4 Lift the power-adapter port, along with its cable, off the palm-rest assembly.

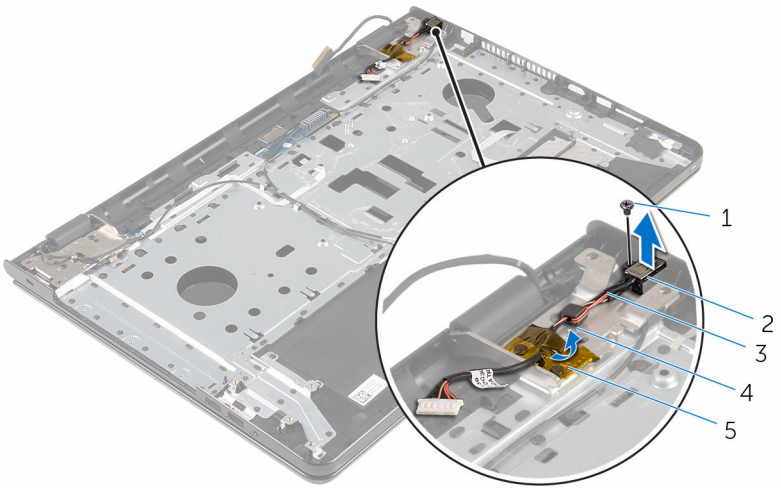

- | | | | |
|---|--------------------------|---|--------------------|
| 1 | screw | 2 | power-adapter port |
| 3 | power-adapter port cable | 4 | routing guide |
| 5 | tape | | |

Replacing the power-adapter port

 **WARNING:** Before working inside your computer, read the safety information that shipped with your computer and follow the steps in [Before working inside your computer](#). After working inside your computer, follow the instructions in [After working inside your computer](#). For more safety best practices, see the Regulatory Compliance home page at www.dell.com/regulatory_compliance.

Procedure

- 1 Slide the power-adapter port into the slot on the palm-rest assembly.
- 2 Replace the screw that secures the power-adapter port to the palm-rest assembly.
- 3 Route the power-adapter-port cable through the routing guides on the palm-rest assembly.
- 4 Adhere the tape that secures the power-adapter port to the palm-rest assembly.

Post-requisites

- 1 Replace the [system board](#).
- 2 Replace the [heat-sink assembly](#).
- 3 Replace the [I/O board](#).
- 4 Follow the procedure from step 3 to step 8 in "[Replacing the computer base](#)".
- 5 Follow the procedure from step 4 to step 7 in "[Replacing the optical drive](#)".
- 6 Replace the [keyboard](#).
- 7 Replace the [memory modules](#).
- 8 Replace the [wireless card](#).
- 9 Follow the procedure from step 4 to step 6 in "[Replacing the hard drive](#)".
- 10 Replace the [base cover](#).
- 11 Replace the [battery](#).

Removing the display assembly

 **WARNING:** Before working inside your computer, read the safety information that shipped with your computer and follow the steps in [Before working inside your computer](#). After working inside your computer, follow the instructions in [After working inside your computer](#). For more safety best practices, see the Regulatory Compliance home page at www.dell.com/regulatory_compliance.

Prerequisites

- 1 Remove the [battery](#).
- 2 Remove the [base cover](#).
- 3 Follow the procedure from step 1 to step 3 in "[Removing the hard drive](#)".
- 4 Remove the [wireless card](#).
- 5 Remove the [memory modules](#).
- 6 Remove the [keyboard](#).
- 7 Follow the procedure from step 1 to step 4 in "[Removing the optical drive](#)".
- 8 Follow the procedure from step 1 to step 6 in "[Removing the computer base](#)".
- 9 Remove the [I/O board](#).
- 10 Remove the [heat-sink assembly](#).
- 11 Remove the [system board](#).
- 12 Remove the [power-adaptor port](#).

Procedure

- 1 Note the antenna cable routing and remove the cable from its routing guides.

- 2 Peel off the tapes that secure the antenna cables to the palm-rest assembly.

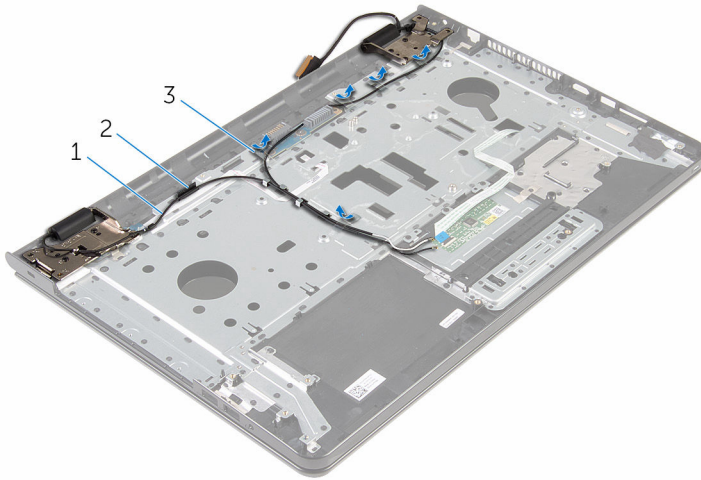

- | | | | |
|---|--------------------|---|---------------|
| 1 | antenna cables (2) | 2 | routing guide |
| 3 | tapes (5) | | |

- 3 Open the display at an angle of 90 degrees.
- 4 Place the computer on the edge of a table so that the palm-rest assembly is on the table and the display assembly extends past the table edge with the display hinges facing up.
- 5 Remove the screws that secure the display hinges to the palm-rest assembly.

6 Lift the display assembly off the palm-rest assembly.

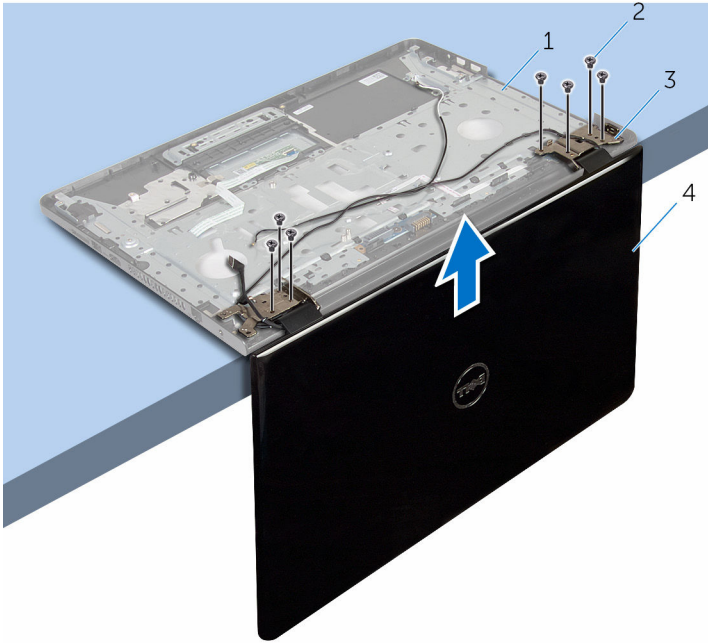

1 palm-rest assembly

2 screws (7)

3 display hinges (2)

4 display assembly

Replacing the display assembly

 **WARNING:** Before working inside your computer, read the safety information that shipped with your computer and follow the steps in [Before working inside your computer](#). After working inside your computer, follow the instructions in [After working inside your computer](#). For more safety best practices, see the Regulatory Compliance home page at www.dell.com/regulatory_compliance.

Procedure

- 1 Place the palm-rest assembly at the edge of a table with the display hinges facing up.
- 2 Align the screw holes on the display hinges with the screw holes on the palm-rest assembly.
- 3 Replace the screws that secure the display hinges to the palm-rest assembly.
- 4 Close the display and turn the computer over.
- 5 Route the antenna cable through the routing guides on the palm-rest assembly.
- 6 Adhere the tapes that secure the display cable and the antenna cables to the palm-rest assembly.

Post-requisites

- 1 Replace the [power-adapter port](#).
- 2 Replace the [system board](#).
- 3 Replace the [heat-sink assembly](#).
- 4 Replace the [I/O board](#).
- 5 Follow the procedure from step 3 to step 8 in "[Replacing the computer base](#)".
- 6 Follow the procedure from step 4 to step 7 in "[Replacing the optical drive](#)".
- 7 Replace the [keyboard](#).
- 8 Replace the [memory modules](#).
- 9 Replace the [wireless card](#).
- 10 Follow the procedure from step 4 to step 6 in "[Replacing the hard drive](#)".

- 11** Replace the [base cover](#).
- 12** Replace the [battery](#).

Removing the power-button board

 **WARNING:** Before working inside your computer, read the safety information that shipped with your computer and follow the steps in [Before working inside your computer](#). After working inside your computer, follow the instructions in [After working inside your computer](#). For more safety best practices, see the Regulatory Compliance home page at www.dell.com/regulatory_compliance.

Prerequisites

- 1 Remove the [battery](#).
- 2 Remove the [base cover](#).
- 3 Follow the procedure from step 1 to step 3 in "[Removing the hard drive](#)".
- 4 Remove the [wireless card](#).
- 5 Remove the [memory modules](#).
- 6 Remove the [keyboard](#).
- 7 Follow the procedure from step 1 to step 4 in "[Removing the optical drive](#)".
- 8 Follow the procedure from step 1 to step 6 in "[Removing the computer base](#)".
- 9 Remove the [I/O board](#).
- 10 Remove the [heat-sink assembly](#).
- 11 Remove the [system board](#).
- 12 Remove the [power-adapter port](#).
- 13 Remove the [display assembly](#).

Procedure

- 1 Remove the screw that secures the power-button board to the palm-rest assembly.
- 2 Peel off the tape that secures the power-button board to the palm rest.
- 3 Peel off the power-button board cable from the palm rest.
- 4 Slide the power-button board from under the tabs on the palm rest.

- 5 Lift the power-button board, along with its cable, off the palm-rest assembly.

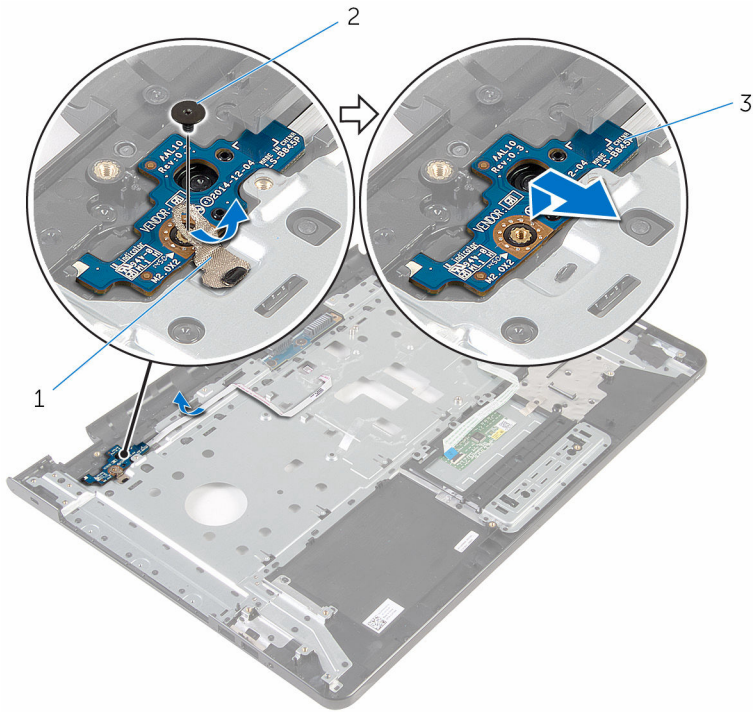

1 tape

2 screw

3 power-button board

Replacing the power-button board



WARNING: Before working inside your computer, read the safety information that shipped with your computer and follow the steps in [Before working inside your computer](#). After working inside your computer, follow the instructions in [After working inside your computer](#). For more safety best practices, see the Regulatory Compliance home page at www.dell.com/regulatory_compliance.

Procedure

- 1 Slide the power-button board under the tabs on the palm rest and align the screw hole on the power-button board with the screw hole on the palm-rest assembly.
- 2 Replace the screw that secures the power-button board to the palm-rest assembly.
- 3 Adhere the power-button board cable to the palm-rest assembly.
- 4 Adhere the tape that secures the power-button board to the palm-rest assembly.

Post-requisites

- 1 Replace the [display assembly](#).
- 2 Replace the [power-adapter port](#).
- 3 Replace the [system board](#).
- 4 Replace the [heat-sink assembly](#).
- 5 Replace the [I/O board](#).
- 6 Follow the procedure from step 3 to step 8 in "[Replacing the computer base](#)".
- 7 Follow the procedure from step 4 to step 7 in "[Replacing the optical drive](#)".
- 8 Replace the [keyboard](#).
- 9 Replace the [memory modules](#).
- 10 Replace the [wireless card](#).
- 11 Follow the procedure from step 4 to step 6 in "[Replacing the hard drive](#)".

12 Replace the [base cover](#).

13 Replace the [battery](#).

Removing the palm-rest assembly



WARNING: Before working inside your computer, read the safety information that shipped with your computer and follow the steps in [Before working inside your computer](#). After working inside your computer, follow the instructions in [After working inside your computer](#). For more safety best practices, see the Regulatory Compliance home page at www.dell.com/regulatory_compliance.

Prerequisites

- 1 Remove the [battery](#).
- 2 Remove the [base cover](#).
- 3 Follow the procedure from step 1 to step 3 in "[Removing the hard drive](#)".
- 4 Remove the [wireless card](#).
- 5 Remove the [memory modules](#).
- 6 Remove the [keyboard](#).
- 7 Follow the procedure from step 1 to step 4 in "[Removing the optical drive](#)".
- 8 Follow the procedure from step 1 to step 6 in "[Removing the computer base](#)".
- 9 Remove the [I/O board](#).
- 10 Remove the [heat-sink assembly](#).
- 11 Remove the [system board](#).
- 12 Remove the [power-adapter port](#).
- 13 Remove the [display assembly](#).
- 14 Remove the [power-button board](#).

Procedure

After performing all the prerequisites, we are left with the palm-rest assembly.

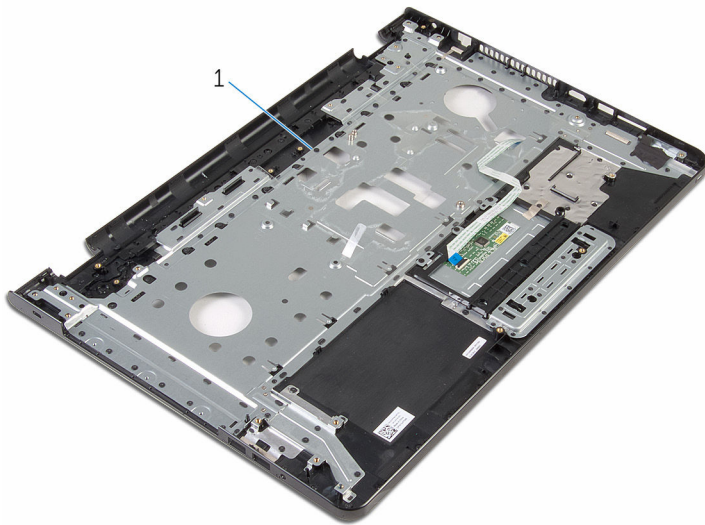

1 palm-rest assembly

Replacing the palm-rest assembly

 **WARNING:** Before working inside your computer, read the safety information that shipped with your computer and follow the steps in [Before working inside your computer](#). After working inside your computer, follow the instructions in [After working inside your computer](#). For more safety best practices, see the Regulatory Compliance home page at www.dell.com/regulatory_compliance.

Procedure

Place the palm-rest assembly on a flat surface.

Post-requisites

- 1 Replace the [power-button board](#).
- 2 Replace the [display assembly](#).
- 3 Replace the [power-adapter port](#).
- 4 Replace the [system board](#).
- 5 Replace the [heat-sink assembly](#).
- 6 Replace the [I/O board](#).
- 7 Follow the procedure from step 3 to step 8 in "[Replacing the computer base](#)".
- 8 Follow the procedure from step 4 to step 7 in "[Replacing the optical drive](#)".
- 9 Replace the [keyboard](#).
- 10 Replace the [memory modules](#).
- 11 Replace the [wireless card](#).
- 12 Follow the procedure from step 4 to step 6 in "[Replacing the hard drive](#)".
- 13 Replace the [base cover](#).
- 14 Replace the [battery](#).

Removing the display bezel



WARNING: Before working inside your computer, read the safety information that shipped with your computer and follow the steps in [Before working inside your computer](#). After working inside your computer, follow the instructions in [After working inside your computer](#). For more safety best practices, see the Regulatory Compliance home page at www.dell.com/regulatory_compliance.

Prerequisites



NOTE: These instructions are only applicable for laptop with non-touchscreen display.

- 1 Remove the [battery](#).
- 2 Remove the [base cover](#).
- 3 Follow the procedure from step 1 to step 3 in "[Removing the hard drive](#)".
- 4 Remove the [wireless card](#).
- 5 Remove the [memory modules](#).
- 6 Remove the [keyboard](#).
- 7 Follow the procedure from step 1 to step 4 in "[Removing the optical drive](#)".
- 8 Follow the procedure from step 1 to step 6 in "[Removing the computer base](#)".
- 9 Remove the [I/O board](#).
- 10 Remove the [heat-sink assembly](#).
- 11 Remove the [system board](#).
- 12 Remove the [power-adaptor port](#).
- 13 Remove the [display assembly](#).

Procedure

- 1 Using your fingertips, carefully pry up the inside edge of the display bezel.

2 Remove the display bezel off the display back-cover.

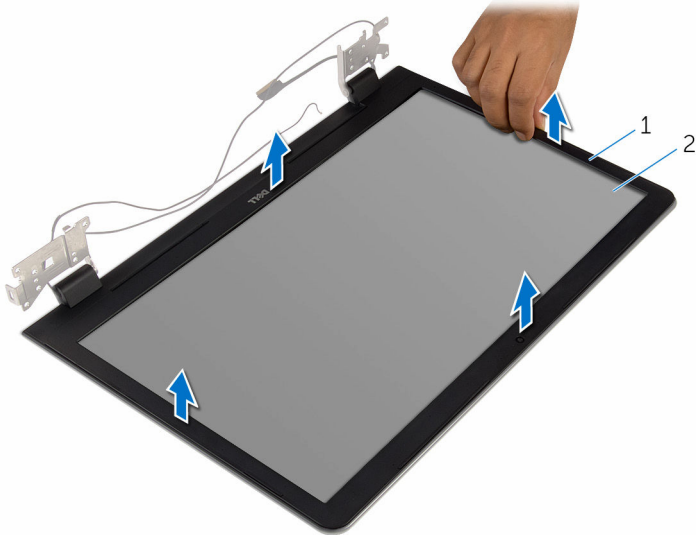

1 display bezel

2 display back-cover

Replacing the display bezel



WARNING: Before working inside your computer, read the safety information that shipped with your computer and follow the steps in [Before working inside your computer](#). After working inside your computer, follow the instructions in [After working inside your computer](#). For more safety best practices, see the Regulatory Compliance home page at www.dell.com/regulatory_compliance.

Procedure



NOTE: These instructions are only applicable for laptops with non-touchscreen display.

Align the display bezel with the display back-cover and gently snap the display bezel into place.

Post-requisites

- 1 Replace the [display assembly](#).
- 2 Replace the [power-adapter port](#).
- 3 Replace the [system board](#).
- 4 Replace the [heat-sink assembly](#).
- 5 Replace the [I/O board](#).
- 6 Follow the procedure from step 3 to step 8 in "[Replacing the computer base](#)".
- 7 Follow the procedure from step 4 to step 7 in "[Replacing the optical drive](#)".
- 8 Replace the [keyboard](#).
- 9 Replace the [memory modules](#).
- 10 Replace the [wireless card](#).
- 11 Follow the procedure from step 4 to step 6 in "[Replacing the hard drive](#)".
- 12 Replace the [base cover](#).
- 13 Replace the [battery](#).

Removing the display panel



WARNING: Before working inside your computer, read the safety information that shipped with your computer and follow the steps in [Before working inside your computer](#). After working inside your computer, follow the instructions in [After working inside your computer](#). For more safety best practices, see the Regulatory Compliance home page at www.dell.com/regulatory_compliance.

Prerequisites



NOTE: These instructions are applicable only for laptops with a non-touch screen display.

- 1 Remove the [battery](#).
- 2 Remove the [base cover](#).
- 3 Follow the procedure from step 1 to step 3 in "[Removing the hard drive](#)".
- 4 Remove the [wireless card](#).
- 5 Remove the [memory modules](#).
- 6 Remove the [keyboard](#).
- 7 Follow the procedure from step 1 to step 4 in "[Removing the optical drive](#)".
- 8 Follow the procedure from step 1 to step 6 in "[Removing the computer base](#)".
- 9 Remove the [I/O board](#).
- 10 Remove the [heat-sink assembly](#).
- 11 Remove the [system board](#).
- 12 Remove the [power-adapter port](#).
- 13 Remove the [display assembly](#).
- 14 Remove the [display bezel](#).

Procedure

- 1 Remove the screws that secure the display panel to the display back-cover.

2 Gently lift the display panel and turn it over.

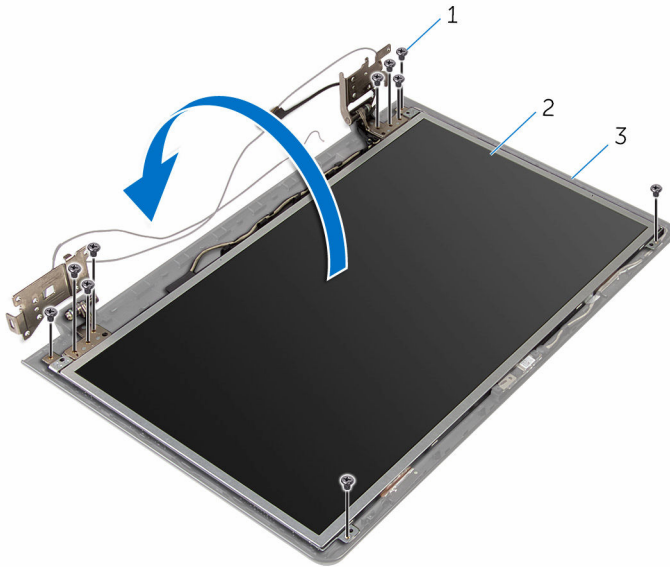

1 screws (10)

2 display panel

3 display back-cover

- 3** Gently peel the display cable, then lift the latch and disconnect the display cable from the display-cable connector.

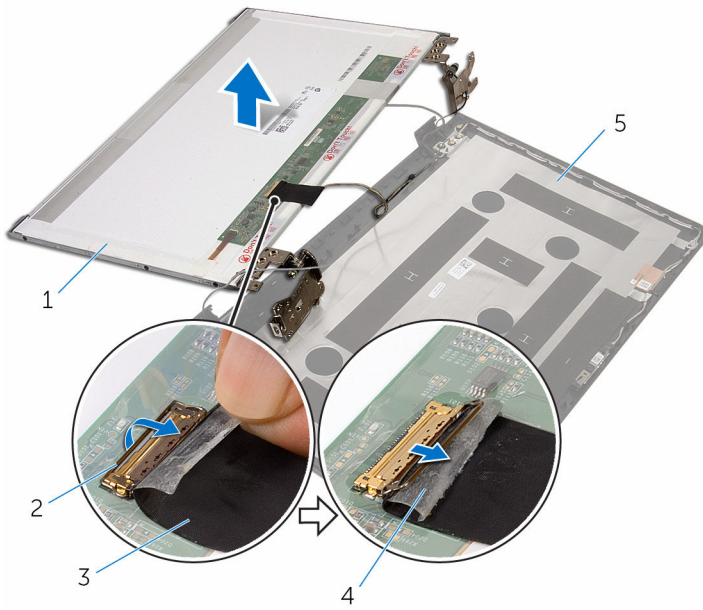

- | | | | |
|---|--------------------|---|-------|
| 1 | display panel | 2 | latch |
| 3 | display cable | 4 | tape |
| 5 | display back-cover | | |

- 4** Lift the display panel off the display back-cover.

- 5 Remove the [display hinges](#).

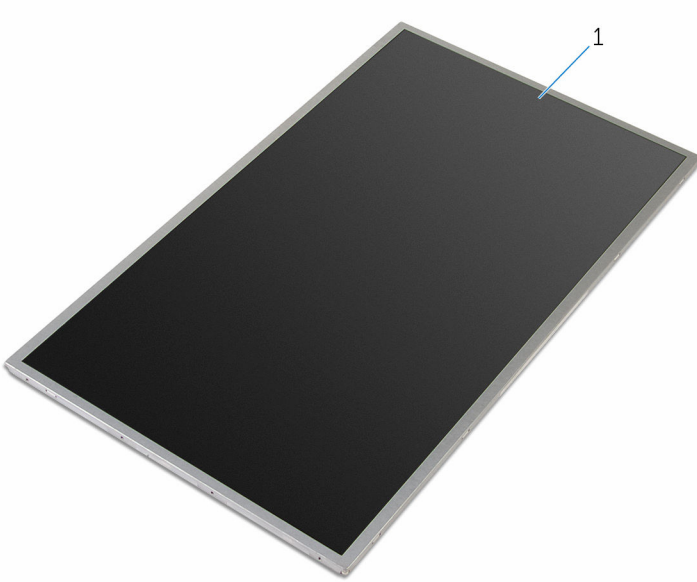

- 1 display panel

Replacing the display panel

 **WARNING:** Before working inside your computer, read the safety information that shipped with your computer and follow the steps in [Before working inside your computer](#). After working inside your computer, follow the instructions in [After working inside your computer](#). For more safety best practices, see the Regulatory Compliance home page at www.dell.com/regulatory_compliance.

Procedure

 **NOTE:** These instructions are only applicable for laptop with non-touchscreen display.

- 1 Replace the [display hinges](#).
- 2 Slide the display cable into the display-panel cable connector and press down the latch to secure the cable.
- 3 Adhere the display cable over the display-panel cable connector.
- 4 Gently place the display panel on the display back-cover and align the screw holes on the display panel with the screw holes on the display back-cover.
- 5 Replace the screws that secure the display panel to the display back-cover.

Post-requisites

- 1 Replace the [display bezel](#).
- 2 Replace the [display assembly](#).
- 3 Replace the [power-adapter port](#).
- 4 Replace the [system board](#).
- 5 Replace the [heat-sink assembly](#).
- 6 Replace the [I/O board](#).
- 7 Follow the procedure from step 3 to step 8 in "[Replacing the computer base](#)".
- 8 Follow the procedure from step 4 to step 7 in "[Replacing the optical drive](#)".
- 9 Replace the [keyboard](#).

- 10** Replace the [memory modules](#).
- 11** Replace the [wireless card](#).
- 12** Follow the procedure from step 4 to step 6 in "[Replacing the hard drive](#)".
- 13** Replace the [base cover](#).
- 14** Replace the [battery](#).

Removing the display hinges



WARNING: Before working inside your computer, read the safety information that shipped with your computer and follow the steps in [Before working inside your computer](#). After working inside your computer, follow the instructions in [After working inside your computer](#). For more safety best practices, see the Regulatory Compliance home page at www.dell.com/regulatory_compliance.

Prerequisites



NOTE: These instructions are applicable only for laptops with a non-touchscreen display.

- 1 Remove the [battery](#).
- 2 Remove the [base cover](#).
- 3 Follow the procedure from step 1 to step 3 in "[Removing the hard drive](#)".
- 4 Remove the [wireless card](#).
- 5 Remove the [memory modules](#).
- 6 Remove the [keyboard](#).
- 7 Follow the procedure from step 1 to step 4 in "[Removing the optical drive](#)".
- 8 Follow the procedure from step 1 to step 6 in "[Removing the computer base](#)".
- 9 Remove the [I/O board](#).
- 10 Remove the [heat-sink assembly](#).
- 11 Remove the [system board](#).
- 12 Remove the [power-adaptor port](#).
- 13 Remove the [display assembly](#).
- 14 Remove the [display bezel](#).
- 15 Remove the [display panel](#).

Procedure

- 1 Remove the screws that secure the display hinges to the display panel.

2 Lift the display hinges off the display panel.

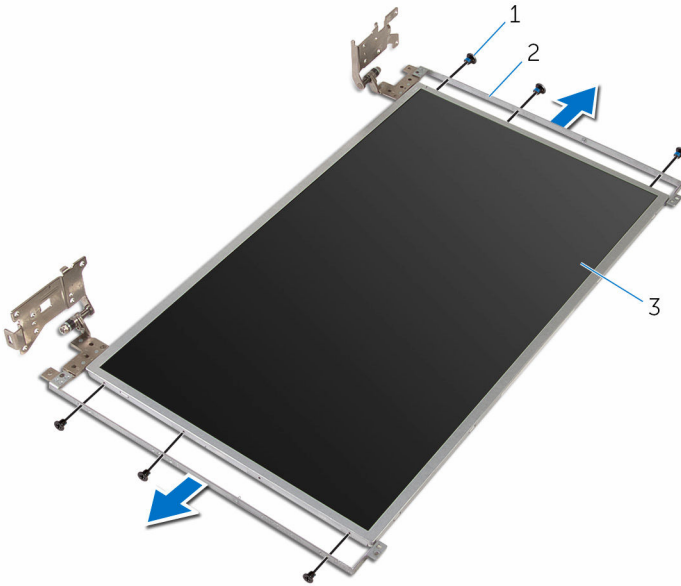

1 screws (6)

2 display hinges (2)

3 display panel

Replacing the display hinges



WARNING: Before working inside your computer, read the safety information that shipped with your computer and follow the steps in [Before working inside your computer](#). After working inside your computer, follow the instructions in [After working inside your computer](#). For more safety best practices, see the Regulatory Compliance home page at www.dell.com/regulatory_compliance.

Procedure



NOTE: These instructions are only applicable for laptop with non-touchscreen display.

- 1 Align the screw holes on the display hinges with the screw holes on the display panel.
- 2 Replace the screws that secure the display hinges to the display panel.

Post-requisites

- 1 Replace the [display panel](#).
- 2 Replace the [display bezel](#).
- 3 Replace the [display assembly](#).
- 4 Replace the [power-adapter port](#).
- 5 Replace the [system board](#).
- 6 Replace the [heat-sink assembly](#).
- 7 Replace the [I/O board](#).
- 8 Follow the procedure from step 3 to step 8 in "[Replacing the computer base](#)".
- 9 Follow the procedure from step 4 to step 7 in "[Replacing the optical drive](#)".
- 10 Replace the [keyboard](#).
- 11 Replace the [memory modules](#).
- 12 Replace the [wireless card](#).
- 13 Follow the procedure from step 4 to step 6 in "[Replacing the hard drive](#)".
- 14 Replace the [base cover](#).
- 15 Replace the [battery](#).

Removing the camera



WARNING: Before working inside your computer, read the safety information that shipped with your computer and follow the steps in [Before working inside your computer](#). After working inside your computer, follow the instructions in [After working inside your computer](#). For more safety best practices, see the Regulatory Compliance home page at www.dell.com/regulatory_compliance.

Prerequisites



NOTE: These instructions are applicable only for laptops with a non-touchscreen display.

- 1 Remove the [battery](#).
- 2 Remove the [base cover](#).
- 3 Follow the procedure from step 1 to step 3 in "[Removing the hard drive](#)".
- 4 Remove the [wireless card](#).
- 5 Remove the [memory modules](#).
- 6 Remove the [keyboard](#).
- 7 Follow the procedure from step 1 to step 4 in "[Removing the optical drive](#)".
- 8 Follow the procedure from step 1 to step 6 in "[Removing the computer base](#)".
- 9 Remove the [I/O board](#).
- 10 Remove the [heat-sink assembly](#).
- 11 Remove the [system board](#).
- 12 Remove the [power-adaptor port](#).
- 13 Remove the [display assembly](#).
- 14 Remove the [display bezel](#).

Procedure

- 1 Disconnect the camera cable from the camera module.

2 Using a plastic scribe, gently pry the camera off the display back-cover.

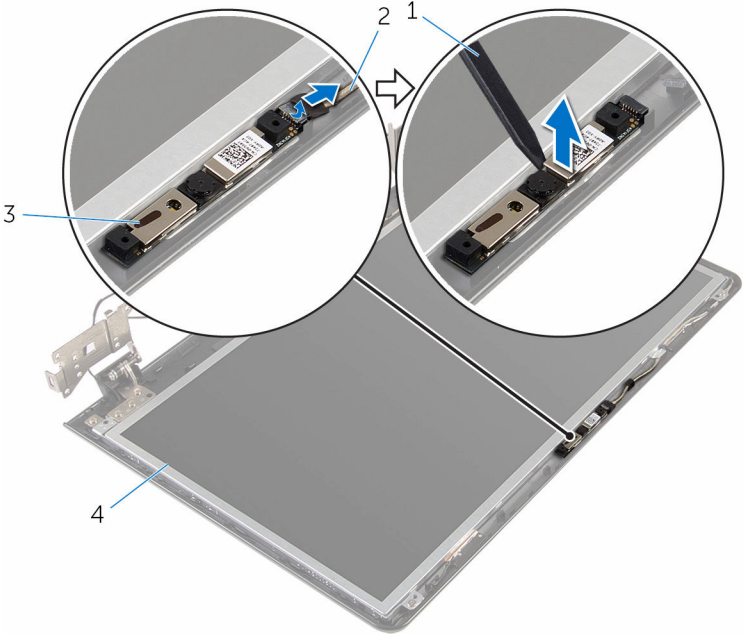

- 1 plastic scribe
- 3 camera

- 2 camera cable
- 4 display back-cover

Replacing the camera



WARNING: Before working inside your computer, read the safety information that shipped with your computer and follow the steps in [Before working inside your computer](#). After working inside your computer, follow the instructions in [After working inside your computer](#). For more safety best practices, see the Regulatory Compliance home page at www.dell.com/regulatory_compliance.

Procedure



NOTE: These instructions are only applicable for laptop with non-touchscreen display.

- 1 Using the alignment post, adhere the camera to the display back-cover.
- 2 Connect the camera cable to the camera connector.

Post-requisites

- 1 Replace the [display bezel](#).
- 2 Replace the [display assembly](#).
- 3 Replace the [power-adapter port](#).
- 4 Replace the [system board](#).
- 5 Replace the [heat-sink assembly](#).
- 6 Replace the [I/O board](#).
- 7 Follow the procedure from step 3 to step 8 in "[Replacing the computer base](#)".
- 8 Follow the procedure from step 4 to step 7 in "[Replacing the optical drive](#)".
- 9 Replace the [keyboard](#).
- 10 Replace the [memory modules](#).
- 11 Replace the [wireless card](#).
- 12 Follow the procedure from step 4 to step 6 in "[Replacing the hard drive](#)".
- 13 Replace the [base cover](#).
- 14 Replace the [battery](#).

Removing the display cable

 **WARNING:** Before working inside your computer, read the safety information that shipped with your computer and follow the steps in [Before working inside your computer](#). After working inside your computer, follow the instructions in [After working inside your computer](#). For more safety best practices, see the Regulatory Compliance home page at www.dell.com/regulatory_compliance.

Prerequisites

 **NOTE:** This chapter is applicable only for laptops with a non-touchscreen display.

- 1 Remove the [battery](#).
- 2 Remove the [base cover](#).
- 3 Follow the procedure from step 1 to step 3 in "[Removing the hard drive](#)".
- 4 Remove the [wireless card](#).
- 5 Remove the [memory modules](#).
- 6 Remove the [keyboard](#).
- 7 Follow the procedure from step 1 to step 4 in "[Removing the optical drive](#)".
- 8 Follow the procedure from step 1 to step 6 in "[Removing the computer base](#)".
- 9 Remove the [I/O board](#).
- 10 Remove the [heat-sink assembly](#).
- 11 Remove the [system board](#).
- 12 Remove the [power-adapter port](#).
- 13 Remove the [display assembly](#).
- 14 Remove the [display bezel](#).
- 15 Remove the [display panel](#).
- 16 Remove the [camera](#).

Procedure

- 1 Peel off the tapes that secure the camera cable to the display back-cover.

- 2 Note the display cable routing and remove the display cable from the routing guides on the display back-cover.
- 3 Note the camera cable routing and remove the camera cable from the display back-cover.

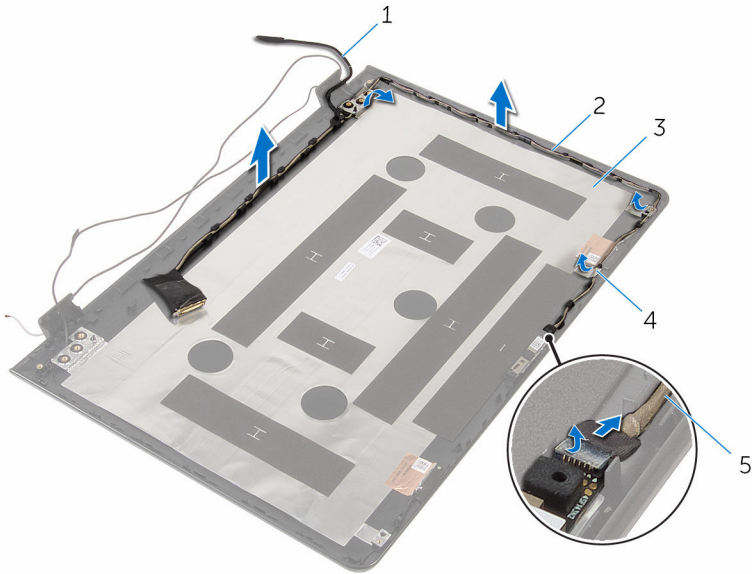

- | | | | |
|---|--------------------|---|----------------|
| 1 | display cable | 2 | routing guides |
| 3 | display back-cover | 4 | tape |
| 5 | camera cable | | |

Replacing the display cable

 **WARNING:** Before working inside your computer, read the safety information that shipped with your computer and follow the steps in [Before working inside your computer](#). After working inside your computer, follow the instructions in [After working inside your computer](#). For more safety best practices, see the Regulatory Compliance home page at www.dell.com/regulatory_compliance.

Procedure

- 1 Route the display cable through the routing guides on the display back-cover.
- 2 Adhere the tapes that secure the display cable to the display back-cover.

Post-requisites

- 1 Replace the [camera](#).
- 2 Replace the [display panel](#).
- 3 Replace the [display bezel](#).
- 4 Replace the [display assembly](#).
- 5 Replace the [power-adapter port](#).
- 6 Replace the [system board](#).
- 7 Replace the [heat-sink assembly](#).
- 8 Replace the [I/O board](#).
- 9 Follow the procedure from step 3 to step 8 in "[Replacing the computer base](#)".
- 10 Follow the procedure from step 4 to step 7 in "[Replacing the optical drive](#)".
- 11 Replace the [keyboard](#).
- 12 Replace the [memory modules](#).
- 13 Replace the [wireless card](#).
- 14 Follow the procedure from step 4 to step 6 in "[Replacing the hard drive](#)".
- 15 Replace the [base cover](#).
- 16 Replace the [battery](#).

Removing the display back-cover and antenna assembly

 **WARNING:** Before working inside your computer, read the safety information that shipped with your computer and follow the steps in [Before working inside your computer](#). After working inside your computer, follow the instructions in [After working inside your computer](#). For more safety best practices, see the Regulatory Compliance home page at www.dell.com/regulatory_compliance.

Prerequisites

 **NOTE:** These instructions are applicable only for laptops with a non-touchscreen display.

- 1 Remove the [battery](#).
- 2 Remove the [base cover](#).
- 3 Follow the procedure from step 1 to step 3 in "[Removing the hard drive](#)".
- 4 Remove the [wireless card](#).
- 5 Remove the [memory modules](#).
- 6 Remove the [keyboard](#).
- 7 Follow the procedure from step 1 to step 4 in "[Removing the optical drive](#)".
- 8 Follow the procedure from step 1 to step 6 in "[Removing the computer base](#)".
- 9 Remove the [I/O board](#).
- 10 Remove the [heat-sink assembly](#).
- 11 Remove the [system board](#).
- 12 Remove the [power-adaptor port](#).
- 13 Remove the [display assembly](#).
- 14 Remove the [display bezel](#).
- 15 Remove the [camera](#).
- 16 Remove the [display panel](#).
- 17 Remove the [display cable](#).

Procedure

After performing all the prerequisites, we are left with the display back-cover and antenna assembly.

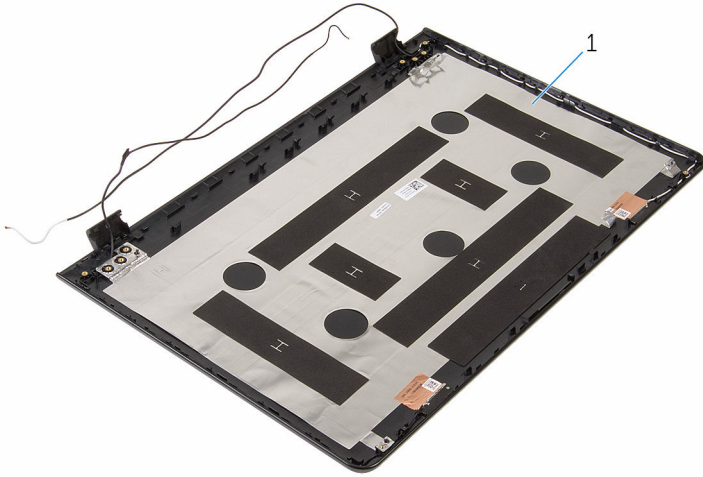

- 1 display back-cover and antenna assembly

Replacing the display back-cover and antenna assembly

 **WARNING:** Before working inside your computer, read the safety information that shipped with your computer and follow the steps in [Before working inside your computer](#). After working inside your computer, follow the instructions in [After working inside your computer](#). For more safety best practices, see the Regulatory Compliance home page at www.dell.com/regulatory_compliance.

Procedure

Place the display back-cover and antenna assembly on a flat surface.

Post-requisites

- 1 Replace the [display cable](#).
- 2 Replace the [display panel](#).
- 3 Replace the [camera](#).
- 4 Replace the [display bezel](#).
- 5 Replace the [display assembly](#).
- 6 Replace the [power-adapter port](#).
- 7 Replace the [system board](#).
- 8 Replace the [heat-sink assembly](#).
- 9 Replace the [I/O board](#).
- 10 Follow the procedure from step 3 to step 8 in "[Replacing the computer base](#)".
- 11 Follow the procedure from step 4 to step 7 in "[Replacing the optical drive](#)".
- 12 Replace the [keyboard](#).
- 13 Replace the [memory modules](#).
- 14 Replace the [wireless card](#).
- 15 Follow the procedure from step 4 to step 6 in "[Replacing the hard drive](#)".
- 16 Replace the [base cover](#).
- 17 Replace the [battery](#).

Flashing the BIOS

You may need to flash (update) the BIOS when an update is available or when you replace the system board. To flash the BIOS:

- 1 Turn on the computer.
- 2 Go to **www.dell.com/support**.
- 3 Click **Product Support**, enter the Service Tag of your computer and click **Submit**.
 **NOTE:** If you do not have the Service Tag, use the auto-detect feature or manually browse for your computer model.
- 4 Click **Drivers & downloads**.
- 5 Select the operating system installed on your computer.
- 6 Scroll down the page and expand **BIOS**.
- 7 Click **Download File** to download the latest version of the BIOS for your computer.
- 8 Save the file and, once the download is complete, navigate to the folder where you saved the BIOS update file.
- 9 Double-click the BIOS update file icon and follow the instructions on the screen.

Getting help and contacting Dell

Self-help resources

You can get information and help on Dell products and services using these self-help resources:

Information about Dell products and services

www.dell.com

Windows 8.1 and Windows 10

Dell Help & Support app



Windows 10

Get started app



Windows 8.1

Help + Tips app



Accessing help in Windows 8, Windows 8.1, and Windows 10

In Windows search, type **Help and Support**, and press **Enter**.

Accessing help in Windows 7

Click **Start** → **Help and Support**.

Online help for operating system

www.dell.com/support/windows

www.dell.com/support/linux

Troubleshooting information, user manuals, setup instructions, product specifications, technical help blogs, drivers, software updates, and so on

www.dell.com/support

Learn about your operating system, setting up and using your computer, data backup, diagnostics, and so on.

See *Me and My Dell* at

www.dell.com/support/manuals.

Contacting Dell

To contact Dell for sales, technical support, or customer service issues, see www.dell.com/contactdell.



NOTE: Availability varies by country and product, and some services may not be available in your country.



NOTE: If you do not have an active internet connection, you can find contact information on your purchase invoice, packing slip, bill, or Dell product catalog.