

Inspiron 15

3000 Series

Service Manual

Computer Model: Inspiron 15–3559
Regulatory Model: P47F
Regulatory Type: P47F004



Notes, cautions, and warnings



NOTE: A NOTE indicates important information that helps you make better use of your computer.



CAUTION: A CAUTION indicates either potential damage to hardware or loss of data and tells you how to avoid the problem.



WARNING: A WARNING indicates a potential for property damage, personal injury, or death.

Copyright © 2015 Dell Inc. All rights reserved. This product is protected by U.S. and international copyright and intellectual property laws. Dell™ and the Dell logo are trademarks of Dell Inc. in the United States and/or other jurisdictions. All other marks and names mentioned herein may be trademarks of their respective companies.

2015–11

Rev. A00

Contents

Before working inside your computer.....	9
Before you begin	9
Safety instructions.....	9
Recommended tools.....	10
After working inside your computer.....	11
Removing the battery.....	12
Procedure.....	12
Replacing the battery.....	13
Procedure.....	13
Removing the base panel.....	14
Prerequisites.....	14
Procedure.....	14
Replacing the base panel.....	15
Procedure.....	15
Post-requisites.....	15
Removing the hard drive.....	16
Prerequisites.....	16
Procedure.....	16
Replacing the hard drive.....	20
Procedure.....	20
Post-requisites.....	20

Removing the memory modules.....	21
Prerequisites.....	21
Procedure.....	21
Replacing the memory modules.....	23
Procedure.....	23
Post-requisites.....	24
Removing the wireless card.....	25
Prerequisites.....	25
Procedure.....	25
Replacing the wireless card.....	27
Procedure.....	27
Post-requisites.....	27
Removing the keyboard.....	28
Prerequisites.....	28
Procedure.....	28
Replacing the keyboard.....	31
Procedure.....	31
Post-requisites.....	31
Removing the palm rest.....	32
Prerequisites.....	32
Procedure.....	32
Replacing the palm rest.....	37
Procedure.....	37
Post-requisites.....	37

Removing the touch pad.....	38
Prerequisites.....	38
Procedure.....	39
Replacing the touch pad.....	42
Procedure.....	42
Post-requisites.....	42
Removing the power-button board.....	43
Prerequisites.....	43
Procedure.....	44
Replacing the power-button board.....	46
Procedure.....	46
Post-requisites.....	46
Removing the speakers.....	47
Prerequisites.....	47
Procedure.....	48
Replacing the speakers.....	50
Procedure.....	50
Post-requisites.....	50
Removing the I/O board.....	51
Prerequisites.....	51
Procedure.....	51
Replacing the I/O board.....	53
Procedure.....	53
Post-requisites.....	53

Removing the system board.....	54
Prerequisites.....	54
Procedure.....	55
Replacing the system board.....	58
Procedure.....	58
Post-requisites.....	59
Removing the coin-cell battery.....	60
Prerequisites.....	60
Procedure.....	60
Replacing the coin-cell battery.....	62
Procedure.....	62
Post-requisites.....	62
Removing the heat sink.....	63
Prerequisites.....	63
Procedure.....	63
Replacing the heat sink.....	65
Procedure.....	65
Post-requisites.....	65
Removing the fan.....	66
Prerequisites.....	66
Procedure.....	67
Replacing the fan.....	68
Procedure.....	68
Post-requisites.....	68



Removing the display assembly.....	69
Prerequisites.....	69
Procedure.....	69
Replacing the display assembly.....	72
Procedure.....	72
Post-requisites.....	72
Removing the power-adapter port.....	73
Prerequisites.....	73
Procedure.....	73
Replacing the power-adapter port.....	75
Procedure.....	75
Post-requisites.....	75
Removing the display bezel.....	76
Prerequisites.....	76
Procedure.....	76
Replacing the display bezel.....	78
Procedure.....	78
Post-requisites.....	78
Removing the display panel.....	79
Prerequisites.....	79
Procedure.....	79
Replacing the display panel.....	82
Procedure.....	82
Post-requisites.....	82

Removing the camera.....	83
Prerequisites.....	83
Procedure.....	83
Replacing the camera.....	85
Procedure.....	85
Post-requisites.....	85
Removing the display hinges.....	86
Prerequisites.....	86
Procedure.....	86
Replacing the display hinges.....	88
Procedure.....	88
Post-requisites.....	88
Flashing the BIOS.....	89
Getting help and contacting Dell.....	90
Self-help resources.....	90
Contacting Dell.....	91

Before working inside your computer

 **NOTE:** The images in this document may differ from your computer depending on the configuration you ordered.

Before you begin

- 1 Save and close all open files and exit all open applications.
 - 2 Shut down your computer.
 - Windows 10: Click or tap **Start** →  **Power** → **Shut down**.
 - Windows 8.1: On the **Start** screen, click or tap the power icon  → **Shut down**.
 - Windows 7: Click or tap **Start** → **Shut down**.
-  **NOTE:** If you are using a different operating system, see the documentation of your operating system for shut-down instructions.
- 3 Disconnect your computer and all attached devices from their electrical outlets.
 - 4 Disconnect all cables such as telephone cables, network cables and so on, from your computer.
 - 5 Disconnect all attached devices and peripherals, such as keyboard, mouse, monitor, and so on, from your computer.
 - 6 Remove any media card and optical disc from your computer, if applicable.

Safety instructions

Use the following safety guidelines to protect your computer from potential damage and ensure your personal safety.

 **WARNING:** Before working inside your computer, read the safety information that shipped with your computer. For more safety best practices, see the Regulatory Compliance home page at www.dell.com/regulatory_compliance.

 **WARNING:** Disconnect all power sources before opening the computer cover or panels. After you finish working inside the computer, replace all covers, panels, and screws before connecting to the power source.

 **CAUTION:** To avoid damaging the computer, ensure that the work surface is flat and clean.

 **CAUTION:** To avoid damaging the components and cards, handle them by their edges and avoid touching pins and contacts.

 **CAUTION:** You should only perform troubleshooting and repairs as authorized or directed by the Dell technical assistance team. Damage due to servicing that is not authorized by Dell is not covered by your warranty. See the safety instructions that shipped with the product or at www.dell.com/regulatory_compliance.

 **CAUTION:** Before touching anything inside your computer, ground yourself by touching an unpainted metal surface, such as the metal at the back of the computer. While you work, periodically touch an unpainted metal surface to dissipate static electricity, which could harm internal components.

 **CAUTION:** When you disconnect a cable, pull on its connector or on its pull tab, not on the cable itself. Some cables have connectors with locking tabs or thumb-screws that you must disengage before disconnecting the cable. When disconnecting cables, keep them evenly aligned to avoid bending any connector pins. When connecting cables, ensure that the ports and connectors are correctly oriented and aligned.

 **CAUTION:** Press and eject any installed card from the media-card reader.

Recommended tools

The procedures in this document may require the following tools:

- Phillips screwdriver
- Plastic scribe

After working inside your computer



CAUTION: Leaving stray or loose screws inside your computer may severely damage your computer.

- 1 Replace all screws and ensure that no stray screws remain inside your computer.
- 2 Connect any external devices, peripherals, and cables you removed before working on your computer.
- 3 Replace any media cards, discs, and any other parts that you removed before working on your computer.
- 4 Connect your computer and all attached devices to their electrical outlets.
- 5 Turn on your computer.

Removing the battery

 **WARNING:** Before working inside your computer, read the safety information that shipped with your computer and follow the steps in [Before working inside your computer](#). After working inside your computer, follow the instructions in [After working inside your computer](#). For more safety best practices, see the Regulatory Compliance home page at www.dell.com/regulatory_compliance.

Procedure

- 1 Close the display and turn the computer over.
- 2 Slide the battery-release latch to the unlock position.
- 3 Lift the battery at an angle and remove the battery from the battery bay.

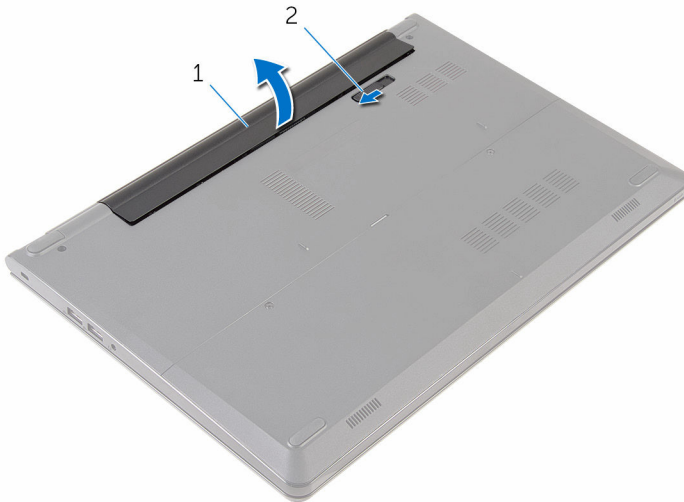

1 battery

2 battery-release latch

- 4 Turn the computer over, open the display, and press the power button for five seconds to ground the system board.

Replacing the battery



WARNING: Before working inside your computer, read the safety information that shipped with your computer and follow the steps in [Before working inside your computer](#). After working inside your computer, follow the instructions in [After working inside your computer](#). For more safety best practices, see the Regulatory Compliance home page at www.dell.com/regulatory_compliance.

Procedure

Slide the tabs on the battery into the slots on the battery bay and snap the battery into place.



NOTE: The battery-release latch returns to the lock position if the battery is installed properly.

Removing the base panel

⚠ WARNING: Before working inside your computer, read the safety information that shipped with your computer and follow the steps in [Before working inside your computer](#). After working inside your computer, follow the instructions in [After working inside your computer](#). For more safety best practices, see the Regulatory Compliance home page at www.dell.com/regulatory_compliance.

Prerequisites

Remove the [battery](#).

Procedure

- 1 Remove the screws that secure the base panel to the computer base.
- 2 Using your fingertips, gently pry the base panel off the computer base.

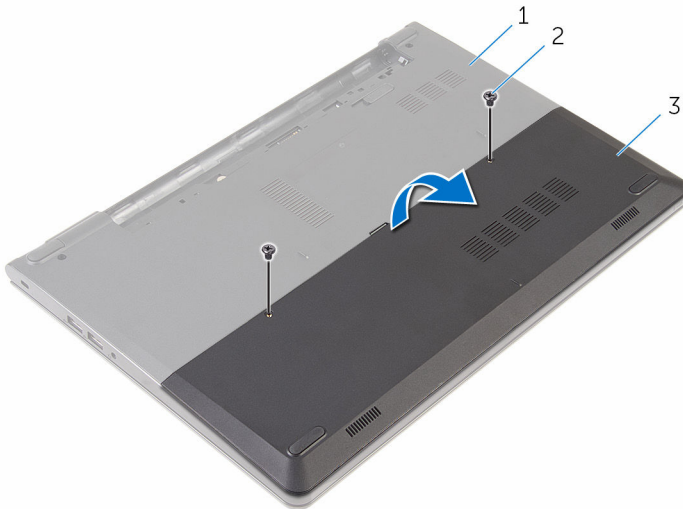

1 computer base

2 screws (2)

3 base panel

Replacing the base panel



WARNING: Before working inside your computer, read the safety information that shipped with your computer and follow the steps in [Before working inside your computer](#). After working inside your computer, follow the instructions in [After working inside your computer](#). For more safety best practices, see the Regulatory Compliance home page at www.dell.com/regulatory_compliance.



Procedure

- 1 Slide the tabs on the base panel into the slots on the computer base and snap the base panel into place.
- 2 Replace the screws that secure the base panel to the computer base.

Post-requisites

Replace the [battery](#).

Removing the hard drive

-  **WARNING:** Before working inside your computer, read the safety information that shipped with your computer and follow the steps in [Before working inside your computer](#). After working inside your computer, follow the instructions in [After working inside your computer](#). For more safety best practices, see the Regulatory Compliance home page at www.dell.com/regulatory_compliance.
-  **CAUTION:** Hard drives are fragile. Exercise care when handling the hard drive.
-  **CAUTION:** To avoid data loss, do not remove the hard drive while the computer is in sleep or on state.

Prerequisites

- 1 Remove the [battery](#).
- 2 Remove the [base panel](#).

Procedure

- 1 Remove the screws that secure the hard-drive assembly to the computer base.
- 2 Lift the latch and disconnect the hard-drive cable from the system board.

3 Lift the hard-drive assembly off the computer base.

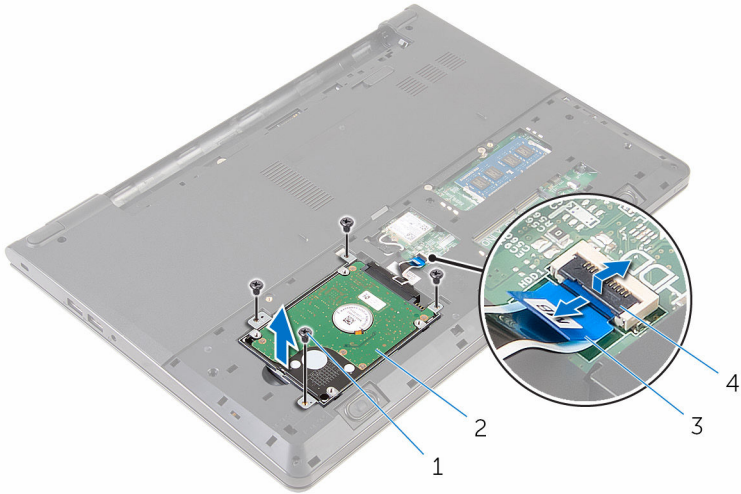

1 screws (4)

2 hard-drive assembly

3 hard-drive cable

4 latch

4 Disconnect the interposer from the hard drive.

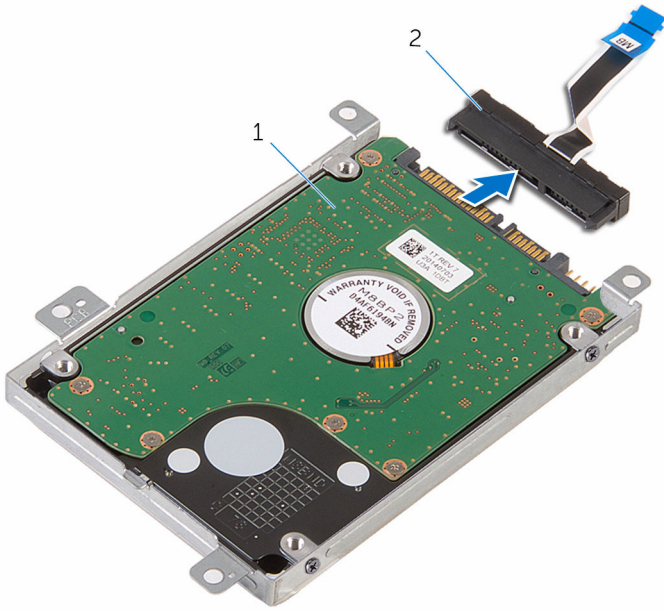

1 hard-drive assembly

2 interposer

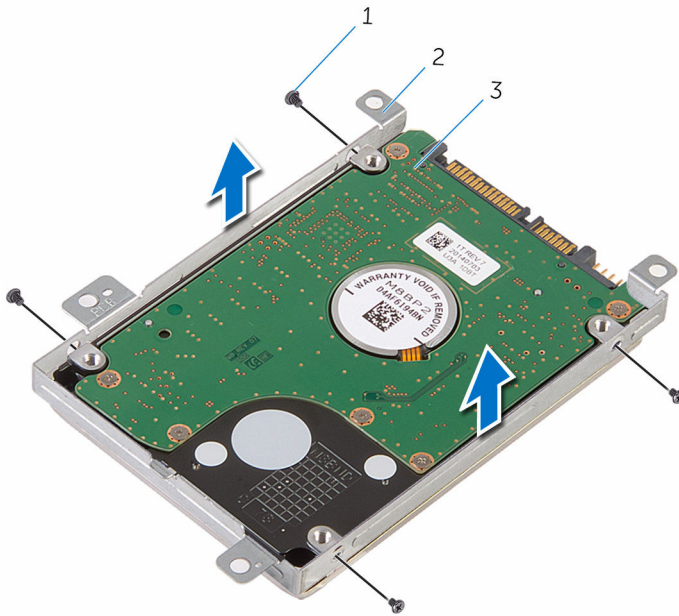

- 5 Remove the screws that secure the hard-drive bracket to the hard drive and lift the hard-drive bracket off the hard drive.



- 1 screws (4)
3 hard drive

- 2 hard-drive bracket

Replacing the hard drive

-  **WARNING:** Before working inside your computer, read the safety information that shipped with your computer and follow the steps in [Before working inside your computer](#). After working inside your computer, follow the instructions in [After working inside your computer](#). For more safety best practices, see the Regulatory Compliance home page at www.dell.com/regulatory_compliance.
-  **CAUTION:** Hard drives are fragile. Exercise care when handling the hard drive.

Procedure

- 1 Place the hard-drive bracket over the hard drive and align the screw holes on the hard-drive bracket with the screw holes on the hard drive.
- 2 Replace the screws that secure the hard-drive bracket to the hard drive.
- 3 Slide the hard-drive assembly in the computer base and align the screw holes on the hard-drive assembly with the screw holes on the computer base.
- 4 Slide the hard-drive cable into its connector and close the latch to secure the cable.
- 5 Replace the screws that secure the hard-drive assembly to the computer base.

Post-requisites

- 1 Replace the [base panel](#).
- 2 Replace the [battery](#).

Removing the memory modules

 **WARNING:** Before working inside your computer, read the safety information that shipped with your computer and follow the steps in [Before working inside your computer](#). After working inside your computer, follow the instructions in [After working inside your computer](#). For more safety best practices, see the Regulatory Compliance home page at www.dell.com/regulatory_compliance.

Prerequisites

- 1 Remove the [battery](#).
- 2 Remove the [base panel](#).

Procedure

- 1 Using your fingertips, pry apart the securing clips on each end of the memory-module slot until the memory module pops up.

2 Slide and remove the memory module from the memory-module slot.

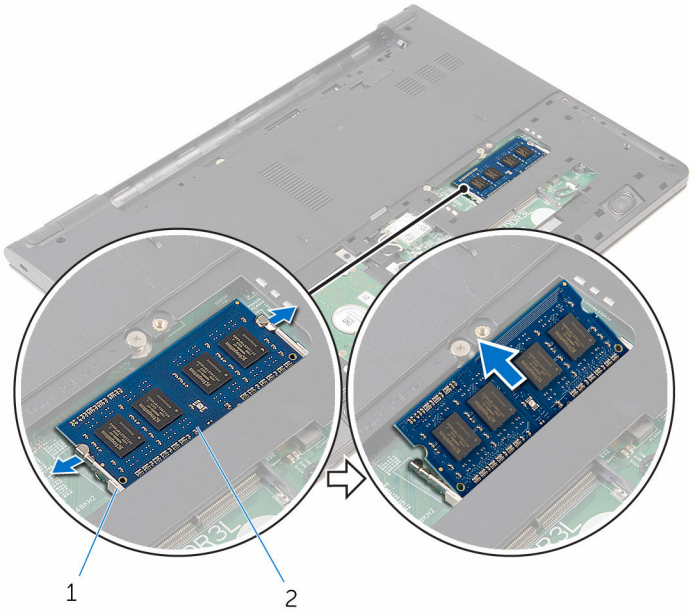

1 securing clips (2)

2 memory module

Replacing the memory modules

 **WARNING:** Before working inside your computer, read the safety information that shipped with your computer and follow the steps in [Before working inside your computer](#). After working inside your computer, follow the instructions in [After working inside your computer](#). For more safety best practices, see the Regulatory Compliance home page at www.dell.com/regulatory_compliance.

Procedure

- 1 Align the notch on the memory module with the tab on the memory-module slot.

- Slide the memory module firmly into the slot at an angle and press the memory module down until it clicks into place.

 **NOTE:** If you do not hear the click, remove the memory module and reinstall it.

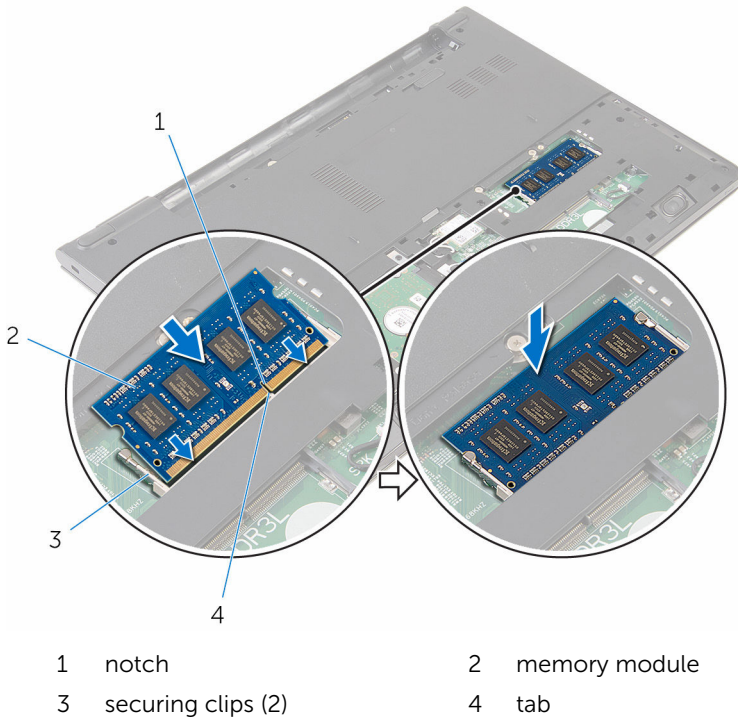

Post-requisites

- Replace the [base panel](#).
- Replace the [battery](#).

Removing the wireless card



WARNING: Before working inside your computer, read the safety information that shipped with your computer and follow the steps in [Before working inside your computer](#). After working inside your computer, follow the instructions in [After working inside your computer](#). For more safety best practices, see the Regulatory Compliance home page at www.dell.com/regulatory_compliance.

Prerequisites

- 1 Remove the [battery](#).
- 2 Remove the [base panel](#).

Procedure

- 1 Disconnect the antenna cables from the wireless card.
- 2 Remove the screw that secures the wireless card to the system board.

- 3** Lift the wireless card, and then slide and remove it from the system board.

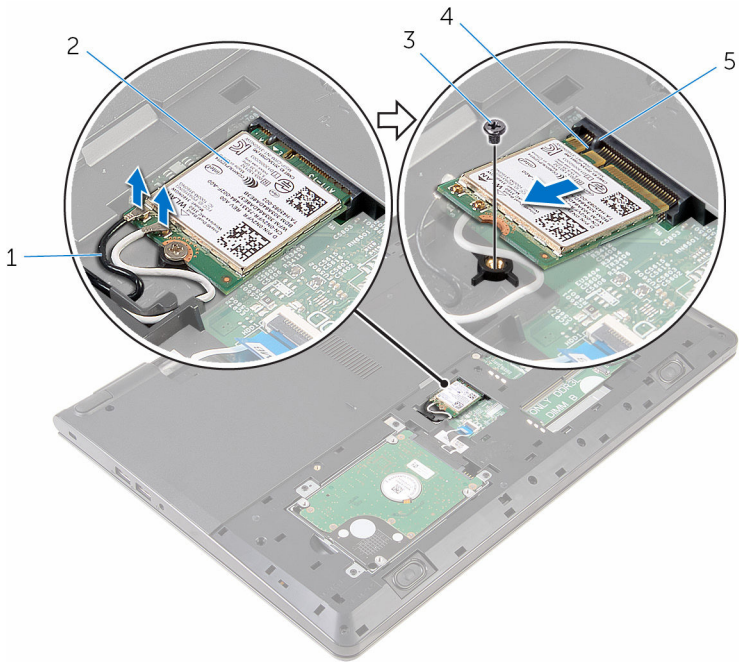

1 antenna cables (2)

3 screw

5 tab

2 wireless card

4 notch

Replacing the wireless card

 **WARNING:** Before working inside your computer, read the safety information that shipped with your computer and follow the steps in [Before working inside your computer](#). After working inside your computer, follow the instructions in [After working inside your computer](#). For more safety best practices, see the Regulatory Compliance home page at www.dell.com/regulatory_compliance.

Procedure

 **CAUTION:** To avoid damage to the wireless card, do not place any cables under it.

- 1 Align the notch on the wireless card with the tab on the wireless-card slot and slide the card into the slot.
- 2 Replace the screw that secures the wireless card to the system board.
- 3 Connect the antenna cables to the wireless card. The following table provides the antenna-cable color scheme for the wireless card supported by your computer:

Connectors on the wireless card	Antenna-cable color
Main (white triangle)	White
Auxiliary (black triangle)	Black

Post-requisites

- 1 Replace the [base panel](#).
- 2 Replace the [battery](#).

Removing the keyboard



WARNING: Before working inside your computer, read the safety information that shipped with your computer and follow the steps in [Before working inside your computer](#). After working inside your computer, follow the instructions in [After working inside your computer](#). For more safety best practices, see the Regulatory Compliance home page at www.dell.com/regulatory_compliance.

Prerequisites

Remove the [battery](#).

Procedure

- 1 Turn the computer over and open the display as far as possible.

- 2** Using a plastic scribe, gently release the tabs that secure the keyboard to the palm-rest assembly.



- | | | | |
|---|----------|---|--------------------|
| 1 | tab | 2 | plastic scribe |
| 3 | keyboard | 4 | palm-rest assembly |

- 3** Carefully turn the keyboard over and place it on the palm-rest assembly.

- 4 Lift the latches and disconnect the keyboard cable and the keyboard-backlight cable from the system board.

 **NOTE:** The keyboard-backlight cable is present only if the laptop is shipped with a backlit keyboard.



- | | | | |
|---|----------|---|--------------------|
| 1 | latch | 2 | keyboard cable |
| 3 | keyboard | 4 | palm-rest assembly |

- 5 Lift the keyboard, along with the cables, off the palm-rest assembly.

Replacing the keyboard



WARNING: Before working inside your computer, read the safety information that shipped with your computer and follow the steps in [Before working inside your computer](#). After working inside your computer, follow the instructions in [After working inside your computer](#). For more safety best practices, see the Regulatory Compliance home page at www.dell.com/regulatory_compliance.

Procedure

- 1 Slide the keyboard cable into the system-board slot and press down on the latch to secure the cable.
- 2 Carefully turn the keyboard over, slide the tabs on the keyboard into the slots on the palm rest, and snap the keyboard into place.
- 3 Close the display and turn the computer over.

Post-requisites

Replace the [battery](#).

Removing the palm rest



WARNING: Before working inside your computer, read the safety information that shipped with your computer and follow the steps in [Before working inside your computer](#). After working inside your computer, follow the instructions in [After working inside your computer](#). For more safety best practices, see the Regulatory Compliance home page at www.dell.com/regulatory_compliance.

Prerequisites

- 1 Remove the [battery](#).
- 2 Remove the [base panel](#).
- 3 Follow the procedure from step 1 to step 3 in “Removing the [hard drive](#)”.
- 4 Remove the [keyboard](#).

Procedure

- 1 Lift the latch and disconnect the touch-pad cable from the system board.
- 2 Lift the latch and disconnect the power-button cable from the system board.

- 3** Remove the screws that secure the palm-rest assembly to the computer base.

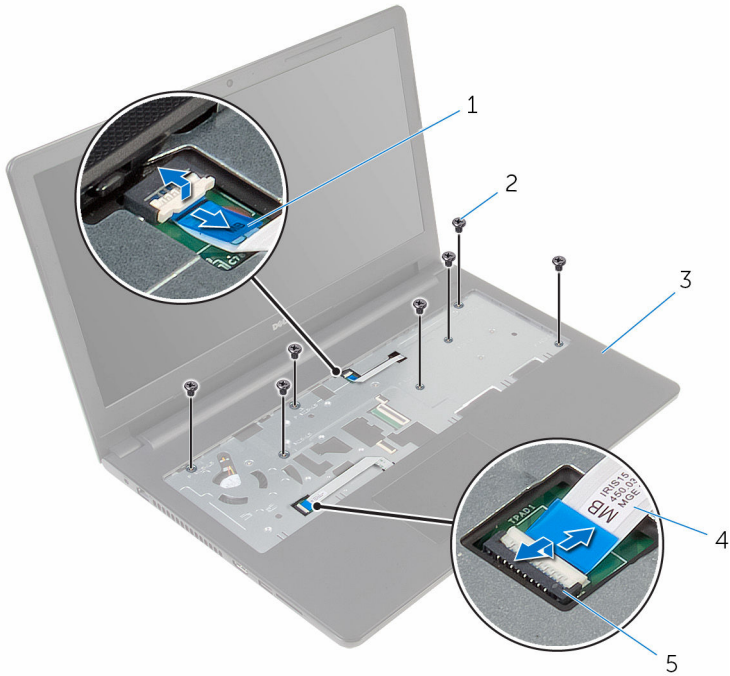

1 power-button cable

2 screws (7)

3 palm-rest assembly

4 touch-pad cable

5 latch

- 4** Close the display and turn the computer over.

- 5 Remove the screws that secure the palm-rest assembly to the computer base.

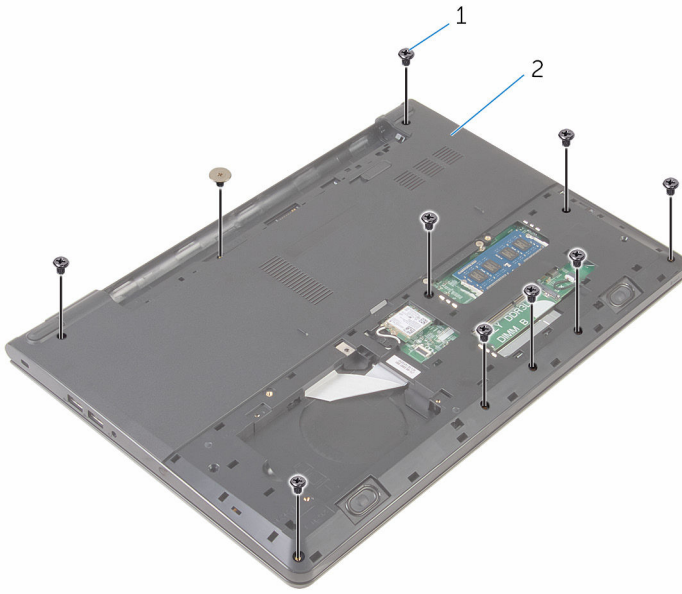

1 screws (10)

2 computer base

- 6** Slightly open the computer base and, using a plastic scribe, pry the palm-rest assembly off the computer base.

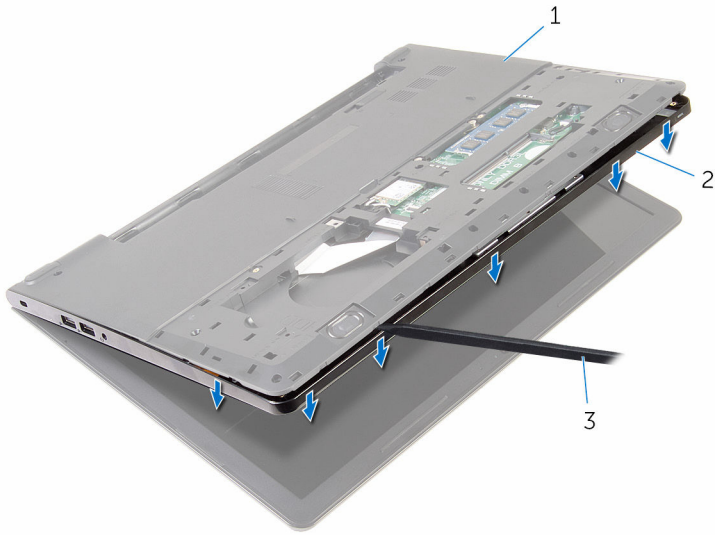

1 computer base

2 palm-rest assembly

3 plastic scribe

- 7** Turn the computer over and open the display.

- 8 Lift the palm-rest assembly off the computer base.



1 palm-rest assembly

2 computer base

- 9 Follow the procedure from step 1 to step 5 in “Removing the [touch pad](#)”.

Replacing the palm rest



WARNING: Before working inside your computer, read the safety information that shipped with your computer and follow the steps in [Before working inside your computer](#). After working inside your computer, follow the instructions in [After working inside your computer](#). For more safety best practices, see the Regulatory Compliance home page at www.dell.com/regulatory_compliance.

Procedure

- 1 Follow the procedure from step 1 to step 5 in “Replacing the [touch pad](#)”.
- 2 Align the screw holes on the palm rest with the screw holes on the computer base and snap the palm rest into place.
- 3 Replace the screws that secure the palm rest to the computer base.
- 4 Slide the touch-pad cable and the power-button cable into the respective connectors and press down on the latches to secure the cables.
- 5 Turn the computer over.
- 6 Replace the screws that secure the palm rest to the back cover.

Post-requisites

- 1 Replace the [keyboard](#).
- 2 Follow the procedure from step 3 to step 5 in “Replacing the [hard drive](#)”.
- 3 Replace the [base panel](#).
- 4 Replace the [battery](#).

Removing the touch pad



WARNING: Before working inside your computer, read the safety information that shipped with your computer and follow the steps in [Before working inside your computer](#). After working inside your computer, follow the instructions in [After working inside your computer](#). For more safety best practices, see the Regulatory Compliance home page at www.dell.com/regulatory_compliance.

Prerequisites

- 1 Remove the [battery](#).
- 2 Remove the [base panel](#).
- 3 Follow the procedure from step 1 to step 3 in “Removing the [hard drive](#)”.
- 4 Remove the [keyboard](#).
- 5 Remove the [palm rest](#).

Procedure

- 1 Peel the tape off the touch-pad bracket.

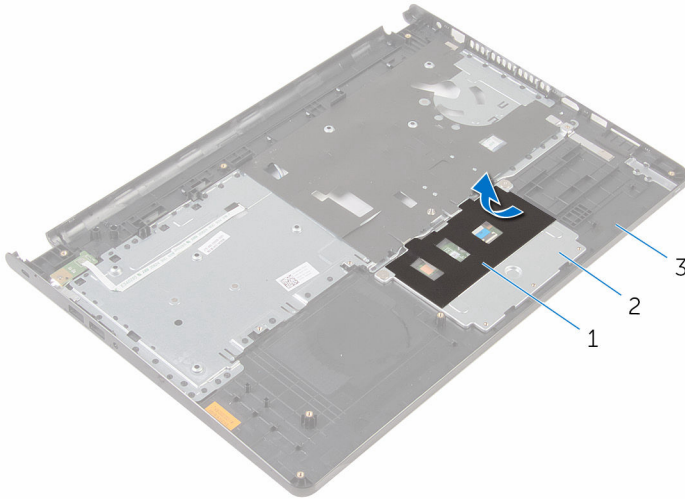

1 tape

2 touch-pad bracket

3 palm rest

- 2 Remove the screws that secure the touch-pad bracket to the touch pad.

3 Lift the latch and disconnect the touch-pad cable from the touch pad.

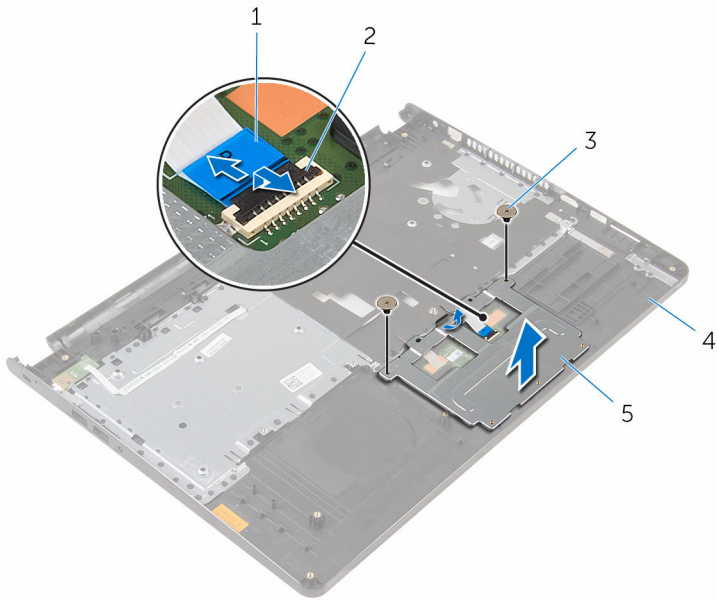

1 touch-pad cable

2 latch

3 screws (2)

4 palm rest

5 touch-pad bracket

4 Peel off the tape from the touch pad.

- 5 Lift the touch pad off the palm rest.

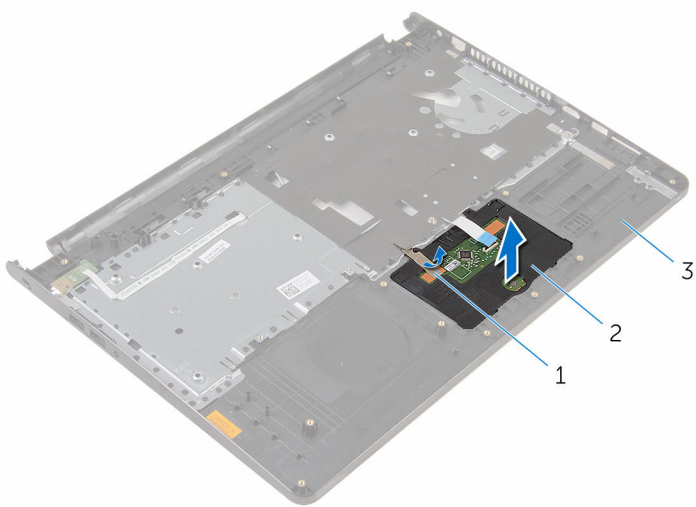

1 tape

2 touch pad

3 palm rest

Replacing the touch pad



WARNING: Before working inside your computer, read the safety information that shipped with your computer and follow the steps in [Before working inside your computer](#). After working inside your computer, follow the instructions in [After working inside your computer](#). For more safety best practices, see the Regulatory Compliance home page at www.dell.com/regulatory_compliance.

Procedure

- 1 Slide the tabs on the touch pad into the slots on the palm rest.
- 2 Adhere the tape that secures the touch pad to the palm rest.
- 3 Align the screw holes on the touch-pad bracket with the screw holes on the palm rest.
- 4 Replace the screws that secure the touch-pad bracket to the palm rest.
- 5 Adhere the tape over the touch-pad bracket.

Post-requisites

- 1 Replace the [palm rest](#).
- 2 Replace the [keyboard](#).
- 3 Follow the procedure from step 4 to step 6 in "Replacing the [hard drive](#)".
- 4 Replace the [base panel](#).
- 5 Replace the [battery](#).

Removing the power-button board



WARNING: Before working inside your computer, read the safety information that shipped with your computer and follow the steps in [Before working inside your computer](#). After working inside your computer, follow the instructions in [After working inside your computer](#). For more safety best practices, see the Regulatory Compliance home page at www.dell.com/regulatory_compliance.

Prerequisites

- 1 Remove the [battery](#).
- 2 Remove the [base panel](#).
- 3 Follow the procedure from step 1 to step 3 in “Removing the [hard drive](#)”.
- 4 Remove the [keyboard](#).
- 5 Follow the procedure from step 1 to step 8 in “Removing the [palm rest](#)”.

Procedure

- 1 Slide the power-button board cable through the slot on the palm rest.

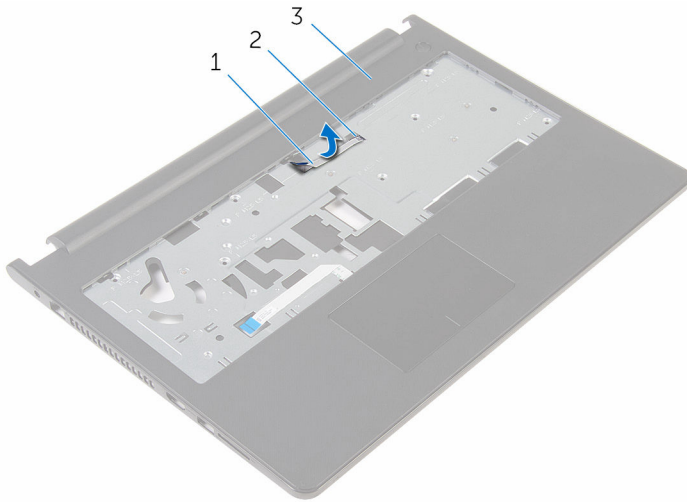

- 1 power-button board cable
- 2 slot
- 3 palm rest

- 2 Turn the palm rest over.
- 3 Remove the screw that secures the power-button board to the palm rest.
- 4 Slide the power-button board out from the tab on the palm rest.

5 Lift the power-button board, along with its cable, off the palm rest.

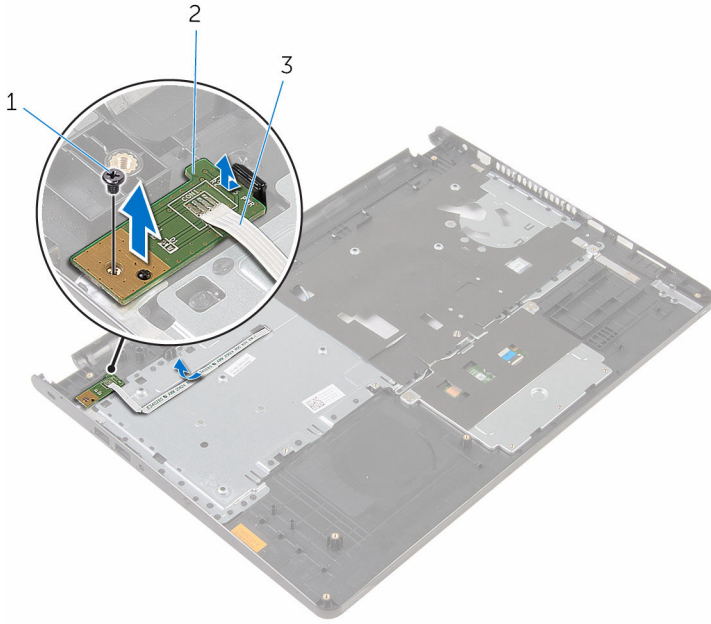

1 screw

2 power-button board

3 power-button board cable

Replacing the power-button board



WARNING: Before working inside your computer, read the safety information that shipped with your computer and follow the steps in [Before working inside your computer](#). After working inside your computer, follow the instructions in [After working inside your computer](#). For more safety best practices, see the Regulatory Compliance home page at www.dell.com/regulatory_compliance.

Procedure

- 1 Slide the power-button board under the tab on the palm rest and align the screw hole on the power-button board with the screw hole on the palm rest.
- 2 Replace the screw that secures the power-button board to the palm rest.
- 3 Slide the power-button board cable through the slot on the palm rest.

Post-requisites

- 1 Follow the procedure from step 2 to step 6 in “Replacing the [palm rest](#)”.
- 2 Replace the [keyboard](#).
- 3 Follow the procedure from step 4 to step 6 in “Replacing the [hard drive](#)”.
- 4 Replace the [base panel](#).
- 5 Replace the [battery](#).

Removing the speakers



WARNING: Before working inside your computer, read the safety information that shipped with your computer and follow the steps in [Before working inside your computer](#). After working inside your computer, follow the instructions in [After working inside your computer](#). For more safety best practices, see the Regulatory Compliance home page at www.dell.com/regulatory_compliance.

Prerequisites

- 1 Remove the [battery](#).
- 2 Remove the [base panel](#).
- 3 Follow the procedure from step 1 to step 3 in “Removing the [hard drive](#)”.
- 4 Remove the [keyboard](#).
- 5 Follow the procedure from step 1 to step 8 in “Removing the [palm rest](#)”.

Procedure

- 1 Disconnect the speaker cable from the system board.

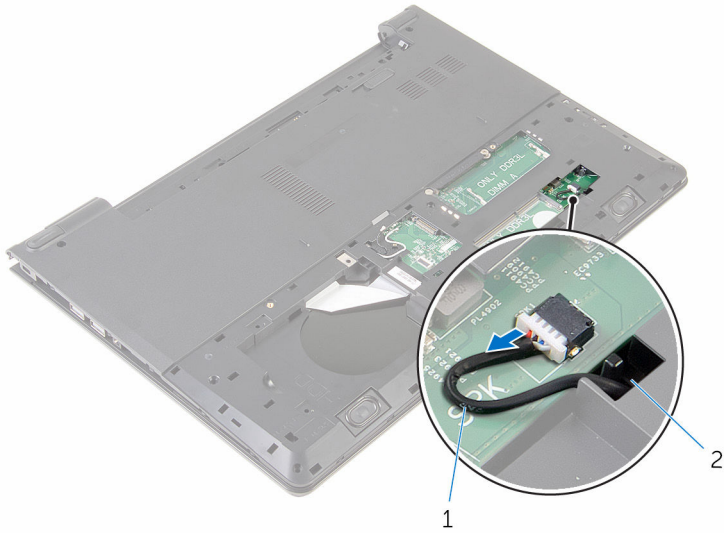

1 speaker cable

2 slot

- 2 Turn the computer over and open the display.
- 3 Note the speaker-cable routing and remove the cable from the routing guides on the computer base.

- 4 Slide the speaker cable through the slot on the computer base and lift the speakers, along with the speaker cable, off the computer base.



1 speaker cable

2 speakers (2)

Replacing the speakers



WARNING: Before working inside your computer, read the safety information that shipped with your computer and follow the steps in [Before working inside your computer](#). After working inside your computer, follow the instructions in [After working inside your computer](#). For more safety best practices, see the Regulatory Compliance home page at www.dell.com/regulatory_compliance.

Procedure

- 1 Using the alignment posts, align and place the speakers on the palm rest.
- 2 Route the speaker cable through the routing guides on the palm rest.
- 3 Turn the computer over.
- 4 Slide the speaker cable through the slot on the computer base and connect the speaker cable to the system board.

Post-requisites

- 1 Follow the procedure from step 2 to step 6 in “Replacing the [palm rest](#)”.
- 2 Replace the [keyboard](#).
- 3 Follow the procedure from step 3 to step 5 in “Replacing the [hard drive](#)”.
- 4 Replace the [base panel](#).
- 5 Replace the [battery](#).

Removing the I/O board



WARNING: Before working inside your computer, read the safety information that shipped with your computer and follow the steps in [Before working inside your computer](#). After working inside your computer, follow the instructions in [After working inside your computer](#). For more safety best practices, see the Regulatory Compliance home page at www.dell.com/regulatory_compliance.

Prerequisites

- 1 Remove the [battery](#).
- 2 Remove the [base panel](#).
- 3 Follow the procedure from step 1 to step 3 in “Removing the [hard drive](#)”.
- 4 Remove the [keyboard](#).
- 5 Follow the procedure from step 1 to step 8 in “Removing the [palm rest](#)”.

Procedure

- 1 Lift the latch and disconnect the I/O-board cable from the I/O board.
- 2 Remove the screw that secures the I/O board to the computer base.

3 Lift the I/O board off the computer base.

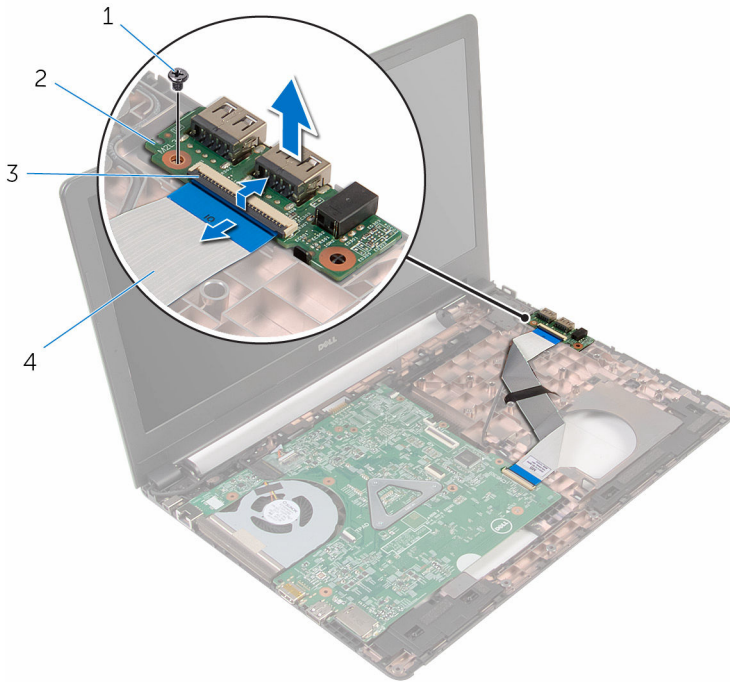

1 screw

2 I/O board

3 latch

4 I/O-board cable

Replacing the I/O board



WARNING: Before working inside your computer, read the safety information that shipped with your computer and follow the steps in [Before working inside your computer](#). After working inside your computer, follow the instructions in [After working inside your computer](#). For more safety best practices, see the Regulatory Compliance home page at www.dell.com/regulatory_compliance.

Procedure

- 1 Align the screw hole on the I/O board with the screw hole on the computer base.
- 2 Replace the screw that secures the I/O board to the computer base.
- 3 Slide the I/O-board cable into the connector on the I/O board and press down the latch to secure the cable.

Post-requisites

- 1 Follow the procedure from step 2 to step 6 in "Replacing the [palm rest](#)".
- 2 Replace the [keyboard](#).
- 3 Follow the procedure from step 3 to step 5 in "Replacing the [hard drive](#)".
- 4 Replace the [base panel](#).
- 5 Replace the [battery](#).

Removing the system board



WARNING: Before working inside your computer, read the safety information that shipped with your computer and follow the steps in [Before working inside your computer](#). After working inside your computer, follow the instructions in [After working inside your computer](#). For more safety best practices, see the Regulatory Compliance home page at www.dell.com/regulatory_compliance.



NOTE: Your computer's Service Tag is stored in the system board. You must enter the Service Tag in the BIOS setup program after you replace the system board.



NOTE: Replacing the system board removes any changes you have made to the BIOS using the BIOS setup program. You must make the desired changes again after you replace the system board.



NOTE: Before disconnecting the cables from the system board, note the location of the connectors so that you can reconnect the cables correctly after you replace the system board.

Prerequisites

- 1 Remove the [battery](#).
- 2 Remove the [base panel](#).
- 3 Follow the procedure from step 1 to step 3 in "Removing the [hard drive](#)".
- 4 Remove the [memory modules](#).
- 5 Remove the [wireless card](#).
- 6 Remove the [keyboard](#).
- 7 Follow the procedure from step 1 to step 8 in "Removing the [palm rest](#)".

Procedure

- 1 Disconnect the speaker cable from the system board.

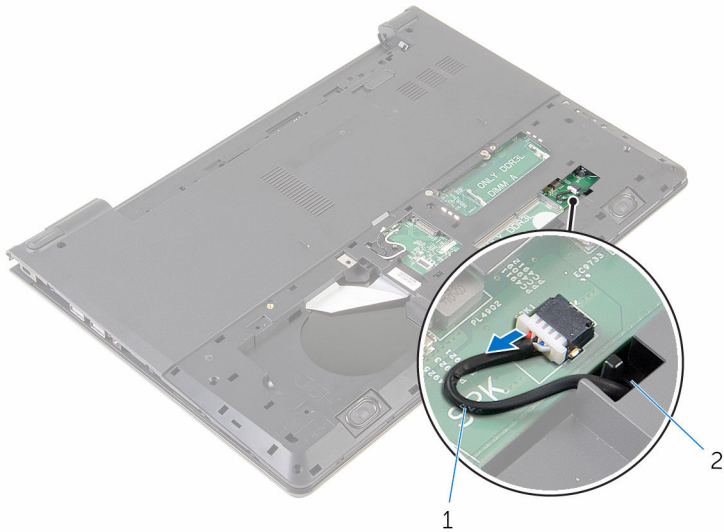

1 speaker cable

2 slot

- 2 Turn the computer over and open the display as far as possible.
- 3 Peel the tape that secures the display cable to the system board.
- 4 Lift the latch and disconnect the display cable from the system board.
- 5 Disconnect the power-adaptor port cable from the system board.

6 Lift the latch and disconnect the I/O-board cable from the system board.



1 tape

3 latch

5 I/O-board cable

2 display cable

4 power-adaptor port cable

6 system board

7 Remove the screw that secures the system board to the computer base.

- 8** Lift the system board off the computer base.

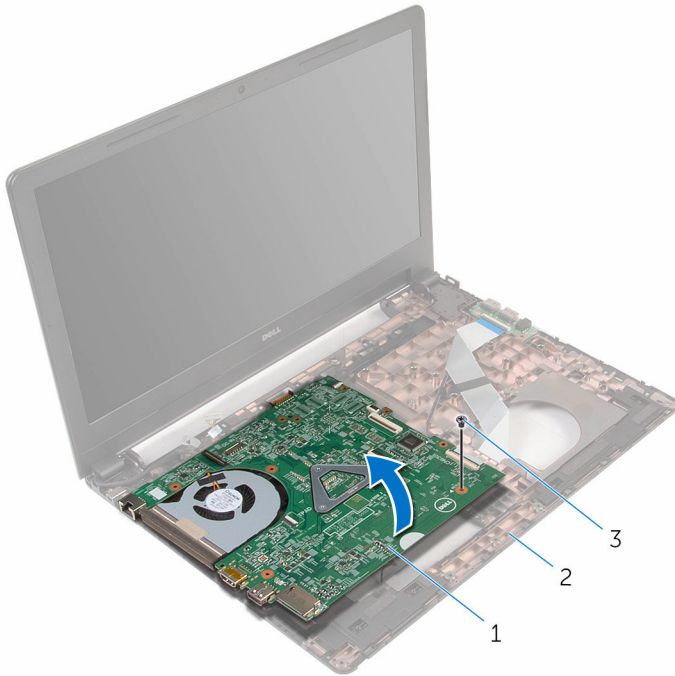

1 system board

2 computer base

3 screw

- 9** Remove the [coin-cell battery](#).

- 10** Remove the [heat sink](#).

Replacing the system board



WARNING: Before working inside your computer, read the safety information that shipped with your computer and follow the steps in [Before working inside your computer](#). After working inside your computer, follow the instructions in [After working inside your computer](#). For more safety best practices, see the Regulatory Compliance home page at www.dell.com/regulatory_compliance.



NOTE: Your computer's Service Tag is stored in the system board. You must enter the Service Tag in the BIOS setup program after you replace the system board.



NOTE: Replacing the system board removes any changes you have made to the BIOS using the BIOS setup program. You must make the desired changes again after you replace the system board.

Procedure

- 1 Replace the [heat sink](#).
- 2 Replace the [coin-cell battery](#).



CAUTION: To avoid damaging the system board, ensure that no cables are placed under it.

- 3 Align the screw hole on the system board with the screw hole on the computer base and place the system board on the computer base.
- 4 Replace the screw that secures the system board to the computer base.
- 5 Connect the power-adaptor port cable to the system board.
- 6 Slide the display cable into the connector on the system board and press down the latch to secure the cable.
- 7 Adhere the tape that secures the display cable to the system board.
- 8 Slide the I/O-board cable into the connector on the system board and press down the latch to secure the cable.
- 9 Close the display and turn the computer over.
- 10 Connect the speaker cable to the system board.

Post-requisites

- 1 Follow the procedure from step 2 to step 6 in "Replacing the [palm rest](#)".
- 2 Replace the [keyboard](#).
- 3 Replace the [wireless card](#).
- 4 Replace the [memory modules](#).
- 5 Follow the procedure from step 3 to step 5 in "Replacing the [hard drive](#)".
- 6 Replace the [battery](#).
- 7 Replace the [base panel](#).

Removing the coin-cell battery

 **WARNING:** Before working inside your computer, read the safety information that shipped with your computer and follow the steps in [Before working inside your computer](#). After working inside your computer, follow the instructions in [After working inside your computer](#). For more safety best practices, see the Regulatory Compliance home page at www.dell.com/regulatory_compliance.

 **CAUTION:** Removing the coin-cell battery resets the BIOS setup program's settings to default. It is recommended that you note the BIOS setup program's settings before removing the coin-cell battery.

Prerequisites

- 1 Remove the [battery](#).
- 2 Remove the [base panel](#).
- 3 Follow the procedure from step 1 to step 3 in "Removing the [hard drive](#)".
- 4 Remove the [memory modules](#).
- 5 Remove the [wireless card](#).
- 6 Remove the [keyboard](#).
- 7 Follow the procedure from step 1 to step 8 in "Removing the [palm rest](#)".
- 8 Follow the procedure from step 1 to step 8 in "Removing the [system board](#)".

Procedure

Using a plastic scribe, gently pry the coin-cell battery out of the battery socket on the system board.

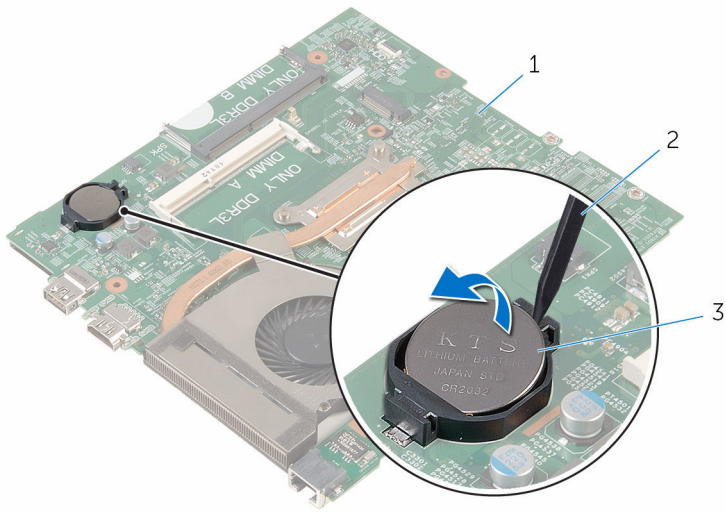

- 1 system board
- 3 coin-cell battery

- 2 plastic scribe

Replacing the coin-cell battery



WARNING: Before working inside your computer, read the safety information that shipped with your computer and follow the steps in [Before working inside your computer](#). After working inside your computer, follow the instructions in [After working inside your computer](#). For more safety best practices, see the Regulatory Compliance home page at www.dell.com/regulatory_compliance.

Procedure

With the positive-side facing up, snap the coin-cell battery into the battery socket on the system board.

Post-requisites

- 1 Follow the procedure from step 3 to step 10 in “Replacing the [system board](#)”.
- 2 Follow the procedure from step 2 to step 6 in “Replacing the [palm rest](#)”.
- 3 Replace the [keyboard](#).
- 4 Replace the [wireless card](#).
- 5 Replace the [memory modules](#).
- 6 Follow the procedure from step 3 to step 5 in “Replacing the [hard drive](#)”.
- 7 Replace the [battery](#).
- 8 Replace the [base panel](#).

Removing the heat sink

 **WARNING:** Before working inside your computer, read the safety information that shipped with your computer and follow the steps in [Before working inside your computer](#). After working inside your computer, follow the instructions in [After working inside your computer](#). For more safety best practices, see the Regulatory Compliance home page at www.dell.com/regulatory_compliance.

 **WARNING:** The heat sink may become hot during normal operation. Allow sufficient time for the heat sink to cool before you touch it.

 **CAUTION:** For maximum cooling of the processor, do not touch the heat transfer areas on the heat sink. The oils in your skin can reduce the heat transfer capability of the thermal grease.

Prerequisites

- 1 Remove the [battery](#).
- 2 Remove the [base panel](#).
- 3 Follow the procedure from step 1 to step 3 in "Removing the [hard drive](#)".
- 4 Remove the [memory modules](#).
- 5 Remove the [wireless card](#).
- 6 Remove the [keyboard](#).
- 7 Follow the procedure from step 1 to step 8 in "Removing the [palm rest](#)".
- 8 Follow the procedure from step 1 to step 8 in "Removing the [system board](#)".

Procedure

- 1 Turn the system board over.
- 2 In sequential order, as indicated on the heat sink, loosen the captive screws that secure the cooling assembly to the system board.

3 Disconnect the fan cable from the system board.

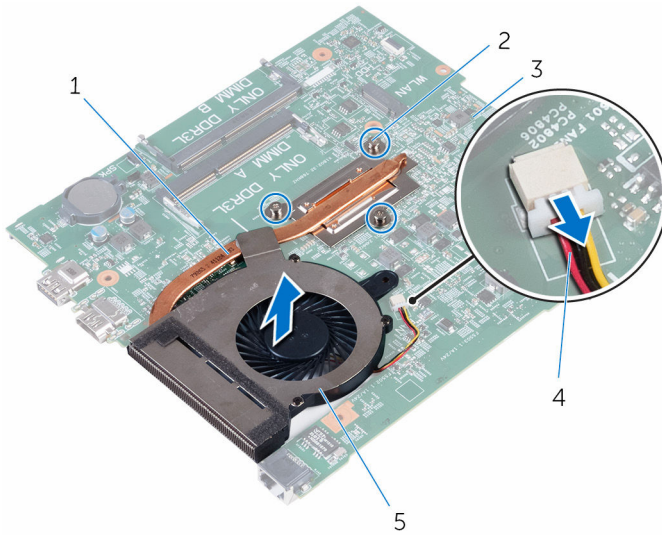

1 cooling assembly

2 captive screws (3)

3 system board

4 fan cable

5 fan

4 Lift the cooling assembly off the system board.

5 Remove the [fan](#).

Replacing the heat sink

 **WARNING:** Before working inside your computer, read the safety information that shipped with your computer and follow the steps in [Before working inside your computer](#). After working inside your computer, follow the instructions in [After working inside your computer](#). For more safety best practices, see the Regulatory Compliance home page at www.dell.com/regulatory_compliance.

 **CAUTION:** Incorrect alignment of the heat sink can damage the system board and processor.

 **NOTE:** The original thermal grease can be reused if the original system board and heat sink are reinstalled together. If either the system board or the heat sink is replaced, use the thermal pad provided in the kit to ensure that thermal conductivity is achieved.

Procedure

- 1 Replace the [fan](#).
- 2 Align the screws on the cooling assembly with the screw holes on the system board.
- 3 In sequential order, as indicated on the heat sink, tighten the captive screws that secure the cooling assembly to the system board.
- 4 Connect the fan cable to the system board.

Post-requisites

- 1 Follow the procedure from step 3 to step 10 in “Replacing the [system board](#)”.
- 2 Follow the procedure from step 2 to step 6 in “Replacing the [palm rest](#)”.
- 3 Replace the [keyboard](#).
- 4 Replace the [wireless card](#).
- 5 Replace the [memory modules](#).
- 6 Follow the procedure from step 3 to step 5 in “Replacing the [hard drive](#)”.
- 7 Replace the [battery](#).
- 8 Replace the [base panel](#).

Removing the fan



WARNING: Before working inside your computer, read the safety information that shipped with your computer and follow the steps in [Before working inside your computer](#). After working inside your computer, follow the instructions in [After working inside your computer](#). For more safety best practices, see the Regulatory Compliance home page at www.dell.com/regulatory_compliance.

Prerequisites

- 1 Remove the [battery](#).
- 2 Remove the [base panel](#).
- 3 Follow the procedure from step 1 to step 3 in “Removing the [hard drive](#)”.
- 4 Remove the [memory modules](#).
- 5 Remove the [wireless card](#).
- 6 Remove the [keyboard](#).
- 7 Follow the procedure from step 1 to step 8 in “Removing the [palm rest](#)”.
- 8 Follow the procedure from step 1 to step 8 in “Removing the [system board](#)”.
- 9 Follow the procedure from step 1 to step 4 in “Removing the [heat sink](#)”.

Procedure

- 1 Remove the screws that secure the fan to the heat sink.

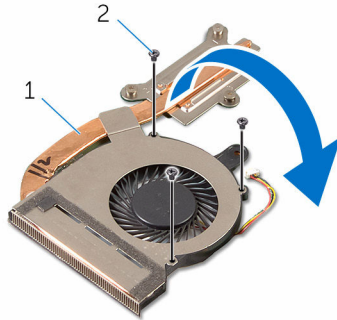

1 cooling assembly

2 screws (3)

- 2 Turn the cooling assembly over.
- 3 Peel off the tape that secures the fan to the heat sink.
- 4 Lift the fan off the heat sink.

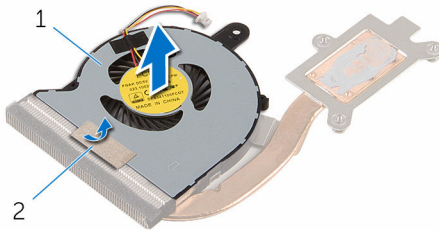

1 fan

2 tape

Replacing the fan



WARNING: Before working inside your computer, read the safety information that shipped with your computer and follow the steps in [Before working inside your computer](#). After working inside your computer, follow the instructions in [After working inside your computer](#). For more safety best practices, see the Regulatory Compliance home page at www.dell.com/regulatory_compliance.

Procedure

- 1 Place the fan on the heat sink.
- 2 Adhere the tape that secures the fan to the heat sink.
- 3 Turn the cooling assembly over.
- 4 Replace the screws that secure the fan to the heat sink.

Post-requisites

- 1 Follow the procedure from step 2 to step 4 in "Replacing the [heat sink](#)".
- 2 Follow the procedure from step 3 to step 10 in "Replacing the [system board](#)".
- 3 Follow the procedure from step 2 to step 6 in "Replacing the [palm rest](#)".
- 4 Replace the [keyboard](#).
- 5 Replace the [wireless card](#).
- 6 Replace the [memory modules](#).
- 7 Follow the procedure from step 3 to step 5 in "Replacing the [hard drive](#)".
- 8 Replace the [battery](#).
- 9 Replace the [base panel](#).

Removing the display assembly



WARNING: Before working inside your computer, read the safety information that shipped with your computer and follow the steps in [Before working inside your computer](#). After working inside your computer, follow the instructions in [After working inside your computer](#). For more safety best practices, see the Regulatory Compliance home page at www.dell.com/regulatory_compliance.

Prerequisites

- 1 Remove the [battery](#).
- 2 Remove the [base panel](#).
- 3 Follow the procedure from step 1 to step 3 in “Removing the [hard drive](#)”.
- 4 Remove the [memory modules](#).
- 5 Remove the [wireless card](#).
- 6 Remove the [keyboard](#).
- 7 Follow the procedure from step 1 to step 8 in “Removing the [palm rest](#)”.
- 8 Follow the procedure from step 1 to step 8 in “Removing the [system board](#)”.

Procedure

- 1 Turn the computer over and open the display as far as possible.
- 2 Note the antenna cable routing and remove the antenna cables from its routing guides on the computer base.

- 3** Note the display cable routing and remove the cable from its routing guides on the computer base.

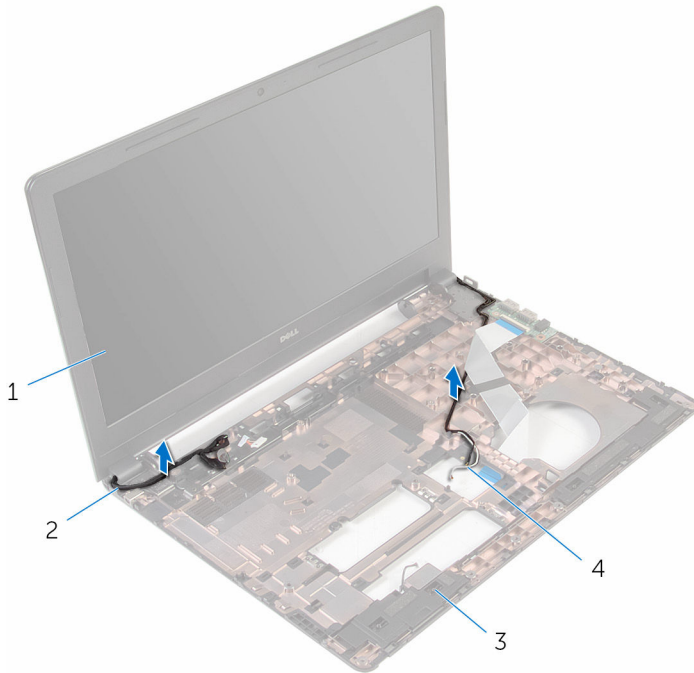

1 display assembly

2 display cable

3 computer base

4 antenna cables (2)

- 4** Remove the screws that secure the display hinges to the computer base.

5 Carefully lift the display assembly off the computer base.

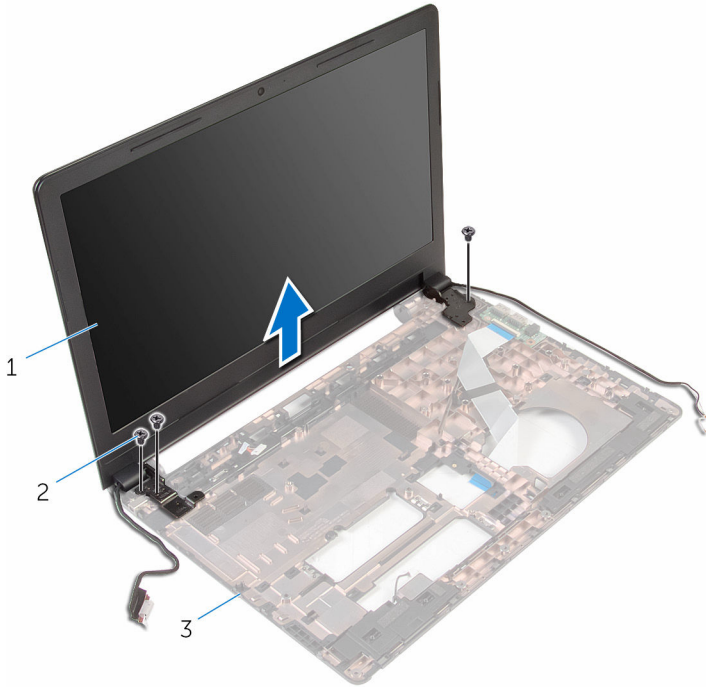

1 display assembly

2 screws (3)

3 computer base

Replacing the display assembly



WARNING: Before working inside your computer, read the safety information that shipped with your computer and follow the steps in [Before working inside your computer](#). After working inside your computer, follow the instructions in [After working inside your computer](#). For more safety best practices, see the Regulatory Compliance home page at www.dell.com/regulatory_compliance.

Procedure

- 1 Align the screw holes on the display hinges with the screw holes on the computer base.
- 2 Replace the screws that secure the display hinges to the computer base.
- 3 Route the display cable through its routing guides on the computer base.
- 4 Route the antenna cables through its routing guides and slide the antenna cables through the slot on the computer base.
- 5 Close the display and turn the computer over.

Post-requisites

- 1 Follow the procedure from step 3 to step 10 in "Replacing the [system board](#)".
- 2 Follow the procedure from step 2 to step 6 in "Replacing the [palm rest](#)".
- 3 Replace the [keyboard](#).
- 4 Replace the [wireless card](#).
- 5 Replace the [memory modules](#).
- 6 Follow the procedure from step 3 to step 5 in "Replacing the [hard drive](#)".
- 7 Replace the [base panel](#).
- 8 Replace the [battery](#).

Removing the power-adapter port



WARNING: Before working inside your computer, read the safety information that shipped with your computer and follow the steps in [Before working inside your computer](#). After working inside your computer, follow the instructions in [After working inside your computer](#). For more safety best practices, see the Regulatory Compliance home page at www.dell.com/regulatory_compliance.

Prerequisites

- 1 Remove the [battery](#).
- 2 Remove the [base panel](#).
- 3 Follow the procedure from step 1 to step 3 in “Removing the [hard drive](#)”.
- 4 Remove the [memory modules](#).
- 5 Remove the [wireless card](#).
- 6 Remove the [keyboard](#).
- 7 Follow the procedure from step 1 to step 8 in “Removing the [palm rest](#)”.
- 8 Follow the procedure from step 1 to step 8 in “Removing the [system board](#)”.
- 9 Remove the [display assembly](#).

Procedure

- 1 Note the power-adapter port cable routing and remove the cable from its routing guides on the computer base.
- 2 Remove the screw that secures the power-adapter port to the computer base.

- 3 Lift the power-adapter port, along with the power-adapter port cable, off the computer base.

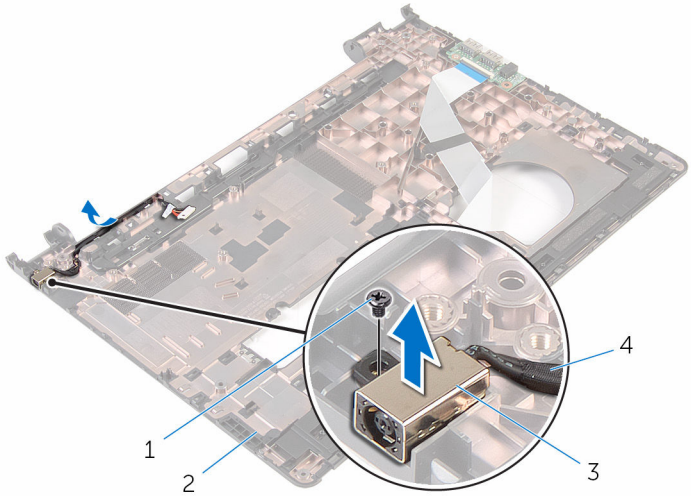

- | | | | |
|---|--------------------|---|--------------------------|
| 1 | screw | 2 | computer base |
| 3 | power-adapter port | 4 | power-adapter port cable |

Replacing the power-adapter port

 **WARNING:** Before working inside your computer, read the safety information that shipped with your computer and follow the steps in [Before working inside your computer](#). After working inside your computer, follow the instructions in [After working inside your computer](#). For more safety best practices, see the Regulatory Compliance home page at www.dell.com/regulatory_compliance.

Procedure

- 1 Slide the power-adapter port into the slot on the computer base.
- 2 Replace the screw that secures the power-adapter port to the computer base.
- 3 Route the power-adapter port cable along its routing guides on the computer base.

Post-requisites

- 1 Replace the [display assembly](#).
- 2 Follow the procedure from step 3 to step 10 in “Replacing the [system board](#)”.
- 3 Follow the procedure from step 2 to step 6 in “Replacing the [palm rest](#)”.
- 4 Replace the [keyboard](#).
- 5 Replace the [wireless card](#).
- 6 Replace the [memory modules](#).
- 7 Follow the procedure from step 3 to step 5 in “Replacing the [hard drive](#)”.
- 8 Replace the [base panel](#).
- 9 Replace the [battery](#).

Removing the display bezel



WARNING: Before working inside your computer, read the safety information that shipped with your computer and follow the steps in [Before working inside your computer](#). After working inside your computer, follow the instructions in [After working inside your computer](#). For more safety best practices, see the Regulatory Compliance home page at www.dell.com/regulatory_compliance.

Prerequisites



NOTE: These instructions are applicable only for laptops with a non-touch screen display.

- 1 Remove the [battery](#).
- 2 Remove the [base panel](#).
- 3 Follow the procedure from step 1 to step 3 in “Removing the [hard drive](#)”.
- 4 Remove the [memory modules](#).
- 5 Remove the [wireless card](#).
- 6 Remove the [keyboard](#).
- 7 Follow the procedure from step 1 to step 8 in “Removing the [palm rest](#)”.
- 8 Follow the procedure from step 1 to step 8 in “Removing the [system board](#)”.
- 9 Remove the [display assembly](#).

Procedure

- 1 Using your fingertips, gently pry up the inner edges of the display bezel.

2 Lift the display bezel off the display assembly.

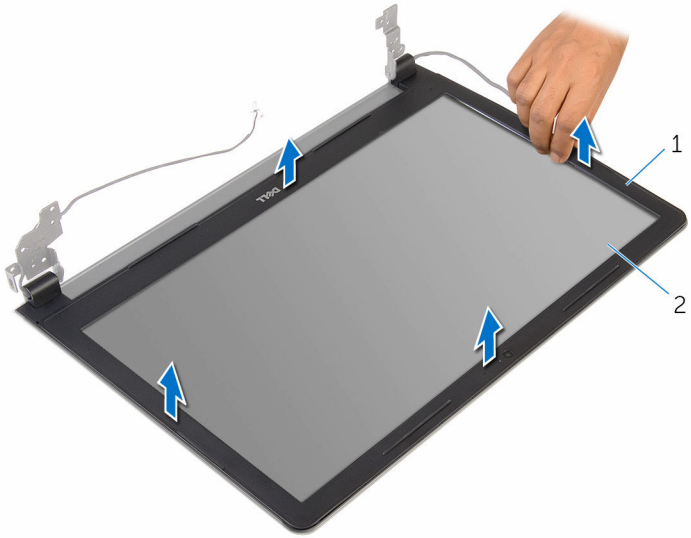

1 display bezel

2 display panel

Replacing the display bezel



WARNING: Before working inside your computer, read the safety information that shipped with your computer and follow the steps in [Before working inside your computer](#). After working inside your computer, follow the instructions in [After working inside your computer](#). For more safety best practices, see the Regulatory Compliance home page at www.dell.com/regulatory_compliance.

Procedure

Align the display bezel with the display back-cover and gently snap the display bezel into place.

Post-requisites

- 1 Replace the [display assembly](#).
- 2 Follow the procedure from step 3 to step 10 in "Replacing the [system board](#)".
- 3 Follow the procedure from step 2 to step 6 in "Replacing the [palm rest](#)".
- 4 Replace the [keyboard](#).
- 5 Replace the [wireless card](#).
- 6 Replace the [memory modules](#).
- 7 Follow the procedure from step 3 to step 5 in "Replacing the [hard drive](#)".
- 8 Replace the [base panel](#).
- 9 Replace the [battery](#).

Removing the display panel



WARNING: Before working inside your computer, read the safety information that shipped with your computer and follow the steps in [Before working inside your computer](#). After working inside your computer, follow the instructions in [After working inside your computer](#). For more safety best practices, see the Regulatory Compliance home page at www.dell.com/regulatory_compliance.

Prerequisites



NOTE: These instructions are applicable only for laptops with a non-touch screen display.

- 1 Remove the [battery](#).
- 2 Remove the [base panel](#).
- 3 Follow the procedure from step 1 to step 3 in “Removing the [hard drive](#)”.
- 4 Remove the [memory modules](#).
- 5 Remove the [wireless card](#).
- 6 Remove the [keyboard](#).
- 7 Follow the procedure from step 1 to step 8 in “Removing the [palm rest](#)”.
- 8 Follow the procedure from step 1 to step 8 in “Removing the [system board](#)”.
- 9 Remove the [display assembly](#).
- 10 Remove the [display bezel](#).

Procedure

- 1 Remove the screws that secure the display panel to the display back-cover.

- 2 Turn the display panel over.

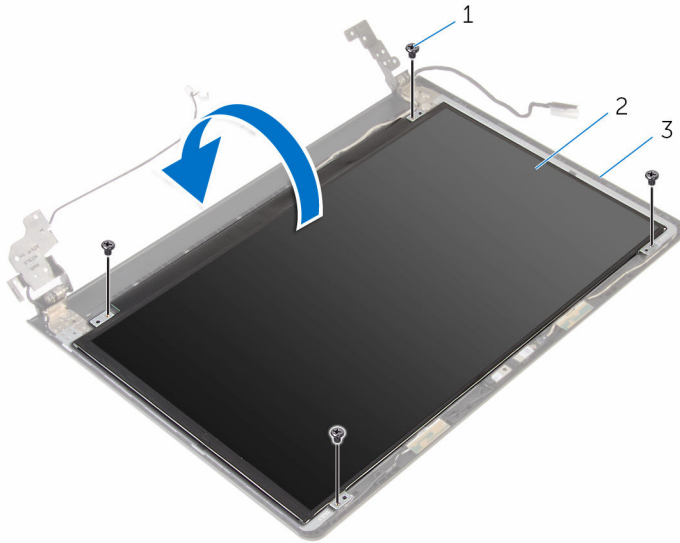

1 screws (4)

2 display panel

3 display back-cover

- 3 Peel the tape that secures the display cable to the display back-cover.
- 4 Lift the latch and disconnect the display cable from the display back-cover.

5 Lift the display panel off the display back-cover.

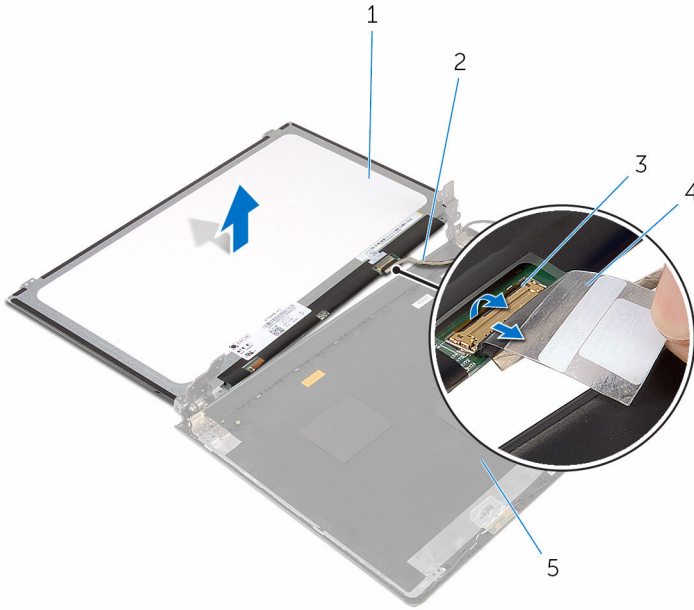

1 display panel

2 display cable

3 latch

4 tape

5 display back-cover

Replacing the display panel



WARNING: Before working inside your computer, read the safety information that shipped with your computer and follow the steps in [Before working inside your computer](#). After working inside your computer, follow the instructions in [After working inside your computer](#). For more safety best practices, see the Regulatory Compliance home page at www.dell.com/regulatory_compliance.

Procedure

- 1 Slide the display cable into the connector on the display back-cover and press down the latch to secure the cable.
- 2 Adhere the tape that secures the display cable to the display back-cover.
- 3 Turn the display panel over and place it on the display back-cover.
- 4 Align the screw holes on the display panel with the screw holes on the display back-cover.
- 5 Replace the screws that secure the display panel to the display back-cover.

Post-requisites

- 1 Replace the [display bezel](#).
- 2 Replace the [display assembly](#).
- 3 Follow the procedure from step 3 to step 10 in “Replacing the [system board](#)”.
- 4 Follow the procedure from step 2 to step 6 in “Replacing the [palm rest](#)”.
- 5 Replace the [keyboard](#).
- 6 Replace the [wireless card](#).
- 7 Replace the [memory modules](#).
- 8 Follow the procedure from step 3 to step 5 in “Replacing the [hard drive](#)”.
- 9 Replace the [base panel](#).
- 10 Replace the [battery](#).

Removing the camera

 **WARNING:** Before working inside your computer, read the safety information that shipped with your computer and follow the steps in [Before working inside your computer](#). After working inside your computer, follow the instructions in [After working inside your computer](#). For more safety best practices, see the Regulatory Compliance home page at www.dell.com/regulatory_compliance.

Prerequisites

 **NOTE:** These instructions are applicable only for laptops with a non-touch screen display.

- 1 Remove the [battery](#).
- 2 Remove the [base panel](#).
- 3 Follow the procedure from step 1 to step 3 in “Removing the [hard drive](#)”.
- 4 Remove the [memory modules](#).
- 5 Remove the [wireless card](#).
- 6 Remove the [keyboard](#).
- 7 Remove the [palm rest](#).
- 8 Remove the [system board](#).
- 9 Remove the [display assembly](#).
- 10 Remove the [display bezel](#).

Procedure

- 1 Using a plastic scribe, gently pry the camera off the display back-cover.

2 Disconnect the camera cable from the camera.

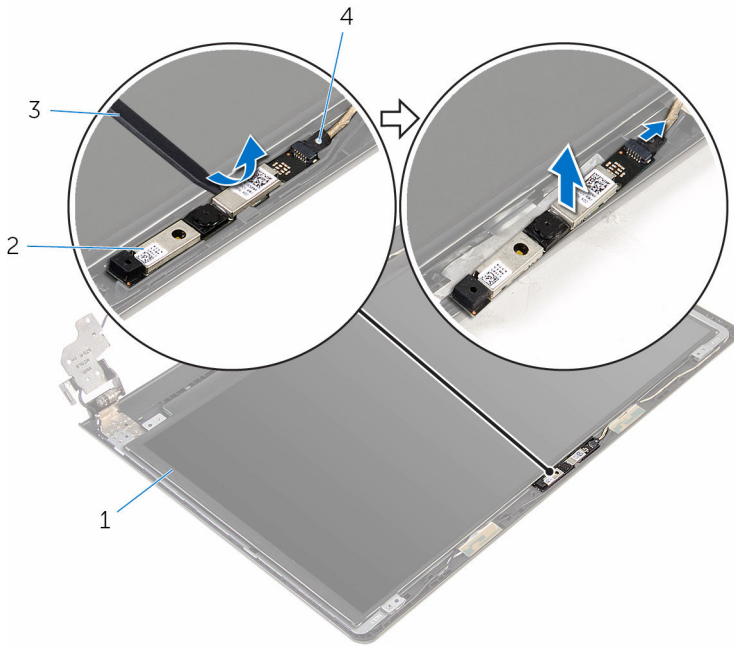

1 display back-cover

2 camera

3 plastic scribe

4 camera cable

Replacing the camera



WARNING: Before working inside your computer, read the safety information that shipped with your computer and follow the steps in [Before working inside your computer](#). After working inside your computer, follow the instructions in [After working inside your computer](#). For more safety best practices, see the Regulatory Compliance home page at www.dell.com/regulatory_compliance.

Procedure

- 1 Connect the camera cable to the camera.
- 2 Align the camera to the alignment posts on the display back-cover and snap the camera in place.

Post-requisites

- 1 Replace the [display bezel](#).
- 2 Replace the [display assembly](#).
- 3 Replace the [system board](#).
- 4 Replace the [palm rest](#).
- 5 Replace the [keyboard](#).
- 6 Replace the [wireless card](#).
- 7 Replace the [memory modules](#).
- 8 Follow the procedure from step 3 to step 5 in "Replacing the [hard drive](#)".
- 9 Replace the [base panel](#).
- 10 Replace the [battery](#).

Removing the display hinges



WARNING: Before working inside your computer, read the safety information that shipped with your computer and follow the steps in [Before working inside your computer](#). After working inside your computer, follow the instructions in [After working inside your computer](#). For more safety best practices, see the Regulatory Compliance home page at www.dell.com/regulatory_compliance.

Prerequisites



NOTE: These instructions are applicable only for laptops with a non-touch screen display.

- 1 Remove the [battery](#).
- 2 Remove the [base panel](#).
- 3 Follow the procedure from step 1 to step 3 in “Removing the [hard drive](#)”.
- 4 Remove the [memory modules](#).
- 5 Remove the [wireless card](#).
- 6 Remove the [keyboard](#).
- 7 Follow the procedure from step 1 to step 8 in “Removing the [palm rest](#)”.
- 8 Follow the procedure from step 1 to step 8 in “Removing the [system board](#)”.
- 9 Remove the [display assembly](#).
- 10 Remove the [display panel](#).
- 11 Remove the [display bezel](#).

Procedure

- 1 Remove the screws that secure the display hinges to the display back-cover.

2 Release the hinges from the latches and lift the display hinges off the display back-cover.

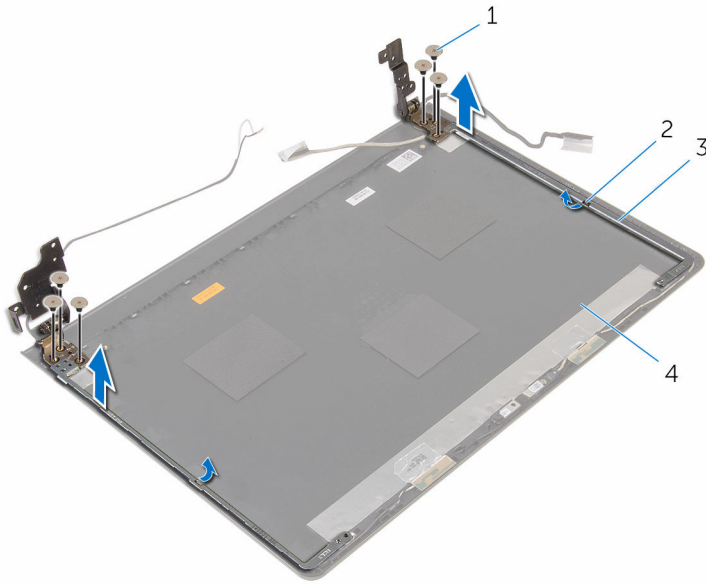

1 screws (6)

2 latches (2)

3 display hinges (2)

4 display back-cover

Replacing the display hinges



WARNING: Before working inside your computer, read the safety information that shipped with your computer and follow the steps in [Before working inside your computer](#). After working inside your computer, follow the instructions in [After working inside your computer](#). For more safety best practices, see the Regulatory Compliance home page at www.dell.com/regulatory_compliance.

Procedure

- 1 Slide the hinges under the latches on the display back-cover.
- 2 Align the screw holes on the display hinges with the screw holes on the display back-cover.
- 3 Replace the screws that secure the display hinges to the display back-cover.

Post-requisites

- 1 Replace the [display bezel](#).
- 2 Replace the [display panel](#).
- 3 Replace the [display assembly](#).
- 4 Follow the procedure from step 3 to step 10 in "Replacing the [system board](#)".
- 5 Follow the procedure from step 2 to step 6 in "Replacing the [palm rest](#)".
- 6 Replace the [keyboard](#).
- 7 Replace the [wireless card](#).
- 8 Replace the [memory modules](#).
- 9 Follow the procedure from step 3 to step 5 in "Replacing the [hard drive](#)".
- 10 Replace the [base panel](#).
- 11 Replace the [battery](#).

Flashing the BIOS

You may need to flash (update) the BIOS when an update is available or when you replace the system board. To flash the BIOS:

- 1 Turn on the computer.
- 2 Go to **www.dell.com/support**.
- 3 Click **Product Support**, enter the Service Tag of your computer and click **Submit**.
 **NOTE:** If you do not have the Service Tag, use the auto-detect feature or manually browse for your computer model.
- 4 Click **Drivers & downloads**.
- 5 Select the operating system installed on your computer.
- 6 Scroll down the page and expand **BIOS**.
- 7 Click **Download File** to download the latest version of the BIOS for your computer.
- 8 Save the file and, once the download is complete, navigate to the folder where you saved the BIOS update file.
- 9 Double-click the BIOS update file icon and follow the instructions on the screen.

Getting help and contacting Dell

Self-help resources

You can get information and help on Dell products and services using these self-help resources:

Information about Dell products and services

www.dell.com

Windows 8.1 and Windows 10

Dell Help & Support app



Windows 10

Get started app



Windows 8.1

Help + Tips app



Accessing help in Windows 8, Windows 8.1, and Windows 10

In Windows search, type **Help and Support**, and press **Enter**.

Accessing help in Windows 7

Click **Start** → **Help and Support**.

Online help for operating system

www.dell.com/support/windows
www.dell.com/support/linux

Troubleshooting information, user manuals, setup instructions, product specifications, technical help blogs, drivers, software updates, and so on

www.dell.com/support

Learn about your operating system, setting up and using your computer, data backup, diagnostics, and so on.

See *Me and My Dell* at www.dell.com/support/manuals.

Contacting Dell

To contact Dell for sales, technical support, or customer service issues, see www.dell.com/contactdell.



NOTE: Availability varies by country and product, and some services may not be available in your country.



NOTE: If you do not have an active internet connection, you can find contact information on your purchase invoice, packing slip, bill, or Dell product catalog.