

# Inspiron 15

## 3000 Series

# Service Manual

Computer Model: Inspiron 15–3555  
Regulatory Model: P47F  
Regulatory Type: P47F005



# Notes, cautions, and warnings

---



**NOTE:** A NOTE indicates important information that helps you make better use of your computer.



**CAUTION:** A CAUTION indicates either potential damage to hardware or loss of data and tells you how to avoid the problem.



**WARNING:** A WARNING indicates a potential for property damage, personal injury, or death.

---

**Copyright © 2016 Dell Inc. All rights reserved.** This product is protected by U.S. and international copyright and intellectual property laws. Dell™ and the Dell logo are trademarks of Dell Inc. in the United States and/or other jurisdictions. All other marks and names mentioned herein may be trademarks of their respective companies.

2016-01

Rev. A00

# Contents

<b>Before working inside your computer.....</b>	<b>9</b>
Before you begin .....	9
Safety instructions.....	9
Recommended tools.....	10
<b>After working inside your computer.....</b>	<b>11</b>
<b>Removing the battery.....</b>	<b>12</b>
Procedure.....	12
<b>Replacing the battery.....</b>	<b>13</b>
Procedure.....	13
<b>Removing the optical drive.....</b>	<b>14</b>
Prerequisites.....	14
Procedure.....	14
<b>Replacing the optical drive.....</b>	<b>17</b>
Procedure.....	17
Post-requisites.....	17
<b>Removing the keyboard.....</b>	<b>18</b>
Prerequisites.....	18
Procedure.....	18
<b>Replacing the keyboard.....</b>	<b>21</b>
Procedure.....	21
Post-requisites.....	21

<b>Removing the base cover.....</b>	<b>22</b>
Prerequisites.....	22
Procedure.....	22
<b>Replacing the base cover.....</b>	<b>27</b>
Procedure.....	27
Post-requisites.....	27
<b>Removing the hard drive.....</b>	<b>28</b>
Prerequisites.....	28
Procedure.....	28
<b>Replacing the hard drive.....</b>	<b>31</b>
Procedure.....	31
Post-requisites.....	31
<b>Removing the memory module.....</b>	<b>32</b>
Prerequisites.....	32
Procedure.....	32
<b>Replacing the memory module.....</b>	<b>34</b>
Procedure.....	34
Post-requisites.....	35
<b>Removing the wireless card.....</b>	<b>36</b>
Prerequisites.....	36
Procedure.....	36
<b>Replacing the wireless card.....</b>	<b>38</b>
Procedure.....	38
Post-requisites.....	40

<b>Removing the power-button board.....</b>	<b>41</b>
Prerequisites.....	41
Procedure.....	41
<b>Replacing the power-button board.....</b>	<b>44</b>
Procedure.....	44
Post-requisites.....	44
<b>Removing the speakers.....</b>	<b>45</b>
Prerequisites.....	45
Procedure.....	45
<b>Replacing the speakers.....</b>	<b>47</b>
Procedure.....	47
Post-requisites.....	47
<b>Removing the I/O board.....</b>	<b>48</b>
Prerequisites.....	48
Procedure.....	48
<b>Replacing the I/O board.....</b>	<b>50</b>
Procedure.....	50
Post-requisites.....	50
<b>Removing the coin-cell battery.....</b>	<b>51</b>
Prerequisites.....	51
Procedure.....	51
<b>Replacing the coin-cell battery.....</b>	<b>53</b>
Procedure.....	53
Post-requisites.....	53

<b>Removing the heat-sink assembly.....</b>	<b>54</b>
Prerequisites.....	54
Procedure.....	54
<b>Replacing the heat-sink assembly.....</b>	<b>56</b>
Procedure.....	56
Post-requisites.....	56
<b>Removing the fan.....</b>	<b>57</b>
Prerequisites.....	57
Procedure.....	57
<b>Replacing the fan.....</b>	<b>59</b>
Procedure.....	59
Post-requisites.....	59
<b>Removing the system board.....</b>	<b>60</b>
Prerequisites.....	60
Procedure.....	60
<b>Replacing the system board.....</b>	<b>65</b>
Procedure.....	65
Post-requisites.....	66
<b>Removing the touch pad.....</b>	<b>67</b>
Prerequisites.....	67
Procedure.....	68
<b>Replacing the touch pad.....</b>	<b>72</b>
Procedure.....	72
Post-requisites.....	72

<b>Removing the power-adapter port.....</b>	<b>73</b>
Prerequisites.....	73
Procedure.....	73
<b>Replacing the power-adapter port.....</b>	<b>76</b>
Procedure.....	76
Post-requisites.....	76
<b>Removing the display assembly.....</b>	<b>77</b>
Prerequisites.....	77
Procedure.....	77
<b>Replacing the display assembly.....</b>	<b>82</b>
Procedure.....	82
Post-requisites.....	82
<b>Removing the display bezel.....</b>	<b>83</b>
Prerequisites.....	83
Procedure.....	83
<b>Replacing the display bezel.....</b>	<b>85</b>
Procedure.....	85
Post-requisites.....	85
<b>Removing the display panel.....</b>	<b>86</b>
Prerequisites.....	86
Procedure.....	86
<b>Replacing the display panel.....</b>	<b>89</b>
Procedure.....	89
Post-requisites.....	89

<b>Removing the camera.....</b>	<b>90</b>
Prerequisites.....	90
Procedure.....	90
<b>Replacing the camera.....</b>	<b>92</b>
Procedure.....	92
Post-requisites.....	92
<b>Removing the display hinges.....</b>	<b>93</b>
Prerequisites.....	93
Procedure.....	93
<b>Replacing the display hinges.....</b>	<b>95</b>
Procedure.....	95
Post-requisites.....	95
<b>Removing the palm rest.....</b>	<b>96</b>
Prerequisites.....	96
Procedure.....	96
<b>Replacing the palm rest.....</b>	<b>98</b>
Procedure.....	98
Post-requisites.....	98
<b>Flashing the BIOS.....</b>	<b>99</b>
<b>Getting help and contacting Dell.....</b>	<b>100</b>
Self-help resources.....	100
Contacting Dell.....	101





# Before working inside your computer

---

 **NOTE:** The images in this document may differ from your computer depending on the configuration you ordered.

## Before you begin

- 1 Save and close all open files and exit all open applications.
  - 2 Shut down your computer.
    - Windows 10: Click or tap **Start** →  **Power** → **Shut down**.
    - Windows 8.1: On the **Start** screen, click or tap the power icon  → **Shut down**.
    - Windows 7: Click or tap **Start** → **Shut down**.
-  **NOTE:** If you are using a different operating system, see the documentation of your operating system for shut-down instructions.
- 3 Disconnect your computer and all attached devices from their electrical outlets.
  - 4 Disconnect all cables such as telephone cables, network cables and so on, from your computer.
  - 5 Disconnect all attached devices and peripherals, such as keyboard, mouse, monitor, and so on, from your computer.
  - 6 Remove any media card and optical disc from your computer, if applicable.

## Safety instructions

Use the following safety guidelines to protect your computer from potential damage and ensure your personal safety.

 **WARNING:** Before working inside your computer, read the safety information that shipped with your computer. For more safety best practices, see the Regulatory Compliance home page at [www.dell.com/regulatory\\_compliance](http://www.dell.com/regulatory_compliance).

 **WARNING:** Disconnect all power sources before opening the computer cover or panels. After you finish working inside the computer, replace all covers, panels, and screws before connecting to the power source.

 **CAUTION:** To avoid damaging the computer, ensure that the work surface is flat and clean.

 **CAUTION:** To avoid damaging the components and cards, handle them by their edges and avoid touching pins and contacts.

 **CAUTION:** You should only perform troubleshooting and repairs as authorized or directed by the Dell technical assistance team. Damage due to servicing that is not authorized by Dell is not covered by your warranty. See the safety instructions that shipped with the product or at [www.dell.com/regulatory\\_compliance](http://www.dell.com/regulatory_compliance).

 **CAUTION:** Before touching anything inside your computer, ground yourself by touching an unpainted metal surface, such as the metal at the back of the computer. While you work, periodically touch an unpainted metal surface to dissipate static electricity, which could harm internal components.

 **CAUTION:** When you disconnect a cable, pull on its connector or on its pull tab, not on the cable itself. Some cables have connectors with locking tabs or thumb-screws that you must disengage before disconnecting the cable. When disconnecting cables, keep them evenly aligned to avoid bending any connector pins. When connecting cables, ensure that the ports and connectors are correctly oriented and aligned.

 **CAUTION:** Press and eject any installed card from the media-card reader.

## Recommended tools

The procedures in this document may require the following tools:

- Phillips screwdriver
- Plastic scribe

# After working inside your computer

---



**CAUTION: Leaving stray or loose screws inside your computer may severely damage your computer.**

- 1 Replace all screws and ensure that no stray screws remain inside your computer.
- 2 Connect any external devices, peripherals, and cables you removed before working on your computer.
- 3 Replace any media cards, discs, and any other parts that you removed before working on your computer.
- 4 Connect your computer and all attached devices to their electrical outlets.
- 5 Turn on your computer.

# Removing the battery

---

 **WARNING:** Before working inside your computer, read the safety information that shipped with your computer and follow the steps in [Before working inside your computer](#). After working inside your computer, follow the instructions in [After working inside your computer](#). For more safety best practices, see the Regulatory Compliance home page at [www.dell.com/regulatory\\_compliance](http://www.dell.com/regulatory_compliance).

## Procedure

- 1 Close the display and turn the computer over.
- 2 Slide the battery-release latch to the unlocked position.
- 3 Lift the battery at an angle and remove the battery from the battery bay.

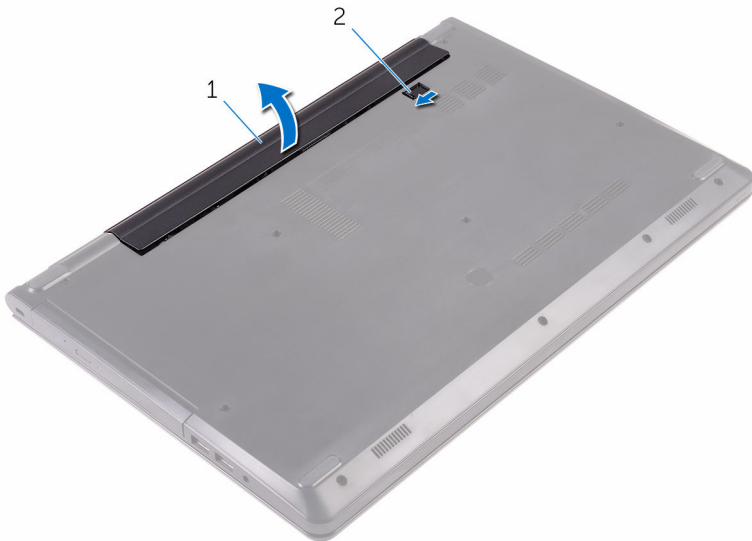

1 battery

2 battery-release latch

- 4 Turn the computer over, open the display, and press the power button for five seconds to ground the system board.

# Replacing the battery

---



**WARNING:** Before working inside your computer, read the safety information that shipped with your computer and follow the steps in [Before working inside your computer](#). After working inside your computer, follow the instructions in [After working inside your computer](#). For more safety best practices, see the Regulatory Compliance home page at [www.dell.com/regulatory\\_compliance](http://www.dell.com/regulatory_compliance).

## Procedure

- 1 Close the display and turn the computer over.
- 2 Place the battery in the battery bay and snap the battery into place.



**NOTE:** The battery-release latch returns to the locked position if the battery is installed properly.

# Removing the optical drive

---



**WARNING:** Before working inside your computer, read the safety information that shipped with your computer and follow the steps in [Before working inside your computer](#). After working inside your computer, follow the instructions in [After working inside your computer](#). For more safety best practices, see the Regulatory Compliance home page at [www.dell.com/regulatory\\_compliance](http://www.dell.com/regulatory_compliance).

## Prerequisites

Remove the [battery](#).

## Procedure

- 1 Remove the screw that secures the optical-drive assembly to the base cover.
- 2 Using a plastic scribe, push the optical-drive assembly out of the optical-drive bay.

- 3** Pull the optical-drive assembly out of the optical-drive bay.

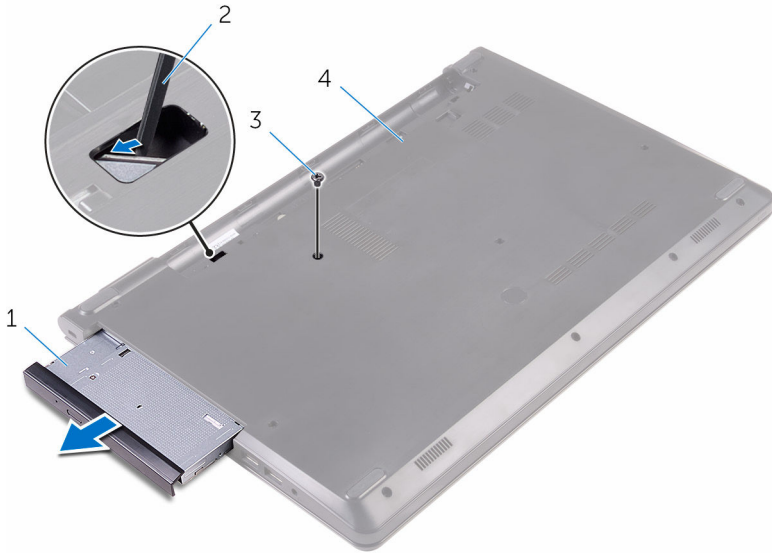

1 optical-drive assembly

2 plastic scribe

3 screw

4 base cover

- 4** Carefully pry the optical-drive bezel off the optical drive.

- 5 Remove the screw that secures the optical-drive bracket to the optical drive.

 **NOTE:** Note the orientation of the optical-drive bracket so that you can replace it correctly.

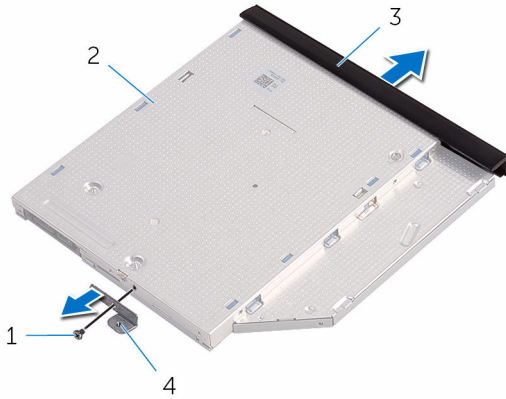

1 screw

3 optical-drive bezel

2 optical drive

4 optical-drive bracket



# Replacing the optical drive

---



**WARNING:** Before working inside your computer, read the safety information that shipped with your computer and follow the steps in [Before working inside your computer](#). After working inside your computer, follow the instructions in [After working inside your computer](#). For more safety best practices, see the Regulatory Compliance home page at [www.dell.com/regulatory\\_compliance](http://www.dell.com/regulatory_compliance).

## Procedure

- 1 Align the screw hole on the optical-drive bracket with the screw hole on the optical drive.
  -  **NOTE:** You must correctly align the optical-drive bracket to ensure that the optical drive can be properly secured to the computer. For correct orientation, see step 5 in "[Removing the optical drive](#)".
- 2 Replace the screw that secures the optical-drive bracket to the optical drive.
- 3 Align the tabs on the optical-drive bezel with the slots on the optical drive and snap the optical-drive bezel into place.
- 4 Slide the optical-drive assembly into the optical-drive bay.
- 5 Replace the screw that secures the optical-drive assembly to the base cover.

## Post-requisites

Replace the [battery](#).

# Removing the keyboard

---



**WARNING:** Before working inside your computer, read the safety information that shipped with your computer and follow the steps in [Before working inside your computer](#). After working inside your computer, follow the instructions in [After working inside your computer](#). For more safety best practices, see the Regulatory Compliance home page at [www.dell.com/regulatory\\_compliance](http://www.dell.com/regulatory_compliance).

## Prerequisites

Remove the [battery](#).

## Procedure

- 1 Turn the computer over and open the display.
- 2 Using a plastic scribe, gently release the tabs that secure the keyboard to the palm-rest assembly.
- 3 Slide the keyboard up to release it from the slots on the palm-rest assembly.

4 Carefully turn the keyboard over and place it on the palm-rest assembly.



- 1 tabs (5)
- 2 plastic scribe
- 3 keyboard
- 4 slots (6)
- 5 palm-rest assembly

- 5 Open the latch and disconnect the keyboard cable from the system board.



- |   |          |   |                    |
|---|----------|---|--------------------|
| 1 | latch    | 2 | keyboard cable     |
| 3 | keyboard | 4 | palm-rest assembly |

- 6 Lift the keyboard, along with the cable, off the palm-rest assembly.

# Replacing the keyboard

---



**WARNING:** Before working inside your computer, read the safety information that shipped with your computer and follow the steps in [Before working inside your computer](#). After working inside your computer, follow the instructions in [After working inside your computer](#). For more safety best practices, see the Regulatory Compliance home page at [www.dell.com/regulatory\\_compliance](http://www.dell.com/regulatory_compliance).

## Procedure

- 1 Slide the keyboard cable into the system-board connector and close the latch to secure the cable.
- 2 Carefully turn the keyboard over, slide the tabs on the keyboard into the slots on the palm-rest assembly, and snap the keyboard into place.
- 3 Close the display and turn the computer over.

## Post-requisites

Replace the [battery](#).

# Removing the base cover

---



**WARNING:** Before working inside your computer, read the safety information that shipped with your computer and follow the steps in [Before working inside your computer](#). After working inside your computer, follow the instructions in [After working inside your computer](#). For more safety best practices, see the Regulatory Compliance home page at [www.dell.com/regulatory\\_compliance](http://www.dell.com/regulatory_compliance).

## Prerequisites

- 1 Remove the [battery](#).
- 2 Follow the procedure from step 1 to step 3 in “Removing the [optical drive](#)”.
- 3 Remove the [keyboard](#).

## Procedure

- 1 Open the display and remove the screws that secure the palm-rest assembly to the base cover from its connector on the system board.

- 2 Open the latch and disconnect the optical-drive cable from its connector on the system board.



- |   |            |   |                     |
|---|------------|---|---------------------|
| 1 | screws (5) | 2 | palm-rest assembly  |
| 3 | base cover | 4 | optical-drive cable |
| 5 | latch      |   |                     |

- 3 Close the display and turn the computer over.

- 4 Remove the screws that secure the base cover to the palm-rest assembly.

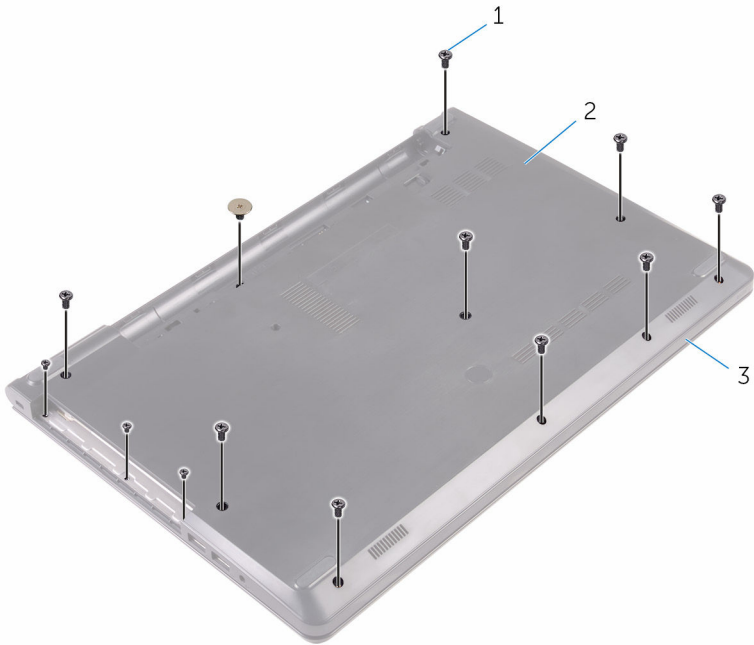

1 screws (13)

2 base cover

3 palm-rest assembly



- 5 Using your fingertips, gently pry the base cover off the palm-rest assembly.

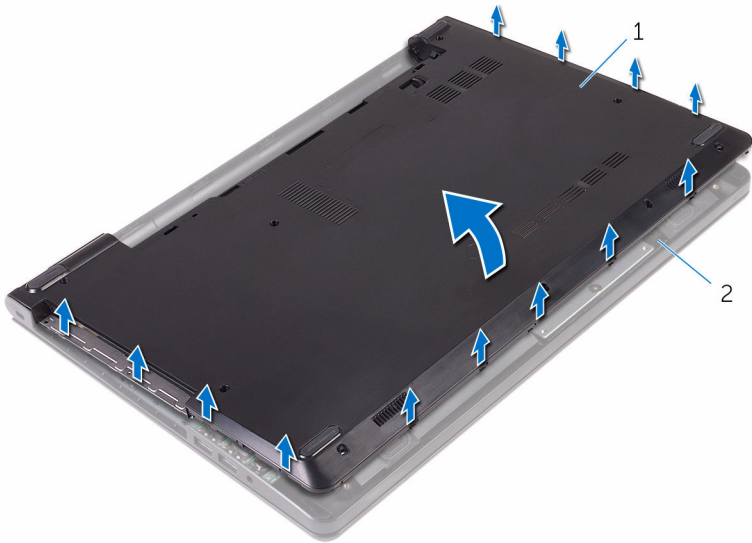

1 base cover

2 palm-rest assembly

- 6 Turn the base cover over.

7 Release the optical-drive interposer from the tabs on the base cover.

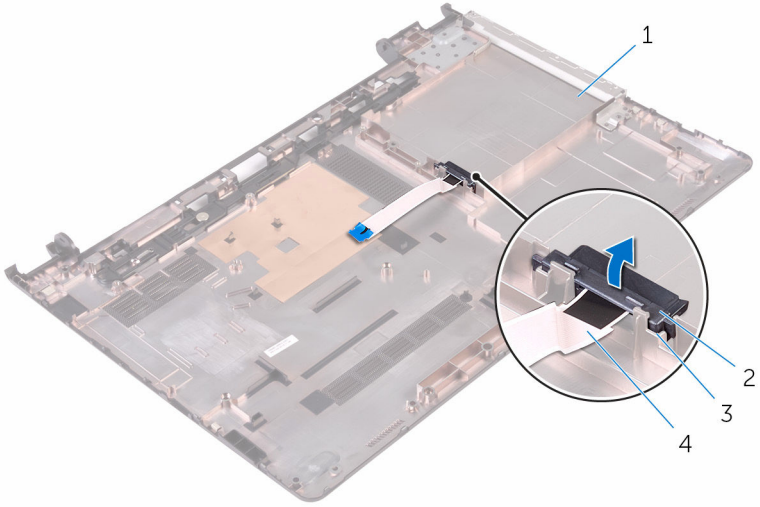

1 base cover

3 tabs (2)

2 optical-drive interposer

4 optical-drive cable

# Replacing the base cover

---



**WARNING:** Before working inside your computer, read the safety information that shipped with your computer and follow the steps in [Before working inside your computer](#). After working inside your computer, follow the instructions in [After working inside your computer](#). For more safety best practices, see the Regulatory Compliance home page at [www.dell.com/regulatory\\_compliance](http://www.dell.com/regulatory_compliance).

## Procedure

- 1 Align the optical-drive interposer with the tabs on the base cover and snap it into place.
- 2 Turn the base cover over.
- 3 Slide the tabs on the base cover into the slots on the palm-rest assembly and snap the base cover into place.
- 4 Replace the screws that secure the base cover to the palm-rest assembly.
- 5 Turn the computer over.
- 6 Open the display and replace the screws that secure the palm-rest assembly to the base cover.
- 7 Slide the optical-drive cable into its connector and close the latch to secure the cable.

## Post-requisites

- 1 Replace the [keyboard](#).
- 2 Follow the procedure from step 4 to step 5 in "Replacing the [optical drive](#)".
- 3 Replace the [battery](#).

# Removing the hard drive

---

 **WARNING:** Before working inside your computer, read the safety information that shipped with your computer and follow the steps in [Before working inside your computer](#). After working inside your computer, follow the instructions in [After working inside your computer](#). For more safety best practices, see the Regulatory Compliance home page at [www.dell.com/regulatory\\_compliance](http://www.dell.com/regulatory_compliance).

 **CAUTION:** Hard drives are fragile. Exercise care when handling the hard drive.

 **CAUTION:** To avoid data loss, do not remove the hard drive while the computer is in sleep or on state.

## Prerequisites

- 1 Remove the [battery](#).
- 2 Follow the procedure from step 1 to step 3 in “Removing the [optical drive](#)”.
- 3 Remove the [keyboard](#).
- 4 Follow the procedure from step 1 to step 5 in “Removing the [base cover](#)”.

## Procedure

- 1 Remove the screws that secure the hard-drive assembly to the palm-rest assembly.
- 2 Open the latch and disconnect the hard-drive cable from its connector on the system board.

**3** Lift the hard-drive assembly off the palm-rest assembly.

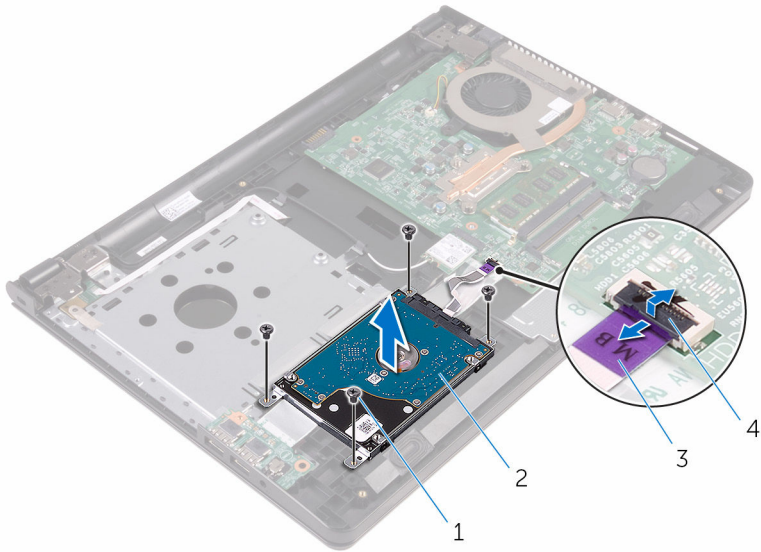

1 screws (4)

2 hard-drive assembly

3 hard-drive cable

4 latch

**4** Disconnect the interposer from the hard drive.

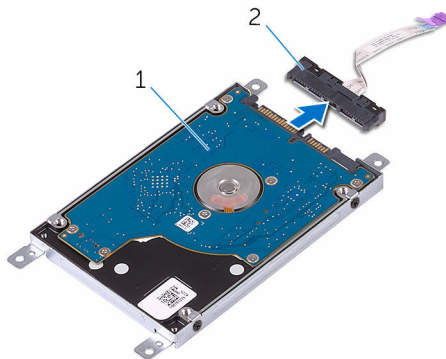

1 hard-drive assembly

2 interposer

- 5 Remove the screws that secure the hard-drive bracket to the hard drive and lift the bracket off the hard drive.

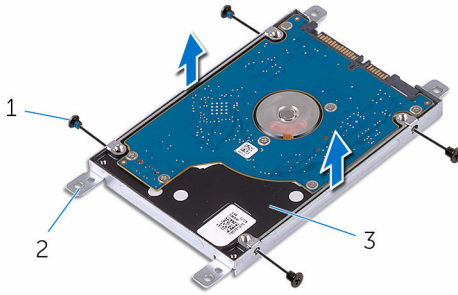

1 screws (4)

2 hard-drive bracket

3 hard drive

# Replacing the hard drive

---

 **WARNING:** Before working inside your computer, read the safety information that shipped with your computer and follow the steps in [Before working inside your computer](#). After working inside your computer, follow the instructions in [After working inside your computer](#). For more safety best practices, see the Regulatory Compliance home page at [www.dell.com/regulatory\\_compliance](http://www.dell.com/regulatory_compliance).

 **CAUTION:** Hard drives are fragile. Exercise care when handling the hard drive.

## Procedure

- 1 Align the screw holes on the hard-drive bracket with the screw holes on the hard drive.
- 2 Replace the screws that secure the hard-drive bracket to the hard drive.
- 3 Connect the interposer to the hard-drive assembly.
- 4 Align the screw holes on the hard-drive assembly with the screw holes on the palm-rest assembly.
- 5 Replace the screws that secure the hard-drive assembly to the palm-rest assembly.
- 6 Slide the hard-drive cable into the system-board connector and close the latch to secure the cable.

## Post-requisites

- 1 Follow the procedure from step 3 to step 7 in “Replacing the [base cover](#)”.
- 2 Replace the [keyboard](#).
- 3 Follow the procedure from step 4 to step 5 in “Replacing the [optical drive](#)”.
- 4 Replace the [battery](#).

# Removing the memory module

---



**WARNING:** Before working inside your computer, read the safety information that shipped with your computer and follow the steps in [Before working inside your computer](#). After working inside your computer, follow the instructions in [After working inside your computer](#). For more safety best practices, see the Regulatory Compliance home page at [www.dell.com/regulatory\\_compliance](http://www.dell.com/regulatory_compliance).

## Prerequisites

- 1 Remove the [battery](#).
- 2 Follow the procedure from step 1 to step 3 in “Removing the [optical drive](#)”.
- 3 Remove the [keyboard](#).
- 4 Follow the procedure from step 1 to step 5 in “Removing the [base cover](#)”.

## Procedure

- 1 Using your fingertips, spread apart the securing clips at each end of the memory-module slot until the memory module pops up.



2 Slide and remove the memory module from the memory-module slot.

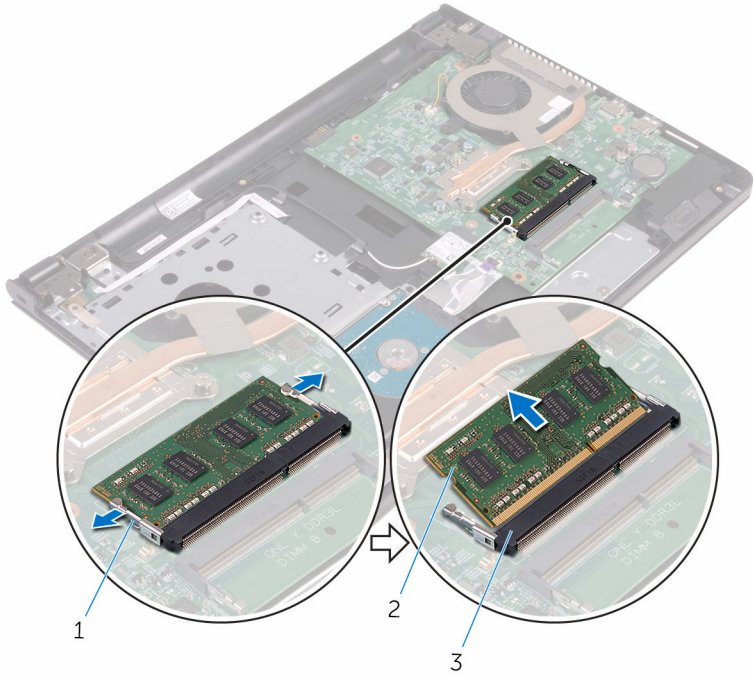

1 securing clips (2)

2 memory module

3 memory-module slot

# Replacing the memory module

---



**WARNING:** Before working inside your computer, read the safety information that shipped with your computer and follow the steps in [Before working inside your computer](#). After working inside your computer, follow the instructions in [After working inside your computer](#). For more safety best practices, see the Regulatory Compliance home page at [www.dell.com/regulatory\\_compliance](http://www.dell.com/regulatory_compliance).

## Procedure

- 1 Align the notch on the memory module with the tab on the memory-module slot.

- Slide the memory module firmly into the slot at an angle and press the memory module down until it clicks into place.

 **NOTE:** If you do not hear the click, remove the memory module and reinstall it.

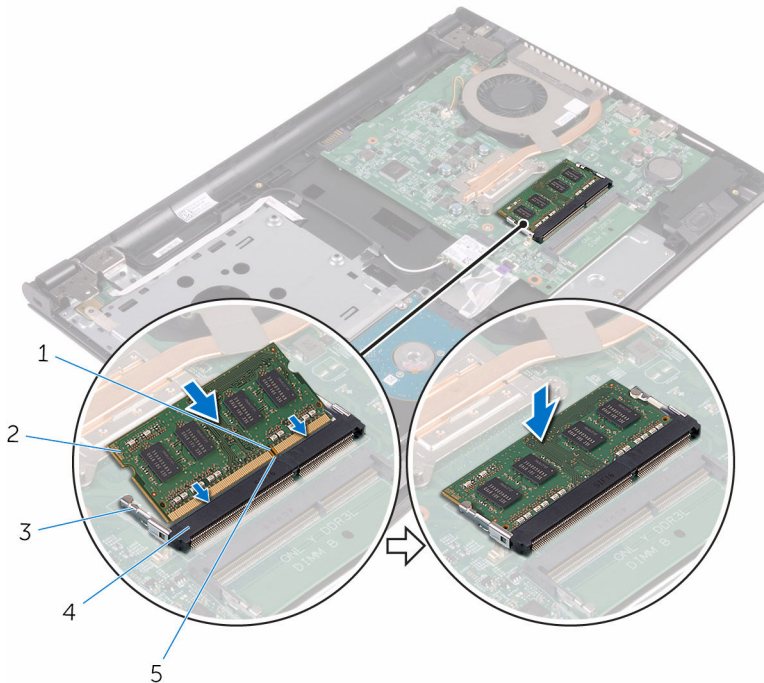

- |   |                    |   |                    |
|---|--------------------|---|--------------------|
| 1 | notch              | 2 | memory module      |
| 3 | securing clips (2) | 4 | memory-module slot |
| 5 | tab                |   |                    |

## Post-requisites

- Follow the procedure from step 3 to step 7 in “Replacing the [base cover](#)”.
- Replace the [keyboard](#).
- Follow the procedure from step 4 to step 5 in “Replacing the [optical drive](#)”.
- Replace the [battery](#).

# Removing the wireless card

---



**WARNING:** Before working inside your computer, read the safety information that shipped with your computer and follow the steps in [Before working inside your computer](#). After working inside your computer, follow the instructions in [After working inside your computer](#). For more safety best practices, see the Regulatory Compliance home page at [www.dell.com/regulatory\\_compliance](http://www.dell.com/regulatory_compliance).

## Prerequisites

- 1 Remove the [battery](#).
- 2 Follow the procedure from step 1 to step 3 in “Removing the [optical drive](#)”.
- 3 Remove the [keyboard](#).
- 4 Follow the procedure from step 1 to step 5 in “Removing the [base cover](#)”.

## Procedure

- 1 Disconnect the antenna cables from the wireless card.
- 2 Remove the screw that secures the wireless card to the system board.

**3** Slide the wireless card out of the wireless-card slot on the system board.

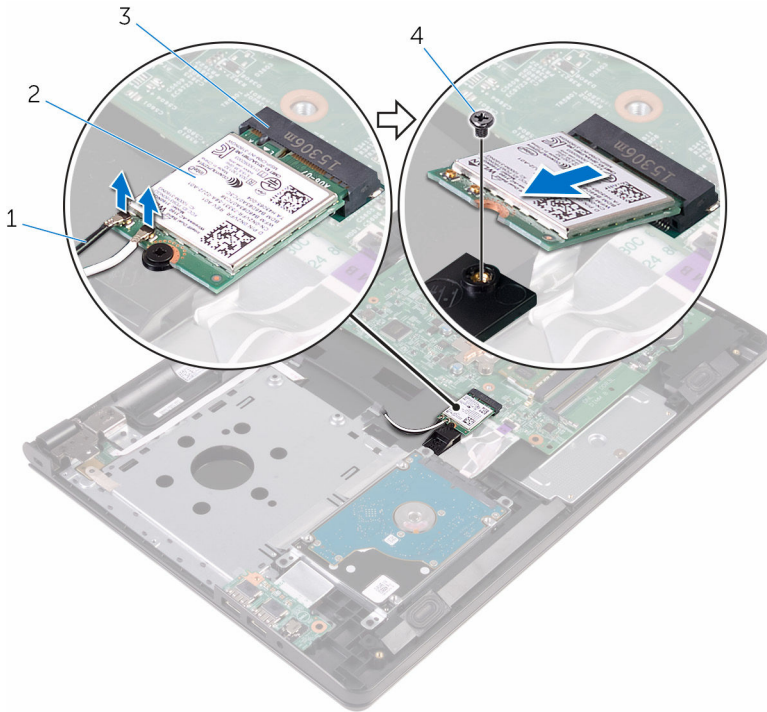

1 antenna cables (2)

2 wireless card

3 wireless-card slot

4 screw

# Replacing the wireless card

---

 **WARNING:** Before working inside your computer, read the safety information that shipped with your computer and follow the steps in [Before working inside your computer](#). After working inside your computer, follow the instructions in [After working inside your computer](#). For more safety best practices, see the Regulatory Compliance home page at [www.dell.com/regulatory\\_compliance](http://www.dell.com/regulatory_compliance).

## Procedure

 **CAUTION:** To avoid damage to the wireless card, do not place any cables under it.

- 1 Align the notch on the wireless card with the tab on the wireless-card slot and slide the card into the slot.
- 2 Replace the screw that secures the wireless card to the system board.

**3** Connect the antenna cables to the wireless card.

The following table provides the antenna-cable color scheme for the wireless card supported by your computer:

<b>Connectors on the wireless card</b>	<b>Antenna-cable color</b>
Main (white triangle)	White
Auxiliary (black triangle)	Black

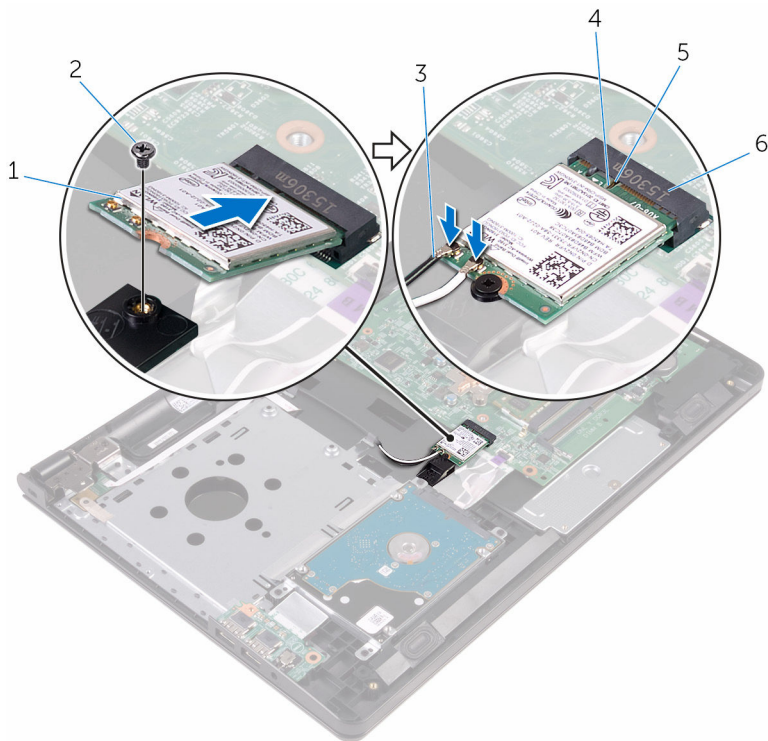

- |   |                    |   |                    |
|---|--------------------|---|--------------------|
| 1 | wireless card      | 2 | screw              |
| 3 | antenna cables (2) | 4 | notch              |
| 5 | tab                | 6 | wireless-card slot |

## Post-requisites

- 1 Follow the procedure from step 3 to step 7 in “Replacing the [base cover](#)”.
- 2 Replace the [keyboard](#).
- 3 Follow the procedure from step 4 to step 5 in “Replacing the [optical drive](#)”.
- 4 Replace the [battery](#).



# Removing the power-button board

---

 **WARNING:** Before working inside your computer, read the safety information that shipped with your computer and follow the steps in [Before working inside your computer](#). After working inside your computer, follow the instructions in [After working inside your computer](#). For more safety best practices, see the Regulatory Compliance home page at [www.dell.com/regulatory\\_compliance](http://www.dell.com/regulatory_compliance).

## Prerequisites

- 1 Remove the [battery](#).
- 2 Follow the procedure from step 1 to step 3 in “Removing the [optical drive](#)”.
- 3 Remove the [keyboard](#).
- 4 Follow the procedure from step 1 to step 5 in “Removing the [base cover](#)”.

## Procedure

- 1 Turn the computer over and open the display as far as possible.

- 2 Open the latch and disconnect the power-button board cable from the system board.



1 latch

2 power-button board cable

3 palm-rest assembly

- 3 Close the display and turn the computer over.
- 4 Peel the tape that secures the power-button board cable to the palm-rest assembly.
- 5 Remove the screw that secures the power-button board to the palm-rest assembly.
- 6 Peel the power-button board cable from the palm-rest assembly.

- 7 Slide and lift the power-button board, along with its cable, off the palm-rest assembly.

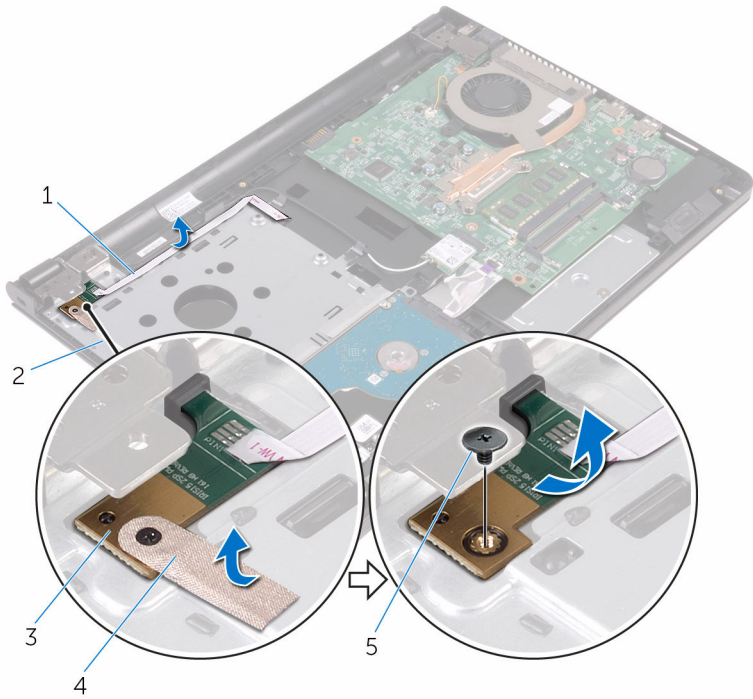

- |   |                          |   |                    |
|---|--------------------------|---|--------------------|
| 1 | power-button board cable | 2 | palm-rest assembly |
| 3 | power-button board       | 4 | tape               |
| 5 | screw                    |   |                    |

# Replacing the power-button board

---

 **WARNING:** Before working inside your computer, read the safety information that shipped with your computer and follow the steps in [Before working inside your computer](#). After working inside your computer, follow the instructions in [After working inside your computer](#). For more safety best practices, see the Regulatory Compliance home page at [www.dell.com/regulatory\\_compliance](http://www.dell.com/regulatory_compliance).

## Procedure

- 1 Slide the power-button board under the tab on the palm-rest assembly and align the screw hole on the power-button board with the screw hole on the palm-rest assembly.
- 2 Replace the screw that secures the power-button board to the palm-rest assembly.
- 3 Adhere the tape that secures the power-button board to the palm-rest assembly.
- 4 Adhere the power-button board cable to the palm-rest assembly.
- 5 Slide the power-button board cable through the slot on the palm-rest assembly.
- 6 Turn the computer over and open the display as far as possible.
- 7 Slide the power-button board cable into its connector on the system board and close the latch to secure the cable.

## Post-requisites

- 1 Follow the procedure from step 3 to step 7 in “Replacing the [base cover](#)”.
- 2 Replace the [keyboard](#).
- 3 Follow the procedure from step 4 to step 5 in “Replacing the [optical drive](#)”.
- 4 Replace the [battery](#).

# Removing the speakers

---



**WARNING:** Before working inside your computer, read the safety information that shipped with your computer and follow the steps in [Before working inside your computer](#). After working inside your computer, follow the instructions in [After working inside your computer](#). For more safety best practices, see the Regulatory Compliance home page at [www.dell.com/regulatory\\_compliance](http://www.dell.com/regulatory_compliance).

## Prerequisites

- 1 Remove the [battery](#).
- 2 Follow the procedure from step 1 to step 3 in “Removing the [optical drive](#)”.
- 3 Remove the [keyboard](#).
- 4 Follow the procedure from step 1 to step 5 in “Removing the [base cover](#)”.

## Procedure

- 1 Disconnect the speaker cable from the system board.
- 2 Note the speaker-cable routing and remove the cable from the routing guides on the palm-rest assembly.

- 3** Lift the speakers, along with the speaker cable, off the palm-rest assembly.

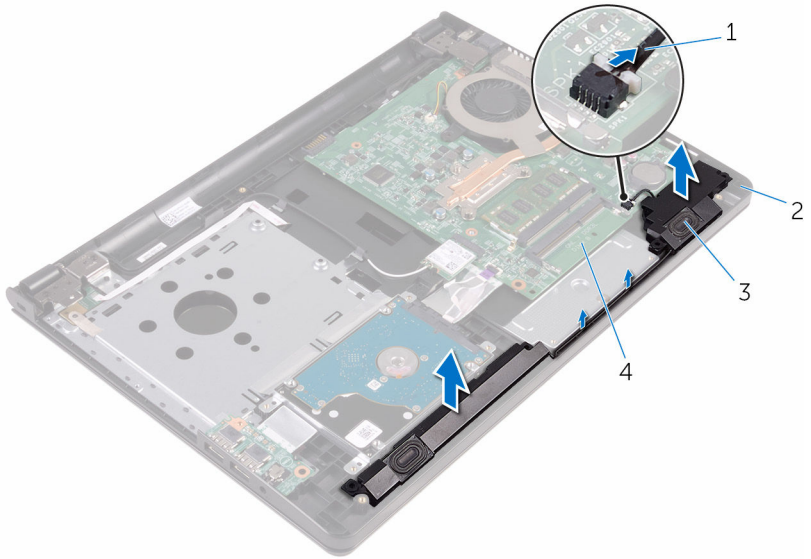

- |   |               |   |                    |
|---|---------------|---|--------------------|
| 1 | speaker cable | 2 | palm-rest assembly |
| 3 | speakers (2)  | 4 | system board       |

# Replacing the speakers

---



**WARNING:** Before working inside your computer, read the safety information that shipped with your computer and follow the steps in [Before working inside your computer](#). After working inside your computer, follow the instructions in [After working inside your computer](#). For more safety best practices, see the Regulatory Compliance home page at [www.dell.com/regulatory\\_compliance](http://www.dell.com/regulatory_compliance).

## Procedure

- 1 Align the speakers using the alignment posts on the palm-rest assembly and snap the speakers into place.
- 2 Route the speaker cable through the routing guides on the palm-rest assembly.
- 3 Connect the speaker cable to the system board.

## Post-requisites

- 1 Follow the procedure from step 3 to step 7 in “Replacing the [base cover](#)”.
- 2 Replace the [keyboard](#).
- 3 Follow the procedure from step 4 to step 5 in “Replacing the [optical drive](#)”.
- 4 Replace the [battery](#).

# Removing the I/O board

---



**WARNING:** Before working inside your computer, read the safety information that shipped with your computer and follow the steps in [Before working inside your computer](#). After working inside your computer, follow the instructions in [After working inside your computer](#). For more safety best practices, see the Regulatory Compliance home page at [www.dell.com/regulatory\\_compliance](http://www.dell.com/regulatory_compliance).

## Prerequisites

- 1 Remove the [battery](#).
- 2 Follow the procedure from step 1 to step 3 in “Removing the [optical drive](#)”.
- 3 Remove the [keyboard](#).
- 4 Follow the procedure from step 1 to step 5 in “Removing the [base cover](#)”.

## Procedure

- 1 Remove the screw that secures the I/O board to the palm-rest assembly.
- 2 Turn the I/O board over and peel the tape that secures the I/O-board cable to the I/O board.
- 3 Open the latch and disconnect the I/O-board cable from the I/O board.



4 Lift the I/O board off the palm-rest assembly.

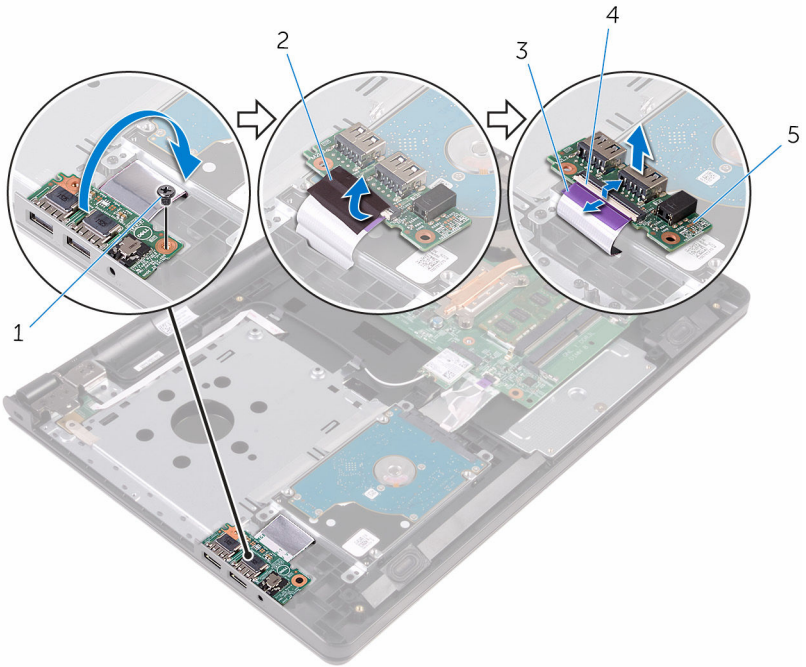

1 screw

2 tape

3 I/O-board cable

4 latch

5 I/O board

# Replacing the I/O board

---



**WARNING:** Before working inside your computer, read the safety information that shipped with your computer and follow the steps in [Before working inside your computer](#). After working inside your computer, follow the instructions in [After working inside your computer](#). For more safety best practices, see the Regulatory Compliance home page at [www.dell.com/regulatory\\_compliance](http://www.dell.com/regulatory_compliance).

## Procedure

- 1 Slide the I/O-board cable into its connector on the I/O board and close the latch to secure the cable.
- 2 Adhere the tape that secures the I/O-board cable to the I/O board.
- 3 Turn the I/O board over and align the screw hole on the I/O board with the screw hole on the palm-rest assembly.
- 4 Replace the screw that secures the I/O board to the palm-rest assembly.

## Post-requisites

- 1 Follow the procedure from step 3 to step 7 in “Replacing the [base cover](#)”.
- 2 Replace the [keyboard](#).
- 3 Follow the procedure from step 4 to step 5 in “Replacing the [optical drive](#)”.
- 4 Replace the [battery](#).

# Removing the coin-cell battery

---

 **WARNING:** Before working inside your computer, read the safety information that shipped with your computer and follow the steps in [Before working inside your computer](#). After working inside your computer, follow the instructions in [After working inside your computer](#). For more safety best practices, see the Regulatory Compliance home page at [www.dell.com/regulatory\\_compliance](http://www.dell.com/regulatory_compliance).

 **CAUTION:** Removing the coin-cell battery resets the BIOS setup program's settings to default. It is recommended that you note the BIOS setup program's settings before removing the coin-cell battery.

## Prerequisites

- 1 Remove the [battery](#).
- 2 Follow the procedure from step 1 to step 3 in "Removing the [optical drive](#)".
- 3 Remove the [keyboard](#).
- 4 Follow the procedure from step 1 to step 5 in "Removing the [base cover](#)".

## Procedure

Using a plastic scribe, gently pry the coin-cell battery out of the battery socket on the system board.

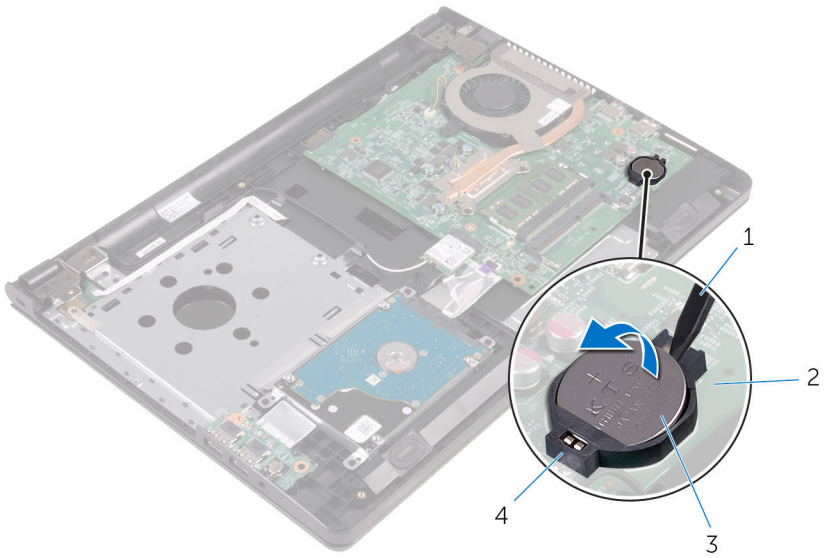

- 1 plastic scribe
- 3 coin-cell battery

- 2 system board
- 4 battery socket

# Replacing the coin-cell battery

---



**WARNING:** Before working inside your computer, read the safety information that shipped with your computer and follow the steps in [Before working inside your computer](#). After working inside your computer, follow the instructions in [After working inside your computer](#). For more safety best practices, see the Regulatory Compliance home page at [www.dell.com/regulatory\\_compliance](http://www.dell.com/regulatory_compliance).

## Procedure



With the positive-side facing up, snap the coin-cell battery into the battery socket on the system board.

## Post-requisites

- 1 Follow the procedure from step 3 to step 7 in “Replacing the [base cover](#)”.
- 2 Replace the [keyboard](#).
- 3 Follow the procedure from step 4 to step 5 in “Replacing the [optical drive](#)”.
- 4 Replace the [battery](#).

# Removing the heat-sink assembly

---

-  **WARNING:** Before working inside your computer, read the safety information that shipped with your computer and follow the steps in [Before working inside your computer](#). After working inside your computer, follow the instructions in [After working inside your computer](#). For more safety best practices, see the Regulatory Compliance home page at [www.dell.com/regulatory\\_compliance](http://www.dell.com/regulatory_compliance).
-  **WARNING:** The heat sink may become hot during normal operation. Allow sufficient time for the heat sink to cool before you touch it.
-  **CAUTION:** For maximum cooling of the processor, do not touch the heat transfer areas on the heat sink. The oils in your skin can reduce the heat transfer capability of the thermal grease.

## Prerequisites

- 1 Remove the [battery](#).
- 2 Follow the procedure from step 1 to step 3 in “Removing the [optical drive](#)”.
- 3 Remove the [keyboard](#).
- 4 Follow the procedure from step 1 to step 5 in “Removing the [base cover](#)”.

## Procedure

- 1 In sequential order, as indicated on the heat-sink assembly, loosen the captive screws that secure the heat-sink assembly to the system board.

**2** Disconnect the fan cable from the system board.

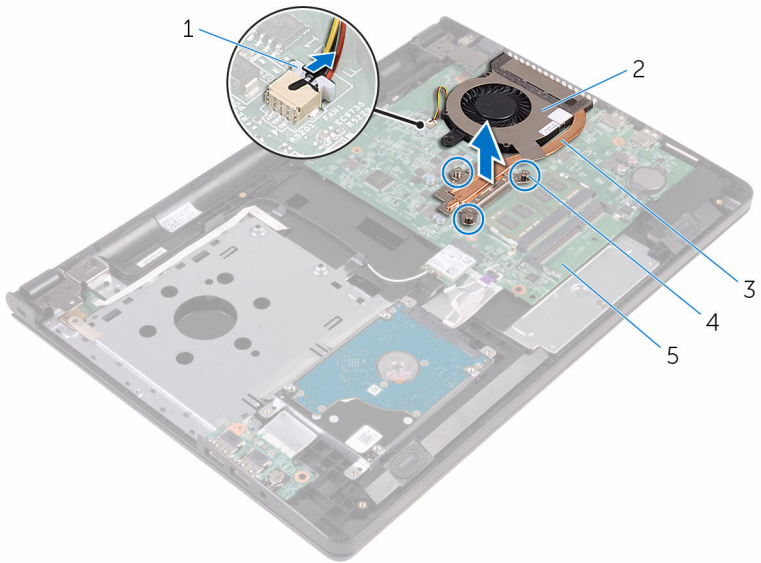

1 fan cable

2 fan

3 heat-sink assembly

4 captive screws (3)



5 system board

**3** Lift the heat-sink assembly off the system board.

**4** Remove the [fan](#).

# Replacing the heat-sink assembly

---

-  **WARNING:** Before working inside your computer, read the safety information that shipped with your computer and follow the steps in [Before working inside your computer](#). After working inside your computer, follow the instructions in [After working inside your computer](#). For more safety best practices, see the Regulatory Compliance home page at [www.dell.com/regulatory\\_compliance](http://www.dell.com/regulatory_compliance).
-  **CAUTION:** Incorrect alignment of the heat sink can damage the system board and processor.
-  **NOTE:** The original thermal grease can be reused if the original system board and fan are reinstalled together. If either the system board or the fan is replaced, use the thermal pad provided in the kit to ensure that thermal conductivity is achieved.

## Procedure

- 1 Replace the [fan](#).
- 2 Align the screws on the heat-sink assembly with the screw holes on the system board.
- 3 In sequential order, as indicated on the heat-sink assembly, tighten the captive screws that secure the heat-sink assembly to the system board.
- 4 Connect the fan cable to the system board.

## Post-requisites

- 1 Follow the procedure from step 3 to step 7 in “Replacing the [base cover](#)”.
- 2 Replace the [keyboard](#).
- 3 Follow the procedure from step 4 to step 5 in “Replacing the [optical drive](#)”.
- 4 Replace the [battery](#).



# Removing the fan

---

**!** **WARNING:** Before working inside your computer, read the safety information that shipped with your computer and follow the steps in [Before working inside your computer](#). After working inside your computer, follow the instructions in [After working inside your computer](#). For more safety best practices, see the Regulatory Compliance home page at [www.dell.com/regulatory\\_compliance](http://www.dell.com/regulatory_compliance).

## Prerequisites

- 1 Remove the [battery](#).
- 2 Follow the procedure from step 1 to step 3 in "Removing the [optical drive](#)".
- 3 Remove the [keyboard](#).
- 4 Follow the procedure from step 1 to step 5 in "Removing the [base cover](#)".
- 5 Remove the [heat-sink assembly](#).

## Procedure

- 1 Remove the screws that secure the fan to the heat-sink assembly.

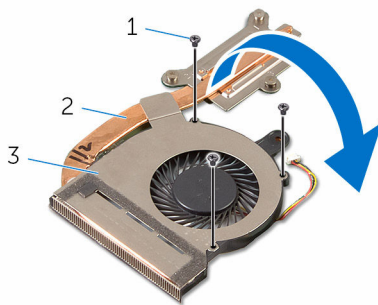

1 screws (3)

2 heat-sink assembly

3 fan

- 2 Turn the heat-sink assembly over.
- 3 Peel off the tape that secures the fan cable to the heat-sink assembly.

4 Lift the fan along with the fan cable off the heat-sink assembly.

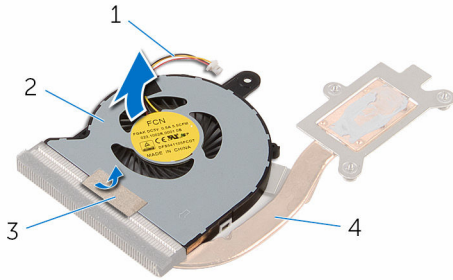

1 fan cable

2 fan

3 tape

4 heat-sink assembly

# Replacing the fan

---



**WARNING:** Before working inside your computer, read the safety information that shipped with your computer and follow the steps in [Before working inside your computer](#). After working inside your computer, follow the instructions in [After working inside your computer](#). For more safety best practices, see the Regulatory Compliance home page at [www.dell.com/regulatory\\_compliance](http://www.dell.com/regulatory_compliance).

## Procedure

- 1 Place the fan on the heat-sink assembly.
- 2 Adhere the tape that secures the fan cable to the heat-sink assembly.
- 3 Turn the heat-sink assembly over.
- 4 Replace the screws that secure the fan to the heat-sink assembly.

## Post-requisites

- 1 Replace the [heat-sink assembly](#).
- 2 Follow the procedure from step 3 to step 7 in "Replacing the [base cover](#)".
- 3 Replace the [keyboard](#).
- 4 Follow the procedure from step 4 to step 5 in "Replacing the [optical drive](#)".
- 5 Replace the [battery](#).

# Removing the system board

---



**WARNING:** Before working inside your computer, read the safety information that shipped with your computer and follow the steps in [Before working inside your computer](#). After working inside your computer, follow the instructions in [After working inside your computer](#). For more safety best practices, see the Regulatory Compliance home page at [www.dell.com/regulatory\\_compliance](http://www.dell.com/regulatory_compliance).



**NOTE:** Your computer's Service Tag is stored in the system board. You must enter the Service Tag in the BIOS setup program after you replace the system board.



**NOTE:** Replacing the system board removes any changes you have made to the BIOS using the BIOS setup program. You must make the desired changes again after you replace the system board.



**NOTE:** Before disconnecting the cables from the system board, note the location of the connectors so that you can reconnect the cables correctly after you replace the system board.

## Prerequisites

- 1 Remove the [battery](#).
- 2 Follow the procedure from step 1 to step 3 in "Removing the [optical drive](#)".
- 3 Remove the [keyboard](#).
- 4 Follow the procedure from step 1 to step 5 in "Removing the [base cover](#)".
- 5 Follow the procedure from step 1 to step 3 in "Removing the [hard drive](#)".
- 6 Remove the [memory module](#).
- 7 Remove the [wireless card](#).
- 8 Remove the [I/O board](#).
- 9 Remove the [heat-sink assembly](#).

## Procedure

- 1 Turn the computer over and open the display as far as possible.

- 2 Open the latches and disconnect the power-button board cable and touch-pad cable from the system board.



1 latches (2)

2 power-button board cable

3 palm-rest assembly

4 touch-pad cable

- 3 Close the display and turn the computer over.
- 4 Disconnect the speaker cable from the system board.
- 5 Remove the screw that secures the display hinge to the system board.

- 6** Open the display hinge to an angle of 90 degrees.

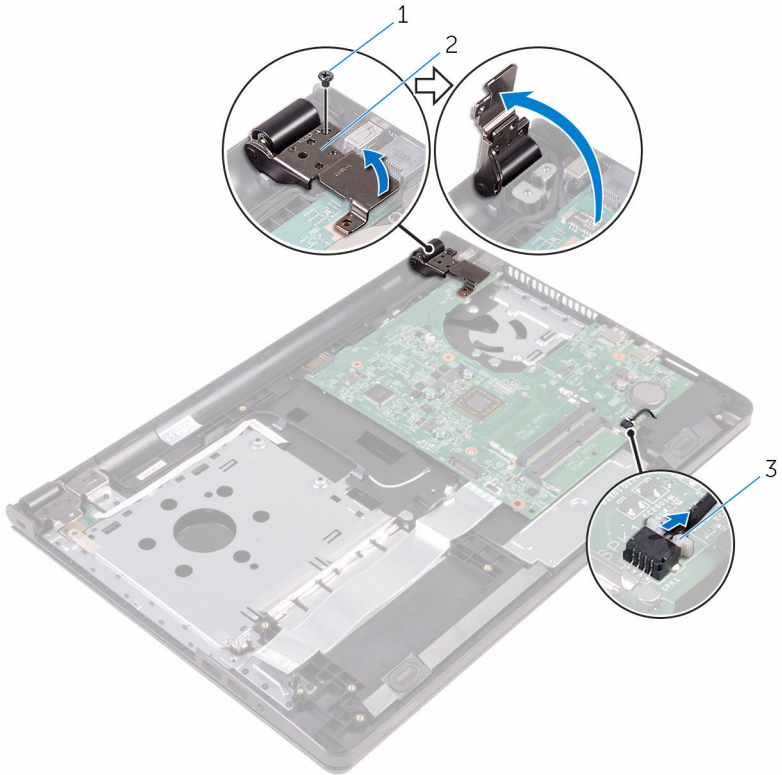

1 screw

2 display hinge

3 speaker cable

- 7** Remove the screw that secures the system board to the palm-rest assembly.
- 8** Lift and hold the speaker to release the system board from the palm-rest assembly.
- 9** Carefully lift the system board to release the ports from the slots on the palm-rest assembly.

**10** Turn the system board over.

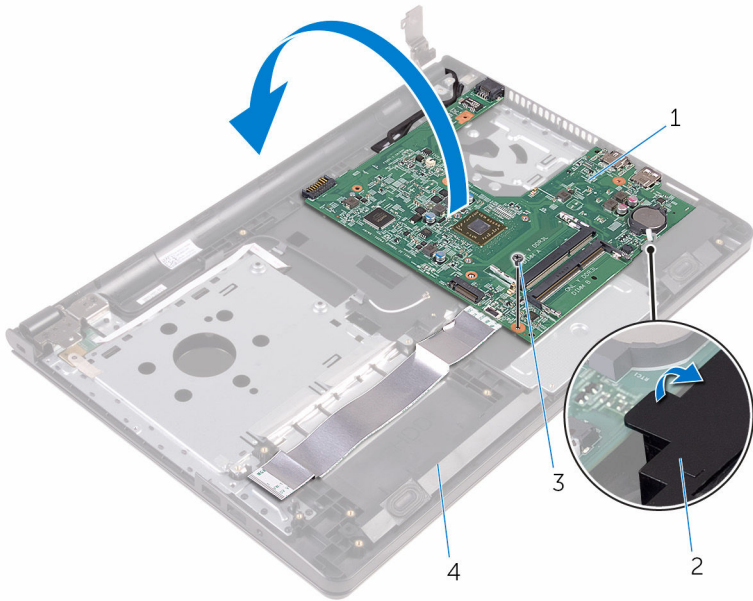

1 system board

2 speaker

3 screw

4 palm-rest assembly

**11** Peel the tapes that secure the I/O-board cable and display cable to the system board.

**12** Open the latches and disconnect the I/O-board cable and display cable from the system board.

**13** Disconnect the power-adaptor port cable from the system board.

14 Lift the system board off the palm-rest assembly.

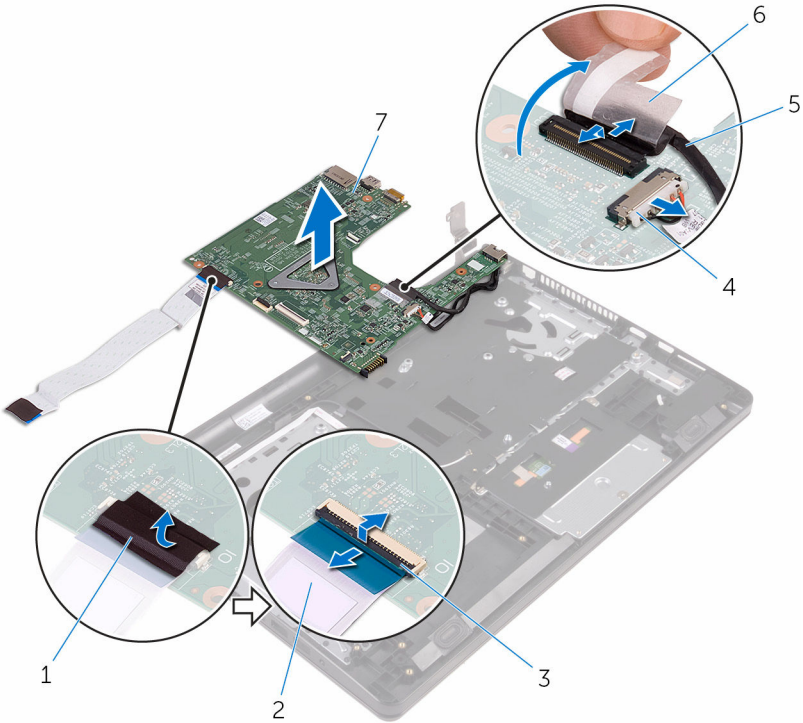

- 1 tape
- 2 I/O-board cable
- 3 latch
- 4 power-adaptor port cable
- 5 display cable
- 6 tape
- 7 system board



# Replacing the system board

---



**WARNING:** Before working inside your computer, read the safety information that shipped with your computer and follow the steps in [Before working inside your computer](#). After working inside your computer, follow the instructions in [After working inside your computer](#). For more safety best practices, see the Regulatory Compliance home page at [www.dell.com/regulatory\\_compliance](http://www.dell.com/regulatory_compliance).



**NOTE:** Your computer's Service Tag is stored in the system board. You must enter the Service Tag in the BIOS setup program after you replace the system board.



**NOTE:** Replacing the system board removes any changes you have made to the BIOS using the BIOS setup program. You must make the desired changes again after you replace the system board.

## Procedure

- 1 Slide the display cable into the connector on the system board and close the latch to secure the cable.
- 2 Adhere the tape that secures the display cable to the system board.
- 3 Connect the power-adaptor port cable to the system board.
- 4 Slide the I/O-board cable into the connector on the system board and close the latch to secure the cable.
- 5 Adhere the tape that secures the I/O-board cable to the system board.
- 6 Turn the system board over.
- 7 Slide the ports on the system board into the slots on the palm-rest assembly and place the system board on the palm-rest assembly.
- 8 Align the screw hole on the system board with the screw hole on the palm-rest assembly and place the system board on the palm-rest assembly.
- 9 Replace the screw that secures the system board to the palm-rest assembly.
- 10 Close the display hinge and align the screw hole on the display hinge with the screw hole on the system board.
- 11 Replace the screw that secures the display hinge to the system board .
- 12 Turn the computer over and open the display as far as possible,

- 13 Slide the touch-pad cable and the power-button board cable into their connectors on the system board and close the latches to secure the cables.

## Post-requisites

- 1 Replace the [heat-sink assembly](#).
- 2 Replace the [I/O board](#).
- 3 Replace the [wireless card](#).
- 4 Replace the [memory module](#).
- 5 Follow the procedure from step 4 to step 6 in "Replacing the [hard drive](#)".
- 6 Follow the procedure from step 3 to step 7 in "Replacing the [base cover](#)".
- 7 Replace the [keyboard](#).
- 8 Follow the procedure from step 4 to step 5 in "Replacing the [optical drive](#)".
- 9 Replace the [battery](#).

# Removing the touch pad

---



**WARNING:** Before working inside your computer, read the safety information that shipped with your computer and follow the steps in [Before working inside your computer](#). After working inside your computer, follow the instructions in [After working inside your computer](#). For more safety best practices, see the Regulatory Compliance home page at [www.dell.com/regulatory\\_compliance](http://www.dell.com/regulatory_compliance).

## Prerequisites

- 1 Remove the [battery](#).
- 2 Follow the procedure from step 1 to step 3 in “Removing the [optical drive](#)”.
- 3 Remove the [keyboard](#).
- 4 Follow the procedure from step 1 to step 5 in “Removing the [base cover](#)”.
- 5 Follow the procedure from step 1 to step 3 in “Removing the [hard drive](#)”.
- 6 Remove the [memory module](#).
- 7 Remove the [wireless card](#).
- 8 Remove the [I/O board](#).
- 9 Remove the [heat-sink assembly](#).
- 10 Remove the [system board](#).

# Procedure

- 1 Peel the tape off the touch-pad bracket.

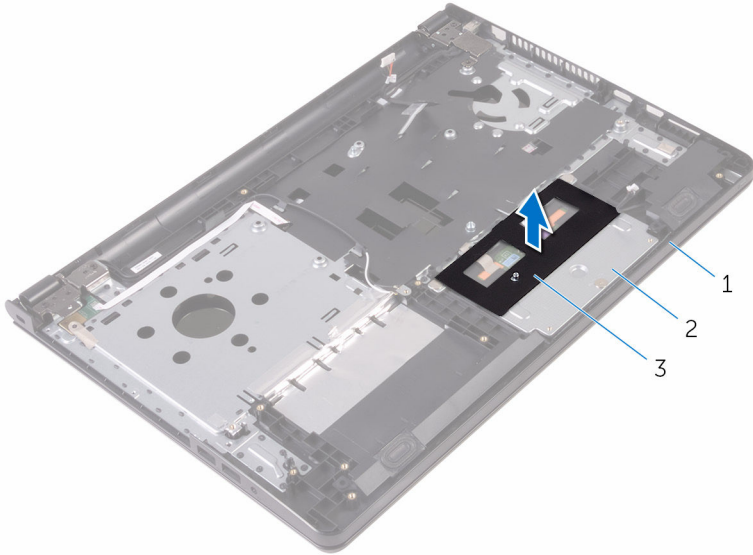

- |   |                    |   |                   |
|---|--------------------|---|-------------------|
| 1 | palm-rest assembly | 2 | touch-pad bracket |
| 3 | tape               |   |                   |

- 2 Remove the screws that secure the touch-pad bracket to the touch pad.
- 3 Peel off the tape that secures the touch-pad bracket to the touch pad.

- 4 Open the latch and disconnect the touch-pad cable from the touch pad.

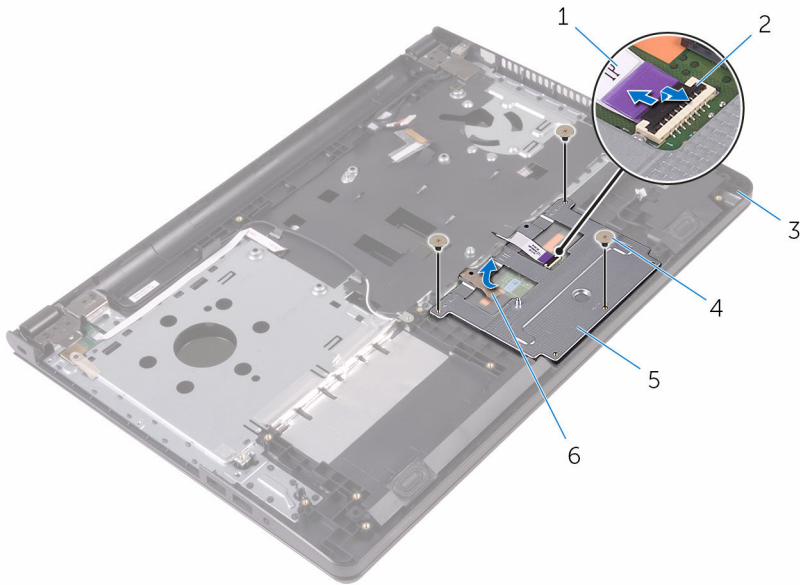

- |   |                    |   |            |
|---|--------------------|---|------------|
| 1 | touch-pad cable    | 2 | latch      |
| 3 | palm-rest assembly | 4 | screws (3) |
| 5 | touch-pad bracket  | 6 | tape       |

5 Lift the touch-pad bracket off the touch pad.

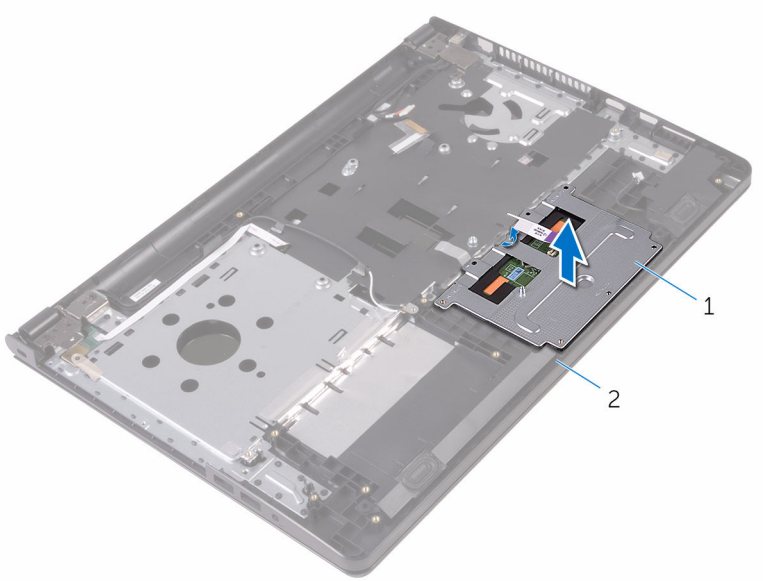

1 touch-pad bracket

2 palm-rest assembly

- 6 Lift the touch pad off the palm-rest assembly.

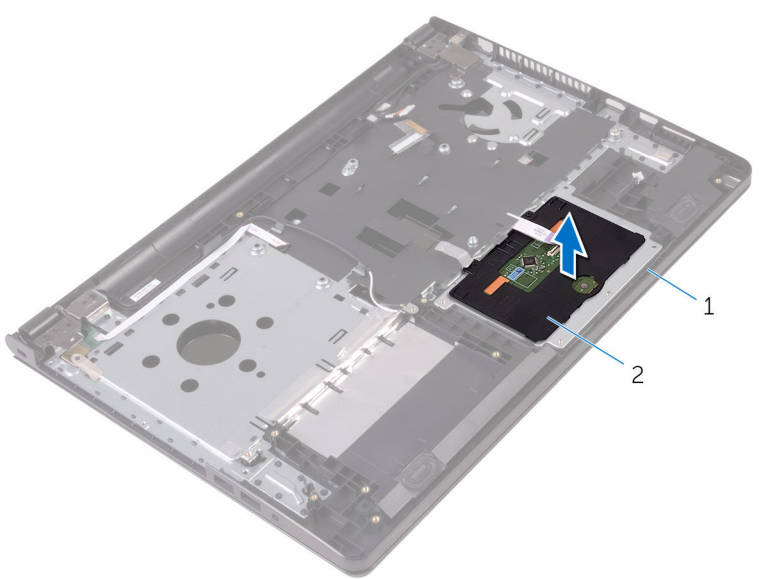

1 palm-rest assembly

2 touch pad

# Replacing the touch pad

---



**WARNING:** Before working inside your computer, read the safety information that shipped with your computer and follow the steps in [Before working inside your computer](#). After working inside your computer, follow the instructions in [After working inside your computer](#). For more safety best practices, see the Regulatory Compliance home page at [www.dell.com/regulatory\\_compliance](http://www.dell.com/regulatory_compliance).

## Procedure

- 1 Place the touch pad on the palm-rest assembly.
- 2 Slide the tabs on the touch-pad bracket into the slots on the palm-rest assembly.
- 3 Slide the touch-pad cable into the connector on the touch pad and close the latch to secure the cable.
- 4 Align the screw holes on the touch-pad bracket with the screw holes on the palm-rest assembly.
- 5 Replace the screws that secure the touch-pad bracket to the palm-rest assembly.
- 6 Adhere the tape over the touch-pad bracket.

## Post-requisites

- 1 Replace the [system board](#).
- 2 Replace the [heat-sink assembly](#).
- 3 Replace the [I/O board](#).
- 4 Replace the [wireless card](#).
- 5 Replace the [memory module](#).
- 6 Follow the procedure from step 4 to step 6 in "Replacing the [hard drive](#)".
- 7 Follow the procedure from step 3 to step 7 in "Replacing the [base cover](#)".
- 8 Replace the [keyboard](#).
- 9 Follow the procedure from step 4 to step 5 in "Replacing the [optical drive](#)".
- 10 Replace the [battery](#).



# Removing the power-adapter port

---

 **WARNING:** Before working inside your computer, read the safety information that shipped with your computer and follow the steps in [Before working inside your computer](#). After working inside your computer, follow the instructions in [After working inside your computer](#). For more safety best practices, see the Regulatory Compliance home page at [www.dell.com/regulatory\\_compliance](http://www.dell.com/regulatory_compliance).

## Prerequisites

- 1 Remove the [battery](#).
- 2 Follow the procedure from step 1 to step 3 in “Removing the [optical drive](#)”.
- 3 Remove the [keyboard](#).
- 4 Follow the procedure from step 1 to step 5 in “Removing the [base cover](#)”.
- 5 Follow the procedure from step 1 to step 3 in “Removing the [hard drive](#)”.
- 6 Remove the [memory module](#).
- 7 Remove the [wireless card](#).
- 8 Remove the [I/O board](#).
- 9 Remove the [heat-sink assembly](#).
- 10 Remove the [system board](#).

## Procedure

- 1 Remove the screw that secures the display hinge to the palm-rest assembly.

- 2 Open the display hinge to an angle of 90 degrees.

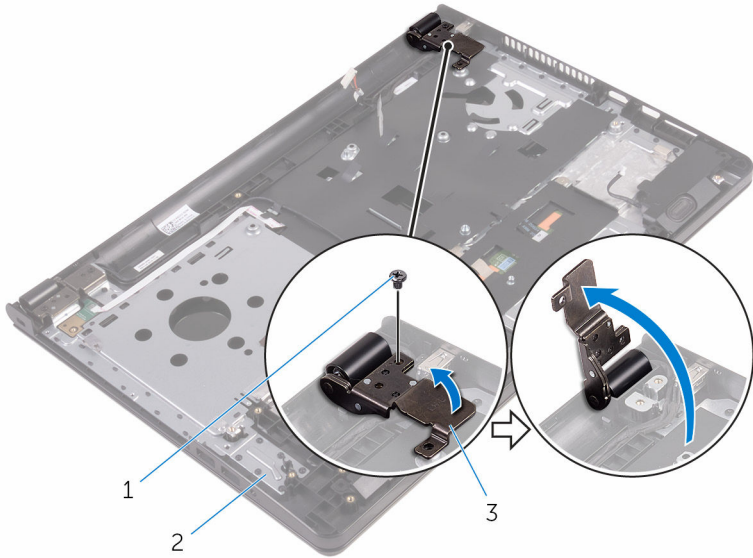

1 screw

2 palm-rest assembly

3 display hinge

- 3 Note the power-adapter port cable routing and remove the cable from its routing guides.
- 4 Remove the screw that secures the power-adapter port to the palm-rest assembly.

- 5 Lift the power-adapter port, along with its cable, off the palm-rest assembly.

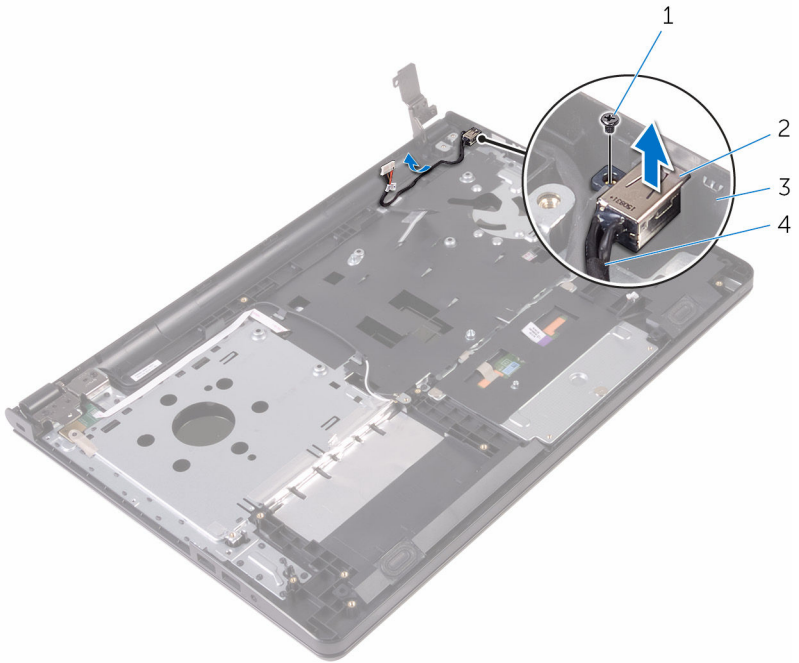

1 screw

2 power-adapter port

3 palm-rest assembly

4 power-adapter port cable

# Replacing the power-adapter port

---

 **WARNING:** Before working inside your computer, read the safety information that shipped with your computer and follow the steps in [Before working inside your computer](#). After working inside your computer, follow the instructions in [After working inside your computer](#). For more safety best practices, see the Regulatory Compliance home page at [www.dell.com/regulatory\\_compliance](http://www.dell.com/regulatory_compliance).

## Procedure

- 1 Slide the power-adapter port into the slot on the palm-rest assembly.
- 2 Replace the screw that secures the power-adapter port to the palm-rest assembly.
- 3 Route the power-adapter port cable along its routing guides on the palm-rest assembly.
- 4 Close the display hinge and replace the screw that secures the display hinge to the palm-rest assembly.

## Post-requisites

- 1 Replace the [system board](#).
- 2 Replace the [heat-sink assembly](#).
- 3 Replace the [I/O board](#).
- 4 Replace the [wireless card](#).
- 5 Replace the [memory module](#).
- 6 Follow the procedure from step 4 to step 6 in “Replacing the [hard drive](#)”.
- 7 Follow the procedure from step 3 to step 7 in “Replacing the [base cover](#)”.
- 8 Replace the [keyboard](#).
- 9 Follow the procedure from step 4 to step 5 in “Replacing the [optical drive](#)”.
- 10 Replace the [battery](#).

# Removing the display assembly

---

 **WARNING:** Before working inside your computer, read the safety information that shipped with your computer and follow the steps in [Before working inside your computer](#). After working inside your computer, follow the instructions in [After working inside your computer](#). For more safety best practices, see the Regulatory Compliance home page at [www.dell.com/regulatory\\_compliance](http://www.dell.com/regulatory_compliance).

## Prerequisites

 **NOTE:** These instructions are applicable only for laptops with a non-touch screen display.

- 1 Remove the [battery](#).
- 2 Follow the procedure from step 1 to step 3 in “Removing the [optical drive](#)”.
- 3 Remove the [keyboard](#).
- 4 Follow the procedure from step 1 to step 5 in “Removing the [base cover](#)”.
- 5 Follow the procedure from step 1 to step 3 in “Removing the [hard drive](#)”.
- 6 Remove the [memory module](#).
- 7 Remove the [wireless card](#).
- 8 Remove the [I/O board](#).
- 9 Remove the [heat-sink assembly](#).
- 10 Remove the [system board](#).

## Procedure

- 1 Remove the screws that secure the display hinges to the palm-rest assembly and open the hinges to an angle of 90 degrees.
- 2 Note the antenna cable routing and remove the cable from its routing guides on the palm-rest assembly.

**3** Note the display cable routing and remove the cable from its routing guides on the palm-rest assembly.

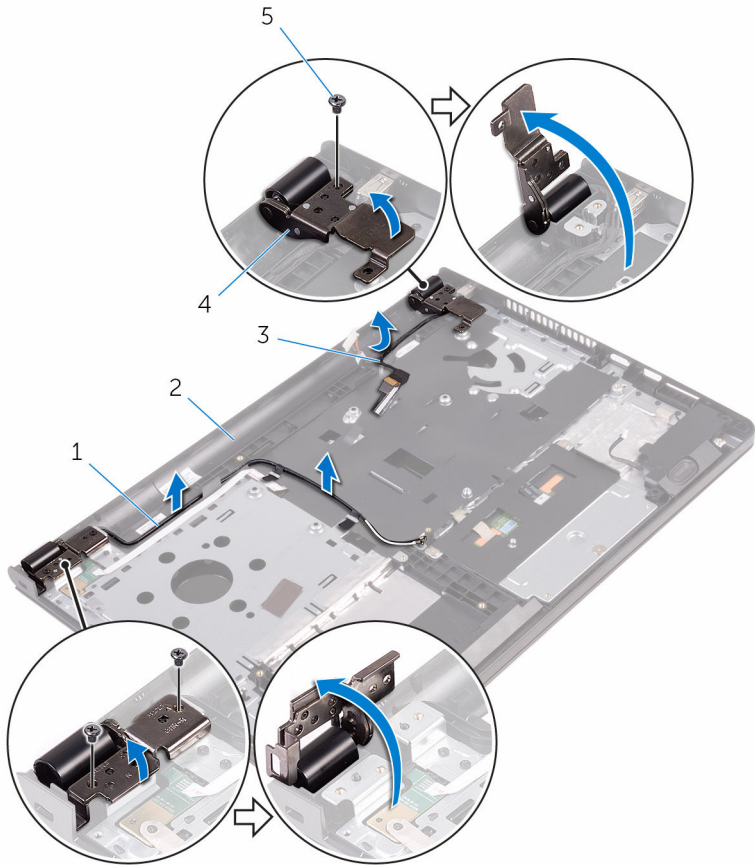

1 antenna cables (2)

2 palm-rest assembly

3 display cable

4 display hinges (2)

5 screws (3)

4 Open the palm-rest assembly.

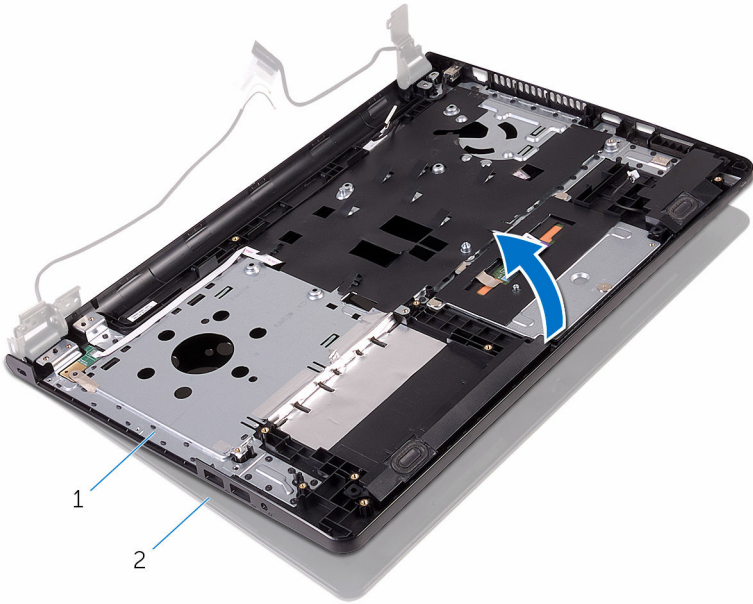

1 palm-rest assembly

2 display assembly

5 Lift the palm-rest assembly at an angle off the display assembly.

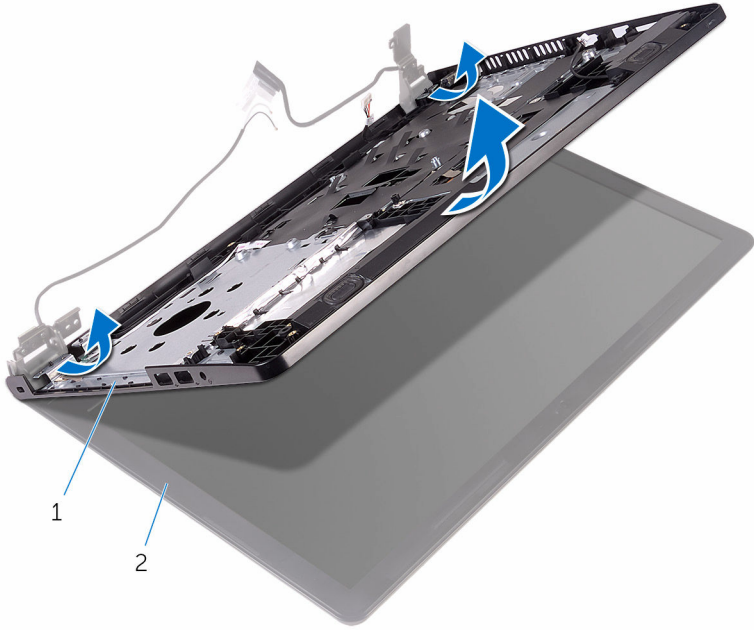

1 palm-rest assembly

2 display assembly



- 6 Place the display assembly on a clean, flat surface.



- 1 display assembly

# Replacing the display assembly

---



**WARNING:** Before working inside your computer, read the safety information that shipped with your computer and follow the steps in [Before working inside your computer](#). After working inside your computer, follow the instructions in [After working inside your computer](#). For more safety best practices, see the Regulatory Compliance home page at [www.dell.com/regulatory\\_compliance](http://www.dell.com/regulatory_compliance).

## Procedure

- 1 Place the display assembly on the palm-rest assembly.
- 2 Close the display hinges and align the screw holes on the display hinges with the screw holes on the palm-rest assembly.
- 3 Replace the screws that secure the display hinges to the palm-rest assembly.
- 4 Route the display cable through its routing guides on the palm-rest assembly.
- 5 Route the antenna cables through its routing guides on the palm-rest assembly.
- 6 Close the display and turn the computer over.

## Post-requisites

- 1 Replace the [system board](#).
- 2 Replace the [heat-sink assembly](#).
- 3 Replace the [I/O board](#).
- 4 Replace the [wireless card](#).
- 5 Replace the [memory module](#).
- 6 Follow the procedure from step 4 to step 6 in "Replacing the [hard drive](#)".
- 7 Follow the procedure from step 3 to step 7 in "Replacing the [base cover](#)".
- 8 Follow the procedure from step 4 to step 5 in "Replacing the [optical drive](#)".
- 9 Replace the [keyboard](#).
- 10 Replace the [battery](#).

# Removing the display bezel

---



**WARNING:** Before working inside your computer, read the safety information that shipped with your computer and follow the steps in [Before working inside your computer](#). After working inside your computer, follow the instructions in [After working inside your computer](#). For more safety best practices, see the Regulatory Compliance home page at [www.dell.com/regulatory\\_compliance](http://www.dell.com/regulatory_compliance).

## Prerequisites



**NOTE:** These instructions are applicable only for laptops with a non-touch screen display.

- 1 Remove the [battery](#).
- 2 Follow the procedure from step 1 to step 3 in “Removing the [optical drive](#)”.
- 3 Remove the [keyboard](#).
- 4 Follow the procedure from step 1 to step 5 in “Removing the [base cover](#)”.
- 5 Follow the procedure from step 1 to step 3 in “Removing the [hard drive](#)”.
- 6 Remove the [memory module](#).
- 7 Remove the [wireless card](#).
- 8 Remove the [I/O board](#).
- 9 Remove the [heat-sink assembly](#).
- 10 Remove the [system board](#).
- 11 Remove the [display assembly](#).

## Procedure

- 1 Using your fingertips, gently pry up the inner edges of the display bezel.

2 Lift the display bezel off the display assembly.

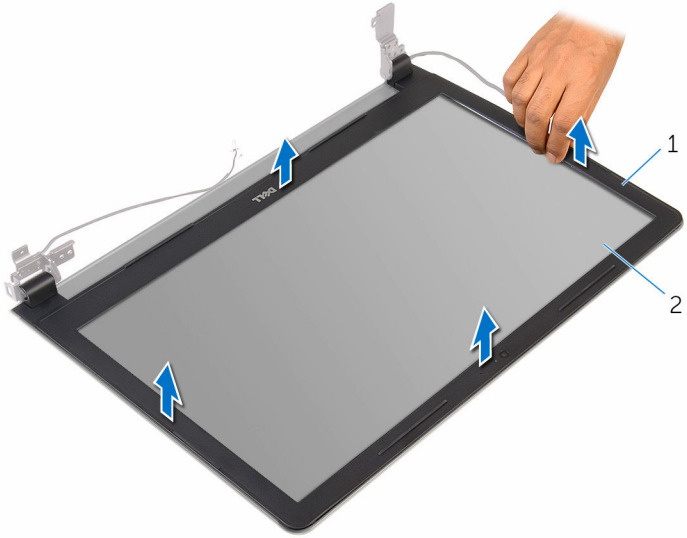

1 display bezel

2 display panel

# Replacing the display bezel

---



**WARNING:** Before working inside your computer, read the safety information that shipped with your computer and follow the steps in [Before working inside your computer](#). After working inside your computer, follow the instructions in [After working inside your computer](#). For more safety best practices, see the Regulatory Compliance home page at [www.dell.com/regulatory\\_compliance](http://www.dell.com/regulatory_compliance).

## Procedure

Align the display bezel with the display back-cover and gently snap the display bezel into place.

## Post-requisites

- 1 Replace the [display assembly](#).
- 2 Replace the [system board](#).
- 3 Replace the [heat-sink assembly](#).
- 4 Replace the [I/O board](#).
- 5 Replace the [wireless card](#).
- 6 Replace the [memory module](#).
- 7 Follow the procedure from step 4 to step 6 in "Replacing the [hard drive](#)".
- 8 Follow the procedure from step 3 to step 7 in "Replacing the [base cover](#)".
- 9 Follow the procedure from step 4 to step 5 in "Replacing the [optical drive](#)".
- 10 Replace the [keyboard](#).
- 11 Replace the [battery](#).

# Removing the display panel

---



**WARNING:** Before working inside your computer, read the safety information that shipped with your computer and follow the steps in [Before working inside your computer](#). After working inside your computer, follow the instructions in [After working inside your computer](#). For more safety best practices, see the Regulatory Compliance home page at [www.dell.com/regulatory\\_compliance](http://www.dell.com/regulatory_compliance).

## Prerequisites



**NOTE:** These instructions are applicable only for laptops with a non-touch screen display.

- 1 Remove the [battery](#).
- 2 Follow the procedure from step 1 to step 3 in “Removing the [optical drive](#)”.
- 3 Remove the [keyboard](#).
- 4 Follow the procedure from step 1 to step 5 in “Removing the [base cover](#)”.
- 5 Follow the procedure from step 1 to step 3 in “Removing the [hard drive](#)”.
- 6 Remove the [memory module](#).
- 7 Remove the [wireless card](#).
- 8 Remove the [I/O board](#).
- 9 Remove the [heat-sink assembly](#).
- 10 Remove the [system board](#).
- 11 Remove the [display assembly](#).
- 12 Remove the [display bezel](#).

## Procedure

- 1 Remove the screws that secure the display panel to the display back-cover.

- 2 Turn the display panel over.

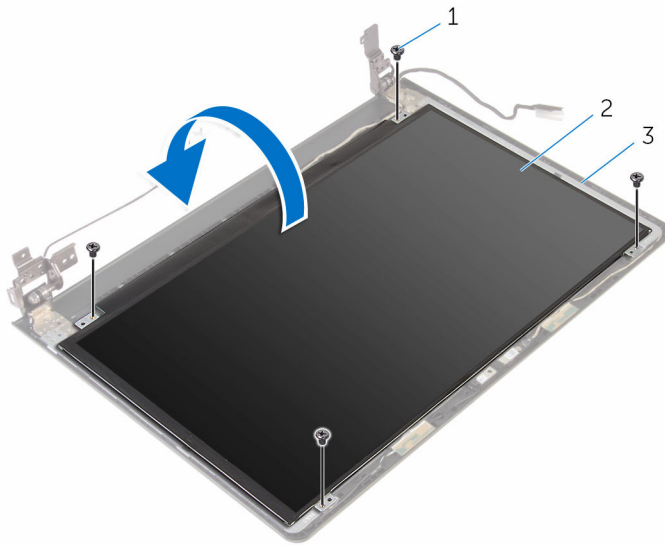

1 screws (4)

2 display panel

3 display back-cover

- 3 Peel the tape that secures the display cable to the display back-cover.
- 4 Open the latch and disconnect the display cable from the display back-cover.

5 Lift the display panel off the display back-cover.

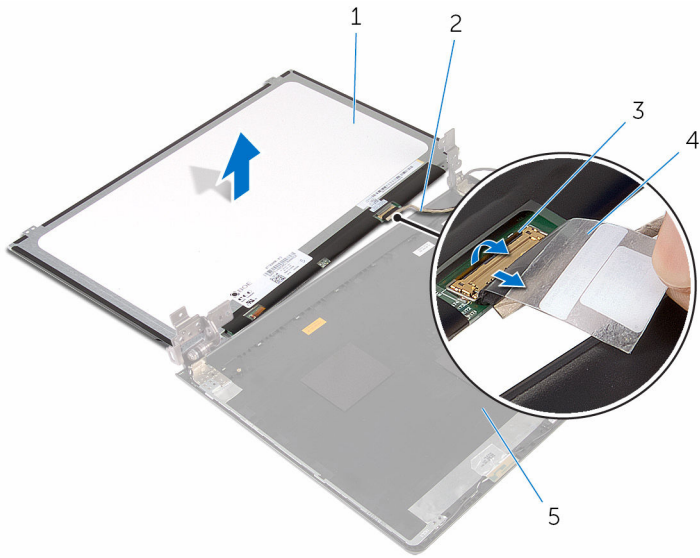

1 display panel

2 display cable

3 latch

4 tape

5 display back-cover



# Replacing the display panel

---



**WARNING:** Before working inside your computer, read the safety information that shipped with your computer and follow the steps in [Before working inside your computer](#). After working inside your computer, follow the instructions in [After working inside your computer](#). For more safety best practices, see the Regulatory Compliance home page at [www.dell.com/regulatory\\_compliance](http://www.dell.com/regulatory_compliance).

## Procedure

- 1 Slide the display cable into the connector on the display back-cover and close the latch to secure the cable.
- 2 Adhere the tape that secures the display cable to the display back-cover.
- 3 Turn the display panel over and place it on the display back-cover.
- 4 Align the screw holes on the display panel with the screw holes on the display back-cover.
- 5 Replace the screws that secure the display panel to the display back-cover.

## Post-requisites

- 1 Replace the [display bezel](#).
- 2 Replace the [display assembly](#).
- 3 Replace the [system board](#).
- 4 Replace the [heat-sink assembly](#).
- 5 Replace the [I/O board](#).
- 6 Replace the [wireless card](#).
- 7 Replace the [memory module](#).
- 8 Follow the procedure from step 4 to step 6 in "Replacing the [hard drive](#)".
- 9 Follow the procedure from step 3 to step 7 in "Replacing the [base cover](#)".
- 10 Follow the procedure from step 4 to step 5 in "Replacing the [optical drive](#)".
- 11 Replace the [keyboard](#).
- 12 Replace the [battery](#).

# Removing the camera

---



**WARNING:** Before working inside your computer, read the safety information that shipped with your computer and follow the steps in [Before working inside your computer](#). After working inside your computer, follow the instructions in [After working inside your computer](#). For more safety best practices, see the Regulatory Compliance home page at [www.dell.com/regulatory\\_compliance](http://www.dell.com/regulatory_compliance).

## Prerequisites



**NOTE:** These instructions are applicable only for laptops with a non-touchscreen display.

- 1 Remove the [battery](#).
- 2 Follow the procedure from step 1 to step 3 in “Removing the [optical drive](#)”.
- 3 Remove the [keyboard](#).
- 4 Follow the procedure from step 1 to step 5 in “Removing the [base cover](#)”.
- 5 Follow the procedure from step 1 to step 3 in “Removing the [hard drive](#)”.
- 6 Remove the [memory module](#).
- 7 Remove the [wireless card](#).
- 8 Remove the [I/O board](#).
- 9 Remove the [heat-sink assembly](#).
- 10 Remove the [system board](#).
- 11 Remove the [display assembly](#).
- 12 Remove the [display bezel](#).

## Procedure

- 1 Using a plastic scribe, gently pry the camera off the display back-cover.

2 Disconnect the camera cable from the camera.

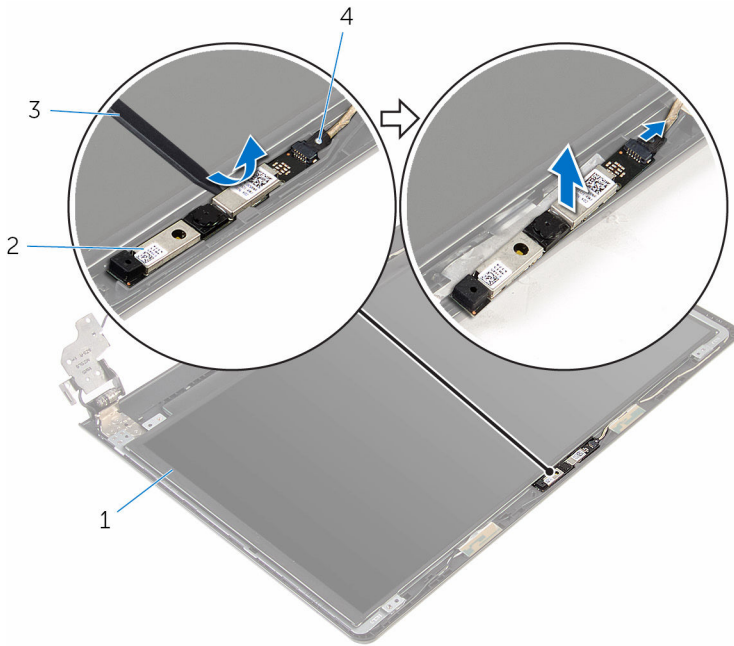

1 display back-cover

2 camera

3 plastic scribe

4 camera cable

# Replacing the camera

---



**WARNING:** Before working inside your computer, read the safety information that shipped with your computer and follow the steps in [Before working inside your computer](#). After working inside your computer, follow the instructions in [After working inside your computer](#). For more safety best practices, see the Regulatory Compliance home page at [www.dell.com/regulatory\\_compliance](http://www.dell.com/regulatory_compliance).

## Procedure

- 1 Connect the camera cable to the camera.
- 2 Align the camera to the alignment posts on the display back-cover and snap the camera in place.

## Post-requisites

- 1 Replace the [display bezel](#).
- 2 Replace the [display assembly](#).
- 3 Replace the [system board](#).
- 4 Replace the [heat-sink assembly](#).
- 5 Replace the [I/O board](#).
- 6 Replace the [wireless card](#).
- 7 Replace the [memory module](#).
- 8 Follow the procedure from step 4 to step 6 in "Replacing the [hard drive](#)".
- 9 Follow the procedure from step 3 to step 7 in "Replacing the [base cover](#)".
- 10 Follow the procedure from step 4 to step 5 in "Replacing the [optical drive](#)".
- 11 Replace the [keyboard](#).
- 12 Replace the [battery](#).

# Removing the display hinges

---

 **WARNING:** Before working inside your computer, read the safety information that shipped with your computer and follow the steps in [Before working inside your computer](#). After working inside your computer, follow the instructions in [After working inside your computer](#). For more safety best practices, see the Regulatory Compliance home page at [www.dell.com/regulatory\\_compliance](http://www.dell.com/regulatory_compliance).

## Prerequisites

 **NOTE:** These instructions are applicable only for laptops with a non-touchscreen display.

- 1 Remove the [battery](#).
- 2 Follow the procedure from step 1 to step 3 in “Removing the [optical drive](#)”.
- 3 Remove the [keyboard](#).
- 4 Follow the procedure from step 1 to step 5 in “Removing the [base cover](#)”.
- 5 Follow the procedure from step 1 to step 3 in “Removing the [hard drive](#)”.
- 6 Remove the [memory module](#).
- 7 Remove the [wireless card](#).
- 8 Remove the [I/O board](#).
- 9 Remove the [heat-sink assembly](#).
- 10 Remove the [system board](#).
- 11 Remove the [display assembly](#).
- 12 Remove the [display bezel](#).
- 13 Remove the [display panel](#).

## Procedure

- 1 Remove the screws that secure the display hinges to the display back-cover.

- 2 Release the hinges from the latches and lift the display hinges off the display back-cover.

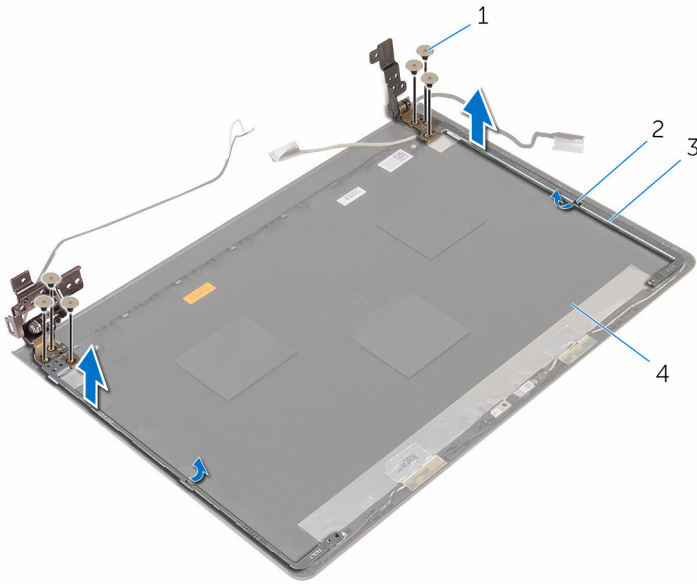

- |   |                    |   |                    |
|---|--------------------|---|--------------------|
| 1 | screws (6)         | 2 | latches (2)        |
| 3 | display hinges (2) | 4 | display back-cover |

# Replacing the display hinges

---



**WARNING:** Before working inside your computer, read the safety information that shipped with your computer and follow the steps in [Before working inside your computer](#). After working inside your computer, follow the instructions in [After working inside your computer](#). For more safety best practices, see the Regulatory Compliance home page at [www.dell.com/regulatory\\_compliance](http://www.dell.com/regulatory_compliance).

## Procedure

- 1 Slide the hinges under the latches on the display back-cover.
- 2 Align the screw holes on the display hinges with the screw holes on the display back-cover.
- 3 Replace the screws that secure the display hinges to the display back-cover.

## Post-requisites

- 1 Replace the [display panel](#).
- 2 Replace the [display bezel](#).
- 3 Replace the [display assembly](#).
- 4 Replace the [system board](#).
- 5 Replace the [heat-sink assembly](#).
- 6 Replace the [I/O board](#).
- 7 Replace the [wireless card](#).
- 8 Replace the [memory module](#).
- 9 Follow the procedure from step 4 to step 6 in "Replacing the [hard drive](#)".
- 10 Follow the procedure from step 3 to step 7 in "Replacing the [base cover](#)".
- 11 Follow the procedure from step 4 to step 5 in "Replacing the [optical drive](#)".
- 12 Replace the [keyboard](#).
- 13 Replace the [battery](#).

# Removing the palm rest

---



**WARNING:** Before working inside your computer, read the safety information that shipped with your computer and follow the steps in [Before working inside your computer](#). After working inside your computer, follow the instructions in [After working inside your computer](#). For more safety best practices, see the Regulatory Compliance home page at [www.dell.com/regulatory\\_compliance](http://www.dell.com/regulatory_compliance).

## Prerequisites



**NOTE:** These instructions are applicable only for laptops with a non-touch screen display.

- 1 Remove the [battery](#).
- 2 Follow the procedure from step 1 to step 3 in “Removing the [optical drive](#)”.
- 3 Remove the [keyboard](#).
- 4 Follow the procedure from step 1 to step 5 in “Removing the [base cover](#)”.
- 5 Follow the procedure from step 1 to step 3 in “Removing the [hard drive](#)”.
- 6 Remove the [memory module](#).
- 7 Remove the [wireless card](#).
- 8 Remove the [I/O board](#).
- 9 Remove the [heat-sink assembly](#).
- 10 Remove the [system board](#).
- 11 Remove the [touch pad](#).
- 12 Remove the [display assembly](#).

## Procedure

After performing the prerequisites, we are left with the palm rest.



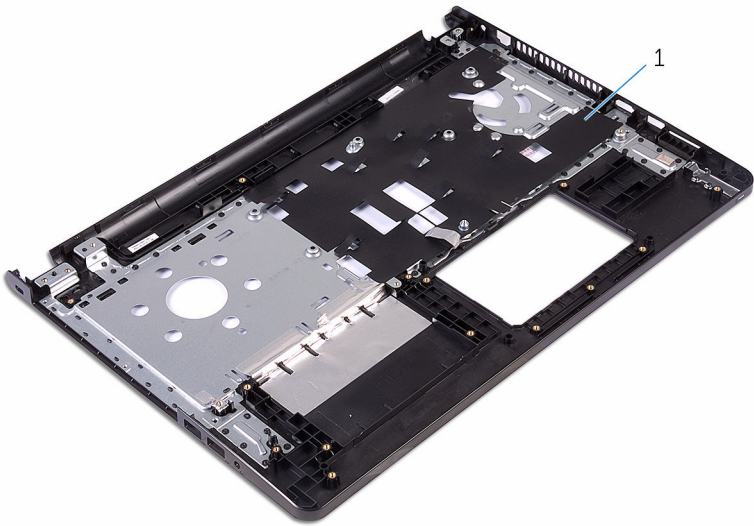

1 palm rest

# Replacing the palm rest

---



**WARNING:** Before working inside your computer, read the safety information that shipped with your computer and follow the steps in [Before working inside your computer](#). After working inside your computer, follow the instructions in [After working inside your computer](#). For more safety best practices, see the Regulatory Compliance home page at [www.dell.com/regulatory\\_compliance](http://www.dell.com/regulatory_compliance).

## Procedure

Place the palm rest on a clean and flat surface.

## Post-requisites

- 1 Replace the [display assembly](#).
- 2 Replace the [touch pad](#).
- 3 Replace the [system board](#).
- 4 Replace the [heat-sink assembly](#).
- 5 Replace the [I/O board](#).
- 6 Replace the [wireless card](#).
- 7 Replace the [memory module](#).
- 8 Follow the procedure from step 4 to step 6 in “Replacing the [hard drive](#)”.
- 9 Follow the procedure from step 3 to step 7 in “Replacing the [base cover](#)”.
- 10 Follow the procedure from step 4 to step 5 in “Replacing the [optical drive](#)”.
- 11 Replace the [keyboard](#).
- 12 Replace the [battery](#).

# Flashing the BIOS

---

You may need to flash (update) the BIOS when an update is available or when you replace the system board. To flash the BIOS:

- 1 Turn on the computer.
- 2 Go to **[www.dell.com/support](http://www.dell.com/support)**.
- 3 Click **Product Support**, enter the Service Tag of your computer and click **Submit**.  
 **NOTE:** If you do not have the Service Tag, use the auto-detect feature or manually browse for your computer model.
- 4 Click **Drivers & downloads**.
- 5 Select the operating system installed on your computer.
- 6 Scroll down the page and expand **BIOS**.
- 7 Click **Download File** to download the latest version of the BIOS for your computer.
- 8 Save the file and, once the download is complete, navigate to the folder where you saved the BIOS update file.
- 9 Double-click the BIOS update file icon and follow the instructions on the screen.

# Getting help and contacting Dell

---

## Self-help resources

You can get information and help on Dell products and services using these self-help resources:

Information about Dell products and services

[www.dell.com](http://www.dell.com)

Windows 8.1 and Windows 10

Dell Help & Support app



Windows 10

Get started app



Windows 8.1

Help + Tips app



Accessing help in Windows 8, Windows 8.1, and Windows 10

In Windows search, type **Help and Support**, and press **Enter**.

Accessing help in Windows 7

Click **Start** → **Help and Support**.

Online help for operating system

[www.dell.com/support/windows](http://www.dell.com/support/windows)  
[www.dell.com/support/linux](http://www.dell.com/support/linux)

Troubleshooting information, user manuals, setup instructions, product specifications, technical help blogs, drivers, software updates, and so on

[www.dell.com/support](http://www.dell.com/support)

Learn about your operating system, setting up and using your computer, data backup, diagnostics, and so on.

See *Me and My Dell* at [www.dell.com/support/manuals](http://www.dell.com/support/manuals).

# Contacting Dell

To contact Dell for sales, technical support, or customer service issues, see [www.dell.com/contactdell](http://www.dell.com/contactdell).



**NOTE:** Availability varies by country and product, and some services may not be available in your country.



**NOTE:** If you do not have an active internet connection, you can find contact information on your purchase invoice, packing slip, bill, or Dell product catalog.