

Inspiron 15

3000 Series

Service Manual

Computer Model: Inspiron 15-3541/Inspiron
15-3542/Inspiron 15-3543
Regulatory Model: P40F
Regulatory Type: P40F001/P40F002



Notes, Cautions, and Warnings



NOTE: A NOTE indicates important information that helps you make better use of your computer.



CAUTION: A CAUTION indicates either potential damage to hardware or loss of data and tells you how to avoid the problem.



WARNING: A WARNING indicates a potential for property damage, personal injury, or death.

Copyright © 2014 Dell Inc. All rights reserved. This product is protected by U.S. and international copyright and intellectual property laws. Dell™ and the Dell logo are trademarks of Dell Inc. in the United States and/or other jurisdictions. All other marks and names mentioned herein may be trademarks of their respective companies.

Contents

Before Working Inside Your Computer.....	10
Before You Begin	10
Safety Instructions.....	10
Recommended Tools.....	11
After Working Inside Your Computer.....	13
Removing the Battery.....	14
Procedure.....	14
Replacing the Battery.....	15
Procedure.....	15
Removing the Base Cover.....	16
Prerequisites.....	16
Procedure.....	16
Replacing the Base Cover.....	17
Procedure.....	17
Post-requisites.....	17
Removing the Optical Drive.....	18
Prerequisites.....	18
Procedure.....	18
Replacing the Optical Drive.....	20
Procedure.....	20
Post-requisites.....	20

Removing the Hard Drive.....	21
Prerequisites.....	21
Procedure.....	21
Replacing the Hard Drive.....	23
Procedure.....	23
Post-requisites.....	23
Removing the Memory Module.....	24
Prerequisites.....	24
Procedure.....	24
Replacing the Memory Module.....	26
Procedure.....	26
Post-requisites.....	27
Removing the Wireless Card.....	28
Prerequisites.....	28
Procedure.....	28
Replacing the Wireless Card.....	30
Procedure.....	30
Post-requisites.....	30
Removing the Keyboard.....	31
Prerequisites.....	31
Procedure.....	31
Replacing the Keyboard.....	34
Procedure.....	34
Folding the Keyboard Cables.....	34
Post-requisites.....	38

Removing the Palm Rest.....	39
Prerequisites.....	39
Procedure.....	39
Replacing the Palm Rest.....	43
Procedure.....	43
Post-requisites.....	43
Removing the Power-Button Module.....	44
Prerequisites.....	44
Procedure.....	44
Replacing the Power-Button Module.....	46
Procedure.....	46
Post-requisites.....	46
Removing the Touch Pad.....	47
Prerequisites.....	47
Procedure.....	47
Replacing the Touch Pad.....	50
Procedure.....	50
Post-requisites.....	50
Removing the Battery-Connector Board.....	51
Prerequisites.....	51
Procedure.....	51
Replacing the Battery-Connector Board.....	53
Procedure.....	53
Post-requisites.....	53

Removing the I/O Board.....	54
Prerequisites.....	54
Procedure.....	54
Replacing the I/O Board.....	56
Procedure.....	56
Post-requisites.....	56
Removing the Optical-Drive Connector Board.....	57
Prerequisites.....	57
Procedure.....	57
Replacing the Optical-Drive Connector Board.....	60
Procedure.....	60
Post-requisites.....	60
Removing the Coin-Cell Battery.....	61
Prerequisites.....	61
Procedure.....	61
Replacing the Coin-Cell Battery.....	63
Procedure.....	63
Post-requisites.....	63
Removing the Power-Adapter Port.....	64
Prerequisites.....	64
Procedure.....	64
Replacing the Power-Adapter Port.....	66
Procedure.....	66
Post-requisites.....	66

Removing the Speakers.....	67
Prerequisites.....	67
Procedure.....	67
Replacing the Speakers.....	69
Procedure.....	69
Post-requisites.....	69
Removing the System Board.....	70
Prerequisites.....	70
Procedure.....	70
Replacing the System Board.....	73
Procedure.....	73
Post-requisites.....	73
Removing the Heat-Sink Assembly.....	75
Prerequisites.....	75
Procedure.....	75
Replacing the Heat-Sink Assembly.....	77
Procedure.....	77
Post-requisites.....	77
Removing the Display Assembly.....	78
Prerequisites.....	78
Procedure.....	78
Replacing the Display Assembly.....	82
Procedure.....	82
Post-requisites.....	82

Removing the Display Bezel.....	84
Prerequisites.....	84
Procedure.....	84
Replacing the Display Bezel.....	86
Procedure.....	86
Post-requisites.....	86
Removing the Display Panel.....	87
Prerequisites.....	87
Procedure.....	87
Replacing the Display Panel.....	90
Procedure.....	90
Post-requisites.....	90
Removing the Display Hinges.....	91
Prerequisites.....	91
Procedure.....	91
Replacing the Display Hinges.....	93
Procedure.....	93
Post-requisites.....	93
Removing the Camera.....	94
Prerequisites.....	94
Procedure.....	94
Replacing the Camera.....	96
Procedure.....	96
Post-requisites.....	96
Flashing the BIOS.....	97



Getting Help and Contacting Dell.....	98
Self-Help Resources.....	98
Contacting Dell.....	98

Before Working Inside Your Computer

 **CAUTION:** To avoid damaging the components and cards, handle them by their edges and avoid touching pins and contacts.









 **NOTE:** The images in this document may differ from your computer depending on the configuration you ordered.

Before You Begin

- 1 Save and close all open files and exit all open applications.
 - 2 Shut down your computer.
 - Windows 8.1: On the **Start** screen, click or tap the power icon  → **Shut down**.
 - Windows 7: Click or tap **Start** → **Shut down** .
-  **NOTE:** If you are using a different operating system, see the documentation of your operating system for shut-down instructions.
- 3 Disconnect your computer and all attached devices from their electrical outlets.
 - 4 Disconnect all cables such as telephone cables, network cables and so on, from your computer.
 - 5 Disconnect all attached devices and peripherals, such as keyboard, mouse, monitor, and so on, from your computer.
 - 6 Remove any media card and optical disc from your computer, if applicable.

Safety Instructions

Use the following safety guidelines to protect your computer from potential damage and ensure your personal safety.

-  **WARNING:** Before working inside your computer, read the safety information that shipped with your computer. For more safety best practices, see the Regulatory Compliance home page at dell.com/regulatory_compliance.
-  **WARNING:** Disconnect all power sources before opening the computer cover or panels. After you finish working inside the computer, replace all covers, panels, and screws before connecting to the power source.
-  **CAUTION:** To avoid damaging the computer, make sure that the work surface is flat and clean.
-  **CAUTION:** To avoid damaging the components and cards, handle them by their edges and avoid touching pins and contacts.
-  **CAUTION:** You should only perform troubleshooting and repairs as authorized or directed by the Dell technical assistance team. Damage due to servicing that is not authorized by Dell is not covered by your warranty. See the safety instructions that shipped with the product or at dell.com/regulatory_compliance.
-  **CAUTION:** Before touching anything inside your computer, ground yourself by touching an unpainted metal surface, such as the metal at the back of the computer. While you work, periodically touch an unpainted metal surface to dissipate static electricity, which could harm internal components.
-  **CAUTION:** When you disconnect a cable, pull on its connector or on its pull-tab, not on the cable itself. Some cables have connectors with locking tabs or thumb-screws that you must disengage before disconnecting the cable. When disconnecting cables, keep them evenly aligned to avoid bending any connector pins. When connecting cables, make sure that the ports and connectors are correctly oriented and aligned.
-  **CAUTION:** To disconnect a network cable, first unplug the cable from your computer and then unplug the cable from the network device.
-  **CAUTION:** Press and eject any installed card from the media-card reader.

Recommended Tools

The procedures in this document may require the following tools:

- Philips screwdriver
- Plastic scribe

After Working Inside Your Computer



CAUTION: Leaving stray or loose screws inside your computer may severely damage your computer.

- 1 Replace all screws and make sure that no stray screws remain inside your computer.
- 2 Connect any external devices, peripherals, and cables you removed before working on your computer.
- 3 Replace any media cards, discs, and any other part(s) that you removed before working on your computer.
- 4 Connect your computer and all attached devices to their electrical outlets.
- 5 Turn on your computer.

Removing the Battery

⚠ WARNING: Before working inside your computer, read the safety information that shipped with your computer and follow the steps in [Before Working Inside Your Computer](#). After working inside your computer, follow the instructions in [After Working Inside Your Computer](#). For more safety best practices, see the Regulatory Compliance home page at dell.com/regulatory_compliance.

Procedure

- 1 Close the display and turn the computer over.
- 2 Slide the battery-release latches to the unlock position.

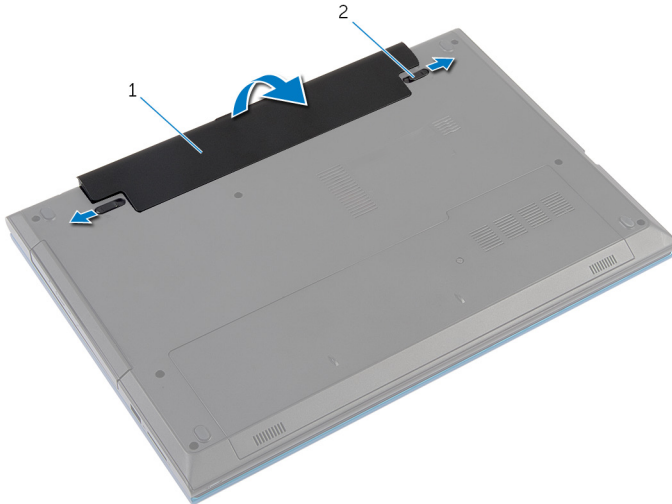

1 battery

2 battery-release latches (2)

- 3 Using your fingertips, lift the battery at an angle and remove the battery off the battery bay.
- 4 Turn the computer over and open the display as far as possible.
- 5 Press and hold the power button for 5 seconds after the computer is unplugged to ground the system board.

Replacing the Battery

 **WARNING:** Before working inside your computer, read the safety information that shipped with your computer and follow the steps in [Before Working Inside Your Computer](#). After working inside your computer, follow the instructions in [After Working Inside Your Computer](#). For more safety best practices, see the Regulatory Compliance home page at dell.com/regulatory_compliance.

Procedure

- 1 Slide the tabs on the battery into the slots on the battery bay and snap the battery into place.
 -  **NOTE:** Make sure the battery-release latches are secured.
- 2 Turn the computer over and open the display as far as possible.

Removing the Base Cover

 **WARNING:** Before working inside your computer, read the safety information that shipped with your computer and follow the steps in [Before Working Inside Your Computer](#). After working inside your computer, follow the instructions in [After Working Inside Your Computer](#). For more safety best practices, see the Regulatory Compliance home page at dell.com/regulatory_compliance.

Prerequisites

Remove the [battery](#).

Procedure

- 1 Remove the screw that secures the base cover to the computer base.
- 2 Slide the base cover to release the tabs on the base cover from the slots on the computer base.
- 3 Lift the base cover out of the computer base.

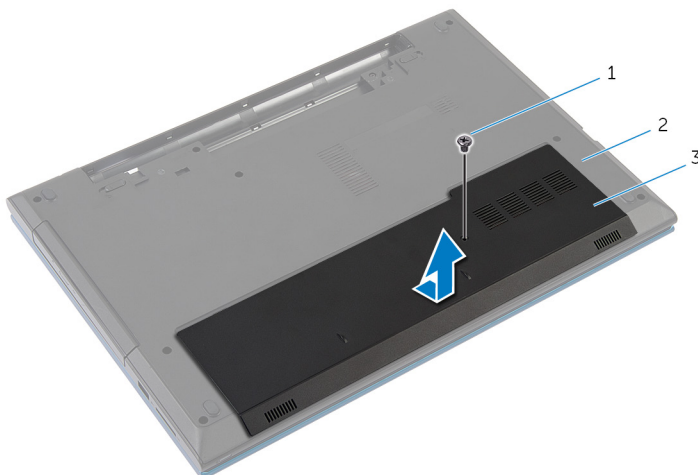

1 screw

2 computer base

3 base cover

Replacing the Base Cover



WARNING: Before working inside your computer, read the safety information that shipped with your computer and follow the steps in [Before Working Inside Your Computer](#). After working inside your computer, follow the instructions in [After Working Inside Your Computer](#). For more safety best practices, see the Regulatory Compliance home page at dell.com/regulatory_compliance.

Procedure

- 1 Slide the tabs on the base cover into the slots on the computer base and snap the base cover into place.
- 2 Replace the screw that secures the base cover to the computer base.

Post-requisites

Replace the [battery](#).

Removing the Optical Drive

! **WARNING:** Before working inside your computer, read the safety information that shipped with your computer and follow the steps in [Before Working Inside Your Computer](#). After working inside your computer, follow the instructions in [After Working Inside Your Computer](#). For more safety best practices, see the Regulatory Compliance home page at dell.com/regulatory_compliance.

Prerequisites

Remove the [battery](#).

Procedure

- 1 Remove the screw that secures the optical-drive assembly to the computer base.
- 2 Using your fingertips, slide the optical-drive assembly out of the optical-drive bay.

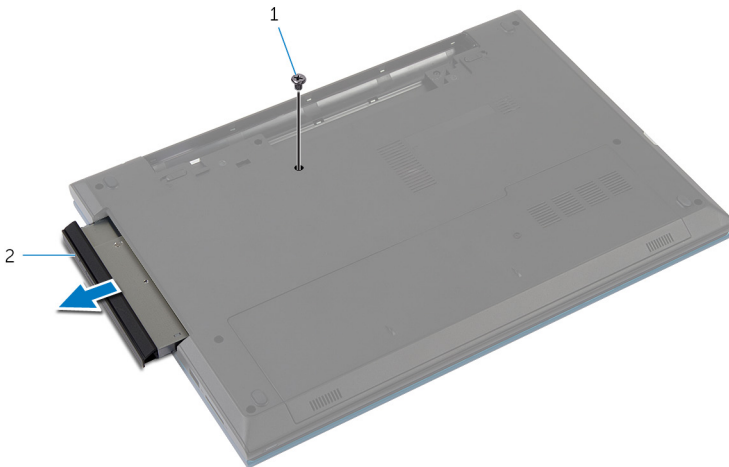

1 screw

2 optical-drive assembly

- 3 Remove the screw that secures the optical-drive bracket to the optical-drive assembly.

- 4 Remove the optical-drive bracket from the optical-drive assembly.
- 5 Carefully pry the optical-drive bezel and remove it from the optical drive.

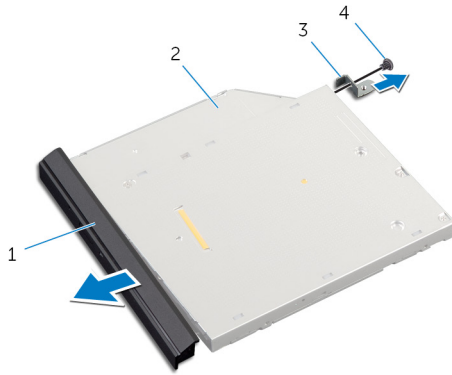

- | | | | |
|---|-----------------------|---|---------------|
| 1 | optical-drive bezel | 2 | optical drive |
| 3 | optical-drive bracket | 4 | screw |

Replacing the Optical Drive



WARNING: Before working inside your computer, read the safety information that shipped with your computer and follow the steps in [Before Working Inside Your Computer](#). After working inside your computer, follow the instructions in [After Working Inside Your Computer](#). For more safety best practices, see the Regulatory Compliance home page at dell.com/regulatory_compliance.



Procedure

- 1 Align the tabs on the optical-drive bezel with the slots on the optical drive and snap the optical-drive bezel into place.
- 2 Align the screw hole on the optical-drive bracket with the screw hole on the optical-drive assembly.
- 3 Replace the screw that secures the optical-drive bracket to the optical-drive assembly.
- 4 Slide the optical-drive assembly into the optical-drive bay and align the screw hole on the optical-drive bracket with the screw hole on computer base.
- 5 Replace the screw that secures the optical-drive assembly to the computer base.

Post-requisites

Replace the [battery](#).

Removing the Hard Drive

-  **WARNING:** Before working inside your computer, read the safety information that shipped with your computer and follow the steps in [Before Working Inside Your Computer](#). After working inside your computer, follow the instructions in [After Working Inside Your Computer](#). For more safety best practices, see the Regulatory Compliance home page at dell.com/regulatory_compliance.
-  **CAUTION:** Hard drives are fragile. Exercise care when handling the hard drive.
-  **CAUTION:** To avoid data loss, do not remove the hard drive while the computer is in sleep or on state.

Prerequisites

- 1 Remove the [battery](#).
- 2 Remove the [base cover](#).

Procedure

- 1 Remove the screw that secures the hard-drive assembly to the computer base.
- 2 Using the pull tab, slide the hard-drive assembly to disconnect it from the system board.

3 Lift the hard-drive assembly out of the computer base.

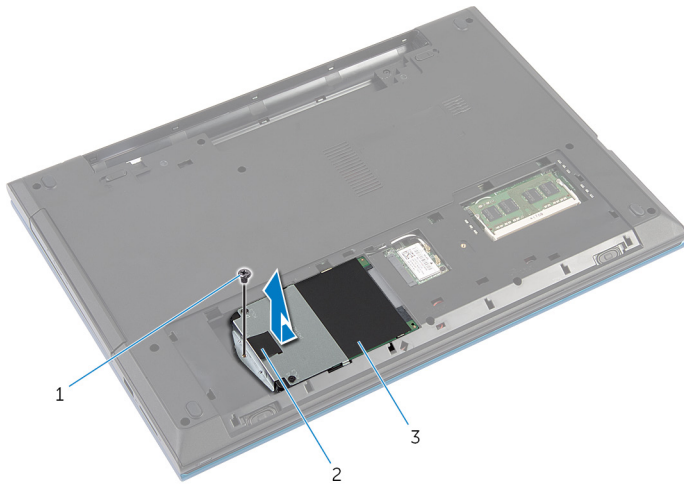

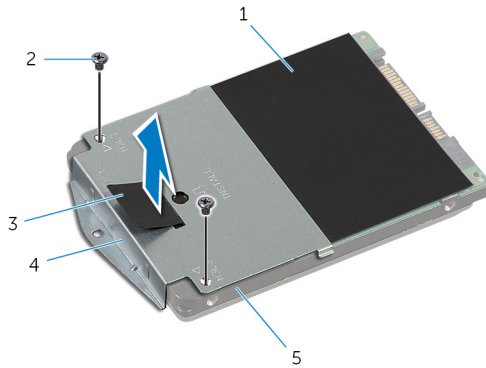

- 1 screw
- 2 pull tab
- 3 hard-drive assembly

4 Remove the screws that secure the hard-drive bracket to the hard drive.
5 Using the pull tab, lift the hard-drive bracket and peel the Mylar sheet off the hard drive.



- 1 Mylar sheet
- 2 screws (2)
- 3 pull tab
- 4 hard-drive bracket
- 5 hard drive

Replacing the Hard Drive

-  **WARNING:** Before working inside your computer, read the safety information that shipped with your computer and follow the steps in [Before Working Inside Your Computer](#). After working inside your computer, follow the instructions in [After Working Inside Your Computer](#). For more safety best practices, see the Regulatory Compliance home page at dell.com/regulatory_compliance.
-  **CAUTION:** Hard drives are fragile. Exercise care when handling the hard drive.

Procedure

- 1 Adhere the Mylar sheet to the hard drive.
- 2 Align the screw holes on the hard-drive bracket with the screw holes on the hard drive.
- 3 Replace the screws that secure the hard-drive bracket to the hard drive.
- 4 Place the hard-drive assembly on the computer base.
- 5 Slide the hard-drive assembly to secure the hard-drive connector with the system-board connector.
- 6 Replace the screw that secures the hard-drive assembly to the computer base.

Post-requisites

- 1 Replace the [base cover](#).
- 2 Replace the [battery](#).

Removing the Memory Module



WARNING: Before working inside your computer, read the safety information that shipped with your computer and follow the steps in [Before Working Inside Your Computer](#). After working inside your computer, follow the instructions in [After Working Inside Your Computer](#). For more safety best practices, see the Regulatory Compliance home page at dell.com/regulatory_compliance.

Prerequisites

- 1 Remove the [battery](#).
- 2 Remove the [base cover](#).

Procedure

- 1 Using your fingertips, pry apart the securing clips on each end of the memory-module slot until the memory module pops up.

- 2 Slide and remove the memory module from the memory-module slot.

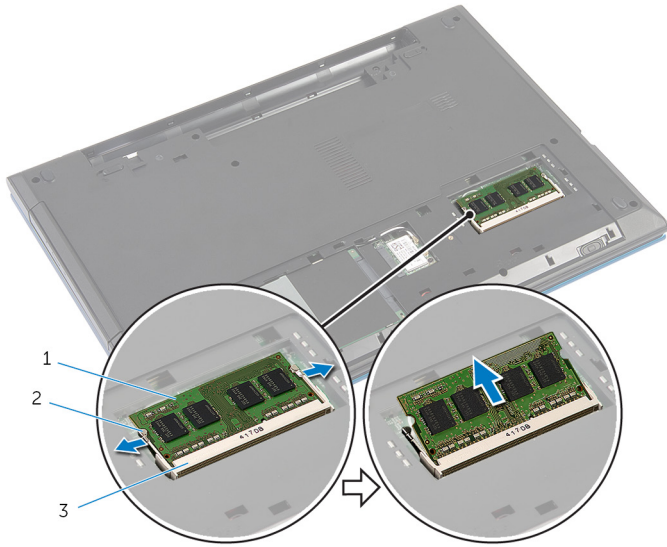

- 1 memory module
2 securing clips (2)
3 memory-module slot

- 2 securing clips (2)

Replacing the Memory Module



WARNING: Before working inside your computer, read the safety information that shipped with your computer and follow the steps in [Before Working Inside Your Computer](#). After working inside your computer, follow the instructions in [After Working Inside Your Computer](#). For more safety best practices, see the Regulatory Compliance home page at dell.com/regulatory_compliance.

Procedure

- 1 Align the notch on the memory module with the tab on the memory-module slot.

- Slide the memory module into the slot at an angle and press the memory module down until it clicks into place.

 **NOTE:** If you do not hear the click, remove the memory module and reinstall it.

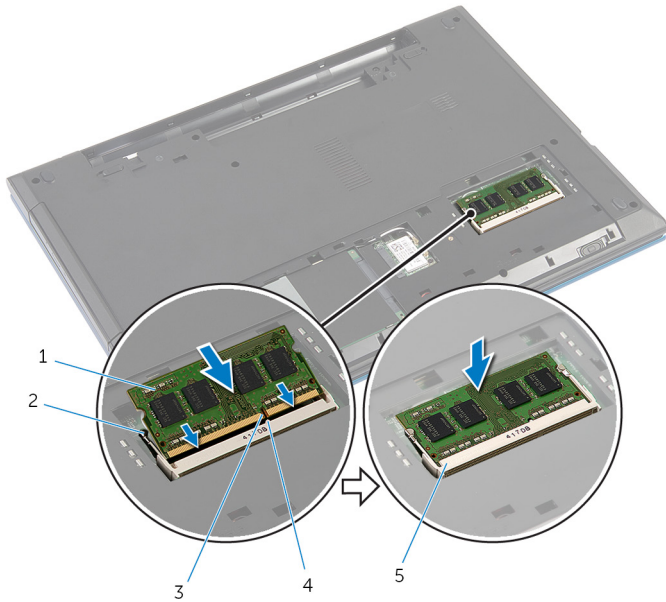

1 memory module

3 notch

5 memory-module slot

2 securing clips (2)

4 tab

Post-requisites

- Replace the [base cover](#).
- Replace the [battery](#).

Removing the Wireless Card



WARNING: Before working inside your computer, read the safety information that shipped with your computer and follow the steps in [Before Working Inside Your Computer](#). After working inside your computer, follow the instructions in [After Working Inside Your Computer](#). For more safety best practices, see the Regulatory Compliance home page at dell.com/regulatory_compliance.

Prerequisites

- 1 Remove the [battery](#).
- 2 Remove the [base cover](#).

Procedure

- 1 Disconnect the antenna cables from the wireless card.
- 2 Remove the screw that secures the wireless card to the computer base.

3 Slide the wireless card out of the wireless-card slot.

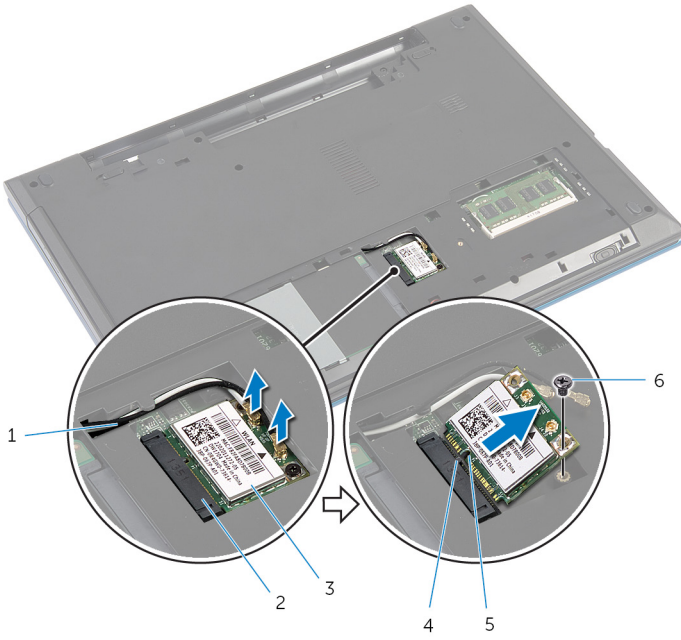

1 antenna cables (2)

3 wireless card

5 notch

2 wireless-card slot

4 tab

6 screw

Replacing the Wireless Card



WARNING: Before working inside your computer, read the safety information that shipped with your computer and follow the steps in [Before Working Inside Your Computer](#). After working inside your computer, follow the instructions in [After Working Inside Your Computer](#). For more safety best practices, see the Regulatory Compliance home page at dell.com/regulatory_compliance.

Procedure

- 1 Align the notch on the wireless card with the tab on the wireless-card slot.
- 2 Insert the wireless card at an angle into the slot.
- 3 Press the other end of the wireless card down and replace the screw that secures the wireless card to the computer base.
- 4 Connect the antenna cables to the wireless card.

The following table provides the antenna cable color schemes for the wireless card supported by your computer.

Connectors on the wireless card	Antenna-cable color
Main (white triangle)	White
Auxiliary (black triangle)	Black

Post-requisites

- 1 Replace the [base cover](#).
- 2 Replace the [battery](#).

Removing the Keyboard



WARNING: Before working inside your computer, read the safety information that shipped with your computer and follow the steps in [Before Working Inside Your Computer](#). After working inside your computer, follow the instructions in [After Working Inside Your Computer](#). For more safety best practices, see the Regulatory Compliance home page at dell.com/regulatory_compliance.

Prerequisites

Remove the [battery](#).

Procedure

- 1 Turn the computer over and open the display as far as possible.
- 2 Using a plastic scribe, release the tabs that secure the keyboard to the palm rest.

- Carefully turn the keyboard over and place it on the palm rest.

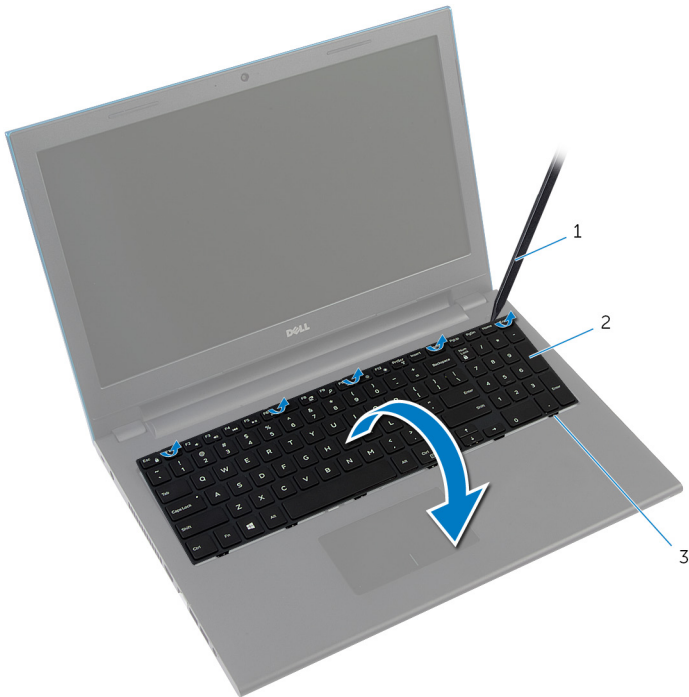

- | | | | |
|---|----------------|---|----------|
| 1 | plastic scribe | 2 | keyboard |
| 3 | tabs (6) | | |

- Lift the connector latches and disconnect the keyboard cable and keyboard-backlight cable (optional) from the system board.



NOTE: Keyboard-backlight cable is present only on a backlit-keyboard.

5 Lift the keyboard along with the cables off the palm rest.

 **NOTE:** If you are installing a new keyboard, make sure to note the folding of the keyboard cable and keyboard-backlight cable (optional).

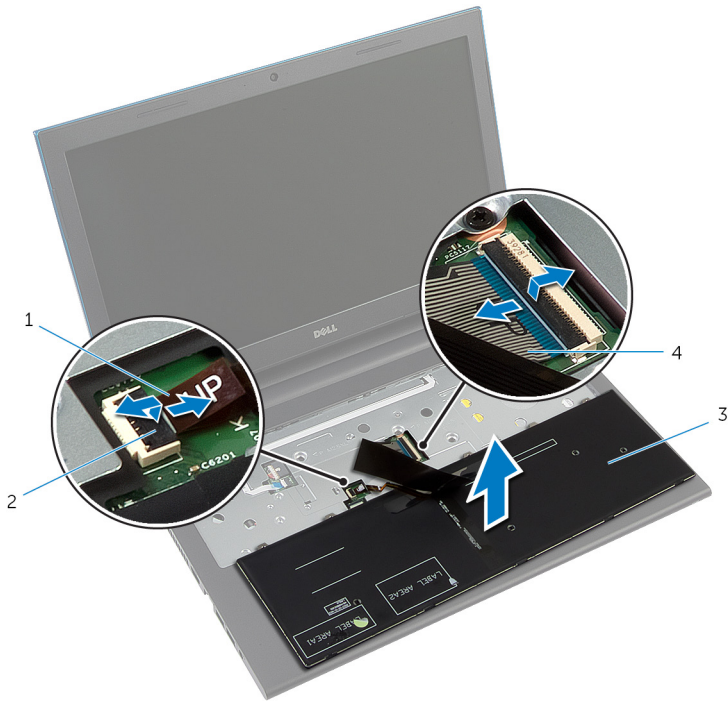

1 keyboard-backlight cable (optional)

2 connector latch

3 keyboard

4 keyboard cable

Replacing the Keyboard

 **WARNING:** Before working inside your computer, read the safety information that shipped with your computer and follow the steps in [Before Working Inside Your Computer](#). After working inside your computer, follow the instructions in [After Working Inside Your Computer](#). For more safety best practices, see the Regulatory Compliance home page at dell.com/regulatory_compliance.

Procedure

- 1 Slide the keyboard cable and keyboard-backlight cable (optional) into the system-board connectors and press down on the connector latches to secure the cables.
 -  **NOTE:** If you are installing a new keyboard, fold the cables the same way they are folded on the old keyboard. For more information, see "[Folding the Keyboard Cables](#)".
- 2 Carefully turn the keyboard over, slide the tabs on the keyboard into the slots on the palm rest, and snap the keyboard into place.
- 3 Close the display and turn the computer over.

Folding the Keyboard Cables

 **CAUTION:** Do not apply excess pressure while folding the cables.

The cables on the keyboard are not folded when you receive a replacement keyboard. Follow these instructions to fold the cables on the replacement keyboard the same way they are folded on the old keyboard.



NOTE: Keyboard-backlight cable is present only on a backlit-keyboard.

- 1 Place the keyboard on a flat and clean surface.

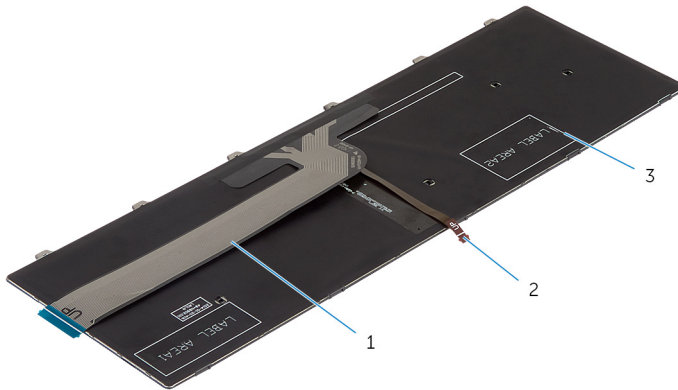

1 keyboard cable

2 keyboard-backlight cable

3 keyboard



CAUTION: Do not apply excess pressure while folding the cables.

2 Lift the keyboard cable and gently fold the keyboard-backlight cable at the fold line.

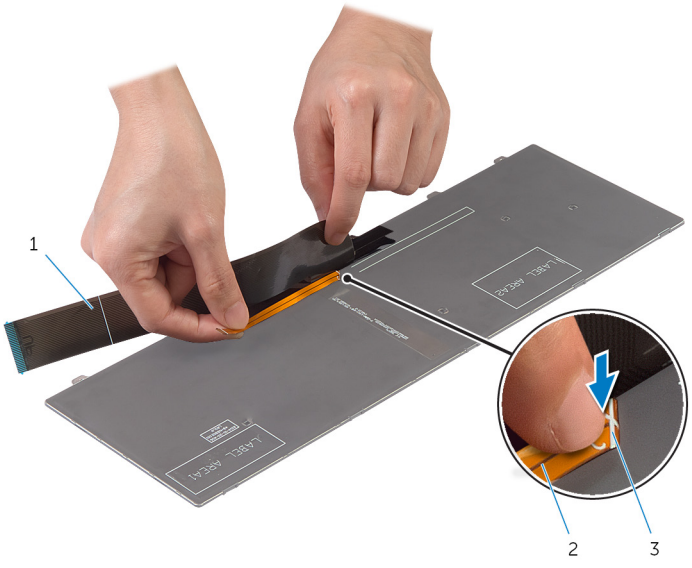

1 keyboard cable
3 fold line

2 keyboard-backlight cable

3 Using the alignment line, gently fold the keyboard cable.

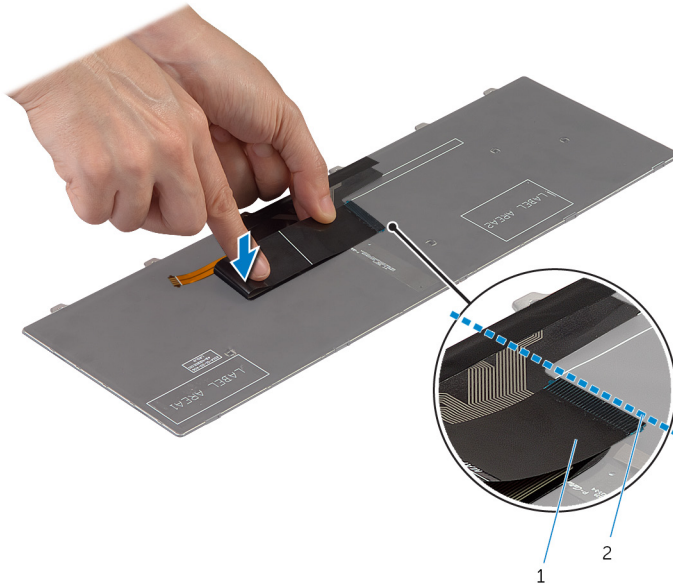

1 keyboard cable

2 alignment line

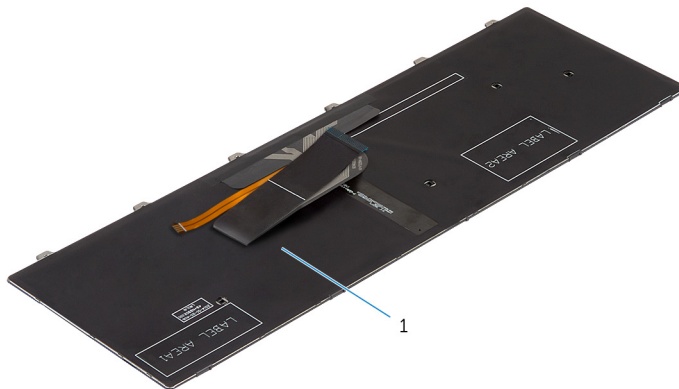

1 keyboard

Post-requisites

Replace the [battery](#).

Removing the Palm Rest



WARNING: Before working inside your computer, read the safety information that shipped with your computer and follow the steps in [Before Working Inside Your Computer](#). After working inside your computer, follow the instructions in [After Working Inside Your Computer](#). For more safety best practices, see the Regulatory Compliance home page at dell.com/regulatory_compliance.

Prerequisites

- 1 Remove the [battery](#).
- 2 Remove the [base cover](#).
- 3 Follow the procedure from step 1 to step 3 in “Removing the [Hard Drive](#)”.
- 4 Remove the [keyboard](#).

Procedure

- 1 Remove the screws that secure the palm rest to the computer base.

- 2** Lift the connector latches and using the pull tabs, disconnect the touch-pad cable and power-button board cable from the system board.



- | | | | |
|---|--------------------------|---|-----------------|
| 1 | power-button board cable | 2 | connector latch |
| 3 | touch-pad cable | 4 | screws (3) |

- 3** Close the display and turn the computer over.

- 4 Remove the screws that secure the palm rest to the computer base.

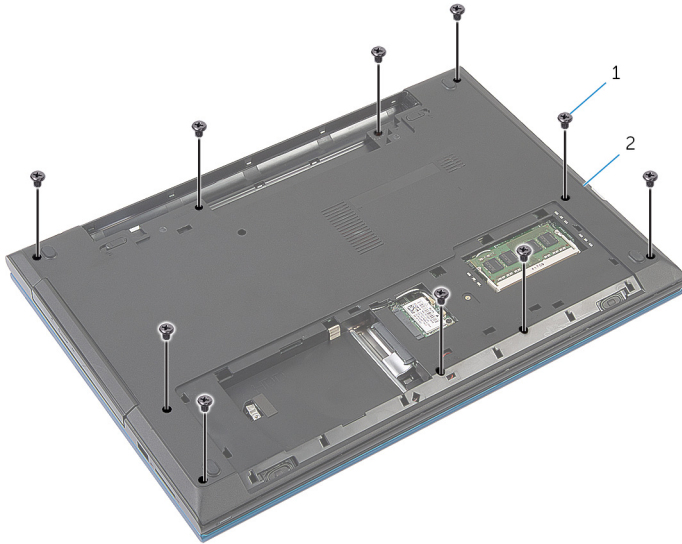

1 screws (10)

2 computer base

- 5 Using a plastic scribe, gently release the tabs on the palm rest from the slots on the computer base.



1 computer base

2 palm rest

- 6 Turn the computer over and open the display as far as possible.

- 7 Lift the palm rest at an angle and release it from the ports on the system board.



1 palm rest

- 8 Follow the procedure from step 1 to step 7 in “Removing the [Power-Button Module](#)”.
- 9 Follow the procedure from step 1 to step 5 in “Removing the [Touch Pad](#)”.

Replacing the Palm Rest



WARNING: Before working inside your computer, read the safety information that shipped with your computer and follow the steps in [Before Working Inside Your Computer](#). After working inside your computer, follow the instructions in [After Working Inside Your Computer](#). For more safety best practices, see the Regulatory Compliance home page at dell.com/regulatory_compliance.

Procedure

- 1 Follow the procedure from step 1 to step 4 in “Replacing the [Touch Pad](#)”.
- 2 Follow the procedure from step 1 to step 7 in “Replacing the [Power-Button Module](#)”.
- 3 Slide the slots on the palm rest into the ports on the system board and place the palm rest on the computer base.
- 4 Press down on the palm rest to snap it into place.
- 5 Replace the screws that secure the palm rest to the computer base.
- 6 Slide the touch-pad cable and the power-button board cable into the system-board connectors and press down on the connector latches to secure the cables.
- 7 Close the display and turn the computer over.
- 8 Replace the screws that secure the palm rest to the computer base.
- 9 Turn the computer over and open the display as far as possible.

Post-requisites

- 1 Replace the [keyboard](#).
- 2 Follow the procedure from step 4 to step 6 in “Replacing the [Hard Drive](#)”.
- 3 Replace the [base cover](#).
- 4 Replace the [battery](#).

Removing the Power-Button Module



WARNING: Before working inside your computer, read the safety information that shipped with your computer and follow the steps in [Before Working Inside Your Computer](#). After working inside your computer, follow the instructions in [After Working Inside Your Computer](#). For more safety best practices, see the Regulatory Compliance home page at dell.com/regulatory_compliance.

Prerequisites

- 1 Remove the [battery](#).
- 2 Remove the [base cover](#).
- 3 Follow the procedure from step 1 to step 3 in “Removing the [Hard Drive](#)”.
- 4 Remove the [keyboard](#).
- 5 Follow the procedure from step 1 to step 7 in “Removing the [Palm Rest](#)”.

Procedure

- 1 Peel off the power-button board cable from the palm rest.
- 2 Turn the palm rest over and place it on a clean and flat surface.
- 3 Remove the power-button board cable through the slot on the palm rest.
- 4 Peel off the tape that secures the power-button board to the palm rest.
- 5 Remove the screw that secures the power-button board to the palm rest.
- 6 Note the power-button board cable routing and peel it off the palm rest.

- 7 Lift the power-button board at an angle and remove it from under the tab on the palm rest.

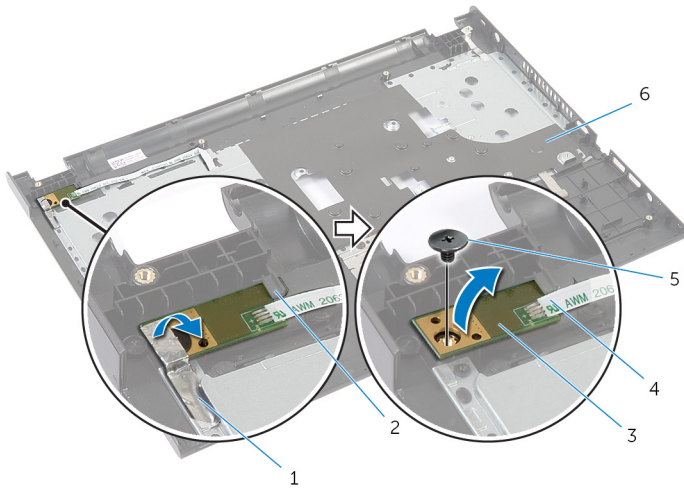

- | | | | |
|---|--------------------|---|--------------------------|
| 1 | tape | 2 | tab |
| 3 | power-button board | 4 | power-button board cable |
| 5 | screw | 6 | palm rest |

Replacing the Power-Button Module



WARNING: Before working inside your computer, read the safety information that shipped with your computer and follow the steps in [Before Working Inside Your Computer](#). After working inside your computer, follow the instructions in [After Working Inside Your Computer](#). For more safety best practices, see the Regulatory Compliance home page at dell.com/regulatory_compliance.

Procedure

- 1 Slide the power-button board under the tab on the palm rest and align the screw hole on the power-button board with the screw hole on the palm rest.
- 2 Replace the screw that secures the power-button board to the palm rest.
- 3 Adhere the tape that secures the power-button board to the palm rest.
- 4 Adhere the power-button board cable to the palm rest.
- 5 Slide the power-button board cable through the slot on the palm rest.
- 6 Turn the palm rest over.
- 7 Adhere the power-button board cable to the palm rest.

Post-requisites

- 1 Follow the procedure from step 3 to step 9 in “Replacing the [Palm Rest](#)”.
- 2 Replace the [keyboard](#).
- 3 Follow the procedure from step 4 to step 6 in “Replacing the [Hard Drive](#)”.
- 4 Replace the [base cover](#).
- 5 Replace the [battery](#).

Removing the Touch Pad



WARNING: Before working inside your computer, read the safety information that shipped with your computer and follow the steps in [Before Working Inside Your Computer](#). After working inside your computer, follow the instructions in [After Working Inside Your Computer](#). For more safety best practices, see the Regulatory Compliance home page at dell.com/regulatory_compliance.

Prerequisites

- 1 Remove the [battery](#).
- 2 Remove the [base cover](#).
- 3 Follow the procedure from step 1 to step 3 in “Removing the [Hard Drive](#)”.
- 4 Remove the [keyboard](#).
- 5 Follow the procedure from step 1 to step 7 in “Removing the [Palm Rest](#)”.

Procedure

- 1 Turn the palm rest over and keep it on a clean and flat surface.
- 2 Lift the connector latch and disconnect the touch-pad cable from the touch pad.

3 Remove the screws that secure the touch pad to the palm rest.

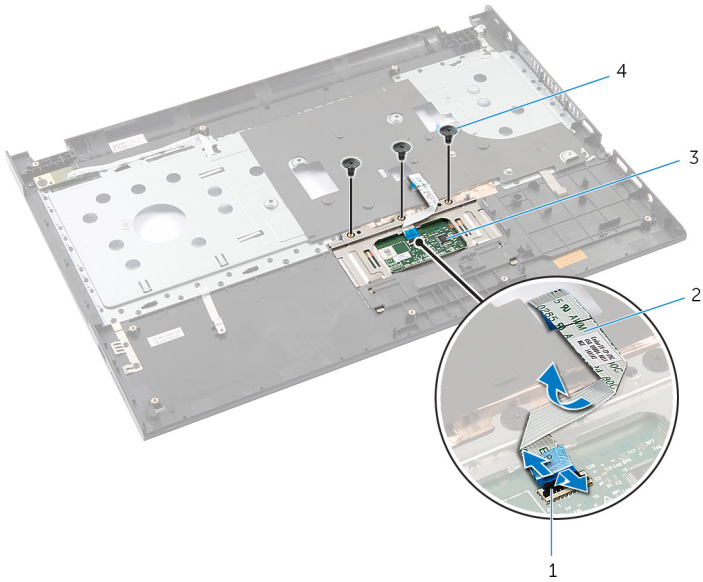

1 connector latch

2 touch-pad cable

3 touch pad

4 screws (3)

4 Using your fingertips, release the touch pad from under the palm rest.

- 5 Slide and remove the touch pad out of the palm rest.

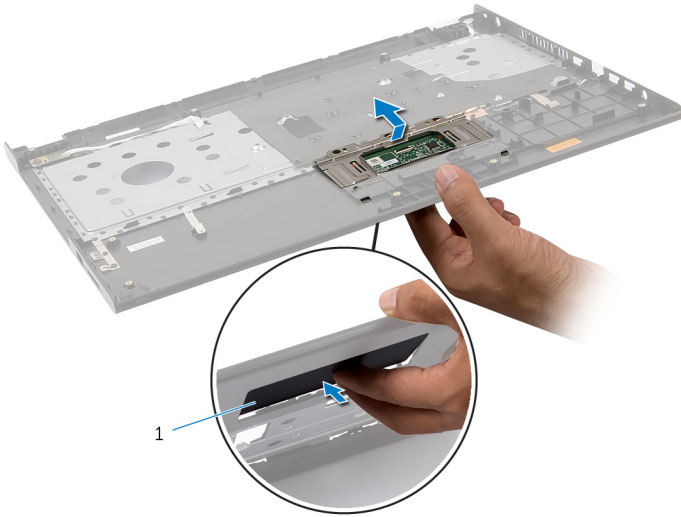

1 touch pad

Replacing the Touch Pad



WARNING: Before working inside your computer, read the safety information that shipped with your computer and follow the steps in [Before Working Inside Your Computer](#). After working inside your computer, follow the instructions in [After Working Inside Your Computer](#). For more safety best practices, see the Regulatory Compliance home page at dell.com/regulatory_compliance.

Procedure

- 1 Slide the tabs on the touch pad into the slots on the palm rest.
- 2 Replace the screws that secure the touch pad to the palm rest.
- 3 Slide the touch-pad cable into the touch-pad connector and press down on the connector latch to secure the cable.
- 4 Turn the palm rest over.

Post-requisites

- 1 Follow the procedure from step 3 to step 9 in “Replacing the [Palm Rest](#)”.
- 2 Replace the [keyboard](#).
- 3 Follow the procedure from step 4 to step 6 in “Replacing the [Hard Drive](#)”.
- 4 Replace the [base cover](#).
- 5 Replace the [battery](#).

Removing the Battery-Connector Board



WARNING: Before working inside your computer, read the safety information that shipped with your computer and follow the steps in [Before Working Inside Your Computer](#). After working inside your computer, follow the instructions in [After Working Inside Your Computer](#). For more safety best practices, see the Regulatory Compliance home page at dell.com/regulatory_compliance.

Prerequisites

- 1 Remove the [battery](#).
- 2 Remove the [base cover](#).
- 3 Follow the procedure from step 1 to step 3 in “Removing the [Hard Drive](#)”.
- 4 Remove the [keyboard](#).
- 5 Follow the procedure from step 1 to step 7 in “Removing the [Palm Rest](#)”.

Procedure

- 1 Remove the screws that secure the battery-connector board to the computer base.

2 Carefully lift the battery-connector board to disconnect it from the system board.



1 battery-connector board

2 screws (2)

Replacing the Battery-Connector Board

 **WARNING:** Before working inside your computer, read the safety information that shipped with your computer and follow the steps in [Before Working Inside Your Computer](#). After working inside your computer, follow the instructions in [After Working Inside Your Computer](#). For more safety best practices, see the Regulatory Compliance home page at dell.com/regulatory_compliance.

Procedure

- 1 Connect the battery-connector board to the system-board connector.
- 2 Replace the screws that secure the battery-connector board to the computer base.

Post-requisites

- 1 Follow the procedure from step 3 to step 9 in “Replacing the [Palm Rest](#)”.
- 2 Replace the [keyboard](#).
- 3 Follow the procedure from step 4 to step 6 in “Replacing the [Hard Drive](#)”.
- 4 Replace the [base cover](#).
- 5 Replace the [battery](#).

Removing the I/O Board



WARNING: Before working inside your computer, read the safety information that shipped with your computer and follow the steps in [Before Working Inside Your Computer](#). After working inside your computer, follow the instructions in [After Working Inside Your Computer](#). For more safety best practices, see the Regulatory Compliance home page at dell.com/regulatory_compliance.

Prerequisites

- 1 Remove the [battery](#).
- 2 Remove the [base cover](#).
- 3 Follow the procedure from step 1 to step 3 in “Removing the [Hard Drive](#)”.
- 4 Remove the [keyboard](#).
- 5 Follow the procedure from step 1 to step 7 in “Removing the [Palm Rest](#)”.

Procedure

- 1 Release the tab that secures the I/O board to the computer base and turn the I/O board over.
- 2 Lift the connector latch and using the pull tab, disconnect the I/O-board cable from the I/O board.

3 Lift the I/O board off the computer base.

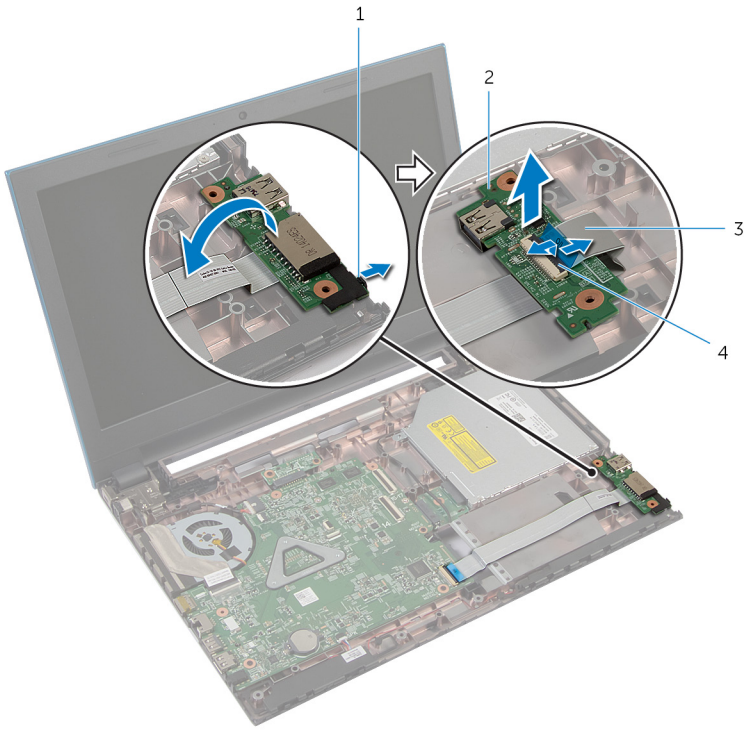

1 tab

2 I/O board

3 I/O-board cable

4 connector latch

Replacing the I/O Board



WARNING: Before working inside your computer, read the safety information that shipped with your computer and follow the steps in [Before Working Inside Your Computer](#). After working inside your computer, follow the instructions in [After Working Inside Your Computer](#). For more safety best practices, see the Regulatory Compliance home page at dell.com/regulatory_compliance.

Procedure

- 1 Slide the I/O-board cable into the I/O-board connector and press down on the connector latch to secure the cable.
- 2 Turn the I/O board over and snap the I/O board into place.

Post-requisites

- 1 Follow the procedure from step 3 to step 9 in "Replacing the [Palm Rest](#)".
- 2 Replace the [keyboard](#).
- 3 Follow the procedure from step 4 to step 6 in "Replacing the [Hard Drive](#)".
- 4 Replace the [base cover](#).
- 5 Replace the [battery](#).

Removing the Optical-Drive Connector Board

 **WARNING:** Before working inside your computer, read the safety information that shipped with your computer and follow the steps in [Before Working Inside Your Computer](#). After working inside your computer, follow the instructions in [After Working Inside Your Computer](#). For more safety best practices, see the Regulatory Compliance home page at dell.com/regulatory_compliance.

Prerequisites

- 1 Remove the [battery](#).
- 2 Remove the [base cover](#).
- 3 Follow the procedure from step 1 to step 3 in “Removing the [Hard Drive](#)”.
- 4 Follow the procedure from step 1 to step 2 in “Removing the [Optical Drive](#)”.
- 5 Remove the [keyboard](#).
- 6 Follow the procedure from step 1 to step 7 in “Removing the [Palm Rest](#)”.

Procedure

- 1 Close the display and turn the computer over.

- 2 Disconnect the antenna cables from the wireless card and remove the cables from the routing guide on the computer base.

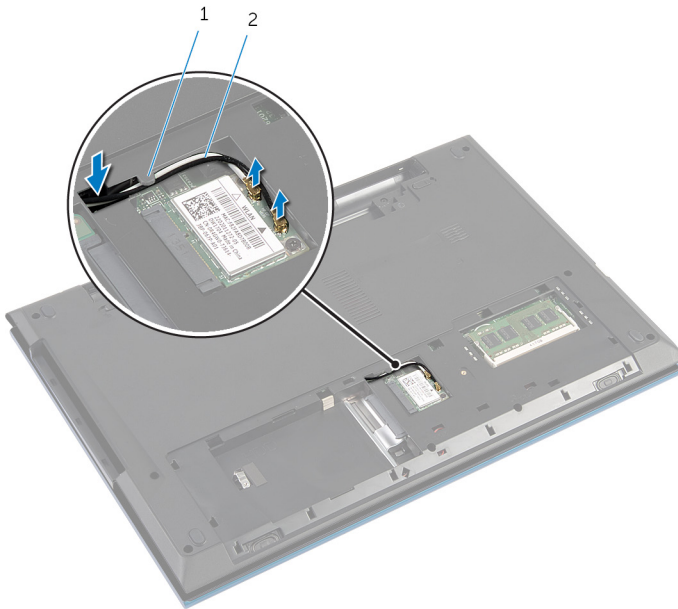

1 routing guide

2 antenna cables (2)

- 3 Turn the computer over and open the display as far as possible.
- 4 Remove the antenna cables from the slot on the computer base and remove the cables from the optical-drive connector board.
- 5 Remove the screw that secures the optical-drive connector board to the computer base.
- 6 Slide the optical-drive connector board to disconnect it from the system board.

7 Lift the optical-drive connector board off the computer base.

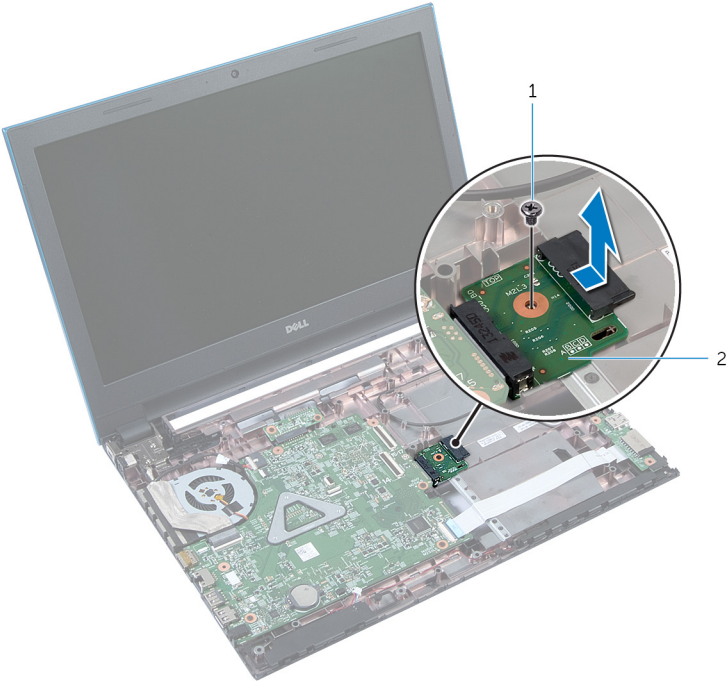

1 screw

2 optical-drive connector board

Replacing the Optical-Drive Connector Board

 **WARNING:** Before working inside your computer, read the safety information that shipped with your computer and follow the steps in [Before Working Inside Your Computer](#). After working inside your computer, follow the instructions in [After Working Inside Your Computer](#). For more safety best practices, see the Regulatory Compliance home page at dell.com/regulatory_compliance.



Procedure

- 1 Slide the optical-drive connector board into the system-board connector.
- 2 Replace the screw that secures the optical-drive connector board to the computer base.
- 3 Route the antenna cables on the optical-drive connector board and slide the cables into the slot on the computer base.
- 4 Close the display and turn the computer over.
- 5 Route the antenna cables through the routing guide on the computer base.
- 6 Connect the antenna cables to the wireless card. See “Replacing the [Wireless Card](#)”.

Post-requisites

- 1 Follow the procedure from step 3 to step 9 in “Replacing the [Palm Rest](#)”.
- 2 Replace the [keyboard](#).
- 3 Follow the procedure from step 4 to step 5 in “Replacing the [Optical Drive](#)”.
- 4 Follow the procedure from step 4 to step 6 in “Replacing the [Hard Drive](#)”.
- 5 Replace the [base cover](#).
- 6 Replace the [battery](#).

Removing the Coin-Cell Battery

-  **WARNING:** Before working inside your computer, read the safety information that shipped with your computer and follow the steps in [Before Working Inside Your Computer](#). After working inside your computer, follow the instructions in [After Working Inside Your Computer](#). For more safety best practices, see the Regulatory Compliance home page at dell.com/regulatory_compliance.
-  **CAUTION:** Removing the coin-cell battery resets the BIOS settings to default. It is recommended that you note the BIOS settings before removing the coin-cell battery.

Prerequisites

- 1 Remove the [battery](#).
- 2 Remove the [base cover](#).
- 3 Follow the procedure from step 1 to step 3 in “Removing the [Hard Drive](#)”.
- 4 Remove the [keyboard](#).
- 5 Follow the procedure from step 1 to step 7 in “Removing the [Palm Rest](#)”.

Procedure

Using a plastic scribe, gently pry out the coin-cell battery out of the battery socket on the system board.

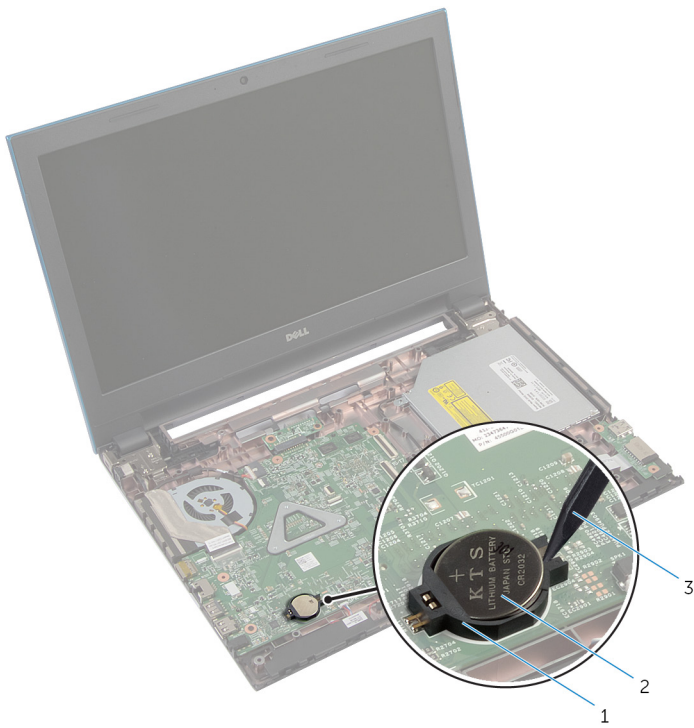

1 battery socket

2 coin-cell battery

3 plastic scribe

Replacing the Coin-Cell Battery



WARNING: Before working inside your computer, read the safety information that shipped with your computer and follow the steps in [Before Working Inside Your Computer](#). After working inside your computer, follow the instructions in [After Working Inside Your Computer](#). For more safety best practices, see the Regulatory Compliance home page at dell.com/regulatory_compliance.

Procedure

With the positive-side facing up, snap the coin-cell battery into the battery socket on the system board.

Post-requisites

- 1 Follow the procedure from step 3 to step 9 in “Replacing the [Palm Rest](#)”.
- 2 Replace the [keyboard](#).
- 3 Follow the procedure from step 4 to step 6 in “Replacing the [Hard Drive](#)”.
- 4 Replace the [battery](#).
- 5 Replace the [base cover](#).

Removing the Power-Adapter Port



WARNING: Before working inside your computer, read the safety information that shipped with your computer and follow the steps in [Before Working Inside Your Computer](#). After working inside your computer, follow the instructions in [After Working Inside Your Computer](#). For more safety best practices, see the Regulatory Compliance home page at dell.com/regulatory_compliance.

Prerequisites

- 1 Remove the [battery](#).
- 2 Remove the [base cover](#).
- 3 Follow the procedure from step 1 to step 3 in “Removing the [Hard Drive](#)”.
- 4 Remove the [keyboard](#).
- 5 Follow the procedure from step 1 to step 7 in “Removing the [Palm Rest](#)”.

Procedure

- 1 Disconnect the power-adapter port cable from the system board.
- 2 Remove the power-adapter port cable from the routing guides on the computer base.

- 3** Lift the power-adapter port along with its cable off the computer base.

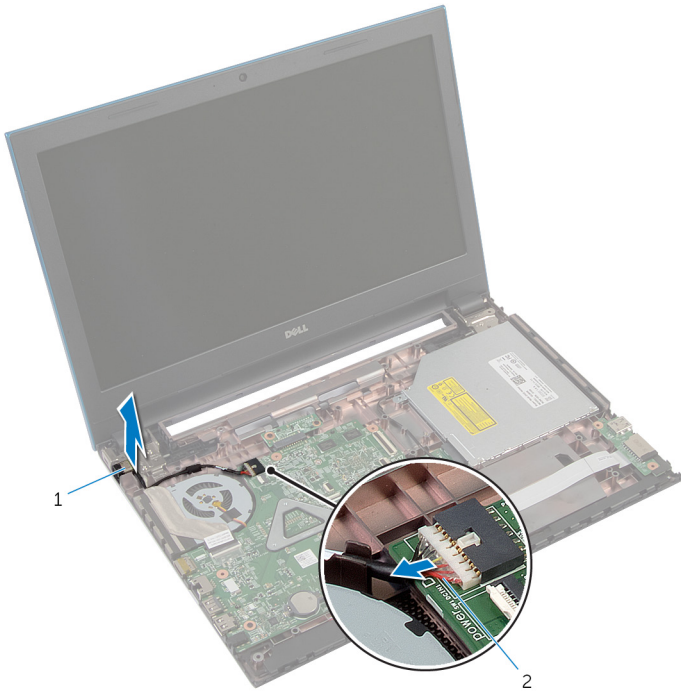

1 power-adapter port

2 power-adapter port cable

Replacing the Power-Adapter Port



WARNING: Before working inside your computer, read the safety information that shipped with your computer and follow the steps in [Before Working Inside Your Computer](#). After working inside your computer, follow the instructions in [After Working Inside Your Computer](#). For more safety best practices, see the Regulatory Compliance home page at dell.com/regulatory_compliance.

Procedure

- 1 Slide the power-adapter port into the slot on the computer base.
- 2 Route the power-adapter port cable through the routing guides on the computer base.
- 3 Connect the power-adapter port cable to the system board.

Post-requisites

- 1 Follow the procedure from step 3 to step 9 in “Replacing the [Palm Rest](#)”.
- 2 Replace the [keyboard](#).
- 3 Follow the procedure from step 4 to step 6 in “Replacing the [Hard Drive](#)”.
- 4 Replace the [base cover](#).
- 5 Replace the [battery](#).

Removing the Speakers



WARNING: Before working inside your computer, read the safety information that shipped with your computer and follow the steps in [Before Working Inside Your Computer](#). After working inside your computer, follow the instructions in [After Working Inside Your Computer](#). For more safety best practices, see the Regulatory Compliance home page at dell.com/regulatory_compliance.

Prerequisites

- 1 Remove the [battery](#).
- 2 Remove the [base cover](#).
- 3 Follow the procedure from step 1 to step 3 in “Removing the [Hard Drive](#)”.
- 4 Remove the [keyboard](#).
- 5 Follow the procedure from step 1 to step 7 in “Removing the [Palm Rest](#)”.
- 6 Remove the [I/O board](#).

Procedure

- 1 Disconnect the speaker cable from the system board.
- 2 Note the speaker-cable routing and remove the cable from the routing guides on the computer base.

3 Lift the speakers along with the speaker cable off the computer base.



1 speaker cable

2 speakers (2)

Replacing the Speakers



WARNING: Before working inside your computer, read the safety information that shipped with your computer and follow the steps in [Before Working Inside Your Computer](#). After working inside your computer, follow the instructions in [After Working Inside Your Computer](#). For more safety best practices, see the Regulatory Compliance home page at dell.com/regulatory_compliance.

Procedure

- 1 Align the speakers using the alignment posts on the computer base and snap the speakers into place.
- 2 Route the speaker cable through the routing guides on the computer base.
- 3 Connect the speaker cable to the system board.

Post-requisites

- 1 Replace the [I/O board](#).
- 2 Follow the procedure from step 3 to step 9 in "Replacing the [Palm Rest](#)".
- 3 Replace the [keyboard](#).
- 4 Follow the procedure from step 4 to step 6 in "Replacing the [Hard Drive](#)".
- 5 Replace the [base cover](#).
- 6 Replace the [battery](#).

Removing the System Board



WARNING: Before working inside your computer, read the safety information that shipped with your computer and follow the steps in [Before Working Inside Your Computer](#). After working inside your computer, follow the instructions in [After Working Inside Your Computer](#). For more safety best practices, see the Regulatory Compliance home page at dell.com/regulatory_compliance.



NOTE: Your computer's Service Tag is stored in the system board. You must enter the Service Tag in the BIOS setup program after you replace the system board.



NOTE: Replacing the system board removes any changes you have made to the BIOS using the BIOS setup program. You must make the desired changes again after you replace the system board.



NOTE: Before disconnecting the cables from the system board, note the location of the connectors so that you can reconnect them correctly after you replace the system board.

Prerequisites

- 1 Remove the [battery](#).
- 2 Remove the [base cover](#).
- 3 Remove the [memory module](#).
- 4 Follow the procedure from step 1 to step 3 in "Removing the [Hard Drive](#)".
- 5 Follow the procedure from step 1 to step 2 in "Removing the [Optical Drive](#)".
- 6 Remove the [wireless card](#).
- 7 Remove the [keyboard](#).
- 8 Follow the procedure from step 1 to step 7 in "Removing the [Palm Rest](#)".
- 9 Remove the [battery-connector board](#).
- 10 Remove the [optical-drive connector board](#).

Procedure

- 1 Peel off the tape that secures the display cable to the system board.

- 2 Lift the connector latches and disconnect the display cable and I/O-board cable from the system board.
- 3 Disconnect the power-adaptor port cable and speaker cable from the system board.

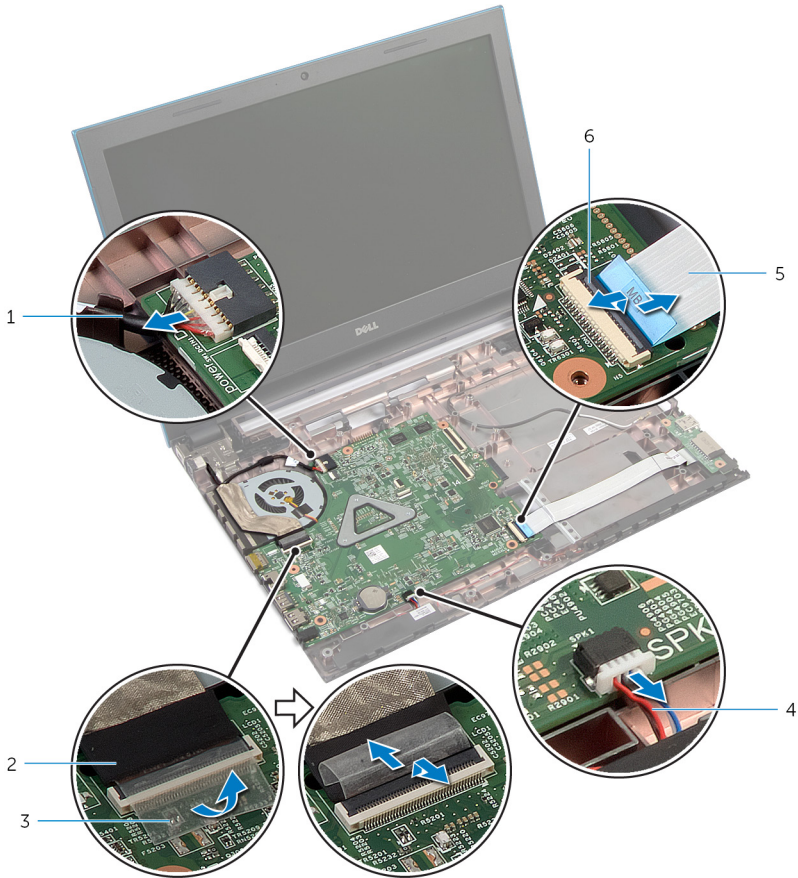

- | | | | |
|---|--------------------------|---|-----------------|
| 1 | power-adaptor port cable | 2 | display cable |
| 3 | tape | 4 | speaker cable |
| 5 | I/O-board cable | 6 | connector latch |

- 4 Remove the screws that secure the system board to the computer base.

- 5 Lift the system board off the computer base.





1 system board

2 screws (3)

- 6 Follow the procedure from step 1 to step 4 in "Removing the [Heat Sink](#)".

Replacing the System Board

 **WARNING:** Before working inside your computer, read the safety information that shipped with your computer and follow the steps in [Before Working Inside Your Computer](#). After working inside your computer, follow the instructions in [After Working Inside Your Computer](#). For more safety best practices, see the Regulatory Compliance home page at dell.com/regulatory_compliance.

 **NOTE:** Your computer's Service Tag is stored in the system board. You must enter the Service Tag in the BIOS setup program after you replace the system board.

 **NOTE:** Replacing the system board removes any changes you have made to the BIOS using the BIOS setup program. You must make the desired changes again after you replace the system board.

Procedure

- 1 Follow the procedure from step 1 to step 4 in "Replacing the [Heat Sink](#)".
- 2 Align the screw holes on the system board with the screw holes on the computer base.

 **CAUTION:** Make sure that no cables are placed under the system board.



- 3 Replace the screws that secure the system board to the computer base.
- 4 Connect the power-adaptor port cable and speaker cable to the system board.
- 5 Slide the display cable and I/O-board cable into the system-board connectors and press down on the connector latches to secure the cables.
- 6 Adhere the tape that secures the display cable to the system board.

Post-requisites

- 1 Replace the [optical-drive connector board](#).
- 2 Replace the [battery-connector board](#).
- 3 Follow the procedure from step 3 to step 9 in "Replacing the [Palm Rest](#)".
- 4 Replace the [keyboard](#).

- 5** Replace the [wireless card](#).
- 6** Follow the procedure from step 4 to step 5 in "Replacing the [Optical Drive](#)".
- 7** Follow the procedure from step 4 to step 6 in "Replacing the [Hard Drive](#)".
- 8** Replace the [memory module](#).
- 9** Replace the [base cover](#).
- 10** Replace the [battery](#).

Removing the Heat-Sink Assembly

-  **WARNING:** Before working inside your computer, read the safety information that shipped with your computer and follow the steps in [Before Working Inside Your Computer](#). After working inside your computer, follow the instructions in [After Working Inside Your Computer](#). For more safety best practices, see the Regulatory Compliance home page at dell.com/regulatory_compliance.
-  **WARNING:** The heat sink may become hot during normal operation. Allow sufficient time for the heat sink to cool before you touch it.
-  **CAUTION:** For maximum cooling of the processor, do not touch the heat transfer areas on the heat sink. The oils in your skin can reduce the heat transfer capability of the thermal grease.

Prerequisites

- 1 Remove the [battery](#).
- 2 Remove the [base cover](#).
- 3 Follow the procedure from step 1 to step 3 in “Removing the [Hard Drive](#)”.
- 4 Follow the procedure from step 1 to step 2 in “Removing the [Optical Drive](#)”.
- 5 Remove the [wireless card](#).
- 6 Remove the [keyboard](#).
- 7 Follow the procedure from step 1 to step 7 in “Removing the [Palm Rest](#)”.
- 8 Remove the [battery-connector board](#).
- 9 Remove the [optical-drive connector board](#).
- 10 Follow the procedure from step 1 to step 5 in “Removing the [System Board](#)”.

Procedure

-  **NOTE:** The heat sink may look different on your computer depending on the configuration you ordered.
- 1 Turn the system board over and place it on a flat and clean surface.

- 2 In sequential order (indicated on the heat sink), loosen the captive screws that secure the heat-sink assembly to the system board.
- 3 Disconnect the fan cable from the system board.
- 4 Lift the heat-sink assembly off the system board.

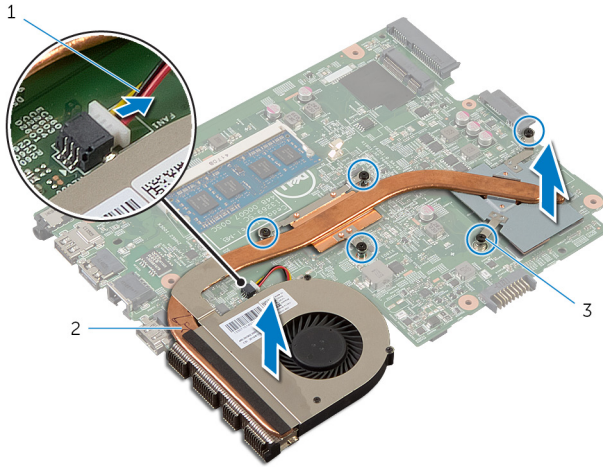

- | | | | |
|---|--------------------|---|--------------------|
| 1 | fan cable | 2 | heat-sink assembly |
| 3 | captive screws (5) | | |

Replacing the Heat-Sink Assembly

 **WARNING:** Before working inside your computer, read the safety information that shipped with your computer and follow the steps in [Before Working Inside Your Computer](#). After working inside your computer, follow the instructions in [After Working Inside Your Computer](#). For more safety best practices, see the Regulatory Compliance home page at dell.com/regulatory_compliance.

 **CAUTION:** Incorrect alignment of the heat sink can cause damage to the system board and processor.

Procedure

- 1 Align the screw holes on the heat-sink assembly with the screw holes on the system board.
- 2 In sequential order (indicated on the heat sink), tighten the captive screws that secure the heat-sink assembly to the system board.
- 3 Connect the fan cable to the system board.
- 4 Turn the system board over.

Post-requisites

- 1 Follow the procedure from step 2 to step 6 in “Replacing the [System Board](#)”.
- 2 Replace the [battery-connector board](#).
- 3 Replace the [optical-drive connector board](#).
- 4 Follow the procedure from step 3 to step 9 in “Replacing the [Palm Rest](#)”.
- 5 Replace the [keyboard](#).
- 6 Replace the [wireless card](#).
- 7 Follow the procedure from step 4 to step 5 in “Replacing the [Optical Drive](#)”.
- 8 Follow the procedure from step 4 to step 6 in “Replacing the [Hard Drive](#)”.
- 9 Replace the [base cover](#).
- 10 Replace the [battery](#).

Removing the Display Assembly



WARNING: Before working inside your computer, read the safety information that shipped with your computer and follow the steps in [Before Working Inside Your Computer](#). After working inside your computer, follow the instructions in [After Working Inside Your Computer](#). For more safety best practices, see the Regulatory Compliance home page at dell.com/regulatory_compliance.

Prerequisites

- 1 Remove the [battery](#).
- 2 Remove the [base cover](#).
- 3 Follow the procedure from step 1 to step 3 in "Removing the [Hard Drive](#)".
- 4 Follow the procedure from step 1 to step 2 in "Removing the [Optical Drive](#)".
- 5 Remove the [keyboard](#).
- 6 Follow the procedure from step 1 to step 7 in "Removing the [Palm Rest](#)".
- 7 Remove the [power-adapter port](#).

Procedure

- 1 Close the display and turn the computer over.
- 2 Disconnect the antenna cables from the wireless card.

- 3 Remove the antenna cables from the routing guide on the computer base.

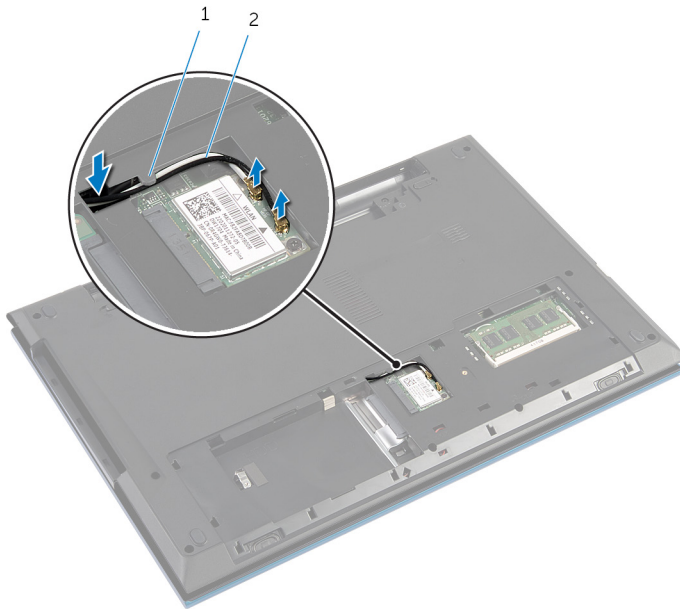

1 routing guide

2 antenna cables (2)

- 4 Turn the computer over and open the display as far as possible.
- 5 Remove the antenna cables from the slot on the computer base.
- 6 Peel off the tape that secures the display cable to the system board.

- 7 Lift the connector latch and disconnect the display cable from the system board.



- 1 display cable
- 2 tape
- 3 connector latch

- 8 Remove the screws that secure the display hinges to the computer base.
- 9 Note the antenna-cable routing and remove the cable from the routing guides on the computer base.

10 Release the display hinges from the tabs on the computer base and lift the display assembly off the computer base.

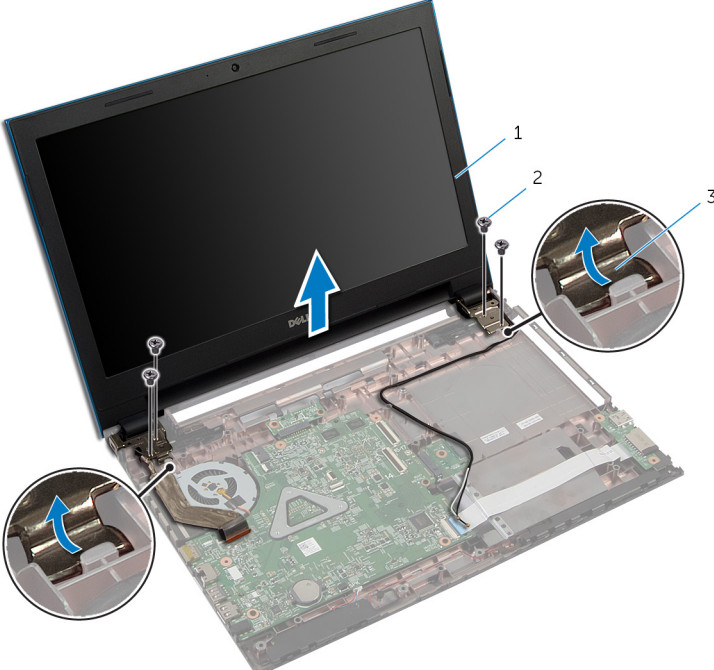

- 1 display assembly
- 3 display hinges (2)

- 2 screws (4)

Replacing the Display Assembly



WARNING: Before working inside your computer, read the safety information that shipped with your computer and follow the steps in [Before Working Inside Your Computer](#). After working inside your computer, follow the instructions in [After Working Inside Your Computer](#). For more safety best practices, see the Regulatory Compliance home page at dell.com/regulatory_compliance.

Procedure

- 1 Slide the display hinges under the tab on the computer base and align the screw holes on the display hinges with the screw holes on the computer base.
- 2 Replace the screws that secure the display hinges to the computer base.
- 3 Route the antenna cable through the routing guides on the computer base.
- 4 Connect the display cable to the system board.
- 5 Adhere the tape that secures the display cable to the system board.
- 6 Slide the antenna cables through the slot on the computer base.
- 7 Close the display and turn the computer over.
- 8 Route the antenna cables through the routing guide on the computer base.
- 9 Connect the antenna cables to the wireless card. See "Replacing the [Wireless Card](#)".
- 10 Turn the computer over and open the display as far as possible.

Post-requisites

- 1 Replace the [power-adaptor port](#).
- 2 Follow the procedure from step 3 to step 9 in "Replacing the [Palm Rest](#)".
- 3 Replace the [keyboard](#).
- 4 Follow the procedure from step 4 to step 5 in "Replacing the [Optical Drive](#)".
- 5 Follow the procedure from step 4 to step 6 in "Replacing the [Hard Drive](#)".

- 6 Replace the [base cover](#).
- 7 Replace the [battery](#).

Removing the Display Bezel



WARNING: Before working inside your computer, read the safety information that shipped with your computer and follow the steps in [Before Working Inside Your Computer](#). After working inside your computer, follow the instructions in [After Working Inside Your Computer](#). For more safety best practices, see the Regulatory Compliance home page at dell.com/regulatory_compliance.

Prerequisites



NOTE: These instructions are only applicable for laptop with non-touch screen display.

- 1 Remove the [base cover](#).
- 2 Remove the [battery](#).
- 3 Follow the procedure from step 1 to step 3 in “Removing the [Hard Drive](#)”.
- 4 Follow the procedure from step 1 to step 2 in “Removing the [Optical Drive](#)”.
- 5 Remove the [keyboard](#).
- 6 Follow the procedure from step 1 to step 7 in “Removing the [Palm Rest](#)”.
- 7 Remove the [power-adapter port](#).
- 8 Remove the [display assembly](#).

Procedure

Using your fingertips, carefully pry up the inside edges of the display bezel and lift the display bezel off the display assembly.



1 display bezel

Replacing the Display Bezel



WARNING: Before working inside your computer, read the safety information that shipped with your computer and follow the steps in [Before Working Inside Your Computer](#). After working inside your computer, follow the instructions in [After Working Inside Your Computer](#). For more safety best practices, see the Regulatory Compliance home page at dell.com/regulatory_compliance.

Procedure



NOTE: These instructions are only applicable for laptop with non-touch screen display.

Align the display bezel with the display back-cover and gently snap the display bezel into place.

Post-requisites

- 1 Replace the [display assembly](#).
- 2 Replace the [power-adapter port](#).
- 3 Follow the procedure from step 3 to step 9 in “Replacing the [Palm Rest](#)”.
- 4 Replace the [keyboard](#).
- 5 Follow the procedure from step 4 to step 5 in “Replacing the [Optical Drive](#)”.
- 6 Follow the procedure from step 4 to step 6 in “Replacing the [Hard Drive](#)”.
- 7 Replace the [base cover](#).
- 8 Replace the [battery](#).

Removing the Display Panel



WARNING: Before working inside your computer, read the safety information that shipped with your computer and follow the steps in [Before Working Inside Your Computer](#). After working inside your computer, follow the instructions in [After Working Inside Your Computer](#). For more safety best practices, see the Regulatory Compliance home page at dell.com/regulatory_compliance.

Prerequisites



NOTE: These instructions are only applicable for laptop with non-touch screen display.

- 1 Remove the [battery](#).
- 2 Remove the [base cover](#).
- 3 Follow the procedure from step 1 to step 3 in “Removing the [Hard Drive](#)”.
- 4 Follow the procedure from step 1 to step 2 in “Removing the [Optical Drive](#)”.
- 5 Remove the [keyboard](#).
- 6 Follow the procedure from step 1 to step 7 in “Removing the [Palm Rest](#)”.
- 7 Remove the [power-adapter port](#).
- 8 Remove the [display assembly](#).
- 9 Remove the [display bezel](#).

Procedure

- 1 Remove the screws that secure the display panel to the display back-cover.

- 4 Lift the connector latch and disconnect the display cable from the display panel.

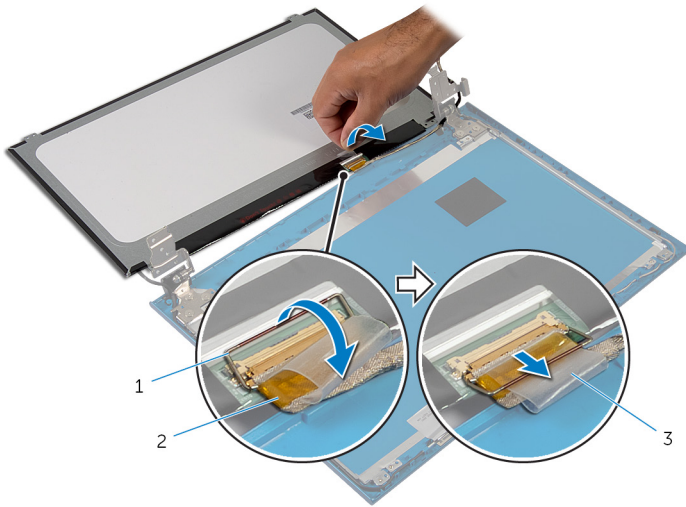

1 connector latch

2 display cable

3 tape

Replacing the Display Panel



WARNING: Before working inside your computer, read the safety information that shipped with your computer and follow the steps in [Before Working Inside Your Computer](#). After working inside your computer, follow the instructions in [After Working Inside Your Computer](#). For more safety best practices, see the Regulatory Compliance home page at dell.com/regulatory_compliance.

Procedure



NOTE: These instructions are only applicable for laptop with non-touch screen display.

- 1 Connect the display cable to the display panel and press down on the connector latch to secure the cable.
- 2 Adhere the tape to the display cable.
- 3 Gently place the display panel on the display back-cover.
- 4 Align the screw holes on the display panel with the screw holes on the display back-cover.
- 5 Replace the screws that secure the display panel to the display back-cover.

Post-requisites

- 1 Replace the [display bezel](#).
- 2 Replace the [display assembly](#).
- 3 Replace the [power-adapter port](#).
- 4 Follow the procedure from step 3 to step 9 in "Replacing the [Palm Rest](#)".
- 5 Replace the [keyboard](#).
- 6 Follow the procedure from step 4 to step 5 in "Replacing the [Optical Drive](#)".
- 7 Follow the procedure from step 4 to step 6 in "Replacing the [Hard Drive](#)".
- 8 Replace the [base cover](#).
- 9 Replace the [battery](#).

Removing the Display Hinges



WARNING: Before working inside your computer, read the safety information that shipped with your computer and follow the steps in [Before Working Inside Your Computer](#). After working inside your computer, follow the instructions in [After Working Inside Your Computer](#). For more safety best practices, see the Regulatory Compliance home page at dell.com/regulatory_compliance.

Prerequisites



NOTE: These instructions are only applicable for laptop with non-touch screen display.

- 1 Remove the [battery](#).
- 2 Remove the [base cover](#).
- 3 Follow the procedure from step 1 to step 3 in “Removing the [Hard Drive](#)”.
- 4 Follow the procedure from step 1 to step 2 in “Removing the [Optical Drive](#)”.
- 5 Remove the [keyboard](#).
- 6 Follow the procedure from step 1 to step 7 in “Removing the [Palm Rest](#)”.
- 7 Remove the [power-adapter port](#).
- 8 Remove the [display assembly](#).
- 9 Remove the [display bezel](#).

Procedure

- 1 Remove the screws that secure the display hinges to the display back-cover.

2 Lift the display hinges off the display back-cover.

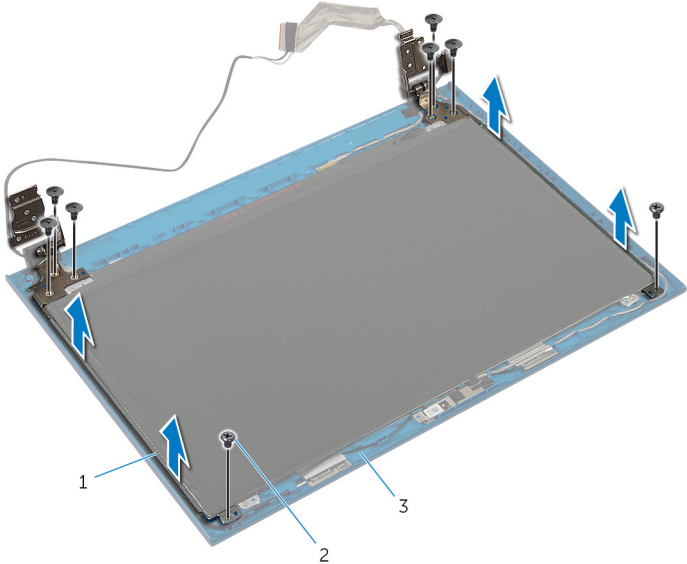

1 display hinges (2)

2 screws (8)

3 display back-cover

Replacing the Display Hinges

 **WARNING:** Before working inside your computer, read the safety information that shipped with your computer and follow the steps in [Before Working Inside Your Computer](#). After working inside your computer, follow the instructions in [After Working Inside Your Computer](#). For more safety best practices, see the Regulatory Compliance home page at dell.com/regulatory_compliance.

Procedure

 **NOTE:** These instructions are only applicable for laptop with non-touch screen display.

- 1 Align the screw holes on the display hinges with the screw holes on the display back-cover.
- 2 Replace the screws that secure the display hinges to the display back-cover.

Post-requisites

- 1 Replace the [display bezel](#).
- 2 Replace the [display assembly](#).
- 3 Replace the [power-adapter port](#).
- 4 Follow the procedure from step 3 to step 9 in "Replacing the [Palm Rest](#)".
- 5 Replace the [keyboard](#).
- 6 Follow the procedure from step 4 to step 5 in "Replacing the [Optical Drive](#)".
- 7 Follow the procedure from step 4 to step 6 in "Replacing the [Hard Drive](#)".
- 8 Replace the [base cover](#).
- 9 Replace the [battery](#).

Removing the Camera



WARNING: Before working inside your computer, read the safety information that shipped with your computer and follow the steps in [Before Working Inside Your Computer](#). After working inside your computer, follow the instructions in [After Working Inside Your Computer](#). For more safety best practices, see the Regulatory Compliance home page at dell.com/regulatory_compliance.

Prerequisites



NOTE: These instructions are only applicable for laptop with non-touch screen display.

- 1 Remove the [battery](#).
- 2 Remove the [base cover](#).
- 3 Follow the procedure from step 1 to step 3 in “Removing the [Hard Drive](#)”.
- 4 Follow the procedure from step 1 to step 2 in “Removing the [Optical Drive](#)”.
- 5 Remove the [keyboard](#).
- 6 Follow the procedure from step 1 to step 3 in “Removing the [Palm Rest](#)”.
- 7 Remove the [power-adapter port](#).
- 8 Remove the [display assembly](#).
- 9 Remove the [display bezel](#).

Procedure

- 1 Carefully pry the camera module from the display back-cover.
- 2 Lift the camera module at an angle and remove it from under the tab on the display back-cover.

3 Disconnect the camera cable from the camera module.

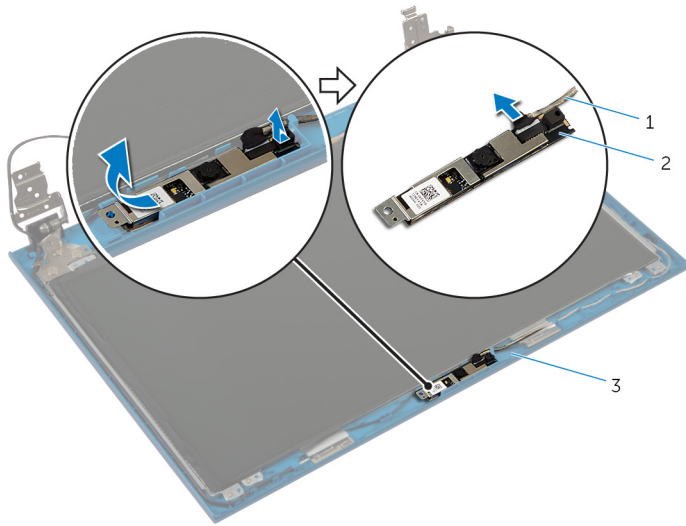

1 camera cable

2 camera module

3 display back-cover

Replacing the Camera



WARNING: Before working inside your computer, read the safety information that shipped with your computer and follow the steps in [Before Working Inside Your Computer](#). After working inside your computer, follow the instructions in [After Working Inside Your Computer](#). For more safety best practices, see the Regulatory Compliance home page at dell.com/regulatory_compliance.

Procedure



NOTE: These instructions are only applicable for laptop with non-touch screen display.

- 1 Connect the camera cable to the camera module.
- 2 Slide the camera under the tab on the display back-cover and adhere the camera module to the display back-cover.

Post-requisites

- 1 Replace the [display bezel](#).
- 2 Replace the [display assembly](#).
- 3 Replace the [power-adapter port](#).
- 4 Follow the procedure from step 3 to step 9 in "Replacing the [Palm Rest](#)".
- 5 Replace the [keyboard](#).
- 6 Follow the procedure from step 4 to step 5 in "Replacing the [Optical Drive](#)".
- 7 Follow the procedure from step 4 to step 6 in "Replacing the [Hard Drive](#)".
- 8 Replace the [base cover](#).
- 9 Replace the [battery](#).

Flashing the BIOS

You may need to flash (update) the BIOS when an update is available or when you replace the system board. To flash the BIOS:

- 1 Turn on the computer.
- 2 Go to **dell.com/support**.
- 3 If you have your computer's Service Tag, type your computer's Service Tag and click **Submit**.
If you do not have your computer's Service Tag, click **Detect My Product** to allow automatic detection of the Service Tag.
 **NOTE:** If the Service Tag cannot be detected automatically, select your product under the product categories.
- 4 Click **Get Drivers and Downloads**.
- 5 Click **View All Drivers**.
- 6 In the **Operating System** drop-down, select the operating system installed on your computer.
- 7 Click **BIOS**.
- 8 Click **Download File** to download the latest version of the BIOS for your computer.
- 9 On the next page, select **Single-file download** and click **Continue**.
- 10 Save the file and once the download is complete, navigate to the folder where you saved the BIOS update file.
- 11 Double-click the BIOS update file icon and follow the instructions on the screen.

Getting Help and Contacting Dell

Self-Help Resources

You can get information and help on Dell products and services using these online self-help resources:

Self-Help Information	Self-Help Options
Accessing Windows Help	Windows 8.1 — Open the Search charm, type Help and Support in the search box and press Enter . Windows 7 — Click Start → Help and Support .
Information about Dell products and services	See dell.com .
Troubleshooting information, user manuals, setup instructions, product specifications, technical help blogs, drivers, software updates, and so on	See dell.com/support .
Information about Microsoft Windows 8.1	See dell.com/windows8 .
Information about Microsoft Windows 7	Click Start → All Programs → Dell Help Documentation .
Learn about your operating system, setting up and using your computer, data backup, diagnostics, and so on.	See <i>Me and My Dell</i> at dell.com/support/manuals .

Contacting Dell

To contact Dell for sales, technical support, or customer service issues, see **dell.com/contactdell**.

 **NOTE:** Availability varies by country and product, and some services may not be available in your country.



NOTE: If you do not have an active internet connection, you can find contact information on your purchase invoice, packing slip, bill, or Dell product catalog.