

Inspiron 15

Service Manual

Computer Model: Inspiron 15–3531
Regulatory Model: P28F
Regulatory Type: P28F005



Notes, Cautions, and Warnings



NOTE: A NOTE indicates important information that helps you make better use of your computer.



CAUTION: A CAUTION indicates either potential damage to hardware or loss of data and tells you how to avoid the problem.



WARNING: A WARNING indicates a potential for property damage, personal injury, or death.

Copyright © 2014 Dell Inc. All rights reserved. This product is protected by U.S. and international copyright and intellectual property laws. Dell™ and the Dell logo are trademarks of Dell Inc. in the United States and/or other jurisdictions. All other marks and names mentioned herein may be trademarks of their respective companies.

2014 - 05

Rev. A00

Contents

Before Working Inside Your Computer.....	9
Before You Begin	9
Safety Instructions.....	9
Recommended Tools.....	10
After Working Inside Your Computer.....	11
Removing the Battery.....	12
Procedure.....	12
Replacing the Battery.....	13
Procedure.....	13
Removing the Base Cover.....	14
Prerequisites.....	14
Procedure.....	14
Replacing the Base Cover.....	16
Procedure.....	16
Post-requisites.....	16
Removing the Optical-Drive Filler.....	17
Prerequisites.....	17
Procedure.....	17
Replacing the Optical-Drive Filler.....	18
Procedure.....	18
Post-requisites.....	18

Removing the Memory Module.....	19
Prerequisites.....	19
Procedure.....	20
Replacing the Memory Module.....	21
Procedure.....	22
Post-requisites.....	23
Removing the Hard Drive.....	24
Prerequisites.....	24
Procedure.....	24
Replacing the Hard Drive.....	27
Procedure.....	27
Post-requisites.....	27
Removing the Keyboard.....	28
Prerequisites.....	28
Procedure.....	28
Replacing the Keyboard.....	31
Procedure.....	31
Post-requisites.....	31
Removing the Wireless Card.....	32
Prerequisites.....	32
Procedure.....	32
Replacing the Wireless Card.....	34
Procedure.....	34
Post-requisites.....	34

Removing the Palm Rest	35
Prerequisites.....	35
Procedure.....	36
Replacing the Palm Rest	40
Procedure.....	40
Post-requisites.....	40
Removing the Light-Extender Tube	41
Prerequisites.....	41
Procedure.....	41
Replacing the Light-Extender Tube	43
Procedure.....	43
Post-requisites.....	43
Removing the System Board	44
Prerequisites.....	44
Procedure.....	45
Replacing the System Board	47
Procedure.....	47
Post-requisites.....	47
Entering the Service Tag in the BIOS.....	48
Removing the Heat-Sink Assembly	49
Prerequisites.....	49
Procedure.....	49
Replacing the Heat-Sink Assembly	51
Procedure.....	51
Post-requisites.....	51

Removing the Coin-Cell Battery	52
Prerequisites.....	52
Procedure.....	52
Replacing the Coin-Cell Battery	54
Procedure.....	54
Post-requisites.....	54
Removing the Speakers	55
Prerequisites.....	55
Procedure.....	56
Replacing the Speakers	57
Procedure.....	57
Post-requisites.....	57
Removing the Display Assembly	58
Prerequisites.....	58
Procedure.....	59
Replacing the Display Assembly	62
Procedure.....	62
Post-requisites.....	62
Removing the Display Bezel	63
Prerequisites.....	63
Procedure.....	64
Replacing the Display Bezel	66
Procedure.....	66
Post-requisites.....	66

Removing the Display Hinges.....	67
Prerequisites.....	67
Procedure.....	68
Replacing the Display Hinges.....	69
Procedure.....	69
Post-requisites.....	69
Removing the Display Panel.....	70
Prerequisites.....	70
Procedure.....	71
Replacing the Display Panel.....	73
Procedure.....	73
Post-requisites.....	73
Removing the Camera.....	74
Prerequisites.....	74
Procedure.....	75
Replacing the Camera.....	77
Procedure.....	77
Post-requisites.....	77
Removing the Power-Adapter Port.....	78
Prerequisites.....	78
Procedure.....	78
Replacing the Power-Adapter Port.....	80
Procedure.....	80
Post-requisites.....	80
Flashing the BIOS.....	81



Getting Help and Contacting Dell.....	82
Self-Help Resources.....	82
Contacting Dell.....	82

Before Working Inside Your Computer

 **CAUTION:** To avoid damaging the components and cards, handle them by their edges and avoid touching pins and contacts.

 **NOTE:** The images in this document may differ from your computer depending on the configuration you ordered.









Before You Begin

- 1 Save and close all open files and exit all open applications.
 - 2 Shut down your computer.
 - Windows 8.1: On the **Start** screen, click or tap the power icon  → **Shut down**.
 - Windows 7: Click or tap **Start** → **Shut down** .
-  **NOTE:** If you are using a different operating system, see the documentation of your operating system for shut-down instructions.
- 3 Disconnect your computer and all attached devices from their electrical outlets.
 - 4 Disconnect all cables such as telephone cables, network cables and so on, from your computer.
 - 5 Disconnect all attached devices and peripherals, such as keyboard, mouse, monitor, and so on, from your computer.
 - 6 Remove any media card and optical disc from your computer, if applicable.

Safety Instructions

Use the following safety guidelines to protect your computer from potential damage and ensure your personal safety.

 **WARNING:** Before working inside your computer, read the safety information that shipped with your computer. For more safety best practices, see the Regulatory Compliance home page at dell.com/regulatory_compliance.

-  **WARNING:** Disconnect all power sources before opening the computer cover or panels. After you finish working inside the computer, replace all covers, panels, and screws before connecting to the power source.
-  **CAUTION:** To avoid damaging the computer, make sure that the work surface is flat and clean.
-  **CAUTION:** To avoid damaging the components and cards, handle them by their edges and avoid touching pins and contacts.
-  **CAUTION:** Only a certified service technician is authorized to remove the computer cover and access any of the components inside the computer. See the safety instructions for complete information about safety precautions, working inside your computer, and protecting against electrostatic discharge.
-  **CAUTION:** Before touching anything inside your computer, ground yourself by touching an unpainted metal surface, such as the metal at the back of the computer. While you work, periodically touch an unpainted metal surface to dissipate static electricity, which could harm internal components.
-  **CAUTION:** When you disconnect a cable, pull on its connector or on its pull-tab, not on the cable itself. Some cables have connectors with locking tabs or thumb-screws that you must disengage before disconnecting the cable. When disconnecting cables, keep them evenly aligned to avoid bending any connector pins. When connecting cables, make sure that the ports and connectors are correctly oriented and aligned.
-  **CAUTION:** To disconnect a network cable, first unplug the cable from your computer and then unplug the cable from the network device.
-  **CAUTION:** Press and eject any installed card from the media-card reader.

Recommended Tools

The procedures in this document may require the following tools:

- Philips screwdriver
- Plastic scribe

After Working Inside Your Computer



CAUTION: Leaving stray or loose screws inside your computer may severely damage your computer.

- 1 Replace all screws and make sure that no stray screws remain inside your computer.
- 2 Connect any external devices, peripherals, and cables you removed before working on your computer.
- 3 Replace any media cards, discs, and any other part(s) that you removed before working on your computer.
- 4 Connect your computer and all attached devices to their electrical outlets.
- 5 Turn on your computer.

Removing the Battery

! **WARNING:** Before working inside your computer, read the safety information that shipped with your computer and follow the steps in [Before Working Inside Your Computer](#). After working inside your computer, follow the instructions in [After Working Inside Your Computer](#). For more safety best practices, see the Regulatory Compliance home page at dell.com/regulatory_compliance.

Procedure

- 1 Close the display and turn the computer over.
- 2 Slide the battery-release latches to the unlock position.
- 3 Using your fingertips, lift the battery at an angle and remove the battery off the battery bay.

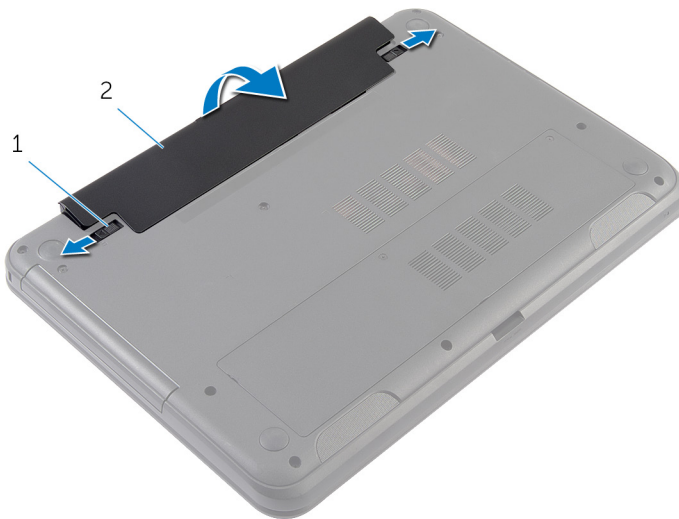

1 battery-release latches (2) 2 battery

- 4 Turn the computer over and open the display as far as possible.
- 5 Press and hold the power button for 5 seconds after the computer is unplugged to ground the system board.

Replacing the Battery



WARNING: Before working inside your computer, read the safety information that shipped with your computer and follow the steps in [Before Working Inside Your Computer](#). After working inside your computer, follow the instructions in [After Working Inside Your Computer](#). For more safety best practices, see the Regulatory Compliance home page at dell.com/regulatory_compliance.

Procedure

- 1 Slide the tabs on the battery into the slots on the battery bay and snap the battery into place.
 -  **NOTE:** Make sure the battery-release latches are secured.
- 2 Turn the computer over and open the display as far as possible.

Removing the Base Cover



WARNING: Before working inside your computer, read the safety information that shipped with your computer and follow the steps in [Before Working Inside Your Computer](#). After working inside your computer, follow the instructions in [After Working Inside Your Computer](#). For more safety best practices, see the Regulatory Compliance home page at dell.com/regulatory_compliance.

Prerequisites

Remove the [battery](#).

Procedure

- 1 Loosen the captive screws that secure the base cover to the computer base.
- 2 Using your fingertips, pry the base cover from the computer base.

3 Lift the base cover at an angle and remove it from the computer base.

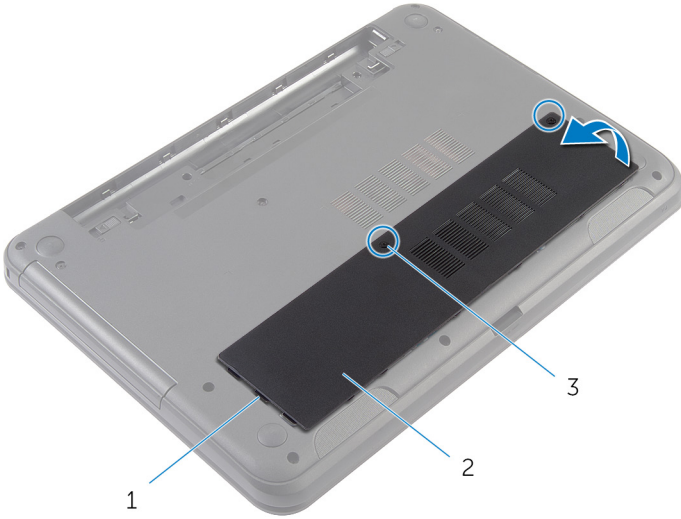

1 tabs (3)

2 base cover

3 captive screws (2)

Replacing the Base Cover



WARNING: Before working inside your computer, read the safety information that shipped with your computer and follow the steps in [Before Working Inside Your Computer](#). After working inside your computer, follow the instructions in [After Working Inside Your Computer](#). For more safety best practices, see the Regulatory Compliance home page at dell.com/regulatory_compliance.

Procedure

- 1 Slide the tabs on the base cover into the slots on the computer base and snap the base cover into place.
- 2 Tighten the captive screws that secure the base cover to the computer base.

Post-requisites

Replace the [battery](#).

Removing the Optical-Drive Filler

⚠ WARNING: Before working inside your computer, read the safety information that shipped with your computer and follow the steps in [Before Working Inside Your Computer](#). After working inside your computer, follow the instructions in [After Working Inside Your Computer](#). For more safety best practices, see the Regulatory Compliance home page at dell.com/regulatory_compliance.

Prerequisites

Remove the [battery](#).

Procedure

- 1 Remove the screw that secures the optical-drive filler to the computer base.
- 2 Using your fingertips, slide the optical-drive filler out of the optical-drive filler bay.

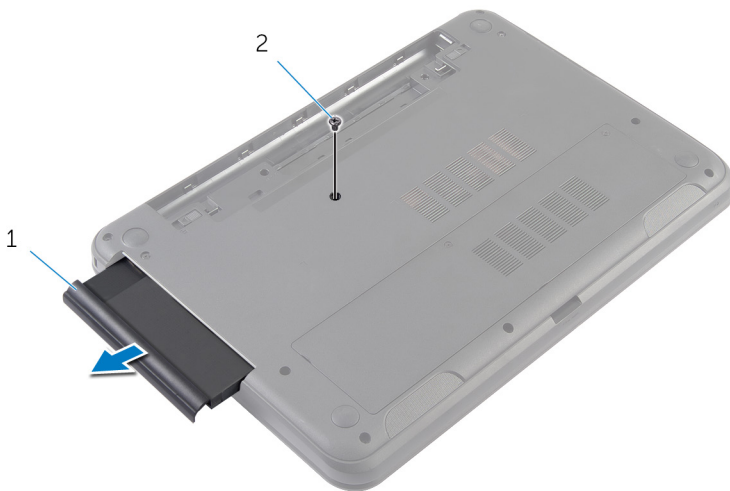

1 optical-drive filler

2 screw

Replacing the Optical-Drive Filler



WARNING: Before working inside your computer, read the safety information that shipped with your computer and follow the steps in [Before Working Inside Your Computer](#). After working inside your computer, follow the instructions in [After Working Inside Your Computer](#). For more safety best practices, see the Regulatory Compliance home page at dell.com/regulatory_compliance.

Procedure

- 1 Slide the optical-drive filler into the optical-drive filler bay and align the screw hole on the optical-drive filler with the screw hole on computer base.
- 2 Replace the screw that secures the optical-drive filler to the computer base.

Post-requisites

Replace the [battery](#).

Removing the Memory Module

 **WARNING:** Before working inside your computer, read the safety information that shipped with your computer and follow the steps in [Before Working Inside Your Computer](#). After working inside your computer, follow the instructions in [After Working Inside Your Computer](#). For more safety best practices, see the Regulatory Compliance home page at dell.com/regulatory_compliance.

Prerequisites

- 1 Remove the [battery](#).
- 2 Remove the [base cover](#).

Procedure

- 1 Using your fingertips, pry apart the securing clips on each end of the memory-module slot until the memory module pops up.
- 2 Slide and remove the memory module from the memory-module slot.

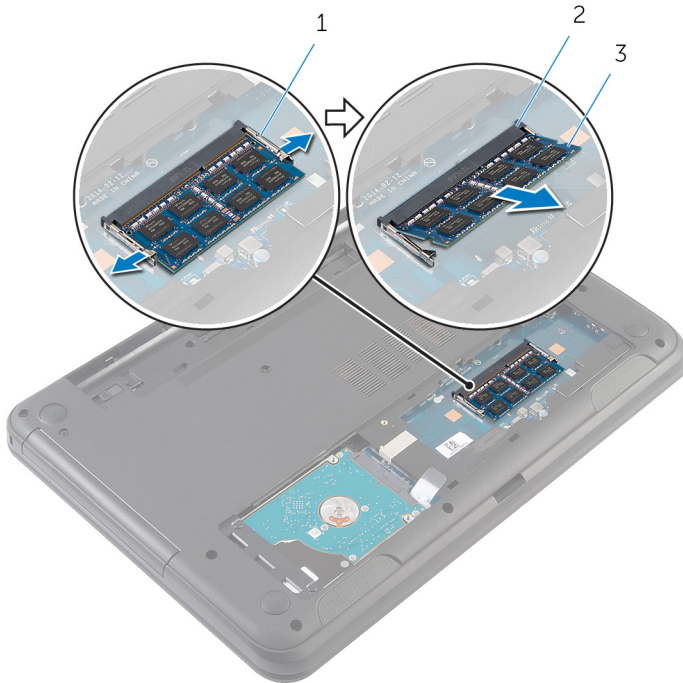

1 securing clips (2)

2 memory-module slot

3 memory module

Replacing the Memory Module



WARNING: Before working inside your computer, read the safety information that shipped with your computer and follow the steps in [Before Working Inside Your Computer](#). After working inside your computer, follow the instructions in [After Working Inside Your Computer](#). For more safety best practices, see the Regulatory Compliance home page at dell.com/regulatory_compliance.

Procedure

- 1 Align the notch on the memory module with the tab on the memory-module slot.
- 2 Slide the memory module into the slot at an angle and press the memory module down until it clicks into place.

 **NOTE:** If you do not hear the click, remove the memory module and reinstall it.

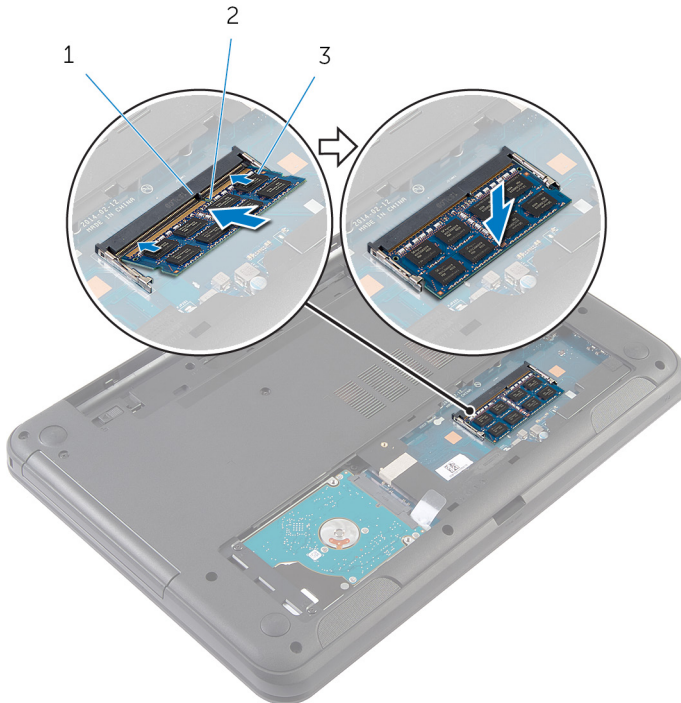

- 1 tab
3 memory module

2 notch

Post-requisites

- 1 Replace the [base cover](#).
- 2 Replace the [battery](#).

Removing the Hard Drive

 **WARNING:** Before working inside your computer, read the safety information that shipped with your computer and follow the steps in [Before Working Inside Your Computer](#). After working inside your computer, follow the instructions in [After Working Inside Your Computer](#). For more safety best practices, see the Regulatory Compliance home page at dell.com/regulatory_compliance.

 **CAUTION:** Hard drives are fragile. Exercise care when handling the hard drive.

 **CAUTION:** To avoid data loss, do not remove the hard drive while the computer is in Sleep or On state.

Prerequisites

- 1 Remove the [battery](#).
- 2 Remove the [base cover](#).

Procedure

- 1 Remove the screws that secure the hard-drive assembly to the computer base.
- 2 Slide the hard-drive assembly away from the system-board connector to disconnect the hard-drive assembly from the system board.

- 3** Using the pull tab, lift the hard-drive assembly at an angle and remove it from the computer base.

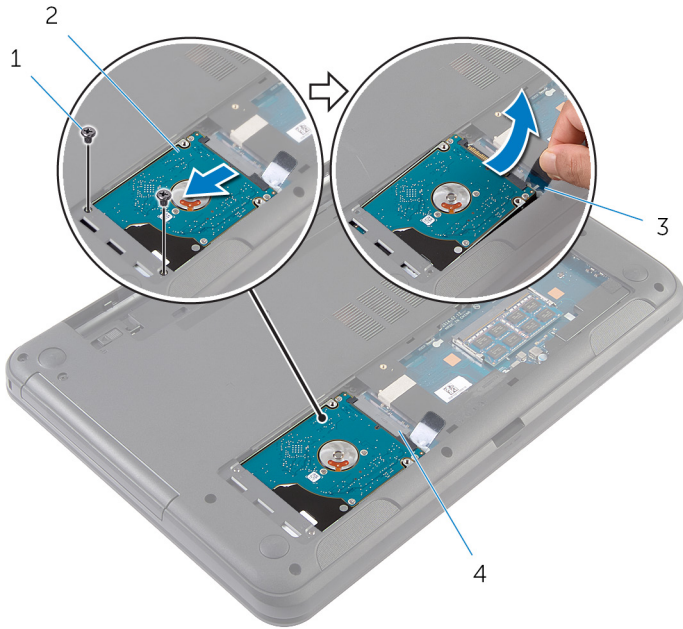

1 screws (2)

2 hard-drive assembly

3 pull tab

4 system-board connector

- 4** Remove the screws that secure the hard-drive bracket to the hard drive.

5 Lift the hard-drive bracket off the hard drive.

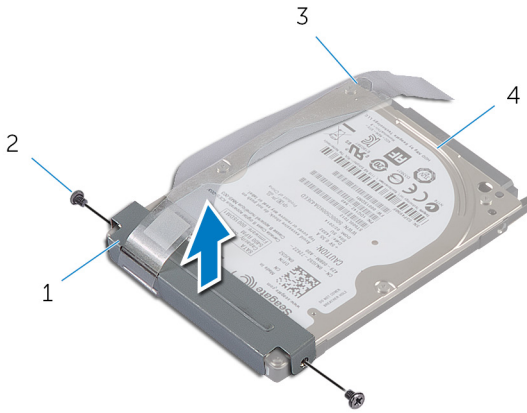



1 hard-drive bracket

2 screws (2)

3 pull tab

4 hard drive

Replacing the Hard Drive

-  **WARNING:** Before working inside your computer, read the safety information that shipped with your computer and follow the steps in [Before Working Inside Your Computer](#). After working inside your computer, follow the instructions in [After Working Inside Your Computer](#). For more safety best practices, see the Regulatory Compliance home page at dell.com/regulatory_compliance.
-  **CAUTION:** Hard drives are fragile. Exercise care when handling the hard drive.

Procedure

- 1 Align the screw holes on the hard-drive bracket with the screw holes on the hard drive.
- 2 Replace the screws that secure the hard-drive bracket to the hard drive.
- 3 Slide the hard-drive assembly into the slot on the computer base and place the hard-drive assembly on the computer base.
- 4 Using the pull tab, slide the hard-drive assembly towards the system-board connector to connect the hard-drive assembly to the system board.
- 5 Replace the screws that secure the hard-drive assembly to the computer base.

Post-requisites

- 1 Replace the [base cover](#).
- 2 Replace the [battery](#).

Removing the Keyboard



WARNING: Before working inside your computer, read the safety information that shipped with your computer and follow the steps in [Before Working Inside Your Computer](#). After working inside your computer, follow the instructions in [After Working Inside Your Computer](#). For more safety best practices, see the Regulatory Compliance home page at dell.com/regulatory_compliance.

Prerequisites

Remove the [battery](#).

Procedure

- 1 Turn the computer over and open the display as far as possible.
- 2 Using a plastic scribe, release the tabs that secure the keyboard to the palm rest.

- 3** Carefully turn the keyboard over and place it on the palm rest.



- | | | | |
|---|----------------|---|-----------|
| 1 | plastic scribe | 2 | keyboard |
| 3 | tabs (5) | 4 | palm rest |

- 4** Lift the connector latch and disconnect the keyboard cable from the system board.

5 Lift the keyboard along with the cable off the palm rest.



1 connector latch

2 keyboard cable

3 keyboard

Replacing the Keyboard



WARNING: Before working inside your computer, read the safety information that shipped with your computer and follow the steps in [Before Working Inside Your Computer](#). After working inside your computer, follow the instructions in [After Working Inside Your Computer](#). For more safety best practices, see the Regulatory Compliance home page at dell.com/regulatory_compliance.

Procedure

- 1 Slide the keyboard cable into the system-board connector and press down on the connector latch to secure the cable.
- 2 Carefully turn the keyboard over, slide the tabs on the keyboard into the slots on the palm rest, and snap the keyboard into place.
- 3 Close the display and turn the computer over.

Post-requisites

Replace the [battery](#).

Removing the Wireless Card



WARNING: Before working inside your computer, read the safety information that shipped with your computer and follow the steps in [Before Working Inside Your Computer](#). After working inside your computer, follow the instructions in [After Working Inside Your Computer](#). For more safety best practices, see the Regulatory Compliance home page at dell.com/regulatory_compliance.

Prerequisites

- 1 Remove the [battery](#).
- 2 Remove the [keyboard](#).

Procedure

- 1 Disconnect the antenna cables from the wireless card.
- 2 Remove the screw that secures the wireless card to the computer base.

3 Slide the wireless card out of the wireless-card slot.

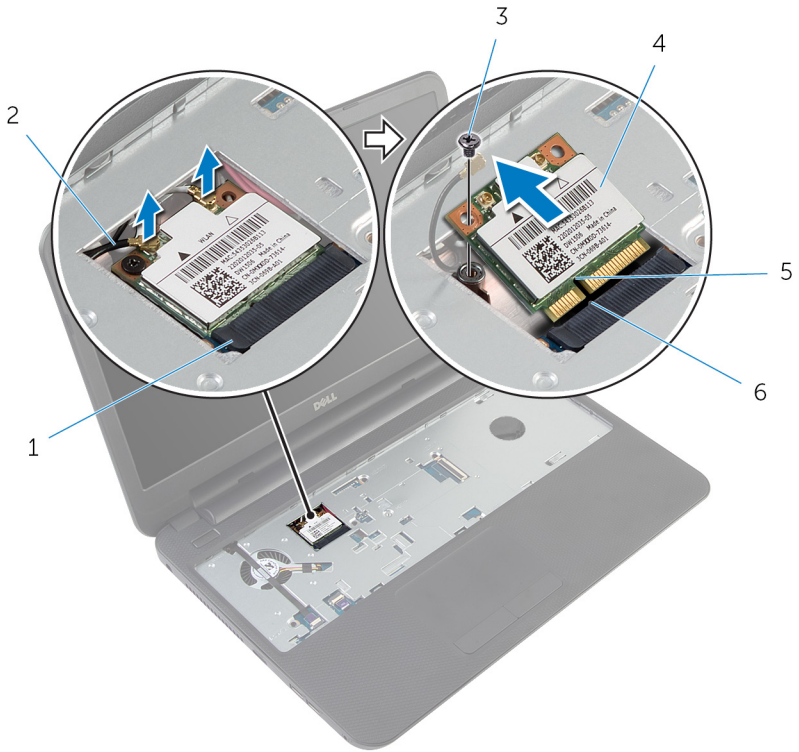

1 wireless-card slot

2 antenna cables (2)

3 screw

4 wireless card

5 notch

6 tab

Replacing the Wireless Card



WARNING: Before working inside your computer, read the safety information that shipped with your computer and follow the steps in [Before Working Inside Your Computer](#). After working inside your computer, follow the instructions in [After Working Inside Your Computer](#). For more safety best practices, see the Regulatory Compliance home page at dell.com/regulatory_compliance.

Procedure

- 1 Align the notch on the wireless card with the tab on the wireless-card slot.
- 2 Insert the wireless card at an angle into the slot.
- 3 Press the other end of the wireless card down and replace the screw that secures the wireless card to the computer base.
- 4 Connect the antenna cables to the wireless card.

The following table provides the antenna cable color schemes for the wireless card supported by your computer.

Connectors on the wireless card	Antenna-cable color
Main (white triangle)	White
Auxiliary (black triangle)	Black

Post-requisites

- 1 Replace the [keyboard](#).
- 2 Replace the [battery](#).

Removing the Palm Rest



WARNING: Before working inside your computer, read the safety information that shipped with your computer and follow the steps in [Before Working Inside Your Computer](#). After working inside your computer, follow the instructions in [After Working Inside Your Computer](#). For more safety best practices, see the Regulatory Compliance home page at dell.com/regulatory_compliance.

Prerequisites

- 1 Remove the [battery](#).
- 2 Remove the [base cover](#).
- 3 Remove the [keyboard](#).

Procedure

- 1 Lift the connector latches and using the pull tabs, disconnect the touchpad cable and power-button cable from the system board.
- 2 Note the power-button cable routing and peel it off the palm rest.



1 power-button cable

2 connector latches (2)

3 touchpad cable

4 pull tabs (2)

- 3 Remove the screws that secure the palm rest to the computer base.

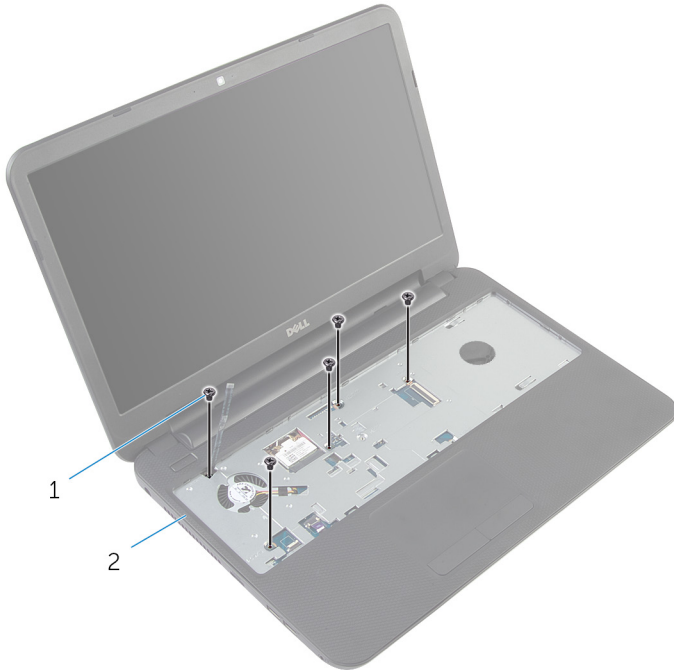

1 screws (5)

2 palm rest

- 4 Close the display and turn the computer over.

- 5** Remove the screws that secure the palm rest to the computer base.

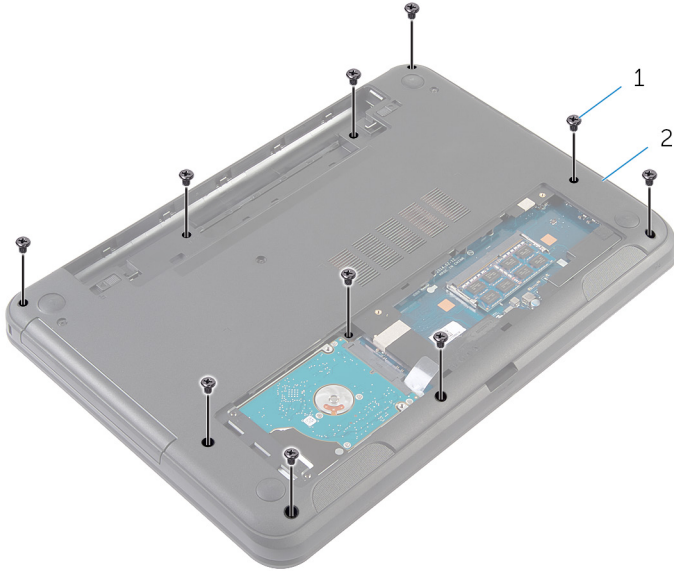

1 screws (10)

2 computer base

- 6** Turn the computer over and open the display as far as possible.
- 7** Using a plastic scribe, gently release the tabs on the palm rest from the slots on the computer base.

- 8** Lift the palm rest at an angle and remove it from the computer base.



1 palm rest

2 plastic scribe

Replacing the Palm Rest



WARNING: Before working inside your computer, read the safety information that shipped with your computer and follow the steps in [Before Working Inside Your Computer](#). After working inside your computer, follow the instructions in [After Working Inside Your Computer](#). For more safety best practices, see the Regulatory Compliance home page at dell.com/regulatory_compliance.

Procedure

- 1 Align the screw holes on the palm rest with the screw holes on the computer base and snap the palm rest into place.
- 2 Replace the screws that secure the palm rest to the computer base.
- 3 Adhere the power-button cable to the palm rest.
- 4 Slide the touchpad cable and the power-button cable into the system-board connectors and press down on the connector latches to secure the cables.
- 5 Close the display and turn the computer over.
- 6 Replace the screws that secure the palm rest to the computer base.
- 7 Turn the computer over and open the display as far as possible.

Post-requisites

- 1 Replace the [keyboard](#).
- 2 Replace the [base cover](#).
- 3 Replace the [battery](#).

Removing the Light-Extender Tube



WARNING: Before working inside your computer, read the safety information that shipped with your computer and follow the steps in [Before Working Inside Your Computer](#). After working inside your computer, follow the instructions in [After Working Inside Your Computer](#). For more safety best practices, see the Regulatory Compliance home page at dell.com/regulatory_compliance.

Prerequisites

- 1 Remove the [battery](#).
- 2 Remove the [base cover](#).
- 3 Remove the [keyboard](#).
- 4 Remove the [palm rest](#).

Procedure

Note the light-extender tube alignment, lift the light-extender tube at an angle, and remove it from the slot on the speaker.



1 speaker

2 light-extender tube

Replacing the Light-Extender Tube



WARNING: Before working inside your computer, read the safety information that shipped with your computer and follow the steps in [Before Working Inside Your Computer](#). After working inside your computer, follow the instructions in [After Working Inside Your Computer](#). For more safety best practices, see the Regulatory Compliance home page at dell.com/regulatory_compliance.

Procedure

Slide the light-extender tube into the slot on the computer base and place it in the slot on the speaker.

Post-requisites

- 1 Replace the [palm rest](#).
- 2 Replace the [keyboard](#).
- 3 Replace the [base cover](#).
- 4 Replace the [battery](#).

Removing the System Board



WARNING: Before working inside your computer, read the safety information that shipped with your computer and follow the steps in [Before Working Inside Your Computer](#). After working inside your computer, follow the instructions in [After Working Inside Your Computer](#). For more safety best practices, see the Regulatory Compliance home page at dell.com/regulatory_compliance.



NOTE: Your computer's Service Tag is stored in the system board. You must enter the Service Tag in the System Setup after you replace the system board.



NOTE: Replacing the system board removes any changes you have made to the BIOS using System Setup. You must make the desired changes again after you replace the system board.



NOTE: Before disconnecting the cables from the system board, note the location of the connectors so that you can reconnect them correctly after you replace the system board.

Prerequisites

- 1 Remove the [battery](#).
- 2 Remove the [base cover](#).
- 3 Remove the [memory module](#).
- 4 Follow the procedure from step 1 to step 3 in "Removing the [Hard Drive](#)".
- 5 Remove the [keyboard](#).
- 6 Remove the [wireless card](#).
- 7 Remove the [palm rest](#).
- 8 Remove the [light-extender tube](#).

Procedure

- 1 Peel off the tape that secures the display cable to the system board.
- 2 Disconnect the display cable, power-adaptor port cable, and speaker cable from the system board.

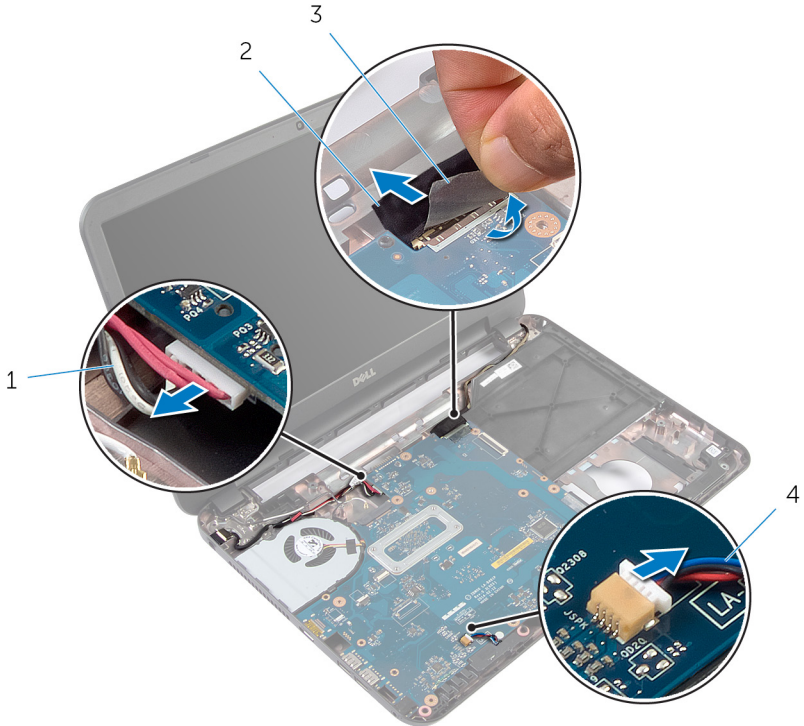

- | | | | |
|---|--------------------------|---|---------------|
| 1 | power-adaptor port cable | 2 | display cable |
| 3 | tape | 4 | speaker cable |

- 3 Remove the screw that secures the system board to the computer base.
- 4 Lift the system board at an angle and release the ports on the system board from the slots on the computer base.

- 5 Turn the system board over and place it on a clean and flat surface.





1 system board

2 screw

- 6 Follow the procedure from step 1 to step 3 in “Removing the [Heat-Sink Assembly](#)”.

Replacing the System Board

 **WARNING:** Before working inside your computer, read the safety information that shipped with your computer and follow the steps in [Before Working Inside Your Computer](#). After working inside your computer, follow the instructions in [After Working Inside Your Computer](#). For more safety best practices, see the Regulatory Compliance home page at dell.com/regulatory_compliance.

 **NOTE:** Your computer's Service Tag is stored in the system board. You must enter the Service Tag in the System Setup after you replace the system board.

Procedure

- 1 Follow the procedure from step 1 to step 4 in "Replacing the [Heat-Sink Assembly](#)".
- 2 Turn the system-board over.
- 3 Slide the system-board ports into the slots on the computer base.
- 4 Align the screw hole on the system board with the screw hole on the computer base.

 **CAUTION:** Make sure that no cables are placed under the system board.

- 5 Replace the screw that secures the system board to the computer base.
- 6 Connect the display cable, power-adapter port cable, and speaker cable to the system board.
- 7 Adhere the tape to the display cable.



Post-requisites

- 1 Replace the [light-extender tube](#).
- 2 Replace the [palm rest](#).
- 3 Replace the [wireless card](#).
- 4 Replace the [keyboard](#).
- 5 Follow the procedure from step 3 to step 5 in "Replacing the [Hard Drive](#)".
- 6 Replace the [memory module](#).
- 7 Replace the [base cover](#).
- 8 Replace the [battery](#).

Entering the Service Tag in the BIOS

- 1 Turn on the computer.
- 2 Press **F2** when the DELL logo is displayed to enter System Setup.
- 3 Navigate to the **Main** tab and enter the Service Tag in the **Service Tag Input** field.

Removing the Heat-Sink Assembly

-  **WARNING:** Before working inside your computer, read the safety information that shipped with your computer and follow the steps in [Before Working Inside Your Computer](#). After working inside your computer, follow the instructions in [After Working Inside Your Computer](#). For more safety best practices, see the Regulatory Compliance home page at dell.com/regulatory_compliance.
-  **WARNING:** The heat sink may become hot during normal operation. Allow sufficient time for the heat sink to cool before you touch it.
-  **CAUTION:** To ensure maximum cooling for the processor, do not touch the heat transfer areas on the heat sink. The oils in your skin can reduce the heat transfer capability of the thermal grease.

Prerequisites

- 1 Remove the [battery](#).
- 2 Remove the [base cover](#).
- 3 Follow the procedure from step 1 to step 3 in “Removing the [Hard Drive](#)”.
- 4 Remove the [keyboard](#).
- 5 Remove the [wireless card](#).
- 6 Remove the [palm rest](#).
- 7 Follow the procedure from step 1 to step 5 in “Removing the [System Board](#)”.

Procedure

-  **NOTE:** The heat-sink assembly may look different on your computer depending on the configuration you ordered.
- 1 Disconnect the fan cable from the system board.
 - 2 In sequential order (indicated on the heat-sink assembly), remove the screws that secure the heat-sink assembly to the system board.

3 Lift the heat-sink assembly off the system board.

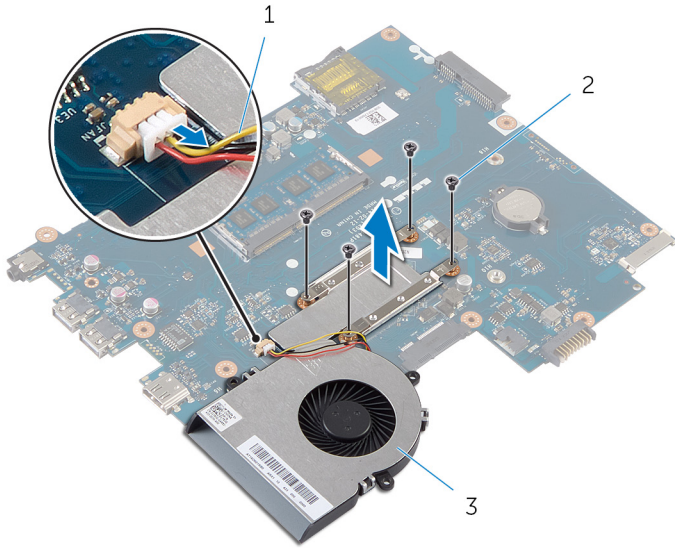

1 fan cable

2 screws (4)

3 heat-sink assembly

Replacing the Heat-Sink Assembly



WARNING: Before working inside your computer, read the safety information that shipped with your computer and follow the steps in [Before Working Inside Your Computer](#). After working inside your computer, follow the instructions in [After Working Inside Your Computer](#). For more safety best practices, see the Regulatory Compliance home page at dell.com/regulatory_compliance.



CAUTION: Incorrect alignment of the heat sink can cause damage to the system board and processor.

Procedure

- 1 Clean the thermal grease from the bottom of the heat-sink assembly and reapply it.
- 2 Align the screw holes on the heat-sink assembly with the screw holes on the system board.
- 3 In sequential order (indicated on the heat-sink assembly), replace the screws that secure the heat-sink assembly to the system board.
- 4 Connect the fan cable to the system board.

Post-requisites

- 1 Follow the procedure from step 2 to step 7 in “Replacing the [System Board](#)”.
- 2 Replace the [palm rest](#).
- 3 Replace the [wireless card](#).
- 4 Replace the [keyboard](#).
- 5 Follow the procedure from step 3 to step 5 in “Replacing the [Hard Drive](#)”.
- 6 Replace the [base cover](#).
- 7 Replace the [battery](#).

Removing the Coin-Cell Battery

 **WARNING:** Before working inside your computer, read the safety information that shipped with your computer and follow the steps in [Before Working Inside Your Computer](#). After working inside your computer, follow the instructions in [After Working Inside Your Computer](#). For more safety best practices, see the Regulatory Compliance home page at dell.com/regulatory_compliance.

 **CAUTION:** Removing the coin-cell battery resets the BIOS settings to default. It is recommended that you note the BIOS settings before removing the coin-cell battery.

Prerequisites

- 1 Remove the [battery](#).
- 2 Remove the [base cover](#).
- 3 Follow the procedure from step 1 to step 3 in “Removing the [Hard Drive](#)”.
- 4 Remove the [keyboard](#).
- 5 Remove the [wireless card](#).
- 6 Remove the [palm rest](#).
- 7 Follow the procedure from step 1 to step 5 in “Removing the [System Board](#)”.

Procedure

Using a plastic scribe, gently pry out the coin-cell battery out of the battery socket on the system board.

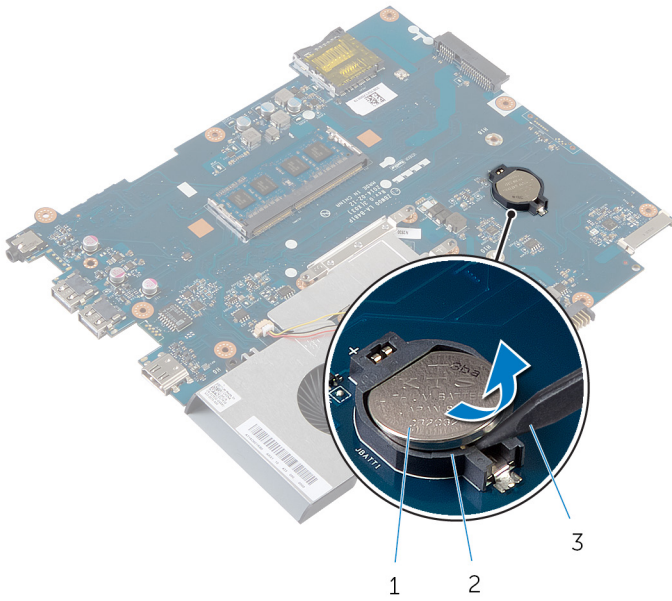

1 coin-cell battery

2 battery socket

3 plastic scribe

Replacing the Coin-Cell Battery



WARNING: Before working inside your computer, read the safety information that shipped with your computer and follow the steps in [Before Working Inside Your Computer](#). After working inside your computer, follow the instructions in [After Working Inside Your Computer](#). For more safety best practices, see the Regulatory Compliance home page at dell.com/regulatory_compliance.

Procedure

With the positive-side facing up, snap the coin-cell battery into the battery socket on the system board.

Post-requisites

- 1 Follow the procedure from step 2 to step 7 in “Replacing the [System Board](#)”.
- 2 Replace the [palm rest](#).
- 3 Replace the [wireless card](#).
- 4 Replace the [keyboard](#).
- 5 Follow the procedure from step 3 to step 5 in “Replacing the [Hard Drive](#)”.
- 6 Replace the [base cover](#).
- 7 Replace the [battery](#).

Removing the Speakers



WARNING: Before working inside your computer, read the safety information that shipped with your computer and follow the steps in [Before Working Inside Your Computer](#). After working inside your computer, follow the instructions in [After Working Inside Your Computer](#). For more safety best practices, see the Regulatory Compliance home page at dell.com/regulatory_compliance.

Prerequisites

- 1 Remove the [battery](#).
- 2 Remove the [base cover](#).
- 3 Follow the procedure from step 1 to step 3 in "Removing the [Hard Drive](#)".
- 4 Remove the [keyboard](#).
- 5 Remove the [wireless card](#).
- 6 Remove the [palm rest](#).
- 7 Remove the [light-extender tube](#).
- 8 Follow the procedure from step 1 to step 5 in "Removing the [System Board](#)".

Procedure

- 1 Note the speaker-cable routing and remove the cable from the routing guides on the computer base.
- 2 Lift the speakers along with the cable off the computer base.



1 speakers (2)

2 speaker cable

Replacing the Speakers



WARNING: Before working inside your computer, read the safety information that shipped with your computer and follow the steps in [Before Working Inside Your Computer](#). After working inside your computer, follow the instructions in [After Working Inside Your Computer](#). For more safety best practices, see the Regulatory Compliance home page at dell.com/regulatory_compliance.

Procedure

- 1 Align the speakers using the alignment posts on the computer base and snap the speakers into place.
- 2 Route the speaker cable through the routing guides on the computer base.

Post-requisites

- 1 Follow the procedure from step 2 to step 7 in “Replacing the [System Board](#)”.
- 2 Replace the [light-extender tube](#).
- 3 Replace the [palm rest](#).
- 4 Replace the [wireless card](#).
- 5 Replace the [keyboard](#).
- 6 Follow the procedure from step 3 to step 5 in “Replacing the [Hard Drive](#)”.
- 7 Replace the [base cover](#).
- 8 Replace the [battery](#).

Removing the Display Assembly



WARNING: Before working inside your computer, read the safety information that shipped with your computer and follow the steps in [Before Working Inside Your Computer](#). After working inside your computer, follow the instructions in [After Working Inside Your Computer](#). For more safety best practices, see the Regulatory Compliance home page at dell.com/regulatory_compliance.

Prerequisites

- 1 Remove the [battery](#).
- 2 Remove the [base cover](#).
- 3 Remove the [optical-drive filler](#).
- 4 Remove the [keyboard](#).
- 5 Remove the [palm rest](#).

Procedure

- 1 Close the display and turn the computer over.
- 2 Remove the screws that secure the display hinges to the computer base.

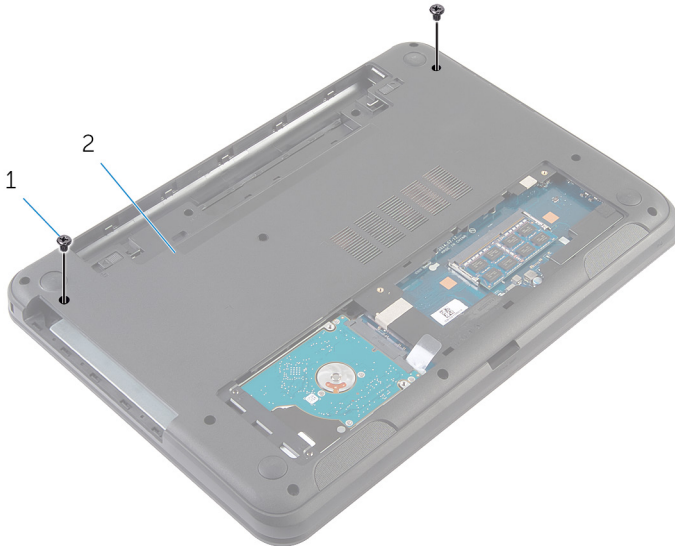

1 screws (2)

2 computer base

- 3 Turn the computer over and open the display as far as possible.
- 4 Disconnect the antenna cables from the wireless card. See "Removing the [Wireless Card](#)".
- 5 Note the antenna cables routing and remove the cables from the routing guides on the computer base.
- 6 Peel off the tape that secures the display cable to the system board.
- 7 Disconnect the display cable from the system board.

- 8 Note the display cable routing and remove the cable from the routing guides on the computer base.



- 1 antenna cables (2)
3 tape

- 2 display cable

- 9 Remove the screws that secure the display hinges to the computer base.

10 Lift the display assembly off the computer base.

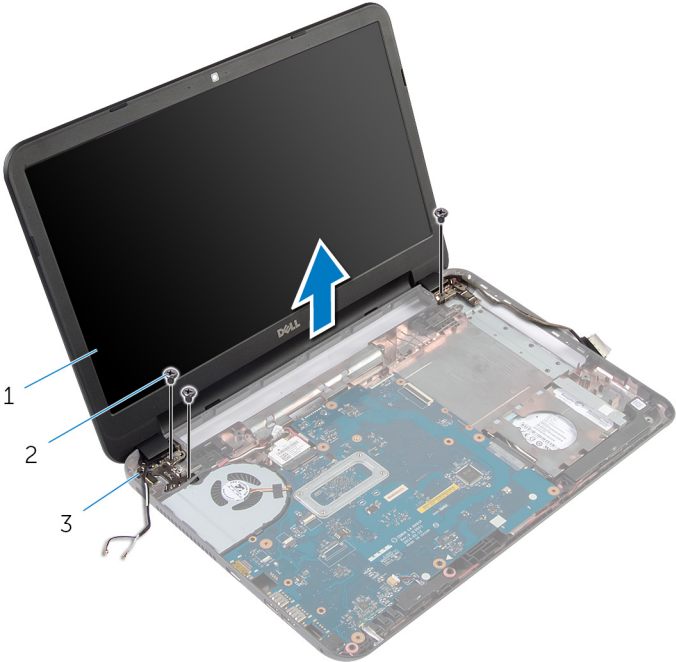

- 1 display assembly
- 3 display hinges (2)

- 2 screws (3)

Replacing the Display Assembly

 **WARNING:** Before working inside your computer, read the safety information that shipped with your computer and follow the steps in [Before Working Inside Your Computer](#). After working inside your computer, follow the instructions in [After Working Inside Your Computer](#). For more safety best practices, see the Regulatory Compliance home page at dell.com/regulatory_compliance.

Procedure

- 1 Align the screw holes on the display hinges with the screw holes on the computer base.
- 2 Replace the screws that secure the display hinges to the computer base.
- 3 Route the display cable through the routing guides on the computer base.
- 4 Connect the display cable to the system board and adhere the tape to the display cable.
- 5 Route the antenna cables through the routing guides on the computer base.
- 6 Connect the antenna cables to the wireless card. See "Replacing the [Wireless Card](#)".
- 7 Close the display and turn the computer over.
- 8 Replace the screws that secure the display hinges to the computer base.
- 9 Turn the computer over and open the display as far as possible.

Post-requisites

- 1 Replace the [palm rest](#).
- 2 Replace the [keyboard](#).
- 3 Replace the [optical-drive filler](#).
- 4 Replace the [base cover](#).
- 5 Replace the [battery](#).

Removing the Display Bezel



WARNING: Before working inside your computer, read the safety information that shipped with your computer and follow the steps in [Before Working Inside Your Computer](#). After working inside your computer, follow the instructions in [After Working Inside Your Computer](#). For more safety best practices, see the Regulatory Compliance home page at dell.com/regulatory_compliance.

Prerequisites

- 1 Remove the [battery](#).
- 2 Remove the [base cover](#).
- 3 Remove the [optical-drive filler](#).
- 4 Remove the [keyboard](#).
- 5 Remove the [palm rest](#).
- 6 Remove the [display assembly](#).

Procedure

- 1 Press and lift the hinge covers off the display bezel.

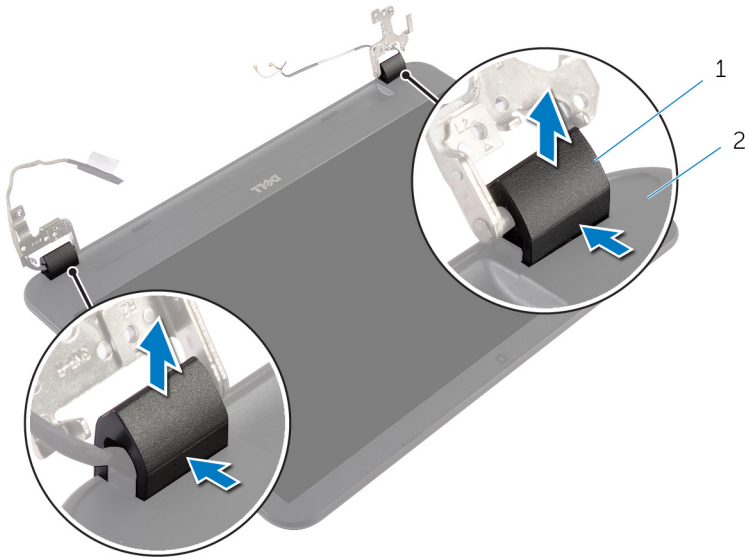

1 hinge covers (2)

2 display bezel

- 2 Using your fingertips, carefully pry up the inside edges of the display bezel and lift the display bezel off the display back-cover.

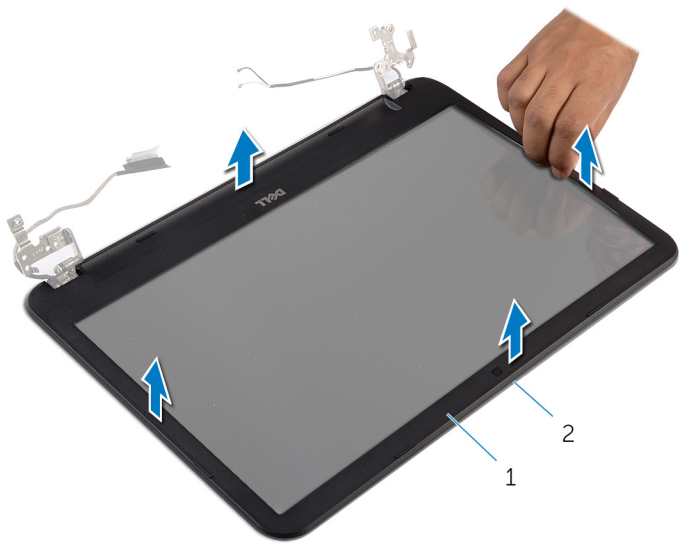

1 display bezel

2 display back-cover

Replacing the Display Bezel



WARNING: Before working inside your computer, read the safety information that shipped with your computer and follow the steps in [Before Working Inside Your Computer](#). After working inside your computer, follow the instructions in [After Working Inside Your Computer](#). For more safety best practices, see the Regulatory Compliance home page at dell.com/regulatory_compliance.

Procedure

- 1 Align the display bezel with the display back-cover and gently snap the display bezel into place.
- 2 Align the hinge covers with the display hinges and snap the hinge covers into place.

Post-requisites

- 1 Replace the [display assembly](#).
- 2 Replace the [palm rest](#).
- 3 Replace the [keyboard](#).
- 4 Replace the [optical-drive filler](#).
- 5 Replace the [base cover](#).
- 6 Replace the [battery](#).

Removing the Display Hinges



WARNING: Before working inside your computer, read the safety information that shipped with your computer and follow the steps in [Before Working Inside Your Computer](#). After working inside your computer, follow the instructions in [After Working Inside Your Computer](#). For more safety best practices, see the Regulatory Compliance home page at dell.com/regulatory_compliance.

Prerequisites

- 1 Remove the [battery](#).
- 2 Remove the [base cover](#).
- 3 Remove the [optical-drive filler](#).
- 4 Remove the [keyboard](#).
- 5 Remove the [palm rest](#).
- 6 Remove the [display assembly](#).
- 7 Remove the [display bezel](#).

Procedure

- 1 Remove the screws that secure the display hinges to the display back-cover.
- 2 Lift the display hinges off the display back-cover.

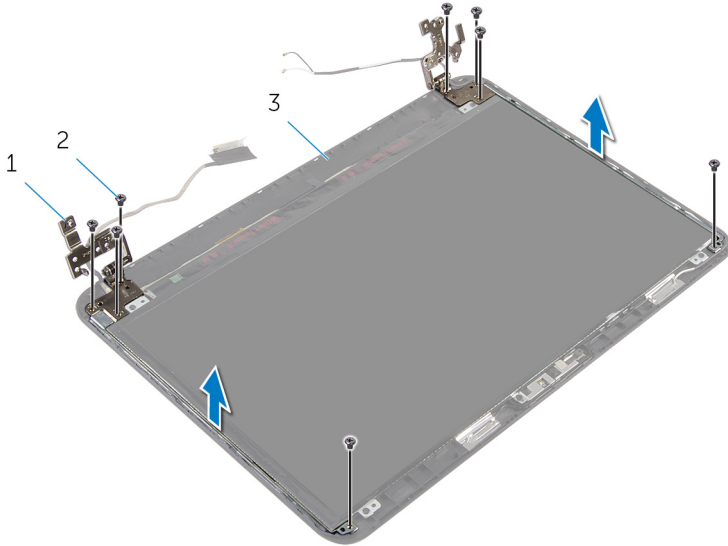

1 display hinges (2)

2 screws (8)

3 display back-cover

Replacing the Display Hinges



WARNING: Before working inside your computer, read the safety information that shipped with your computer and follow the steps in [Before Working Inside Your Computer](#). After working inside your computer, follow the instructions in [After Working Inside Your Computer](#). For more safety best practices, see the Regulatory Compliance home page at dell.com/regulatory_compliance.

Procedure

- 1 Align the screw holes on the display hinges with the screw holes on the display back-cover.
- 2 Replace the screws that secure the display hinges to the display back-cover.

Post-requisites

- 1 Replace the [display bezel](#).
- 2 Replace the [display assembly](#).
- 3 Replace the [palm rest](#).
- 4 Replace the [keyboard](#).
- 5 Replace the [optical-drive filler](#).
- 6 Replace the [base cover](#).
- 7 Replace the [battery](#).

Removing the Display Panel



WARNING: Before working inside your computer, read the safety information that shipped with your computer and follow the steps in [Before Working Inside Your Computer](#). After working inside your computer, follow the instructions in [After Working Inside Your Computer](#). For more safety best practices, see the Regulatory Compliance home page at dell.com/regulatory_compliance.

Prerequisites

- 1 Remove the [battery](#).
- 2 Remove the [base cover](#).
- 3 Remove the [optical-drive filler](#).
- 4 Remove the [keyboard](#).
- 5 Remove the [palm rest](#).
- 6 Remove the [display assembly](#).
- 7 Remove the [display bezel](#).

Procedure

- 1 Remove the screws that secure the display panel to the display back-cover.
- 2 Gently lift the display panel, turn it over, and place it on a flat and clean surface.

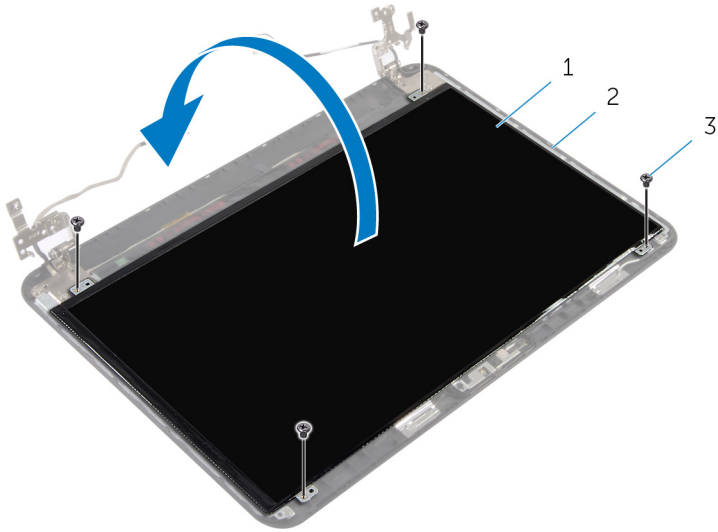

1 display panel

2 display back-cover

3 screws (4)

- 3 Peel off the tape that secures the display cable to the display panel.
- 4 Disconnect the display cable from the display panel.

5 Lift the display panel from the surface.

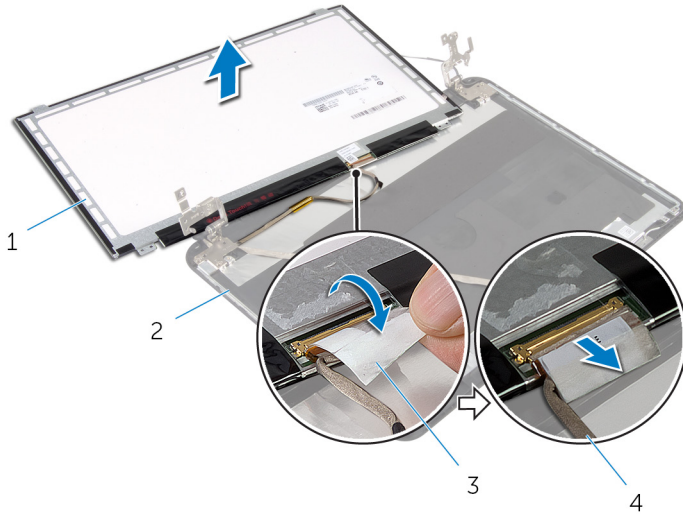

1 display panel

2 display back-cover

3 tape

4 display cable

Replacing the Display Panel



WARNING: Before working inside your computer, read the safety information that shipped with your computer and follow the steps in [Before Working Inside Your Computer](#). After working inside your computer, follow the instructions in [After Working Inside Your Computer](#). For more safety best practices, see the Regulatory Compliance home page at dell.com/regulatory_compliance.

Procedure

- 1 Connect the display cable to the display panel and adhere the tape to the display cable.
- 2 Gently place the display panel on the display back-cover.
- 3 Align the screw holes on the display panel with the screw holes on the display back-cover.
- 4 Replace the screws that secure the display panel to the display back-cover.

Post-requisites

- 1 Replace the [display bezel](#).
- 2 Replace the [display assembly](#).
- 3 Replace the [palm rest](#).
- 4 Replace the [keyboard](#).
- 5 Replace the [optical-drive filler](#).
- 6 Replace the [base cover](#).
- 7 Replace the [battery](#).

Removing the Camera



WARNING: Before working inside your computer, read the safety information that shipped with your computer and follow the steps in [Before Working Inside Your Computer](#). After working inside your computer, follow the instructions in [After Working Inside Your Computer](#). For more safety best practices, see the Regulatory Compliance home page at dell.com/regulatory_compliance.

Prerequisites

- 1 Remove the [battery](#).
- 2 Remove the [base cover](#).
- 3 Remove the [optical-drive filler](#).
- 4 Remove the [keyboard](#).
- 5 Remove the [palm rest](#).
- 6 Remove the [display assembly](#).
- 7 Remove the [display bezel](#).

Procedure

- 1 Remove the screws that secure the display panel to the display back-cover.
- 2 Gently lift the display panel, turn it over, and place it on a flat and clean surface.

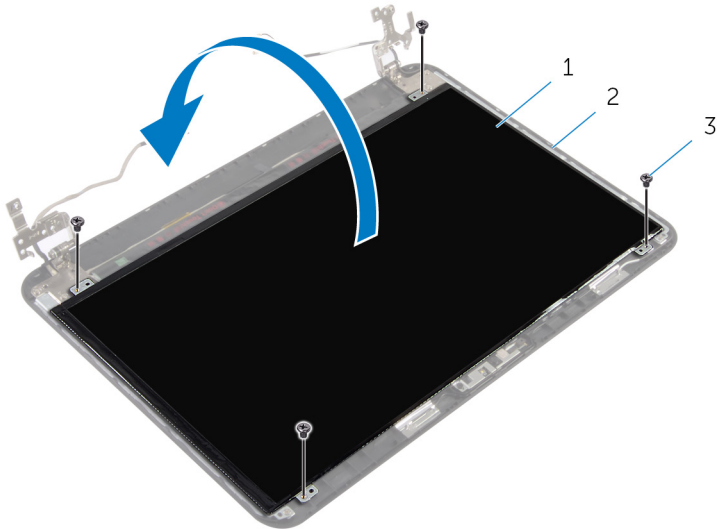

- | | | | |
|---|---------------|---|--------------------|
| 1 | display panel | 2 | display back-screw |
| 3 | screws (4) | | |

- 3 Remove the screw that secures the camera module to the display back-cover.
- 4 Disconnect the camera cable from the camera module.
- 5 Carefully pry out the camera module from the display back-cover.

- 6 Lift the camera module at an angle and release it from the tab on the display back-cover.

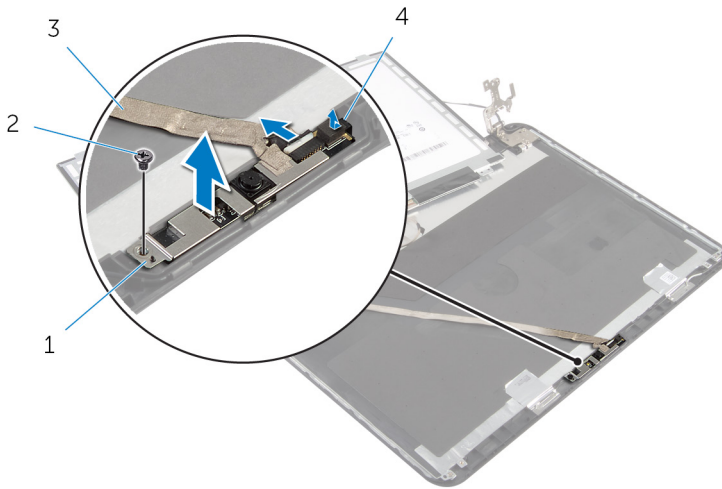

1 camera module

2 screw

3 camera cable

4 tab

Replacing the Camera



WARNING: Before working inside your computer, read the safety information that shipped with your computer and follow the steps in [Before Working Inside Your Computer](#). After working inside your computer, follow the instructions in [After Working Inside Your Computer](#). For more safety best practices, see the Regulatory Compliance home page at dell.com/regulatory_compliance.

Procedure

- 1 Slide the camera under the tab on the display back-cover and adhere the camera module to the display back-cover.
- 2 Connect the camera cable to the camera module.
- 3 Replace the screw that secures the camera module to the display back-cover.
- 4 Gently place the display panel on the display back-cover.
- 5 Align the screw holes on the display panel with the screw holes on the display back-cover.
- 6 Replace the screws that secure the display panel to the display back-cover.

Post-requisites

- 1 Replace the [display bezel](#).
- 2 Replace the [display assembly](#).
- 3 Replace the [palm rest](#).
- 4 Replace the [keyboard](#).
- 5 Replace the [optical-drive filler](#).
- 6 Replace the [base cover](#).
- 7 Replace the [battery](#).

Removing the Power-Adapter Port



WARNING: Before working inside your computer, read the safety information that shipped with your computer and follow the steps in [Before Working Inside Your Computer](#). After working inside your computer, follow the instructions in [After Working Inside Your Computer](#). For more safety best practices, see the Regulatory Compliance home page at dell.com/regulatory_compliance.

Prerequisites

- 1 Remove the [battery](#).
- 2 Remove the [base cover](#).
- 3 Remove the [optical-drive filler](#).
- 4 Remove the [keyboard](#).
- 5 Remove the [palm rest](#).
- 6 Remove the [wireless card](#).
- 7 Remove the [display assembly](#).

Procedure

- 1 Disconnect the power-adapter port cable from the system board.
- 2 Remove the power-adapter port cable from the routing guides on the computer base.

3 Lift the power-adapter port along with its cable off the computer base.

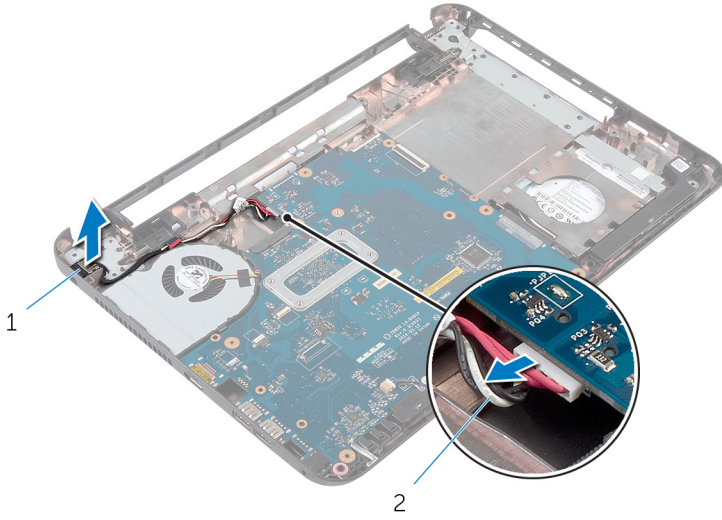

1 power-adapter port

2 power-adapter port cable

Replacing the Power-Adapter Port



WARNING: Before working inside your computer, read the safety information that shipped with your computer and follow the steps in [Before Working Inside Your Computer](#). After working inside your computer, follow the instructions in [After Working Inside Your Computer](#). For more safety best practices, see the Regulatory Compliance home page at dell.com/regulatory_compliance.

Procedure

- 1 Slide the power-adapter port into the slot on the computer base.
- 2 Route the power-adapter port cable through the routing guides on the computer base.
- 3 Connect the power-adapter port cable to the system board.

Post-requisites

- 1 Replace the [display assembly](#).
- 2 Replace the [wireless card](#).
- 3 Replace the [palm rest](#).
- 4 Replace the [keyboard](#).
- 5 Replace the [optical-drive filler](#).
- 6 Replace the [base cover](#).
- 7 Replace the [battery](#).

Flashing the BIOS

You may need to flash (update) the BIOS when an update is available or when you replace the system board. To flash the BIOS:

- 1 Turn on the computer.
- 2 Go to **dell.com/support**.
- 3 If you have your computer's Service Tag, type your computer's Service Tag and click **Submit**.
If you do not have your computer's Service Tag, click **Detect My Product** to allow automatic detection of the Service Tag.
 **NOTE:** If the Service Tag cannot be detected automatically, select your product under the product categories.
- 4 Click **Get Drivers and Downloads**.
- 5 Click **View All Drivers**.
- 6 In the **Operating System** drop-down, select the operating system installed on your computer.
- 7 Click **BIOS**.
- 8 Click **Download File** to download the latest version of the BIOS for your computer.
- 9 On the next page, select **Single-file download** and click **Continue**.
- 10 Save the file and once the download is complete, navigate to the folder where you saved the BIOS update file.
- 11 Double-click the BIOS update file icon and follow the instructions on the screen.

Getting Help and Contacting Dell

Self-Help Resources

You can get information and help on Dell products and services using these online self-help resources:

Self-Help Information	Self-Help Options
Accessing Windows Help	Windows 8.1 — Open the Search charm, type Help and Support in the search box and press Enter . Windows 7 — Click Start → Help and Support .
Information about Dell products and services	See dell.com .
Troubleshooting information, user manuals, setup instructions, product specifications, technical help blogs, drivers, software updates, and so on	See dell.com/support .
Information about Microsoft Windows 8/8.1	See dell.com/windows8 .
Information about Microsoft Windows 7	Click Start → All Programs → Dell Help Documentation .
Learn about your operating system, setting up and using your computer, data backup, diagnostics, and so on.	See <i>Me and My Dell</i> at dell.com/support/manuals .

Contacting Dell

To contact Dell for sales, technical support, or customer service issues, see **dell.com/contactdell**.

 **NOTE:** Availability varies by country and product, and some services may not be available in your country.



NOTE: If you do not have an active internet connection, you can find contact information on your purchase invoice, packing slip, bill, or Dell product catalog.