

# INSPIRON™

## SETUP GUIDE





# INSPIRON™

## SETUP GUIDE

Model PP42L

# Notes, Cautions, and Warnings

 **NOTE:** A NOTE indicates important information that helps you make better use of your computer.

 **CAUTION:** A CAUTION indicates either potential damage to hardware or loss of data and tells you how to avoid the problem.

 **WARNING:** A WARNING indicates a potential for property damage, personal injury, or death.

---

Information in this document is subject to change without notice.

© 2009 Dell Inc. All rights reserved.

Reproduction of these materials in any manner whatsoever without the written permission of Dell Inc. is strictly forbidden.

Trademarks used in this text: *Dell*, the *DELL* logo, *Inspiron*, *YOURS IS HERE*, and *DellConnect* are trademarks of Dell Inc.; *Intel*, *Celeron*, and *Pentium* are registered trademarks and *Core* is a trademark of Intel Corporation in the U.S. and other countries; *Microsoft*, *Windows*, *Windows Vista*, and *Windows Vista* start button logo are either trademarks or registered trademarks of Microsoft Corporation in the United States and/or other countries; *Blu-ray Disc* is a registered trademark of the Blu-ray Disc Association; *Bluetooth* is a registered trademark owned by Bluetooth SIG, Inc. and is used by Dell under license.

Other trademarks and trade names may be used in this document to refer to either the entities claiming the marks and names or their products. Dell Inc. disclaims any proprietary interest in trademarks and trade names other than its own.

March 2009

P/N M792N

Rev. A00

# Contents

<b>Setting Up Your Inspiron™ Laptop</b> . . . . .	<b>5</b>	Media Controls . . . . .	22
Before Setting Up Your Computer . . . . .	5	Display Features . . . . .	24
Connect the AC Adapter . . . . .	6	Removing and Replacing the Battery . . . . .	26
Connect the Network Cable (Optional) . . . . .	7	Software Features . . . . .	28
Press the Power Button . . . . .	8	<b>Solving Problems</b> . . . . .	<b>30</b>
Windows Vista® Setup . . . . .	9	Network Problems . . . . .	30
Enable or Disable Wireless . . . . .	9	Power Problems . . . . .	32
Connect to the Internet (Optional) . . . . .	10	Memory Problems . . . . .	33
<b>Using Your Inspiron™ Laptop</b> . . . . .	<b>12</b>	Lockups and Software Problems . . . . .	34
Right Side Features . . . . .	12	<b>Using Support Tools</b> . . . . .	<b>36</b>
Left Side Features . . . . .	14	Dell Support Center . . . . .	36
Front Side Features . . . . .	16	System Messages . . . . .	38
Computer Base and Keyboard Features . . . . .	18	Hardware Troubleshooter . . . . .	39
Touch Pad Gestures . . . . .	20	Dell Diagnostics . . . . .	40

## Contents

<b>Restoring Your Operating System</b> .....	<b>42</b>
System Restore .....	42
Dell Factory Image Restore .....	44
Operating System Reinstallation .....	46
<b>Getting Help</b> .....	<b>48</b>
Technical Support and Customer Service .....	49
Online Services .....	50
Automated Order-Status Service.....	51
Product Information.....	51
Before You Call.....	52
Contacting Dell.....	53
<b>Finding More Information and Resources</b> .....	<b>54</b>
<b>Specifications</b> .....	<b>56</b>
<b>Index</b> .....	<b>63</b>

# Setting Up Your Inspiron™ Laptop

This section provides information about setting up your Inspiron 1440 laptop and connecting peripherals.

## Before Setting Up Your Computer

When positioning your computer, ensure that you allow easy access to a power source, adequate ventilation, and a level surface to place your computer.

Restricting airflow around your Inspiron laptop may cause it to overheat. To prevent overheating ensure that you leave at least 10.2 cm (4 inches) at the back of the computer and a minimum of 5.1 cm (2 inches) on all other sides. You should never place your computer in an enclosed space, such as a cabinet or drawer when it is powered on.

 **WARNING:** Do not block, push objects into, or allow dust to accumulate in the air vents. Do not place your Dell™ computer in a low-airflow environment, such as a closed briefcase, while it is powered on. Restricting the airflow can damage the computer or cause a fire. The computer turns on the fan when the computer gets hot. Fan noise is normal and does not indicate a problem with the fan or the computer.

 **CAUTION:** Placing or stacking heavy or sharp objects on the computer may result in permanent damage to the computer.

## Connect the AC Adapter

Connect the AC adapter to the computer and then plug it into a wall outlet or surge protector.

**⚠ WARNING:** The AC adapter works with electrical outlets worldwide. However, power connectors and power strips vary among countries. Using an incompatible cable or improperly connecting the cable to a power strip or electrical outlet may cause fire or permanent damage to your computer.

**📌 NOTE:** Charge the computer battery for at least 12 hours before using your computer on battery power.

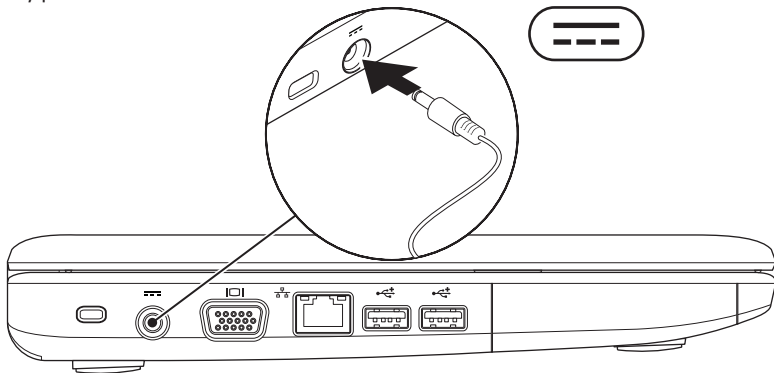



## Connect the Network Cable (Optional)

To use a wired network connection, connect the network cable.

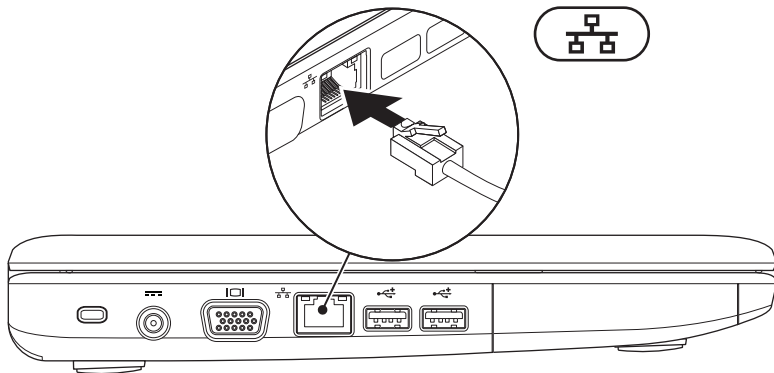

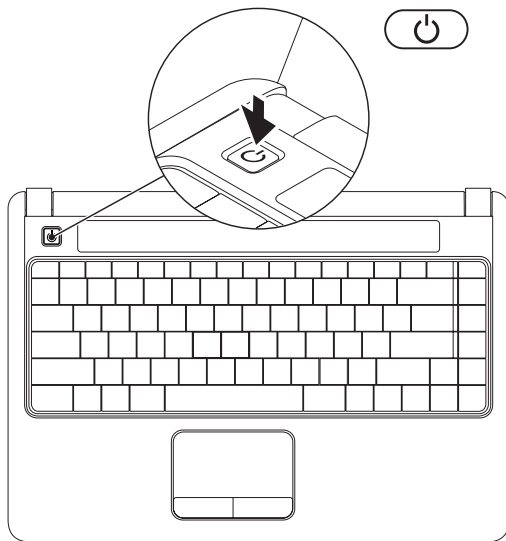

## Press the Power Button



## Windows Vista® Setup

If you selected Windows Vista operating system while ordering, your Dell computer is preconfigured with Windows Vista. To set up Windows Vista for the first time, follow the instructions on the screen. These steps are mandatory and may take up to 15 minutes to complete. The screens will take you through several procedures including accepting license agreements, setting preferences, and setting up an Internet connection.

 **CAUTION:** Do not interrupt the operating system's setup process. Doing so may render your computer unusable.

 **NOTE:** It is recommended that you download and install the latest BIOS and drivers for your computer available on the Dell Support website at [support.dell.com](http://support.dell.com).

## Enable or Disable Wireless

To turn on wireless, with the computer turned on:

1. Press <Fn><F2> or press the  key on the keyboard.

The **Wireless Enable/Disable** dialog box appears.

2. Select one of the following:
  - **Enable Bluetooth**
  - **Enable Wireless LAN**
3. Click **OK**.

To turn off wireless, press <Fn><F2> again to turn off all radios.

## Connect to the Internet (Optional)

 **NOTE:** Internet Service Providers (ISPs) and ISP offerings vary by country.

To connect to the Internet, you need an external modem or network connection and an ISP.

If WLAN adapter is not a part of your original order, you can purchase one from the Dell website at [www.dell.com](http://www.dell.com).

 **NOTE:** If you cannot connect to the Internet but have successfully connected in the past, the ISP might have a service outage. Contact your ISP to check the service status, or try connecting again later.

Have your ISP information ready. If you do not have an ISP, then **Connect to the Internet** wizard can help you get one.

## Setting Up a Wired Connection

- If you are using a dial-up connection, connect the telephone line to the external USB modem (optional) and to the telephone wall jack before you set up your Internet connection.
- If you are using a DSL or cable/satellite modem connection, contact your ISP or cellular telephone service for setup instructions.

To complete setting up your wired internet connection, follow the instructions in “Setting Up Your Internet Connection” on page 11.

## Setting Up a Wireless Connection

 **NOTE:** To set up your wireless router, see the documentation that shipped with your router.

Before you can use your wireless Internet connection, you need to connect to your wireless router. To set up your connection to a wireless router:

1. Save and close any open files, and exit any open programs.
2. Click **Start**  → **Connect To**.
3. Follow the instructions on the screen to complete the setup.

## Setting Up Your Internet Connection

1. Save and close any open files, and exit any open programs.
2. Click **Start**  → **Control Panel**.
3. Under **Network and Internet**, click **Connect to the Internet**.

The **Connect to the Internet** window appears.

4. Click either **Broadband (PPPoE)** or **Dial-up**, depending on how you want to connect:
  - Choose **Broadband** if you use a DSL, satellite modem, cable TV modem, or Bluetooth® wireless technology connection.
  - Chose **Dial-up** if you use an optional USB dial-up modem or ISDN.

 **NOTE:** If you do not know which type of connection to select, click **Help me choose** or contact your ISP.



5. Follow the instructions on the screen and use the setup information provided by your ISP to complete the setup.

# Using Your Inspiron™ Laptop

Your Inspiron 1440 laptop has indicators and buttons that provide information and enable you to perform common tasks. The connectors on your computer provide the option of attaching additional devices.

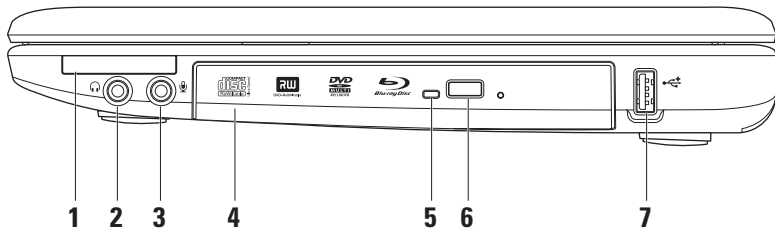
## Right Side Features



- 
-  **ExpressCard slot** – Provides support for additional memory, wired and wireless communications, multimedia, and security features. Supports 34 mm ExpressCards.  
 **NOTE:** Your computer ships with a plastic *blank* installed in the ExpressCard slot. Blanks protect unused slots from dust and other particles. Save the blank for use when no ExpressCard is installed in the slot; blanks from other computers may not fit your computer.

---

  -  **Audio out/Headphone connector** – Connects to a pair of headphones, or sends audio to a powered speaker or sound system.

---

  -  **Audio in/Microphone connector** – Connects to a microphone or input signal for use with audio programs.

---

  - Optical drive** – Plays or burns CDs, DVDs, Blu-ray disc (optional). Ensure that the side with print or writing is facing upward when inserting discs.

---

  - Optical drive light** – Blinks when you press the optical drive eject button or when you insert a disc and it is being read.

---

  - Optical drive eject button** – Opens the optical drive.

---

  -  **USB 2.0 connector** – Connects to USB devices, such as a mouse, keyboard, printer, external drive, or MP3 player.

## Left Side Features

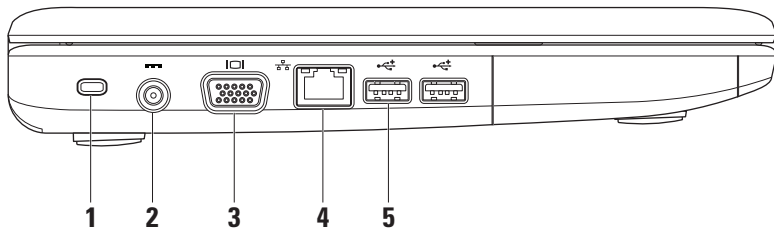





- 
- 1 **Security cable slot** – Attaches a commercially available antitheft device to the computer.

 **NOTE:** Before you buy an antitheft device, ensure that it works with the security cable slot on your computer.

---

- 2  **AC adapter connector** – Connects to the AC adapter to power the computer and charge the battery.
- 

- 3  **VGA connector** – Connects to a monitor or projector.
- 

- 4  **Network connector** – Connects your computer to a network or a broadband device if you are using a wired network.
- 

- 5  **USB 2.0 connectors (2)** – Connects to USB devices, such as a mouse, keyboard, printer, external drive, or MP3 player.
-

## Front Side Features

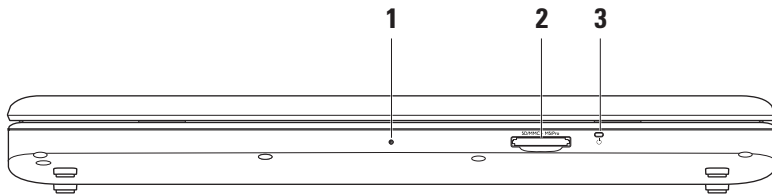

---

**1 Integrated single analog microphone** – Provides quality sound for video chatting and voice recording.

---

**2**  **7-in-1 Media Card Reader** – Provides a fast and convenient way to view and share digital photos, music, videos, and documents stored on these digital memory cards:

- Secure digital (SD) memory card
  - Secure Digital Input Output (SDIO) card
  - Multi Media Card (MMC)
  - Memory Stick
  - Memory Stick PRO
  - Hi Speed-SD
  - Hi Density-SD
- 

**3**  **Power/Battery indicator light** – Turns on steadily or blinks to indicate power/battery charge status. The light indicates the following states while charging or using the computer with:

*an AC adapter*

- Solid white – The computer is on/off and the battery is charging.
- Blinking white – The computer is in standby mode.
- Off – The computer is off or in hibernate mode.

*a battery*

- Solid white – The computer is on.
- Blinking white – The computer is in standby mode.
- Solid amber – The battery charge is low. Connect the AC adapter to charge the battery.
- Off – The computer is off or in hibernate mode

## Computer Base and Keyboard Features

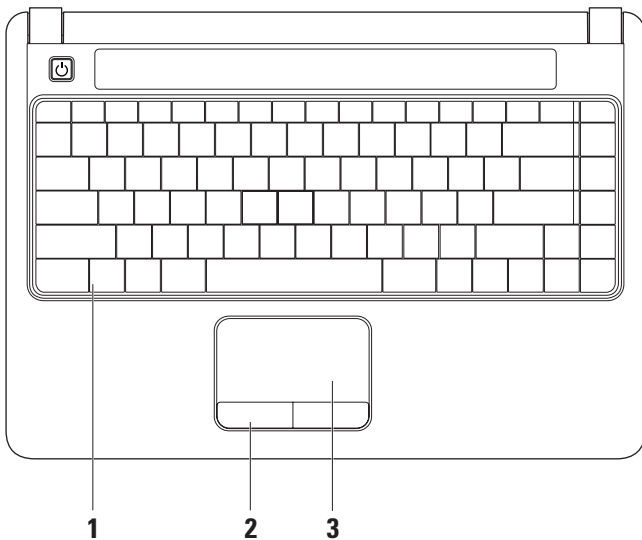

- 
- 1 Keyboard** – For more information about the keyboard, see the *Dell Technology Guide*. The media controls are also located on the keyboard. These keys control CD, DVD, Blu-ray (optional), and media playback.
- 
- 2 Touch pad buttons** – Provide left- and right-click functions like those on a mouse.
- 
- 3 Touch pad** – Provides the functionality of a mouse to move the cursor, drag or move selected items, and left-click by tapping the surface.

## Touch Pad Gestures

### Scroll

Allows you to scroll through content. The scroll feature includes:

**Traditional Scroll** – Allows you to scroll up and down, or right and left.

To scroll up and down:

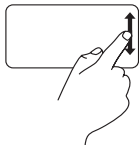

Move a finger up or down in the vertical scroll zone (extreme right of the touch pad) to scroll up or down on the active window.

To scroll right and left:

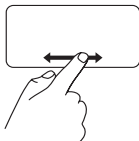

Move a finger right or left in the horizontal scroll zone (extreme bottom of the touch pad) to scroll right or left on the active window.

**Circular Scroll** – Allows you to scroll up and down, or right and left.

To scroll up and down:



Move a finger in the vertical scroll zone (extreme right of the touch pad), in a clockwise circular motion to scroll up or counterclockwise circular motion to scroll down.

To scroll right and left:



Move a finger in the horizontal scroll zone (extreme bottom of the touch pad), in a clockwise circular motion to scroll right or counterclockwise circular motion to scroll left.

## Zoom

Allows you to increase or decrease the magnification of the screen content. The zoom feature includes:

**One finger zoom** – Allows you to zoom in or out.

To zoom in:

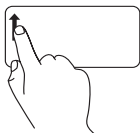

Move a finger up in the zoom zone (extreme left of the touch pad) to zoom in.

To zoom out:

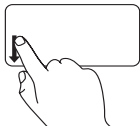

Move a finger down in the zoom zone (extreme left of the touch pad) to zoom out.

## Media Controls

You can configure the media control keys using the **Function Key Behavior** in the **System Setup** utility. The options in the **Function Key Behavior** setting are:

**Multimedia Key First** – This is the default setting. Pressing any media control key performs the associated multimedia action. For function key, press <Fn> + the required function key.

**Function Key First** – Pressing any function key performs the associated function. For multimedia action, press <Fn> + the required media control key.

 **NOTE:** The **Multimedia Key First** option is active only in the operating system. During POST, press <F2> or <F12> directly.





---

 Mute the sound

---

 Turn down the volume

---

 Turn up the volume

---

 Play the previous track or chapter

---

 Play or pause

---

 Play the next track or chapter

---

 Eject the disc

---

## Display Features

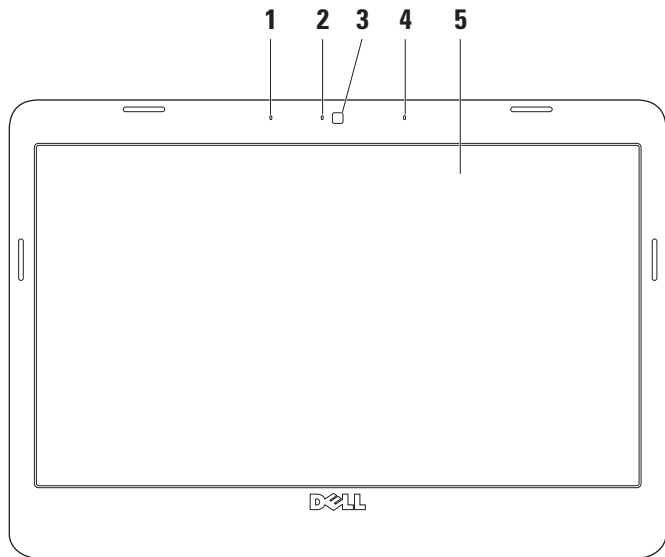

- 
- 1 Left digital array microphone (optional)** – Combines with the right digital array microphone to provide high quality sound for video chatting and voice recording.
- 
- 2 Camera activity light (optional)** – Indicates if the camera is on or off. Based on selections you made when purchasing your computer, your computer may not include a camera.
- 
- 3 Camera (optional)** – Built-in camera for video capture, conferencing, and chat. Based on the selections you made when purchasing your computer, your computer may not include a camera.
- 
- 4 Right digital array microphone (optional)** – Combines with the left digital array microphone to provide high quality sound for video chatting and voice recording.
- 
- 5 Display** – Your display can vary based on selections you made when purchasing your computer. For more information about displays, see the *Dell Technology Guide*.

## Removing and Replacing the Battery

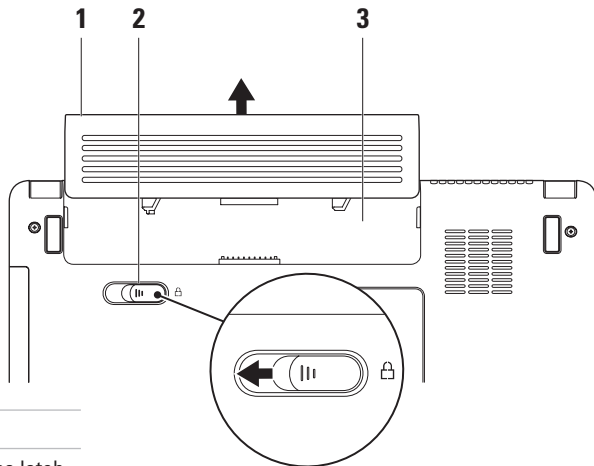

---



**1** Battery

---

**2** Battery release latch

---

**3** Battery bay

-  **WARNING:** Before you begin any of the procedures in this section, follow the safety instructions that shipped with your computer.
-  **WARNING:** Using an incompatible battery may increase the risk of fire or explosion. This computer should only use a battery purchased from Dell. Do not use batteries from other computers.
-  **WARNING:** Before removing the battery, shut down the computer, and remove external cables (including the AC adapter).

### **To remove the battery:**

1. Shut down the computer and turn it over.
2. Slide the battery release latch to the side.
3. Slide the battery away from the battery bay.

To replace the battery, slide it into the bay until it clicks into place.

## Software Features

 **NOTE:** For more information about the features described in this section, see the *Dell Technology Guide* on your hard drive or on the Dell Support website at [support.dell.com](http://support.dell.com).

### Productivity and Communication

You can use your computer to create presentations, brochures, greeting cards, fliers, and spreadsheets depending on the applications installed in your computer. Check your purchase order for software installed on your computer.

After connecting to the Internet, you can access websites, setup an e-mail account, upload and download files, and so on.

### Entertainment and Multimedia

You can use your computer to watch videos, play games, listen to music and internet radio stations.

## Customizing the Desktop

You can customize your desktop to change the appearance, resolution, wallpaper, screensaver, and so on by accessing the **Personalize appearance and sounds** window.

To access the display properties window:

1. Right-click an open area of the desktop.
2. Click **Personalize**, to open the **Personalize appearance and sounds** window and learn more about your customization options.

### Customizing Your Energy Settings

You can use the power options in your operating system to configure the power settings on your computer.

Microsoft® Windows Vista® provides three default options:

- **Balanced** — This power option offers full performance when you need it and saves power during periods of inactivity.

- **Power saver** — This power option saves power on your computer by reducing system performance to maximize the life of the computer and by reducing the amount of energy consumed by your computer over its lifetime.
- **High performance** — This power option provides the highest level of system performance on your computer by adapting processor speed to your activity and by maximizing system performance.

## Transferring Information to a New Computer

1. Click **Start**  → **Transfer files and settings** → **Start Windows Easy Transfer**.
2. In the **User Account Control** window, click **Continue**.
3. Click **Start a new transfer** or **Continue a transfer in progress**.

Follow the instructions on the **Windows Easy Transfer** wizard.

## Backing Up Your Data

It is recommended that you periodically back up files and folders on your computer.

To back up files:

1. Click **Start**  → **Control Panel** → **System and Maintenance** → **Welcome Center** → **Transfer files and settings**.
2. Click **Back up files** or **Back up computer**.
3. Click **Continue** on the **User Account Control** window and follow the instructions on the **Back up Files** wizard.

# Solving Problems

This section provides troubleshooting information for your computer. If you cannot solve your problem using the following guidelines, see “Using Support Tools” on page 36 or see “Contacting Dell” on page 53.

## Network Problems

### Wireless Connections

**If the wireless network connection is lost** — The wireless router is offline or wireless has been disabled on the computer.

- Check your wireless router to ensure it is powered on and connected to your data source (cable modem or network hub).

- Interference may be blocking or interrupting your wireless connection. Try moving the computer closer to your wireless router.
- Re-establish your connection to the wireless router:
  - a. Save and close any open files, and exit any open programs.
  - b. Click **Start**  → **Connect To**.
  - c. Follow the instructions on the screen to complete the setup.



## Wired Connections

**If the wired network connection is lost** — The cable is loose or damaged.

- Check the cable to ensure it is plugged in and not damaged.

The link integrity light on the integrated network connector lets you verify that your connection is working and provides information on the status:

- Green — A good connection exists between a 10-Mbps network and the computer.
- Orange — A good connection exists between a 100-Mbps network and the computer.
- Off — The computer is not detecting a physical connection to the network.

 **NOTE:** The link integrity light on the network connector is only for the wired network connection. The link integrity light does not provide status for wireless connections.

# Power Problems

**If the power light is off** — The computer is either turned off or is not receiving power.

- Reseat the power cable into both the power connector on the computer and the electrical outlet.
- If the computer is plugged into a power strip, ensure that the power strip is plugged into an electrical outlet and that the power strip is turned on. Also bypass power protection devices, power strips, and power extension cables to verify that the computer turns on properly.
- Ensure that the electrical outlet is working by testing it with another device, such as a lamp.
- Check the AC adapter cable connections. If the AC adapter has a light, ensure that the light on the AC adapter is on.

**If the power light is solid white and the computer is not responding** — The display may not be responding. Press the power button until the computer turns off and then turn it back on.

**If the power light is blinking white** — The computer is in standby mode. Press a key on the keyboard, move the pointer using the touch pad or a connected mouse, or press the power button to resume normal operation.

**If you encounter interference that hinders reception on your computer** — An unwanted signal is creating interference by interrupting or blocking other signals. Some possible causes of interference are:

- Power, keyboard, and mouse extension cables.
- Too many devices connected to a power strip.
- Multiple power strips connected to the same electrical outlet.

## Memory Problems

### If you receive an insufficient memory message —

- Save and close any open files and exit any open programs you are not using to see if that resolves the problem.
- See the software documentation for minimum memory requirements. If necessary, install additional memory (see the *Service Manual* on the Dell Support website at [support.dell.com](http://support.dell.com)).
- Reseat the memory modules (see the *Service Manual* on the Dell Support website at [support.dell.com](http://support.dell.com)) to ensure that your computer is successfully communicating with the memory.

### If you experience other memory problems —

- Ensure that you are following the memory installation guidelines (see the *Service Manual* on the Dell Support website at [support.dell.com](http://support.dell.com)).
- Check if the memory module is compatible with your computer. Your computer supports DDR2 memory. For more information about the type of memory supported by your computer, see “Specifications” on page 56.
- Run the Dell Diagnostics (see “Dell Diagnostics” on page 40).
- Reseat the memory modules (see the *Service Manual* on the Dell Support website at [support.dell.com](http://support.dell.com)) to ensure that your computer is successfully communicating with the memory.

## Lockups and Software Problems

**If the computer does not start up** — Ensure that the power cable is firmly connected to the computer and to the electrical outlet.

**If a program stops responding** — End the program:

1. Press <Ctrl><Shift><Esc> simultaneously.
2. Click **Applications**.
3. Click the program that is no longer responding
4. Click **End Task**.

**If a program crashes repeatedly** — Check the software documentation. If necessary, uninstall and then reinstall the program.

 **NOTE:** Software usually includes installation instructions in its documentation or on the disc (CD or DVD).

**If the computer stops responding or a solid blue screen appears** —

 **CAUTION:** You might lose data if you are unable to perform an operating system shutdown.

If you are unable to get a response by pressing a key on your keyboard or moving your mouse, press the power button for at least 8 to 10 seconds until the computer turns off and then restart your computer.

**If a program is designed for an earlier Microsoft® Windows® operating system** —

Run the Program Compatibility Wizard. The Program Compatibility Wizard configures a program so that it runs in an environment similar to non-Windows Vista operating system environments.

1. Click **Start**  → **Control Panel** → **Programs** → **Use an older program with this version of Windows**.
2. In the welcome screen, click **Next**.
3. Follow the instructions on the screen.

#### **If you have other software problems —**

- Back up your files immediately.
- Use a virus-scanning program to check the hard drive or CDs.
- Save and close any open files or programs and shut down your computer through the **Start**  menu.
- Check the software documentation or contact the software manufacturer for troubleshooting information:
  - Ensure that the program is compatible with the operating system installed on your computer.
  - Ensure that your computer meets the minimum hardware requirements needed to run the software. See the software documentation for information.
  - Ensure that the program is installed and configured properly.
  - Verify that the device drivers do not conflict with the program.
  - If necessary, uninstall and then reinstall the program.

# Using Support Tools

## Dell Support Center

The **Dell Support Center** helps you find the service, support, and system-specific information you need. For more information about **Dell Support Center** and available support tools, click the **Services** tab at [support.dell.com](http://support.dell.com).

Click the  icon in the taskbar to run the application. The home page provides links to access:

- Self Help (Troubleshooting, Security, System Performance, Network/Internet, Backup/Recovery, and Windows operating system)
- Alerts (technical support alerts relevant to your computer)
- Assistance from Dell (Technical Support with DellConnect™, Customer Service, Training and Tutorials, How-To Help with Dell on Call, and Online Scan with PCCheckUp)
- About Your System (System Documentation, Warranty Information, System Information, Upgrades & Accessories)

The top of the **Dell Support Center** home page displays your computer's model number along with its service tag and express service code.

For more information about the **Dell Support Center**, see the *Dell Technology Guide* on your hard drive or on the Dell Support website at **[support.dell.com](http://support.dell.com)**.

# System Messages

If your computer has an issue or error, it may display a System Message that will help you identify the cause and action needed to resolve the issue.

 **NOTE:** If the message you received is not listed in the following examples, see the documentation for either the operating system or the program that was running when the message appeared. Alternatively you could see the *Service Manual* on the Dell Support website at [support.dell.com](http://support.dell.com) or see “Contacting Dell” on page 53 for assistance.

**Alert! Previous attempts at booting this system have failed at checkpoint [nnnn]. For help in resolving this problem, please note this checkpoint and contact Dell Technical Support** — The computer failed to complete the boot routine three consecutive times for the same error. See “Contacting Dell” on page 53 for assistance.

**CMOS checksum error** — Possible motherboard failure or RTC battery low. Replace the battery. See the *Service Manual* on the Dell Support website at [support.dell.com](http://support.dell.com) or see “Contacting Dell” on page 53 for assistance.

**Hard-disk (HDD) drive failure** — Possible hard disk drive failure during HDD POST. See “Contacting Dell” on page 53 for assistance.

**Hard-disk (HDD) drive read failure** — Possible hard disk drive failure during HDD boot test. See “Contacting Dell” on page 53 for assistance.

**Keyboard failure** — Keyboard failure or loose cable.

**No boot device available** — No bootable partition on hard disk drive, the hard disk drive connector is loose, or no bootable device exists.

- If the hard drive is your boot device, ensure that the connector is connected and that the drive is installed properly and partitioned as a boot device.



- Enter system setup and ensure that the boot sequence information is correct (see the *Service Manual* on the Dell Support website at [support.dell.com](http://support.dell.com)).

**No timer tick interrupt** — A chip on the system board might be malfunctioning or motherboard failure (see the *Service Manual* on the Dell Support website at [support.dell.com](http://support.dell.com)).

**USB over current error** — Disconnect the USB device. Your USB device needs more power for it to function properly. Use an external power source to connect the USB device, or if your device has two USB cables, connect both of them.

**NOTICE - Hard Drive SELF MONITORING SYSTEM has reported that a parameter has exceeded its normal operating range. Dell recommends that you back up your data regularly. A parameter out of range may or may not indicate a potential hard drive problem** — S.M.A.R.T error, possible hard disk drive failure.

This feature can be enabled or disabled in the BIOS setup (see “Contacting Dell” on page 53 for assistance).

## Hardware Troubleshooter

If a device is either not detected during the operating system setup or is detected but incorrectly configured, you can use the **Hardware Troubleshooter** to resolve the incompatibility.

To start the Hardware Troubleshooter:

1. Click **Start**  → **Help and Support**.
2. Type `hardware troubleshooter` in the search field and press <Enter> to start the search.
3. In the search results, select the option that best describes the problem and follow the remaining troubleshooting steps.

### Dell Diagnostics

If you experience a problem with your computer, perform the checks in “Lockups and Software Problems” on page 34 and run the Dell Diagnostics before you contact Dell for technical assistance.

It is recommended that you print these procedures before you begin.

 **NOTE:** Dell Diagnostics works only on Dell computers.

 **NOTE:** The *Drivers and Utilities* disc is optional and may not ship with your computer.

See the System Setup section in the *Service Manual* to review your computer’s configuration information, and ensure that the device that you want to test displays in the system setup program and is active.

Start the Dell Diagnostics from your hard drive or from the *Drivers and Utilities* disc.

### Starting Dell Diagnostics From Your Hard Drive

The Dell Diagnostics is located on a hidden diagnostic utility partition on your hard drive.

 **NOTE:** If your computer cannot display a screen image, see “Contacting Dell” on page 53.

1. Ensure that the computer is connected to an electrical outlet that is known to be working properly.
2. Turn on (or restart) your computer.
3. When the DELL™ logo appears, press <F12> immediately. Select **Diagnostics** from the boot menu and press <Enter>.

 **NOTE:** If you wait too long and the operating system logo appears, continue to wait until you see the Microsoft® Windows® desktop; then, shut down your computer and try again.

 **NOTE:** If you see a message stating that no diagnostics utility partition has been found, run the Dell Diagnostics from the *Drivers and Utilities* disc.

4. Press any key to start the Dell Diagnostics from the diagnostics utility partition on your hard drive.

## Starting Dell Diagnostics From the Drivers and Utilities Disc

1. Insert the *Drivers and Utilities* disc.
2. Shut down and restart the computer. When the DELL logo appears, press <F12> immediately.

 **NOTE:** If you wait too long and the operating system logo appears, continue to wait until you see the Microsoft® Windows® desktop; then, shut down your computer and try again.

 **NOTE:** The next steps change the boot sequence for one time only. On the next start-up, the computer boots according to the devices specified in the system setup program.

3. When the boot device list appears, highlight **CD/DVD/CD-RW** and press <Enter>.
4. Select the **Boot from CD-ROM** option from the menu that appears and press <Enter>.
5. Type 1 to start the CD menu and press <Enter> to proceed.
6. Select **Run the 32 Bit Dell Diagnostics** from the numbered list. If multiple versions are listed, select the version appropriate for your computer.
7. When the Dell Diagnostics **Main Menu** appears, select the test you want to run.

# Restoring Your Operating System

You can restore your operating system in the following ways:

- System Restore returns your computer to an earlier operating state without affecting data files. Use System Restore as the first solution for restoring your operating system and preserving data files.
- Dell Factory Image Restore returns your hard drive to the operating state it was in when you purchased the computer. This procedure permanently delete all data on the hard drive and remove any programs installed after you received the computer. Use Dell Factory Image Restore only if System Restore did not resolve your operating system problem.
- If you received an Operating System disc with your computer, you can use it to restore your operating system. However, using the Operating System disc also deletes all data on the hard drive. Use the disc only if System Restore did not resolve your operating system problem.

## System Restore

The Windows operating systems provide a System Restore option which allows you to return your computer to an earlier operating state (without affecting data files) if changes to the hardware, software, or other system settings have left the computer in an undesirable operating state. Any changes that System Restore makes to your computer are completely reversible.

 **CAUTION:** Make regular backups of your data files. System Restore does not monitor your data files or recover them.

 **NOTE:** The procedures in this document were written for the Windows default view, so they may not apply if you set your Dell™ computer to the Windows Classic view.

## Starting System Restore

1. Click **Start** .
2. In the **Start Search** box, type `System Restore` and press <Enter>.

 **NOTE:** The **User Account Control** window may appear. If you are an administrator on the computer, click **Continue**; otherwise, contact your administrator to continue the desired action.

3. Click **Next** and follow the remaining prompts on the screen.

In the event that System Restore did not resolve the issue, you may undo the last system restore.

## Undoing the Last System Restore

 **NOTE:** Before you undo the last system restore, save and close all open files and exit any open programs. Do not alter, open, or delete any files or programs until the system restoration is complete.

1. Click **Start** .
2. In the **Start Search** box, type `System Restore` and press <Enter>.
3. Click **Undo my last restoration** and click **Next**.

## Dell Factory Image Restore

 **CAUTION:** Using Dell Factory Image Restore permanently deletes all data on the hard drive and removes any programs or drivers installed after you received your computer. If possible, back up the data before using these options. Use Dell Factory Image Restore only if System Restore did not resolve your operating system problem.

 **NOTE:** Dell Factory Image Restore may not be available in certain countries or on certain computers.

Use Dell Factory Image Restore only as the last method to restore your operating system. These options restore your hard drive to the operating state it was in when you purchased the computer. Any programs or files added since you received your computer—including data files—are permanently deleted from the hard drive. Data files include documents, spreadsheets, e-mail messages, digital photos, music files, and so on. If possible, back up all data before using Dell Factory Image Restore.

## Dell Factory Image Restore

1. Turn on the computer. When the Dell logo appears, press <F8> several times to access the **Vista Advanced Boot Options** Window.
2. Select **Repair Your Computer**.
3. The **System Recovery Options** window appears.
4. Select a keyboard layout and click **Next**.
5. To access the recovery options, log on as a local user. To access the command prompt, type `administrator` in the **User name** field, then click **OK**.
6. Click **Dell Factory Image Restore**. The **Dell Factory Image Restore** welcome screen appears.

 **NOTE:** Depending upon your configuration, you may need to select **Dell Factory Tools**, then **Dell Factory Image Restore**.

7. Click **Next**. The **Confirm Data Deletion** screen appears.

 **NOTE:** If you do not want to proceed with Factory Image Restore, click **Cancel**.

8. Click the checkbox to confirm that you want to continue reformatting the hard drive and restoring the system software to the factory condition, then click **Next**.

The restore process begins and may take five or more minutes to complete. A message appears when the operating system and factory-installed applications have been restored to factory condition.

9. Click **Finish** to reboot the system.

# Operating System Reinstallation

### Before you Begin

If you are considering reinstalling the Windows operating system to correct a problem with a newly installed driver, first try using Windows Device Driver Rollback. If Device Driver Rollback does not resolve the problem, then use System Restore to return your operating system to the operating state it was in before you installed the new device driver. See “System Restore” on page 42.

 **NOTE:** Before performing the installation, back up all data files on your primary hard drive. For conventional hard drive configurations, the primary hard drive is the first drive detected by the computer.

To reinstall Windows, you need the following

- Dell *Operating System* disc
- Dell *Drivers and Utilities* disc

 **NOTE:** The Dell *Drivers and Utilities* disc contains drivers that were installed during the assembly of the computer. Use the Dell *Drivers and Utilities* disc to load any required drivers. Depending on the region from which you ordered your computer, or whether you requested the disc, the Dell *Drivers and Utilities* disc and *Operating System* disc may not ship with your computer.



## Reinstalling Windows Vista

The reinstallation process can take 1 to 2 hours to complete. After you reinstall the operating system, you must also reinstall the device drivers, virus protection program, and other software.

1. Save and close any open files and exit any open programs.
2. Insert the *Operating System* disc.
3. Click **Exit** if the **Install Windows** message appears.
4. Restart the computer.
5. When the DELL logo appears, press <F12> immediately.

 **NOTE:** If you wait too long and the operating system logo appears, continue to wait until you see the Microsoft® Windows® desktop; then, shut down your computer and try again.

 **NOTE:** The next steps change the boot sequence for one time only. On the next start-up, the computer boots according to the devices specified in the system setup program.

6. When the boot device list appears, highlight **CD/DVD/CD-RW Drive** and press <Enter>.
7. Press any key to **Boot from CD-ROM**. Follow the instructions on the screen to complete the installation.

# Getting Help

If you experience a problem with your computer, you can complete the following steps to diagnose and troubleshoot the problem:

1. See “Solving Problems” on page 30 for information and procedures that pertain to the problem your computer is experiencing.
2. See “Dell Diagnostics” on page 40 for procedures on how to run Dell Diagnostics.
3. Fill out the “Diagnostic Checklist” on page 52.
4. Use Dell’s extensive suite of online services available at Dell Support ([support.dell.com](http://support.dell.com)) for help with installation and troubleshooting procedures. See “Online Services” on page 50 for a more extensive list of Dell Support online.
5. If the preceding steps have not resolved the problem, see “Before You Call” on page 52 and then “Contacting Dell” on page 53.



**NOTE:** Call Dell Support from a telephone near or at the computer so that the support staff can assist you with any necessary procedures.



**NOTE:** Dell’s Express Service Code system may not be available in all countries.

When prompted by Dell's automated telephone system, enter your Express Service Code to route the call directly to the proper support personnel. If you do not have an Express Service Code, open the **Dell Accessories** folder, double-click the **Express Service Code** icon, and follow the directions.

 **NOTE:** Some of the services are not always available in all locations outside the continental U.S. Call your local Dell representative for information on availability.

## Technical Support and Customer Service

Dell's support service is available to answer your questions about Dell hardware. Our support staff use computer-based diagnostics to provide fast, accurate answers.

To contact Dell's support service, see "Before You Call" on page 52 and then see the contact information for your region or go to **[support.dell.com](http://support.dell.com)**.

### Online Services

You can learn about Dell products and services on the following websites:

- **www.dell.com**
- **www.dell.com/ap** (Asian/Pacific countries only)
- **www.dell.com/jp** (Japan only)
- **www.euro.dell.com** (Europe only)
- **www.dell.com/la** (Latin American and Caribbean countries)
- **www.dell.ca** (Canada only)

You can access Dell Support through the following websites and e-mail addresses:

#### Dell Support websites

- **support.dell.com**
- **support.jp.dell.com** (Japan only)
- **support.euro.dell.com** (Europe only)
- **supportapj.dell.com** (Asia Pacific only)

#### Dell Support e-mail addresses

- **mobile\_support@us.dell.com**
- **support@us.dell.com**
- **la-techsupport@dell.com** (Latin America and Caribbean countries only)
- **apsupport@dell.com** (Asian/Pacific countries only)

#### Dell Marketing and Sales e-mail addresses

- **apmarketing@dell.com** (Asian/Pacific countries only)
- **sales\_canada@dell.com** (Canada only)

#### Anonymous file transfer protocol (FTP)

- **ftp.dell.com**

Log in as user: `anonymous`, and use your e-mail address as your password.

## Automated Order-Status Service

To check on the status of any Dell products that you have ordered, you can go to **support.dell.com**, or you can call the automated order-status service. A recording prompts you for the information needed to locate and report on your order. For the telephone number to call your region, see “Contacting Dell” on page 53 for problems with your order.

If you have a problem with your order, such as missing parts, wrong parts, or incorrect billing, contact Dell for customer assistance. Have your invoice or packing slip handy when you call. For the telephone number to call for your region, see “Contacting Dell” on page 53.

## Product Information

If you need information about additional products available from Dell, or if you would like to place an order, visit the Dell website at **www.dell.com**. For the telephone number to call for your region or to speak to a sales specialist, see “Contacting Dell” on page 53.

# Before You Call

 **NOTE:** Have your Express Service Code ready when you call. The code helps Dell's automated-support telephone system direct your call more efficiently. You may also be asked for your Service Tag (located on the back or bottom of your computer).

Remember to fill out the following Diagnostics Checklist. If possible, turn on your computer before you call Dell for assistance and call from a telephone at or near the computer. You may be asked to type some commands at the keyboard, relay detailed information during operations, or try other troubleshooting steps possible only at the computer itself. Ensure that the computer documentation is available.

## Diagnostic Checklist

- Name:
- Date:
- Address:
- Phone number:
- Service Tag (bar code on the back or bottom of the computer):
- Express Service Code:
- Return Material Authorization Number (if provided by Dell support technician):
- Operating system and version:
- Devices:

- Expansion cards:
- Are you connected to a network? Yes/No
- Network, version, and network adapter:
- Programs and versions:

See your operating system documentation to determine the contents of the computer's start-up files. If the computer is connected to a printer, print each file. Otherwise, record the contents of each file before calling Dell.

- Error message, beep code, or diagnostic code:
- Description of problem and troubleshooting procedures you performed:

## Contacting Dell

For customers in the United States, call 800-WWW-DELL (800-999-3355).

 **NOTE:** If you do not have an active Internet connection, you can find contact information on your purchase invoice, packing slip, bill, or Dell product catalog.

Dell provides several online and telephone-based support and service options. Availability varies by country and product, and some services may not be available in your area. To contact Dell for sales, technical support, or customer service issues:

1. Visit **support.dell.com**.
2. Verify your country or region in the **Choose A Country/Region** drop-down menu at the bottom of the page.
3. Click **Contact Us** on the left side of the page.
4. Select the appropriate service or support link based on your need.
5. Choose the method of contacting Dell that is convenient for you.

# Finding More Information and Resources

**If you need to:****See:**

---

reinstall your operating system.

your Operating System disc.

---

run a diagnostic program for your computer, reinstall laptop system software, or update drivers for your computer, and readme files.

the *Drivers and Utilities* disc.



**NOTE:** Drivers and documentation updates can be found on the Dell™ Support website at **support.dell.com**.

---

learn more about your operating system, maintaining peripherals, RAID, Internet, Bluetooth®, networking, and e-mail.

the *Dell Technology Guide* installed on your hard drive.

---

upgrade your computer with new or additional memory, or a new hard drive.

the *Service Manual* on the Dell Support website at **support.dell.com**

reinstall or replace a worn or defective part.



**NOTE:** In some countries, opening and replacing parts of your computer may void your warranty. Check your warranty and return policies before working inside your computer.

---



**If you need to:**

find safety best practices information for your computer

review Warranty information, Terms and Conditions (U.S. only), Safety instructions, Regulatory information, Ergonomics information, and End User License Agreement.

find your Service tag/Express Service Code — You must use the service tag to identify your computer on **support.dell.com** or to contact technical support.

find drivers and downloads.

access technical support and product help.

check on your order status for new purchases.

find solutions and answers to common questions.

locate information for last-minute updates about technical changes to your computer or advanced technical-reference material for technicians or experienced users.

**See:**

the safety and regulatory documents that shipped with your computer and also see the Regulatory Compliance Homepage at **www.dell.com/regulatory\_compliance**.

the back or bottom of your computer.

the Dell™ Support website at **support.dell.com**.



# Specifications

## System model

---

Inspiron 1440

This section provides information that you may need when setting up, updating drivers for, and upgrading your computer.

 **NOTE:** Offerings may vary by region. For more information regarding the configuration of your computer, click **Start**  → **Help and Support** and select the option to view information about your computer.

## Processor

---

<i>Type</i>	<i>L2 cache</i>
Intel® Celeron®	1 MB
Intel Celeron Dual-Core	1 MB
Intel Pentium® Dual-Core	1 MB
Intel Core™2 Duo	2 MB/3 MB/6 MB
External bus frequency	667 MHz, 800 MHz, and 1066 MHz

## Memory

---

Memory module connector	two internally-accessible SO-DIMM sockets
Memory configurations possible	1 GB, 2 GB, 3 GB, 4 GB, 6 GB, and 8 GB
Memory type	DDR2 SO-DIMM
Minimum memory	1 GB
Maximum memory	8 GB

 **NOTE:** For instructions on upgrading your memory, see the *Service Manual* on the Dell Support website at [support.dell.com](http://support.dell.com).

## ExpressCard

---

Connector	one 34 mm ExpressCard slot
Connector size	26 pins

## Computer information

---

System chipset	Intel GM45 (UMA) Intel GM45 (Discrete)
Graphics card	ATI Mobility Radeon HD4330
Graphics card memory	256 MB GFX/ 512 MB GFX
Graphics bus	internal

## Communications

---

Modem (optional)	External V.92 56K USB modem
Network adapter	10/100 Ethernet LAN on system board
Wireless	internal WLAN and Bluetooth® wireless support

## Specifications

### Audio

---

Audio type	two-channel high definition audio (Azalia)
Audio controller	IDT 92HD81
Stereo conversion	24-bit (analog-to-digital and digital-to-analog)
Internal interface	Intel high-definition audio
Speaker	two 4-ohm speaker
Volume controls	program menus, keyboard hotkeys

### Ports and connectors

---

Audio	one microphone connector, stereo headphone/speaker connector, digital MIC with camera module (optional)
-------	---

### Ports and connectors

---

Mini-Card	one half Mini-Card slot
Network adapter	RJ45 port
USB	three 4-pin USB 2.0-compliant connectors
Video	15-hole connector

### Display

---

Type (TrueLife)	14.0 inch (HD) WLED 14.0 inch (HD+) WLED
-----------------	---

#### *Dimensions:*

Height	173.95 mm (6.85 inches)
Width	309.40 mm (12.2 inches)
Diagonal	355.60 mm (14.0 inches)
Operating angle	0° (closed) to 140°

**Display***Viewing Angles:*

Horizontal	±40° (HD) ±60° (HD+)
Vertical	+15/-30° (HD) ±50° (HD+)
Pixel pitch	0.2265 mm (HD) 0.1935 mm (HD+)
Power consumption (panel with backlight) (typical)	4.8 W (max) (HD) 5.5 W (max) (HD+)

**Camera (optional)**

Pixel	1.3 megapixel
Video resolution	320 x 240 ~1280 x 1024 (640 x 480 at 30 fps)
Diagonal viewing angle	66°

**Touch pad**

X/Y position resolution (graphics table mode)	240 cpi
<i>Size:</i>	
Width	81.0 mm (3.20 inches) sensor-active area
Height	42.0 mm (1.65 inches) rectangle

## Specifications

### Keyboard

---

Number of keys	86 (U.S. and Canada); 87 (Europe); 90 (Japan)
Layout	QWERTY/AZERTY/Kanji

### Battery

---

Type	4-cell lithium ion 6-cell lithium ion 9-cell lithium ion
Depth	48.45 mm (1.91 inches)
Height	20.15 mm (0.79 inches) (4/6-cell) 40.05 mm (1.58 inches) (9-cell)
Width	205.22 mm (8.08 inches) (4/6-cell) 276.95 (10.90 inches) (9-cell)

### Battery

---

Weight	0.26 kg (0.57 lb) (4-cell) 0.35 kg (0.77 lb) (6-cell) 0.52 kg (1.15 lb) (9-cell)
--------	--

### AC adapter

---

Input voltage	100–240 VAC
Input current (maximum)	1.5/1.6 A
Input frequency	50–60 Hz
Output power	65 W or 90 W
Output current	3.34 A (65 W); 4.62 A (90 W)
Rated output voltage	19.5 +/-1.0 VDC

**AC adapter***Dimensions:*

65 W

Height 29.0 mm (1.14 inches)

Width 46.5 mm (1.83 inches)

Depth 107 mm  
(4.21 inches)Weight (with  
cables) 0.250 kg (0.55 lb)

65 W (E-Series)

Height 16.0 mm (0.67 inches)

Width 66.0 mm (2.60 inches)

Depth 127.0 mm  
(5.00 inches)Weight (with  
cables) 0.265 kg (0.58 lb)**AC adapter**

90 W

Height 16.0 mm (0.67 inches)

Width 70.0 mm (2.76 inches)

Depth 147.0 mm (5.79 inches)

Weight (with  
cables) 0.350 kg (0.77 lb)

90 W (D-Series)

Height 34.2 mm (1.35 inches)

Width 60.8 mm (2.40 inches)

Depth 169.5 mm (6.68 inches)

Weight (with  
cables) 0.460 kg (1.01 lb)

## Specifications

### Physical

---

Height	25.4 to 38.9 mm (1.0 to 1.5 inches)
Width	339 mm (13.35 inches)
Depth	238 mm (9.37 inches)
Weight (with 4-cell battery)	2.3 kg (5.07 lb)
Weight (with 6-cell battery)	2.4 kg (5.29 lb)

### Computer environment

---

#### *Temperature range:*

Operating	0° to 35°C (32° to 95°F)
Storage	-40° to 65°C (-40° to 149°F)

### Computer environment

---

#### *Relative humidity (maximum):*

Operating	10% to 90% (noncondensing)
Storage	5% to 95% (noncondensing)

#### *Maximum vibration (using a random-vibration spectrum that simulates user environment):*

Operating	0.66 GRMS
Storage	1.30 GRMS

#### *Maximum shock (measured with hard drive in head-parked position and a 2-ms half-sine pulse):*

Operating	110 G
Storage	163 G
Airborne contaminant level	G2 or lower as defined by ISA-S71.04-1985



# Index

## A

- AC adapter
  - size and weight **61**
- airflow, allowing **5**

## B

- backups
  - creating **29**

## C

- calling Dell **52**
- computer, setting up **5**

- connect(ing)
  - to the Internet **10**
- conserving energy **28**
- customer service **49**
- customizing
  - your energy settings **28**

## D

- damage, avoiding **5**
- data, backing up **29**
- Dell Factory Image Restore **42**
- Dell Support Center **36**
- Dell support website **55**

## Index

Dell Technology Guide

for further information **54**

Diagnostic Checklist **52**

drivers and downloads **55**

## E

e-mail addresses

for technical support **50**

energy

conserving **28**

expansion bus **57**

## F

finding more information **54**

FTP login, anonymous **50**

## H

hardware problems

diagnosing **40**

Hardware Troubleshooter **40**

help

getting assistance and support **48**

## I

Internet connection **10**

ISP

Internet Service Provider **10**

## M

memory problems

solving **33**

memory support **57**

**N**

network connection

fixing **30, 31**

network speed

testing **30**

**O**

order status **51**

**P**

power problems, solving **32**

power strips, using **6**

problems, solving **30**

processor **56**

products

information and purchasing **51**

**R**

reinstalling Windows **42**

resources, finding more **54**

restoring factory image **44**

**S**

setup, before you begin **5**

software features **28**

software problems **34**

solving problems **30**

specifications **56**

support e-mail addresses **50**

support sites

worldwide **49**

System Messages **38**

system reinstall options **42**

System Restore **42**

## Index

### T

technical support **49**

### V

ventilation, ensuring **5**

### W

Windows, reinstalling **42**

Windows Vista® **9**

    Program Compatibility Wizard **34**

    reinstalling **47**

    setup **9**

wired network

    network cable, connecting **7**





Printed in the U.S.A.

[www.dell.com](http://www.dell.com) | [support.dell.com](http://support.dell.com)



0M792NA00