

# Dell Inspiron M4040/14-N4050 Owner's Manual

Regulatory model: P22G

Regulatory type: P22G001; P22G002



# Notes, Cautions, and Warnings



**NOTE:** A NOTE indicates important information that helps you make better use of your computer.



**CAUTION:** A CAUTION indicates potential damage to hardware or loss of data if instructions are not followed.



**WARNING:** A WARNING indicates a potential for property damage, personal injury, or death.

---

**Information in this document is subject to change without notice.**

© 2011 Dell Inc. All rights reserved.

Trademarks used in this text: Dell™, the DELL logo, and Inspiron™ are trademarks of Dell Inc.; Bluetooth® is a registered trademark owned by Bluetooth SIG, Inc.; Microsoft®, Windows®, and the Windows start button logo  are either trademarks or registered trademarks of Microsoft Corporation in the United States and/or other countries.

Reproduction of these materials in any manner whatsoever without the written permission of Dell Inc. is strictly forbidden.

Regulatory model: P22G

Regulatory type: P22G001; P22G002

2011 - 05

Rev. A00

# Contents

1	Before You Begin . . . . .	9
	<b>Recommended Tools</b> . . . . .	9
	<b>Turning Off Your Computer</b> . . . . .	9
	<b>Before Working Inside Your Computer</b> . . . . .	10
2	Battery . . . . .	13
	<b>Removing the Battery</b> . . . . .	13
	<b>Replacing the Battery</b> . . . . .	14
3	Keyboard . . . . .	15
	<b>Removing the Keyboard</b> . . . . .	15
	<b>Replacing the Keyboard</b> . . . . .	17
4	Memory Module(s) . . . . .	19
	<b>Removing the Memory Module(s)</b> . . . . .	19
	<b>Replacing the Memory Module(s)</b> . . . . .	20
5	Optical Drive . . . . .	23
	<b>Removing the Optical Drive</b> . . . . .	23

	<b>Replacing the Optical Drive . . . . .</b>	<b>24</b>
<b>6</b>	<b>Palm-Rest Assembly . . . . .</b>	<b>25</b>
	<b>Removing the Palm-Rest Assembly . . . . .</b>	<b>25</b>
	<b>Replacing the Palm-Rest Assembly . . . . .</b>	<b>28</b>
<b>7</b>	<b>Power Button Board . . . . .</b>	<b>31</b>
	<b>Removing the Power Button Board . . . . .</b>	<b>31</b>
	<b>Replacing the Power Button Board . . . . .</b>	<b>32</b>
<b>8</b>	<b>Hard Drive . . . . .</b>	<b>33</b>
	<b>Removing the Hard Drive . . . . .</b>	<b>33</b>
	<b>Replacing the Hard Drive . . . . .</b>	<b>35</b>
<b>9</b>	<b>Wireless Mini-Card . . . . .</b>	<b>37</b>
	<b>Removing the Mini-Card . . . . .</b>	<b>37</b>
	<b>Replacing the Mini-Card . . . . .</b>	<b>38</b>
<b>10</b>	<b>Audio Board . . . . .</b>	<b>41</b>
	<b>Removing the Audio Board . . . . .</b>	<b>41</b>
	<b>Replacing the Audio Board . . . . .</b>	<b>42</b>

11	Coin-Cell Battery . . . . .	43
	<b>Removing the Coin-Cell Battery . . . . .</b>	<b>43</b>
	<b>Replacing the Coin-Cell Battery . . . . .</b>	<b>45</b>
12	USB Board . . . . .	47
	<b>Removing the USB Board . . . . .</b>	<b>47</b>
	<b>Replacing the USB Board . . . . .</b>	<b>48</b>
13	Thermal Cooling Assembly . . . . .	49
	<b>Removing the Thermal Cooling Assembly . . . . .</b>	<b>49</b>
	<b>Replacing the Thermal Cooling Assembly . . . . .</b>	<b>50</b>
14	Processor Module (For Inspiron 14-N4050 Only)	
	51	
	<b>Removing the Processor Module . . . . .</b>	<b>51</b>
	<b>Replacing the Processor Module . . . . .</b>	<b>52</b>
15	Hinge Cover . . . . .	55
	<b>Removing the Hinge Cover . . . . .</b>	<b>55</b>
	<b>Replacing the Hinge Cover . . . . .</b>	<b>57</b>
16	Display . . . . .	59
	<b>Display Assembly . . . . .</b>	<b>59</b>

Removing the Display Assembly . . . . .	59
Replacing the Display Assembly . . . . .	61
<b>Display Bezel.</b> . . . .	<b>62</b>
Removing the Display Bezel . . . . .	62
Replacing the Display Bezel . . . . .	63
Removing the Display Panel . . . . .	63
Replacing the Display Panel . . . . .	66
17 Camera Module . . . . .	69
<b>Removing the Camera Module.</b> . . . .	<b>69</b>
<b>Replacing the Camera Module</b> . . . . .	<b>70</b>
18 System Board . . . . .	73
<b>Removing the System Board.</b> . . . .	<b>73</b>
<b>Replacing the System Board.</b> . . . .	<b>75</b>
<b>Entering the Service Tag in the BIOS</b> . . . . .	<b>76</b>
19 Flashing the BIOS . . . . .	77







# Before You Begin

This manual provides procedures for removing and installing components in your computer. Before you begin any procedure in this book, ensure that:

- You have performed the steps in "Turning Off Your Computer" on page 9 and "Before Working Inside Your Computer" on page 10.
- You have read the safety information that shipped with your computer.
- A component can be replaced or—if purchased separately—installed by performing the removal procedure in the reverse order.

## Recommended Tools

The procedures in this document may require the following tools:

- Small flat-blade screwdriver
- Phillips screwdriver
- Plastic scribe
- BIOS executable update program available at [support.dell.com](http://support.dell.com)

## Turning Off Your Computer

 **CAUTION: To avoid losing data, save and close all open files and exit all open programs before you turn off your computer.**







- 1 Save and close all open files and exit all open programs.
- 2 Click Start  and then click Shut Down.

The computer turns off after the operating system shutdown process is completed.

- 3 Ensure that the computer is turned off. If your computer did not automatically turn off when you shut down the operating system, press and hold the power button until the computer turns off.

# Before Working Inside Your Computer

Use the following safety guidelines to help protect your computer from potential damage and to ensure your own personal safety.

-  **WARNING:** Before working inside your computer, read the safety information that shipped with your computer. For additional safety best practices information, see the Regulatory Compliance Homepage at [www.dell.com/regulatory\\_compliance](http://www.dell.com/regulatory_compliance).
-  **CAUTION:** To avoid electrostatic discharge, ground yourself by using a wrist grounding strap or by periodically touching an unpainted metal surface (such as a connector on your computer).
-  **CAUTION:** Handle components and cards with care. Do not touch the components or contacts on a card. Hold a card by its edges or by its metal mounting bracket. Hold a component such as a processor by its edges, not by its pins.
-  **CAUTION:** Only a certified service technician should perform repairs on your computer. Damage due to servicing that is not authorized by Dell is not covered by your warranty.
-  **CAUTION:** When you disconnect a cable, pull on its connector or on its pull-tab, not on the cable itself. Some cables have connectors with locking tabs; if you are disconnecting this type of cable, press in on the locking tabs before you disconnect the cable. As you pull connectors apart, keep them evenly aligned to avoid bending any connector pins. Also, before you connect a cable, ensure that both connectors are correctly oriented and aligned.
-  **CAUTION:** To avoid damaging the computer, perform the following steps before you begin working inside the computer.
  - 1 Ensure that the work surface is flat and clean to prevent the computer cover from being scratched.
  - 2 Turn off your computer, see "Turning Off Your Computer" on page 9, and all attached devices.
-  **CAUTION:** To disconnect a network cable, first unplug the cable from your computer and then unplug the cable from the network device.
  - 3 Disconnect all telephone or network cables from the computer.
  - 4 Press and eject any installed cards from the 3-in-1 media card reader.
  - 5 Disconnect your computer and all attached devices from their electrical outlets.

6 Disconnect all attached devices from your computer.







**CAUTION: To help prevent damage to the system board, remove the main battery, see "Removing the Battery" on page 13, before working inside the computer.**

7 Remove the battery. See "Removing the Battery" on page 13.

8 Turn the computer top-side up, open the display, and press the power button to ground the system board.



# Battery

-  **WARNING:** Before working inside your computer, read the safety information that shipped with your computer. For additional safety best practices information, see the Regulatory Compliance Homepage at [www.dell.com/regulatory\\_compliance](http://www.dell.com/regulatory_compliance).
-  **CAUTION:** Only a certified service technician should perform repairs on your computer. Damage due to servicing that is not authorized by Dell is not covered by your warranty.
-  **CAUTION:** To avoid electrostatic discharge, ground yourself by using a wrist grounding strap or by periodically touching an unpainted metal surface (such as a connector on your computer).
-  **CAUTION:** To avoid damage to the computer, use only the battery designed for this particular Dell computer. Do not use batteries designed for other Dell computers.

## Removing the Battery

- 1 Follow the instructions in "Before You Begin" on page 9.
- 2 Turn off the computer and turn it over.
- 3 Slide the battery lock latch to the unlock position until it clicks into place.
- 4 Slide and hold the battery release latch in the unlock position.
- 5 Slide and lift the battery out of the battery bay.

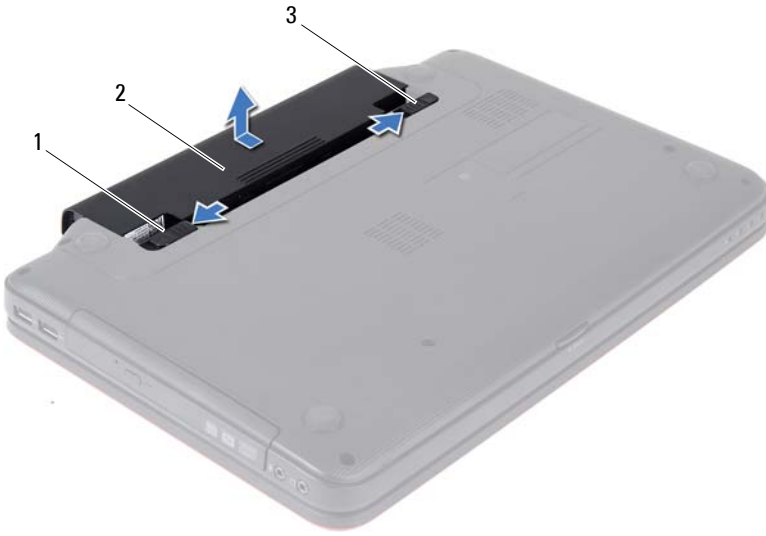





- 1 battery release latch
- 3 battery lock latch

2 battery

## Replacing the Battery

- 1 Follow the instructions in "Before You Begin" on page 9.
- 2 Slide the battery into the battery bay until it clicks into place.
- 3 Slide the battery lock latch to the lock position.

# Keyboard

-  **WARNING:** Before working inside your computer, read the safety information that shipped with your computer. For additional safety best practices information, see the Regulatory Compliance Homepage at [www.dell.com/regulatory\\_compliance](http://www.dell.com/regulatory_compliance).
-  **CAUTION:** Only a certified service technician should perform repairs on your computer. Damage due to servicing that is not authorized by Dell is not covered by your warranty.
-  **CAUTION:** To avoid electrostatic discharge, ground yourself by using a wrist grounding strap or by periodically touching an unpainted metal surface (such as a connector on your computer).
-  **CAUTION:** To help prevent damage to the system board, remove the main battery, see "Removing the Battery" on page 13, before working inside the computer.

## Removing the Keyboard

- 1 Follow the instructions in "Before You Begin" on page 9.
  - 2 Remove the battery. See "Removing the Battery" on page 13.
-  **CAUTION:** The keycaps on the keyboard are fragile, easily dislodged, and time-consuming to replace. Be careful when removing and handling the keyboard.
- 3 Turn the computer over and open the display as far as possible.
  - 4 Using a plastic scribe, release the four tabs that secure the keyboard to the palm rest and ease the keyboard up until it clears off the palm rest.



1 plastic scribe

2 tabs (4)

3 keyboard

**⚠ CAUTION: Be extremely careful when removing and handling the keyboard. Failure to do so could result in scratching the display panel.**

- 5 Without pulling hard on the keyboard, hold it towards the display.
- 6 Lift the connector latch that secures the keyboard cable to the connector on the system board and remove the keyboard cable.
- 7 Lift the keyboard off the computer.





1 keyboard cable

2 keyboard

## Replacing the Keyboard

- 1 Follow the instructions in "Before You Begin" on page 9.
- 2 Slide the keyboard cable into the connector on the system board. Press down on the connector latch to secure the keyboard cable to the connector on the system board.
- 3 Slide the tabs on the keyboard into the slots on the palm rest.
- 4 Gently press around the edges of the keyboard to lock the four tabs securing the keyboard.
- 5 Close the display and turn the computer over.
- 6 Replace the battery. See "Replacing the Battery" on page 14.



# Memory Module(s)

 **WARNING:** Before working inside your computer, read the safety information that shipped with your computer. For additional safety best practices information, see the Regulatory Compliance Homepage at [www.dell.com/regulatory\\_compliance](http://www.dell.com/regulatory_compliance).

 **CAUTION:** Only a certified service technician should perform repairs on your computer. Damage due to servicing that is not authorized by Dell is not covered by your warranty.

 **CAUTION:** To avoid electrostatic discharge, ground yourself by using a wrist grounding strap or by periodically touching an unpainted metal surface (such as a connector on your computer).

 **CAUTION:** To help prevent damage to the system board, remove the main battery, see "Removing the Battery" on page 13, before working inside the computer.

You can increase your computer memory by installing memory modules on the system board. For information on the type of memory supported by your computer, see the *Specifications* at [support.dell.com/manuals](http://support.dell.com/manuals).

 **NOTE:** Memory modules purchased from Dell are covered under your computer warranty.

Your computer has two user-accessible SODIMM sockets, labeled DIMM A and DIMM B, that can be accessed from the bottom of the computer.

## Removing the Memory Module(s)

- 1 Follow the instructions in "Before You Begin" on page 9.
- 2 Remove the battery. See "Removing the Battery" on page 13.
- 3 Remove the keyboard. See "Removing the Keyboard" on page 15.

 **CAUTION:** To prevent damage to the memory module connector, do not use tools to spread the memory module securing clips.

- 4 Use your fingertips to carefully spread apart the securing clips on each end of the memory-module connector until the module pops up.
- 5 Remove the memory module from the memory-module connector.

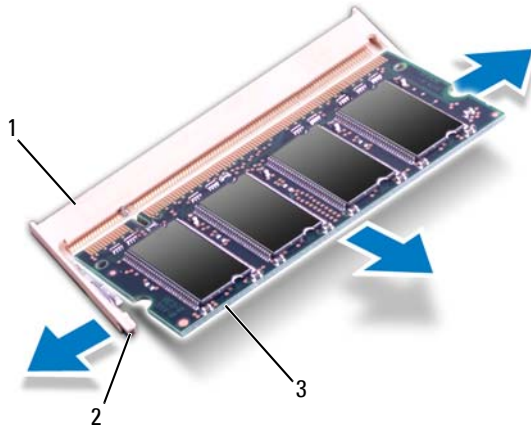

- 1 memory-module connector    2 securing clips (2)  
3 memory module

## Replacing the Memory Module(s)

**CAUTION:** If you need to install memory modules in two connectors, install a memory module in the connector labeled “DIMM A” before you install a memory module in the connector labeled “DIMM B.”

- 1 Follow the instructions in "Before You Begin" on page 9.
- 2 Align the notch in the memory module with the tab in the memory-module connector.
- 3 Slide the memory module firmly into the slot at a 45-degree angle, and press the memory module down until it clicks into place. If you do not hear the click, remove the memory module and reinstall it.



**NOTE:** If the memory module is not installed properly, the computer may not boot.

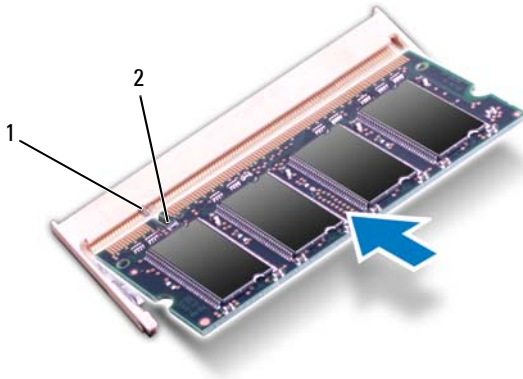

1 tab 2 notch

- 4 Replace the keyboard. See "Replacing the Keyboard" on page 17.
- 5 Replace the battery, see "Replacing the Battery" on page 14, or connect the AC adapter to your computer and an electrical outlet.
- 6 Turn on the computer.

As the computer boots, it detects the memory module(s) and automatically updates the system configuration information.

To confirm the amount of memory installed in the computer:

Click **Start**  → **Control Panel** → **System and Security** → **System**.



# Optical Drive

 **WARNING:** Before working inside your computer, read the safety information that shipped with your computer. For additional safety best practices information, see the Regulatory Compliance Homepage at [www.dell.com/regulatory\\_compliance](http://www.dell.com/regulatory_compliance).

 **CAUTION:** Only a certified service technician should perform repairs on your computer. Damage due to servicing that is not authorized by Dell is not covered by your warranty.

 **CAUTION:** To avoid electrostatic discharge, ground yourself by using a wrist grounding strap or by periodically touching an unpainted metal surface (such as a connector on your computer).

 **CAUTION:** To help prevent damage to the system board, remove the main battery, see "Removing the Battery" on page 13, before working inside the computer.

## Removing the Optical Drive

- 1 Follow the instructions in "Before You Begin" on page 9.
- 2 Remove the battery. See "Removing the Battery" on page 13.
- 3 Remove the keyboard. See "Removing the Keyboard" on page 15.
- 4 Remove the screw that secures the optical drive to the computer base.
- 5 Using a plastic scribe, push the notch on the optical drive to release it from the optical-drive compartment.
- 6 Slide the optical drive out of the optical-drive compartment.

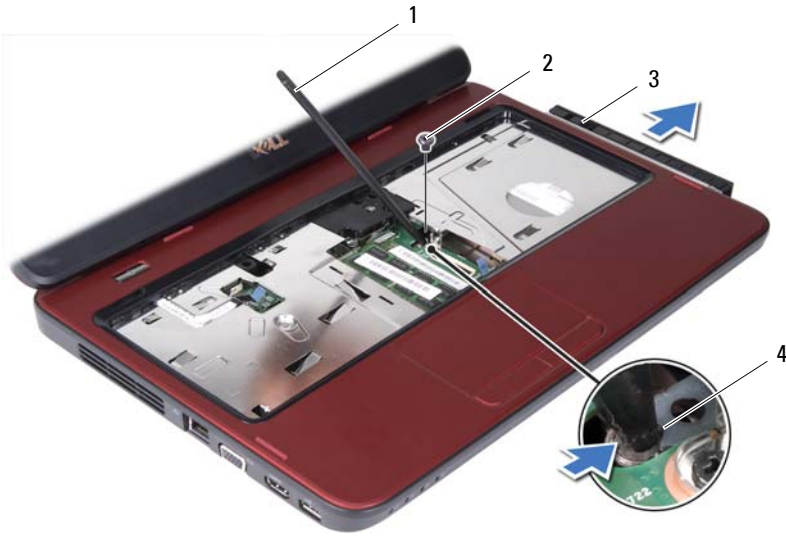

- 1 plastic scribe
- 3 optical drive

- 2 screw
- 4 notch

## Replacing the Optical Drive





- 1 Follow the instructions in "Before You Begin" on page 9.
- 2 Slide the optical drive into the optical-drive compartment until it is fully seated.
- 3 Replace the screw that secures the optical drive to the computer base.
- 4 Replace the keyboard. See "Replacing the Keyboard" on page 17.
- 5 Replace the battery. See "Replacing the Battery" on page 14.



**CAUTION:** Before turning on the computer, replace all screws and ensure that no stray screws remain inside the computer. Failure to do so may result in damage to the computer.



## Palm-Rest Assembly

-  **WARNING:** Before working inside your computer, read the safety information that shipped with your computer. For additional safety best practices information, see the Regulatory Compliance Homepage at [www.dell.com/regulatory\\_compliance](http://www.dell.com/regulatory_compliance).
-  **CAUTION:** Only a certified service technician should perform repairs on your computer. Damage due to servicing that is not authorized by Dell is not covered by your warranty.
-  **CAUTION:** To avoid electrostatic discharge, ground yourself by using a wrist grounding strap or by periodically touching an unpainted metal surface (such as a connector on your computer).
-  **CAUTION:** To help prevent damage to the system board, remove the main battery, see "Removing the Battery" on page 13, before working inside the computer.

## Removing the Palm-Rest Assembly

- 1 Follow the instructions in "Before You Begin" on page 9.
- 2 Remove the battery. See "Removing the Battery" on page 13.
- 3 Remove the eight screws that secure the palm-rest assembly to the computer base.



4 Remove the keyboard. See "Removing the Keyboard" on page 15.

5 Remove the three screws on the palm-rest assembly.

 **CAUTION: Pull on the plastic tab on top of the connectors to avoid damaging the connectors.**

6 Lift the connector latch that secures the power-button board cable and touch-pad cable to the connectors on the system board and remove the cables.

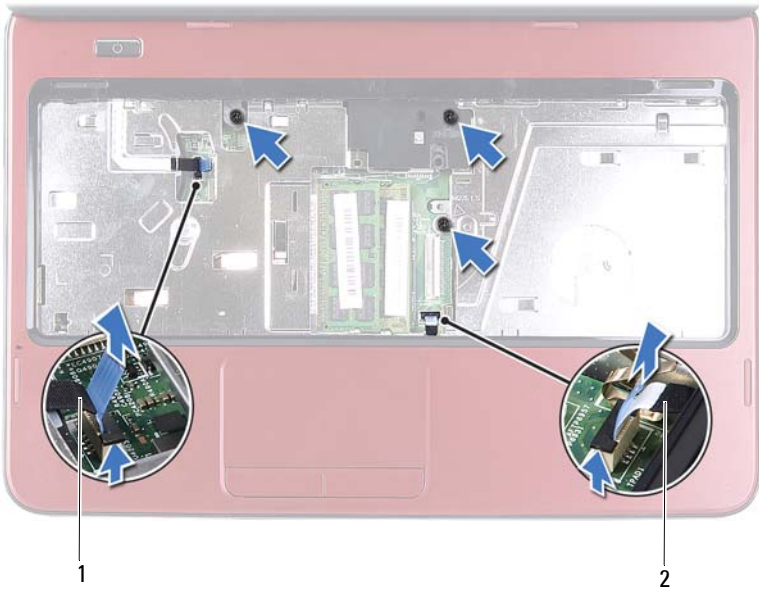

1 power-button board cable

2 touch-pad cable

**△ CAUTION: Carefully separate the palm rest from the computer base to avoid damage to the palm rest.**

- 7 Using a plastic scribe, carefully pry out the palm-rest assembly and then ease the palm-rest assembly from the computer base
- 8 Lift the palm-rest assembly off the computer base.



1 palm-rest assembly

2 plastic scribe

- 9 Remove the power button board. See "Removing the Power Button Board" on page 31.

## Replacing the Palm-Rest Assembly

- 1 Follow the instructions in "Before You Begin" on page 9.
- 2 Replace the power button board. See "Replacing the Power Button Board" on page 32.
- 3 Align the palm-rest assembly on the computer base and gently snap the palm-rest assembly into place.
- 4 Slide the touch-pad cable and power-button board cable into the connectors on the system board and press down on the connector latches to secure them.
- 5 Replace the three screws on the palm-rest assembly.
- 6 Replace the keyboard. See "Replacing the Keyboard" on page 17.
- 7 Replace the eight screws that secure the palm-rest assembly to the computer base.





**8** Replace the battery. See "Replacing the Battery" on page 14.



**CAUTION: Before turning on the computer, replace all screws and ensure that no stray screws remain inside the computer. Failure to do so may result in damage to the computer.**



# Power Button Board

-  **WARNING:** Before working inside your computer, read the safety information that shipped with your computer. For additional safety best practices information, see the Regulatory Compliance Homepage at [www.dell.com/regulatory\\_compliance](http://www.dell.com/regulatory_compliance).
-  **CAUTION:** Only a certified service technician should perform repairs on your computer. Damage due to servicing that is not authorized by Dell is not covered by your warranty.
-  **CAUTION:** To avoid electrostatic discharge, ground yourself by using a wrist grounding strap or by periodically touching an unpainted metal surface (such as a connector on your computer).
-  **CAUTION:** To help prevent damage to the system board, remove the main battery, see "Removing the Battery" on page 13, before working inside the computer.

## Removing the Power Button Board

- 1 Follow the instructions in "Before You Begin" on page 9.
- 2 Remove the battery. See "Removing the Battery" on page 13.
- 3 Follow the instructions from step 3 to step 8 in "Removing the Palm-Rest Assembly" on page 25.
- 4 Turn the palm-rest assembly over.
- 5 Slide and remove the power-button board cable through the slot on the palm-rest assembly.
- 6 Remove the screw that secures the power button board to the palm rest.
- 7 Push and release the tabs that secure the power button board to the palm rest.
- 8 Lift the power button board along with its cable away from the palm rest.

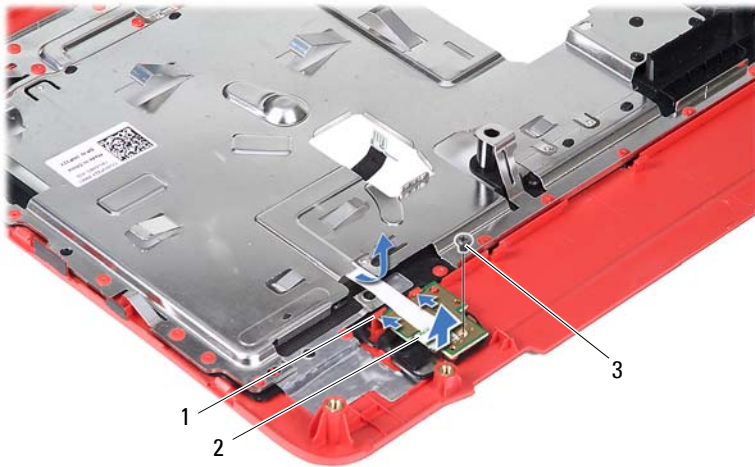

- 1 tabs (2)
- 3 screw

- 2 power button board

## Replacing the Power Button Board

- 1 Follow the instructions in "Before You Begin" on page 9.
- 2 Slide the power button board under the tabs on the palm rest and align the screw hole on the power button board with the screw hole on the palm rest.
- 3 Replace the screw that secures the power button board to the palm rest.
- 4 Slide the power-button board cable through the slot on the palm-rest assembly.
- 5 Turn the palm-rest assembly over.
- 6 Follow the instructions from step 3 to step 7 in "Replacing the Palm-Rest Assembly" on page 28.
- 7 Replace the battery. See "Replacing the Battery" on page 14.





**CAUTION:** Before turning on the computer, replace all screws and ensure that no stray screws remain inside the computer. Failure to do so may result in damage to the computer.





# Hard Drive

 **WARNING:** Before working inside your computer, read the safety information that shipped with your computer. For additional safety best practices information, see the Regulatory Compliance Homepage at [www.dell.com/regulatory\\_compliance](http://www.dell.com/regulatory_compliance).

 **WARNING:** If you remove the hard drive from the computer when the drive is hot, *do not touch* the metal housing of the hard drive.

 **CAUTION:** Only a certified service technician should perform repairs on your computer. Damage due to servicing that is not authorized by Dell is not covered by your warranty.

 **CAUTION:** To avoid electrostatic discharge, ground yourself by using a wrist grounding strap or by periodically touching an unpainted metal surface (such as a connector on your computer).

 **CAUTION:** To help prevent damage to the system board, remove the main battery, see "Removing the Battery" on page 13, before working inside the computer.

 **CAUTION:** To prevent data loss, turn off your computer, see "Turning Off Your Computer" on page 9, before removing the hard-drive assembly. Do not remove the hard drive while the computer is On or in Sleep state.

 **CAUTION:** Hard drives are extremely fragile. Exercise care when handling the hard drive.

 **NOTE:** Dell does not guarantee compatibility or provide support for hard drives from sources other than Dell.

 **NOTE:** If you are installing a hard drive from a source other than Dell, you must install an operating system, drivers, and utilities on the new hard drive.

## Removing the Hard Drive

- 1 Follow the instructions in "Before You Begin" on page 9.
- 2 Remove the battery. See "Removing the Battery" on page 13.
- 3 Follow the instructions from step 3 to step 8 in "Removing the Palm-Rest Assembly" on page 25.

- 4** Slide the hard-drive assembly to the left to disconnect it from the connector on the system board.
- 5** Lift the hard-drive assembly out of the computer base.



**1** hard-drive assembly

- 6** Remove the two screws that secure the hard-drive bracket to the hard drive.
- 7** Lift the hard-drive bracket away from the hard drive.

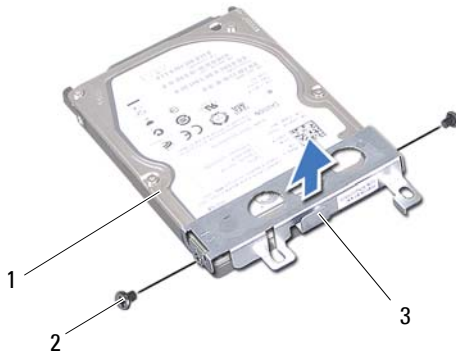

- 1 hard drive
- 2 screws (2)
- 3 hard-drive bracket

## Replacing the Hard Drive

- 1 Follow the instructions in "Before You Begin" on page 9.
- 2 Remove the new hard drive from its packaging.  
Save the original packaging for storing or shipping the hard drive.
- 3 Place the hard-drive bracket on the hard drive.
- 4 Replace the two screws that secure the hard-drive bracket to the hard drive.
- 5 Place the hard-drive assembly on the computer base.
- 6 Push the hard-drive assembly towards the right to connect it to the connector on the system board.
- 7 Follow the instructions from step 3 to step 7 in "Replacing the Palm-Rest Assembly" on page 28.
- 8 Replace the battery. See "Replacing the Battery" on page 14.



**CAUTION: Before turning on the computer, replace all screws and ensure that no stray screws remain inside the computer. Failure to do so may result in damage to the computer.**





# Wireless Mini-Card

 **WARNING:** Before working inside your computer, read the safety information that shipped with your computer. For additional safety best practices information, see the Regulatory Compliance Homepage at [www.dell.com/regulatory\\_compliance](http://www.dell.com/regulatory_compliance).

 **CAUTION:** Only a certified service technician should perform repairs on your computer. Damage due to servicing that is not authorized by Dell is not covered by your warranty.

 **CAUTION:** To avoid electrostatic discharge, ground yourself by using a wrist grounding strap or by periodically touching an unpainted metal surface (such as a connector on your computer).

 **CAUTION:** To help prevent damage to the system board, remove the main battery, see "Removing the Battery" on page 13, before working inside the computer.

 **NOTE:** Dell does not guarantee compatibility or provide support for Mini-Cards from sources other than Dell.

If you ordered a wireless Mini-Card with your computer, the card is already installed.

Your computer has one half Mini-Card slot for Wireless Local Area Network (WLAN)/Bluetooth combo card.

 **NOTE:** Depending on the configuration of the computer when it was sold, the Mini-Card slot may or may not have a Mini-Card installed.

## Removing the Mini-Card

- 1 Follow the instructions in "Before You Begin" on page 9.
- 2 Remove the battery. See "Removing the Battery" on page 13.
- 3 Follow the instructions from step 3 to step 8 in "Removing the Palm-Rest Assembly" on page 25.
- 4 Disconnect the antenna cables from the Mini-Card.
- 5 Push and release the tab that secures the Mini-Card to the connector on the system board.

6 Lift the Mini-Card out of the connector on the system board.

**CAUTION:** When the Mini-Card is not in the computer, store it in protective antistatic packaging. For more information, see "Protecting Against Electrostatic Discharge" in the safety information that shipped with your computer.





1 Mini-Card antenna cables (2)



2 tab

## Replacing the Mini-Card

- 1 Follow the instructions in "Before You Begin" on page 9.
- 2 Remove the new Mini-Card from its packaging.

-  **CAUTION:** Use firm and even pressure to slide the card into place. If you use excessive force, you may damage the connector.
  -  **CAUTION:** The connectors are keyed to ensure correct insertion. If you feel resistance, check the connectors on the card and on the system board, and realign the card.
  -  **CAUTION:** To avoid damage to the Mini-Card, never place cables under the card.
- 3 Insert the Mini-Card connector at a 45-degree angle into the connector on the system-board.
  - 4 Press the other end of the Mini-Card down until it clicks into place.
  - 5 Connect the appropriate antenna cables to the Mini-Card you are installing. The following table provides the antenna cable color scheme for the Mini-Cards supported by your computer.





Connectors on the Mini-Card	Antenna Cable Color Scheme
<b>WLAN (2 antenna cables)</b>	
Main WLAN (white triangle)	white
Auxiliary WLAN (black triangle)	black

- 6 Follow the instructions from step 3 to step 7 in "Replacing the Palm-Rest Assembly" on page 28.
  - 7 Replace the battery. See "Replacing the Battery" on page 14.
-  **CAUTION:** Before turning on the computer, replace all screws and ensure that no stray screws remain inside the computer. Failure to do so may result in damage to the computer.
- 8 Install the drivers and utilities for your computer, as required.
-  **NOTE:** If you are installing a Mini-Card from a source other than Dell, you must install the appropriate drivers and utilities.





## Audio Board

-  **WARNING:** Before working inside your computer, read the safety information that shipped with your computer. For additional safety best practices information, see the Regulatory Compliance Homepage at [www.dell.com/regulatory\\_compliance](http://www.dell.com/regulatory_compliance).
-  **CAUTION:** To avoid electrostatic discharge, ground yourself by using a wrist grounding strap or by periodically touching an unpainted metal surface (such as a connector on your computer).
-  **CAUTION:** Only a certified service technician should perform repairs on your computer. Damage due to servicing that is not authorized by Dell is not covered by your warranty.
-  **CAUTION:** To help prevent damage to the system board, remove the main battery, see "Removing the Battery" on page 13, before working inside the computer.

## Removing the Audio Board

- 1 Follow the instructions in "Before You Begin" on page 9.
- 2 Remove the battery. See "Removing the Battery" on page 13.
- 3 Follow the instructions from step 3 to step 8 in "Removing the Palm-Rest Assembly" on page 25.
- 4 Disconnect the Mini-Card antenna cables from the connectors on the Mini-Card. See "Removing the Mini-Card" on page 37.
- 5 Lift the connector latch that secures the audio-board cable to the connector on the system board and remove the audio-board cable.
- 6 Push and release the tab that secures the audio board to the computer base.
- 7 Lift the audio board away from the computer base.

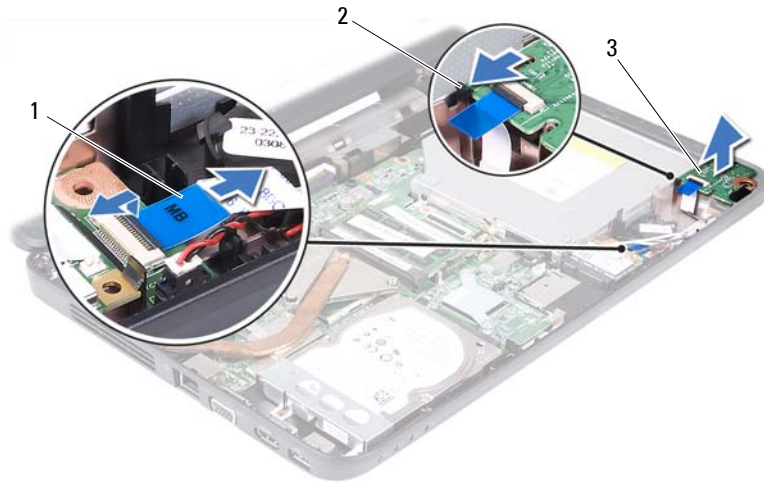

- 1 audio-board cable
- 3 audio board

2 tab





## Replacing the Audio Board

- 1 Follow the instructions in "Before You Begin" on page 9.
- 2 Use the alignment posts on the computer base to place the audio board in place and press the audio board until it clicks into place.
- 3 Slide the audio-board cable into the connector on the system board. Press down on the connector latch to secure the audio-board cable to the connector on the system board.
- 4 Connect the Mini-Card antenna cables to the connectors on the Mini-Card. See "Replacing the Mini-Card" on page 38.
- 5 Follow the instructions from step 3 to step 7 in "Replacing the Palm-Rest Assembly" on page 28.
- 6 Replace the battery. See "Replacing the Battery" on page 14.



**CAUTION:** Before turning on the computer, replace all screws and ensure that no stray screws remain inside the computer. Failure to do so may result in damage to the computer.

# Coin-Cell Battery

-  **WARNING:** Before working inside your computer, read the safety information that shipped with your computer. For additional safety best practices information, see the Regulatory Compliance Homepage at [www.dell.com/regulatory\\_compliance](http://www.dell.com/regulatory_compliance).
-  **CAUTION:** Only a certified service technician should perform repairs on your computer. Damage due to servicing that is not authorized by Dell is not covered by your warranty.
-  **CAUTION:** To avoid electrostatic discharge, ground yourself by using a wrist grounding strap or by periodically touching an unpainted metal surface (such as a connector on your computer).
-  **CAUTION:** To help prevent damage to the system board, remove the main battery, see "Removing the Battery" on page 13, before working inside the computer.

## Removing the Coin-Cell Battery

- 1 Follow the instructions in "Before You Begin" on page 9.
- 2 Remove the battery. See "Removing the Battery" on page 13.
- 3 Follow the instructions from step 3 to step 8 in "Removing the Palm-Rest Assembly" on page 25.

For Inspiron 14-N4050:

- a Lift the connector latch that secures the audio-board cable to the connector on the system board and remove the audio-board cable.
- b Disconnect the coin-cell battery cable from the connector on the system board.
- c Release the coin-cell battery from the battery socket on the computer base.

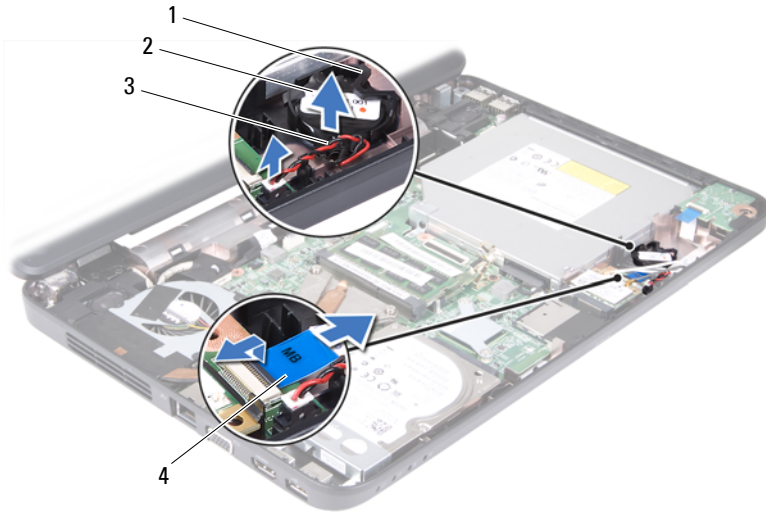

- |   |                         |   |                   |
|---|-------------------------|---|-------------------|
| 1 | battery socket          | 2 | coin-cell battery |
| 3 | coin-cell battery cable | 4 | audio-board cable |

For Inspiron M4040:

- a Using a plastic scribe, gently pry the coin-cell out of the battery socket on the system board.
- b Lift the coin-cell battery out of the battery socket on the system board.



1 plastic scribe

2 coin-cell battery

## Replacing the Coin-Cell Battery

- 1 Follow the instructions in "Before You Begin" on page 9.

For Inspiron M4040:

With the positive side up, snap the coin-cell battery into the battery socket on the system board.

For Inspiron 14-N4050:





- a Slide the coin-cell battery into the battery socket on the computer base.
  - b Connect the coin-cell battery cable to the connector on the system board.
  - c Slide the audio-board cable into the connector on the system board. Press down on the connector latch to secure the audio-board cable to the connector on the system board.
- 2 Follow the instructions from step 3 to step 7 in "Replacing the Palm-Rest Assembly" on page 28.
  - 3 Replace the battery. See "Replacing the Battery" on page 14.



**CAUTION: Before turning on the computer, replace all screws and ensure that no stray screws remain inside the computer. Failure to do so may result in damage to the computer.**



## USB Board

-  **WARNING:** Before working inside your computer, read the safety information that shipped with your computer. For additional safety best practices information, see the Regulatory Compliance Homepage at [www.dell.com/regulatory\\_compliance](http://www.dell.com/regulatory_compliance).
-  **CAUTION:** To avoid electrostatic discharge, ground yourself by using a wrist grounding strap or by periodically touching an unpainted metal surface.
-  **CAUTION:** Only a certified service technician should perform repairs on your computer. Damage due to servicing that is not authorized by Dell is not covered by your warranty.
-  **CAUTION:** To help prevent damage to the system board, remove the main battery, see "Removing the Battery" on page 13, before working inside the computer.

## Removing the USB Board

- 1 Follow the procedures in "Before You Begin" on page 9.
- 2 Remove the battery. See "Removing the Battery" on page 13.
- 3 Follow the instructions from step 3 to step 8 in "Removing the Palm-Rest Assembly" on page 25.
- 4 Remove the optical drive. See "Removing the Optical Drive" on page 23.
- 5 Lift the connector latch that secures the USB-board cable to the connector on the system board and remove the USB-board cable.
- 6 Remove the screw that secures the USB board to the computer base.
- 7 Lift the USB board at an angle and release the connectors on the USB board from the slots on the computer base.

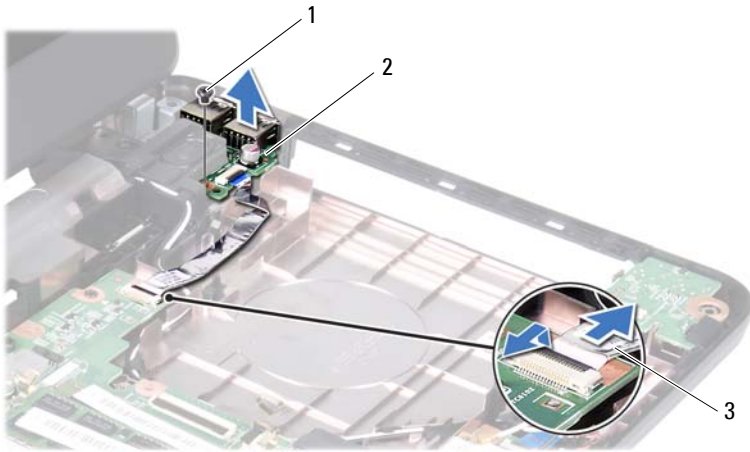

- 1 screw
- 2 USB board
- 3 USB-board cable

## Replacing the USB Board

- 1 Follow the procedures in "Before You Begin" on page 9.
- 2 Slide the connectors on the USB board into the slots on the computer base and align the screw hole on USB board with the screw hole on the computer base.
- 3 Replace the screw that secures the USB board to the computer base.
- 4 Slide the USB-board cable into the connector on the system board. Press down on the connector latch to secure the USB-board cable to the connector on the system board.
- 5 Replace the optical drive. See "Replacing the Optical Drive" on page 24.
- 6 Follow the instructions from step 3 to step 7 in "Replacing the Palm-Rest Assembly" on page 28.
- 7 Replace the battery. See "Replacing the Battery" on page 14.



**CAUTION:** Before turning on the computer, replace all screws and ensure that no stray screws remain inside the computer. Failure to do so may result in damage to the computer.



# Thermal Cooling Assembly



**WARNING:** Before working inside your computer, read the safety information that shipped with your computer. For additional safety best practices information, see the Regulatory Compliance Homepage at [www.dell.com/regulatory\\_compliance](http://www.dell.com/regulatory_compliance).



**CAUTION:** Only a certified service technician should perform repairs on your computer. Damage due to servicing that is not authorized by Dell is not covered by your warranty.



**CAUTION:** To avoid electrostatic discharge, ground yourself by using a wrist grounding strap or by periodically touching an unpainted metal surface (such as a connector on your computer).



**CAUTION:** To help prevent damage to the system board, remove the main battery, see "Removing the Battery" on page 13, before working inside the computer.



**NOTE:** Based on the selection you made at the time of purchase of your computer, location of the fan cable and dimensions of the thermal cooling assembly may vary.

## Removing the Thermal Cooling Assembly

- 1 Follow the instructions in "Before You Begin" on page 9.
- 2 Remove the battery. See "Removing the Battery" on page 13.
- 3 Follow the instructions from step 3 to step 8 in "Removing the Palm-Rest Assembly" on page 25.
- 4 Disconnect the fan cable from the connector on the system board.
- 5 In sequential order (indicated on the thermal cooling assembly), loosen the four captive screws that secure the thermal cooling assembly to the system board.
- 6 Lift the thermal cooling assembly away from the computer.



- 1 thermal cooling assembly
- 2 fan cable
- 3 captive screws (4)





## Replacing the Thermal Cooling Assembly

- 1 Follow the instructions in "Before You Begin" on page 9.
- 2 Align the four captive screws on the thermal cooling assembly with the screw holes on the system board and tighten the screws in sequential order (indicated on the thermal cooling assembly).
- 3 Connect the fan cable to the connector on the system board.
- 4 Follow the instructions from step 3 to step 7 in "Replacing the Palm-Rest Assembly" on page 28.
- 5 Replace the battery. See "Replacing the Battery" on page 14.



**CAUTION:** Before turning on the computer, replace all screws and ensure that no stray screws remain inside the computer. Failure to do so may result in damage to the computer.

# Processor Module (For Inspiron 14-N4050 Only)

-  **WARNING:** Before working inside your computer, read the safety information that shipped with your computer. For additional safety best practices information, see the Regulatory Compliance Homepage at [www.dell.com/regulatory\\_compliance](http://www.dell.com/regulatory_compliance).
-  **CAUTION:** Only a certified service technician should perform repairs on your computer. Damage due to servicing that is not authorized by Dell is not covered by your warranty.
-  **CAUTION:** To avoid electrostatic discharge, ground yourself by using a wrist grounding strap or by periodically touching an unpainted metal surface (such as a connector on your computer).
-  **CAUTION:** To help prevent damage to the system board, remove the main battery, see "Removing the Battery" on page 13, before working inside the computer.
-  **CAUTION:** Handle components and cards by their edges, and avoid touching pins and contacts.

## Removing the Processor Module

- 1 Follow the instructions in "Before You Begin" on page 9.
  - 2 Remove the battery. See "Removing the Battery" on page 13.
  - 3 Follow the instructions from step 3 to step 8 in "Removing the Palm-Rest Assembly" on page 25.
  - 4 Remove the thermal cooling assembly. See "Removing the Thermal Cooling Assembly" on page 49.
  - 5 To loosen the ZIF socket, use a small, flat-blade screwdriver and rotate the ZIF-socket cam screw counterclockwise until it comes to stop.
-  **CAUTION:** To ensure maximum cooling for the processor, do not touch the heat transfer areas on the processor thermal cooling assembly. The oils in your skin can reduce the heat transfer capability of the thermal pads.

**CAUTION:** When removing the processor module, pull the module straight up. Be careful not to bend the pins on the processor module.

- 6 Lift the processor module from the ZIF socket.

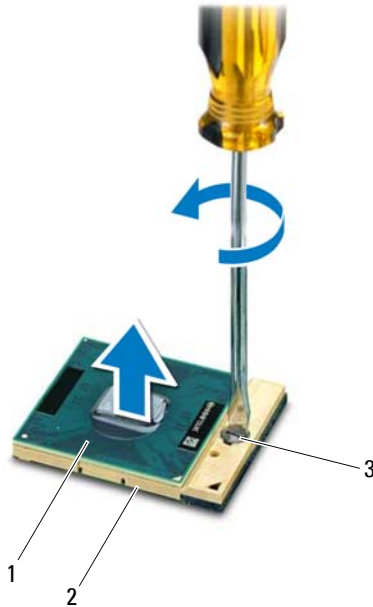

1 processor module

2 ZIF socket

3 ZIF-socket cam screw

## Replacing the Processor Module

- 1 Follow the instructions in "Before You Begin" on page 9.

**NOTE:** If you install a new processor, a new thermal assembly including an affixed thermal pad or a new thermal pad along with documentation to illustrate proper installation is shipped.

- 2 Align the pin-1 corner of the processor module with the pin-1 corner of the ZIF socket, then insert the processor module.



**NOTE:** The pin-1 corner of the processor module has a triangle that aligns with the triangle on the pin-1 corner of the ZIF socket.

When the processor module is properly seated, all four corners are aligned at the same height. If one or more corners of the module are higher than the others, the module is not seated properly.



**CAUTION: To avoid damage to the processor, hold the screwdriver perpendicular to the processor when turning the cam screw.**





- 3 Tighten the ZIF socket by turning the cam screw clockwise to secure the processor module to the system board.
- 4 Replace the thermal cooling assembly. See "Replacing the Thermal Cooling Assembly" on page 50.
- 5 Follow the instructions from step 3 to step 7 in "Replacing the Palm-Rest Assembly" on page 28.
- 6 Replace the battery. See "Replacing the Battery" on page 14.



**CAUTION: Before turning on the computer, replace all screws and ensure that no stray screws remain inside the computer. Failure to do so may result in damage to the computer.**



## Hinge Cover

-  **WARNING:** Before working inside your computer, read the safety information that shipped with your computer. For additional safety best practices information, see the Regulatory Compliance Homepage at [www.dell.com/regulatory\\_compliance](http://www.dell.com/regulatory_compliance).
-  **CAUTION:** Only a certified service technician should perform repairs on your computer. Damage due to servicing that is not authorized by Dell is not covered by your warranty.
-  **CAUTION:** To avoid electrostatic discharge, ground yourself by using a wrist grounding strap or by periodically touching an unpainted metal surface (such as a connector on your computer).
-  **CAUTION:** To help prevent damage to the system board, remove the main battery, see "Removing the Battery" on page 13, before working inside the computer.

## Removing the Hinge Cover

- 1 Follow the instructions in "Before You Begin" on page 9.
- 2 Remove the battery. See "Removing the Battery" on page 13.
- 3 Remove the two screws that secure the hinge cover to the computer base.



- 4 Turn the computer over.
- 5 Pry the hinge cover off the computer base.





- 1 hinge cover

## Replacing the Hinge Cover





- 1 Follow the instructions in "Before You Begin" on page 9.
- 2 Align the tabs on the hinge cover with the slots on the computer base and snap the hinge cover into place.
- 3 Turn the computer over.
- 4 Replace the two screws that secure the hinge cover to the computer base.
- 5 Replace the battery. See "Replacing the Battery" on page 14.



**CAUTION: Before turning on the computer, replace all screws and ensure that no stray screws remain inside the computer. Failure to do so may result in damage to the computer.**



# Display

-  **WARNING:** Before working inside your computer, read the safety information that shipped with your computer. For additional safety best practices information, see the Regulatory Compliance Homepage at [www.dell.com/regulatory\\_compliance](http://www.dell.com/regulatory_compliance).
-  **CAUTION:** Only a certified service technician should perform repairs on your computer. Damage due to servicing that is not authorized by Dell is not covered by your warranty.
-  **CAUTION:** To avoid electrostatic discharge, ground yourself by using a wrist grounding strap or by periodically touching an unpainted metal surface (such as a connector on your computer).
-  **CAUTION:** To help prevent damage to the system board, remove the main battery, see "Removing the Battery" on page 13, before working inside the computer.

## Display Assembly

### Removing the Display Assembly

- 1 Follow the instructions in "Before You Begin" on page 9.
- 2 Remove the battery. See "Removing the Battery" on page 13.
- 3 Follow the instructions from step 3 to step 8 in "Removing the Palm-Rest Assembly" on page 25.
- 4 Remove the optical drive. See "Removing the Optical Drive" on page 23.
- 5 Remove the USB board. See "Removing the USB Board" on page 47.
- 6 Remove the hinge cover. See "Removing the Hinge Cover" on page 55.
- 7 Disconnect the display cable from the connector on the system board.
- 8 Disconnect the Mini-Card antenna cables from the connectors on the Mini-Card.
- 9 Make a note of the display cable and Mini-Card antenna cables routing and remove the cables from the routing guides.

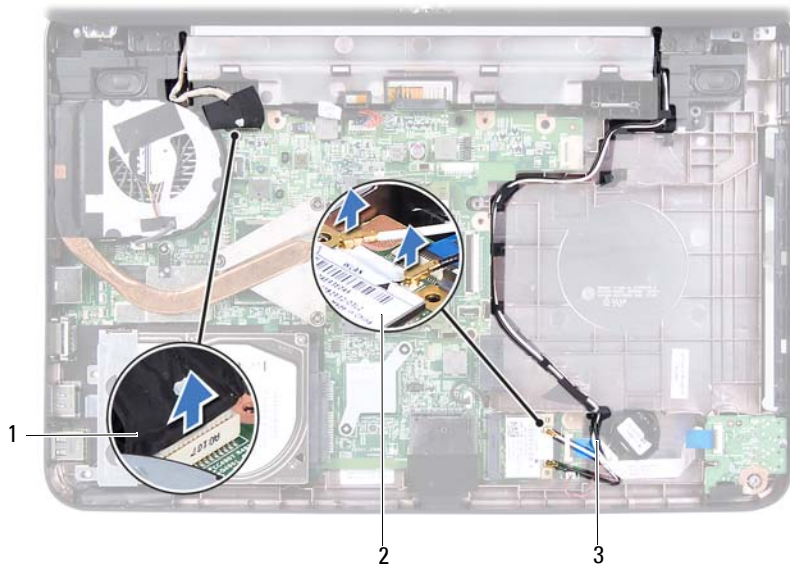

- 1 display cable
- 2 Mini-Card
- 3 Mini-Card antenna cables

- 10** Remove the two screws that secure the display assembly to the computer base.
- 11** Lift and remove the display assembly out of the computer base.



1 display assembly

2 screws (2)

## Replacing the Display Assembly

- 1 Follow the instructions in "Before You Begin" on page 9.
- 2 Place the display assembly in position and replace the two screws that secure the display assembly to the computer base.
- 3 Route the display cable and Mini-Card antenna cables through the routing guides.
- 4 Connect the display cable to the connector on the system board.
- 5 Connect the Mini-Card antenna cables to the Mini-Card.
- 6 Replace the hinge cover. See "Replacing the Hinge Cover" on page 57.
- 7 Replace the USB board. See "Replacing the USB Board" on page 48.
- 8 Replace the optical drive. See "Replacing the Optical Drive" on page 24.

- 9 Follow the instructions from step 3 to step 7 in "Replacing the Palm-Rest Assembly" on page 28.
- 10 Replace the battery. See "Replacing the Battery" on page 14.

**CAUTION:** Before turning on the computer, replace all screws and ensure that no stray screws remain inside the computer. Failure to do so may result in damage to the computer.

## Display Bezel

### Removing the Display Bezel

- 1 Follow the instructions in "Before You Begin" on page 9.
- 2 Remove the display assembly. See "Removing the Display Assembly" on page 59.

**CAUTION:** The display bezel is extremely fragile. Be careful when removing it to prevent damaging the display bezel.

- 3 Using your fingertips, carefully pry up the inside edge of the display bezel.
- 4 Remove the display bezel.



- 1 display bezel

## Replacing the Display Bezel

- 1 Follow the instructions in "Before You Begin" on page 9.
- 2 Realign the display bezel over the display panel and gently snap into place.
- 3 Replace the display assembly. See "Replacing the Display Assembly" on page 61.

 **CAUTION:** Before turning on the computer, replace all screws and ensure that no stray screws remain inside the computer. Failure to do so may result in damage to the computer.

## Display Panel

### Removing the Display Panel

- 1 Follow the instructions in "Before You Begin" on page 9.
- 2 Remove the display assembly. See "Removing the Display Assembly" on page 59.
- 3 Remove the display bezel. See "Removing the Display Bezel" on page 62.
- 4 Disconnect the camera cable from the connector on the camera module. See "Removing the Camera Module" on page 69.
- 5 Make a note of the display cable and Mini-Card antenna cables routing and remove them from the routing guides on the display hinges.
- 6 Remove the six screws that secure the display panel to the display cover.

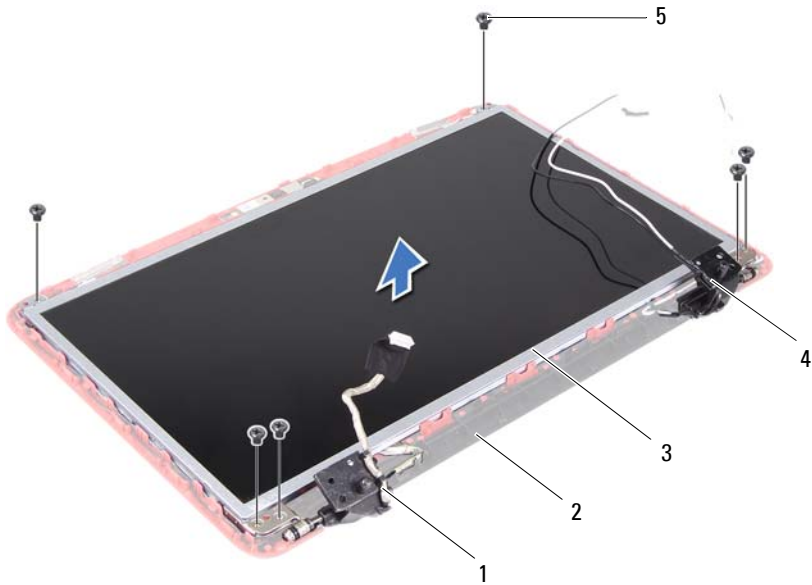

- |   |               |   |                          |
|---|---------------|---|--------------------------|
| 1 | display cable | 2 | display cover            |
| 3 | display panel | 4 | Mini-Card antenna cables |
| 5 | screws (6)    |   |                          |

- 7 Lift the display panel off the display cover.
- 8 Remove the four screws (two on each side) that secure the display-panel brackets to the display panel.





1 screws (4)

2 display-panel brackets (2)

**9** Turn the display panel over and place it on a clean surface.

**10** Peel and lift the tape that secures the display cable to the display-board connector and disconnect the display cable.

**11** Make a note of the display cable routing and peel the cable from the back of the display panel.

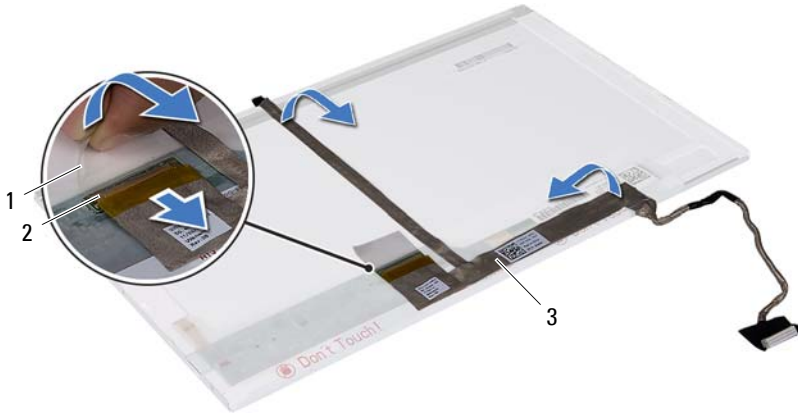

- 1 tape
- 2 display-board connector
- 3 display cable

## Replacing the Display Panel





- 1 Follow the instructions in "Before You Begin" on page 9.
- 2 Attach the display cable to the back of the display panel.
- 3 Connect the display cable to the display-board connector and secure it with the tape.
- 4 Turn the display panel over.
- 5 Align the screw holes on the display-panel bracket with the screw holes on the display panel and replace the four screws (two on each side).
- 6 Align the screw holes on the display panel with the screw holes on the display cover and replace the six screws.
- 7 Route the display cable and Mini-Card antenna cables through the routing guides on the display hinges.
- 8 Connect the camera cable to the connector on the camera module. See "Replacing the Camera Module" on page 70.
- 9 Replace the display bezel. See "Replacing the Display Bezel" on page 63.
- 10 Replace the display assembly. See "Replacing the Display Assembly" on page 61.



**CAUTION:** Before turning on the computer, replace all screws and ensure that no stray screws remain inside the computer. Failure to do so may result in damage to the computer.



# Camera Module

-  **WARNING:** Before working inside your computer, read the safety information that shipped with your computer. For additional safety best practices information, see the Regulatory Compliance Homepage at [www.dell.com/regulatory\\_compliance](http://www.dell.com/regulatory_compliance).
-  **CAUTION:** Only a certified service technician should perform repairs on your computer. Damage due to servicing that is not authorized by Dell is not covered by your warranty.
-  **CAUTION:** To avoid electrostatic discharge, ground yourself by using a wrist grounding strap or by periodically touching an unpainted metal surface (such as a connector on your computer).
-  **CAUTION:** To help prevent damage to the system board, remove the main battery, see "Removing the Battery" on page 13, before working inside the computer.

## Removing the Camera Module

- 1 Follow the instructions in "Before You Begin" on page 9.
- 2 Remove the battery. See "Removing the Battery" on page 13.
- 3 Follow the instructions from step 3 to step 8 in "Removing the Palm-Rest Assembly" on page 25.
- 4 Remove the optical drive. See "Removing the Optical Drive" on page 23.
- 5 Remove the USB board. See "Removing the USB Board" on page 47.
- 6 Remove the hinge cover. See "Removing the Hinge Cover" on page 55.
- 7 Remove the display assembly. See "Removing the Display Assembly" on page 59.
- 8 Remove the display bezel. See "Removing the Display Bezel" on page 62.
- 9 Disconnect the camera cable from the connector on the camera module.
- 10 Release the tabs that secure the camera module to the display cover and lift the camera module off the display cover.

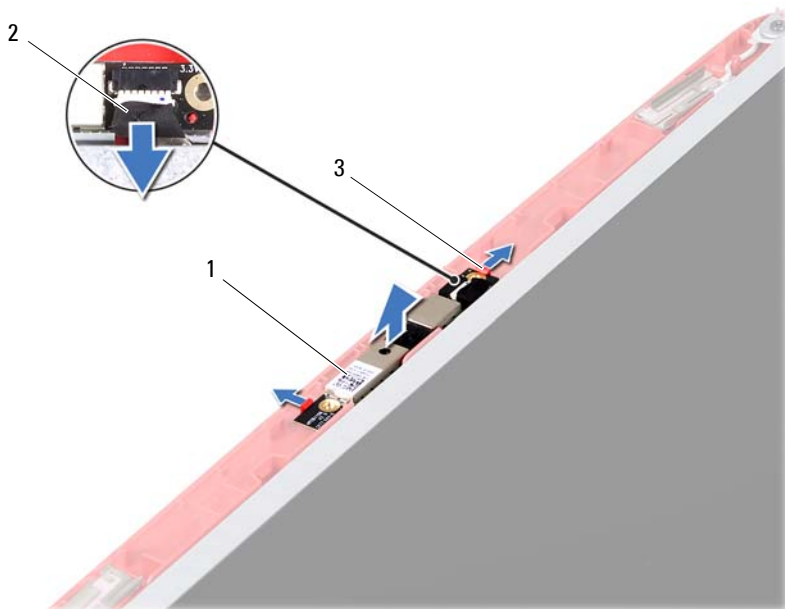

- 1 camera module
- 2 camera cable
- 3 tabs (2)

## Replacing the Camera Module

- 1 Follow the instructions in "Before You Begin" on page 9.
- 2 Connect the camera cable to the connector on the camera module.
- 3 Use the alignment posts on the display cover to place the camera module in position and snap the camera module into place.
- 4 Replace the display bezel. See "Replacing the Display Bezel" on page 63.
- 5 Replace the display assembly. See "Replacing the Display Assembly" on page 61.
- 6 Replace the hinge cover. See "Replacing the Hinge Cover" on page 57.
- 7 Replace the USB board. See "Replacing the USB Board" on page 48.

- 8 Replace the optical drive. See "Replacing the Optical Drive" on page 24.
- 9 Follow the instructions from step 3 to step 7 in "Replacing the Palm-Rest Assembly" on page 28.
- 10 Replace the battery. See "Replacing the Battery" on page 14.







**CAUTION: Before turning on the computer, replace all screws and ensure that no stray screws remain inside the computer. Failure to do so may result in damage to the computer.**





# System Board

-  **WARNING:** Before working inside your computer, read the safety information that shipped with your computer. For additional safety best practices information, see the Regulatory Compliance Homepage at [www.dell.com/regulatory\\_compliance](http://www.dell.com/regulatory_compliance).
-  **CAUTION:** Only a certified service technician should perform repairs on your computer. Damage due to servicing that is not authorized by Dell is not covered by your warranty.
-  **CAUTION:** To avoid electrostatic discharge, ground yourself by using a wrist grounding strap or by periodically touching an unpainted metal surface (such as a connector on your computer).
-  **CAUTION:** To help prevent damage to the system board, remove the main battery, see "Removing the Battery" on page 13, before working inside the computer.
-  **CAUTION:** Handle components and cards by their edges, and avoid touching pins and contacts.

## Removing the System Board

- 1 Follow the instructions in "Before You Begin" on page 9.
- 2 Press and eject any installed cards from the 3-in-1 media card reader.
- 3 Remove the battery. See "Removing the Battery" on page 13.
- 4 Remove the keyboard. See "Removing the Keyboard" on page 15.
- 5 Remove the memory module(s). See "Removing the Memory Module(s)" on page 19.
- 6 Remove the optical drive. See "Removing the Optical Drive" on page 23.
- 7 Follow the instructions from step 3 to step 8 in "Removing the Palm-Rest Assembly" on page 25.
- 8 Remove the Mini-Card. See "Removing the Mini-Card" on page 37.
- 9 Follow the instructions from step 4 to step 5 in "Removing the Hard Drive" on page 33.

- 10 Remove the thermal cooling assembly. See "Removing the Thermal Cooling Assembly" on page 49.
- 11 Remove the processor. See "Removing the Processor Module" on page 51.
- 12 Disconnect the display cable, speakers cable, audio-board cable, USB-board cable, coin-cell battery cable, and AC-adaptor cable from the connectors on the system board.

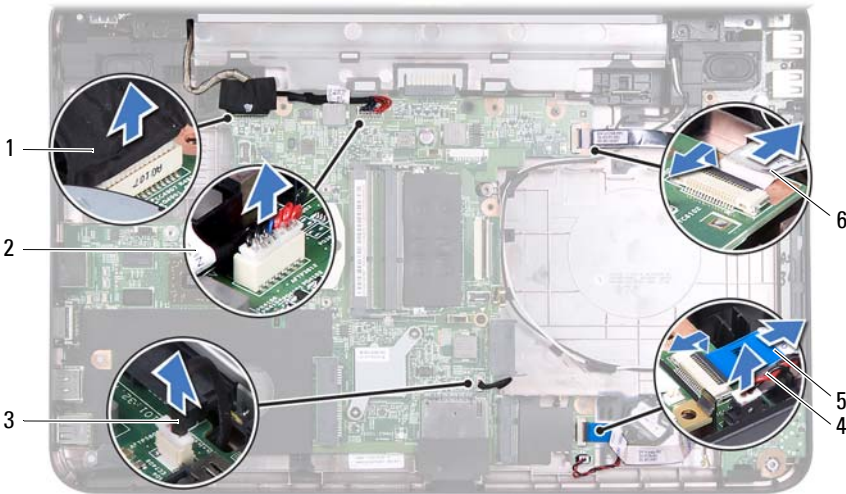

- |                     |                           |
|---------------------|---------------------------|
| 1 display cable     | 2 AC-adaptor cable        |
| 3 speakers cable    | 4 coin-cell battery cable |
| 5 audio-board cable | 6 USB-board cable         |

- 13 Remove the two screws that secure the system board to the computer base.
- 14 Lift the system board at an angle and release the connectors on the system board from the slots on the computer base.

**NOTE:** Based on the selection you made at the time of purchase of your computer, the dimensions of the system board and the location of the system board components may vary.

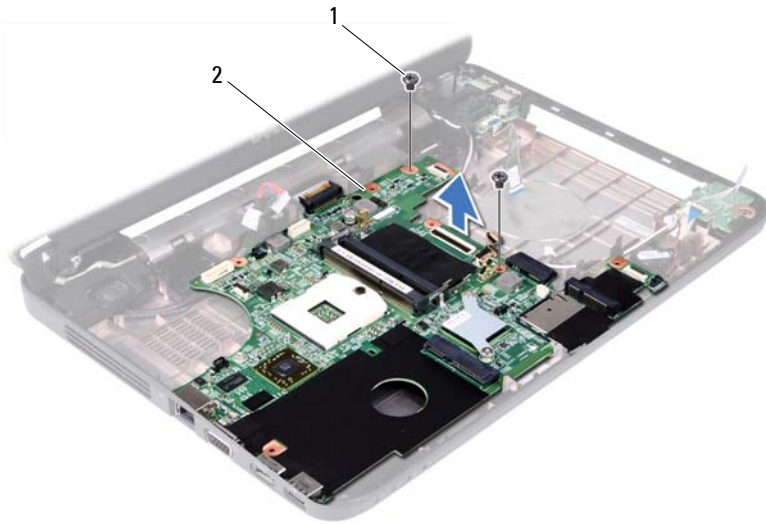



1 screws (2)

2 system board

## Replacing the System Board

- 1 Follow the instructions in "Before You Begin" on page 9.
- 2 Slide the connectors on the system board into the slots on the computer base.
- 3 Replace the two screws that secure the system board to the computer base.
- 4 Connect the display cable, speakers cable, audio-board cable, USB-board cable, coin-cell battery cable, and AC-adaptor cable to the connectors on the system board.
- 5 Replace the processor. See "Replacing the Processor Module" on page 52.
- 6 Replace the thermal cooling assembly. See "Replacing the Thermal Cooling Assembly" on page 50.
- 7 Follow the instructions from step 5 to step 6 in "Replacing the Hard Drive" on page 35.
- 8 Replace the Mini-Card. See "Replacing the Mini-Card" on page 38.

- 9 Follow the instructions from step 3 to step 7 in "Replacing the Palm-Rest Assembly" on page 28.
  - 10 Replace the optical drive. See "Replacing the Optical Drive" on page 24.
  - 11 Replace the memory module(s). See "Replacing the Memory Module(s)" on page 20.
  - 12 Replace the keyboard. See "Replacing the Keyboard" on page 17.
  - 13 Replace the battery. See "Replacing the Battery" on page 14.
  - 14 Replace any removed cards or blanks in the 3-in-1 media card reader.
-  **CAUTION: Before turning on the computer, replace all screws and ensure that no stray screws remain inside the computer. Failure to do so may result in damage to the computer.**
- 15 Turn on the computer.
-  **NOTE:** After you have replaced the system board, enter the computer Service Tag into the BIOS of the replacement system board.
- 16 Enter the service tag. See "Entering the Service Tag in the BIOS" on page 76.

## Entering the Service Tag in the BIOS

- 1 Ensure that the AC adapter is plugged in and that the main battery is installed properly.
- 2 Turn on the computer.
- 3 Press <F2> during POST to enter the system setup program.
- 4 Navigate to the security tab and enter the service tag in the **Set Service Tag** field.

## Flashing the BIOS

The BIOS may require flashing when an update is available or when replacing the system board. To flash the BIOS:

- 1 Turn on the computer.
- 2 Go to [support.dell.com/support/downloads](http://support.dell.com/support/downloads).
- 3 Locate the BIOS update file for your computer:



**NOTE:** The Service Tag for your computer is located on a label at the bottom of your computer.

If you have your computer's Service Tag:

- a Click **Enter a Tag**.
- b Enter your computer's Service Tag in the **Enter a service tag:** field, click **Go**, and proceed to step 4.

If you do not have your computer's Service Tag:

- a Click **Select Model**.
- b Select the type of product in the **Select Your Product Family** list.
- c Select the product brand in the **Select Your Product Line** list.
- d Select the product model number in the **Select Your Product Model** list.



**NOTE:** If you have selected a different model and want to start over again, click **Start Over** on the top right of the menu.

- e Click **Confirm**.
- 4 A list of results appear on the screen. Click **BIOS**.
- 5 Click **Download Now** to download the latest BIOS file. The **File Download** window appears.
- 6 Click **Save** to save the file on your desktop. The file downloads to your desktop.
- 7 Click **Close** if the **Download Complete** window appears. The file icon appears on your desktop and the name of the file is the same as the file that you downloaded.

- 8 Double-click the file icon on the desktop and follow the instructions on the screen.