

Inspiron 14

5000 Series

Owner's Manual

Computer Model: Inspiron 5447
Regulatory Model: P49G
Regulatory Type: P49G001



Notes, Cautions, and Warnings



NOTE: A NOTE indicates important information that helps you make better use of your computer.



CAUTION: A CAUTION indicates either potential damage to hardware or loss of data and tells you how to avoid the problem.



WARNING: A WARNING indicates a potential for property damage, personal injury, or death.

Copyright © 2014 Dell Inc. All rights reserved. This product is protected by U.S. and international copyright and intellectual property laws. Dell™ and the Dell logo are trademarks of Dell Inc. in the United States and/or other jurisdictions. All other marks and names mentioned herein may be trademarks of their respective companies.

2014 - 06

Rev. A01

Contents

Before Working Inside Your Computer.....	8
Before You Begin	8
Safety Instructions.....	8
Recommended Tools.....	9
After Working Inside Your Computer.....	11
Removing the Base Cover.....	12
Procedure.....	12
Replacing the Base Cover.....	13
Procedure.....	13
Removing the Battery.....	14
Prerequisites.....	14
Procedure.....	14
Replacing the Battery.....	15
Procedure.....	15
Post-requisites.....	15
Removing the Hard Drive.....	16
Prerequisites.....	16
Procedure.....	16
Replacing the Hard Drive.....	19
Procedure.....	19
Post-requisites.....	19

Removing the Wireless Card.....	20
Prerequisites.....	20
Procedure.....	20
Replacing the Wireless Card.....	22
Procedure.....	22
Post-requisites.....	22
Removing the Memory Module(s).....	23
Prerequisites.....	23
Procedure.....	23
Replacing the Memory Module(s).....	25
Procedure.....	25
Post-requisites.....	26
Removing the Fan.....	27
Prerequisites.....	27
Procedure.....	27
Replacing the Fan.....	30
Procedure.....	30
Post-requisites.....	30
Removing the Keyboard.....	31
Prerequisites.....	31
Procedure.....	31
Replacing the Keyboard.....	34
Procedure.....	34
Post-requisites.....	34
Folding the Keyboard Cables.....	34

Removing the Base Frame.....	38
Prerequisites.....	38
Procedure.....	39
Replacing the Base Frame.....	42
Procedure.....	42
Post-requisites.....	42
Removing the Heat Sink.....	43
Prerequisites.....	43
Procedure.....	43
Replacing the Heat Sink.....	45
Procedure.....	45
Post-requisites.....	45
Removing the Coin-Cell Battery.....	46
Prerequisites.....	46
Procedure.....	46
Replacing the Coin-Cell Battery.....	48
Procedure.....	48
Post-requisites.....	48
Removing the Speakers.....	49
Prerequisites.....	49
Procedure.....	49
Replacing the Speakers.....	51
Procedure.....	51
Post-requisites.....	51

Removing the I/O Board.....	52
Prerequisites.....	52
Procedure.....	52
Replacing the I/O Board.....	54
Procedure.....	54
Post-requisites.....	54
Removing the Status-Light Board.....	55
Prerequisites.....	55
Procedure.....	55
Replacing the Status-Light Board.....	59
Procedure.....	59
Post-requisites.....	59
Removing the System Board.....	60
Prerequisites.....	60
Procedure.....	60
Replacing the System Board.....	65
Procedure.....	65
Post-requisites.....	65
Removing the Display Assembly.....	66
Prerequisites.....	66
Procedure.....	67
Replacing the Display Assembly.....	69
Procedure.....	69
Post-requisites.....	70



Removing the Power-Adapter Port.....	71
Prerequisites.....	71
Procedure.....	71
Replacing the Power-Adapter Port.....	75
Procedure.....	75
Post-requisites.....	75
Removing the Palm Rest.....	76
Prerequisites.....	76
Procedure.....	76
Replacing the Palm Rest.....	78
Procedure.....	78
Post-requisites.....	78
Flashing the BIOS.....	79

Before Working Inside Your Computer

 **CAUTION:** To avoid damaging the components and cards, handle them by their edges and avoid touching pins and contacts.









 **NOTE:** The images in this document may differ from your computer depending on the configuration you ordered.

Before You Begin

- 1 Save and close all open files and exit all open applications.
 - 2 Shut down your computer.
 - Windows 8.1: On the **Start** screen, click or tap the power icon  → **Shut down**.
 - Windows 7: Click or tap **Start** → **Shut down**.
-  **NOTE:** If you are using a different operating system, see the documentation of your operating system for shut-down instructions.
- 3 Disconnect your computer and all attached devices from their electrical outlets.
 - 4 Disconnect all cables such as telephone cables, network cables and so on, from your computer.
 - 5 Disconnect all attached devices and peripherals, such as keyboard, mouse, monitor, and so on, from your computer.
 - 6 Remove any media card and optical disc from your computer, if applicable.
 - 7 After the computer is unplugged, press and hold the power button for 5 seconds to ground the system board.

Safety Instructions

Use the following safety guidelines to protect your computer from potential damage and ensure your personal safety.

-  **WARNING:** Before working inside your computer, read the safety information that shipped with your computer. For more safety best practices, see the Regulatory Compliance home page at dell.com/regulatory_compliance.
-  **WARNING:** Disconnect all power sources before opening the computer cover or panels. After you finish working inside the computer, replace all covers, panels, and screws before connecting to the power source.
-  **CAUTION:** To avoid damaging the computer, make sure that the work surface is flat and clean.
-  **CAUTION:** To avoid damaging the components and cards, handle them by their edges and avoid touching pins and contacts.
-  **CAUTION:** Only a certified service technician is authorized to remove the computer cover and access any of the components inside the computer. See the safety instructions for complete information about safety precautions, working inside your computer, and protecting against electrostatic discharge.
-  **CAUTION:** Before touching anything inside your computer, ground yourself by touching an unpainted metal surface, such as the metal at the back of the computer. While you work, periodically touch an unpainted metal surface to dissipate static electricity, which could harm internal components.
-  **CAUTION:** When you disconnect a cable, pull on its connector or on its pull-tab, not on the cable itself. Some cables have connectors with locking tabs or thumb-screws that you must disengage before disconnecting the cable. When disconnecting cables, keep them evenly aligned to avoid bending any connector pins. When connecting cables, make sure that the ports and connectors are correctly oriented and aligned.
-  **CAUTION:** To disconnect a network cable, first unplug the cable from your computer and then unplug the cable from the network device.
-  **CAUTION:** Press and eject any installed card from the media-card reader.

Recommended Tools

The procedures in this document may require the following tools:

- Philips screwdriver
- Plastic scribe

After Working Inside Your Computer



CAUTION: Leaving stray or loose screws inside your computer may severely damage your computer.

- 1 Replace all screws and make sure that no stray screws remain inside your computer.
- 2 Connect any external devices, peripherals, and cables you removed before working on your computer.
- 3 Replace any media cards, discs, and any other part(s) that you removed before working on your computer.
- 4 Connect your computer and all attached devices to their electrical outlets.
- 5 Turn on your computer.

Removing the Base Cover

⚠ WARNING: Before working inside your computer, read the safety information that shipped with your computer and follow the steps in [Before Working Inside Your Computer](#). After working inside your computer, follow the instructions in [After Working Inside Your Computer](#). For more safety best practices, see the Regulatory Compliance home page at dell.com/regulatory_compliance.

Procedure

- 1 Close the display and turn the computer over.
- 2 Remove the screws that secure the base cover to the base frame.
- 3 Using a plastic scribe, pry the base cover out of the base frame.
- 4 Slide and lift the base cover off the base frame.

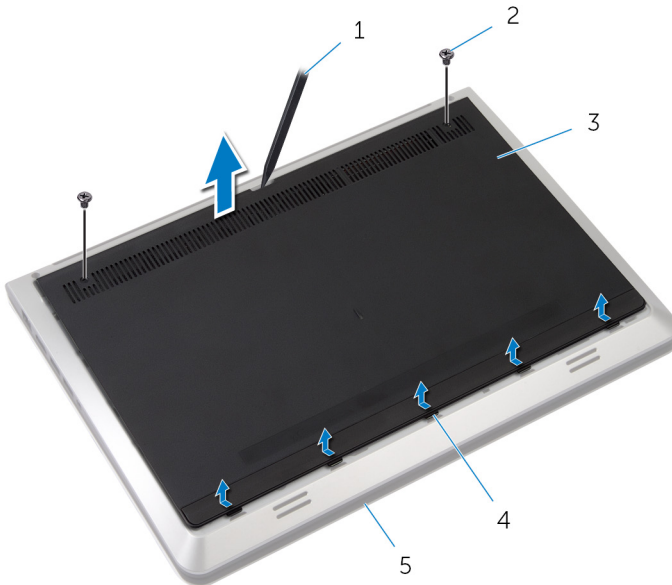

- | | | | |
|---|----------------|---|------------|
| 1 | plastic scribe | 2 | screws (2) |
| 3 | base cover | 4 | tabs |
| 5 | base frame | | |

Replacing the Base Cover



WARNING: Before working inside your computer, read the safety information that shipped with your computer and follow the steps in [Before Working Inside Your Computer](#). After working inside your computer, follow the instructions in [After Working Inside Your Computer](#). For more safety best practices, see the Regulatory Compliance home page at dell.com/regulatory_compliance.

Procedure

- 1 Slide the tabs on the base cover into the slots on the base frame.
- 2 Press down on the base cover to snap it in place.
- 3 Replace the screws that secure the base cover to the base frame.

Removing the Battery

⚠ WARNING: Before working inside your computer, read the safety information that shipped with your computer and follow the steps in [Before Working Inside Your Computer](#). After working inside your computer, follow the instructions in [After Working Inside Your Computer](#). For more safety best practices, see the Regulatory Compliance home page at dell.com/regulatory_compliance.

Prerequisites

Remove the [base cover](#).

Procedure

- 1 Remove the screws that secure the battery to the base frame.
- 2 Lift the battery off the base frame.

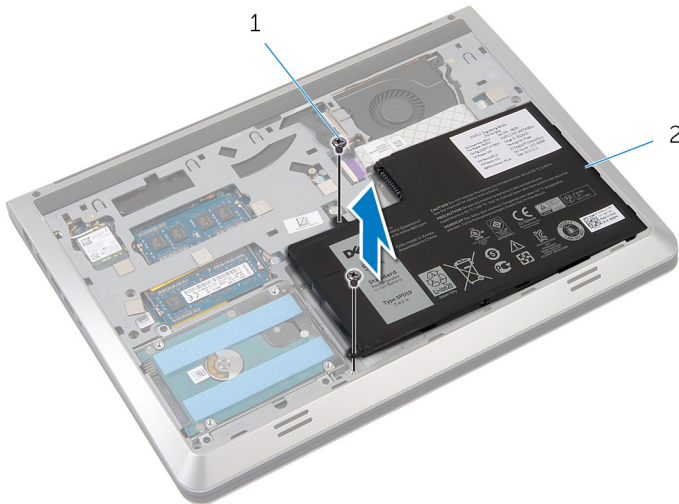

1 screws (2)

2 battery

- 3 Turn the computer over, open the display, and press the power button for five seconds to ground the system board.

Replacing the Battery



WARNING: Before working inside your computer, read the safety information that shipped with your computer and follow the steps in [Before Working Inside Your Computer](#). After working inside your computer, follow the instructions in [After Working Inside Your Computer](#). For more safety best practices, see the Regulatory Compliance home page at dell.com/regulatory_compliance.

Procedure

- 1 Align the screw holes on the battery with the screw holes on the base frame and press down on the battery to connect it to the battery connector.
- 2 Replace the screws that secure the battery to the base frame.

Post-requisites

Replace the [base cover](#).

Removing the Hard Drive

 **WARNING:** Before working inside your computer, read the safety information that shipped with your computer and follow the steps in [Before Working Inside Your Computer](#). After working inside your computer, follow the instructions in [After Working Inside Your Computer](#). For more safety best practices, see the Regulatory Compliance home page at dell.com/regulatory_compliance.

 **CAUTION:** Hard drives are fragile. Exercise care when handling the hard drive.

 **CAUTION:** To avoid data loss, do not remove the hard drive while the computer is in Sleep or On state.

Prerequisites

- 1 Remove the [base cover](#).
- 2 Remove the [battery](#).

Procedure

- 1 Remove the screws that secure the hard-drive assembly to the base frame.

- 2** Gently lift the hard-drive assembly out of the base frame and disconnect the hard-drive cable from the hard drive.

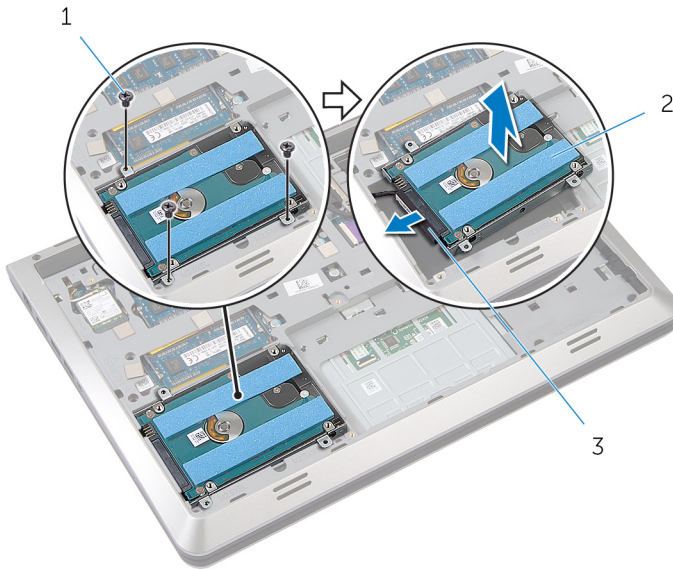

1 screws (3)

2 hard drive

3 hard-drive cable

- 3** Remove the screws that secure the hard-drive bracket to the hard drive.

4 Lift the hard-drive bracket off the hard drive.

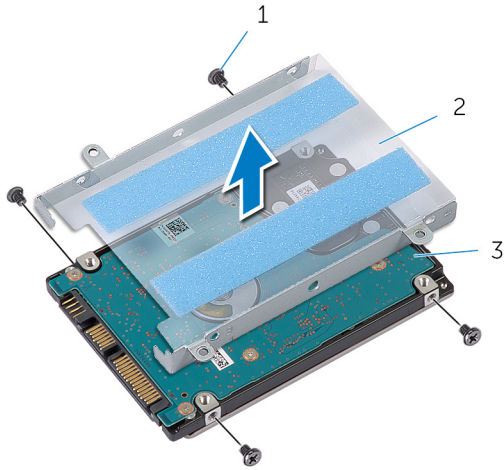

1 screws (4)

2 hard-drive bracket

3 hard drive

Replacing the Hard Drive

 **WARNING:** Before working inside your computer, read the safety information that shipped with your computer and follow the steps in [Before Working Inside Your Computer](#). After working inside your computer, follow the instructions in [After Working Inside Your Computer](#). For more safety best practices, see the Regulatory Compliance home page at dell.com/regulatory_compliance.

 **CAUTION:** Hard drives are fragile. Exercise care when handling the hard drive.

Procedure

- 1 Place the hard-drive bracket on the hard drive.
- 2 Align the screw holes on the hard drive-bracket with the screw holes on the hard drive.
- 3 Replace the screws that secure the hard-drive bracket to the hard drive.
- 4 Connect the hard-drive cable to the hard drive.
- 5 Place the hard-drive assembly in the base frame and align the screw holes on the hard-drive assembly with the screw holes on the base frame.
- 6 Replace the screws that secure the hard-drive assembly to the base frame.

Post-requisites

- 1 Replace the [battery](#).
- 2 Replace the [base cover](#).

Removing the Wireless Card



WARNING: Before working inside your computer, read the safety information that shipped with your computer and follow the steps in [Before Working Inside Your Computer](#). After working inside your computer, follow the instructions in [After Working Inside Your Computer](#). For more safety best practices, see the Regulatory Compliance home page at dell.com/regulatory_compliance.

Prerequisites

- 1 Remove the [base cover](#).
- 2 Remove the [battery](#).

Procedure

- 1 Disconnect the antenna cables from the wireless card.
- 2 Remove the screw that secures the wireless card to the system board.

3 Lift and slide the wireless card out of the wireless-card slot.

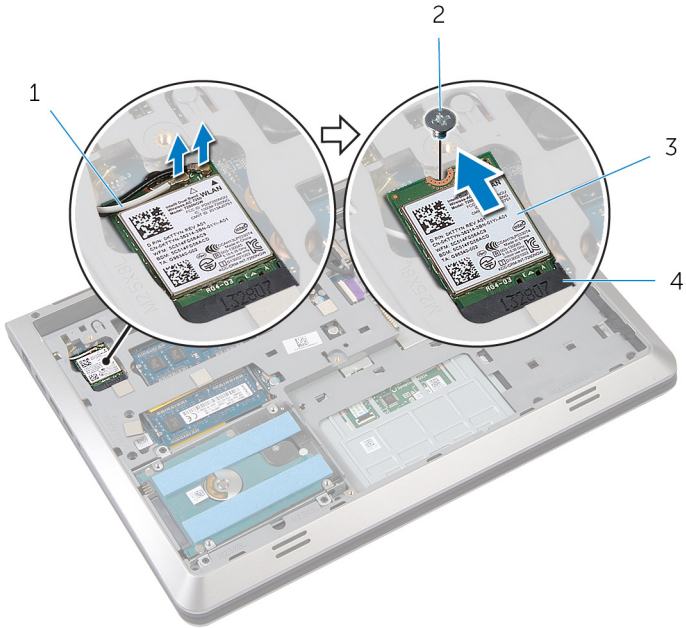

1 antenna cables (2)

2 screw

3 wireless card

4 wireless-card slot

Replacing the Wireless Card

 **WARNING:** Before working inside your computer, read the safety information that shipped with your computer and follow the steps in [Before Working Inside Your Computer](#). After working inside your computer, follow the instructions in [After Working Inside Your Computer](#). For more safety best practices, see the Regulatory Compliance home page at dell.com/regulatory_compliance.

Procedure

 **CAUTION:** To avoid damage to the wireless card, do not place any cables under it.

- 1 Align the notch on the wireless card with the tab on the wireless-card slot and slide the card into the slot.
- 2 Align the screw hole on the wireless card with the screw hole on the system board.
- 3 Replace the screw that secures the wireless card to the system board.
- 4 Connect the antenna cables to the wireless card.

The following table provides the antenna-cable color scheme for the wireless card supported by your computer.

Connectors on the wireless card	Antenna-cable color
Main (white triangle)	white
Auxiliary (black triangle)	black

Post-requisites

- 1 Replace the [battery](#).
- 2 Replace the [base cover](#).

Removing the Memory Module(s)

 **WARNING:** Before working inside your computer, read the safety information that shipped with your computer and follow the steps in [Before Working Inside Your Computer](#). After working inside your computer, follow the instructions in [After Working Inside Your Computer](#). For more safety best practices, see the Regulatory Compliance home page at dell.com/regulatory_compliance.

Prerequisites

- 1 Remove the [base cover](#).
- 2 Remove the [battery](#).

Procedure

- 1 Use your fingertips to carefully spread apart the securing-clips on each end of the memory-module slot until the memory module pops up.

2 Slide and remove the memory module from the memory-module slot.

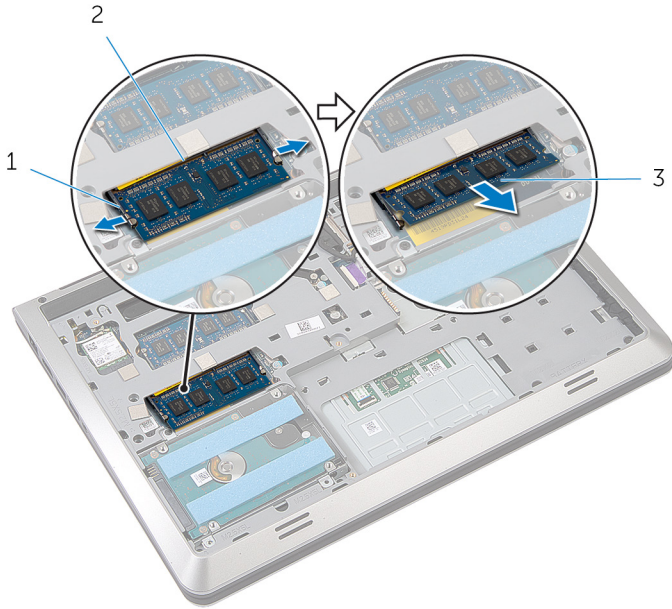

1 securing-clips (2)

2 memory-module slot

3 memory module

Replacing the Memory Module(s)

 **WARNING:** Before working inside your computer, read the safety information that shipped with your computer and follow the steps in [Before Working Inside Your Computer](#). After working inside your computer, follow the instructions in [After Working Inside Your Computer](#). For more safety best practices, see the Regulatory Compliance home page at dell.com/regulatory_compliance.

Procedure

- 1 Align the notch on the memory module with the tab on the memory-module slot.

- Slide the memory module firmly into the slot at an angle, and press the memory module down until it clicks into place.

 **NOTE:** If you do not hear the click, remove the memory module and reinstall it.

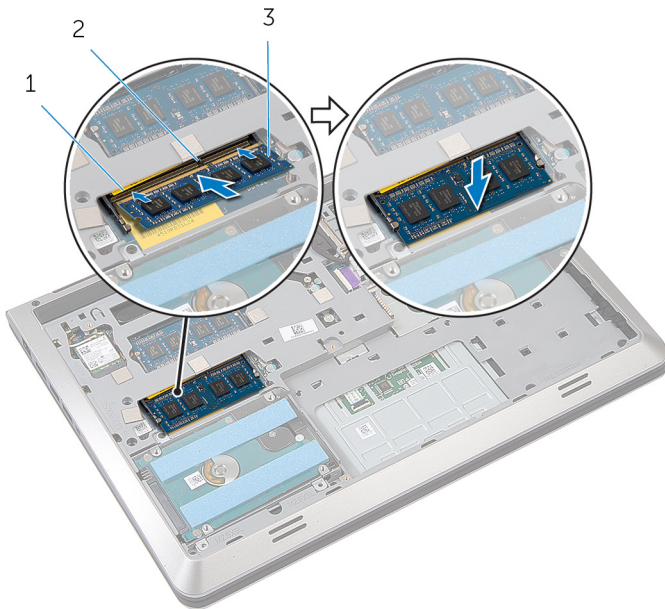

1 memory-module slot

2 tab

3 memory module

Post-requisites

- Replace the [battery](#).
- Replace the [base cover](#).

Removing the Fan



WARNING: Before working inside your computer, read the safety information that shipped with your computer and follow the steps in [Before Working Inside Your Computer](#). After working inside your computer, follow the instructions in [After Working Inside Your Computer](#). For more safety best practices, see the Regulatory Compliance home page at dell.com/regulatory_compliance.

Prerequisites

- 1 Remove the [base cover](#).
- 2 Remove the [battery](#).

Procedure

- 1 Lift the latch and using the pull tab, disconnect the I/O-board cable from the system board.
- 2 Peel off the I/O-board cable from the fan.
- 3 Disconnect the display cable from the system board.

- 4** Note the display-cable routing and remove the cable from the routing guides.

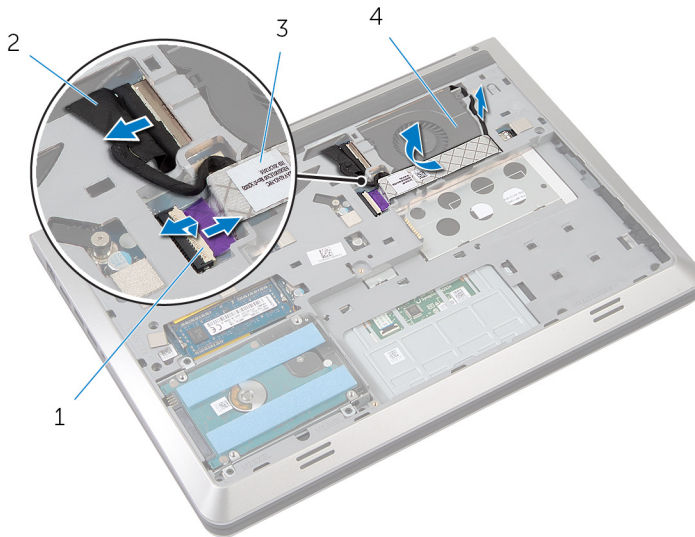

- | | | | |
|---|-----------------|---|---------------|
| 1 | latch | 2 | display cable |
| 3 | I/O-board cable | 4 | fan |

- 5** Disconnect the fan cable from the system board.
- 6** Note the fan-cable routing and remove the cable from the routing guides.
- 7** Remove the screws that secure the fan to the base frame.

8 Lift the fan off the palm rest.

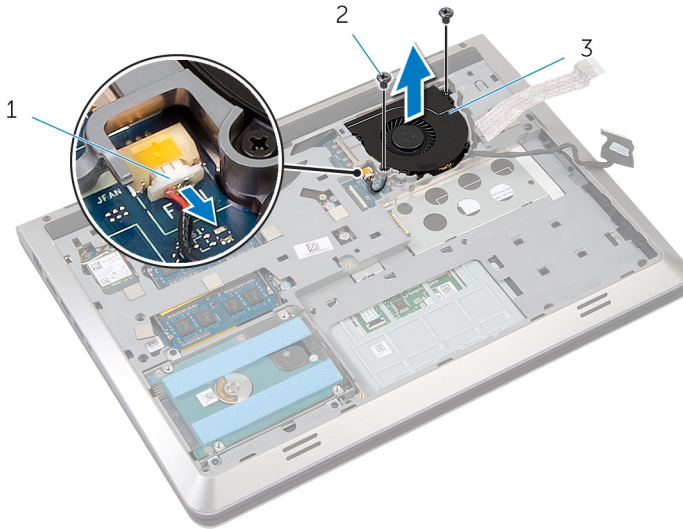

1 fan cable

2 screws (2)

3 fan

Replacing the Fan



WARNING: Before working inside your computer, read the safety information that shipped with your computer and follow the steps in [Before Working Inside Your Computer](#). After working inside your computer, follow the instructions in [After Working Inside Your Computer](#). For more safety best practices, see the Regulatory Compliance home page at dell.com/regulatory_compliance.

Procedure

- 1 Place the fan on the palm rest and align the screw holes on the fan with the screw holes on the base frame.
- 2 Replace the screws that secure the fan to the base frame.
- 3 Route the fan cable through the routing guides and connect it to the system board.
- 4 Route the display cable through the routing guides and connect it to the system board.
- 5 Adhere the I/O-board cable to the fan.
- 6 Slide the I/O-board cable in the connector and press down on the latch to secure the cable.

Post-requisites

- 1 Replace the [battery](#).
- 2 Replace the [base cover](#).

Removing the Keyboard



WARNING: Before working inside your computer, read the safety information that shipped with your computer and follow the steps in [Before Working Inside Your Computer](#). After working inside your computer, follow the instructions in [After Working Inside Your Computer](#). For more safety best practices, see the Regulatory Compliance home page at dell.com/regulatory_compliance.

Prerequisites

- 1 Remove the [base cover](#).
- 2 Remove the [battery](#).

Procedure

- 1 Turn the computer over and open the display.
- 2 Using a plastic scribe, pry out the keyboard from its top edge.
- 3 Slide the keyboard toward the display to release the tabs from the palm rest.

4 Turn the keyboard over and place it on the palm rest.

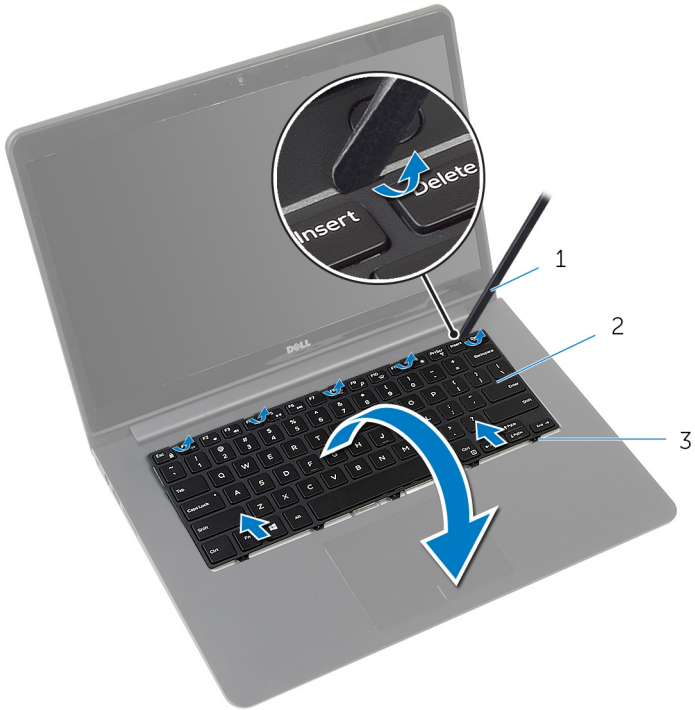

1 plastic scribe

2 keyboard

3 tabs

- 5 Lift the latches and, using the pull tabs, disconnect the keyboard cable and keyboard-backlight cable from the system board.

 **NOTE:** The keyboard-backlight cable is present only if the laptop shipped with a backlit-keyboard.

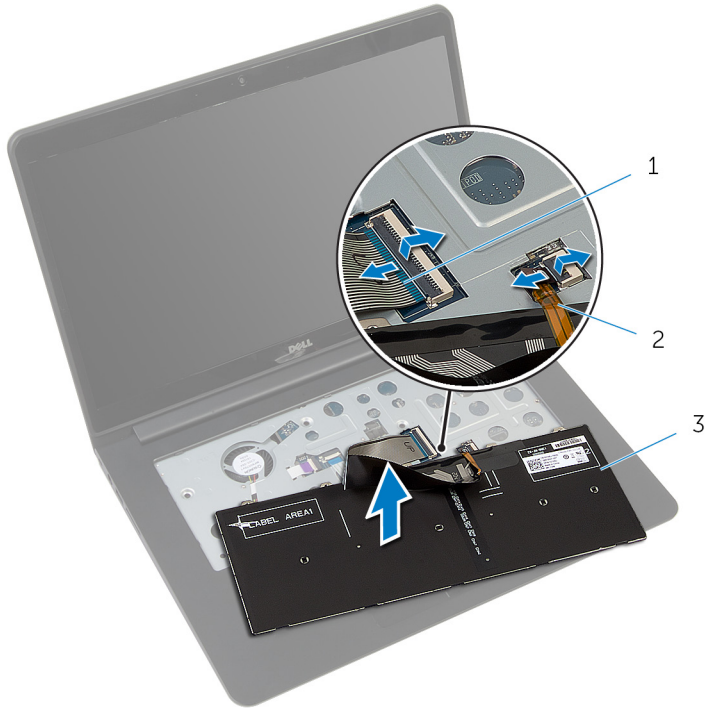

1 keyboard cable

2 keyboard-backlight cable

3 keyboard

Replacing the Keyboard

 **WARNING:** Before working inside your computer, read the safety information that shipped with your computer and follow the steps in [Before Working Inside Your Computer](#). After working inside your computer, follow the instructions in [After Working Inside Your Computer](#). For more safety best practices, see the Regulatory Compliance home page at dell.com/regulatory_compliance.

Procedure

 **NOTE:** If you are installing a new keyboard, fold the cables the same way they are folded on the old keyboard. For more information, see "[Folding the Keyboard Cables](#)".

- 1 Slide the keyboard cable and keyboard-backlight cable in their respective connectors and press down on the latches to secure the cables.
- 2 Turn the keyboard over and place it on the palm rest.
- 3 Slide the tabs on the keyboard into the slots on the palm rest and snap the keyboard into place.

Post-requisites

- 1 Replace the [battery](#).
- 2 Replace the [base cover](#).

Folding the Keyboard Cables

 **CAUTION:** Do not apply excess pressure while folding the cables.

The cables on the keyboard are not folded when you receive a replacement keyboard. Follow these instructions to fold the cables on the replacement keyboard the same way they are folded on the old keyboard.



NOTE: Keyboard-backlight cable is present only on a backlit-keyboard.

- 1 Place the keyboard on a flat and clean surface.

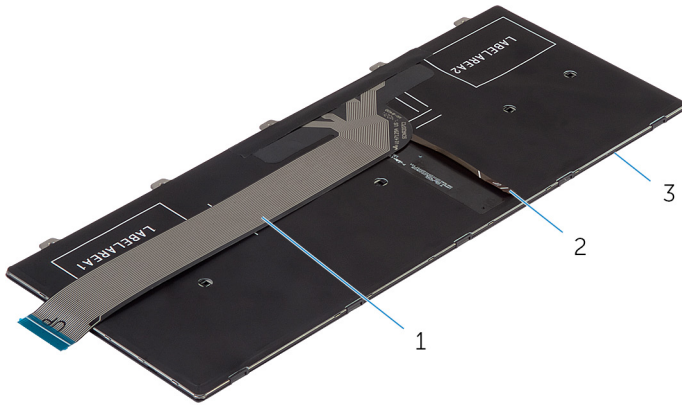

1 keyboard cable

2 keyboard-backlight cable

3 keyboard

2 Lift the keyboard cable and gently fold the keyboard-backlight cable at the fold line.

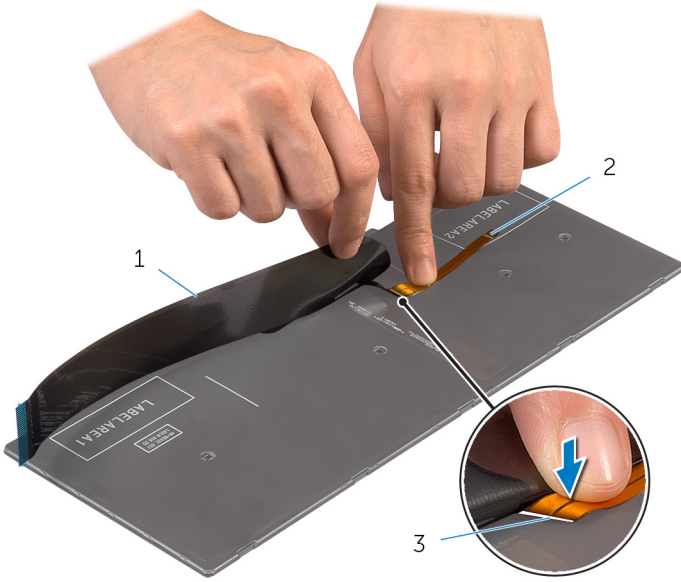

- 1 keyboard cable
- 3 fold line

- 2 keyboard-backlight cable

3 Using the alignment line, gently fold the keyboard cable.

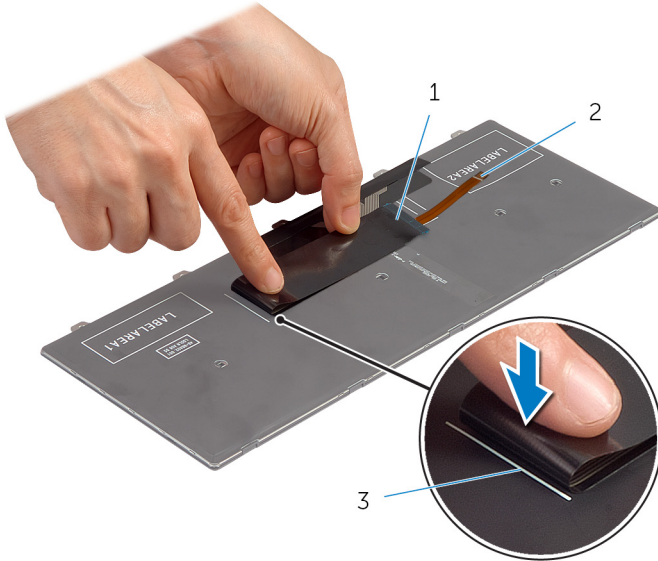

- 1 keyboard cable
- 3 alignment line

2 keyboard-backlight cable

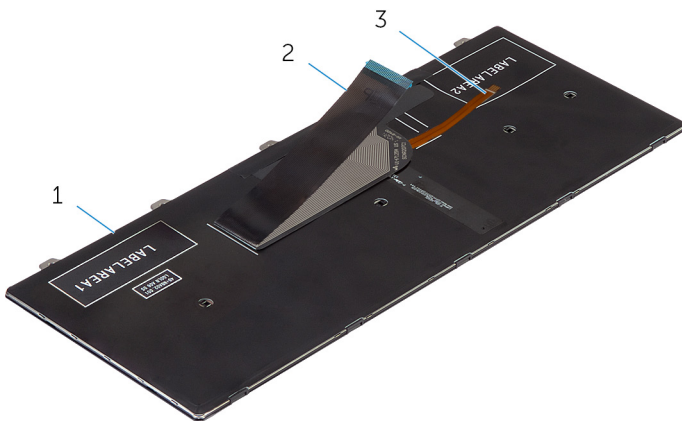

1 keyboard

2 keyboard cable

3 keyboard-backlight cable

Removing the Base Frame



WARNING: Before working inside your computer, read the safety information that shipped with your computer and follow the steps in [Before Working Inside Your Computer](#). After working inside your computer, follow the instructions in [After Working Inside Your Computer](#). For more safety best practices, see the Regulatory Compliance home page at dell.com/regulatory_compliance.

Prerequisites

- 1 Remove the [base cover](#).
- 2 Remove the [battery](#).
- 3 Remove the [hard drive](#).
- 4 Remove the [fan](#).
- 5 Remove the [keyboard](#).

Procedure

- 1 Remove the screws that secure the base frame to the palm rest.

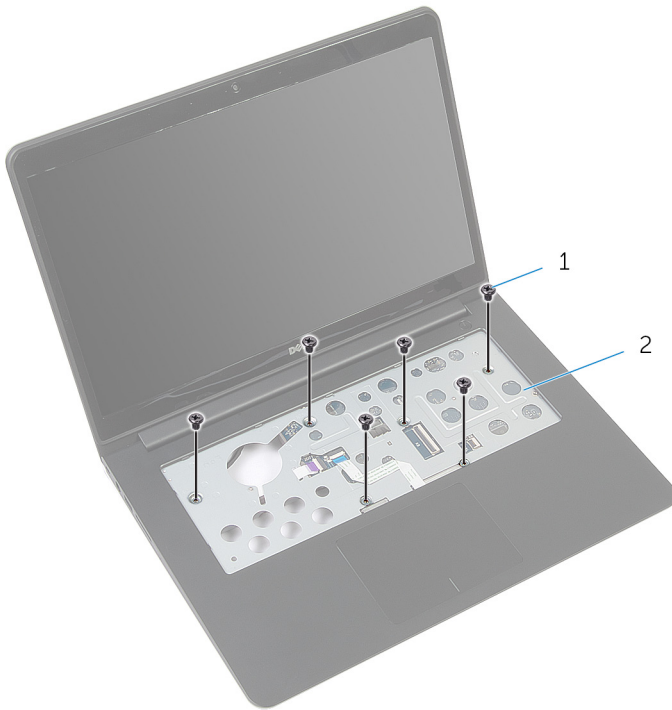

1 screws (6)

2 palm rest

- 2 Close the display and turn the computer over.

- 3 Remove the screws that secure the base frame to the palm rest.

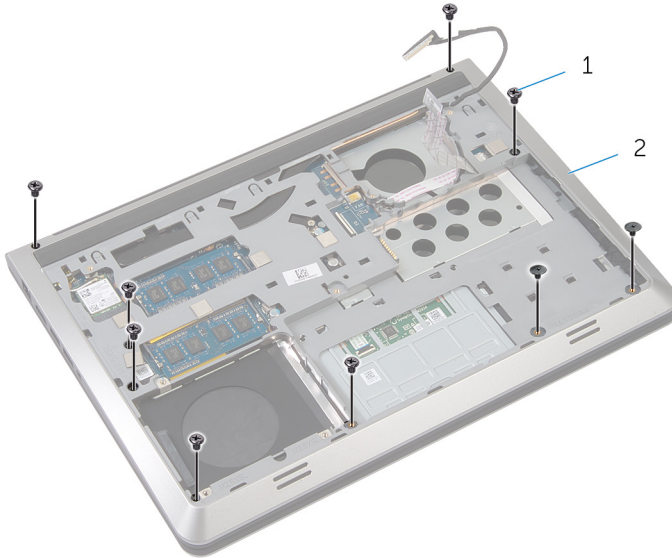

1 screws (9)

2 base frame

- 4 Using a plastic scribe, pry up the base frame.
- 5 Lift the base frame slightly from the top edge and slide it upward to release it from the tabs of the palm rest.

- 6 Lift the base frame off the palm rest and slide the display cable and I/O-board cable through the base frame.

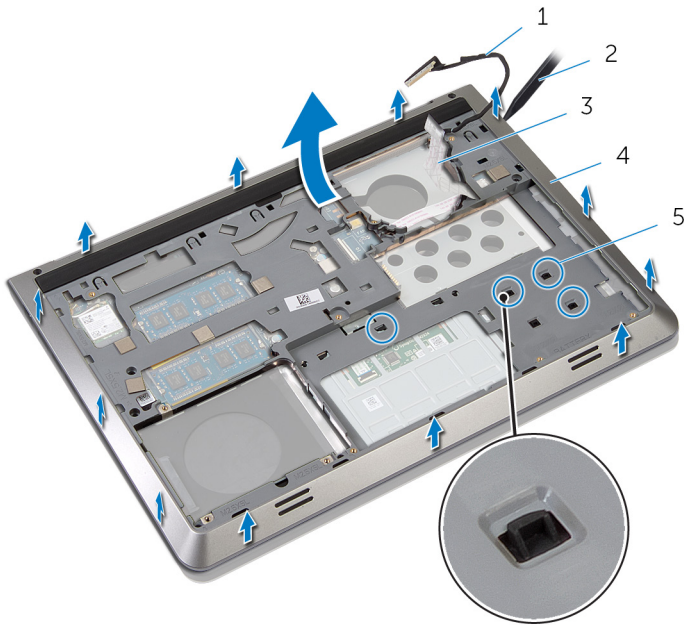

- | | | | |
|---|-----------------|---|----------------|
| 1 | display cable | 2 | plastic scribe |
| 3 | I/O-board cable | 4 | base frame |
| 5 | tabs | | |

Replacing the Base Frame



WARNING: Before working inside your computer, read the safety information that shipped with your computer and follow the steps in [Before Working Inside Your Computer](#). After working inside your computer, follow the instructions in [After Working Inside Your Computer](#). For more safety best practices, see the Regulatory Compliance home page at dell.com/regulatory_compliance.



Procedure

- 1 Route the display cable and I/O-board cable through the slots on the base frame.
- 2 Slide the base frame under the tabs on the palm rest.
- 3 Press the base frame down along the edges to snap it into place.
- 4 Replace the screws that secure the base frame to the palm rest.
- 5 Turn the computer over and open the display.
- 6 Replace the screws that secure the base frame to the palm rest.

Post-requisites

- 1 Replace the [keyboard](#).
- 2 Replace the [fan](#).
- 3 Replace the [hard drive](#).
- 4 Replace the [battery](#).
- 5 Replace the [base cover](#).

Removing the Heat Sink

-  **WARNING:** Before working inside your computer, read the safety information that shipped with your computer and follow the steps in [Before Working Inside Your Computer](#). After working inside your computer, follow the instructions in [After Working Inside Your Computer](#). For more safety best practices, see the Regulatory Compliance home page at dell.com/regulatory_compliance.
-  **WARNING:** The heat sink may become hot during normal operation. Allow sufficient time for the heat sink to cool before you touch it.
-  **CAUTION:** To ensure maximum cooling for the processor, do not touch the heat transfer areas on the heat sink. The oils in your skin can reduce the heat transfer capability of the thermal grease.

Prerequisites

- 1 Remove the [base cover](#).
- 2 Remove the [battery](#).
- 3 Remove the [hard drive](#).
- 4 Remove the [fan](#).
- 5 Remove the [keyboard](#).
- 6 Remove the [base frame](#).

Procedure

-  **NOTE:** The image shows a heat sink on a laptop shipped with discrete graphics card. The heat sink shipped on a laptop with integrated graphics card has only four screws.
- 1 In sequential order (as indicated on the heat sink), remove the screws that secure the heat sink to the system board.

2 Lift the heat sink off the system board.

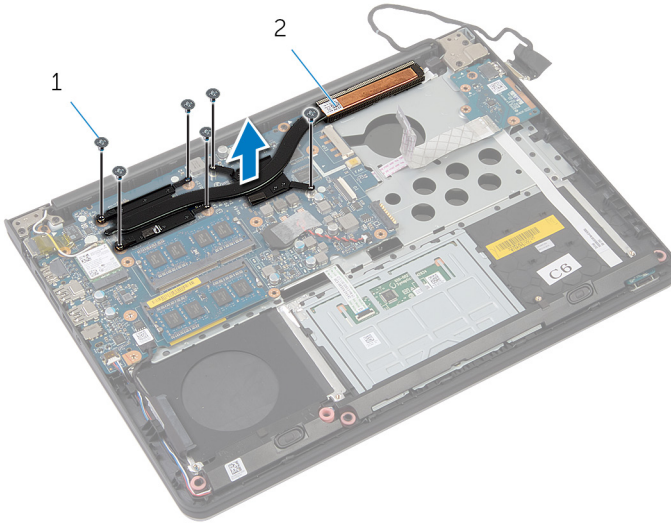

1 screws (6)

2 heat sink

Replacing the Heat Sink



WARNING: Before working inside your computer, read the safety information that shipped with your computer and follow the steps in [Before Working Inside Your Computer](#). After working inside your computer, follow the instructions in [After Working Inside Your Computer](#). For more safety best practices, see the Regulatory Compliance home page at dell.com/regulatory_compliance.



CAUTION: Incorrect alignment of the heat sink can cause damage to the system board and processor.



NOTE: The original thermal grease can be reused if the original system board and fan are reinstalled together. If either the system board or the fan is replaced, use the thermal pad provided in the kit to make sure that thermal conductivity is achieved.

Procedure

- 1 Align the screw holes on the heat sink with the screw holes on the system board.
- 2 In sequential order (as indicated on the heat sink), replace the screws that secure the heat sink to the system board.

Post-requisites

- 1 Replace the [base frame](#).
- 2 Replace the [keyboard](#).
- 3 Replace the [fan](#).
- 4 Replace the [hard drive](#).
- 5 Replace the [battery](#).
- 6 Replace the [base cover](#).

Removing the Coin-Cell Battery

 **WARNING:** Before working inside your computer, read the safety information that shipped with your computer and follow the steps in [Before Working Inside Your Computer](#). After working inside your computer, follow the instructions in [After Working Inside Your Computer](#). For more safety best practices, see the Regulatory Compliance home page at dell.com/regulatory_compliance.

 **CAUTION:** Removing the coin-cell battery resets the BIOS settings to default. It is recommended that you note the BIOS settings before removing the coin-cell battery.

Prerequisites

- 1 Remove the [base cover](#).
- 2 Remove the [battery](#).
- 3 Remove the [hard drive](#).
- 4 Remove the [fan](#).
- 5 Remove the [keyboard](#).
- 6 Remove the [base frame](#).

Procedure

- 1 Disconnect the coin-cell battery cable from the system board.

2 Peel off the coin-cell battery from the system board.

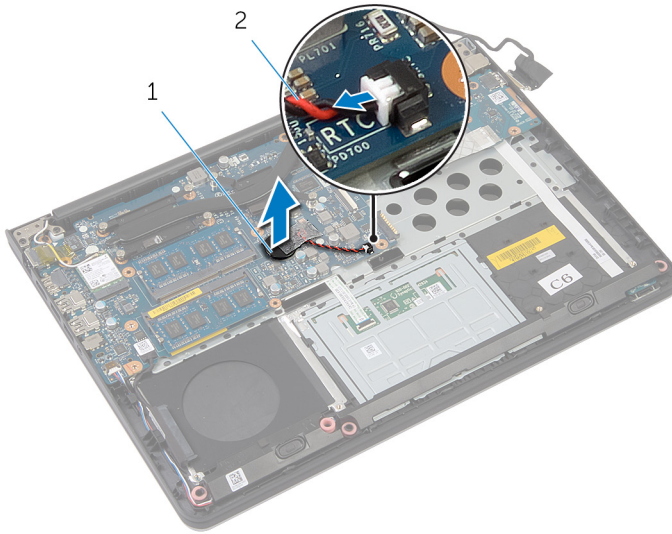

1 coin-cell battery

2 coin-cell battery cable

Replacing the Coin-Cell Battery

 **WARNING:** Before working inside your computer, read the safety information that shipped with your computer and follow the steps in [Before Working Inside Your Computer](#). After working inside your computer, follow the instructions in [After Working Inside Your Computer](#). For more safety best practices, see the Regulatory Compliance home page at dell.com/regulatory_compliance.

Procedure

- 1 Adhere the coin-cell battery to the system board.
- 2 Connect the coin-cell battery cable to the system board.

Post-requisites

- 1 Replace the [base frame](#).
- 2 Replace the [keyboard](#).
- 3 Replace the [fan](#).
- 4 Replace the [hard drive](#).
- 5 Replace the [battery](#).
- 6 Replace the [base cover](#).

Removing the Speakers



WARNING: Before working inside your computer, read the safety information that shipped with your computer and follow the steps in [Before Working Inside Your Computer](#). After working inside your computer, follow the instructions in [After Working Inside Your Computer](#). For more safety best practices, see the Regulatory Compliance home page at dell.com/regulatory_compliance.

Prerequisites

- 1 Remove the [base cover](#).
- 2 Remove the [battery](#).
- 3 Remove the [hard drive](#).
- 4 Remove the [fan](#).
- 5 Remove the [keyboard](#).
- 6 Remove the [base frame](#).

Procedure

- 1 Disconnect the speaker cable from the system board.
- 2 Note the speaker-cable routing and remove the cable from the routing guides.

- 3** Release the speakers from the alignment posts and lift the speakers, along with the speaker cable, off the palm rest.

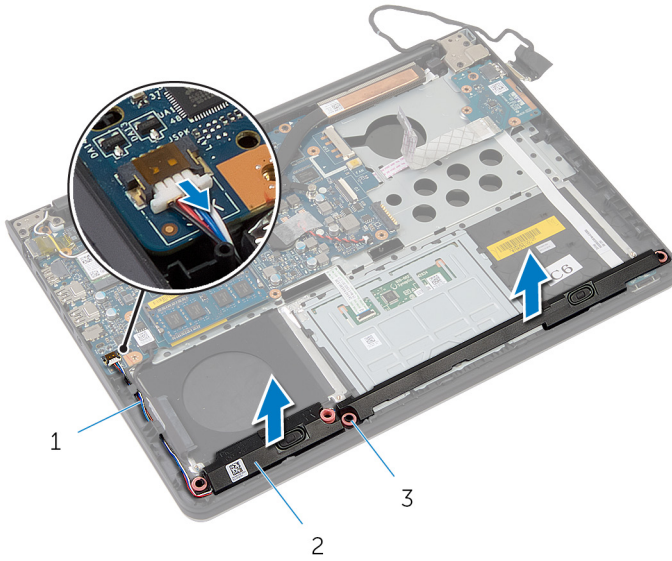

- | | | | |
|---|---------------------|---|--------------|
| 1 | speaker cable | 2 | speakers (2) |
| 3 | alignment posts (4) | | |

Replacing the Speakers



WARNING: Before working inside your computer, read the safety information that shipped with your computer and follow the steps in [Before Working Inside Your Computer](#). After working inside your computer, follow the instructions in [After Working Inside Your Computer](#). For more safety best practices, see the Regulatory Compliance home page at dell.com/regulatory_compliance.

Procedure

- 1 Using the alignment posts, place the speakers on the palm rest.
- 2 Route the speaker cable through the routing guides on the palm rest.
- 3 Connect the speaker cable to the system board.

Post-requisites

- 1 Replace the [base frame](#).
- 2 Replace the [keyboard](#).
- 3 Replace the [fan](#).
- 4 Replace the [hard drive](#).
- 5 Replace the [battery](#).
- 6 Replace the [base cover](#).

Removing the I/O Board



WARNING: Before working inside your computer, read the safety information that shipped with your computer and follow the steps in [Before Working Inside Your Computer](#). After working inside your computer, follow the instructions in [After Working Inside Your Computer](#). For more safety best practices, see the Regulatory Compliance home page at dell.com/regulatory_compliance.

Prerequisites

- 1 Remove the [base cover](#).
- 2 Remove the [battery](#).
- 3 Remove the [hard drive](#).
- 4 Remove the [fan](#).
- 5 Remove the [keyboard](#).
- 6 Remove the [base frame](#).

Procedure

- 1 Remove the screw that secures the I/O board to the palm rest.

2 Lift the I/O board off the palm rest.

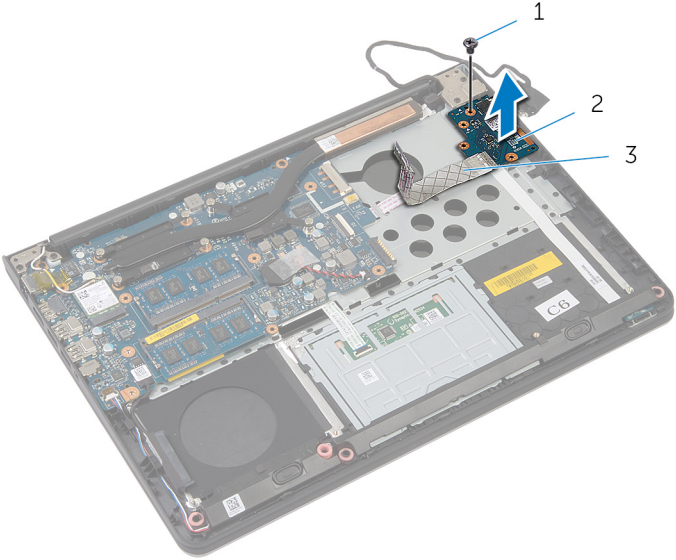

1 screw

2 I/O board

3 I/O-board cable

Replacing the I/O Board



WARNING: Before working inside your computer, read the safety information that shipped with your computer and follow the steps in [Before Working Inside Your Computer](#). After working inside your computer, follow the instructions in [After Working Inside Your Computer](#). For more safety best practices, see the Regulatory Compliance home page at dell.com/regulatory_compliance.

Procedure

- 1 Align the screw hole on the I/O board with the screw hole on the palm rest.
- 2 Replace the screw that secures the I/O board to the palm rest.

Post-requisites

- 1 Replace the [base frame](#).
- 2 Replace the [keyboard](#).
- 3 Replace the [fan](#).
- 4 Replace the [hard drive](#).
- 5 Replace the [battery](#).
- 6 Replace the [base cover](#).

Removing the Status-Light Board



WARNING: Before working inside your computer, read the safety information that shipped with your computer and follow the steps in [Before Working Inside Your Computer](#). After working inside your computer, follow the instructions in [After Working Inside Your Computer](#). For more safety best practices, see the Regulatory Compliance home page at dell.com/regulatory_compliance.

Prerequisites

- 1 Remove the [base cover](#).
- 2 Remove the [battery](#).
- 3 Remove the [hard drive](#).
- 4 Remove the [fan](#).
- 5 Remove the [keyboard](#).
- 6 Remove the [base frame](#).
- 7 Remove the [I/O board](#).

Procedure

- 1 Turn the computer over and open the display.
- 2 Lift the latch and disconnect the status-light board cable from the system board.

- 3 Slide the status-light board cable out through the slot on the palm rest.

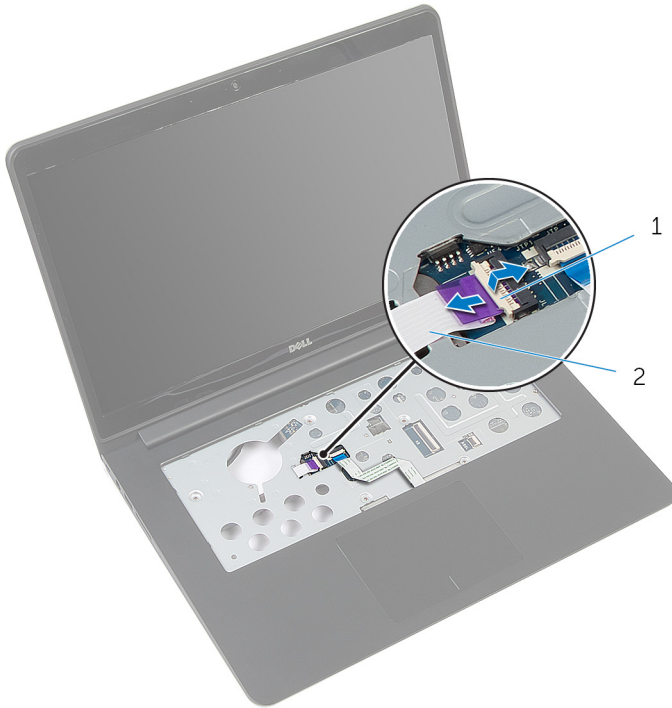

1 latch

2 status-light board cable

- 4 Close the display and turn the computer over.

- 5 Lift the left speaker and move it away from the status-light board.

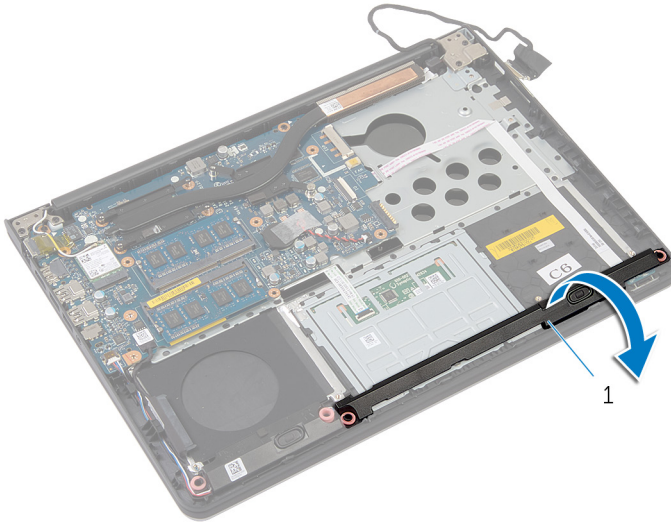

1 left speaker

- 6 Remove the screw that secures the status-light board to the palm rest.

7 Lift the status-light board and peel off the status-light board cable from the palm rest.

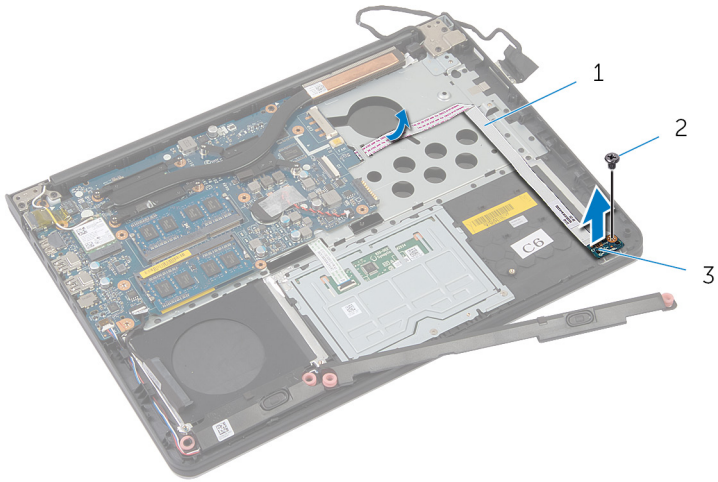

- 1 status-light board cable
- 2 screw
- 3 status-light board

Replacing the Status-Light Board



WARNING: Before working inside your computer, read the safety information that shipped with your computer and follow the steps in [Before Working Inside Your Computer](#). After working inside your computer, follow the instructions in [After Working Inside Your Computer](#). For more safety best practices, see the Regulatory Compliance home page at dell.com/regulatory_compliance.

Procedure

- 1 Align the screw hole on the status-light board with the screw hole on the palm rest.
- 2 Replace the screw that secures the status-light board to the palm rest.
- 3 Using the alignment posts, place the left speaker on the palm rest.
- 4 Adhere the status-light board cable to the palm rest and slide the cable through the slot on the palm rest.
- 5 Turn the computer over and open the display.
- 6 Slide the status-light board cable in the connector and press down on the latch to secure the cable.

Post-requisites

- 1 Replace the [I/O board](#).
- 2 Replace the [base frame](#).
- 3 Replace the [keyboard](#).
- 4 Replace the [fan](#).
- 5 Replace the [hard drive](#).
- 6 Replace the [battery](#).
- 7 Replace the [base cover](#).

Removing the System Board



WARNING: Before working inside your computer, read the safety information that shipped with your computer and follow the steps in [Before Working Inside Your Computer](#). After working inside your computer, follow the instructions in [After Working Inside Your Computer](#). For more safety best practices, see the Regulatory Compliance home page at dell.com/regulatory_compliance.



NOTE: Your computer's Service Tag is stored in the system board. You must enter the Service Tag in the System Setup after you replace the system board.



NOTE: Replacing the system board removes any changes you have made to the BIOS using System Setup. You must make the desired changes again after you replace the system board.



NOTE: Before disconnecting the cables from the system board, note the location of the connectors so that you can reconnect them correctly after you replace the system board.

Prerequisites

- 1 Remove the [base cover](#).
- 2 Remove the [battery](#).
- 3 Remove the [hard drive](#).
- 4 Remove the [fan](#).
- 5 Remove the [keyboard](#).
- 6 Remove the [base frame](#).
- 7 Remove the [memory module\(s\)](#).
- 8 Remove the [wireless card](#).
- 9 Remove the [heat sink](#).

Procedure

- 1 Turn the computer over and open the display.

-
- 2** Lift the latches and disconnect the status-light board cable and touchpad cable from the system board.



1 status-light board cable

2 touchpad cable

-
-
- 3** Close the display panel and turn the computer over.
- 4** Remove the screws that secure the system board to the palm rest.
- 5** Disconnect the speaker cable and hard-drive cable from the system board.

6 Lift the hard-drive cable away from the computer base.

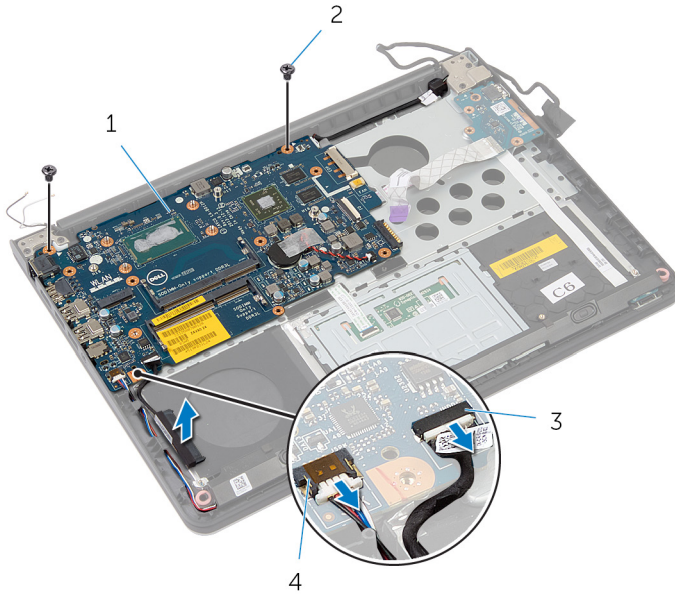

1 system board

2 screws (2)

3 hard-drive cable

4 speaker cable

7 Carefully lift the system board from the inner edge and release the ports from the slots on the palm rest.

8 Turn the system board over.

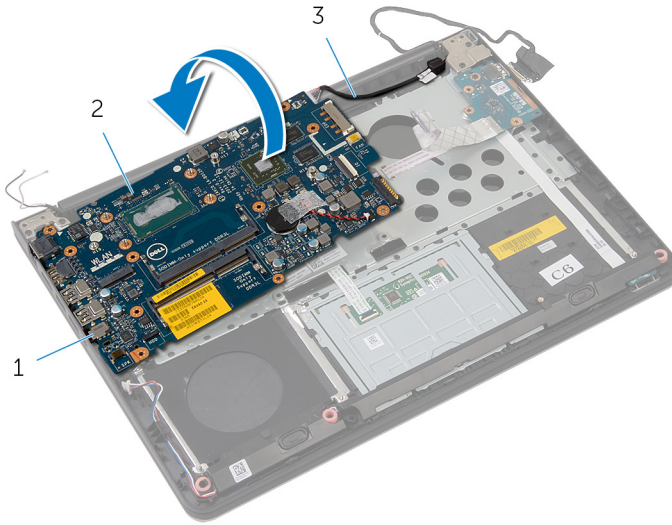

1 ports

2 system board

3 power-adaptor port cable

9 Disconnect the power-adaptor port cable from the system board.

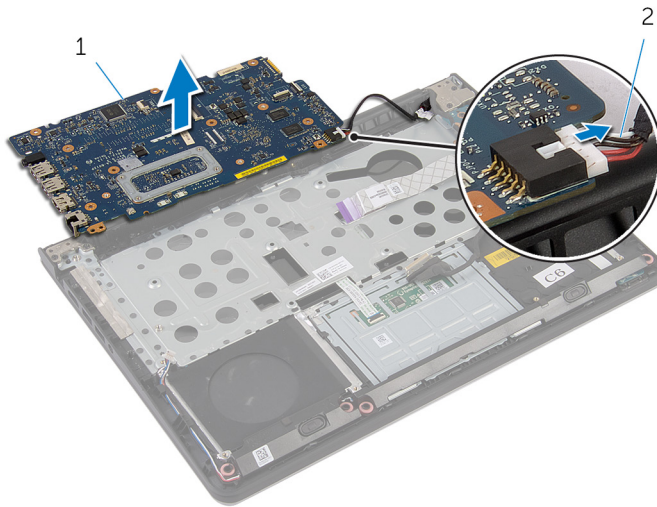

1 system board

2 power-adaptor port cable

Replacing the System Board



WARNING: Before working inside your computer, read the safety information that shipped with your computer and follow the steps in [Before Working Inside Your Computer](#). After working inside your computer, follow the instructions in [After Working Inside Your Computer](#). For more safety best practices, see the Regulatory Compliance home page at dell.com/regulatory_compliance.



NOTE: Your computer's Service Tag is stored in the system board. You must enter the Service Tag in the System Setup after you replace the system board.

Procedure

- 1 Connect the power-adapter port cable to the system board.
- 2 Turn the system board over.
- 3 Slide the ports on the system board into the slots on the palm rest and place the system board on the palm rest.
- 4 Align the screw holes on the system board with the screw holes on the palm rest.
- 5 Replace the screws that secure the system board to the palm rest.
- 6 Connect the hard-drive cable and speaker cable to the system board.
- 7 Turn the computer over and open the display.
- 8 Slide the status-light board cable and touchpad cable into the respective connectors and press down on the latches to secure the cables.

Post-requisites

- 1 Replace the [heat sink](#).
- 2 Replace the [wireless card](#).
- 3 Replace the [memory module\(s\)](#).
- 4 Replace the [base frame](#).
- 5 Replace the [keyboard](#).
- 6 Replace the [fan](#).
- 7 Replace the [hard drive](#).
- 8 Replace the [battery](#).
- 9 Replace the [base cover](#).

Removing the Display Assembly



WARNING: Before working inside your computer, read the safety information that shipped with your computer and follow the steps in [Before Working Inside Your Computer](#). After working inside your computer, follow the instructions in [After Working Inside Your Computer](#). For more safety best practices, see the Regulatory Compliance home page at dell.com/regulatory_compliance.

Prerequisites

- 1 Remove the [base cover](#).
- 2 Remove the [battery](#).
- 3 Remove the [hard drive](#).
- 4 Remove the [fan](#).
- 5 Remove the [keyboard](#).
- 6 Remove the [base frame](#).

Procedure

- 1 Disconnect the antenna cables from the wireless card.



1 antenna cables (2)

2 wireless card

- 2 Open the display to an angle of 90 degrees.
- 3 Place the computer on the edge of the table so that the palm rest is on the table and the display assembly extends past the table edge with the display hinges facing up.
- 4 Remove the screws that secure the display hinges to the palm rest.

5 Lift the display assembly off the palm rest.

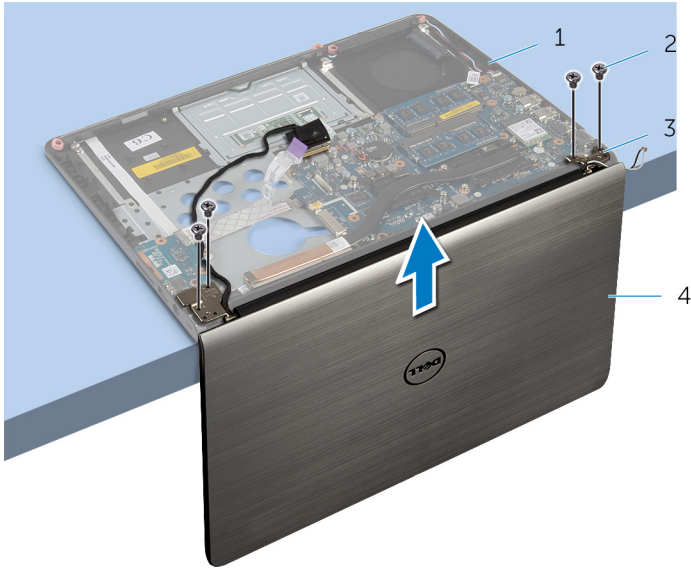

1 palm-rest assembly

2 screws (4)

3 display hinges (2)

4 display assembly



Replacing the Display Assembly



WARNING: Before working inside your computer, read the safety information that shipped with your computer and follow the steps in [Before Working Inside Your Computer](#). After working inside your computer, follow the instructions in [After Working Inside Your Computer](#). For more safety best practices, see the Regulatory Compliance home page at dell.com/regulatory_compliance.

Procedure

- 1 Place the palm rest at the edge of the table with the speakers facing away from the edge.
- 2 Align the screw holes on the display hinges with the screw holes on the palm rest.
- 3 Replace the screws that secure the display hinges to the palm rest.
- 4 Close the display and turn the computer over.

5 Route the antenna cables avoiding the chip and the white circle.

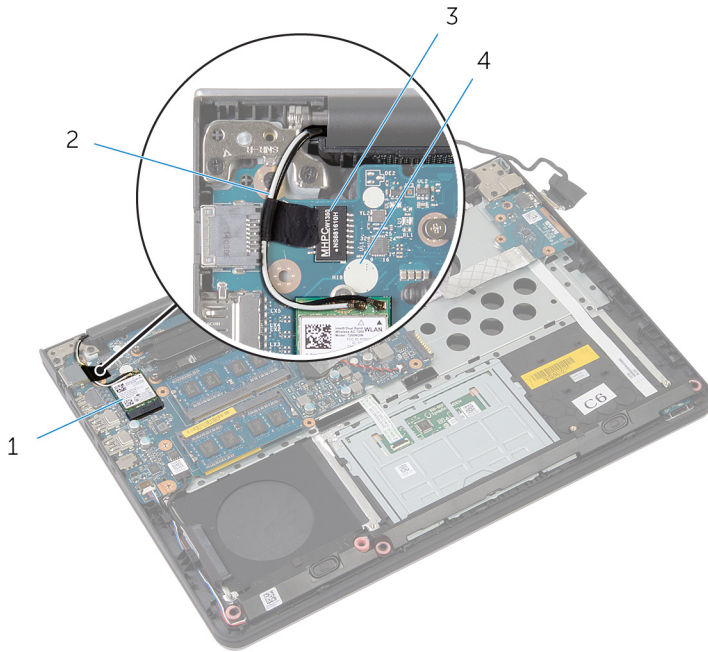

1 wireless card

2 antenna cables (2)

3 chip

4 white circle

6 Connect the antenna cables to the wireless card.

Post-requisites

1 Replace the [base frame](#).

2 Replace the [keyboard](#).

3 Replace the [fan](#).

4 Replace the [hard drive](#).

5 Replace the [battery](#).

6 Replace the [base cover](#).

Removing the Power-Adapter Port



WARNING: Before working inside your computer, read the safety information that shipped with your computer and follow the steps in [Before Working Inside Your Computer](#). After working inside your computer, follow the instructions in [After Working Inside Your Computer](#). For more safety best practices, see the Regulatory Compliance home page at dell.com/regulatory_compliance.

Prerequisites

- 1 Remove the [base cover](#).
- 2 Remove the [battery](#).
- 3 Remove the [hard drive](#).
- 4 Remove the [fan](#).
- 5 Remove the [keyboard](#).
- 6 Remove the [base frame](#).
- 7 Remove the [heat sink](#).
- 8 Remove the [display assembly](#).

Procedure

- 1 Turn the computer over.

- 2 Lift the latches and disconnect the status-light board cable and touchpad cable from the system board.



1 status-light board cable

2 touchpad cable

- 3 Turn the computer over.
- 4 Disconnect the speaker cable from the system board.

9 Note the power-adapter port cable routing and lift the power-adapter port, along with its cable, off the palm rest.

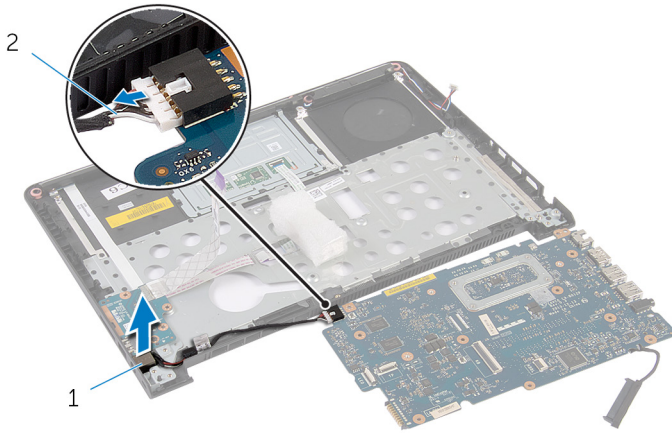

1 power-adapter port

2 power-adapter port cable

Replacing the Power-Adapter Port



WARNING: Before working inside your computer, read the safety information that shipped with your computer and follow the steps in [Before Working Inside Your Computer](#). After working inside your computer, follow the instructions in [After Working Inside Your Computer](#). For more safety best practices, see the Regulatory Compliance home page at dell.com/regulatory_compliance.

Procedure

- 1 Connect the power-adapter port cable to the system board.
- 2 Turn the system board over.
- 3 Route the power-adapter port cable through the routing guides on the palm rest.
- 4 Slide the ports on the system board into the slots on the palm rest and place the system board on the palm rest.
- 5 Align the screw holes on the system board with the screw holes on the palm rest.
- 6 Replace the screws that secure the system board to the palm rest.
- 7 Connect the speaker cable to the system board.
- 8 Turn the computer over.
- 9 Slide the status-light board cable and touchpad cable into the respective connectors and press down on the latches to secure the cables.

Post-requisites

- 1 Replace the [display assembly](#).
- 2 Replace the [heat sink](#).
- 3 Replace the [base frame](#).
- 4 Replace the [keyboard](#).
- 5 Replace the [fan](#).
- 6 Replace the [hard drive](#).
- 7 Replace the [battery](#).
- 8 Replace the [base cover](#).

Removing the Palm Rest



WARNING: Before working inside your computer, read the safety information that shipped with your computer and follow the steps in [Before Working Inside Your Computer](#). After working inside your computer, follow the instructions in [After Working Inside Your Computer](#). For more safety best practices, see the Regulatory Compliance home page at dell.com/regulatory_compliance.

Prerequisites

- 1 Remove the [base cover](#).
- 2 Remove the [battery](#).
- 3 Remove the [hard drive](#).
- 4 Remove the [fan](#).
- 5 Remove the [keyboard](#).
- 6 Remove the [base frame](#).
- 7 Remove the [speakers](#).
- 8 Remove the [I/O board](#).
- 9 Remove the [status light board](#).
- 10 Remove the [display assembly](#).

Procedure

- 1 Remove the screws that secure the system board to the palm rest.
- 2 Remove the power-adaptor port from its slot on the palm rest.

3 Lift the system board along with the power-adaptor port and release the ports from the slots on the palm rest.

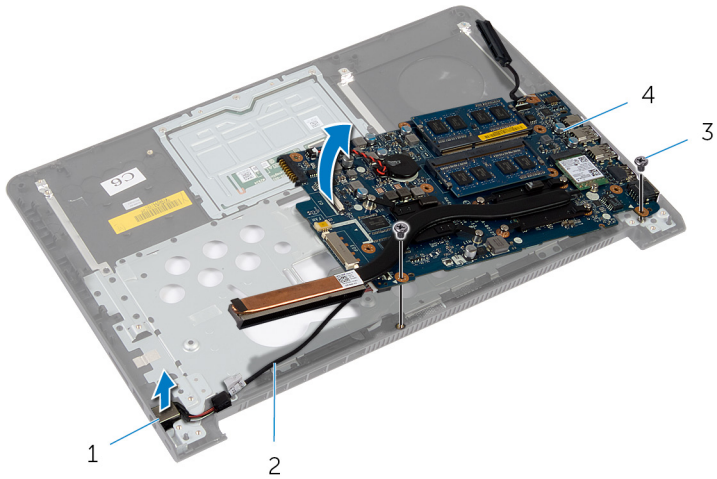

1 power-adaptor port

2 power-adaptor port cable

3 screws (2)

4 system board



1 palm rest

Replacing the Palm Rest



WARNING: Before working inside your computer, read the safety information that shipped with your computer and follow the steps in [Before Working Inside Your Computer](#). After working inside your computer, follow the instructions in [After Working Inside Your Computer](#). For more safety best practices, see the Regulatory Compliance home page at dell.com/regulatory_compliance.

Procedure

- 1 Slide the ports on the system board into the slots on the palm rest and place the system board on the palm rest.
- 2 Slide the power-adaptor port into the slot on the palm rest.
- 3 Replace the screws that secure the system board to the palm rest.

Post-requisites

- 1 Replace the [display assembly](#).
- 2 Replace the [status light board](#).
- 3 Replace the [I/O board](#).
- 4 Replace the [speakers](#).
- 5 Replace the [base frame](#).
- 6 Replace the [keyboard](#).
- 7 Replace the [fan](#).
- 8 Replace the [hard drive](#).
- 9 Replace the [battery](#).
- 10 Replace the [base cover](#).

Flashing the BIOS

You may need to flash (update) the BIOS when an update is available or when you replace the system board. To flash the BIOS:

- 1 Turn on the computer.
- 2 Go to **dell.com/support**.
- 3 If you have your computer's Service Tag, type your computer's Service Tag and click **Submit**.
If you do not have your computer's Service Tag, click **Detect My Product** to allow automatic detection of the Service Tag.
 **NOTE:** If the Service Tag cannot be detected automatically, select your product under the product categories.
- 4 Click **Get Drivers and Downloads**.
- 5 Click **View All Drivers**.
- 6 In the **Operating System** drop-down, select the operating system installed on your computer.
- 7 Click **BIOS**.
- 8 Click **Download File** to download the latest version of the BIOS for your computer.
- 9 On the next page, select **Single-file download** and click **Continue**.
- 10 Save the file and once the download is complete, navigate to the folder where you saved the BIOS update file.
- 11 Double-click the BIOS update file icon and follow the instructions on the screen.