

# Inspiron 14

## 3000 Series

# Owner's Manual

Computer Model: Inspiron 14-3442  
Regulatory Model: P53G  
Regulatory Type: P53G001



# Notes, Cautions, and Warnings

---



**NOTE:** A NOTE indicates important information that helps you make better use of your computer.



**CAUTION:** A CAUTION indicates either potential damage to hardware or loss of data and tells you how to avoid the problem.



**WARNING:** A WARNING indicates a potential for property damage, personal injury, or death.

---

**Copyright © 2014 Dell Inc. All rights reserved.** This product is protected by U.S. and international copyright and intellectual property laws. Dell™ and the Dell logo are trademarks of Dell Inc. in the United States and/or other jurisdictions. All other marks and names mentioned herein may be trademarks of their respective companies.

2014 - 04

Rev. A00

# Contents

<b>Before Working Inside Your Computer.....</b>	<b>9</b>
Before You Begin .....	9
Safety Instructions.....	9
Recommended Tools.....	10
<b>After Working Inside Your Computer.....</b>	<b>11</b>
<b>Removing the Battery.....</b>	<b>12</b>
Procedure.....	12
<b>Replacing the Battery.....</b>	<b>13</b>
Procedure.....	13
<b>Removing the Optical Drive.....</b>	<b>14</b>
Prerequisites.....	14
Procedure.....	14
<b>Replacing the Optical Drive.....</b>	<b>16</b>
Procedure.....	16
Post-requisites.....	16
<b>Removing the Base Cover.....</b>	<b>17</b>
Prerequisites.....	17
Procedure.....	17
<b>Replacing the Base Cover.....</b>	<b>18</b>
Procedure.....	18
Post-requisites.....	18

<b>Removing the Memory Module(s)</b> .....	<b>19</b>
Prerequisites.....	19
Procedure.....	20
<b>Replacing the Memory Module(s)</b> .....	<b>21</b>
Procedure.....	22
Post-requisites.....	22
<b>Removing the Wireless Card</b> .....	<b>23</b>
Prerequisites.....	23
Procedure.....	23
<b>Replacing the Wireless Card</b> .....	<b>25</b>
Procedure.....	25
Post-requisites.....	25
<b>Removing the Keyboard</b> .....	<b>26</b>
Prerequisites.....	26
Procedure.....	26
<b>Replacing the Keyboard</b> .....	<b>29</b>
Procedure.....	29
Post-requisites.....	29
Folding the Keyboard Cable.....	29
<b>Removing the Hard Drive</b> .....	<b>32</b>
Prerequisites.....	32
Procedure.....	32
<b>Replacing the Hard Drive</b> .....	<b>35</b>
Procedure.....	35
Post-requisites.....	35

<b>Removing the Palm Rest</b> .....	<b>36</b>
Prerequisites.....	36
Procedure.....	37
<b>Replacing the Palm Rest</b> .....	<b>41</b>
Procedure.....	41
Post-requisites.....	41
<b>Removing the Power-Button Board</b> .....	<b>42</b>
Prerequisites.....	42
Procedure.....	42
<b>Replacing the Power-Button Board</b> .....	<b>44</b>
Procedure.....	44
Post-requisites.....	44
<b>Removing the Touchpad</b> .....	<b>45</b>
Prerequisites.....	45
Procedure.....	45
<b>Replacing the Touchpad</b> .....	<b>47</b>
Procedure.....	47
Post-requisites.....	47
<b>Removing the I/O Board</b> .....	<b>49</b>
Prerequisites.....	49
Procedure.....	49
<b>Replacing the I/O Board</b> .....	<b>51</b>
Procedure.....	51
Post-requisites.....	51

<b>Removing the Speakers.....</b>	<b>52</b>
Prerequisites.....	52
Procedure.....	52
<b>Replacing the Speakers.....</b>	<b>54</b>
Procedure.....	54
Post-requisites.....	54
<b>Removing the Coin-Cell Battery.....</b>	<b>55</b>
Prerequisites.....	55
Procedure.....	55
<b>Replacing the Coin-Cell Battery.....</b>	<b>57</b>
Procedure.....	57
Post-requisites.....	57
<b>Removing the Power-Adapter Port.....</b>	<b>58</b>
Prerequisites.....	58
Procedure.....	58
<b>Replacing the Power-Adapter Port.....</b>	<b>60</b>
Procedure.....	60
Post-requisites.....	60
<b>Removing the System Board.....</b>	<b>61</b>
Prerequisites.....	61
Procedure.....	61
<b>Replacing the System Board.....</b>	<b>64</b>
Procedure.....	64
Post-requisites.....	64

<b>Removing the Heat-Sink Assembly.....</b>	<b>65</b>
Prerequisites.....	65
Procedure.....	65
<b>Replacing the Heat-Sink Assembly.....</b>	<b>67</b>
Procedure.....	67
Post-requisites.....	67
<b>Removing the Display Assembly.....</b>	<b>68</b>
Prerequisites.....	68
Procedure.....	68
<b>Replacing the Display Assembly.....</b>	<b>70</b>
Procedure.....	70
Post-requisites.....	70
<b>Removing the Display Bezel.....</b>	<b>71</b>
Prerequisites.....	71
Procedure.....	72
<b>Replacing the Display Bezel.....</b>	<b>73</b>
Procedure.....	73
Post-requisites.....	73
<b>Removing the Display Hinges.....</b>	<b>74</b>
Prerequisites.....	74
Procedure.....	75
<b>Replacing the Display Hinges.....</b>	<b>76</b>
Procedure.....	76
Post-requisites.....	76

<b>Removing the Display Panel</b> .....	<b>77</b>
Prerequisites.....	77
Procedure.....	78
<b>Replacing the Display Panel</b> .....	<b>80</b>
Procedure.....	80
Post-requisites.....	80
<b>Removing the Camera</b> .....	<b>81</b>
Prerequisites.....	81
Procedure.....	82
<b>Replacing the Camera</b> .....	<b>83</b>
Procedure.....	83
Post-requisites.....	83
<b>Flashing the BIOS</b> .....	<b>84</b>





# Before Working Inside Your Computer

---

 **CAUTION:** To avoid damaging the components and cards, handle them by their edges and avoid touching pins and contacts.









## Before You Begin

- 1 Save and close all open files and exit all open applications.
  - 2 Shut down your computer.
    - Windows 8: Move your mouse pointer to the upper-right or lower-right corner of the screen to open the charms sidebar, and then click or tap **Settings** → **Power** → **Shut down**.
    - Windows 7: Click or tap **Start**  → **Shut down** .
-  **NOTE:** If you are using a different operating system, see the documentation of your operating system for shut-down instructions.
- 3 Disconnect your computer and all attached devices from their electrical outlets.
  - 4 Disconnect all cables such as telephone cables, network cables and so on, from your computer.
  - 5 Disconnect all attached devices and peripherals, such as keyboard, mouse, monitor, and so on, from your computer.
  - 6 Remove any media card and optical disc from your computer, if applicable.
  - 7 After the computer is unplugged, press and hold the power button for 5 seconds to ground the system board.

## Safety Instructions

Use the following safety guidelines to protect your computer from potential damage and ensure your personal safety.

 **WARNING:** Before working inside your computer, read the safety information that shipped with your computer. For more safety best practices, see the Regulatory Compliance home page at [dell.com/regulatory\\_compliance](http://dell.com/regulatory_compliance).

-  **WARNING:** Disconnect all power sources before opening the computer cover or panels. After you finish working inside the computer, replace all covers, panels, and screws before connecting to the power source.
-  **CAUTION:** To avoid damaging the computer, make sure that the work surface is flat and clean.
-  **CAUTION:** To avoid damaging the components and cards, handle them by their edges and avoid touching pins and contacts.
-  **CAUTION:** Only a certified service technician is authorized to remove the computer cover and access any of the components inside the computer. See the safety instructions for complete information about safety precautions, working inside your computer, and protecting against electrostatic discharge.
-  **CAUTION:** Before touching anything inside your computer, ground yourself by touching an unpainted metal surface, such as the metal at the back of the computer. While you work, periodically touch an unpainted metal surface to dissipate static electricity, which could harm internal components.
-  **CAUTION:** When you disconnect a cable, pull on its connector or on its pull-tab, not on the cable itself. Some cables have connectors with locking tabs or thumb-screws that you must disengage before disconnecting the cable. When disconnecting cables, keep them evenly aligned to avoid bending any connector pins. When connecting cables, make sure that the ports and connectors are correctly oriented and aligned.
-  **CAUTION:** To disconnect a network cable, first unplug the cable from your computer and then unplug the cable from the network device.
-  **CAUTION:** Press and eject any installed card from the media-card reader.

## Recommended Tools

The procedures in this document may require the following tools:

- Philips screwdriver
- Plastic scribe

# After Working Inside Your Computer

---



**CAUTION: Leaving stray or loose screws inside your computer may severely damage your computer.**

- 1 Replace all screws and make sure that no stray screws remain inside your computer.
- 2 Connect any external devices, peripherals, and cables you removed before working on your computer.
- 3 Replace any media cards, discs, and any other part(s) that you removed before working on your computer.
- 4 Connect your computer and all attached devices to their electrical outlets.
- 5 Turn on your computer.

# Removing the Battery

---

**⚠ WARNING:** Before working inside your computer, read the safety information that shipped with your computer and follow the steps in [Before Working Inside Your Computer](#). After working inside your computer, follow the instructions in [After Working Inside Your Computer](#). For more safety best practices, see the Regulatory Compliance home page at [dell.com/regulatory\\_compliance](http://dell.com/regulatory_compliance).

## Procedure

- 1 Close the display and turn the computer over.
- 2 Slide the battery latches to the unlock position. You hear a click sound when the battery is unlocked.
- 3 Using your fingertips, lift the battery at an angle and remove the battery off the computer base.

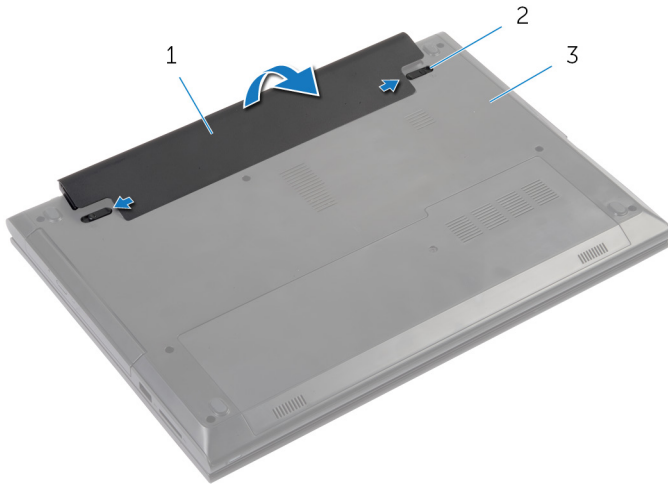

- |   |               |   |             |
|---|---------------|---|-------------|
| 1 | battery       | 2 | latches (2) |
| 3 | computer base |   |             |

- 4 Turn the computer over, open the display, and press the power button for five seconds to ground the system board.

# Replacing the Battery

---



**WARNING:** Before working inside your computer, read the safety information that shipped with your computer and follow the steps in [Before Working Inside Your Computer](#). After working inside your computer, follow the instructions in [After Working Inside Your Computer](#). For more safety best practices, see the Regulatory Compliance home page at [dell.com/regulatory\\_compliance](http://dell.com/regulatory_compliance).

## Procedure

Slide the tabs on the battery into the slots on the battery bay and snap the battery into place.

# Removing the Optical Drive

**!** **WARNING:** Before working inside your computer, read the safety information that shipped with your computer and follow the steps in [Before Working Inside Your Computer](#). After working inside your computer, follow the instructions in [After Working Inside Your Computer](#). For more safety best practices, see the Regulatory Compliance home page at [dell.com/regulatory\\_compliance](http://dell.com/regulatory_compliance).

## Prerequisites

Remove the [battery](#).

## Procedure

- 1 Remove the screw that secures the optical-drive assembly to the computer base.
- 2 Using your fingertips, slide the optical-drive assembly out of the optical-drive bay.

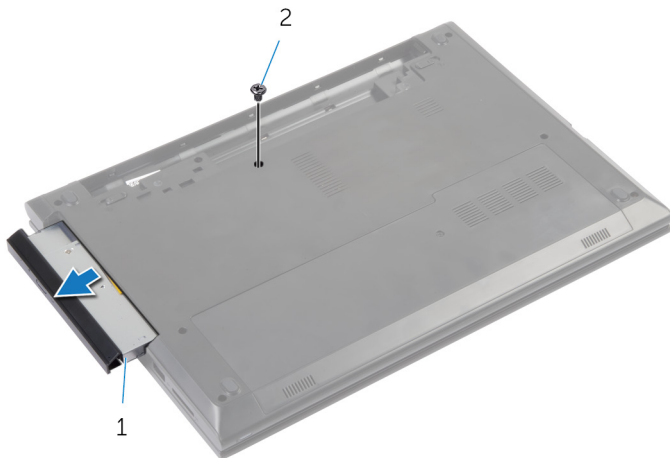

1 optical-drive assembly

2 screw

- 3 Carefully pull the optical-drive bezel and remove it from the optical drive.

- 4 Remove the screw that secures the optical-drive bracket to the optical-drive assembly and remove the optical-drive bracket.

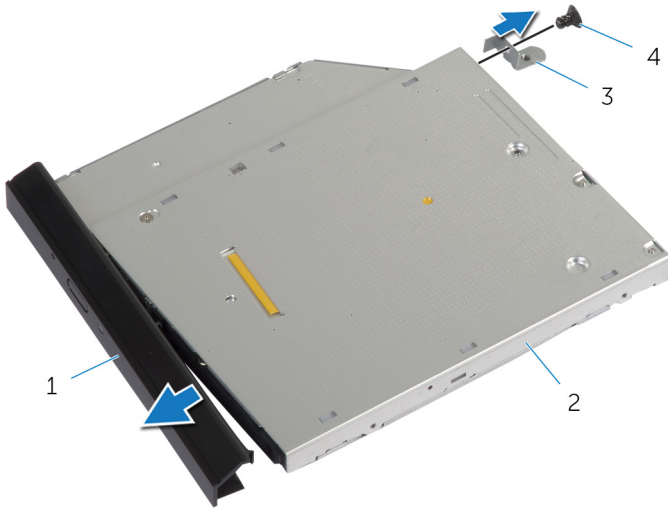

- |   |                       |   |               |
|---|-----------------------|---|---------------|
| 1 | optical-drive bezel   | 2 | optical drive |
| 3 | optical-drive bracket | 4 | screw         |

# Replacing the Optical Drive

---



**WARNING:** Before working inside your computer, read the safety information that shipped with your computer and follow the steps in [Before Working Inside Your Computer](#). After working inside your computer, follow the instructions in [After Working Inside Your Computer](#). For more safety best practices, see the Regulatory Compliance home page at [dell.com/regulatory\\_compliance](http://dell.com/regulatory_compliance).

## Procedure

- 1 Align the tabs on the optical-drive bezel with the slots on the optical drive and snap the optical-drive bezel into place.
- 2 Align the screw hole on the optical-drive bracket with the screw hole on the optical-drive assembly.
- 3 Replace the screw that secures the optical-drive bracket to the optical-drive assembly.
- 4 Slide the optical-drive assembly into the optical-drive bay and align the screw hole on the optical-drive bracket with the screw hole on the computer base.
- 5 Replace the screw that secures the optical-drive assembly to the computer base.

## Post-requisites

Replace the [battery](#).



# Removing the Base Cover

---

**!** **WARNING:** Before working inside your computer, read the safety information that shipped with your computer and follow the steps in [Before Working Inside Your Computer](#). After working inside your computer, follow the instructions in [After Working Inside Your Computer](#). For more safety best practices, see the Regulatory Compliance home page at [dell.com/regulatory\\_compliance](http://dell.com/regulatory_compliance).

## Prerequisites

Remove the [battery](#).

## Procedure

- 1 Remove the screw that secures the base cover to the computer base.
- 2 Slide the base cover to release the tabs on the base cover from the slots on the computer base.
- 3 Lift the base cover off the computer base.

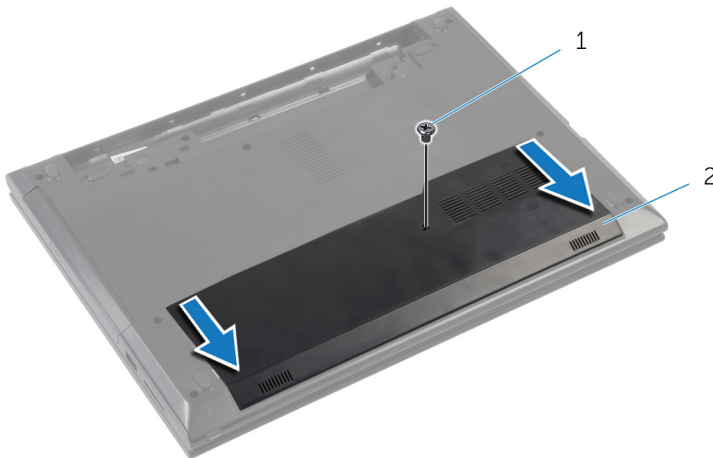

1 screw

2 base cover

# Replacing the Base Cover

---



**WARNING:** Before working inside your computer, read the safety information that shipped with your computer and follow the steps in [Before Working Inside Your Computer](#). After working inside your computer, follow the instructions in [After Working Inside Your Computer](#). For more safety best practices, see the Regulatory Compliance home page at [dell.com/regulatory\\_compliance](http://dell.com/regulatory_compliance).

## Procedure

- 1 Slide the tabs on the base cover into the slots on the computer base and snap the base cover into place.
- 2 Replace the screw that secures the base cover to the computer base.

## Post-requisites

Replace the [battery](#).

# Removing the Memory Module(s)

---

 **WARNING:** Before working inside your computer, read the safety information that shipped with your computer and follow the steps in [Before Working Inside Your Computer](#). After working inside your computer, follow the instructions in [After Working Inside Your Computer](#). For more safety best practices, see the Regulatory Compliance home page at [dell.com/regulatory\\_compliance](http://dell.com/regulatory_compliance).

## Prerequisites

- 1 Remove the [battery](#).
- 2 Remove the [base cover](#).

# Procedure

- 1 Use your fingertips to carefully spread apart the securing-clips on each end of the memory-module slot until the memory module pops up.
- 2 Remove the memory module from the memory-module slot.

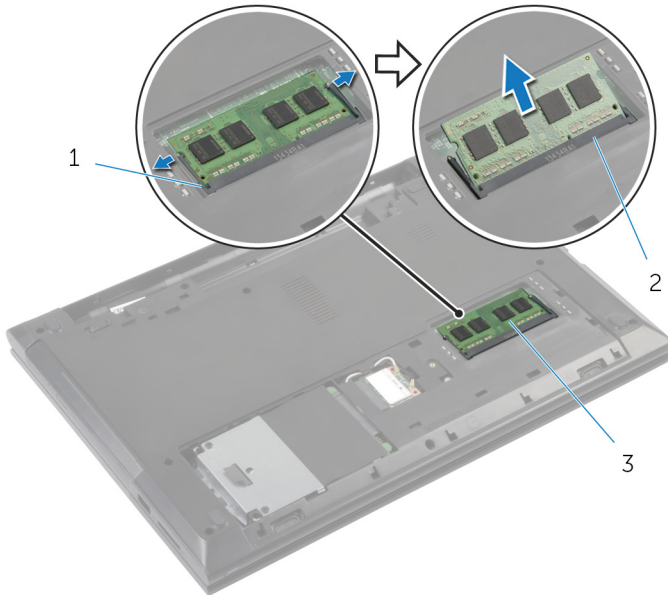

- 1 securing clips (2)
- 3 memory module

- 2 memory-module slot

# Replacing the Memory Module(s)

---

 **WARNING:** Before working inside your computer, read the safety information that shipped with your computer and follow the steps in [Before Working Inside Your Computer](#). After working inside your computer, follow the instructions in [After Working Inside Your Computer](#). For more safety best practices, see the Regulatory Compliance home page at [dell.com/regulatory\\_compliance](http://dell.com/regulatory_compliance).

## Procedure

- 1 Align the notch on the memory module with the tab on the memory-module slot.
- 2 Slide the memory module firmly into the slot at an angle and press the memory module down until it clicks into place.

 **NOTE:** If you do not hear the click, remove the memory module and reinstall it.

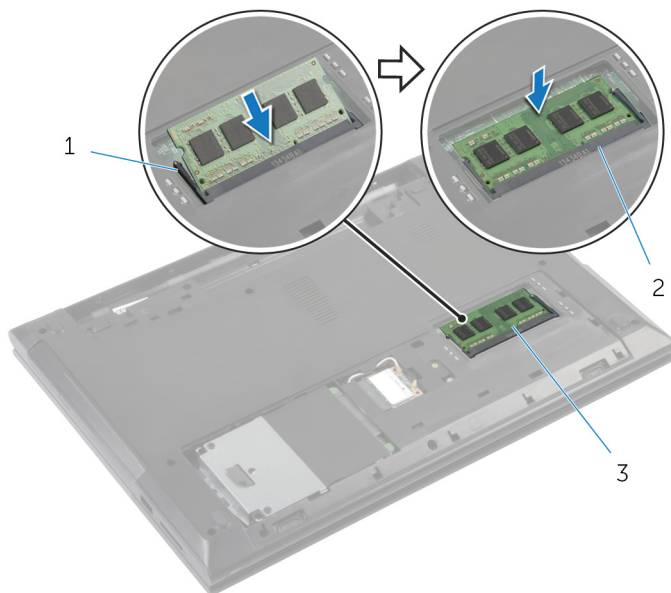

- 1 securing clips (2)
- 3 memory module

- 2 memory-module slot

## Post-requisites

- 1 Replace the [base cover](#).
- 2 Replace the [battery](#).

# Removing the Wireless Card

---



**WARNING:** Before working inside your computer, read the safety information that shipped with your computer and follow the steps in [Before Working Inside Your Computer](#). After working inside your computer, follow the instructions in [After Working Inside Your Computer](#). For more safety best practices, see the Regulatory Compliance home page at [dell.com/regulatory\\_compliance](http://dell.com/regulatory_compliance).

## Prerequisites

- 1 Remove the [battery](#).
- 2 Remove the [base cover](#).

## Procedure

- 1 Disconnect the antenna cables from the wireless card.
- 2 Remove the screw that secures the wireless card to the wireless-card slot.

**3** Slide and remove the wireless card out of the wireless-card slot.

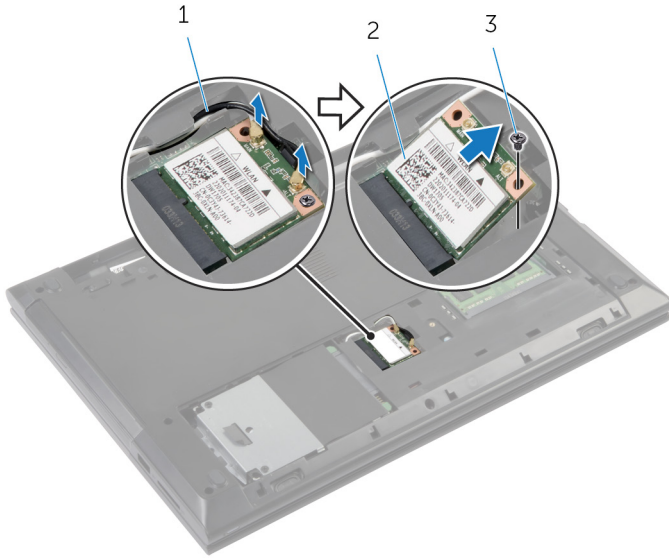

1 antenna cables (2)

2 wireless card

3 screw



# Replacing the Wireless Card

---

 **WARNING:** Before working inside your computer, read the safety information that shipped with your computer and follow the steps in [Before Working Inside Your Computer](#). After working inside your computer, follow the instructions in [After Working Inside Your Computer](#). For more safety best practices, see the Regulatory Compliance home page at [dell.com/regulatory\\_compliance](http://dell.com/regulatory_compliance).

## Procedure

 **CAUTION:** To avoid damage to the wireless card, do not place any cables under it.

- 1 Align the notch on the wireless card with the tab on the wireless-card slot.
- 2 Insert the wireless card into the wireless-card slot.
- 3 Replace the screw that secures the wireless card to the wireless-card slot.
- 4 Connect the antenna cables to the wireless card.

The following table provides the antenna-cable color scheme for the wireless card supported by your computer.

Connectors on the wireless card	Antenna-cable color
Main (white triangle)	white
Auxiliary (black triangle)	black

## Post-requisites

- 1 Replace the [base cover](#).
- 2 Replace the [battery](#).

# Removing the Keyboard

---



**WARNING:** Before working inside your computer, read the safety information that shipped with your computer and follow the steps in [Before Working Inside Your Computer](#). After working inside your computer, follow the instructions in [After Working Inside Your Computer](#). For more safety best practices, see the Regulatory Compliance home page at [dell.com/regulatory\\_compliance](http://dell.com/regulatory_compliance).

## Prerequisites

Remove the [battery](#).

## Procedure

- 1 Turn the computer over and, open the display.
- 2 Using a plastic scribe, pry the keyboard out by pressing the securing-clips starting from the middle securing-clip.

- 3** Slide the keyboard up to release it from the tabs on the palm rest.

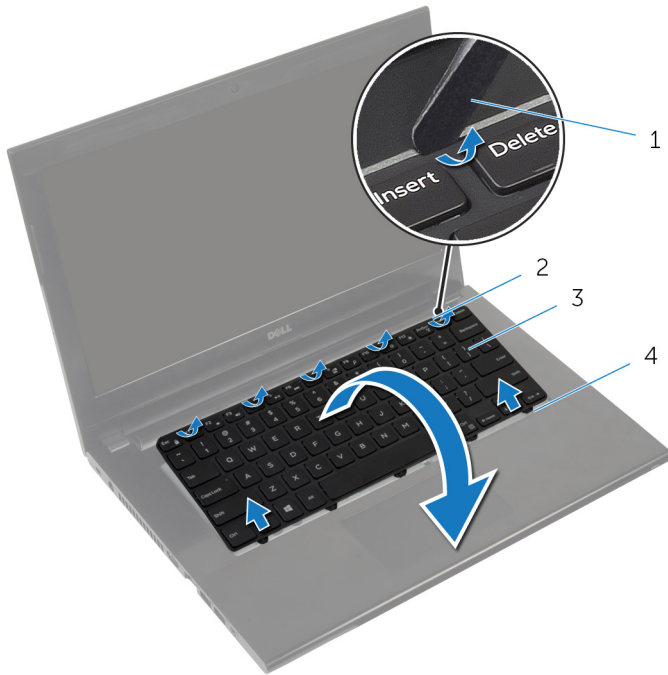

- |   |                |   |                    |
|---|----------------|---|--------------------|
| 1 | plastic scribe | 2 | securing clips (5) |
| 3 | keyboard       | 4 | tabs (5)           |

- 4** Turn the keyboard over and place it on the palm rest.

- 5** Lift the latch and disconnect the keyboard cable from the system board.

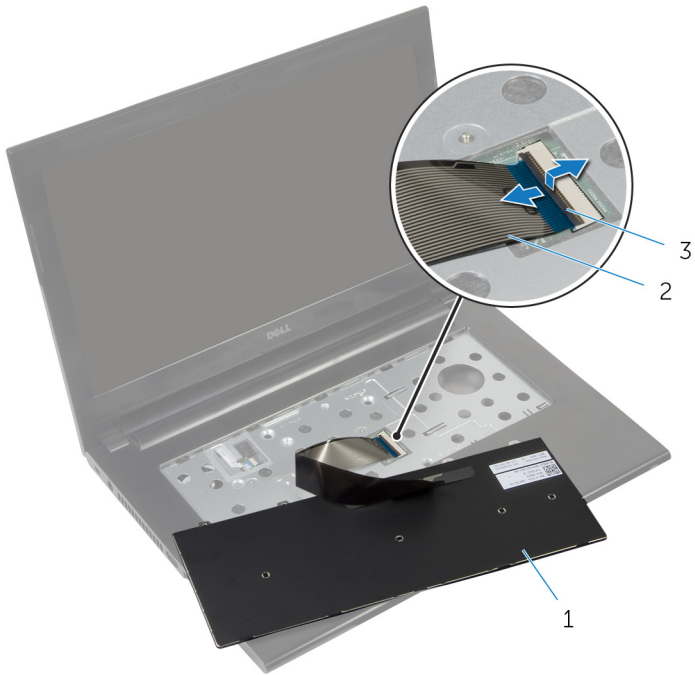

1 keyboard

2 keyboard cable

3 latch

- 6** Lift the keyboard off the palm rest.

# Replacing the Keyboard

---

 **WARNING:** Before working inside your computer, read the safety information that shipped with your computer and follow the steps in [Before Working Inside Your Computer](#). After working inside your computer, follow the instructions in [After Working Inside Your Computer](#). For more safety best practices, see the Regulatory Compliance home page at [dell.com/regulatory\\_compliance](http://dell.com/regulatory_compliance).

## Procedure

 **NOTE:** If you are installing a new keyboard, fold the cables the same way they are folded on the old keyboard. For more information, see "[Folding the Keyboard Cable](#)".

- 1 Slide the keyboard cable into the connector and press down on the latch to secure the cable.
- 2 Turn over the keyboard.
- 3 Slide the tabs on the keyboard into the slots on the palm rest and snap the keyboard into place.

## Post-requisites

Replace the [battery](#).

## Folding the Keyboard Cable

 **CAUTION:** Do not apply excess pressure while folding the cable.



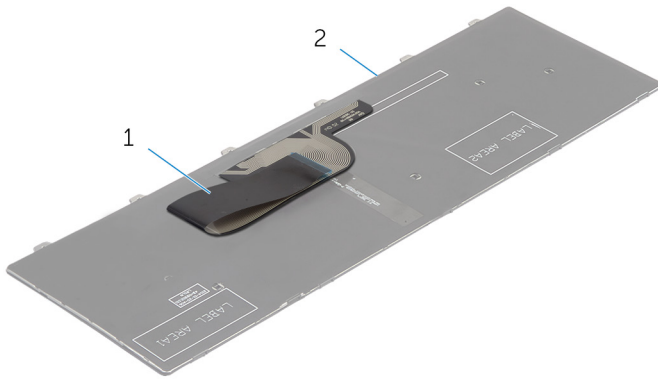

1 keyboard cable

2 keyboard

# Removing the Hard Drive

---

 **WARNING:** Before working inside your computer, read the safety information that shipped with your computer and follow the steps in [Before Working Inside Your Computer](#). After working inside your computer, follow the instructions in [After Working Inside Your Computer](#). For more safety best practices, see the Regulatory Compliance home page at [dell.com/regulatory\\_compliance](http://dell.com/regulatory_compliance).

 **CAUTION:** Hard drives are fragile. Exercise care when handling the hard drive.

 **CAUTION:** To avoid data loss, do not remove the hard drive while the computer is in Sleep or On state.

## Prerequisites

- 1 Remove the [battery](#).
- 2 Remove the [base cover](#).

## Procedure

- 1 Remove the screw that secures the hard-drive assembly to the computer base.
- 2 Slide the hard-drive assembly towards the side of the computer to disconnect the hard-drive assembly from its connector on the system board.



- 3 Using the pull-tab, lift and slide the hard-drive assembly out of the tabs on the computer base.

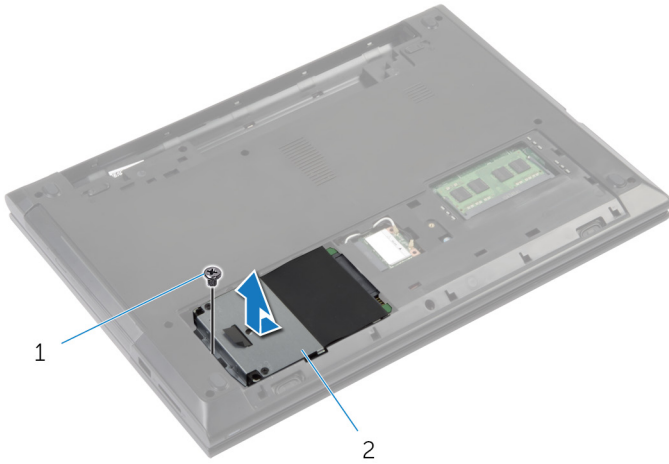

1 screw

2 hard-drive

- 4 Remove the screws that secure the hard-drive bracket to the hard drive.
- 5 Using the pull-tab, lift the hard-drive bracket off the hard drive.

6 Peel off the Mylar sheet from the hard drive.

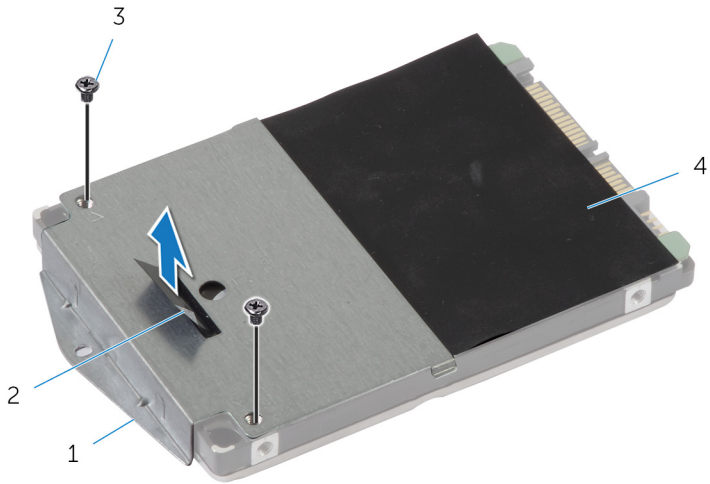

1 hard-drive bracket



2 pull-tab

3 screws (2)

4 mylar sheet

# Replacing the Hard Drive

---

-  **WARNING:** Before working inside your computer, read the safety information that shipped with your computer and follow the steps in [Before Working Inside Your Computer](#). After working inside your computer, follow the instructions in [After Working Inside Your Computer](#). For more safety best practices, see the Regulatory Compliance home page at [dell.com/regulatory\\_compliance](http://dell.com/regulatory_compliance).
-  **CAUTION:** Hard drives are fragile. Exercise care when handling the hard drive.

## Procedure

- 1 Adhere the Mylar sheet on the hard drive.
- 2 Align the screw holes on the hard-drive bracket with the screw holes on the hard drive.
- 3 Replace the screws that secure the hard-drive bracket to the hard drive.
- 4 Slide the hard-drive assembly under the tabs on the computer base and place the hard-drive assembly in the computer base.
- 5 Replace the screw that secures the hard-drive assembly to the computer base.

## Post-requisites

- 1 Replace the [base cover](#).
- 2 Replace the [battery](#).

# Removing the Palm Rest

---



**WARNING:** Before working inside your computer, read the safety information that shipped with your computer and follow the steps in [Before Working Inside Your Computer](#). After working inside your computer, follow the instructions in [After Working Inside Your Computer](#). For more safety best practices, see the Regulatory Compliance home page at [dell.com/regulatory\\_compliance](http://dell.com/regulatory_compliance).

## Prerequisites

- 1 Remove the [battery](#).
- 2 Remove the [base cover](#).
- 3 Remove the [hard drive](#).
- 4 Remove the [keyboard](#).

# Procedure

- 1 Turn the computer over and open the display as far as possible.
- 2 Remove the screws that secure the palm rest to the computer base.

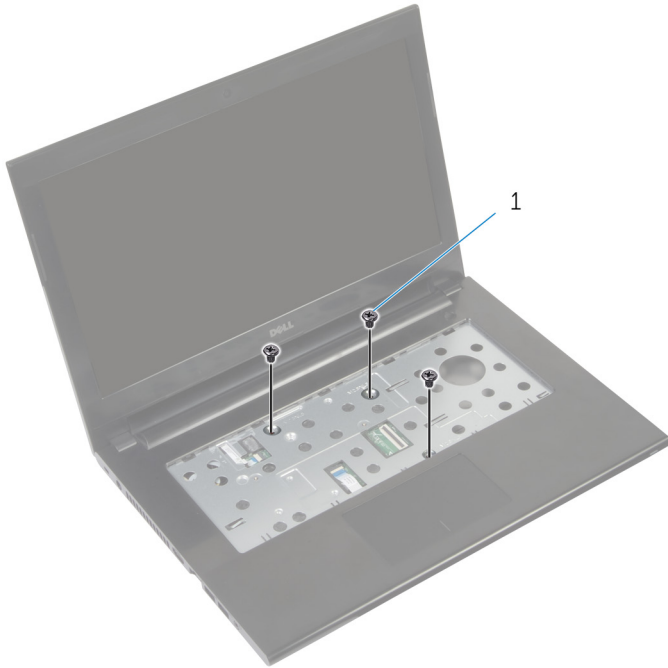

1 screws (3)

- 3 Remove the tape covering the power-button cable.

- 4 Lift the latches and, using the pull-tabs, disconnect the power-button cable and the touchpad cable from the system board.

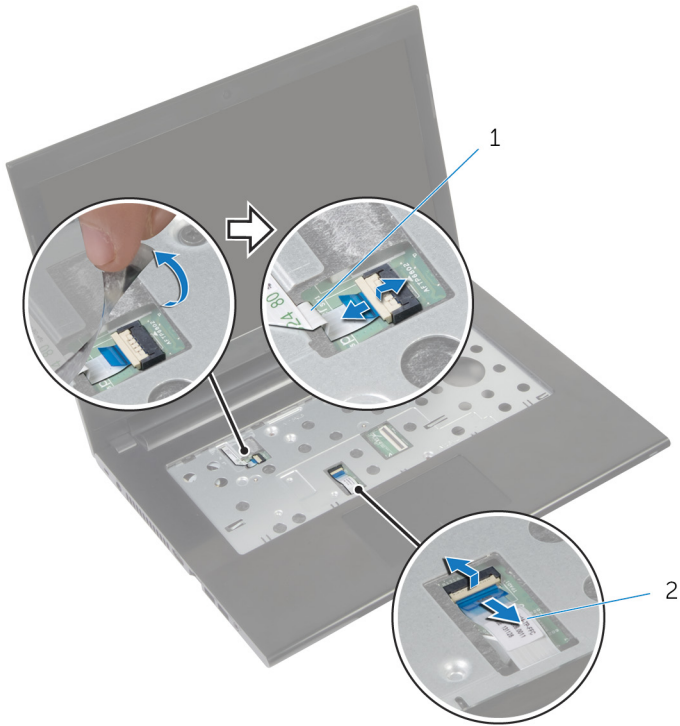

1 power-button cable

2 touchpad cable

- 5 Close the display and turn the computer over.

- 6** Remove the screws that secure the palm rest to the computer base.

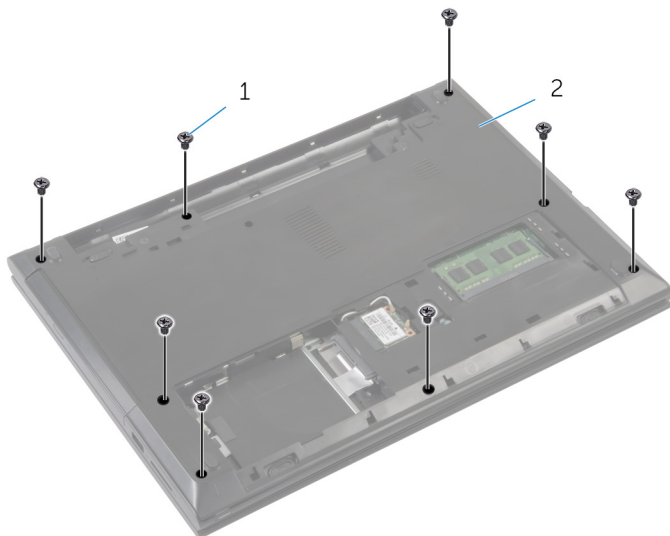

1 screws (8)

2 computer base

- 7** Using a plastic scribe, release the tabs on the palm rest from the slots on the computer base.



1 plastic scribe

2 palm rest

3 computer base

- 8** Turn the computer over and open the display as far as possible.

- 9 Lift the palm rest from the bottom edge and away from the computer base.



1 palm rest

- 10 Follow the procedure from step 2 to step 5 in "Removing the [Power-Button Board](#)".
- 11 Follow the procedure from step 2 to step 3 in "Removing the [Touchpad](#)".



# Replacing the Palm Rest

---



**WARNING:** Before working inside your computer, read the safety information that shipped with your computer and follow the steps in [Before Working Inside Your Computer](#). After working inside your computer, follow the instructions in [After Working Inside Your Computer](#). For more safety best practices, see the Regulatory Compliance home page at [dell.com/regulatory\\_compliance](http://dell.com/regulatory_compliance).

## Procedure

- 1 Follow the procedure from step 1 to step 3 in “Replacing the [Touchpad](#)”.
- 2 Follow the procedure from step 1 to step 4 in “Replacing the [Power-Button Board](#)”.
- 3 Align the palm rest over the computer base.
- 4 Press down on the edges of the palm rest to snap it into place.
- 5 Replace the screws that secure the palm rest to the computer base.
- 6 Slide the touchpad cable and the power-button cable into the connectors on the system board and press down on the latches to secure the cables.
- 7 Adhere the tape back on the power-button cable.
- 8 Close the display and turn the computer over.
- 9 Replace the screws that secure the palm rest to the computer base.

## Post-requisites

- 1 Replace the [hard drive](#).
- 2 Replace the [base cover](#).
- 3 Replace the [keyboard](#).
- 4 Replace the [battery](#).

# Removing the Power-Button Board

---



**WARNING:** Before working inside your computer, read the safety information that shipped with your computer and follow the steps in [Before Working Inside Your Computer](#). After working inside your computer, follow the instructions in [After Working Inside Your Computer](#). For more safety best practices, see the Regulatory Compliance home page at [dell.com/regulatory\\_compliance](http://dell.com/regulatory_compliance).

## Prerequisites

- 1 Remove the [battery](#).
- 2 Remove the [base cover](#).
- 3 Remove the [keyboard](#).
- 4 Remove the [memory module\(s\)](#).
- 5 Remove the [wireless card](#).
- 6 Remove the [hard drive](#).

## Procedure

- 1 Follow the procedure from step 1 to step 7 in “Removing the [Palm Rest](#)”.
- 2 Peel the tape from the power-button board.
- 3 Remove the screw that secures the power-button board to the palm rest.
- 4 Note the power-button cable routing and peel the cable from the palm rest.

- 5 Lift the power-button board along with the cable off the palm rest.

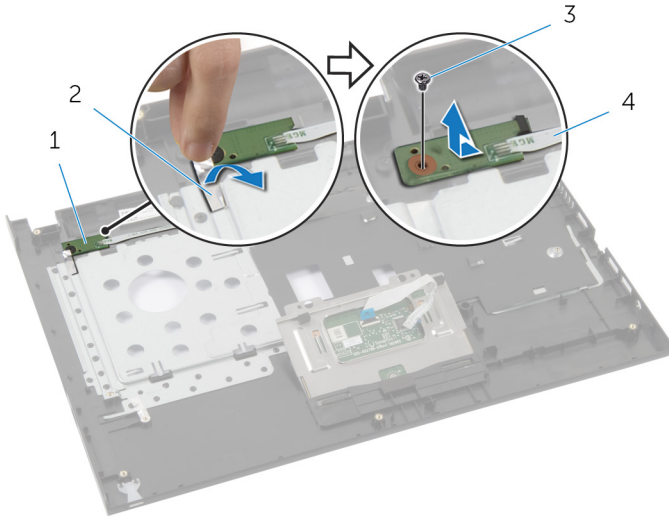

1 power-button board

2 tape

3 screw

4 power-button cable

# Replacing the Power-Button Board

---



**WARNING:** Before working inside your computer, read the safety information that shipped with your computer and follow the steps in [Before Working Inside Your Computer](#). After working inside your computer, follow the instructions in [After Working Inside Your Computer](#). For more safety best practices, see the Regulatory Compliance home page at [dell.com/regulatory\\_compliance](http://dell.com/regulatory_compliance).

## Procedure

- 1 Route the power-button cable through the routing guides on the palm rest.
- 2 Align the screw hole on the power-button board with the screw hole on the palm rest.
- 3 Replace the screw that secures the power-button board to the palm rest.
- 4 Adhere the tape to the power-button board.
- 5 Follow the procedure from step 3 to step 9 in "Replacing the [Palm Rest](#)".

## Post-requisites

- 1 Replace the [hard drive](#).
- 2 Replace the [wireless card](#).
- 3 Replace the [memory module\(s\)](#).
- 4 Replace the [keyboard](#).
- 5 Replace the [base cover](#).
- 6 Replace the [battery](#).

# Removing the Touchpad

---



**WARNING:** Before working inside your computer, read the safety information that shipped with your computer and follow the steps in [Before Working Inside Your Computer](#). After working inside your computer, follow the instructions in [After Working Inside Your Computer](#). For more safety best practices, see the Regulatory Compliance home page at [dell.com/regulatory\\_compliance](http://dell.com/regulatory_compliance).

## Prerequisites

- 1 Remove the [battery](#).
- 2 Remove the [base cover](#).
- 3 Remove the [memory module\(s\)](#).
- 4 Remove the [wireless card](#).
- 5 Remove the [hard drive](#).
- 6 Remove the [keyboard](#).

## Procedure

- 1 Follow the procedure from step 1 to step 7 in “Removing the [Palm Rest](#)”.
- 2 Remove the screws that secure the touchpad to the palm rest.

**3** Slide and remove the touchpad out of its slot on the palm rest.

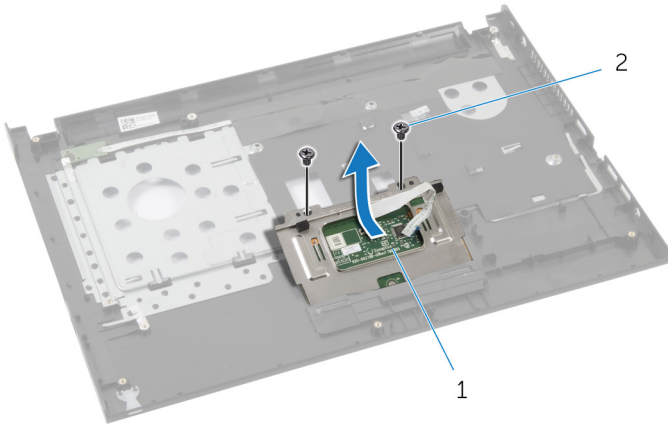

1 touchpad

2 screws (2)

# Replacing the Touchpad

**⚠ WARNING:** Before working inside your computer, read the safety information that shipped with your computer and follow the steps in [Before Working Inside Your Computer](#). After working inside your computer, follow the instructions in [After Working Inside Your Computer](#). For more safety best practices, see the Regulatory Compliance home page at [dell.com/regulatory\\_compliance](http://dell.com/regulatory_compliance).

## Procedure

- 1 Slide and replace the touchpad into its slot on the palm rest.
- 2 Align the screw holes on the touchpad with the screw holes on the palm rest.
- 3 Replace the screws that secure the touchpad to the palm rest.
- 4 Follow the procedure from step 3 to step 9 in “Replacing the [Palm Rest](#)”.

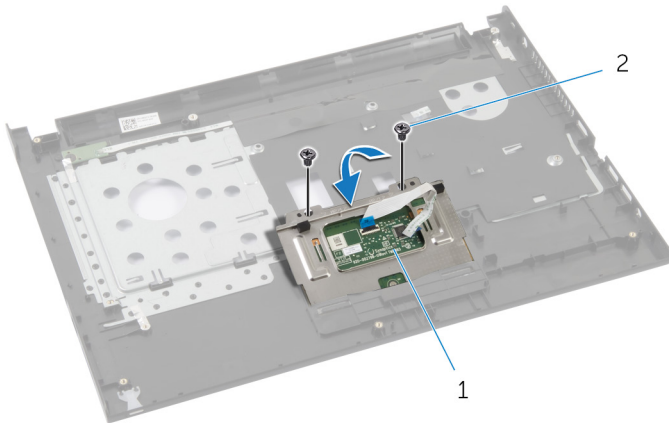

1 touchpad

2 screws (2)

## Post-requisites

- 1 Replace the [hard drive](#).
- 2 Replace the [wireless card](#).
- 3 Replace the [memory module\(s\)](#).
- 4 Replace the [base cover](#).

- 5 Replace the [keyboard](#).
- 6 Replace the [battery](#).



# Removing the I/O Board

---



**WARNING:** Before working inside your computer, read the safety information that shipped with your computer and follow the steps in [Before Working Inside Your Computer](#). After working inside your computer, follow the instructions in [After Working Inside Your Computer](#). For more safety best practices, see the Regulatory Compliance home page at [dell.com/regulatory\\_compliance](http://dell.com/regulatory_compliance).

## Prerequisites

- 1 Remove the [battery](#).
- 2 Remove the [base cover](#).
- 3 Remove the [memory module\(s\)](#).
- 4 Remove the [wireless card](#).
- 5 Remove the [hard drive](#).
- 6 Remove the [keyboard](#).
- 7 Remove the [palm rest](#).

## Procedure

- 1 Lift the I/O board from the computer base and turn it over.
- 2 Lift the latch and, using the pull-tab, disconnect the I/O-board cable from the I/O board.

**3** Lift the I/O board away from the computer base.

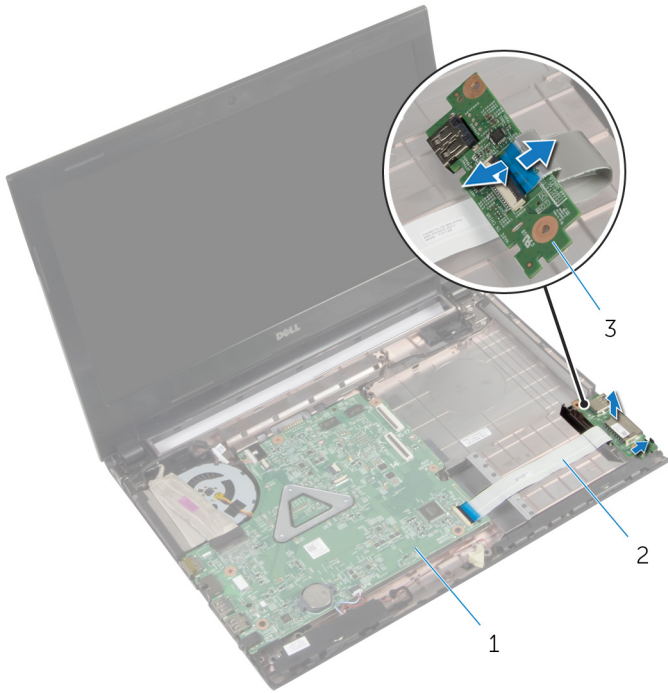

1 system board

2 I/O-board cable

3 I/O board

# Replacing the I/O Board

---



**WARNING:** Before working inside your computer, read the safety information that shipped with your computer and follow the steps in [Before Working Inside Your Computer](#). After working inside your computer, follow the instructions in [After Working Inside Your Computer](#). For more safety best practices, see the Regulatory Compliance home page at [dell.com/regulatory\\_compliance](http://dell.com/regulatory_compliance).

## Procedure

- 1 Slide the I/O-board cable into the I/O-board cable connector and press down on the latch to secure the cable.
- 2 Turn over the I/O board and use the alignment post on the computer base to place the I/O board in position.

## Post-requisites

- 1 Replace the [palm rest](#).
- 2 Replace the [hard drive](#).
- 3 Replace the [wireless card](#).
- 4 Replace the [memory module\(s\)](#).
- 5 Replace the [base cover](#).
- 6 Replace the [keyboard](#).
- 7 Replace the [battery](#).

# Removing the Speakers

---



**WARNING:** Before working inside your computer, read the safety information that shipped with your computer and follow the steps in [Before Working Inside Your Computer](#). After working inside your computer, follow the instructions in [After Working Inside Your Computer](#). For more safety best practices, see the Regulatory Compliance home page at [dell.com/regulatory\\_compliance](http://dell.com/regulatory_compliance).

## Prerequisites

- 1 Remove the [battery](#).
- 2 Remove the [base cover](#).
- 3 Remove the [memory module\(s\)](#).
- 4 Remove the [wireless card](#).
- 5 Remove the [hard drive](#).
- 6 Remove the [keyboard](#).
- 7 Remove the [palm rest](#).
- 8 Remove the [I/O board](#).

## Procedure

- 1 Disconnect the speaker cable from the system board.
- 2 Note the speaker-cable routing and remove the cable from the routing guides.

**3** Lift the speakers, along with the speaker cable, off the computer base.

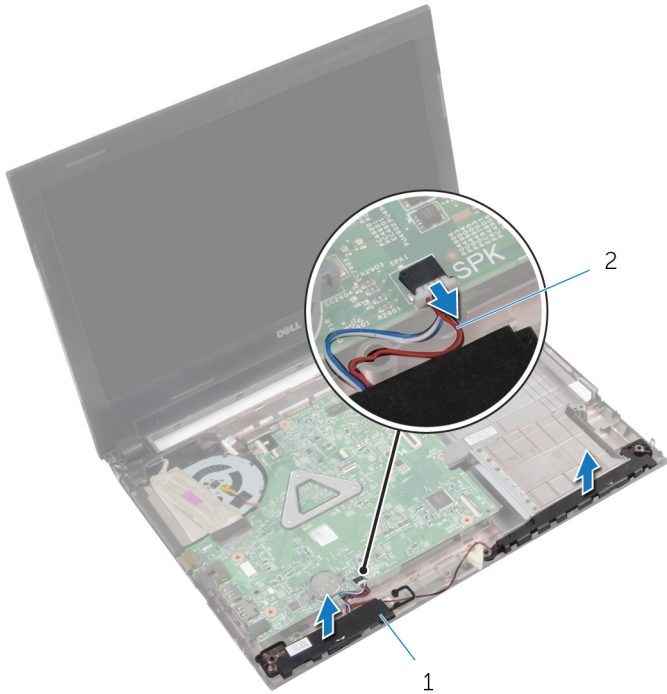

1 speakers (2)

2 speaker cable

# Replacing the Speakers

---



**WARNING:** Before working inside your computer, read the safety information that shipped with your computer and follow the steps in [Before Working Inside Your Computer](#). After working inside your computer, follow the instructions in [After Working Inside Your Computer](#). For more safety best practices, see the Regulatory Compliance home page at [dell.com/regulatory\\_compliance](http://dell.com/regulatory_compliance).

## Procedure



- 1 Using the alignment posts on the computer base, place the speakers on the computer base.
- 2 Route the speaker cable through the routing guides on the computer base.
- 3 Connect the speaker cable to the system board.

## Post-requisites

- 1 Replace the [I/O board](#).
- 2 Replace the [palm rest](#).
- 3 Replace the [hard drive](#).
- 4 Replace the [wireless card](#).
- 5 Replace the [memory module\(s\)](#).
- 6 Replace the [base cover](#).
- 7 Replace the [keyboard](#).
- 8 Replace the [battery](#).

# Removing the Coin-Cell Battery

---

-  **WARNING:** Before working inside your computer, read the safety information that shipped with your computer and follow the steps in [Before Working Inside Your Computer](#). After working inside your computer, follow the instructions in [After Working Inside Your Computer](#). For more safety best practices, see the Regulatory Compliance home page at [dell.com/regulatory\\_compliance](http://dell.com/regulatory_compliance).
-  **CAUTION:** Removing the coin-cell battery resets the BIOS settings to default. It is recommended that you note the BIOS settings before removing the coin-cell battery.

## Prerequisites

- 1 Remove the [battery](#).
- 2 Remove the [base cover](#).
- 3 Remove the [memory module\(s\)](#).
- 4 Remove the [wireless card](#).
- 5 Remove the [hard drive](#).
- 6 Remove the [keyboard](#).
- 7 Remove the [palm rest](#).

## Procedure

Using a plastic scribe, gently pry out the coin-cell battery out of the battery socket on the system board.

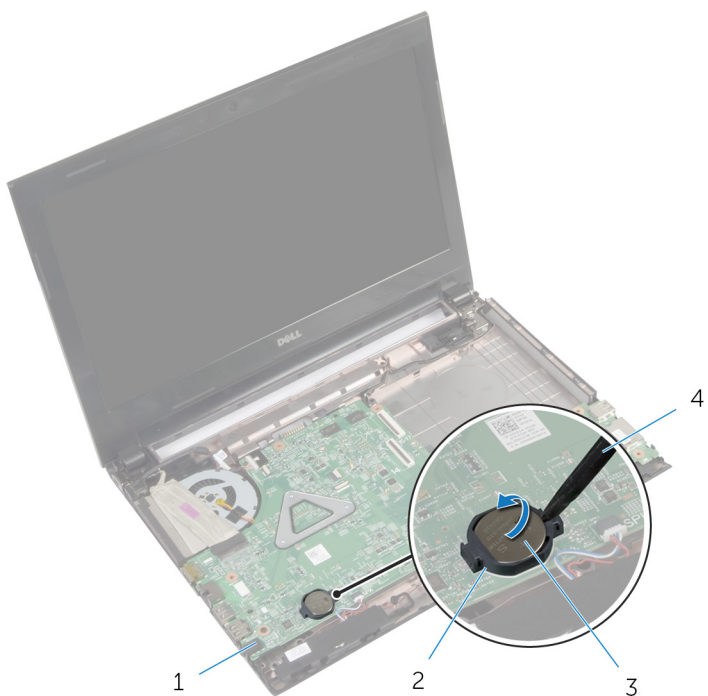

1 system board  
3 coin-cell battery

2 battery socket  
4 plastic scribe



# Replacing the Coin-Cell Battery

---

 **WARNING:** Before working inside your computer, read the safety information that shipped with your computer and follow the steps in [Before Working Inside Your Computer](#). After working inside your computer, follow the instructions in [After Working Inside Your Computer](#). For more safety best practices, see the Regulatory Compliance home page at [dell.com/regulatory\\_compliance](http://dell.com/regulatory_compliance).

## Procedure

With the positive-side facing up, snap the coin-cell battery into the battery socket on the system board.

## Post-requisites

- 1 Replace the [palm rest](#).
- 2 Replace the [hard drive](#).
- 3 Replace the [wireless card](#).
- 4 Replace the [memory module\(s\)](#).
- 5 Replace the [base cover](#).
- 6 Replace the [keyboard](#).
- 7 Replace the [battery](#).

# Removing the Power-Adapter Port

---



**WARNING:** Before working inside your computer, read the safety information that shipped with your computer and follow the steps in [Before Working Inside Your Computer](#). After working inside your computer, follow the instructions in [After Working Inside Your Computer](#). For more safety best practices, see the Regulatory Compliance home page at [dell.com/regulatory\\_compliance](http://dell.com/regulatory_compliance).

## Prerequisites

- 1 Remove the [battery](#).
- 2 Remove the [base cover](#).
- 3 Remove the [memory module\(s\)](#).
- 4 Remove the [wireless card](#).
- 5 Remove the [hard drive](#).
- 6 Remove the [keyboard](#).
- 7 Remove the [palm rest](#).

## Procedure

- 1 Disconnect the power-adapter-port cable from the system board.
- 2 Note the power-adapter-port cable routing and remove it from the routing guides on the computer base.

- 3** Lift the power-adapter port, along with its cable, off the computer base.

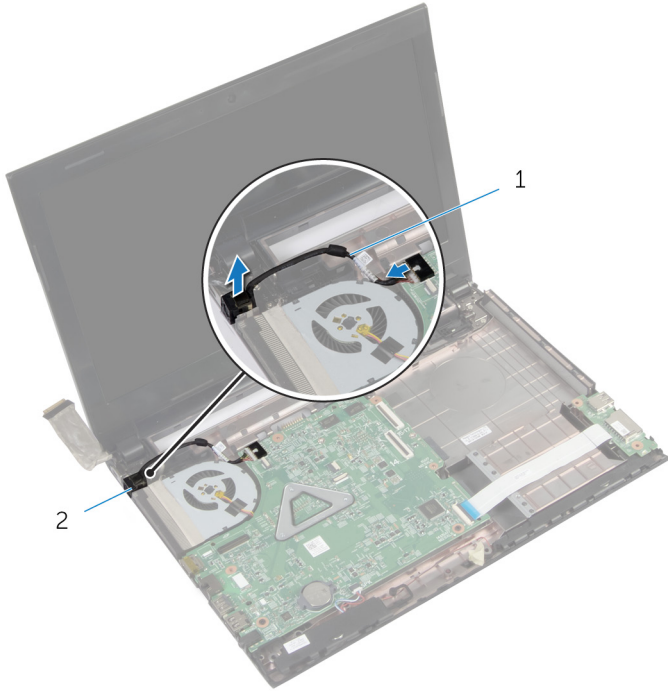

1 power-adapter port cable

2 power-adapter port

# Replacing the Power-Adapter Port

---



**WARNING:** Before working inside your computer, read the safety information that shipped with your computer and follow the steps in [Before Working Inside Your Computer](#). After working inside your computer, follow the instructions in [After Working Inside Your Computer](#). For more safety best practices, see the Regulatory Compliance home page at [dell.com/regulatory\\_compliance](http://dell.com/regulatory_compliance).

## Procedure

- 1 Slide the power-adapter port into position.
- 2 Route the power-adapter-port cable through the routing guides on the computer base.
- 3 Connect the power-adapter-port cable to the system board.

## Post-requisites

- 1 Replace the [palm rest](#).
- 2 Replace the [hard drive](#).
- 3 Replace the [wireless card](#).
- 4 Replace the [memory module\(s\)](#).
- 5 Replace the [base cover](#).
- 6 Replace the [keyboard](#).
- 7 Replace the [battery](#).

# Removing the System Board

---



**WARNING:** Before working inside your computer, read the safety information that shipped with your computer and follow the steps in [Before Working Inside Your Computer](#). After working inside your computer, follow the instructions in [After Working Inside Your Computer](#). For more safety best practices, see the Regulatory Compliance home page at [dell.com/regulatory\\_compliance](http://dell.com/regulatory_compliance).



**NOTE:** Your computer's Service Tag is stored in the system board. You must enter the Service Tag in the system setup after you replace the system board.



**NOTE:** Replacing the system board removes any changes you have made to the BIOS using System Setup. You must make the desired changes again after you replace the system board.



**NOTE:** Before disconnecting the cables from the system board, note the location of the connectors so that you can reconnect them correctly after you replace the system board.

## Prerequisites

- 1 Remove the [battery](#).
- 2 Remove the [optical drive](#).
- 3 Remove the [base cover](#).
- 4 Remove the [memory module\(s\)](#).
- 5 Remove the [wireless card](#).
- 6 Remove the [hard drive](#).
- 7 Remove the [keyboard](#).
- 8 Remove the [palm rest](#).

## Procedure

- 1 Peel the tape that secures the display cable to the connector on the system board.
- 2 Lift the latch and, using the pull-tab, disconnect the display cable from the connector on the system board.
- 3 Peel the display cable from the fan.
- 4 Lift the latch and, using the pull-tab, disconnect the I/O-board cable from the connector on the system board.

- 5** Disconnect the power-adaptor-port cable and speaker cable from the connector on the system board.

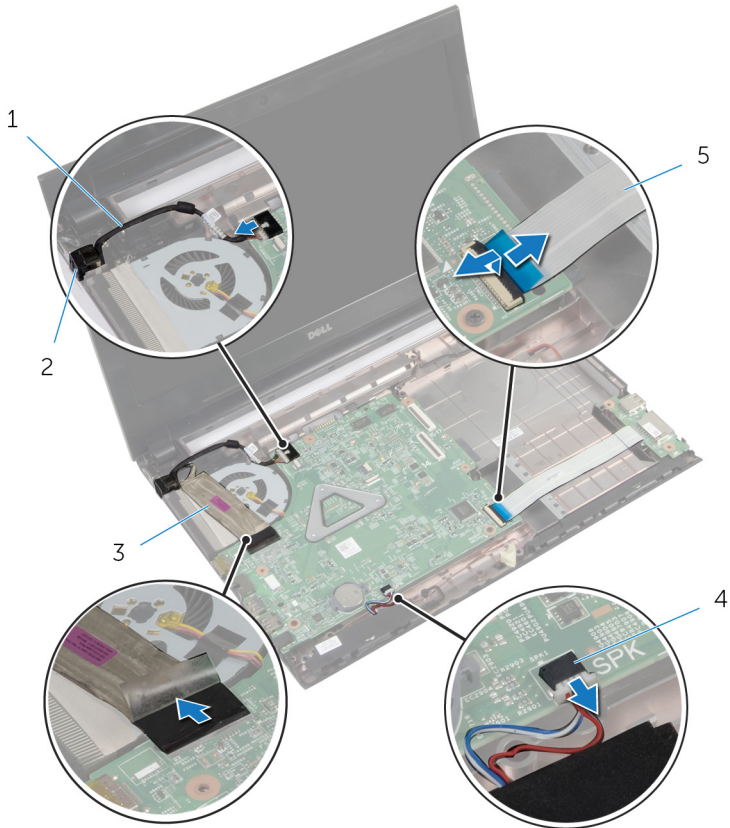

- |   |                          |   |                    |
|---|--------------------------|---|--------------------|
| 1 | power-adaptor port cable | 2 | power-adaptor port |
| 3 | display cable            | 4 | speaker cable      |
| 5 | I/O-board cable          |   |                    |

- 6** Remove the screws that secure the system board to the computer base.

7 Lift the system board off the computer base.

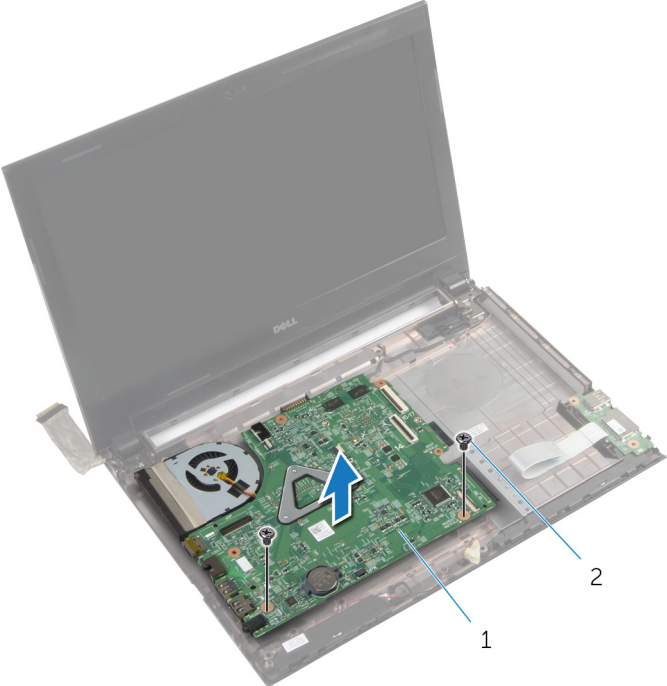

1 system board

2 screws (2)

# Replacing the System Board

---



**WARNING:** Before working inside your computer, read the safety information that shipped with your computer and follow the steps in [Before Working Inside Your Computer](#). After working inside your computer, follow the instructions in [After Working Inside Your Computer](#). For more safety best practices, see the Regulatory Compliance home page at [dell.com/regulatory\\_compliance](http://dell.com/regulatory_compliance).



**NOTE:** Your computer's Service Tag is stored in the system board. You must enter the Service Tag in the system setup after you replace the system board.

## Procedure

- 1 Align the screw holes on the system board with the screw holes on the computer base.
- 2 Replace the screws that secure the system board to the computer base.
- 3 Connect the power-adaptor-port cable and speaker cable to the connectors on the system board.
- 4 Slide the I/O-board cable into the connector on the system board and press down on the latch to secure the cable.
- 5 Adhere the display cable to the fan.
- 6 Slide the display cable into the connector on the system board and press down on the latch to secure the cable.
- 7 Adhere the tape that secures the display cable to the system board.



## Post-requisites

- 1 Replace the [palm rest](#).
- 2 Replace the [hard drive](#).
- 3 Replace the [wireless card](#).
- 4 Replace the [memory module\(s\)](#).
- 5 Replace the [base cover](#).
- 6 Replace the [keyboard](#).
- 7 Replace the [optical drive](#).
- 8 Replace the [battery](#).



# Removing the Heat-Sink Assembly

---

-  **WARNING:** Before working inside your computer, read the safety information that shipped with your computer and follow the steps in [Before Working Inside Your Computer](#). After working inside your computer, follow the instructions in [After Working Inside Your Computer](#). For more safety best practices, see the Regulatory Compliance home page at [dell.com/regulatory\\_compliance](http://dell.com/regulatory_compliance).
-  **WARNING:** The heat sink may become hot during normal operation. Allow sufficient time for the heat sink to cool before you touch it.
-  **CAUTION:** To ensure maximum cooling for the processor, do not touch the heat transfer areas on the heat sink. The oils in your skin can reduce the heat transfer capability of the thermal grease.

## Prerequisites

- 1 Remove the [battery](#).
- 2 Remove the [optical drive](#).
- 3 Remove the [base cover](#).
- 4 Remove the [memory module\(s\)](#).
- 5 Remove the [wireless card](#).
- 6 Remove the [hard drive](#).
- 7 Remove the [keyboard](#).
- 8 Remove the [palm rest](#).
- 9 Remove the [system board](#).

## Procedure

-  **NOTE:** The appearance of the heat-sink assembly on your system may differ from the image below.
- 1 Turn the system board over and place it on a flat surface.
  - 2 Disconnect the fan cable from the system board.
  - 3 In sequential order (indicated on the heat-sink), loosen the captive screws that secure the heat-sink assembly to the system board.

4 Lift the heat-sink assembly off the system board.

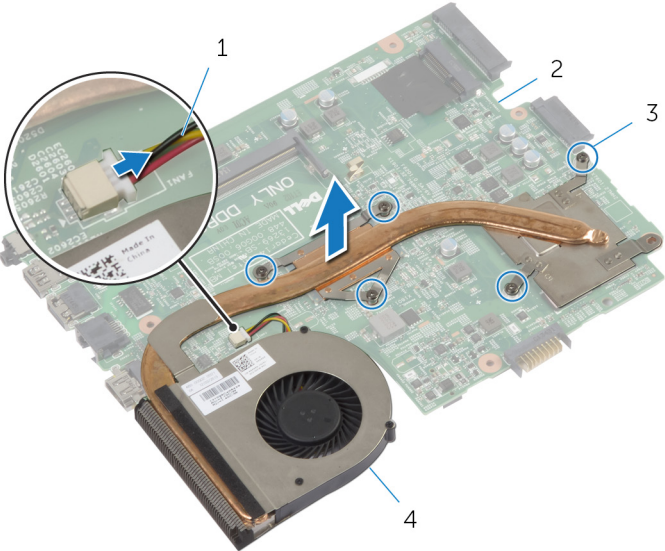

- 1 fan cable
- 2 system board
- 3 captive screws (5)
- 4 heat-sink assembly

# Replacing the Heat-Sink Assembly

---

 **WARNING:** Before working inside your computer, read the safety information that shipped with your computer and follow the steps in [Before Working Inside Your Computer](#). After working inside your computer, follow the instructions in [After Working Inside Your Computer](#). For more safety best practices, see the Regulatory Compliance home page at [dell.com/regulatory\\_compliance](http://dell.com/regulatory_compliance).

 **CAUTION:** Incorrect alignment of the heat sink can cause damage to the system board and processor.

## Procedure

- 1 Align the screw holes on the heat-sink assembly with the screw holes on the system board.
- 2 In sequential order (indicated on the heat-sink), tighten the captive screws that secure the heat-sink assembly to the system board.
- 3 Connect the fan cable to the system board.

## Post-requisites

- 1 Replace the [system board](#).
- 2 Replace the [palm rest](#).
- 3 Replace the [hard drive](#).
- 4 Replace the [wireless card](#).
- 5 Replace the [memory module\(s\)](#).
- 6 Replace the [base cover](#).
- 7 Replace the [keyboard](#).
- 8 Replace the [optical drive](#).
- 9 Replace the [battery](#).

# Removing the Display Assembly

---



**WARNING:** Before working inside your computer, read the safety information that shipped with your computer and follow the steps in [Before Working Inside Your Computer](#). After working inside your computer, follow the instructions in [After Working Inside Your Computer](#). For more safety best practices, see the Regulatory Compliance home page at [dell.com/regulatory\\_compliance](http://dell.com/regulatory_compliance).

## Prerequisites

- 1 Remove the [battery](#).
- 2 Remove the [optical drive](#).
- 3 Remove the [base cover](#).
- 4 Remove the [memory module\(s\)](#).
- 5 Remove the [wireless card](#).
- 6 Remove the [hard drive](#).
- 7 Remove the [keyboard](#).
- 8 Remove the [palm rest](#).
- 9 Remove the [system board](#).

## Procedure

- 1 Note the antenna cable routing and remove the cable from its routing guides.
- 2 Remove the screws that secure the display assembly to the computer base.

**3** Lift the display assembly off the computer base.

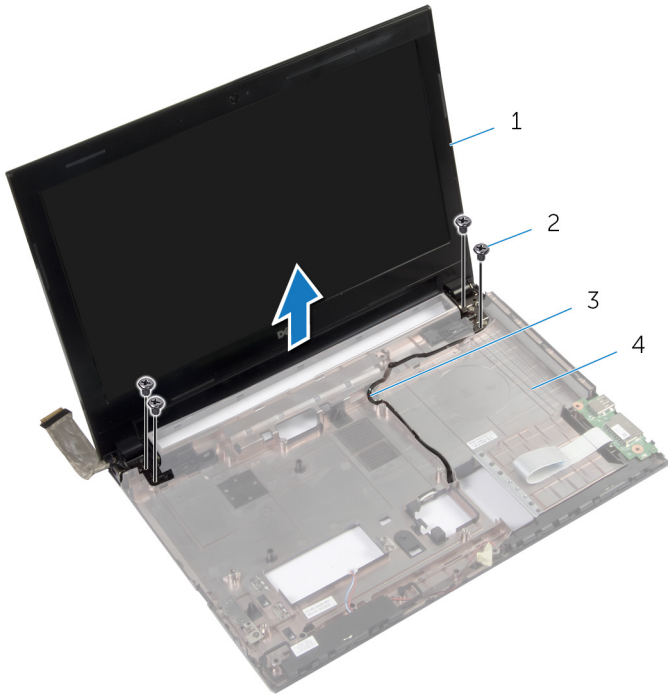

1 display assembly

2 screws (4)

3 antenna cable

4 computer base

# Replacing the Display Assembly

---



**WARNING:** Before working inside your computer, read the safety information that shipped with your computer and follow the steps in [Before Working Inside Your Computer](#). After working inside your computer, follow the instructions in [After Working Inside Your Computer](#). For more safety best practices, see the Regulatory Compliance home page at [dell.com/regulatory\\_compliance](http://dell.com/regulatory_compliance).

## Procedure

- 1 Place the display assembly on the computer base and align the screw holes on the display assembly with the screw holes on the computer base.
- 2 Replace the screws that secure the display assembly to the computer base.
- 3 Route the antenna cable through the routing guides on the computer base.

## Post-requisites

- 1 Replace the [system board](#).
- 2 Replace the [palm rest](#).
- 3 Replace the [hard drive](#).
- 4 Replace the [wireless card](#).
- 5 Replace the [memory module\(s\)](#).
- 6 Replace the [base cover](#).
- 7 Replace the [keyboard](#).
- 8 Replace the [optical drive](#).
- 9 Replace the [battery](#).

# Removing the Display Bezel

---



**WARNING:** Before working inside your computer, read the safety information that shipped with your computer and follow the steps in [Before Working Inside Your Computer](#). After working inside your computer, follow the instructions in [After Working Inside Your Computer](#). For more safety best practices, see the Regulatory Compliance home page at [dell.com/regulatory\\_compliance](http://dell.com/regulatory_compliance).

## Prerequisites

- 1 Remove the [battery](#).
- 2 Remove the [optical drive](#).
- 3 Remove the [base cover](#).
- 4 Remove the [memory module\(s\)](#).
- 5 Remove the [wireless card](#).
- 6 Remove the [hard drive](#).
- 7 Remove the [keyboard](#).
- 8 Remove the [palm rest](#).
- 9 Remove the [system board](#).
- 10 Remove the [display assembly](#).

# Procedure

- 1 Using your fingertips, carefully pry up the inside edge of the display bezel.
- 2 Remove the display bezel off the display back-cover.



1 display bezel

2 display back-cover



# Replacing the Display Bezel

---



**WARNING:** Before working inside your computer, read the safety information that shipped with your computer and follow the steps in [Before Working Inside Your Computer](#). After working inside your computer, follow the instructions in [After Working Inside Your Computer](#). For more safety best practices, see the Regulatory Compliance home page at [dell.com/regulatory\\_compliance](http://dell.com/regulatory_compliance).

## Procedure

- 1 Align the display bezel with the display back-cover, and gently snap the display bezel into place.
- 2 Align the hinge covers with the hinges on the display assembly and snap the hinge covers into place.

## Post-requisites

- 1 Replace the [display assembly](#).
- 2 Replace the [system board](#).
- 3 Replace the [palm rest](#).
- 4 Replace the [hard drive](#).
- 5 Replace the [wireless card](#).
- 6 Replace the [memory module\(s\)](#).
- 7 Replace the [base cover](#).
- 8 Replace the [keyboard](#).
- 9 Replace the [optical drive](#).
- 10 Replace the [battery](#).

# Removing the Display Hinges

---



**WARNING:** Before working inside your computer, read the safety information that shipped with your computer and follow the steps in [Before Working Inside Your Computer](#). After working inside your computer, follow the instructions in [After Working Inside Your Computer](#). For more safety best practices, see the Regulatory Compliance home page at [dell.com/regulatory\\_compliance](http://dell.com/regulatory_compliance).

## Prerequisites

- 1 Remove the [battery](#).
- 2 Remove the [optical drive](#).
- 3 Remove the [base cover](#).
- 4 Remove the [memory module\(s\)](#).
- 5 Remove the [wireless card](#).
- 6 Remove the [hard drive](#).
- 7 Remove the [keyboard](#).
- 8 Remove the [palm rest](#).
- 9 Remove the [system board](#).
- 10 Remove the [display assembly](#).
- 11 Remove the [display bezel](#).

# Procedure

- 1 Remove the screws that secure the display hinges to the display back-cover.
- 2 Lift the display hinges off the display back-cover.

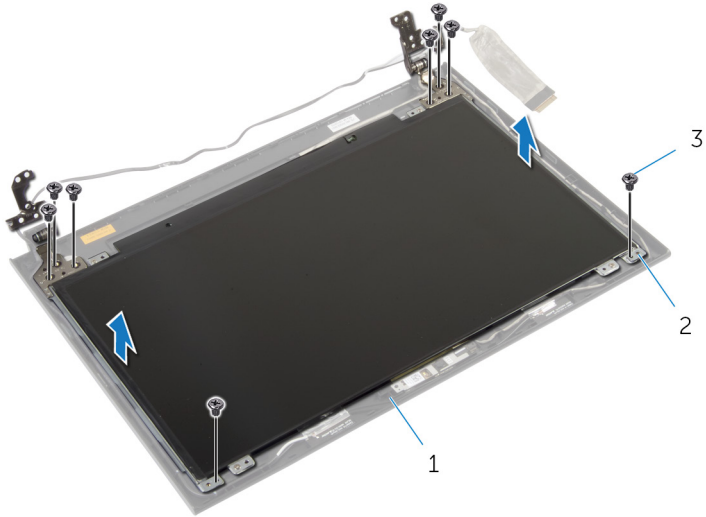

1 display back-cover

2 display hinges (2)

3 screws (8)

# Replacing the Display Hinges

---



**WARNING:** Before working inside your computer, read the safety information that shipped with your computer and follow the steps in [Before Working Inside Your Computer](#). After working inside your computer, follow the instructions in [After Working Inside Your Computer](#). For more safety best practices, see the Regulatory Compliance home page at [dell.com/regulatory\\_compliance](http://dell.com/regulatory_compliance).

## Procedure

- 1 Align the screw holes on the display hinges with the screw holes on the display back-cover.
- 2 Replace the screws that secure the display hinges to the display back-cover.

## Post-requisites

- 1 Replace the [display bezel](#).
- 2 Replace the [display assembly](#).
- 3 Replace the [system board](#).
- 4 Replace the [palm rest](#).
- 5 Replace the [hard drive](#).
- 6 Replace the [wireless card](#).
- 7 Replace the [memory module\(s\)](#).
- 8 Replace the [base cover](#).
- 9 Replace the [keyboard](#).
- 10 Replace the [optical drive](#).
- 11 Replace the [battery](#).

# Removing the Display Panel

---



**WARNING:** Before working inside your computer, read the safety information that shipped with your computer and follow the steps in [Before Working Inside Your Computer](#). After working inside your computer, follow the instructions in [After Working Inside Your Computer](#). For more safety best practices, see the Regulatory Compliance home page at [dell.com/regulatory\\_compliance](http://dell.com/regulatory_compliance).

## Prerequisites

- 1 Remove the [battery](#).
- 2 Remove the [optical drive](#).
- 3 Remove the [base cover](#).
- 4 Remove the [memory module\(s\)](#).
- 5 Remove the [wireless card](#).
- 6 Remove the [hard drive](#).
- 7 Remove the [keyboard](#).
- 8 Remove the [palm rest](#).
- 9 Remove the [system board](#).
- 10 Remove the [display assembly](#).
- 11 Remove the [display bezel](#).
- 12 Remove the [display hinges](#).

# Procedure

- 1 Remove the screws that secure the display panel to the display back-cover.
- 2 Gently lift the display panel and turn it over.

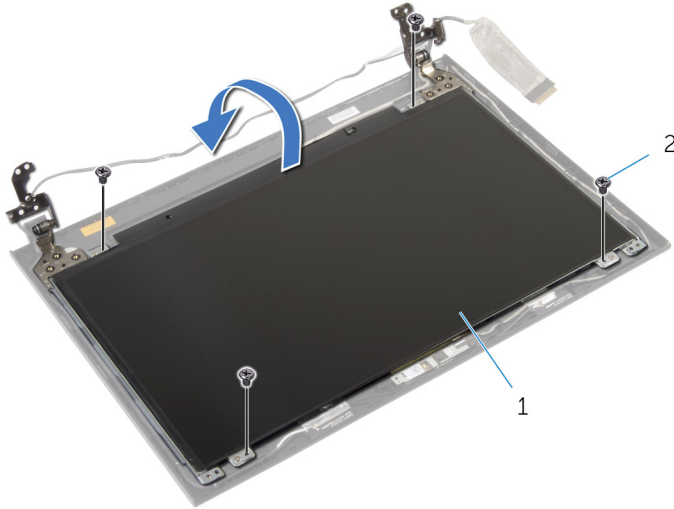

1 display panel

2 screws (4)

- 3 Peel the tape adhered over the display cable.

- 4 Disconnect the display cable from the display-panel cable connector.

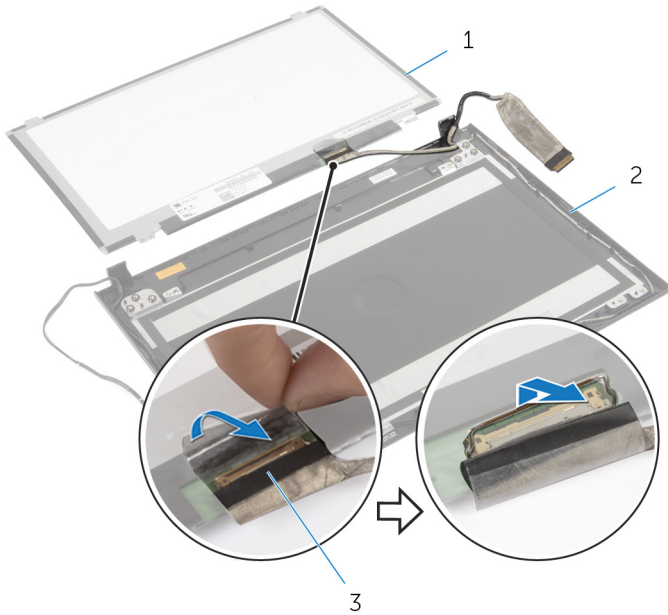

1 display panel

2 display back-cover

3 display cable

- 5 Lift the display panel away from the display back-cover.

# Replacing the Display Panel

---



**WARNING:** Before working inside your computer, read the safety information that shipped with your computer and follow the steps in [Before Working Inside Your Computer](#). After working inside your computer, follow the instructions in [After Working Inside Your Computer](#). For more safety best practices, see the Regulatory Compliance home page at [dell.com/regulatory\\_compliance](http://dell.com/regulatory_compliance).

## Procedure

- 1 Connect the display cable to the display-panel connector.
- 2 Adhere the tape that secures the display cable.
- 3 Gently place the display panel on the display back-cover and align the screw holes on the display panel with the screw holes on the display back-cover.
- 4 Replace the screws that secure the display panel to the display back-cover.

## Post-requisites

- 1 Replace the [display hinges](#).
- 2 Replace the [display bezel](#).
- 3 Replace the [display assembly](#).
- 4 Replace the [system board](#).
- 5 Replace the [palm rest](#).
- 6 Replace the [hard drive](#).
- 7 Replace the [wireless card](#).
- 8 Replace the [memory module\(s\)](#).
- 9 Replace the [base cover](#).
- 10 Replace the [keyboard](#).
- 11 Replace the [optical drive](#).
- 12 Replace the [battery](#).



# Removing the Camera

---



**WARNING:** Before working inside your computer, read the safety information that shipped with your computer and follow the steps in [Before Working Inside Your Computer](#). After working inside your computer, follow the instructions in [After Working Inside Your Computer](#). For more safety best practices, see the Regulatory Compliance home page at [dell.com/regulatory\\_compliance](http://dell.com/regulatory_compliance).

## Prerequisites

- 1 Remove the [battery](#).
- 2 Remove the [optical drive](#).
- 3 Remove the [base cover](#).
- 4 Remove the [memory module\(s\)](#).
- 5 Remove the [wireless card](#).
- 6 Remove the [hard drive](#).
- 7 Remove the [keyboard](#).
- 8 Remove the [palm rest](#).
- 9 Remove the [system board](#).
- 10 Remove the [display assembly](#).
- 11 Remove the [display bezel](#).

# Procedure

- 1 Disconnect the camera cable from the camera.
- 2 Lift the camera off the display back-cover.

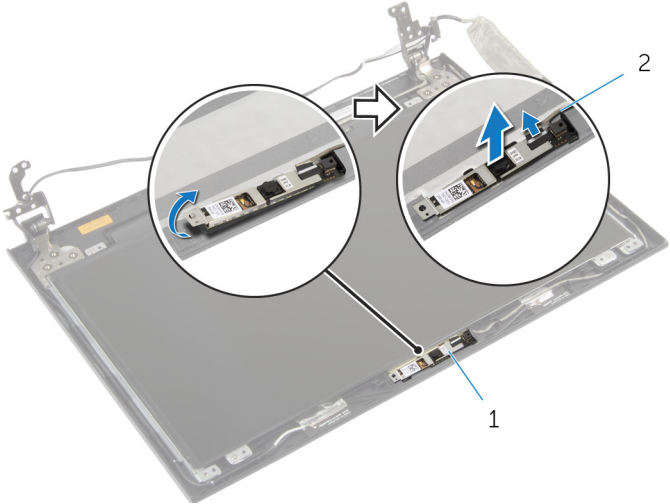

1 camera

2 camera cable

# Replacing the Camera

---



**WARNING:** Before working inside your computer, read the safety information that shipped with your computer and follow the steps in [Before Working Inside Your Computer](#). After working inside your computer, follow the instructions in [After Working Inside Your Computer](#). For more safety best practices, see the Regulatory Compliance home page at [dell.com/regulatory\\_compliance](http://dell.com/regulatory_compliance).

## Procedure

- 1 Using the alignment post, place the camera on the display back-cover.
- 2 Connect the camera cable to the camera connector.

## Post-requisites

- 1 Replace the [display bezel](#).
- 2 Replace the [display assembly](#).
- 3 Replace the [system board](#).
- 4 Replace the [palm rest](#).
- 5 Replace the [hard drive](#).
- 6 Replace the [wireless card](#).
- 7 Replace the [memory module\(s\)](#).
- 8 Replace the [base cover](#).
- 9 Replace the [keyboard](#).
- 10 Replace the [optical drive](#).
- 11 Replace the [battery](#).

# Flashing the BIOS

---

You may need to flash (update) the BIOS when an update is available or when you replace the system board. To flash the BIOS:

- 1 Turn on the computer.
- 2 Go to **dell.com/support**.
- 3 If you have your computer's Service Tag, type your computer's Service Tag and click **Submit**.  
If you do not have your computer's Service Tag, click **Detect My Product** to allow automatic detection of the Service Tag.  
 **NOTE:** If the Service Tag cannot be detected automatically, select your product under the product categories.
- 4 Click **Get Drivers and Downloads**.
- 5 Click **View All Drivers**.
- 6 In the **Operating System** drop-down, select the operating system installed on your computer.
- 7 Click **BIOS**.
- 8 Click **Download File** to download the latest version of the BIOS for your computer.
- 9 On the next page, select **Single-file download** and click **Continue**.
- 10 Save the file and once the download is complete, navigate to the folder where you saved the BIOS update file.
- 11 Double-click the BIOS update file icon and follow the instructions on the screen.