

Inspiron 13

7000 Series

Service Manual

Computer Model: Inspiron 13-7347
Regulatory Model: P57G
Regulatory Type: P57G001

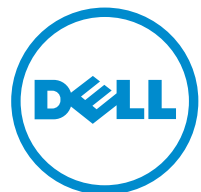

Notes, Cautions, and Warnings



NOTE: A NOTE indicates important information that helps you make better use of your computer.



CAUTION: A CAUTION indicates either potential damage to hardware or loss of data and tells you how to avoid the problem.



WARNING: A WARNING indicates a potential for property damage, personal injury, or death.

Copyright © 2014 Dell Inc. All rights reserved. This product is protected by U.S. and international copyright and intellectual property laws. Dell™ and the Dell logo are trademarks of Dell Inc. in the United States and/or other jurisdictions. All other marks and names mentioned herein may be trademarks of their respective companies.

2014 - 07

Rev. A00

Contents

Before Working Inside Your Computer.....	10
Before You Begin	10
Safety Instructions.....	10
Recommended Tools.....	11
After Working Inside Your Computer.....	12
Removing the Base Cover.....	13
Procedure.....	13
Replacing the Base Cover.....	14
Procedure.....	14
Removing the Battery.....	15
Prerequisites.....	15
Procedure.....	15
Replacing the Battery.....	17
Procedure.....	17
Post-requisites.....	17
Removing the Memory Module.....	18
Prerequisites.....	18
Procedure.....	18
Replacing the Memory Module.....	19
Procedure.....	19
Post-requisites.....	20

Removing the Hard Drive.....	21
Prerequisites.....	21
Procedure.....	21
Replacing the Hard Drive.....	23
Procedure.....	23
Post-requisites.....	23
Removing the Coin-Cell Battery.....	24
Prerequisites.....	24
Procedure.....	24
Replacing the Coin-Cell Battery.....	26
Procedure.....	26
Post-requisites.....	26
Removing the Wireless Card.....	27
Prerequisites.....	27
Procedure.....	27
Replacing the Wireless Card.....	29
Procedure.....	29
Post-requisites.....	29
Removing the Keyboard Daughter-Board.....	30
Prerequisites.....	30
Procedure.....	30
Replacing the Keyboard Daughter-Board.....	32
Procedure.....	32
Post-requisites.....	32

Removing the Power and Volume-Buttons Board.....	33
Prerequisites.....	33
Procedure.....	33
Replacing the Power and Volume-Buttons Board.....	35
Procedure.....	35
Post-requisites.....	35
Removing the Speakers.....	36
Prerequisites.....	36
Procedure.....	36
Replacing the Speakers.....	38
Procedure.....	38
Post-requisites.....	38
Removing the Touchpad.....	39
Prerequisites.....	39
Procedure.....	39
Replacing the Touchpad.....	42
Procedure.....	42
Post-requisites.....	42
Removing the Fan.....	43
Prerequisites.....	43
Procedure.....	43
Replacing the Fan.....	45
Procedure.....	45
Post-requisites.....	45

Removing the Heat Sink.....	46
Prerequisites.....	46
Procedure.....	46
Replacing the Heat Sink.....	48
Procedure.....	48
Post-requisites.....	48
Removing the I/O Board.....	49
Prerequisites.....	49
Procedure.....	49
Replacing the I/O Board.....	51
Procedure.....	51
Post-requisites.....	51
Removing the Power-Adapter Port.....	52
Prerequisites.....	52
Procedure.....	52
Replacing the Power-Adapter Port.....	54
Procedure.....	54
Post-requisites.....	54
Removing the System Board.....	55
Prerequisites.....	55
Procedure.....	55
Replacing the System Board.....	59
Procedure.....	59
Post-requisites.....	59
Entering the Service Tag in the BIOS.....	60

Removing the Display Assembly.....	61
Prerequisites.....	61
Procedure.....	61
Replacing the Display Assembly.....	64
Procedure.....	64
Post-requisites.....	64
Removing the Stylus-Holder Assembly.....	65
Prerequisites.....	65
Procedure.....	66
Replacing the Stylus-Holder Assembly.....	68
Procedure.....	68
Post-requisites.....	68
Removing the Palmrest and Keyboard Assembly.....	69
Prerequisites.....	69
Procedure.....	69
Replacing the Palmrest and Keyboard Assembly.....	71
Procedure.....	71
Post-requisites.....	71
Removing the Display Panel.....	72
Prerequisites.....	72
Procedure.....	72
Replacing the Display Panel.....	74
Procedure.....	74
Post-requisites.....	74

Removing the Display Back-Cover and Antenna Assembly.....	75
Prerequisites.....	75
Procedure.....	75
Replacing the Display Back-Cover and Antenna Assembly.....	77
Procedure.....	77
Post-requisites.....	77
Removing the Display Hinges.....	78
Prerequisites.....	78
Procedure.....	78
Replacing the Display Hinges.....	80
Procedure.....	80
Post-requisites.....	80
Removing the Camera.....	81
Prerequisites.....	81
Procedure.....	81
Replacing the Camera.....	83
Procedure.....	83
Post-requisites.....	83
Removing the Windows-Button Board.....	84
Prerequisites.....	84
Procedure.....	84
Replacing the Windows-Button Board.....	86
Procedure.....	86
Post-requisites.....	86



Removing the Display Cable.....	87
Prerequisites.....	87
Procedure.....	87
Replacing the Display Cable.....	89
Procedure.....	89
Post-requisites.....	89
Flashing the BIOS.....	90
Getting Help and Contacting Dell.....	91
Self-Help Resources.....	91
Contacting Dell.....	91

Before Working Inside Your Computer

 **CAUTION:** To avoid damaging the components and cards, handle them by their edges and avoid touching pins and contacts.

 **NOTE:** The images in this document may differ from your computer depending on the configuration you ordered.









Before You Begin

- 1 Save and close all open files and exit all open applications.
 - 2 Shut down your computer.
 - Windows 8.1: On the **Start** screen, click or tap the power icon  → **Shut down**.
 - Windows 7: Click or tap **Start** → **Shut down** .
-  **NOTE:** If you are using a different operating system, see the documentation of your operating system for shut-down instructions.
- 3 Disconnect your computer and all attached devices from their electrical outlets.
 - 4 Disconnect all cables such as telephone cables, network cables and so on, from your computer.
 - 5 Disconnect all attached devices and peripherals, such as keyboard, mouse, monitor, and so on, from your computer.
 - 6 Remove any media card and optical disc from your computer, if applicable.

Safety Instructions

Use the following safety guidelines to protect your computer from potential damage and ensure your personal safety.

 **WARNING:** Before working inside your computer, read the safety information that shipped with your computer. For more safety best practices, see the Regulatory Compliance home page at dell.com/regulatory_compliance.

-  **WARNING:** Disconnect all power sources before opening the computer cover or panels. After you finish working inside the computer, replace all covers, panels, and screws before connecting to the power source.
-  **CAUTION:** To avoid damaging the computer, make sure that the work surface is flat and clean.
-  **CAUTION:** To avoid damaging the components and cards, handle them by their edges and avoid touching pins and contacts.
-  **CAUTION:** Only a certified service technician is authorized to remove the computer cover and access any of the components inside the computer. See the safety instructions for complete information about safety precautions, working inside your computer, and protecting against electrostatic discharge.
-  **CAUTION:** Before touching anything inside your computer, ground yourself by touching an unpainted metal surface, such as the metal at the back of the computer. While you work, periodically touch an unpainted metal surface to dissipate static electricity, which could harm internal components.
-  **CAUTION:** When you disconnect a cable, pull on its connector or on its pull-tab, not on the cable itself. Some cables have connectors with locking tabs or thumb-screws that you must disengage before disconnecting the cable. When disconnecting cables, keep them evenly aligned to avoid bending any connector pins. When connecting cables, make sure that the ports and connectors are correctly oriented and aligned.
-  **CAUTION:** To disconnect a network cable, first unplug the cable from your computer and then unplug the cable from the network device.
-  **CAUTION:** Press and eject any installed card from the media-card reader.

Recommended Tools

The procedures in this document may require the following tools:

- Philips screwdriver
- Plastic scribe

After Working Inside Your Computer



CAUTION: Leaving stray or loose screws inside your computer may severely damage your computer.

- 1 Replace all screws and make sure that no stray screws remain inside your computer.
- 2 Connect any external devices, peripherals, and cables you removed before working on your computer.
- 3 Replace any media cards, discs, and any other part(s) that you removed before working on your computer.
- 4 Connect your computer and all attached devices to their electrical outlets.
- 5 Turn on your computer.

Removing the Base Cover

 **WARNING:** Before working inside your computer, read the safety information that shipped with your computer and follow the steps in [Before Working Inside Your Computer](#). After working inside your computer, follow the instructions in [After Working Inside Your Computer](#). For more safety best practices, see the Regulatory Compliance home page at dell.com/regulatory_compliance.

Procedure

- 1 Close the display and turn the computer over.
- 2 Remove the screws that secure the base cover to the computer.
- 3 Using a plastic scribe, pry the base cover away from the computer.

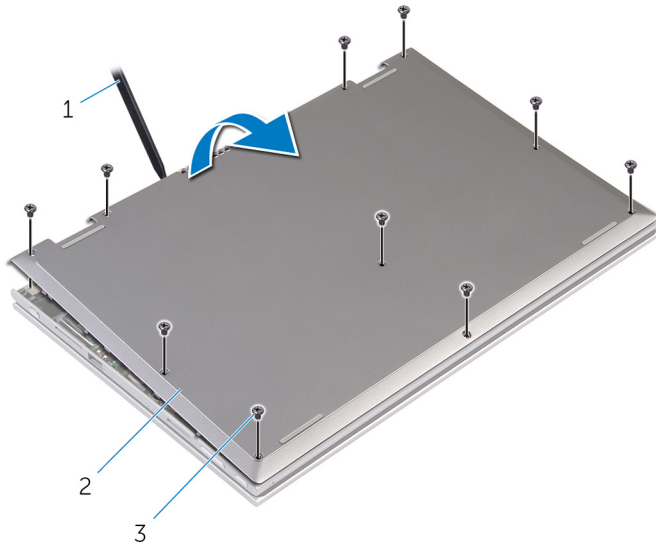

- 1 plastic scribe
- 2 base cover
- 3 screws (10)

Replacing the Base Cover



WARNING: Before working inside your computer, read the safety information that shipped with your computer and follow the steps in [Before Working Inside Your Computer](#). After working inside your computer, follow the instructions in [After Working Inside Your Computer](#). For more safety best practices, see the Regulatory Compliance home page at dell.com/regulatory_compliance.

Procedure

- 1 Slide the tabs on the base cover into the slots on the computer base and snap the base cover into place.
- 2 Replace the screws that secure the base cover to the computer base.

Removing the Battery

⚠ WARNING: Before working inside your computer, read the safety information that shipped with your computer and follow the steps in [Before Working Inside Your Computer](#). After working inside your computer, follow the instructions in [After Working Inside Your Computer](#). For more safety best practices, see the Regulatory Compliance home page at dell.com/regulatory_compliance.

Prerequisites

Remove the [base cover](#).

Procedure

- 1 Remove the screws that secure the battery to the palmrest and keyboard assembly.
- 2 Remove the hard-drive cable from the routing guides on the battery.
- 3 Lift the battery off the palmrest and keyboard assembly.

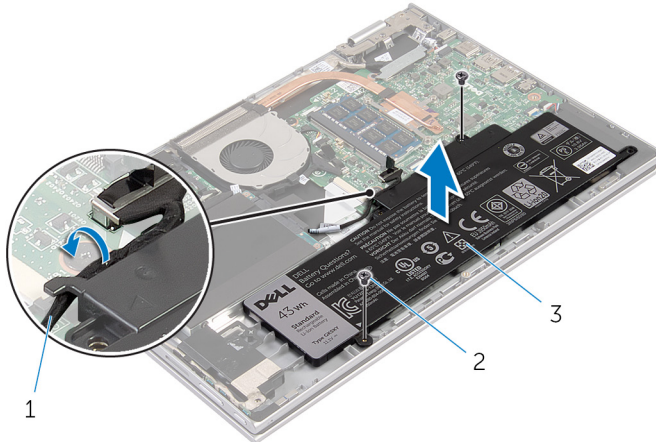

1 hard-drive cable

2 screws (2)

3 battery

- 4 Turn the computer over.

- 5 Press and hold the power button for 5 seconds, to ground the system board.

Replacing the Battery



WARNING: Before working inside your computer, read the safety information that shipped with your computer and follow the steps in [Before Working Inside Your Computer](#). After working inside your computer, follow the instructions in [After Working Inside Your Computer](#). For more safety best practices, see the Regulatory Compliance home page at dell.com/regulatory_compliance.

Procedure

- 1 Align the screw holes on the battery with the screw holes on the palmrest and keyboard assembly and place the battery on the palmrest and keyboard assembly.
- 2 Route the hard-drive cable through the routing guides on the battery.
- 3 Replace the screws that secure the battery to the palmrest and keyboard assembly.

Post-requisites

Replace the [base cover](#).

Removing the Memory Module

! **WARNING:** Before working inside your computer, read the safety information that shipped with your computer and follow the steps in [Before Working Inside Your Computer](#). After working inside your computer, follow the instructions in [After Working Inside Your Computer](#). For more safety best practices, see the Regulatory Compliance home page at dell.com/regulatory_compliance.

Prerequisites

- 1 Remove the [base cover](#).
- 2 Remove the [battery](#).

Procedure

- 1 Use your fingertips to carefully spread apart the securing-clips on each end of the memory-module slot until the memory module pops up.
- 2 Remove the memory module from the memory-module slot.

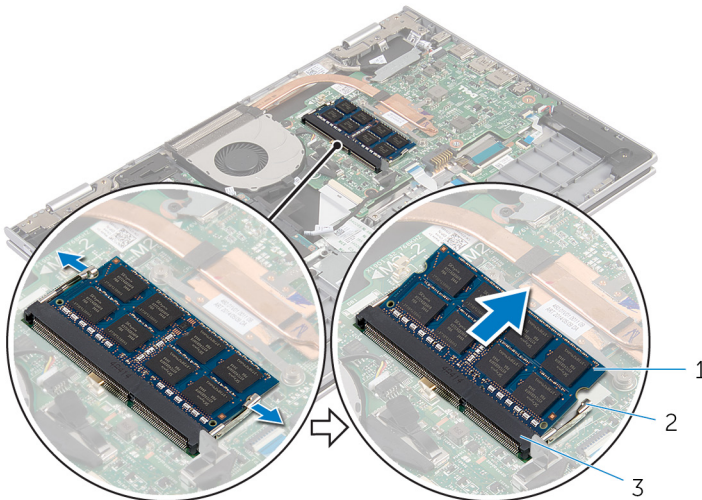

- 1 memory module
- 2 securing clips (2)
- 3 memory-module slot

Replacing the Memory Module

⚠ WARNING: Before working inside your computer, read the safety information that shipped with your computer and follow the steps in [Before Working Inside Your Computer](#). After working inside your computer, follow the instructions in [After Working Inside Your Computer](#). For more safety best practices, see the Regulatory Compliance home page at dell.com/regulatory_compliance.

Procedure

- 1 Align the notch on the memory module with the tab on the memory-module slot.
- 2 Slide the memory module firmly into the slot at an angle and press the memory module down until it clicks into place.

✎ NOTE: If you do not hear the click, remove the memory module and reinstall it.

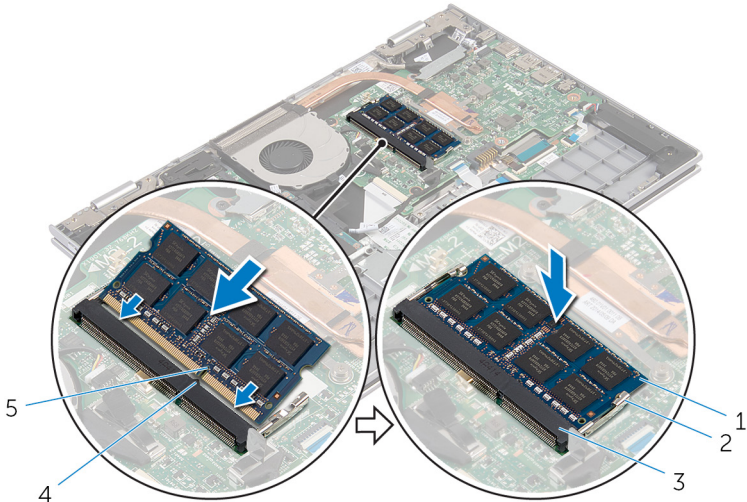

- | | | | |
|---|--------------------|---|--------------------|
| 1 | memory module | 2 | securing clips (2) |
| 3 | memory-module slot | 4 | tab |
| 5 | notch | | |

Post-requisites

- 1 Replace the [battery](#).
- 2 Replace the [base cover](#).

Removing the Hard Drive

 **WARNING:** Before working inside your computer, read the safety information that shipped with your computer and follow the steps in [Before Working Inside Your Computer](#). After working inside your computer, follow the instructions in [After Working Inside Your Computer](#). For more safety best practices, see the Regulatory Compliance home page at dell.com/regulatory_compliance.

 **CAUTION:** Hard drives are fragile. Exercise care when handling the hard drive.

 **CAUTION:** To avoid data loss, do not remove the hard drive while the computer is in Sleep or On state.

Prerequisites

- 1 Remove the [base cover](#).
- 2 Remove the [battery](#).

Procedure

- 1 Remove the screws that secure the hard-drive assembly to the palmrest and keyboard assembly.
- 2 Using the pull tab, disconnect the hard-drive cable from the system board.

- 3** Lift the hard-drive assembly along with its cable off the palmrest and keyboard assembly.

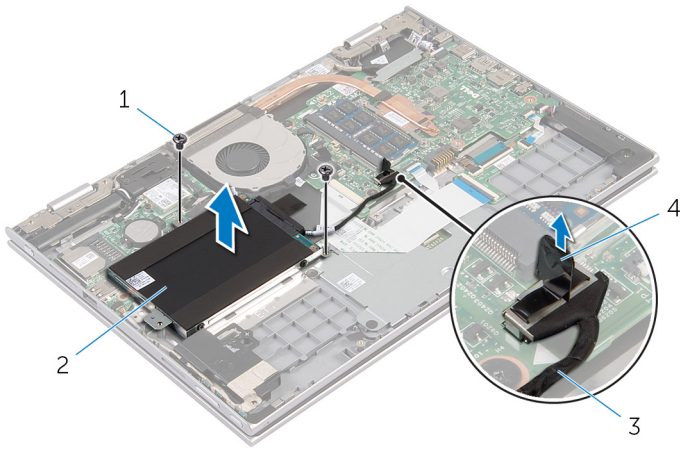

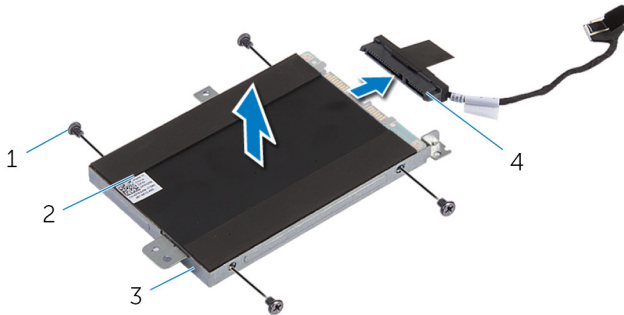

- | | | | |
|---|------------------|---|---------------------|
| 1 | screws (2) | 2 | hard-drive assembly |
| 3 | hard-drive cable | 4 | pull tab |

- 4** Disconnect the interposer from the hard drive.
5 Remove the screws that secure the hard-drive bracket to the hard drive.
6 Lift the hard-drive bracket from the hard drive.



- | | | | |
|---|--------------------|---|------------|
| 1 | screws (4) | 2 | hard drive |
| 3 | hard-drive bracket | 4 | interposer |

Replacing the Hard Drive

-  **WARNING:** Before working inside your computer, read the safety information that shipped with your computer and follow the steps in [Before Working Inside Your Computer](#). After working inside your computer, follow the instructions in [After Working Inside Your Computer](#). For more safety best practices, see the Regulatory Compliance home page at dell.com/regulatory_compliance.
-  **CAUTION:** Hard drives are fragile. Exercise care when handling the hard drive.

Procedure

- 1 Align the screw holes on the hard drive with the screw holes on the hard-drive bracket.
- 2 Replace the screws that secure the hard-drive bracket to the hard drive.
- 3 Connect the interposer to the hard drive.
- 4 Align the screw holes on the hard-drive assembly with the screw holes on the palmrest and keyboard assembly.
- 5 Replace the screws that secure the hard-drive assembly to the palmrest and keyboard assembly.
- 6 Connect the hard-drive cable to the system board.

Post-requisites

- 1 Replace the [battery](#).
- 2 Replace the [base cover](#).

Removing the Coin-Cell Battery

 **WARNING:** Before working inside your computer, read the safety information that shipped with your computer and follow the steps in [Before Working Inside Your Computer](#). After working inside your computer, follow the instructions in [After Working Inside Your Computer](#). For more safety best practices, see the Regulatory Compliance home page at dell.com/regulatory_compliance.

 **CAUTION:** Removing the coin-cell battery resets the BIOS settings to default. It is recommended that you note the BIOS settings before removing the coin-cell battery.

Prerequisites

- 1 Remove the [base cover](#).
- 2 Remove the [battery](#).

Procedure

Using a plastic scribe, gently pry the coin-cell battery out of the battery socket on the system board.

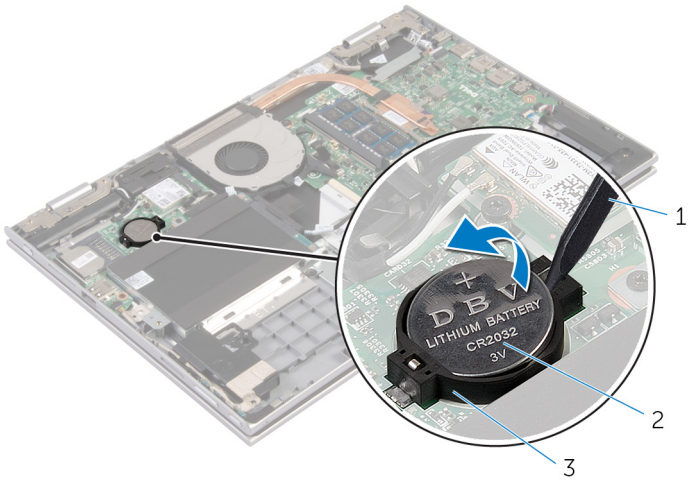

- 1 plastic scribe
- 3 battery socket

- 2 coin-cell battery

Replacing the Coin-Cell Battery

 **WARNING:** Before working inside your computer, read the safety information that shipped with your computer and follow the steps in [Before Working Inside Your Computer](#). After working inside your computer, follow the instructions in [After Working Inside Your Computer](#). For more safety best practices, see the Regulatory Compliance home page at dell.com/regulatory_compliance.

Procedure

With the positive-side facing up, snap the coin-cell battery into the battery socket on the system board.

Post-requisites

- 1 Replace the [battery](#).
- 2 Replace the [base cover](#).

Removing the Wireless Card



WARNING: Before working inside your computer, read the safety information that shipped with your computer and follow the steps in [Before Working Inside Your Computer](#). After working inside your computer, follow the instructions in [After Working Inside Your Computer](#). For more safety best practices, see the Regulatory Compliance home page at dell.com/regulatory_compliance.

Prerequisites

- 1 Remove the [base cover](#).
- 2 Remove the [battery](#).

Procedure

- 1 Disconnect the antenna cables from the wireless card.
- 2 Remove the screw that secures the wireless card to the system board.

3 Slide the wireless card from the wireless-card slot on the system board.

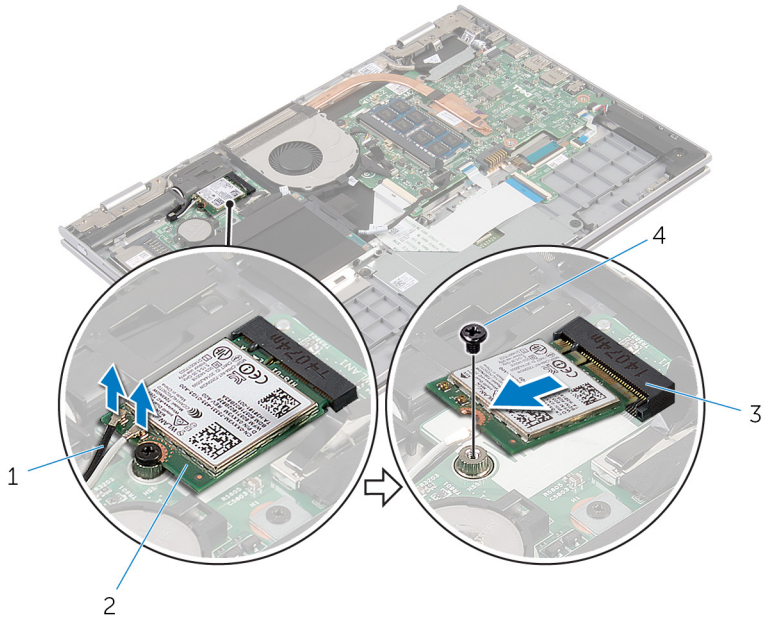

- 1 antenna cables (2)
- 3 wireless-card slot

- 2 wireless card
- 4 screw

Replacing the Wireless Card

 **WARNING:** Before working inside your computer, read the safety information that shipped with your computer and follow the steps in [Before Working Inside Your Computer](#). After working inside your computer, follow the instructions in [After Working Inside Your Computer](#). For more safety best practices, see the Regulatory Compliance home page at dell.com/regulatory_compliance.

Procedure

 **CAUTION:** To avoid damage to the wireless card, do not place any cables under it.

- 1 Align the notch on the wireless card with the tab on the wireless-card slot on the system board.
- 2 Insert the wireless card at an angle into the wireless-card slot.
- 3 Align the screw hole on the wireless card with the screw hole on the system board.
- 4 Replace the screw that secures the wireless card to the system board.
- 5 Connect the antenna cables to the wireless card.

The following table provides the antenna-cable color scheme for the wireless card supported by your computer.

Connectors on the wireless card	Antenna-cable color
Main (white triangle)	white
Auxiliary (black triangle)	black

Post-requisites

- 1 Replace the [battery](#).
- 2 Replace the [base cover](#).

Removing the Keyboard Daughter-Board

 **WARNING:** Before working inside your computer, read the safety information that shipped with your computer and follow the steps in [Before Working Inside Your Computer](#). After working inside your computer, follow the instructions in [After Working Inside Your Computer](#). For more safety best practices, see the Regulatory Compliance home page at dell.com/regulatory_compliance.

Prerequisites

- 1 Remove the [base cover](#).
- 2 Remove the [battery](#).

Procedure

- 1 Lift the connector latches and disconnect the keyboard cables and keyboard-backlit cables from the keyboard daughter-board.

2 Lift the keyboard daughter-board off the palmrest and keyboard assembly.

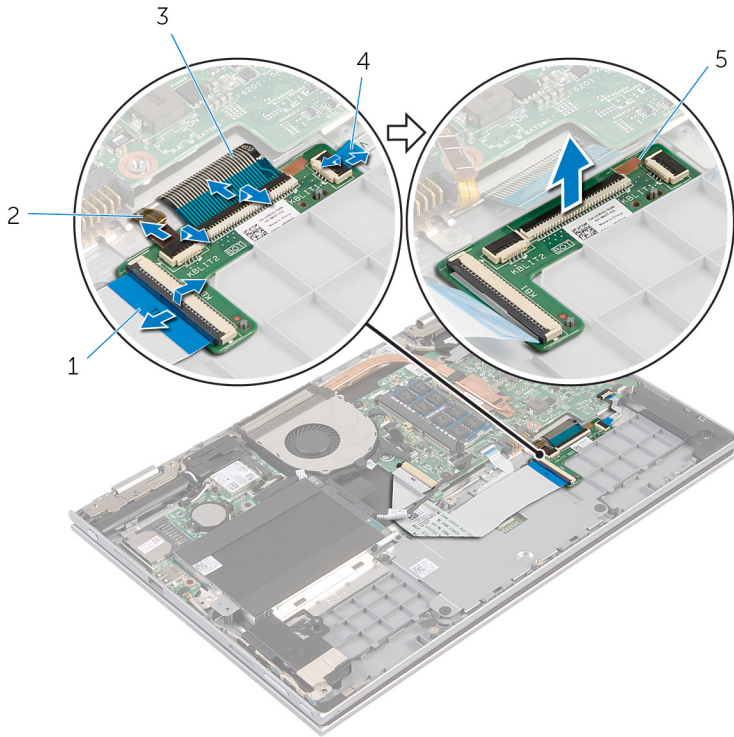

- | | | | |
|---|-------------------------|---|------------------------|
| 1 | keyboard cable | 2 | keyboard-backlit cable |
| 3 | keyboard cable | 4 | keyboard-backlit cable |
| 5 | keyboard daughter-board | | |

Replacing the Keyboard Daughter-Board



WARNING: Before working inside your computer, read the safety information that shipped with your computer and follow the steps in [Before Working Inside Your Computer](#). After working inside your computer, follow the instructions in [After Working Inside Your Computer](#). For more safety best practices, see the Regulatory Compliance home page at dell.com/regulatory_compliance.

Procedure

- 1 Place the keyboard daughter board on the palmrest and keyboard assembly.
- 2 Connect the keyboard cables and keyboard-backlit cables and press down the latches to secure the cables.

Post-requisites

- 1 Replace the [battery](#).
- 2 Replace the [base cover](#).

Removing the Power and Volume-Buttons Board



WARNING: Before working inside your computer, read the safety information that shipped with your computer and follow the steps in [Before Working Inside Your Computer](#). After working inside your computer, follow the instructions in [After Working Inside Your Computer](#). For more safety best practices, see the Regulatory Compliance home page at dell.com/regulatory_compliance.

Prerequisites

- 1 Remove the [base cover](#).
- 2 Remove the [battery](#).
- 3 Follow the procedure from step 1 to step 3 in “Removing the [Hard Drive](#)”.

Procedure

- 1 Peel off the adhesive tape that secures the power and volume-buttons board cable to the palmrest and keyboard assembly
- 2 Disconnect the power and volume-buttons board cable from the system board.
- 3 Remove the power and volume-buttons board cable from the routing guides on the speaker.
- 4 Peel off adhesive the tape that secures the power and volume-buttons board to the speaker.

5 Lift the power and volume-buttons board along with its cable, off the palmrest and keyboard assembly.

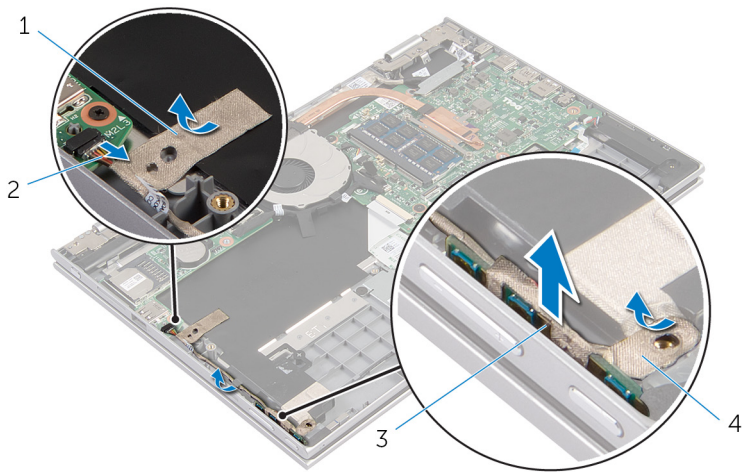

- | | | | |
|---|--------------------------------|---|--------------------------------------|
| 1 | adhesive tape | 2 | power and volume-buttons board cable |
| 3 | power and volume-buttons board | 4 | adhesive tape |

Replacing the Power and Volume-Buttons Board



WARNING: Before working inside your computer, read the safety information that shipped with your computer and follow the steps in [Before Working Inside Your Computer](#). After working inside your computer, follow the instructions in [After Working Inside Your Computer](#). For more safety best practices, see the Regulatory Compliance home page at dell.com/regulatory_compliance.

Procedure

- 1 Place the power and volume-buttons board into the slot on the palmrest and keyboard assembly.
- 2 Adhere the adhesive tape that secures the power and volume-buttons board to the speaker.
- 3 Route the power and volume-buttons board cable through the routing guides on the speaker.
- 4 Connect the power and volume-buttons board cable to the system board.
- 5 Adhere the adhesive tape that secures the power and volume-buttons board cable to the palmrest and keyboard assembly.

Post-requisites

- 1 Follow the procedure from step 4 to step 6 in "Replacing the [Hard Drive](#)".
- 2 Replace the [battery](#).
- 3 Replace the [base cover](#).

Removing the Speakers



WARNING: Before working inside your computer, read the safety information that shipped with your computer and follow the steps in [Before Working Inside Your Computer](#). After working inside your computer, follow the instructions in [After Working Inside Your Computer](#). For more safety best practices, see the Regulatory Compliance home page at dell.com/regulatory_compliance.

Prerequisites

- 1 Remove the [base cover](#).
- 2 Remove the [battery](#).
- 3 Remove the [power and volume-buttons board](#).

Procedure

- 1 Disconnect the speaker cable from the system board.
- 2 Peel off the adhesive tape that secure the speaker cable to the palmrest and keyboard assembly.
- 3 Remove the speaker cable from the routing guides on the palmrest and keyboard assembly.

- 4 Release the speakers from the alignment posts and lift the speakers along with its cable off the palmrest and keyboard assembly.

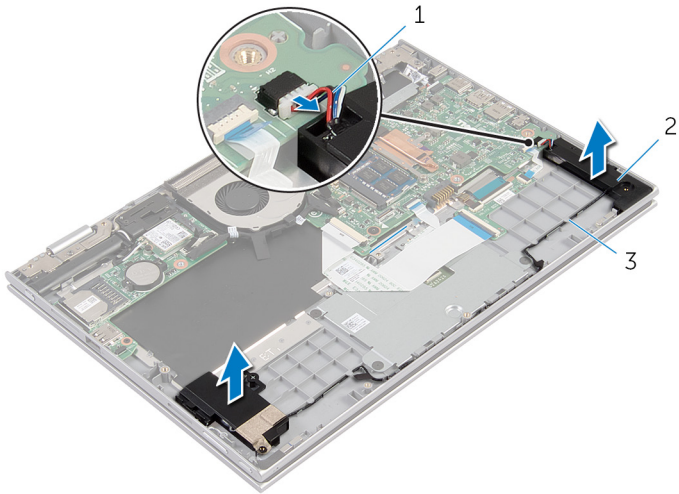

- 1 speaker cable
- 3 routing guides

- 2 speakers (2)

Replacing the Speakers



WARNING: Before working inside your computer, read the safety information that shipped with your computer and follow the steps in [Before Working Inside Your Computer](#). After working inside your computer, follow the instructions in [After Working Inside Your Computer](#). For more safety best practices, see the Regulatory Compliance home page at dell.com/regulatory_compliance.

Procedure

- 1 Using the alignment posts on the palmrest and keyboard assembly, place the speakers on the palmrest and keyboard assembly.
- 2 Route the speaker cable through the routing guides on the palmrest and keyboard assembly.
- 3 Adhere the adhesive tapes that secure the speaker cable on the palmrest and keyboard assembly.
- 4 Connect the speaker cable to the system board.

Post-requisites

- 1 Replace the [power and volume-buttons board](#).
- 2 Replace the [battery](#).
- 3 Replace the [base cover](#).

Removing the Touchpad

⚠ WARNING: Before working inside your computer, read the safety information that shipped with your computer and follow the steps in [Before Working Inside Your Computer](#). After working inside your computer, follow the instructions in [After Working Inside Your Computer](#). For more safety best practices, see the Regulatory Compliance home page at dell.com/regulatory_compliance.

Prerequisites

- 1 Remove the [base cover](#).
- 2 Remove the [battery](#).

Procedure

- 1 Lift the connector latch and disconnect the keyboard cable from the keyboard daughter-board.

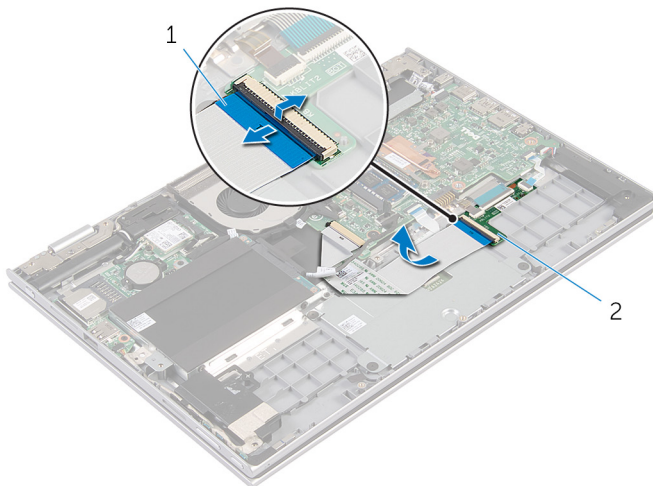

1 keyboard cable

2 keyboard daughter-board

- 2 Lift the connector latch and disconnect the touchpad cable from the touchpad.

- 3 Remove the screws that secure the touchpad bracket to the palmrest and keyboard assembly.
- 4 Lift the touchpad bracket off the palmrest and keyboard assembly.

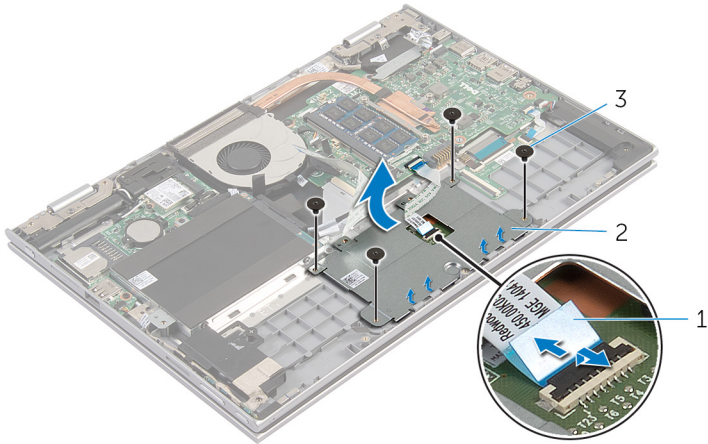

1 touchpad cable

2 touchpad bracket

3 screws (4)

- 5 Peel off the adhesive tape that secures the touchpad to the palmrest and keyboard assembly.

6 Lift the touchpad away from the computer.

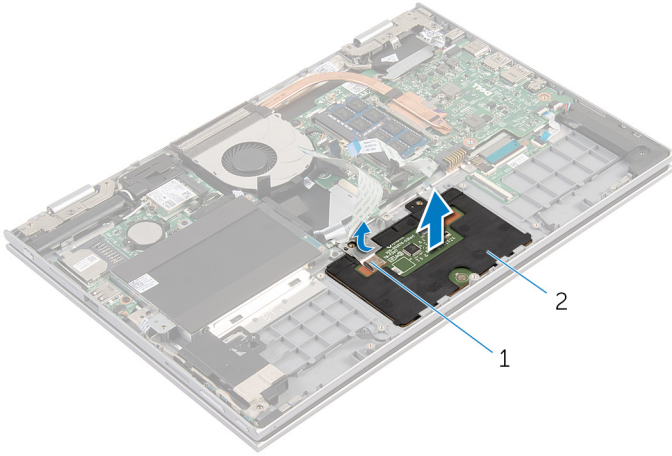

1 adhesive tape

2 touchpad

Replacing the Touchpad



WARNING: Before working inside your computer, read the safety information that shipped with your computer and follow the steps in [Before Working Inside Your Computer](#). After working inside your computer, follow the instructions in [After Working Inside Your Computer](#). For more safety best practices, see the Regulatory Compliance home page at dell.com/regulatory_compliance.

Procedure

- 1 Slide the tabs on the touchpad into the slots on the palmrest and keyboard assembly.
- 2 Adhere the adhesive tape that secures the touchpad to the palmrest and keyboard assembly.
- 3 Align the screw holes on the touchpad bracket with the screw holes on the palmrest and keyboard assembly.
- 4 Replace the screws that secure the touchpad bracket to the palmrest and keyboard assembly.
- 5 Slide the touchpad cable into the touchpad connector and press down the latch to secure the cable.
- 6 Slide the keyboard cable into the keyboard daughter-board connector and press down the latch to secure the cable.

Post-requisites

- 1 Replace the [battery](#).
- 2 Replace the [base cover](#).

Removing the Fan

⚠ WARNING: Before working inside your computer, read the safety information that shipped with your computer and follow the steps in [Before Working Inside Your Computer](#). After working inside your computer, follow the instructions in [After Working Inside Your Computer](#). For more safety best practices, see the Regulatory Compliance home page at dell.com/regulatory_compliance.

Prerequisites

- 1 Remove the [base cover](#).
- 2 Remove the [battery](#).

Procedure

- 1 Lift the latch and disconnect the I/O-board cable from the system board.
- 2 Remove the I/O board cable from the routing guides on the fan.

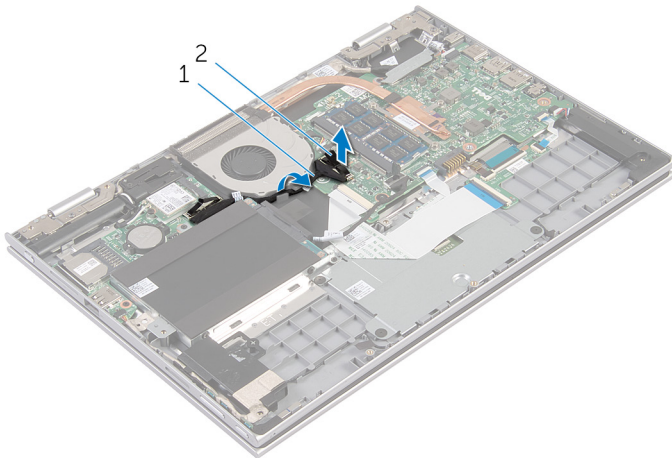

1 I/O-board cable

2 I/O-board cable
connector

- 3 Disconnect the fan cable from the system board.

- 4 Remove the screws that secure the fan to the palmrest and keyboard assembly.
- 5 Lift the fan off the palmrest and keyboard assembly.

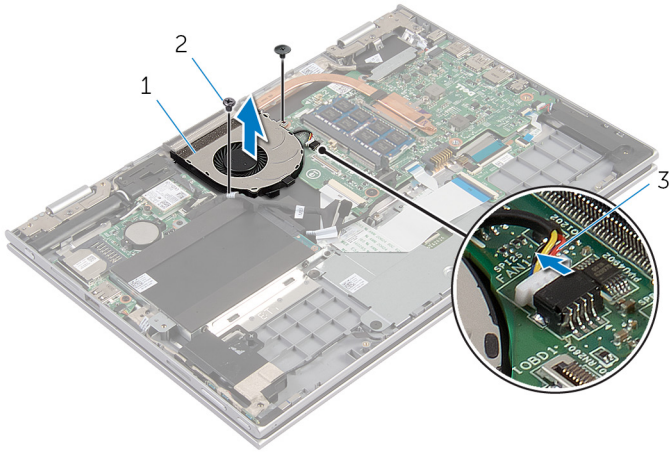

- 1 fan
- 3 fan cable

2 screws (2)

Replacing the Fan



WARNING: Before working inside your computer, read the safety information that shipped with your computer and follow the steps in [Before Working Inside Your Computer](#). After working inside your computer, follow the instructions in [After Working Inside Your Computer](#). For more safety best practices, see the Regulatory Compliance home page at dell.com/regulatory_compliance.



Procedure

- 1 Align the screw holes on the fan with the screw holes on the palmrest and keyboard assembly.
- 2 Replace the screws that secure the fan to the palmrest and keyboard assembly.
- 3 Connect the fan cable to the system board.
- 4 Route the I/O-board cable through the routing guides on the fan.
- 5 Slide the I/O-board cable into the I/O-board cable connector on the system board and press down the latch to secure the cable.

Post-requisites

- 1 Replace the [battery](#).
- 2 Replace the [base cover](#).

Removing the Heat Sink

-  **WARNING:** Before working inside your computer, read the safety information that shipped with your computer and follow the steps in [Before Working Inside Your Computer](#). After working inside your computer, follow the instructions in [After Working Inside Your Computer](#). For more safety best practices, see the Regulatory Compliance home page at dell.com/regulatory_compliance.
-  **WARNING:** The heat sink may become hot during normal operation. Allow sufficient time for the heat sink to cool before you touch it.
-  **CAUTION:** To ensure maximum cooling for the processor, do not touch the heat transfer areas on the heat sink. The oils in your skin can reduce the heat transfer capability of the thermal grease.

Prerequisites

- 1 Remove the [base cover](#).
- 2 Remove the [battery](#).

Procedure

- 1 In sequential order (as indicated on the heat sink), loosen the captive screws that secure the heat sink to the system board.

2 Lift the heat sink off the system board.

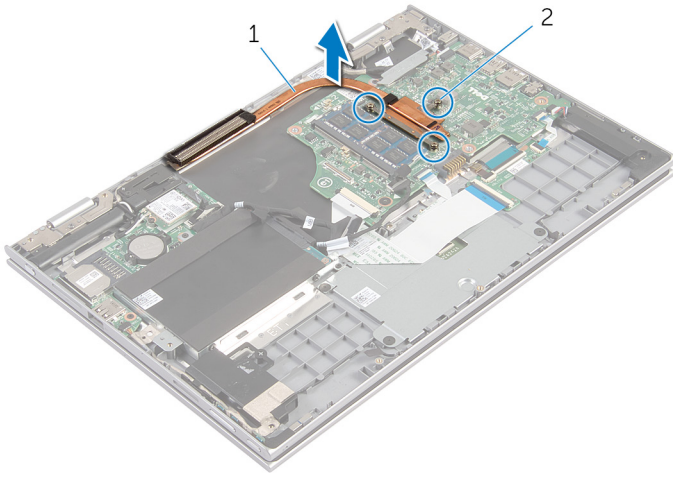



1 heat sink

2 captive screws (3)

Replacing the Heat Sink

 **WARNING:** Before working inside your computer, read the safety information that shipped with your computer and follow the steps in [Before Working Inside Your Computer](#). After working inside your computer, follow the instructions in [After Working Inside Your Computer](#). For more safety best practices, see the Regulatory Compliance home page at dell.com/regulatory_compliance.

 **CAUTION:** Incorrect alignment of the heat sink can cause damage to the system board and processor.

 **NOTE:** The original thermal grease can be reused if the original system board and heat sink are reinstalled together. If either the system board or the heat sink is replaced, use the thermal pad provided in the kit to make sure that thermal conductivity is achieved.

Procedure

- 1 Align the screw holes on the heat sink with the screw holes on the system board.
- 2 In sequential order (indicated on the heat sink), tighten the captive screws that secure the heat sink to the system board.

Post-requisites

- 1 Replace the [battery](#).
- 2 Replace the [base cover](#).

Removing the I/O Board



WARNING: Before working inside your computer, read the safety information that shipped with your computer and follow the steps in [Before Working Inside Your Computer](#). After working inside your computer, follow the instructions in [After Working Inside Your Computer](#). For more safety best practices, see the Regulatory Compliance home page at dell.com/regulatory_compliance.

Prerequisites

- 1 Remove the [base cover](#).
- 2 Remove the [battery](#).
- 3 Remove the [hard drive](#).
- 4 Remove the [wireless card](#).
- 5 Remove the [coin-cell battery](#).

Procedure

- 1 Disconnect the I/O-board cable from the I/O board.
- 2 Disconnect the power and volume-buttons board cable from the I/O board.
- 3 Remove the screw that secures the I/O board to the palmrest and keyboard assembly.

4 Lift the I/O board off the palmrest and keyboard assembly.

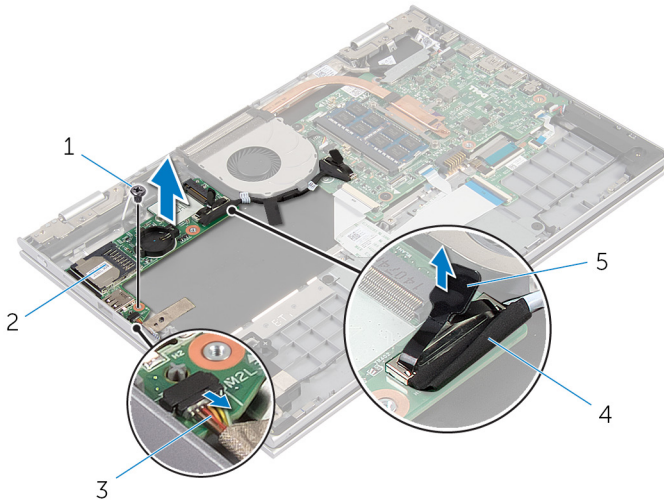

1 screw

2 I/O-board

3 power and volume-buttons
board cable

4 I/O-board cable

5 pull tab

Replacing the I/O Board



WARNING: Before working inside your computer, read the safety information that shipped with your computer and follow the steps in [Before Working Inside Your Computer](#). After working inside your computer, follow the instructions in [After Working Inside Your Computer](#). For more safety best practices, see the Regulatory Compliance home page at dell.com/regulatory_compliance.

Procedure

- 1 Using the alignment posts, place the I/O board on the palmrest and keyboard assembly.
- 2 Align the screw hole on the I/O board with the screw hole on the palmrest and keyboard assembly.
- 3 Replace the screw that secures the I/O board to the palmrest and keyboard assembly.
- 4 Connect the power and volume-buttons board cable to the I/O board.
- 5 Connect the I/O-board cable to the I/O board.

Post-requisites

- 1 Replace the [coin-cell battery](#).
- 2 Replace the [wireless card](#).
- 3 Replace the [hard drive](#).
- 4 Replace the [battery](#).
- 5 Replace the [base cover](#).

Removing the Power-Adapter Port



WARNING: Before working inside your computer, read the safety information that shipped with your computer and follow the steps in [Before Working Inside Your Computer](#). After working inside your computer, follow the instructions in [After Working Inside Your Computer](#). For more safety best practices, see the Regulatory Compliance home page at dell.com/regulatory_compliance.

Prerequisites

- 1 Remove the [base cover](#).
- 2 Remove the [battery](#).

Procedure

- 1 Disconnect the power-adapter port cable from the system board.
- 2 Remove the screw that secures the power-adapter port to the palmrest and keyboard assembly.

- 3** Lift the power-adapter port with its cable, off the palmrest and keyboard assembly.

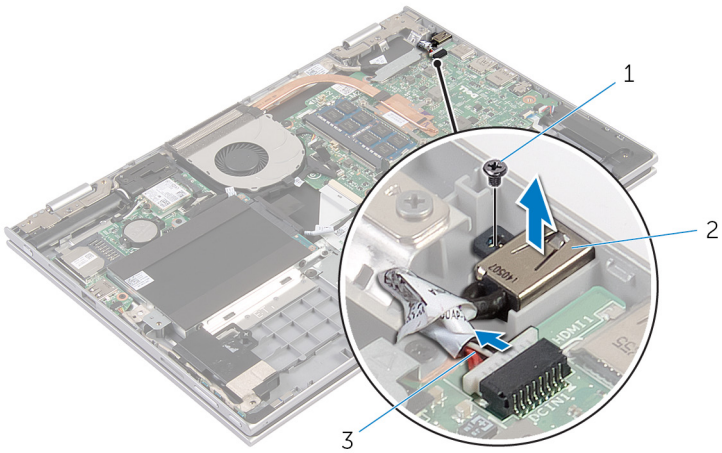

1 screw

2 power-adapter port

3 power-adapter port cable

Replacing the Power-Adapter Port



WARNING: Before working inside your computer, read the safety information that shipped with your computer and follow the steps in [Before Working Inside Your Computer](#). After working inside your computer, follow the instructions in [After Working Inside Your Computer](#). For more safety best practices, see the Regulatory Compliance home page at dell.com/regulatory_compliance.

Procedure

- 1 Place the power-adapter port into the slot on the palmrest and keyboard assembly.
- 2 Align the screw hole on the power-adapter port with the screw hole on the palmrest and keyboard assembly.
- 3 Connect the power-adapter port cable to the system board.

Post-requisites

- 1 Replace the [battery](#).
- 2 Replace the [base cover](#).

Removing the System Board



WARNING: Before working inside your computer, read the safety information that shipped with your computer and follow the steps in [Before Working Inside Your Computer](#). After working inside your computer, follow the instructions in [After Working Inside Your Computer](#). For more safety best practices, see the Regulatory Compliance home page at dell.com/regulatory_compliance.



NOTE: Your computer's Service Tag is stored in the system board. You must enter the Service Tag in the BIOS setup program after you replace the system board.



NOTE: Replacing the system board removes any changes you have made to the BIOS using the BIOS setup program. You must make the desired changes again after you replace the system board.



NOTE: Before disconnecting the cables from the system board, note the location of the connectors so that you can reconnect them correctly after you replace the system board.

Prerequisites

- 1 Remove the [base cover](#).
- 2 Remove the [battery](#).
- 3 Remove the [memory module](#).
- 4 Remove the [fan](#).
- 5 Remove the [heat sink](#).

Procedure

- 1 Remove the screws that secure the display-cable bracket to the system board and lift the display-cable bracket off the system board.
- 2 Using the pull tab disconnect the display cable from the system board.

- 3** Peel off the adhesive tape on the Windows-button board connector and disconnect the Windows-button board cable from the connector.

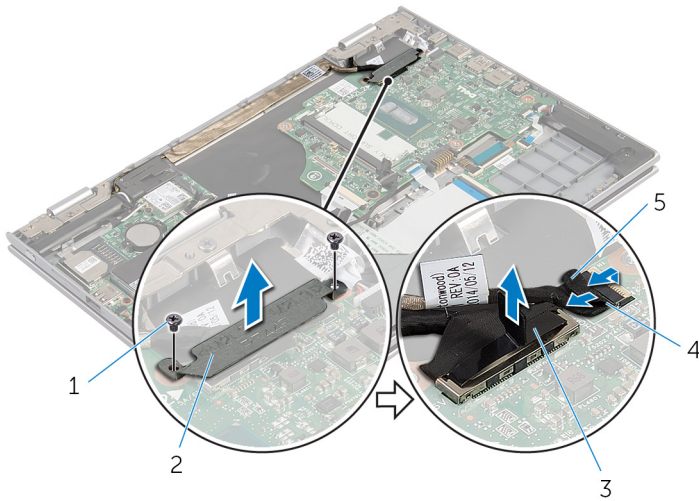

- | | | | |
|---|---------------|---|----------------------------|
| 1 | screws (2) | 2 | display-cable bracket |
| 3 | display cable | 4 | windows-button board cable |
| 5 | adhesive tape | | |

- 4** Using the pull tab disconnect the keyboard cable and the hard-drive cable from the system board.
- 5** Release the connector latch and disconnect the keyboard-backlit cable from the system board.
- 6** Lift the connector latch and disconnect the touchpad cable from the system board.

- 7 Disconnect the speaker cable and the power-adapter port cable from the system board.

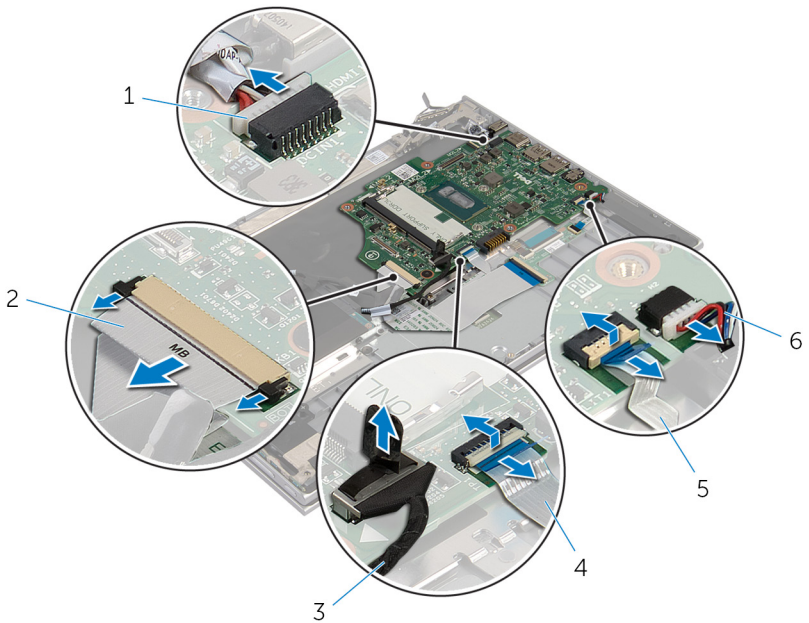

- | | | | |
|---|--------------------------|---|----------------|
| 1 | power-adapter port cable | 2 | keyboard cable |
| 3 | hard-drive cable | 4 | touchpad cable |
| 5 | keyboard-backlit cable | 6 | speaker cable |

- 8** Remove the screw that secures the system board to the palmrest and keyboard assembly and lift it off the palmrest and keyboard assembly.

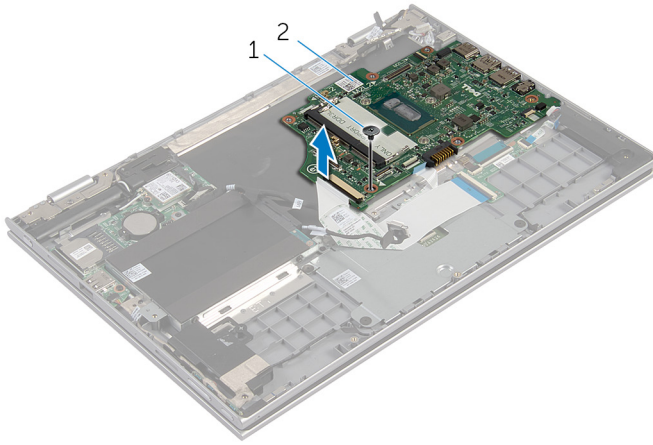

1 screw

2 system board

Replacing the System Board



WARNING: Before working inside your computer, read the safety information that shipped with your computer and follow the steps in [Before Working Inside Your Computer](#). After working inside your computer, follow the instructions in [After Working Inside Your Computer](#). For more safety best practices, see the Regulatory Compliance home page at dell.com/regulatory_compliance.



NOTE: Your computer's Service Tag is stored in the system board. You must enter the Service Tag in the BIOS setup program after you replace the system board.

Procedure

- 1 Align the screw holes on the system board with the screw holes on the palmrest and keyboard assembly.
- 2 Replace the screw that secures the system board to the palmrest and keyboard assembly.
- 3 Connect the power-adaptor port cable and the speaker cable to the system board.
- 4 Slide the touchpad cable into the connector on the system board and press down the latch to secure the cable.
- 5 Slide the keyboard cable and keyboard-backlit cable into the respective connectors and push the connector latches in to secure the cable.
- 6 Connect the hard-drive cable to the system board.
- 7 Secure the Windows-button board cable to the connector on the system board and adhere the tape on the Windows-button board connector to secure the cable.
- 8 Connect the display cable to the system board.
- 9 Align the screw holes on the display-cable bracket with the screw holes on the system board.
- 10 Replace the screws that secure the display-cable bracket to the system board.

Post-requisites

- 1 Replace the [heat sink](#).
- 2 Replace the [fan](#).
- 3 Replace the [memory module](#).

- 4 Replace the [battery](#).
- 5 Replace the [base cover](#).

Entering the Service Tag in the BIOS

- 1 Turn on the computer.
- 2 Press **F2** when the DELL logo is displayed to enter the BIOS setup program.
- 3 Navigate to the **Main** tab and enter the Service Tag in the **Service Tag Input** field.

Removing the Display Assembly



WARNING: Before working inside your computer, read the safety information that shipped with your computer and follow the steps in [Before Working Inside Your Computer](#). After working inside your computer, follow the instructions in [After Working Inside Your Computer](#). For more safety best practices, see the Regulatory Compliance home page at dell.com/regulatory_compliance.

Prerequisites

- 1 Remove the [base cover](#).
- 2 Remove the [battery](#).

Procedure

- 1 Disconnect the antenna cables from the wireless card.
- 2 Remove the screws that secure the display-cable bracket to the system board.
- 3 Lift the display-cable bracket off the system board.
- 4 Using the pull tab disconnect the display cable from the system board.

- 5 Peel off the adhesive tape on the Windows-button board connector and disconnect it from the system board.

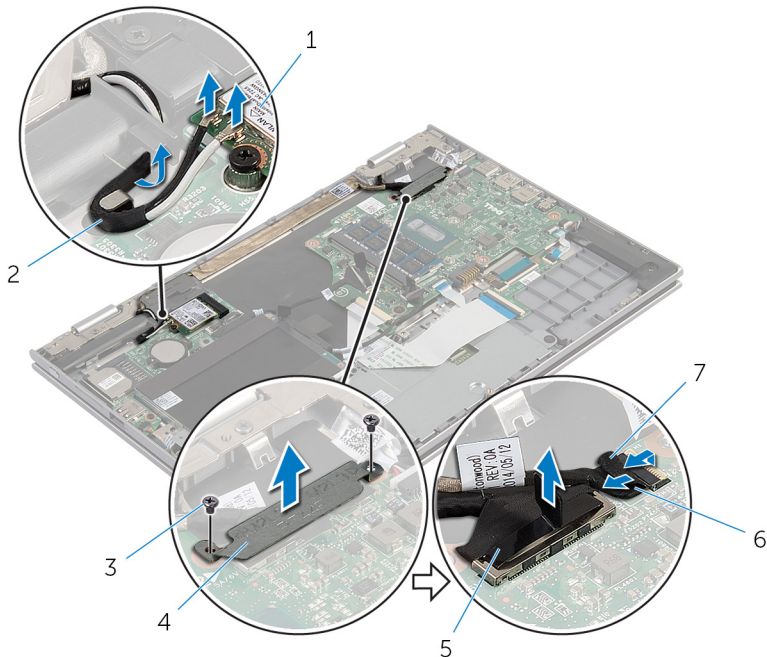

- | | | | |
|---|---------------|---|----------------------------|
| 1 | wireless card | 2 | antenna cables (2) |
| 3 | screws (2) | 4 | display-cable bracket |
| 5 | display cable | 6 | windows-button board cable |
| 7 | adhesive tape | | |

- 6 Turn the computer over and open the display as far as possible.

⚠ CAUTION: Place the computer on a soft and clean surface to avoid scratching the display.

- 7 Place the computer face down on a flat surface.
- 8 Remove the screws that secure the display assembly to the palmrest and keyboard assembly.
- 9 Peel off the adhesive tape that secures the the display cable to the palmrest and keyboard assembly.

10 Lift the display assembly off the palmrest and keyboard assembly.

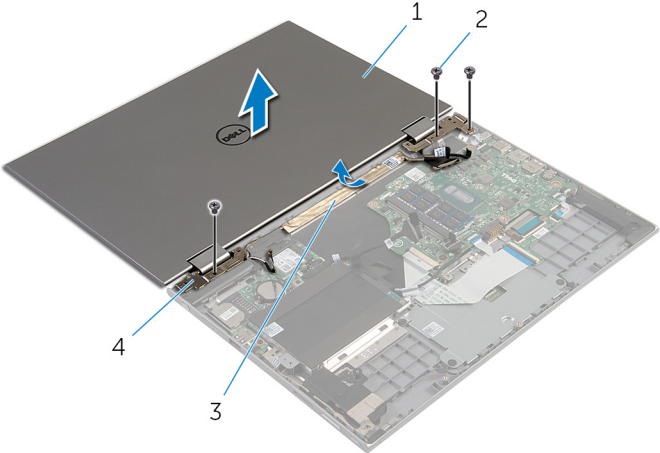

1 display assembly

2 screws (3)

3 adhesive tape

4 display hinges (2)

Replacing the Display Assembly

 **WARNING:** Before working inside your computer, read the safety information that shipped with your computer and follow the steps in [Before Working Inside Your Computer](#). After working inside your computer, follow the instructions in [After Working Inside Your Computer](#). For more safety best practices, see the Regulatory Compliance home page at dell.com/regulatory_compliance.

Procedure

 **CAUTION:** Place the computer on a soft and clean surface to avoid scratching the display.

- 1 Place the display assembly on the palmrest and keyboard assembly.
- 2 Align the screw holes on the display hinges with the screw holes on the palmrest and keyboard assembly.
- 3 Adhere the adhesive tape that secures the the display cable to the palmrest and keyboard assembly.
- 4 Replace the screws that secure the display assembly to the palmrest and keyboard assembly.
- 5 Turn the computer over and close the display.
- 6 Slide the Windows button-board connector into the connector latch on the system board and press down the latch to secure the cable.
- 7 Adhere the tape to the Windows button-board cable.
- 8 Connect the display cable to the system board.
- 9 Align the screw holes on the display-cable bracket with the screw holes on the system board.
- 10 Replace the screws that secure the display-cable bracket to the system board.
- 11 Connect the antenna cables to the wireless card.

Post-requisites

- 1 Replace the [battery](#).
- 2 Replace the [base cover](#).

Removing the Stylus-Holder Assembly



WARNING: Before working inside your computer, read the safety information that shipped with your computer and follow the steps in [Before Working Inside Your Computer](#). After working inside your computer, follow the instructions in [After Working Inside Your Computer](#). For more safety best practices, see the Regulatory Compliance home page at dell.com/regulatory_compliance.

Prerequisites

- 1 Remove the [base cover](#).
- 2 Remove the [battery](#).
- 3 Remove the [display assembly](#).

Procedure

- 1 Push to release the stylus from the stylus holder.

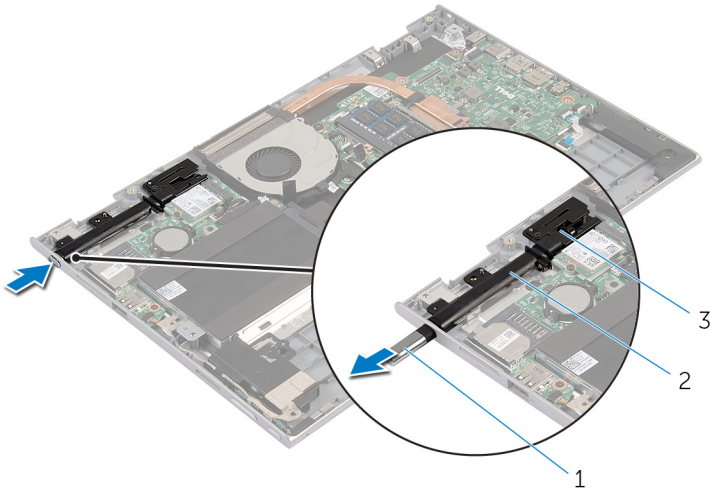

1 stylus

2 stylus holder

3 stylus lock

- 2 Remove the screw and lift the stylus lock from the palmrest and keyboard assembly.

3 Lift the stylus holder off the palmrest and keyboard assembly.

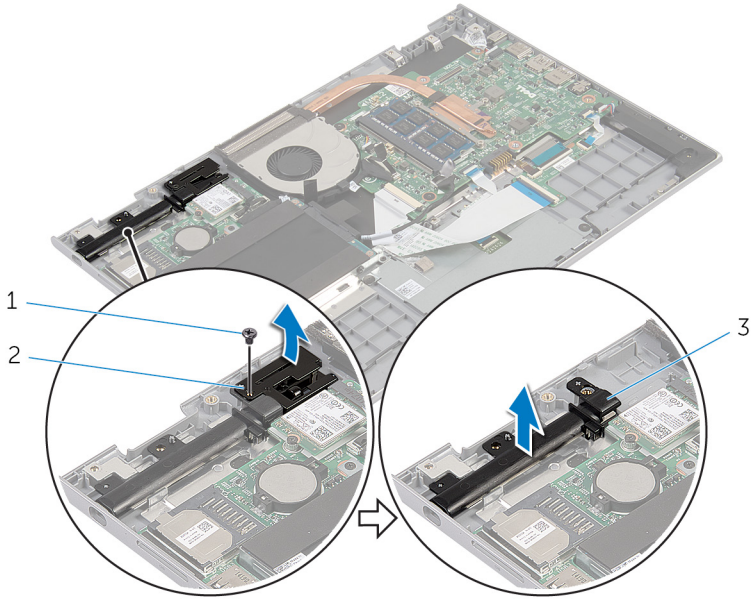

1 screw

2 stylus lock

3 stylus holder

Replacing the Stylus-Holder Assembly



WARNING: Before working inside your computer, read the safety information that shipped with your computer and follow the steps in [Before Working Inside Your Computer](#). After working inside your computer, follow the instructions in [After Working Inside Your Computer](#). For more safety best practices, see the Regulatory Compliance home page at dell.com/regulatory_compliance.

Procedure

- 1 Place the stylus holder and stylus lock on the palmrest and keyboard assembly.
- 2 Align the screw hole on the stylus holder with the screw hole on the palmrest and keyboard assembly.
- 3 Replace the screw that secures the stylus holder and stylus lock to the palmrest and keyboard assembly.
- 4 Align the screw hole on the stylus lock with the screw hole on the palmrest and keyboard assembly.
- 5 Replace the screw that secures the stylus lock to the palmrest and keyboard assembly.
- 6 Insert the stylus into the stylus holder and push to snap it in place.

Post-requisites

- 1 Replace the [display assembly](#).
- 2 Replace the [battery](#).
- 3 Replace the [base cover](#).

Removing the Palmrest and Keyboard Assembly

 **WARNING:** Before working inside your computer, read the safety information that shipped with your computer and follow the steps in [Before Working Inside Your Computer](#). After working inside your computer, follow the instructions in [After Working Inside Your Computer](#). For more safety best practices, see the Regulatory Compliance home page at dell.com/regulatory_compliance.

Prerequisites

- 1 Remove the [base cover](#).
- 2 Remove the [battery](#).
- 3 Follow the procedure from step 1 to step 3 in “Removing the [Hard Drive](#)”.
- 4 Remove the [stylus-holder assembly](#).
- 5 Remove the [keyboard daughter-board](#).
- 6 Remove the [touchpad](#).
- 7 Remove the [fan](#).
- 8 Remove the [heat sink](#).
- 9 Remove the [I/O board](#).
- 10 Remove the [speakers](#).
- 11 Remove the [display assembly](#).
- 12 Remove the [power-adapter port](#).
- 13 Remove the [system board](#).

Procedure

After performing the steps in prerequisites we are left with the palmrest and keyboard assembly.

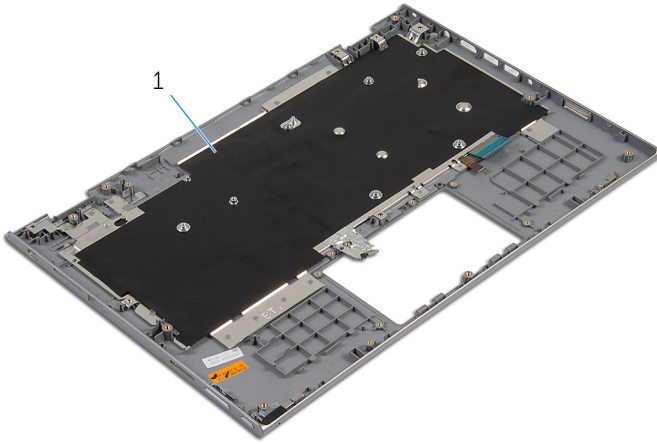

1 palmrest and keyboard assembly

Replacing the Palmrest and Keyboard Assembly

 **WARNING:** Before working inside your computer, read the safety information that shipped with your computer and follow the steps in [Before Working Inside Your Computer](#). After working inside your computer, follow the instructions in [After Working Inside Your Computer](#). For more safety best practices, see the Regulatory Compliance home page at dell.com/regulatory_compliance.

Procedure

Place the palmrest and keyboard assembly on a flat surface with the keyboard facing down.

Post-requisites

- 1 Replace the [system board](#).
- 2 Replace the [power-adapter port](#).
- 3 Replace the [display assembly](#).
- 4 Replace the [speakers](#).
- 5 Replace the [I/O board](#).
- 6 Replace the [heat sink](#).
- 7 Replace the [fan](#).
- 8 Replace the [touchpad](#).
- 9 Replace the [keyboard daughter-board](#).
- 10 Replace the [stylus-holder assembly](#).
- 11 Follow the procedure from step 4 to step 6 in “Replacing the [Hard Drive](#)”.
- 12 Replace the [battery](#).
- 13 Replace the [base cover](#).

Removing the Display Panel

⚠ WARNING: Before working inside your computer, read the safety information that shipped with your computer and follow the steps in [Before Working Inside Your Computer](#). After working inside your computer, follow the instructions in [After Working Inside Your Computer](#). For more safety best practices, see the Regulatory Compliance home page at dell.com/regulatory_compliance.

Prerequisites

- 1 Remove the [base cover](#).
- 2 Remove the [battery](#).
- 3 Remove the [display assembly](#).

Procedure

- 1 Remove the display cable from the routing guides inside the hinge covers.

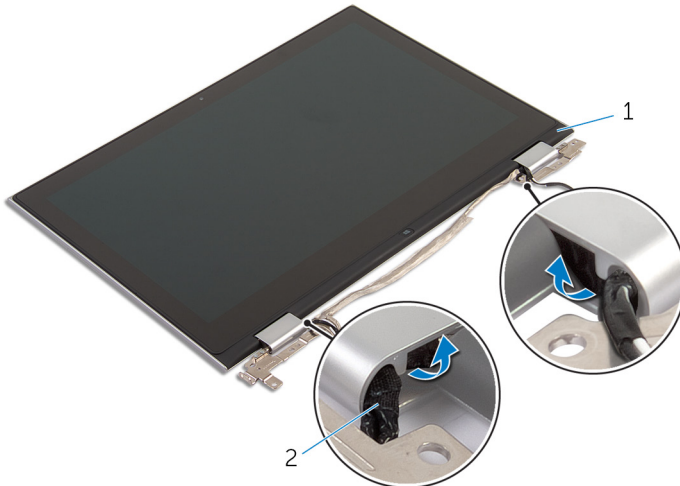

1 display panel assembly

2 display cable

- 2 Using a plastic scribe, pry the display-panel assembly off the display back-cover and antenna assembly.

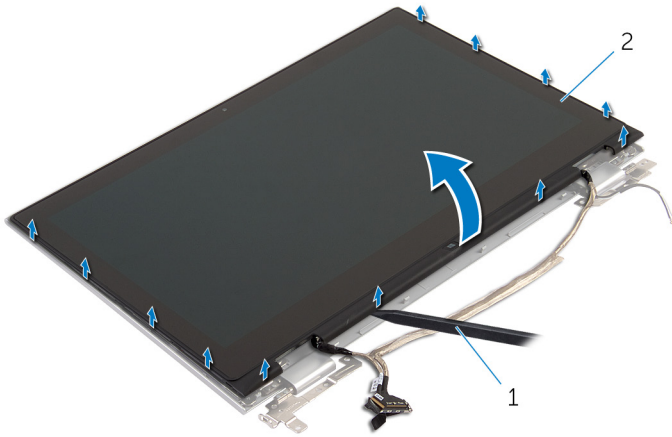

1 plastic scribe

2 display panel assembly

- 3 Remove the [camera](#).
- 4 Remove the [Windows-button board](#).

After performing the above steps, we are left with the display panel.



1 display panel

Replacing the Display Panel



WARNING: Before working inside your computer, read the safety information that shipped with your computer and follow the steps in [Before Working Inside Your Computer](#). After working inside your computer, follow the instructions in [After Working Inside Your Computer](#). For more safety best practices, see the Regulatory Compliance home page at dell.com/regulatory_compliance.

Procedure

- 1 Place the display panel on a flat surface.
- 2 Replace the [Windows-button board](#).
- 3 Replace the [camera](#).
- 4 Route the display cable into the routing guides inside the hinge covers.
- 5 Align the display-panel assembly with the display back-cover and antenna assembly and gently snap the display back-cover and antenna assembly into place.

Post-requisites

- 1 Replace the [display assembly](#).
- 2 Replace the [battery](#).
- 3 Replace the [base cover](#).

Removing the Display Back-Cover and Antenna Assembly

 **WARNING:** Before working inside your computer, read the safety information that shipped with your computer and follow the steps in [Before Working Inside Your Computer](#). After working inside your computer, follow the instructions in [After Working Inside Your Computer](#). For more safety best practices, see the Regulatory Compliance home page at dell.com/regulatory_compliance.

Prerequisites

- 1 Remove the [base cover](#).
- 2 Remove the [battery](#).
- 3 Remove the [display assembly](#).
- 4 Remove the [display panel](#).
- 5 Remove the [display hinges](#).

Procedure

After performing the steps in prerequisites we are left with the display back-cover and antenna assembly.

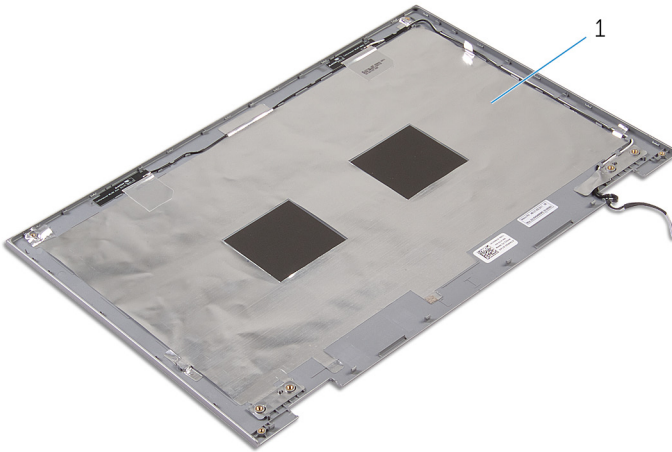

- 1 display back-cover and antenna assembly

Replacing the Display Back-Cover and Antenna Assembly

 **WARNING:** Before working inside your computer, read the safety information that shipped with your computer and follow the steps in [Before Working Inside Your Computer](#). After working inside your computer, follow the instructions in [After Working Inside Your Computer](#). For more safety best practices, see the Regulatory Compliance home page at dell.com/regulatory_compliance.

Procedure

Place the display back-cover and antenna assembly on a flat surface.

Post-requisites

- 1 Replace the [display hinges](#).
- 2 Replace the [display panel](#).
- 3 Replace the [display assembly](#).
- 4 Replace the [battery](#).
- 5 Replace the [base cover](#).

Removing the Display Hinges



WARNING: Before working inside your computer, read the safety information that shipped with your computer and follow the steps in [Before Working Inside Your Computer](#). After working inside your computer, follow the instructions in [After Working Inside Your Computer](#). For more safety best practices, see the Regulatory Compliance home page at dell.com/regulatory_compliance.

Prerequisites

- 1 Remove the [base cover](#).
- 2 Remove the [battery](#).
- 3 Remove the [display assembly](#).
- 4 Remove the [display back-cover and antenna assembly](#).

Procedure

- 1 Remove the antenna cables from the routing guide on the hinge cover.
- 2 Remove the screws that secure the display hinges to the display back-cover and antenna assembly.

3 Lift the display hinges off the display back-cover and antenna assembly.

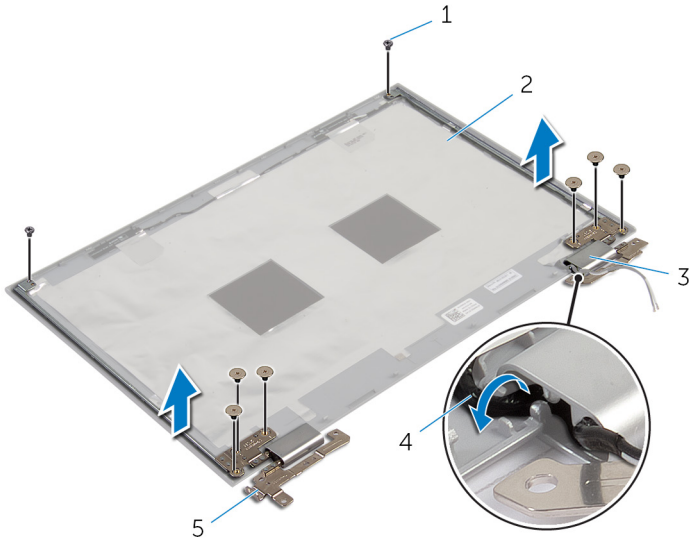

1 screws (8)

2 display back-cover and antenna assembly

3 hinge covers (2)

4 antenna cables (2)

5 display hinges (2)

Replacing the Display Hinges



WARNING: Before working inside your computer, read the safety information that shipped with your computer and follow the steps in [Before Working Inside Your Computer](#). After working inside your computer, follow the instructions in [After Working Inside Your Computer](#). For more safety best practices, see the Regulatory Compliance home page at dell.com/regulatory_compliance.

Procedure

- 1 Align the screw holes on the display hinges with the screw holes on the display back-cover and antenna assembly.
- 2 Replace the screws that secure the display hinges to the display back-cover and antenna assembly.
- 3 Route the antenna cables through the routing guide on the hinge cover and secure it in place.

Post-requisites

- 1 Replace the [display back-cover and antenna assembly](#).
- 2 Replace the [display assembly](#).
- 3 Replace the [battery](#).
- 4 Replace the [base cover](#).

Removing the Camera

 **WARNING:** Before working inside your computer, read the safety information that shipped with your computer and follow the steps in [Before Working Inside Your Computer](#). After working inside your computer, follow the instructions in [After Working Inside Your Computer](#). For more safety best practices, see the Regulatory Compliance home page at dell.com/regulatory_compliance.

Prerequisites

- 1 Remove the [base cover](#).
- 2 Remove the [battery](#).
- 3 Remove the [display assembly](#).
- 4 Remove the [display back-cover and antenna assembly](#).

Procedure

 **CAUTION:** Place the display-panel assembly on a soft and clean surface to avoid scratching the display.

- 1 Place the display-panel assembly face down on a flat surface.
- 2 Using a plastic scribe, pry the camera module off the display bezel.

- 3** Turn the camera over and disconnect the camera cable from the camera module.

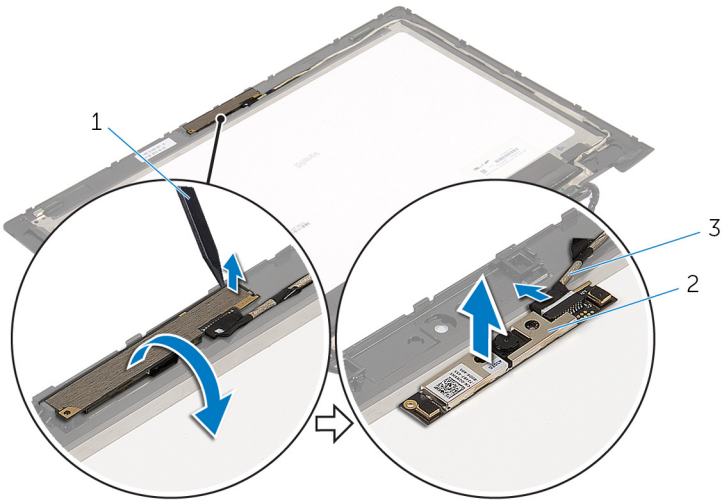

1 plastic scribe

2 camera

3 camera cable

Replacing the Camera



WARNING: Before working inside your computer, read the safety information that shipped with your computer and follow the steps in [Before Working Inside Your Computer](#). After working inside your computer, follow the instructions in [After Working Inside Your Computer](#). For more safety best practices, see the Regulatory Compliance home page at dell.com/regulatory_compliance.

Procedure

- 1 Connect the camera cable to the camera module.
- 2 Using the alignment post place the camera module on the display bezel and snap it into place.

Post-requisites

- 1 Replace the [display back-cover and antenna assembly](#).
- 2 Replace the [display assembly](#).
- 3 Replace the [battery](#).
- 4 Replace the [base cover](#).

Removing the Windows-Button Board

 **WARNING:** Before working inside your computer, read the safety information that shipped with your computer and follow the steps in [Before Working Inside Your Computer](#). After working inside your computer, follow the instructions in [After Working Inside Your Computer](#). For more safety best practices, see the Regulatory Compliance home page at dell.com/regulatory_compliance.

Prerequisites

- 1 Remove the [base cover](#).
- 2 Remove the [battery](#).
- 3 Remove the [display assembly](#).
- 4 Remove the [display back-cover and antenna assembly](#).

Procedure

 **CAUTION:** Place the display-panel assembly on a soft and clean surface to avoid scratching the display.

- 1 Place the display-panel assembly face down on a flat surface.
- 2 Remove the screw that secures the Windows-button board to the display bezel.
- 3 Turn the Windows button board over.
- 4 Peel off the adhesive tape and disconnect the Windows-button board cable from the Windows-button board.

5 Lift the Windows-button board off the display bezel.

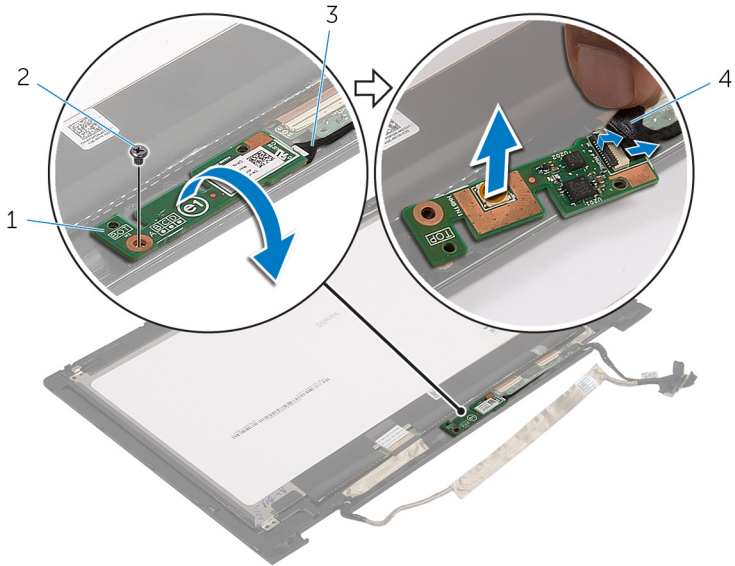

- 1 windows-button board
- 3 windows-button board cable

- 2 screw
- 4 adhesive tape

Replacing the Windows-Button Board



WARNING: Before working inside your computer, read the safety information that shipped with your computer and follow the steps in [Before Working Inside Your Computer](#). After working inside your computer, follow the instructions in [After Working Inside Your Computer](#). For more safety best practices, see the Regulatory Compliance home page at dell.com/regulatory_compliance.

Procedure

- 1 Slide in the Windows-button board cable and the touch screen-board cable into the connectors on the Windows-button board and press down the latches to secure the cables.
- 2 Turn the Windows-button board and align the screw hole on the Windows-button board with the screw hole on the display bezel.
- 3 Replace the screw that secures the Windows-button board to the display bezel.
- 4 Turn the display-panel assembly over.

Post-requisites

- 1 Replace the [display back-cover and antenna assembly](#).
- 2 Replace the [display assembly](#).
- 3 Replace the [battery](#).
- 4 Replace the [base cover](#).

Removing the Display Cable



WARNING: Before working inside your computer, read the safety information that shipped with your computer and follow the steps in [Before Working Inside Your Computer](#). After working inside your computer, follow the instructions in [After Working Inside Your Computer](#). For more safety best practices, see the Regulatory Compliance home page at dell.com/regulatory_compliance.

Prerequisites

- 1 Remove the [base cover](#).
- 2 Remove the [battery](#).
- 3 Remove the [display assembly](#).
- 4 Remove the [display back-cover and antenna assembly](#).
- 5 Remove the [camera](#).

Procedure

- 1 Peel off the adhesive tape and lift the latch to disconnect the display cable from the display panel.
- 2 Disconnect the Windows-button board cable.
- 3 Peel off the adhesive tape, lift the connector latch to disconnect the touch-screen board cable from the touch-screen board.
- 4 Remove the camera cable from the routing guides on the display bezel.
- 5 Lift the connector latch and disconnect the display cable from the touch board.
- 6 Note the display cable routing and remove the display cable from the routing guides on the display bezel.

7 Lift the display cable off the display bezel.

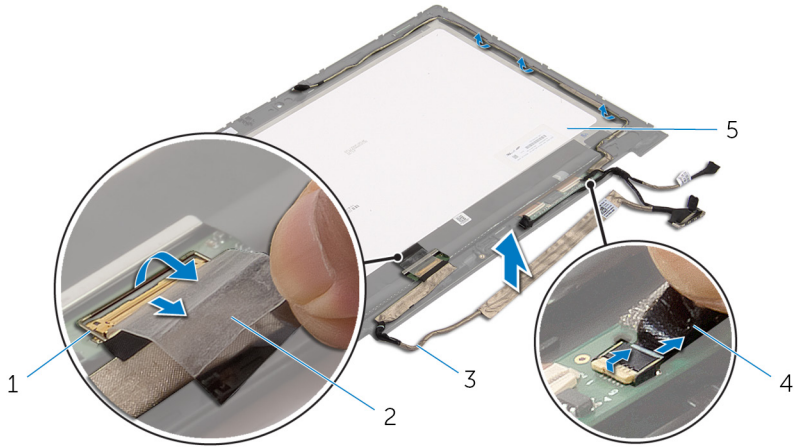

1 connector latch for display cable

2 adhesive tape

3 display cable

4 windows-button board cable

5 display panel

Replacing the Display Cable



WARNING: Before working inside your computer, read the safety information that shipped with your computer and follow the steps in [Before Working Inside Your Computer](#). After working inside your computer, follow the instructions in [After Working Inside Your Computer](#). For more safety best practices, see the Regulatory Compliance home page at dell.com/regulatory_compliance.

Procedure

- 1 Route the display cable through the routing guides on the display bezel.
- 2 Slide the display cable into the connector on the touch board and press down the latch to secure the cable.
- 3 Route the camera cable through the routing guides on the display bezel.
- 4 Adhere the adhesive tape, connect the touch-screen board cable to the touch-screen board and press down the connector latch to secure the cable.
- 5 Slide the Windows-button board cable into the connector on the Windows-button board and press down the latch to secure the cable.
- 6 Adhere the adhesive tape on the Windows-button board connector.

Post-requisites

- 1 Replace the [display back-cover and antenna assembly](#).
- 2 Replace the [display assembly](#).
- 3 Replace the [camera](#).
- 4 Replace the [battery](#).
- 5 Replace the [base cover](#).

Flashing the BIOS

You may need to flash (update) the BIOS when an update is available or when you replace the system board. To flash the BIOS:

- 1 Turn on the computer.
- 2 Go to **dell.com/support**.
- 3 If you have your computer's Service Tag, type your computer's Service Tag and click **Submit**.
If you do not have your computer's Service Tag, click **Detect My Product** to allow automatic detection of the Service Tag.
 **NOTE:** If the Service Tag cannot be detected automatically, select your product under the product categories.
- 4 Click **Get Drivers and Downloads**.
- 5 Click **View All Drivers**.
- 6 In the **Operating System** drop-down, select the operating system installed on your computer.
- 7 Click **BIOS**.
- 8 Click **Download File** to download the latest version of the BIOS for your computer.
- 9 On the next page, select **Single-file download** and click **Continue**.
- 10 Save the file and once the download is complete, navigate to the folder where you saved the BIOS update file.
- 11 Double-click the BIOS update file icon and follow the instructions on the screen.

Getting Help and Contacting Dell

Self-Help Resources

You can get information and help on Dell products and services using these online self-help resources:

Self-Help Information	Self-Help Options
Accessing Windows Help	Windows 8.1 — Open the Search charm, type Help and Support in the search box and press Enter . Windows 7 — Click Start → Help and Support .
Information about Dell products and services	See dell.com .
Troubleshooting information, user manuals, setup instructions, product specifications, technical help blogs, drivers, software updates, and so on	See dell.com/support .
Information about Microsoft Windows 8.1	See dell.com/windows8 .
Information about Microsoft Windows 7	Click Start → All Programs → Dell Help Documentation .
Learn about your operating system, setting up and using your computer, data backup, diagnostics, and so on.	See <i>Me and My Dell</i> at dell.com/support/manuals .

Contacting Dell

To contact Dell for sales, technical support, or customer service issues, see **dell.com/contactdell**.

 **NOTE:** Availability varies by country and product, and some services may not be available in your country.



NOTE: If you do not have an active internet connection, you can find contact information on your purchase invoice, packing slip, bill, or Dell product catalog.