



Alienware 610M Wired/Wireless Gaming Mouse User Guide

Mouse Model: AW610M
Regulatory Model: AW610M/UD2002

A L I E N W A R E™ 

Notes, cautions, and warnings

-  **NOTE:** A NOTE indicates important information that helps you make better use of your computer.
-  **CAUTION:** A CAUTION indicates potential damage to hardware or loss of data if instructions are not followed.
-  **WARNING:** A WARNING indicates a potential for property damage, personal injury, or death.

Copyright © 2019-2020 Dell Inc. or its subsidiaries. All rights reserved. Dell, EMC, and other trademarks are trademarks of Dell Inc. or its subsidiaries. Other trademarks may be trademarks of their respective owners.

2020 – 08

Rev. A01

Contents

What's in the box	4
Features	5
Adjustable DPI	5
Scrolling count	6
Setting up your gaming mouse	6
Connecting the mouse	6
Wireless mode	8
Wired mode	8
Turning on the mouse	9
Charging the battery	10
Battery indicator colors	10
Alienware Command Center (AWCC) Application	11
Installing AWCC through Windows Update	11
Installing AWCC from the Dell Support website	11
Troubleshooting	12
Statutory Information	17
Warranty	17
Limited warranty and return policies	17
For U.S. customers:	17
For European, Middle Eastern and African customers:	17
For non-U.S. customers:	17

What's in the box

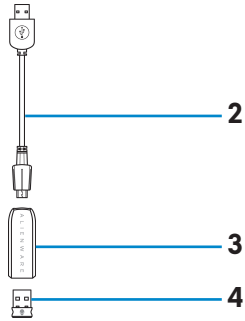
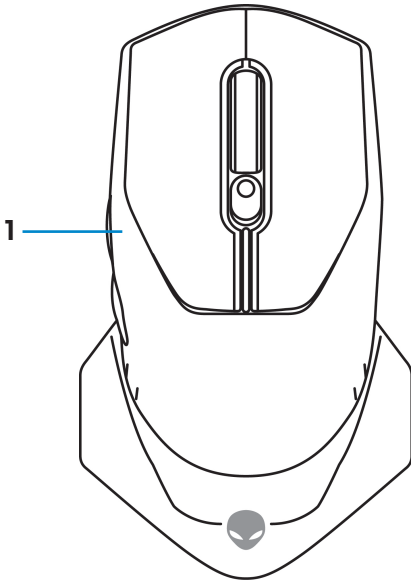

1. Mouse

2. USB wireless dongle extension/
charging cable

3. Wireless extension cable adapter

4. USB wireless dongle (USB 2.0)

5. Documents

Features

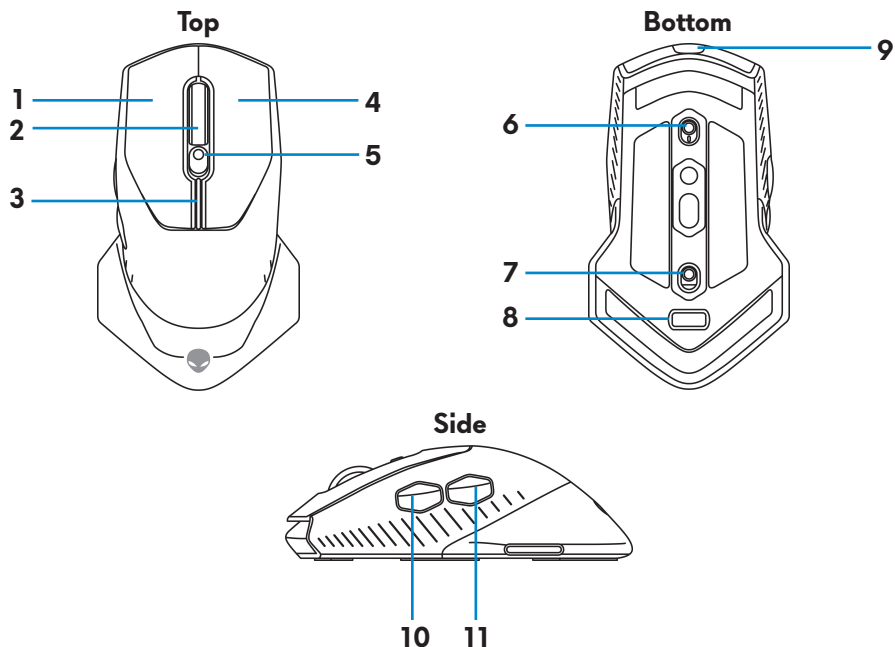

- | | |
|---------------------------|------------------------------------|
| 1. Left button | 2. Scroll wheel |
| 3. DPI/battery indicators | 4. Right button |
| 5. DPI adjustment slider | 6. Scroll wheel adjustment switch |
| 7. Power button | 8. USB wireless dongle compartment |
| 9. Micro USB port | 10. Forward button |
| 11. Backward button | |

Adjustable DPI

Press the DPI adjustment button to instantly change the mouse tracking resolution. DPI setting is indicated by the DPI indicator color. The default five DPI settings available are as follows:

- 800: Blue (■)
- 1800: Green (■) (Out-of-box default)
- 3500: Yellow (■)
- 9000: Orange (■)
- 16000: Red (■)

You can change the default DPI settings and customize the DPI stages and LED colors with the Alienware Command Center (AWCC) application.

Scrolling count

Push the scroll wheel adjustment switch up, to set the number of steps to 12 or down to set the number of steps to 24.

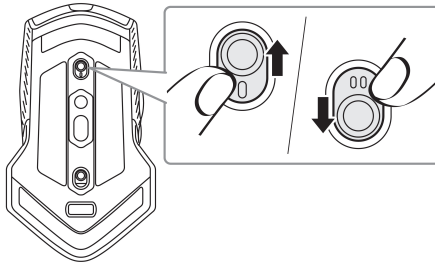

Setting up your gaming mouse

Connecting the mouse

NOTE: The mouse supports both wired mode and wireless mode.

1. Turn the mouse over.

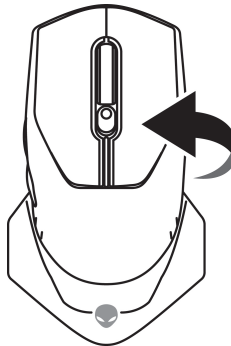

2. Remove the protective sheet.

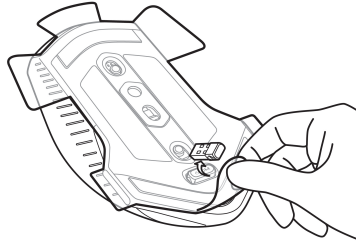

3. Push the USB wireless dongle down to release it from the compartment.

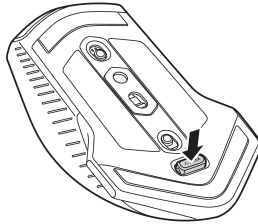

4. Remove the USB wireless dongle from the compartment.

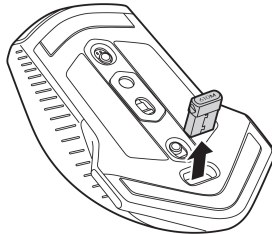

Wireless mode

Laptop

Connect the USB wireless dongle to a USB port on your laptop.

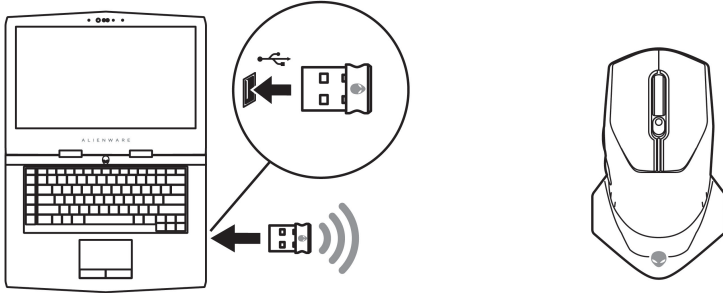

Desktop

1. Connect the USB wireless dongle extension/charging cable to the wireless extension cable adapter.
2. Connect the other end of the USB wireless dongle extension/charging cable to an available USB port on your desktop.
3. Insert the USB wireless dongle to the USB wireless dongle extension/charging cable adapter.

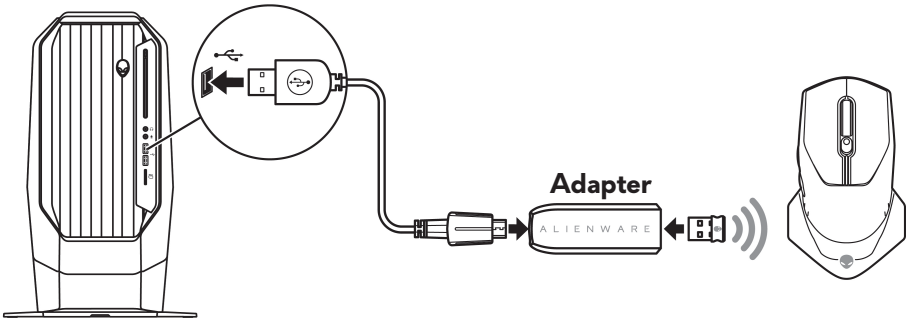

Wired mode

 **NOTE: The battery starts charging automatically in wired mode.**

1. Insert the USB wireless dongle back into the USB compartment.

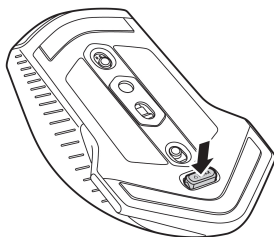

2. Connect the Micro USB end of the USB wireless dongle extension/charging cable to the USB port on the mouse.
3. Connect the other end of the USB wireless dongle extension/charging cable to an available USB port on your desktop or laptop.

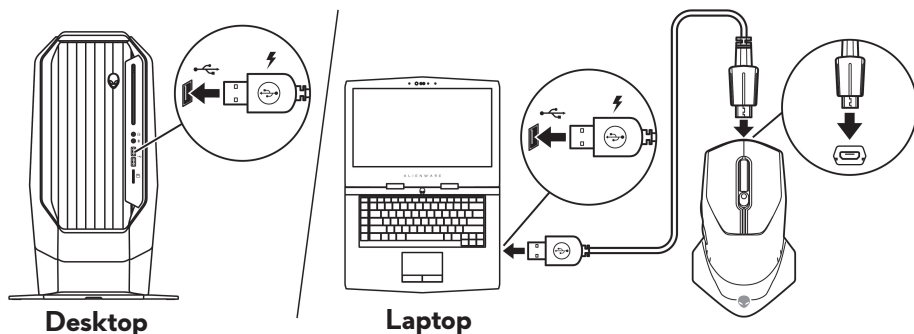

Turning on the mouse

Slide the power button down to turn on the mouse.

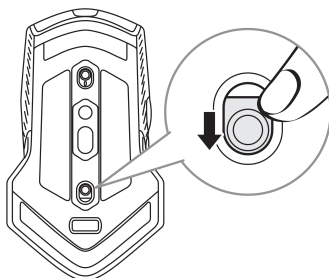

Charging the battery

Your gaming mouse has a rechargeable battery.

For best results, ensure that the battery is fully charged when using it for the first time.

1. Connect one end of the USB wireless extension/charging cable to the Micro USB port on the mouse.

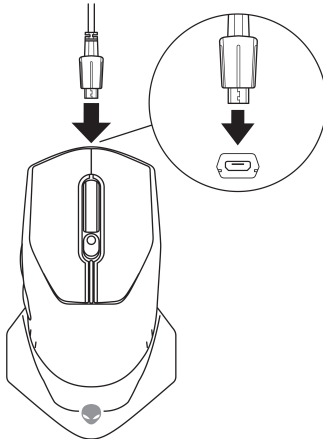

2. Connect the other end of the USB wireless dongle extension/charging cable to the USB port on your desktop or laptop.

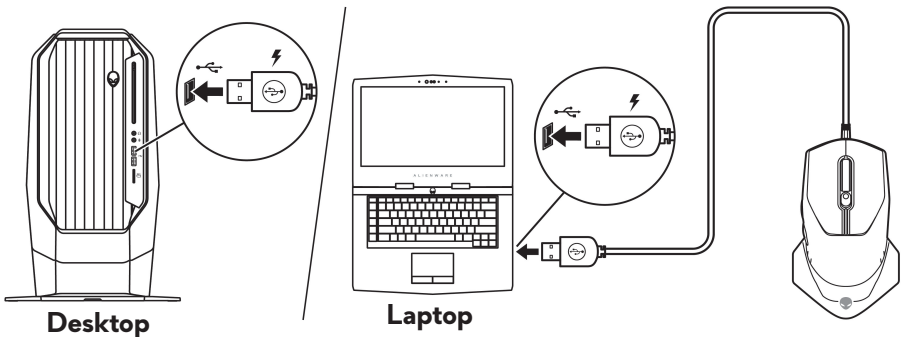

3. Wait until the battery indicator turns solid green. Solid green color indicates that the battery is fully charged.

Battery indicator colors

- Low power: Flashing amber (🔴)
- Charging: Morphing between amber (🟡) and green (🟢)
- Fully charged: Solid green (🟢)

Alienware Command Center (AWCC) Application

Alienware Command Center (AWCC) application provides a single interface to customize and enhance the gaming experience.

 **NOTE: For more information, see the Alienware Command Center (AWCC) application Online Help.**

Installing AWCC through Windows Update

1. Connect your Alienware peripheral to your computer through the USB port. The AWCC application is downloaded and installed automatically. AWCC installation may take up to 10 minutes to complete.
2. Navigate to the program folder to ensure that the AWCC installation is complete.
3. Launch AWCC and perform the following steps to download the additional software components:
 - In the **Settings** window, click **Windows Update**, and then click **Check for updates** to check the Alienware driver update progress.
 - If the driver update is not responding in your computer, install AWCC from the Dell Support website.

Installing AWCC from the Dell Support website

1. Download the latest version of the following applications from www.dell.com/support/drivers.
 - Alienware Command Center
 - Alienware Gaming Peripheral driver
2. Navigate to the folder where you saved the setup files.
3. Double-click the setup file and follow the on-screen instructions to install the application.

 **NOTE: You can customize the mouse features and lighting effects by using the Alienware Command Center (AWCC) application.**

Troubleshooting

Problems

Mouse is not functioning

Possible solutions

1. In wireless mode, ensure that the battery has sufficient battery power.
2. Slide the power button to turn off the mouse and then turn on again.
3. In wired mode, connect the USB wireless dongle extension/charging cable to another USB A port. A notification may appear indicating that the driver installation is in progress. If so, wait until a notification to appear indicating that the driver installation is complete before you use the mouse.
4. In wireless mode, connect the USB wireless dongle to another USB A port. A notification may appear indicating that the driver installation is in progress. If so, wait until a notification to appear indicating that the driver installation is complete before you use the mouse.
5. Restart the computer.

Problems

Possible solutions

Mouse lights do not turn on

1. Press any button to wake the mouse from sleep mode.
2. In wireless mode, ensure that the battery has sufficient battery power.
3. In wired mode, connect the USB wireless dongle extension/charging cable to another USB A port. A notification may appear indicating that the driver installation is in progress. If so, wait until a notification to appear indicating that the driver installation is complete before you use the mouse.
4. In wireless mode, connect the USB wireless dongle to another USB A port. A notification may appear indicating that the driver installation is in progress. If so, wait until a notification to appear indicating that the driver installation is complete before you use the mouse.
5. Restart the computer.

Mouse is not running based on the configuration selected in the Alienware Command Center (AWCC) application.

1. Ensure that the Alienware Command Center (AWCC) application is installed on your computer.
 2. Open the Alienware Command Center (AWCC) application and ensure that the selected configuration is set up and saved.
-

Problems

Resolving cursor issues

Possible solutions

1. In wired mode, connect the USB wireless dongle extension/charging cable to another USB A port. A notification may appear indicating that the driver installation is in progress. If so, wait until a notification to appear indicating that the driver installation is complete before you use the mouse.
2. In wireless mode, connect the USB wireless dongle to another USB A port. A notification may appear indicating that the driver installation is in progress. If so, wait until a notification to appear indicating that the driver installation is complete before you use the mouse.
3. Ensure that the sensor is not obstructed or dirty.
4. Glass or very smooth glossy surfaces are not suitable for the mouse sensor to capture movement. Using a dark colored fabric mouse pad can improve the tracking.
5. Save any data, close any open program(s), and then restart the laptop/desktop. When you do not have another mouse or touchscreen, you may have to hold the power button down for at least 15 seconds to turn the laptop/desktop off. You may lose any data that is not saved.

Problems

Resolving mouse button issues

Possible solutions

1. Ensure that there is nothing preventing the mouse buttons from moving. Most mouse buttons make a clicking noise when pressed down.
2. In wired mode, connect the USB wireless dongle extension/charging cable to another USB A port. A notification may appear indicating that the driver installation is in progress. If so, wait until a notification to appear indicating that the driver installation is complete before you use the mouse.
3. In wireless mode, connect the USB wireless dongle to another USB A port. A notification may appear indicating that the driver installation is in progress. If so, wait until a notification to appear indicating that the driver installation is complete before you use the mouse.
4. Save any data, close any open program(s), and then restart the laptop/desktop. When you do not have another mouse or touchscreen, you may have to hold the power button down for at least 15 seconds to turn the laptop/desktop off. You may lose any data that is not saved.

Problems

Possible solutions

Troubleshooting a slow moving cursor

1. Ensure that the sensor is not obstructed or dirty.
2. Glass or very smooth glossy surfaces are not suitable for the mouse sensor to capture movement. Using a dark colored fabric mouse pad can improve the tracking.
3. Change the mouse settings to adjust the pointer speed.

Click on the tab that matches the Operating System (OS) installed on your laptop/desktop and perform the steps within that section to change the settings.

- In the **Search** box, type `main.cpl`.
- Click or tap `main.cpl` in the list of programs.
- Click or tap the **Pointer Options** tab.
- Move the slider under **Select a Pointer Speed** to adjust the cursor speed to the desired level.
- Click or tap **OK**.

Troubleshooting cursor lagging

Cursor lagging might be due to wireless interference on the USB wireless dongle. Use the USB wireless extension adapter to connect the USB wireless dongle to the laptop/desktop.

Troubleshooting lift off distance (LOD) surface calibration issues

The LOD surface calibration depends on the surface characteristics and may not work on all surfaces.

Using a dark colored fabric mouse pad might improve LOD calibration.

Statutory Information

Warranty

Limited warranty and return policies

Dell-branded products carry a two-year limited hardware warranty. If purchased together with Dell system, it will follow the system warranty.

For U.S. customers:

This purchase and your use of this product are subject to Dell's end user agreement, which you can find at <https://www.dell.com/terms>. This document contains a binding arbitration clause.

For European, Middle Eastern and African customers:

Dell-branded products that are sold and used are subject to applicable national consumer legal rights, the terms of any retailer sale agreement that you have entered into (which will apply between you and the retailer) and Dell's end user contract terms.

Dell may also provide an additional hardware warranty – full details of the Dell end user contract and warranty terms can be found by going to <https://www.dell.com/terms>, selecting your country from the list at the bottom of the "home" page and then clicking the "terms and conditions" link for the end user terms or the "support" link for the warranty terms.

For non-U.S. customers:

Dell-branded products that are sold and used are subject to applicable national consumer legal rights, the terms of any retailer sale agreement that you have entered into (which will apply between you and the retailer) and Dell's warranty terms. Dell may also provide an additional hardware warranty – full details of Dell's warranty terms can be found by going to <https://www.dell.com/terms>, selecting your country from the list at the bottom of the "home" page and then clicking the "terms and conditions" link or the "support" link for the warranty terms.