

Dell UltraSharp 27 Monitor - U2722D/U2722DX/U2722DE

User's Guide

Model: U2722D/U2722DX/U2722DE
Regulatory model: U2722Dt/U2722DEt





NOTE: A NOTE indicates important information that helps you make better use of your computer.



CAUTION: A CAUTION indicates potential damage to hardware or loss of data if instructions are not followed.



WARNING: A WARNING indicates a potential for property damage, personal injury, or death.

Copyright © 2021 Dell Inc. or its subsidiaries. All rights reserved. Dell, EMC, and other trademarks are trademarks of Dell Inc. or its subsidiaries. Other trademarks may be trademarks of their respective owners.

2021 – 02

Rev. A00

Contents

Safety Instructions	6
About Your Monitor	7
Package Contents	7
Product Features	8
Identifying Parts and Controls	10
Front View	10
Back View	11
Bottom View	12
Monitor Specifications	15
Resolution Specifications	17
Preset Display Modes	17
DP Multi-Stream Transport (MST) Modes	18
USB-C Multi-Stream Transport (MST) Modes (U2722DE Only)	18
Electrical Specifications	18
Physical Characteristics	19
Environmental Characteristics	21
Pin Assignments	22
Plug-and-Play	30
LCD Monitor Quality and Pixel Policy	30
Ergonomics	30
Handling and Moving Your Display	32
Maintenance Guidelines	33
Cleaning Your Monitor	33
Setting Up the Monitor	34
Connecting the Stand	34
Using the Tilt, Swivel, and Vertical Extension	37



Tilt, Swivel and Vertical Extension37
Rotating the Display	37
Configuring the Display Settings on Your Computer after Rotation	38
Organizing Your Cables	39
Connecting Your Monitor	40
U2722D/U2722DX41
U2722DE43
Dell Power Button Sync (DPBS) (U2722DE Only)	46
Connecting the Monitor for DPBS for the First Time48
Using DPBS Function49
Connecting the Monitor for USB-C Multi-Stream Transport (MST) function51
Connecting the Monitor for USB-C52
Securing Your Monitor Using Kensington Lock (Optional)	54
Removing the Monitor Stand	55
Wall Mounting (Optional)	56
Operating the Monitor	57
Power On the Monitor	57
Using the Joystick Control	57
Using the Menu Launcher	58
Front-Panel Button60
Using the Main Menu	61
Using the OSD Lock Function76
Initial Setup79
OSD Warning Messages80
Setting the Maximum Resolution83
Multi-Monitor Sync (MMS)84
Setting Multi-Monitor Sync (MMS)85
Setting the KVM USB Switch (U2722DE Only)86
Setting the Auto KVM (U2722DE Only)89



Troubleshooting 91
 Self-Test 91
 Built-in Diagnostics 92
 Common Problems. 93
 Product Specific Problems 95
 Universal Serial Bus (USB) Specific Problems 98

Appendix. 99
 FCC Notices (U.S. Only) and Other Regulatory Information. . 99
 Contacting Dell 99
 EU Product Database for Energy Label and Product
 Information Sheet 99



Safety Instructions

⚠ WARNING: Use of controls, adjustments, or procedures other than those specified in this documentation may result in exposure to shock, electrical hazards, and/or mechanical hazards.

- Place the monitor on a solid surface and handle it carefully. The screen is fragile and can be damaged if dropped or hit sharply.
- Always be sure that your monitor is electrically rated to operate with the AC power available in your location.
- Keep the monitor in room temperature. Excessive cold or hot conditions can have an adverse effect on the liquid crystal of the display.
- Do not subject the monitor to severe vibration or high impact conditions. For example, do not place the monitor inside a car trunk.
- Unplug the monitor when it is going to be left unused for an extended period of time.
- To avoid electric shock, do not attempt to remove any cover or touch the inside of the monitor.

For information on safety instructions, see the Safety, Environmental, and Regulatory Information (SERI).



About Your Monitor



Package Contents

Your monitor ships with the components shown in the table below. If any component is missing, contact Dell. For more information, see [Contact Dell](#).

NOTE: Some components may be optional and may not ship with your monitor. Some features may not be available in certain countries.

	Display
	Stand riser
	Stand base
	Power cable (varies by country)
	DisplayPort 1.8 M cable (DisplayPort to DisplayPort) (U2722D/U2722DE only)
	USB-C 1.0 M cable (A to C)



	USB-C 1.0 M cable (C to C) (U2722DE only)
	HDMI 1.8 M cable (U2722DX only)
	<ul style="list-style-type: none"> • Quick Setup Guide • Safety, Environmental, and Regulatory Information • Factory Calibration Report

Product Features

The **Dell UltraSharp U2722D/U2722DX/U2722DE** monitor has an active matrix, Thin-Film Transistor (TFT), Liquid Crystal Display (LCD), and LED backlight. The monitor features include:

- 68.47 cm (27.0 in.) active area display (Measured diagonally) 2560 x 1440 (16:9) resolution, plus full-screen support for lower resolutions.
- Wide viewing angles with 100% sRGB and 100% Rec. 709 color with an average Delta E < 2.
- Tilt, swivel, pivot and vertical extension adjustment capabilities.
- Removable pedestal stand and Video Electronics Standards Association (VESA™) 100 mm mounting holes for flexible mounting solutions.
- Ultra-thin bezel minimizes the bezel gap during multi-monitor usage, enabling easier set up with an elegant viewing experience.
- Extensive digital connectivity with DP helps future-proof your monitor.
- Single USB-C to supply power to compatible notebook while receiving video signal (U2722DE only).
- USB-C and RJ45 ports enable a single-cable, network-connected experience (U2722DE only).
- Plug and play capability if supported by your computer.
- On-Screen Display (OSD) adjustments for ease of set-up and screen optimization.
- Power and OSD buttons lock.
- Security lock slot.
- ≤ 0.3 W in Off Mode.
- Supports Picture by Picture (PBP) Select mode.



- Allow user to switch USB KVM function in PBP mode (U2722DE only).
 - The Monitor is designed with Dell Power Button Sync (DPBS) feature to control PC system power state from monitor power button (U2722DE only). *
 - The Monitor allows multiple monitors that are daisy chained via DisplayPort to synchronize a pre-defined group of OSD settings in the background by Multi-Monitor Sync (MMS).
 - Premium Panel Exchange for peace of mind.
 - Optimize eye comfort with a flicker-free screen minimizes hazard blue light emission.
 - The Monitor use Low Blue Light panel and compliance with TUV Rheinland (Hardware Solution) at factory reset/default setting model.
 - Decreases the level of hazard blue light emitted from the screen to make viewing more comfortable for your eyes.
 - The Monitor adopts Flicker-Free technology, which clears the eye visible flicker, brings comfort viewing experience and preventing users suffer from eye strain and fatigue.
- * PC system that supports DPBS is the Dell OptiPlex 7090/3090 Ultra platform.

⚠ WARNING: The possible long-term effects of blue light emission from the monitor may cause damage to the eyes, including eye fatigue or digital eye strain.



Identifying Parts and Controls

Front View

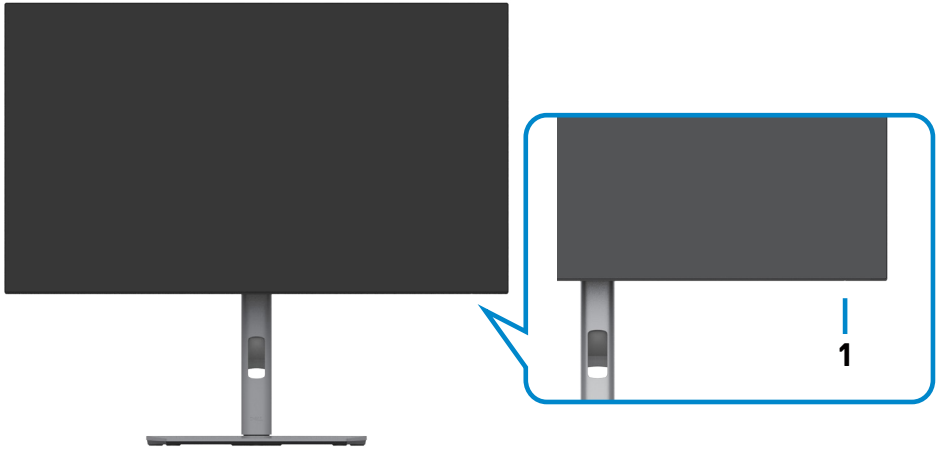

Label	Description	Use
1	Power LED indicator	Solid white light indicates the monitor is turned on and functioning normally. Blinking white light indicates the monitor is in Standby Mode.



Back View









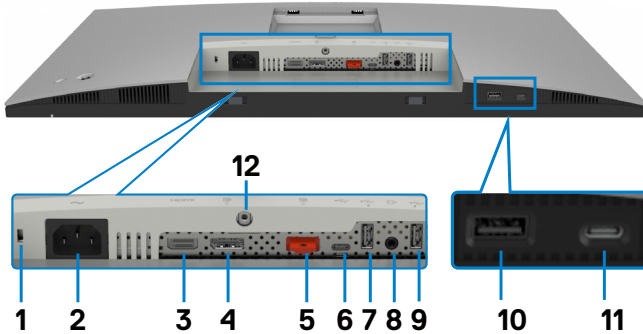

Label	Description	Use
1	VESA mounting holes (100 mm x 100 mm-behind attached VESA cover)	Wall mount monitor using VESA-compatible wall mount kit (100 mm x 100 mm).
2	Regulatory label	Lists the regulatory approvals.
3	Stand release button	Releases stand from the monitor.
4	Power On/Off button	To turn the monitor on or off.
5	Joystick	Use it to control the OSD menu. For more information, see Operating the Monitor .
6	Mac address, Barcode, serial number, and Service Tag label	Refer to this label if you need to contact Dell for technical support. The Service Tag is a unique alphanumeric identifier that enables Dell service technicians to identify the hardware components in your computer and access warranty information.
7	Cable-management slot	Use to organize cables by inserting them through the slot.





Bottom View

U2722D/U2722DX





Label	Description	Use
1	Security lock slot	Secures monitor with security cable lock (sold separately).
2	 Power connector	Connect the power cable.
3	HDMI HDMI port	Connect your computer with the HDMI cable.
4	 DisplayPort in	Connect your computer with the DisplayPort cable.
5	 DP port (out) 	DP output for MST (Multi-Stream Transport) capable monitor. To enable MST, refer to instruction on section “Connecting the Monitor for DP MST Function” . NOTE: Remove the rubber plug when using DP out connector.
6	 USB-C upstream Port	Connect to your computer using the USB cable (A to C or C to C). Once the USB cable is connected, you can use the USB downstream connectors on the monitor.
7,9,10	 Super speed USB 10Gbps (USB 3.2 Gen2) (3)	Connect your USB device. You can use these ports only after you have connected the USB cable (A to C or C to C) from the computer to the monitor. Port with  battery icon supports Battery Charging Rev. 1.2.





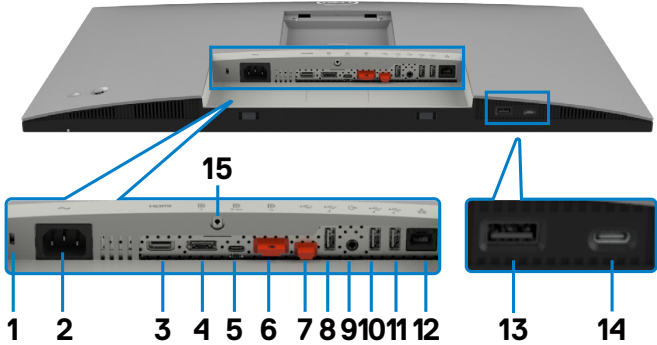







8	 Audio line-out port	Connect speakers to playback audio through HDMI or DisplayPort audio channels. Only two-channel audio is supported. NOTE: The audio line-out port does not support headphones.
11	 USB-C downstream port	Port with  icon supports 5 V/ 3 A. Connect your USB device. You can use this port only after you have connected the USB cable (A to C or C to C) from the computer to the monitor.
12	Stand lock	Lock the stand to the monitor using a M3 x 8 mm screw (screw not included).

U2722DE



Label	Description	Use
1	Security lock slot	Secures monitor with security cable lock (sold separately).
2	 Power connector	Connect the power cable.
3	HDMI HDMI port	Connect your computer with the HDMI cable.
4	 DisplayPort in	Connect your computer with the DisplayPort cable.



5	 <small>90W</small> USB-C port (Video + Data)	Connect to your computer using the USB-C cable. The USB-C port offer the fastest transfer rate and the alternate mode with DP 1.4 support the maximum resolution of 2560 x 1440 at 60 Hz PD 20 V/4.5 A, 15 V/3 A, 9 V/3 A, 5 V/3 A. NOTE: USB-C is not supported on Windows versions that are prior to Windows 10.
6	 DP port (out) 	DP output for MST (Multi-Stream Transport) capable monitor. To enable MST, refer to instruction on section “ Connecting the Monitor for DP MST Function ”. NOTE: Remove the rubber plug when using DP out connector.
7	 USB-C upstream port 	Connect to your computer using the USB cable (A to C or C to C). Once the USB cable is connected, you can use the USB downstream connectors on the monitor. NOTE: Remove the rubber plug when using USB-C connector.
8,10, 11,13	 Super speed USB 10Gbps (USB 3.2 Gen2) (4)	Connect your USB device. You can use these ports only after you have connected the USB cable (A to C or C to C) from the computer to the monitor. Port with  battery icon supports Battery Charging Rev. 1.2.
9	 Audio line-out port	Connect speakers to playback audio through HDMI or DisplayPort audio channels. Only two-channel audio is supported. NOTE: The audio line-out port does not support headphones.
12	 RJ-45 connector	Connect Internet. You can surf Internet via RJ45 only after you have connected the USB cable (A to C or C to C) from the computer to the monitor.
14	 USB-C downstream port	Port with  icon supports 5 V/ 3 A. Connect your USB device. You can use this port only after you have connected the USB cable (A to C or C to C) from the computer to the monitor.
15	Stand lock	Lock the stand to the monitor using a M3 x 8 mm screw (screw not included).



Monitor Specifications

Model	U2722D/U2722DX	U2722DE
Screen type	Active matrix - TFT LCD	
Panel Type	In-plane switching Technology	
Aspect ratio	16:9	
Viewable image dimensions		
Diagonal	68.47 cm (27 in.)	
Active Area		
Horizontal	596.74 mm (23.49 in.)	
Vertical	335.66 mm (13.22 in.)	
Area	200301.74 mm ² (310.47 in. ²)	
Pixel pitch	0.2331 mm x 0.2331 mm	
Pixel per inch (PPI)	108.78	
Viewing angle		
Horizontal	178° (typical)	
Vertical	178° (typical)	
Brightness	350 cd/m ² (typical)	
Contrast ratio	1000 to 1 (typical)	
Display screen coating	Anti-glare treatment of the front polarizer (3H) hard coating	
Backlight	LED	
Response Time (Gray to Gray)	5 ms (Fast mode) 8 ms (Normal mode)	
Color depth	1.07 billion colors	
Color gamut*	100% sRGB 100% Rec. 709 95% DCI-P3	
Calibration accuracy	Delta E < 2 (average) (sRGB, Rec. 709)	



Connectivity	<ul style="list-style-type: none"> · 1 x DP 1.4 (HDCP 1.4) · 1 x HDMI 1.4 · 1 x USB-C (USB 3.2 Gen2, 10Gbps) upstream (Data only) · 1 x DP (Out) · 1 x Analog 2.0 audio line out (3.5 mm jack) · 2 x USB-A (USB 3.2 Gen2, 10Gbps) downstream <p>Quick Access:</p> <ul style="list-style-type: none"> · 1 x USB-A (USB 3.2 Gen2, 10Gbps) downstream with BC 1.2 · 1 x USB-C (USB 3.2 Gen2, 10Gbps, 15 W) downstream 	<ul style="list-style-type: none"> · 1 x DP 1.4 (HDCP 1.4) · 1 x HDMI 1.4 · 1 x USB-C (DP 1.4, PD: 90W, 2/4 lanes switch USB 3.2 Gen2, 10Gbps) - upstream · 1 x USB-C (USB 3.2 Gen2, 10Gbps) upstream · 1 x DP (Out) · 1 x Analog 2.0 audio line out (3.5 mm jack) · 3 x USB-A (USB 3.2 Gen2, 10Gbps) downstream · 1 x RJ45 <p>Quick Access:</p> <ul style="list-style-type: none"> · 1 x USB-A (USB 3.2 Gen2, 10Gbps) downstream with BC 1.2 · 1 x USB-C (USB 3.2 Gen2, 10Gbps, 15 W) downstream
Border width (edge of monitor to active area)		
Top	7.30 mm	
Left/Right	7.30 mm	
Bottom	9.05 mm	
Adjustability		
Height adjustable stand	150 mm	
Tilt	-5° to 21°	
Swivel	-45° to 45°	
Pivot	-90° to 90°	
Cable management	Yes	
Dell Display Manager (DDM)Compatibility	Easy Arrange and other key features	
Security	Security lock slot (cable lock sold separately)	

* At panel native only, under Custom Mode preset.



Resolution Specifications

Horizontal scan range	30 kHz to 90 kHz
Vertical scan range	49 Hz to 76 Hz
Maximum preset resolution	2560 x 1440 at 60 Hz
Video display capabilities (HDMI)	480i, 480p, 576i, 560p, 720p, 1080i, 1080p
Video display capabilities (DP & USB-C alternate mode)	480p, 560p, 720p, 1080p

Preset Display Modes

Display mode	Horizontal frequency (kHz)	Vertical frequency (Hz)	Pixel clock (MHz)	Sync polarity (Horizontal/Vertical)
IBM, 720 x 400	31.47	70.08	28.32	-/+
VESA, 640 x 480	31.47	59.94	25.18	-/-
VESA, 640 x 480	37.50	75.00	31.50	-/-
VESA, 800 x 600	37.88	60.32	40.00	+/+
VESA, 800 x 600	46.88	75.00	49.50	+/+
VESA, 1024 x 768	48.36	60.00	65.00	-/-
VESA, 1024 x 768	60.02	75.03	78.75	+/+
VESA, 1152 x 864	67.50	75.00	108.00	+/+
VESA, 1280 x 1024	63.98	60.02	108.00	+/+
VESA, 1280 x 1024	79.98	75.02	135.00	+/+
VESA, 1600 x 1200	75.00	60.00	162.00	+/+
CTA, 1920 x 1080	67.50	60.00	148.50	+/+
VESA, 1920 x 1200	74.04	59.95	154.00	+/-
VESA, 2048 x 1080	66.66	59.98	147.18	+/-
VESA, 2048 x 1080	26.37	24.00	58.23	+/-
CVR, 2560 x 1440	88.79	59.95	241.50	+/-



DP Multi-Stream Transport (MST) Modes

MST Source Monitor	Maximum number of external monitors that can be supported
	2560 x 1440/60 Hz
2560 x 1440/60 Hz	2

NOTE: Maximum external monitor resolution supported is 2560 x 1440/60 Hz only.

USB-C Multi-Stream Transport (MST) Modes (U2722DE Only)

OSD Display Info: Link rate(current)	Maximum number of external monitors that can be supported
	2560 x 1440/60 Hz
HBR3	2
HBR2	1

Electrical Specifications

Model	U2722D	U2722DX	U2722DE
Video input signals	<ul style="list-style-type: none"> Digital video signal for each differential line Per differential line at 100 ohm impedance DP/HDMI/USB-C (U2722DE only) signal input support 		
Input voltage/frequency/current	100-240 VAC / 50 or 60 Hz \pm 3 Hz / 1.6 A (maximum)		100-240 VAC / 50 or 60 Hz \pm 3 Hz / 2.4 A (maximum)
Inrush current	120 V: 30 A (Max.) 240 V: 60 A (Max.) Inrush current is measured at an ambient temperature of 0°C.		120 V: 42 A (Max.) 240 V: 80 A (Max.) Inrush current is measured at an ambient temperature of 0°C.
Power Consumption	0.3 W (Off Mode) ¹ 0.3 W (Standby Mode) ¹ 20 W (On Mode) ¹ 74 W (Max) ² 16.11 W (P _{on}) ³ 51.39 kWh (TEC) ³	74 W (Max) ² 16.11 W (P _{on}) ³ 51.39 kWh (TEC) ³	0.3 W (Off Mode) ¹ 0.3 W (Standby Mode) ¹ 20.4 W (On Mode) ¹ 197 W (Max) ² 20.32 W (P _{on}) ³ 66.74 kWh (TEC) ³

¹As defined in EU 2019/2021 and EU 2019/2013 (U2722D/U2722DE only).



² Max brightness and contrast setting with maximum power loading on all USB ports.

³ P_{on}: Power consumption of On Mode as defined in Energy Star 8.0 version.

TEC: Total energy consumption in kWh as defined in Energy star 8.0 version.

This document is informational only and reflects laboratory performance.

Your product may perform differently, depending on the software, components and peripherals you ordered and shall have no obligation to update such information.



Accordingly, the customer should not rely upon this information in making decisions about electrical tolerances or otherwise. No warranty as to accuracy or completeness is expressed or implied.

 **NOTE: This monitor is ENERGY STAR certified.**



This product qualifies for ENERGY STAR in the factory default settings which can be restored by “Factory Reset” function in the OSD menu. Changing the factory default settings or enabling other features may increase power consumption that could exceed the ENERGY STAR specified limit.

Physical Characteristics

Model	U2722D/U2722DX	U2722DE
Connector type	<ul style="list-style-type: none"> • DP connector (include DP in and DP out) • HDMI connector • Audio line-out • USB-C (USB 3.2 Gen2, 10Gbps) upstream connector • USB-A (USB 3.2 Gen2, 10Gbps) downstream connector x 3 (Port with  battery icon supports BC 1.2.) • USB-C (USB 3.2 Gen2, 10Gbps, 15W) downstream connector 	<ul style="list-style-type: none"> • DP connector (include DP in and DP out) • HDMI connector • USB-C connector • Audio line-out • USB-C (USB 3.2 Gen2, 10Gbps) upstream connector • USB-A (USB 3.2 Gen 2, 10 Gbps) downstream connector x 4 (Port with  battery icon supports BC 1.2.) • RJ45 connector • USB-C (USB 3.2 Gen2, 10Gbps, 15W) downstream connector



Signal cable type	DP to DP 1.8 M cable (U2722D/U2722DE only) HDMI 1.8 M cable (U2722DX only) USB 3.2 Gen2 C to C 1.0 M cable (U2722DE only) USB 3.2 Gen2 A to C 1.0 M cable	
Dimensions (with stand)		
Height (extended)	535.13 mm (21.07 in.)	
Height (compressed)	385.13 mm (15.16 in.)	
Width	611.34 mm (24.07 in.)	
Depth	185.00 mm (7.28 in.)	
Dimensions (without stand)		
Height	352.01 mm (13.86 in.)	
Width	611.34 mm (24.07 in.)	
Depth	49.50 mm (1.95 in.)	
Stand dimensions		
Height (extended)	428.30 mm (16.86 in.)	
Height (compressed)	381.50 mm (15.02 in.)	
Width	268.00 mm (10.55 in.)	
Depth	185.00 mm (7.28 in.)	
Weight		
Weight with packaging	9.62 kg (21.21 lb)	10.01 kg (22.06 lb)
Weight with stand assembly and cables	6.61kg (14.57lb)	7.02 kg (15.47 lb)
Weight without stand assembly (For wall mount or VESA mount considerations - no cables)	4.38 kg (9.66 lb)	4.78 kg (10.54 lb)
Weight of stand assembly	1.81 kg (3.99 lb)	



Environmental Characteristics

Compliant Standards	
<ul style="list-style-type: none"> • ENERGY STAR certified Monitor. • EPEAT registered where applicable. EPEAT registration varies by country. See https://www.epeat.net for registration status by country. • TCO and TCO Edge Certified Display. • RoHS Compliant. • BFR/PVC Free monitor (excluding external cables). • Meets NFPA 99 leakage current requirements. • Arsenic-Free glass and Mercury-Free for the panel only. 	
Temperature	
Operating	0°C to 40°C (32°F to 104°F)
Non-operating	-20°C to 60°C (-4°F to 140°F)
Humidity	
Operating	10% to 80% (non-condensing)
Non-operating	5% to 90% (non-condensing)
Altitude	
Operating	5,000 m (16,404 ft) (maximum)
Non-operating	12,192 m (40,000 ft) (maximum)
Thermal dissipation	
U2722D/U2722DX	252.50 BTU/hour (maximum) 68.24 BTU/hour (on mode)
U2722DE	672.19 BTU/hour (maximum) 68.24 BTU/hour (on mode)



Pin Assignments

DP Port (in)

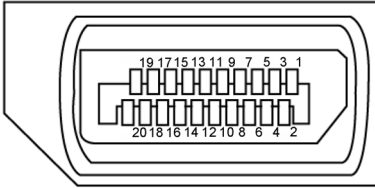

Pin number	20-pin side of the connected signal cable
1	ML3(n)
2	GND
3	ML3(p)
4	ML2(n)
5	GND
6	ML2(p)
7	ML1(n)
8	GND
9	ML1(p)
10	ML0(n)
11	GND
12	ML0(p)
13	CONFIG1
14	CONFIG2
15	AUX CH (p)
16	GND
17	AUX CH (n)
18	Hot Plug Detect
19	Return
20	DP_PWR



DP Port (out)

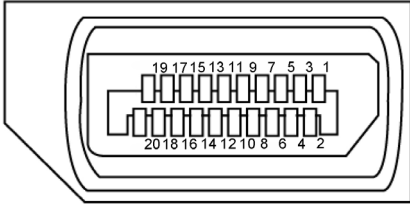

Pin number	20-pin side of the connected signal cable
1	ML0(p)
2	GND
3	ML0(n)
4	ML1(p)
5	GND
6	ML1(n)
7	ML2(p)
8	GND
9	ML2(n)
10	ML3(p)
11	GND
12	ML3(n)
13	CONFIG1
14	CONFIG2
15	AUX CH(p)
16	GND
17	AUX CH(n)
18	Hot Plug Detect
19	Return
20	DP_PWR



HDMI Port

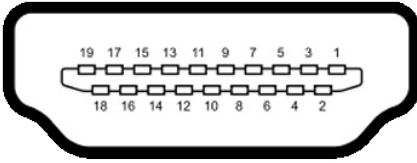

Pin number	19-pin side of the connected signal cable
1	TMDS DATA 2+
2	TMDS DATA 2 SHIELD
3	TMDS DATA 2-
4	TMDS DATA 1+
5	TMDS DATA 1 SHIELD
6	TMDS DATA 1-
7	TMDS DATA 0+
8	TMDS DATA 0 SHIELD
9	TMDS DATA 0-
10	TMDS CLOCK+
11	TMDS CLOCK SHIELD
12	TMDS CLOCK-
13	CEC
14	Reserved (N.C. on device)
15	DDC CLOCK (SCL)
16	DDC DATA (SDA)
17	DDC/CEC Ground
18	+5 V POWER
19	HOT PLUG DETECT



USB-C Port

USB Type-C receptacle

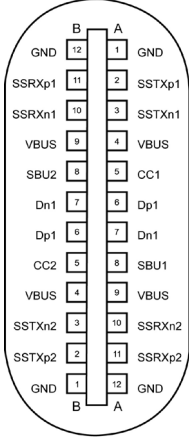



typically connected to a charger through a Type-C cable

Pin	Signal	Pin	Signal
A1	GND	B12	GND
A2	SSTXp1	B11	SSRXp1
A3	SSTXn1	B10	SSRXn1
A4	VBUS	B9	VBUS
A5	CC1	B8	SBU2
A6	Dp1	B7	Dn1
A7	Dn1	B6	Dp1
A8	SBU1	B5	CC2
A9	VBUS	B4	VBUS
A10	SSRXn2	B3	SSTXn2
A11	SSRXp2	B2	SSTXp2
A12	GND	B1	GND





Universal Serial Bus (USB) (U2722D/U2722DX)

This section gives you information about the USB ports available on your monitor.

 **NOTE: Up to 2 A on USB downstream port (port with  battery icon) with BC 1.2 compliance devices; up to 0.9 A on the other 2 USB downstream ports; Up to 3 A on USB-C downstream port (port with  icon) with 5 V/3 A compliance devices.**

Your monitor has the following USB ports:

- 1 upstream - at rear.
- 4 downstream - 2 at bottom, 2 at rear.

Power Charging Port - the ports with  battery icon supports fast current charging capability if the device is BC 1.2 compatible. The USB-C downstream port with  icon supports fast current charging capability if the device is 5V/3A compatible.

 **NOTE: The monitor's USB ports work only when the monitor is on or in Standby Mode. On in Standby Mode, if the USB cable (A to C or C to C) is plugged in, the USB ports can work normally. Otherwise, follow the OSD setting of USB Charging, if the setting is "On in Standby Mode" then USB work normally, otherwise USB is disabled. If you turn off the monitor and then turn it on, the attached peripherals may take a few seconds to resume normal functionality.**

Super speed USB 10 Gbps (USB 3.2 Gen2) Device

Transfer speed	Data rate	Maximum power consumption (each port)
Super speed+	10 Gbps	4.5 W
Super speed	5 Gbps	4.5 W



USB 2.0 Device

Transfer speed	Data rate	Maximum power consumption (each port)
Hi-Speed	480 Mbps	2.5 W
Full speed	12 Mbps	2.5 W
Low speed	1.5 Mbps	2.5 W





Universal Serial Bus (USB) (U2722DE)

This section gives you information about the USB ports available on your monitor.

 **NOTE: Up to 2 A on USB downstream port (port with  battery icon) with BC 1.2 compliance devices; up to 0.9 A on the other 3 USB downstream ports; Up to 3 A on USB-C downstream port (port with  icon) with 5 V/3 A compliance devices.**

Your monitor has the following USB ports:

- 2 upstream - at rear.
- 5 downstream - 2 at bottom, 3 at rear.

Power Charging Port - the ports with  battery icon supports fast current charging capability if the device is BC 1.2 compatible. The USB-C downstream port with  icon supports fast current charging capability if the device is 5V/3A compatible.

 **NOTE: The monitor's USB ports work only when the monitor is on or in Standby Mode. On in Standby Mode, if the USB cable (A to C or C to C) is plugged in, the USB ports can work normally. Otherwise, follow the OSD setting of Other USB Charging, if the setting is "On in Standby Mode" then USB work normally, otherwise USB is disabled. If you turn off the monitor and then turn it on, the attached peripherals may take a few seconds to resume normal functionality.**

Super speed USB 10 Gbps (USB 3.2 Gen2) Device

Transfer speed	Data rate	Maximum power consumption (each port)
Super speed+	10 Gbps	4.5 W
Super speed	5 Gbps	4.5 W
Hi-Speed *	480 Mbps	2.5 W
Full speed *	12 Mbps	2.5 W

 **NOTE: Device speed when High Resolution is selected.**

USB 2.0 Device

Transfer speed	Data rate	Maximum power consumption (each port)
Hi-Speed	480 Mbps	2.5 W
Full speed	12 Mbps	2.5 W
Low speed	1.5 Mbps	2.5 W



**USB 3.2 Gen2 (10Gbps)
downstream port (Bottom)**

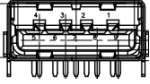

Pin number	Signal name
1	VBUS
2	D-
3	D+
4	GND
5	StdA_SSRX-
6	StdA_SSRX+
7	GND_DRAIN
8	StdA_SSTX-
9	StdA_SSTX+
Shell	Shield

**USB 3.2 Gen2 (10Gbps)
downstream port (Rear)**

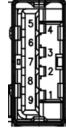

Pin number	Signal name
1	VBUS
2	D-
3	D+
4	GND
5	StdA_SSRX-
6	StdA_SSRX+
7	GND_DRAIN
8	StdA_SSTX-
9	StdA_SSTX+
Shell	Shield

RJ45 Port (Connector Side) (U2722DE Only)

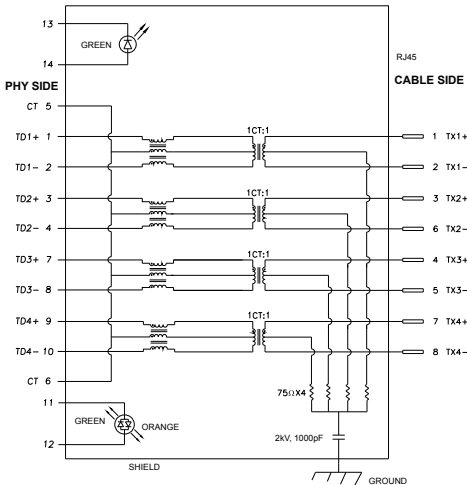

Pin	Signal	Pin	Signal
1	TD1 +	8	TD3 -
2	TD1 -	9	TD4 +
3	TD2 +	10	TD4 -
4	TD2 -	11	GREEN_ORANGE
5	CT	12	GREEN_ORANGE
6	CT	13	GREEN
7	TD3 +	14	GREEN



Driver installation

Install the Realtek USB GBE Ethernet Controller Driver available for your system. This is available for download at <https://www.dell.com/support> under the “Driver and download” section.

Network (RJ45) data rate via USB-C max speed is 1000 Mbps.

NOTE: This LAN port is 1000Base-T IEEE 802.3az compliant, supporting Mac Address (Printed on model label) Pass-thru, Wake-on-LAN (WOL) from standby mode (S3 only) and PXE Boot function, these 3 features depend on BIOS setting and OS version.

RJ45 Connector LED Status (U2722DE Only):

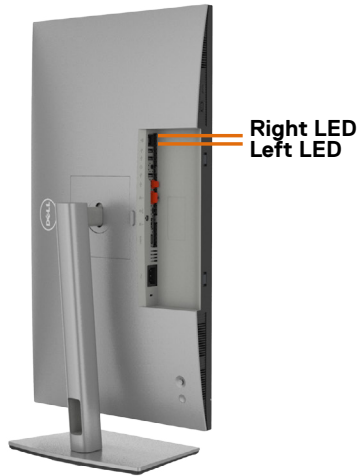

LED	Color	Description
Right LED	Amber or Green	Speed indicator: <ul style="list-style-type: none">• Amber On - 100 0 Mbps• Green On - 100 Mbps• Off - 10 Mbps
Left LED	Green	Link / Activity indicator: <ul style="list-style-type: none">• Blinking - Activity on the port.• Green On - Link is being established.• Off - Link is not established.

NOTE: RJ45 cable is non in-box standard accessory.



Plug-and-Play

You can install the monitor in any Plug-and-Play-compatible system. The monitor automatically provides the computer system with its extended display identification data (EDID) using display data channel (DDC) protocols so the computer can configure itself and optimize the monitor settings. Most monitor installations are automatic; you can select different settings if desired. For more information about changing the monitor settings, see [Operating the Monitor](#).

LCD Monitor Quality and Pixel Policy

During the LCD monitor manufacturing process, it is not uncommon for one or more pixels to become fixed in an unchanging state which are hard to see and do not affect the display quality or usability. For more information on LCD Monitor Pixel Policy, see Dell support site at: <https://www.dell.com/pixelguidelines>.

Ergonomics

⚠ CAUTION: Improper or prolonged usage of keyboard may result in injury.

⚠ CAUTION: Viewing the monitor screen for extended periods of time may result in eye strain.

For comfort and efficiency, observe the following guidelines when setting up and using your computer workstation:

- Position your computer so that the monitor and keyboard are directly in front of you as you work. Special shelves are commercially available to help you correctly position your keyboard.
- To reduce the risk of eye strain and neck/arm/back/shoulder pain from using the monitor for long periods of time, we suggest you to:
 1. Set the distance of the screen between 20 to 28 in. (50 - 70 cm) from your eyes.
 2. Blink frequently to moisten your eyes or wet your eyes with water after prolonged usage of the monitor.
 3. Take regular and frequent breaks for 20 minutes every two hours.
 4. Look away from your monitor and gaze at a distant object at 20 feet away for at least 20 seconds during the breaks.
 5. Perform stretches to relieve tension in the neck, arm, back, and shoulders during the breaks.
- Make sure that the monitor screen is at eye level or slightly lower when you are sitting in front of the monitor.
- Adjust the tilt of the monitor, its contrast, and brightness settings.



- Adjust the ambient lighting around you (such as overhead lights, desk lamps, and the curtains or blinds on nearby windows) to minimize reflections and glare on the monitor screen.
- Use a chair that provides good lower-back support.
- Keep your forearms horizontal with your wrists in a neutral, comfortable position while using the keyboard or mouse.
- Always leave space to rest your hands while using the keyboard or mouse.
- Let your upper arms rest naturally on both sides.
- Ensure that your feet are resting flat on the floor.
- When sitting, make sure that the weight of your legs is on your feet and not on the front portion of your seat. Adjust your chair's height or use a footrest if necessary to maintain a proper posture.
- Vary your work activities. Try to organize your work so that you do not have to sit and work for extended periods of time. Try to stand or get up and walk around at regular intervals.
- Keep the area under your desk clear of obstructions and cables or power cords that may interfere with comfortable seating or present a potential trip hazard.

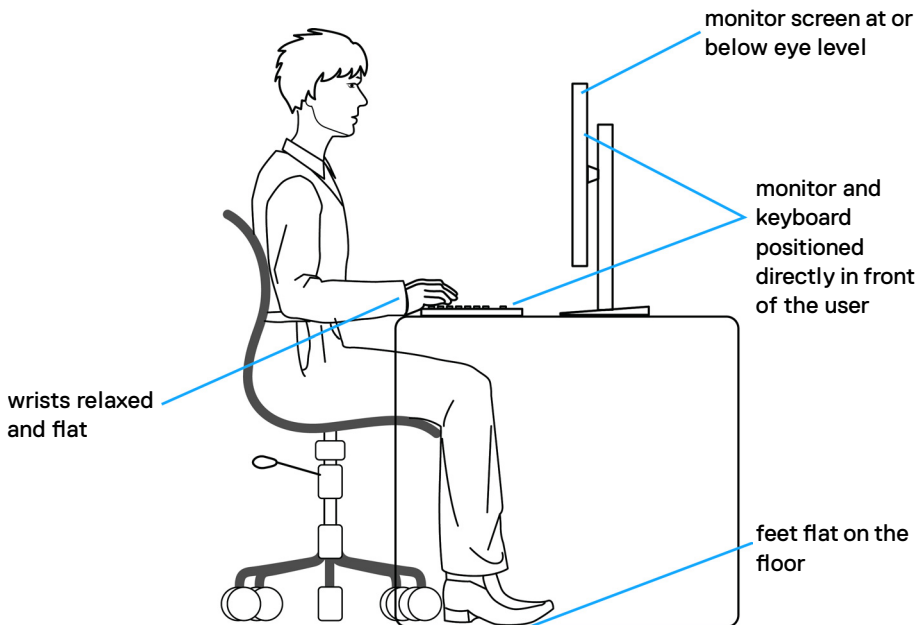

Handling and Moving Your Display

To ensure the monitor is handled safely when lifting or moving it, follow the guidelines mentioned below:

- Before moving or lifting the monitor, turn off your computer and the monitor.
- Disconnect all cables from the monitor.
- Place the monitor in the original box with the original packing materials.
- Hold the bottom edge and the side of the monitor firmly without applying excessive pressure when lifting or moving the monitor.

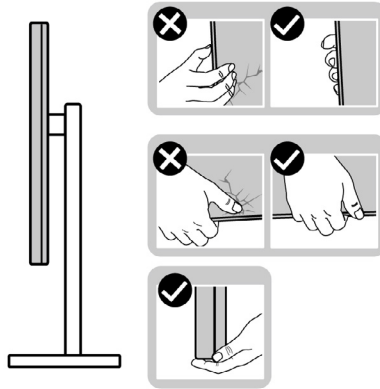

- When lifting or moving the monitor, ensure the screen is facing away from you and do not press on the display area to avoid any scratches or damage.

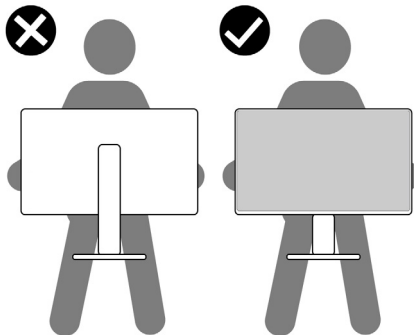

- When transporting the monitor, avoid any sudden shock or vibration to it.



- When lifting or moving the monitor, do not turn the monitor upside down while holding the stand base or stand riser. This may result in accidental damage to the monitor or cause personal injury.

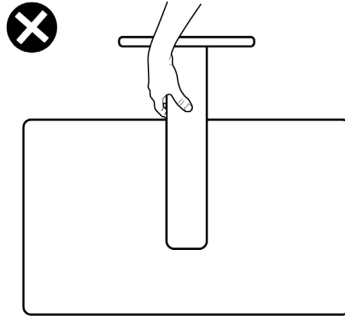

Maintenance Guidelines

Cleaning Your Monitor

- ⚠ **WARNING:** Before cleaning the monitor, unplug the monitor power cable from the electrical outlet.
- ⚠ **CAUTION:** Read and follow the [Safety Instructions](#) before cleaning the monitor.



For best practices, follow these instructions in the list below while unpacking, cleaning, or handling your monitor:

- To clean your anti-static screen, lightly dampen a soft, clean cloth with water. If possible, use a special screen-cleaning tissue or solution suitable for the antistatic coating. Do not use benzene, thinner, ammonia, abrasive cleaners, or compressed air.
- Use a lightly-dampened, soft cloth to clean the monitor. Avoid using detergent of any kind as some detergents leave a milky film on the monitor.
- If you notice white powder when you unpack your monitor, wipe it off with a cloth.
- Handle your monitor with care as a darker-colored monitor may get scratched and show white scuff marks more than a lighter-colored monitor.
- To help maintain the best image quality on your monitor, use a dynamically changing screen saver and turn off your monitor when not in use.



Setting Up the Monitor

Connecting the Stand

-  **NOTE:** The stand riser and stand base are detached when the monitor is shipped from the factory.
-  **NOTE:** The following instructions are applicable only for the stand that was shipped with your monitor. If you are connecting a stand that you purchased from any other source, follow the set up instructions that were included with the stand.

To attach the monitor stand:

1. Open the front flap of the box to get the stand riser and stand base.

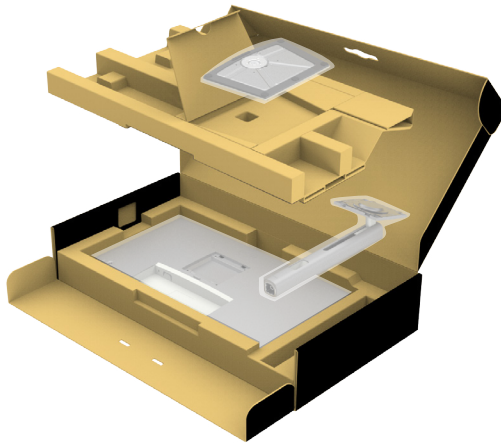

2. Align and place the stand riser on the stand base.
3. Open the screw handle at the bottom of the stand base and turn it clockwise to secure the stand assembly.



4. Close the screw handle.

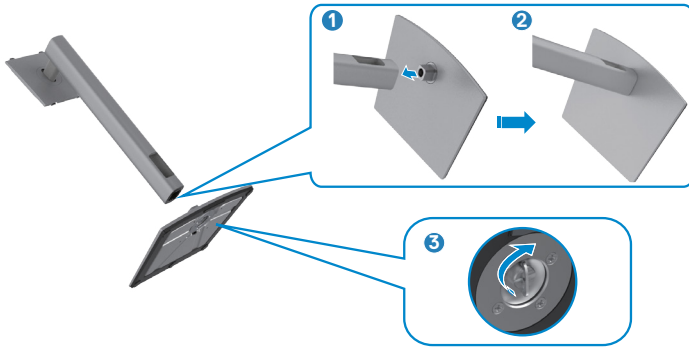

5. Open the protective cover on the monitor to access the VESA slot on the monitor.

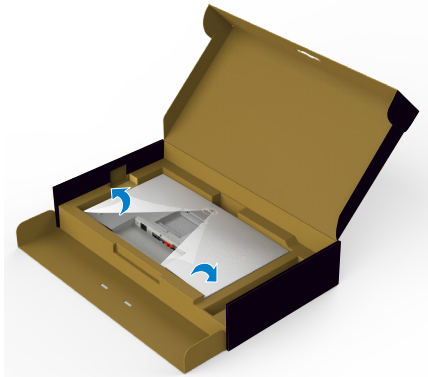

6. Slide the tabs on the stand riser into the slots on the display back cover and lower the stand assembly to snap it into place.

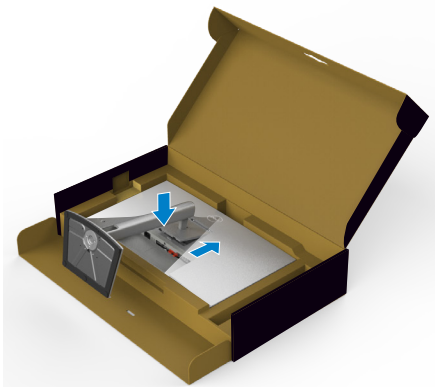

7. Hold the stand riser and lift the monitor carefully, then place it on a flat surface.

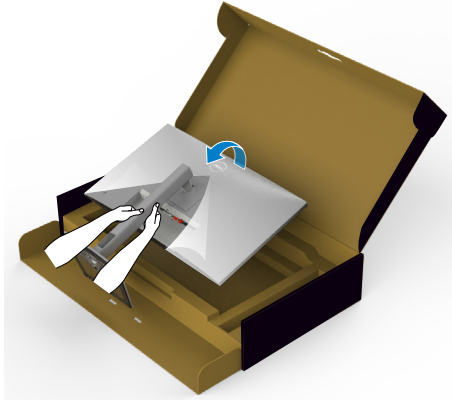

NOTE: Hold the stand riser firmly when lifting the monitor to avoid any accidental damage.

8. Lift the protective cover from the monitor.

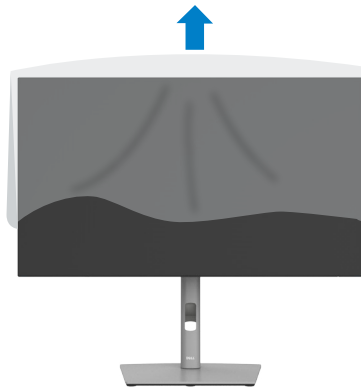

Using the Tilt, Swivel, and Vertical Extension

NOTE: The following instructions are applicable only for the stand that was shipped with your monitor. If you are connecting a stand that you purchased from any other source, follow the set up instructions that were included with the stand.

Tilt, Swivel and Vertical Extension

With the stand attached to the monitor, you can tilt the monitor for the most comfortable viewing angle.

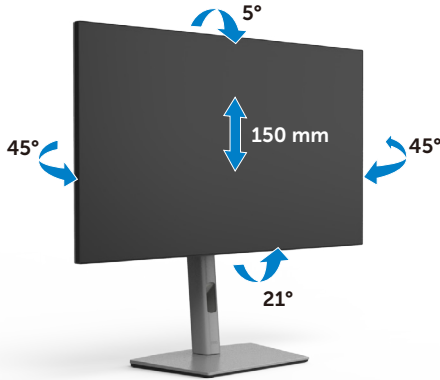



NOTE: The stand is detached when the monitor is shipped from the factory.

Rotating the Display

Before you rotate the display, extend the display vertically until the top of the stand riser and then tilt the display backwards until the maximum to avoid hitting the bottom edge of the display.



-  **NOTE:** To toggle the display setting on your Dell computer between landscape and portrait when rotating the display, download and install the latest graphics driver. To download, go to <https://www.dell.com/support/drivers> and search for the appropriate driver.
-  **NOTE:** When the display is in portrait mode, you may experience performance degradation when using graphic-intensive applications such as 3D gaming.

Configuring the Display Settings on Your Computer after Rotation

After you have rotated the display, complete the procedure given below to configure the display settings on your computer.

-  **NOTE:** If you are using the monitor with a non-Dell computer, go to the graphics card manufacturer's website or your computer manufacturer website for information on how to rotate the contents of your display.

To configure the Display Settings:

1. Right-click on the **Desktop** and click **Properties**.
 2. Select the **Settings** tab and click **Advanced**.
 3. If you have an AMD graphics card, select the **Rotation** tab and set the preferred rotation.
 4. If you have an **nVidia** graphics card, click the **nVidia** tab, in the left-hand column select **NVRotate**, and then select the preferred rotation.
 5. If you have an Intel® graphics card, select the Intel graphics tab, click **Graphic Properties**, select the **Rotation** tab, and then set the preferred rotation.
-  **NOTE:** If you do not see the rotation option or it is not working correctly, go to <https://www.dell.com/support> and download the latest driver for your graphics card.



Organizing Your Cables



After attaching all necessary cables to your monitor and computer, (see [Connecting Your Monitor](#) for cable attachment) organize all cables as shown above.

If your cable is not able to reach your PC, you may connect directly to the PC without routing through the slot on the monitor stand.



Connecting Your Monitor

 **WARNING:** Before you begin any of the procedures in this section, follow the [Safety Instructions](#).

To connect your monitor to the computer:

1. Turn off your computer.
2. Connect the DisplayPort or USB cable, and the USB-C cable from your monitor to the computer.
3. Turn on your monitor.
4. Select the correct input source from the OSD Menu on your monitor and then turn on your computer.

 **NOTE:** U2722D/U2722DX/U2722DE default setting is DisplayPort 1.4. A DisplayPort 1.1 Graphic card may not display normally. Please refer to “[product specific problems – No image when using DP connection to the PC](#)” to change default setting.



U2722D/U2722DX

Connecting the HDMI Cable (U2722DX (Inbox) / U2722D (Optional))



Connecting the DP Cable



Connecting the Monitor for DP Multi-Stream Transport (MST) Function

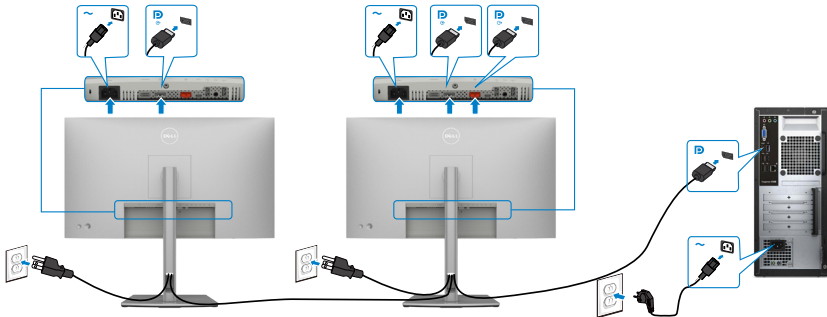

NOTE: Supports the DP MST feature. To make use of this feature, your PC Graphics Card must be certified to at least DP1.2 with MST option.

NOTE: Remove the rubber plug when using DP out connector.

Connecting the USB-C Cable (A to C)

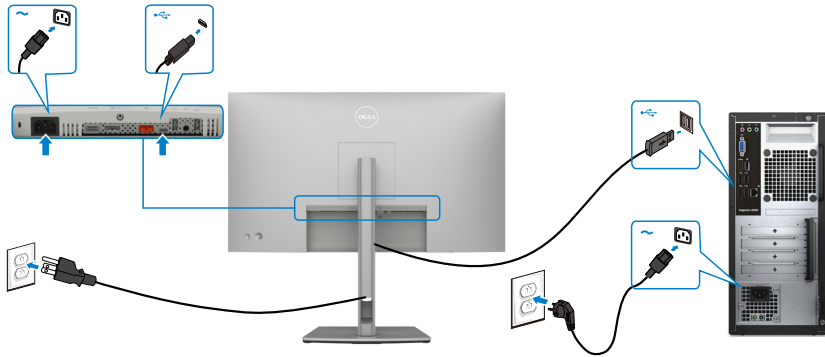

NOTE: This connection only data is available and no video. Need another video connection for display.

Connecting the USB-C Cable (C to C) (Optional)

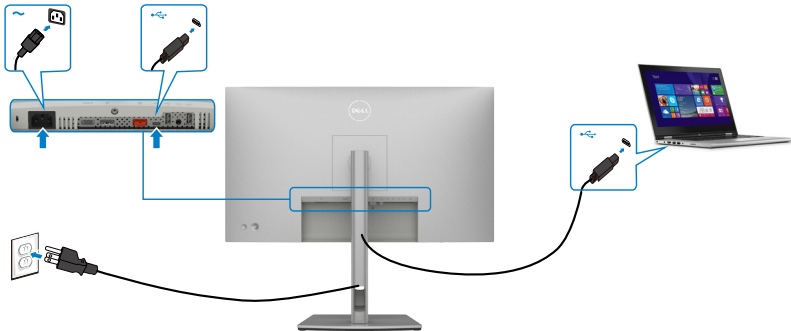

NOTE: This connection is only upstream available and no video. Need another video connection for display.



U2722DE

Connecting the HDMI Cable (Optional)

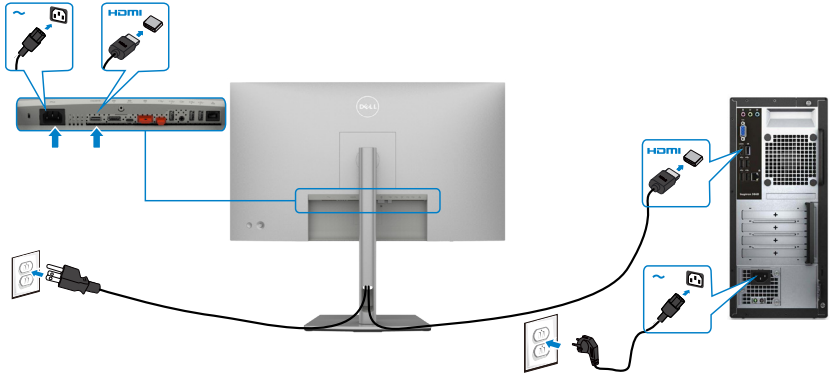

Connecting the DP Cable



Connecting the Monitor for DP Multi-Stream Transport (MST) Function

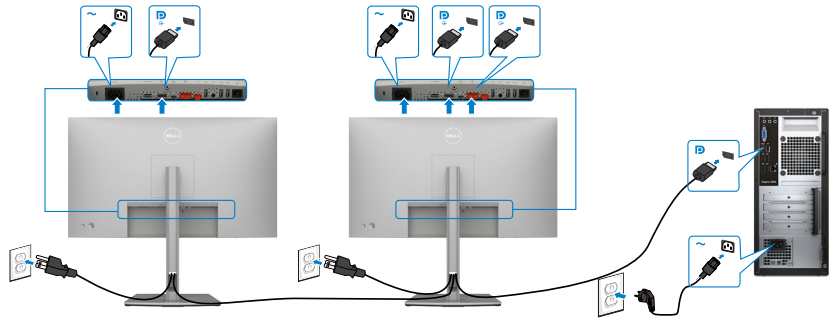

NOTE: Supports the DP MST feature. To make use of this feature, your PC Graphics Card must be certified to at least DP1.2 with MST option.

NOTE: Remove the rubber plug when using DP out connector.

Connecting the USB-C Cable (A to C)

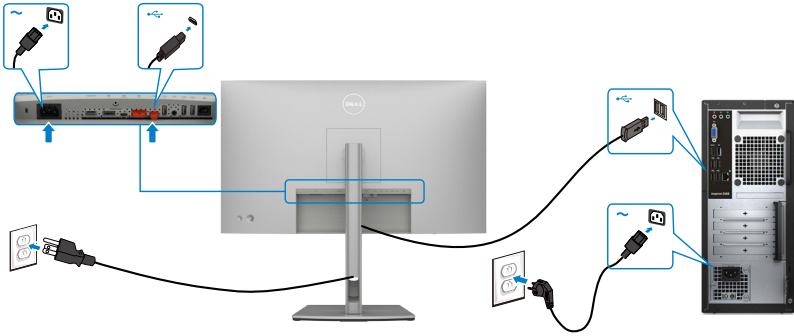

NOTE: This connection only data is available and no video. Need another video connection for display.

Connecting the USB-C Cable (C to C)

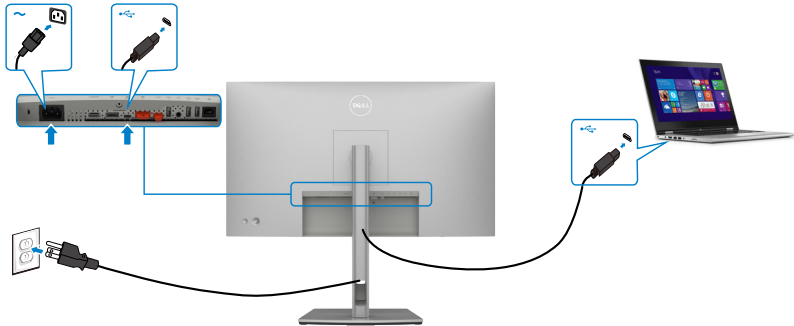

The USB-C port on your monitor:

- Can be used as USB-C or DisplayPort 1.4, alternatively.
- Supports USB Power Delivery (PD), with profiles up to 90W.

NOTE: Regardless of the power requirement/actual power consumption of your laptop, or the remaining power runtime in your battery, the Dell U2722DE monitor is designed to supply power delivery of up to 90 W to your laptop.



Rated power (on laptops that have USB-C with Power Delivery)	Maximum charging power
45 W	45 W
65 W	65 W
90 W	90 W
130 W	Not supported

Connecting the Monitor for USB-C Multi-Stream Transport (MST) Function

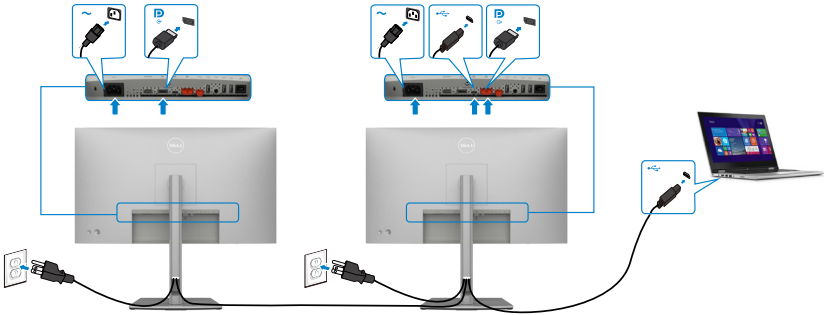

NOTE: The maximum number of supported U2722DE via MST is subjected to the bandwidth of the USB-C source. Please refer to “[product specific problems –No image when using USB-C MST](#)”.

NOTE: Remove the rubber plug when using DP out connector.

Connecting the Monitor for RJ45 Cable (Optional)

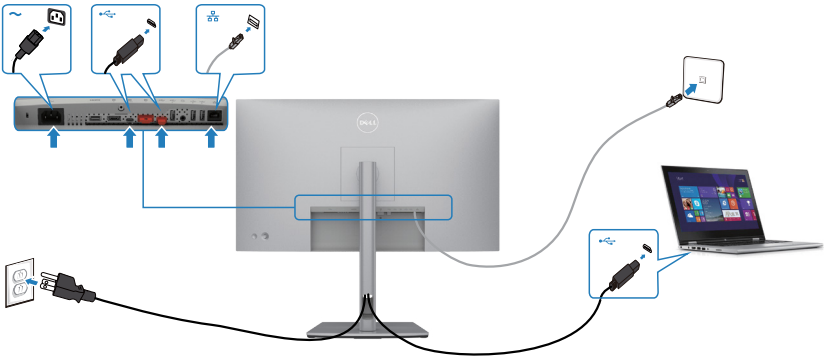

Dell Power Button Sync (DPBS) (U2722DE Only)

- The U2722DE monitor is designed with Dell Power Button Sync (DPBS) feature to allow you to control PC system power state from the monitor power button. This feature is compatible with Dell OptiPlex 7090/3090 Ultra platform, and is only supported over USB-C interface.

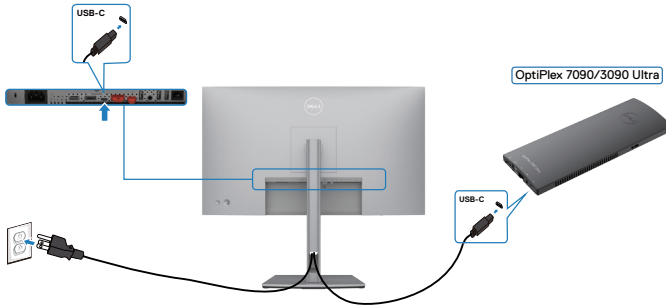

- To make sure the DPBS function works for the first time, you should do the following steps for Dell OptiPlex 7090/3090 Ultra platform in the **Control Panel** first.

NOTE: DPBS only supports the port with  icon.

Go to **Control Panel**.

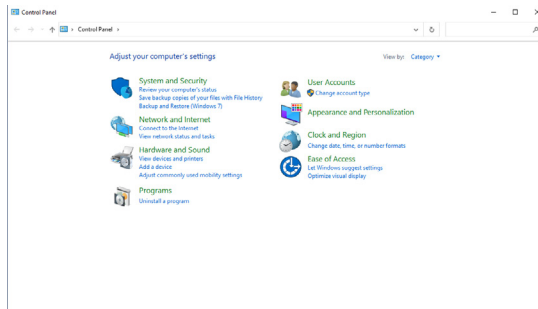

Select **Hardware and Sound**, followed by **Power Options**.

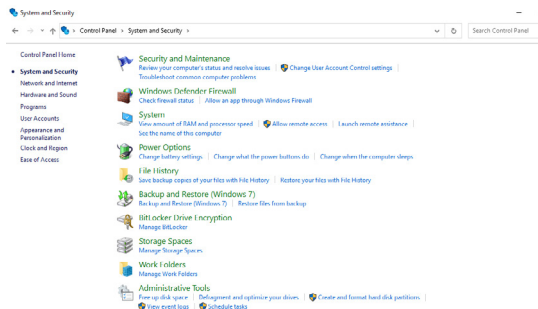

Go to **System Settings**.

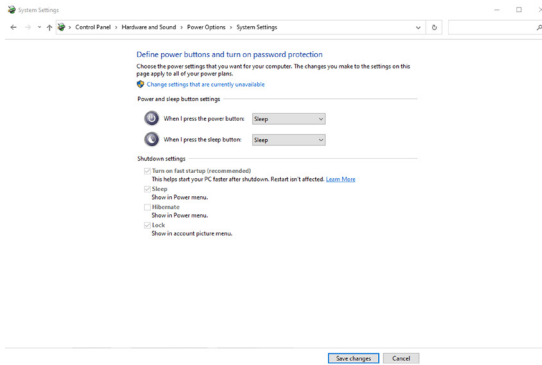

In the drop-down menu of **When I press the power button**, there are a few options for selection namely **Do nothing/Sleep/Hibernate/Shut down**, and you can select **Sleep/Hibernate/Shut down**.

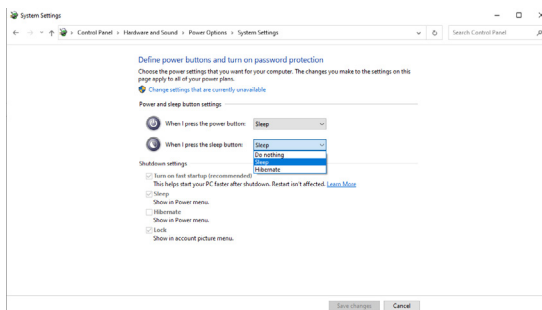
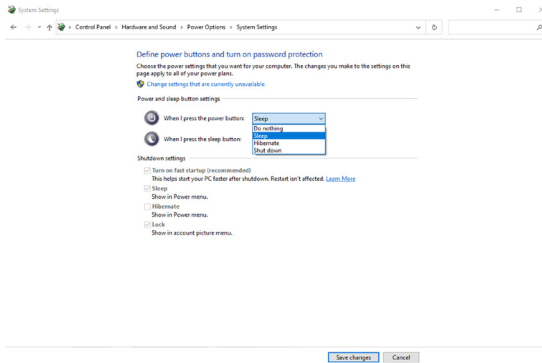

 **NOTE:** Do not select **Do nothing**, otherwise monitor power button cannot sync with PC system power state.



Connecting the Monitor for DPBS for the First Time

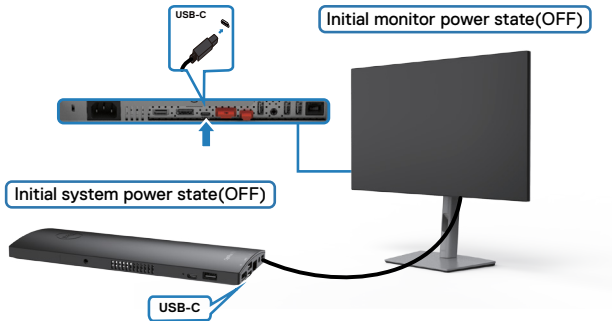

For the first time setting up the DPBS function, please follow below steps:

1. Make sure both the PC and monitor is OFF.
2. Connect the USB-C cable from the PC to the monitor.
3. Press the monitor power button to turn ON the monitor.
4. Both the monitor and PC will turn ON momentarily. Wait for a while (approximately 6 seconds) and both the PC and monitor will turn OFF.
5. Press either the monitor power button or PC power button, both the PC and monitor will turn ON. The PC system power state is in sync with the monitor power button.

NOTE: When the monitor and PC are both at power OFF state at first time, it is recommended that you turn ON the monitor first, then connect the USB-C cable from the PC to the monitor.

NOTE: You can power the OptiPlex 7090/3090 Ultra platform using its DC adaptor jack. Alternatively, you can power the OptiPlex 7090/3090 Ultra platform using the monitor's USB-C cable via Power Delivery (PD); please set USB-C Charging to On in Off Mode.



Using DPBS Function

When you press the monitor power button or PC power button, the Monitor / PC state is as follows:

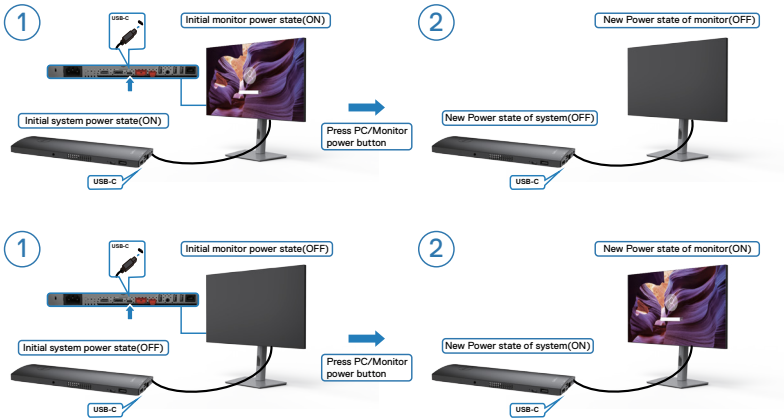

When the monitor and PC power state are both ON, while you **press and hold 4 seconds on monitor power button**, the screen prompt will ask if you would like to shut down the PC.

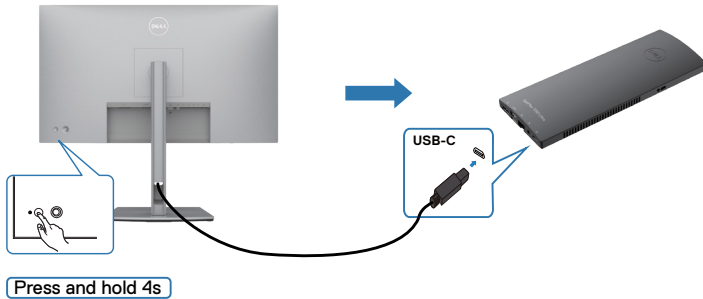

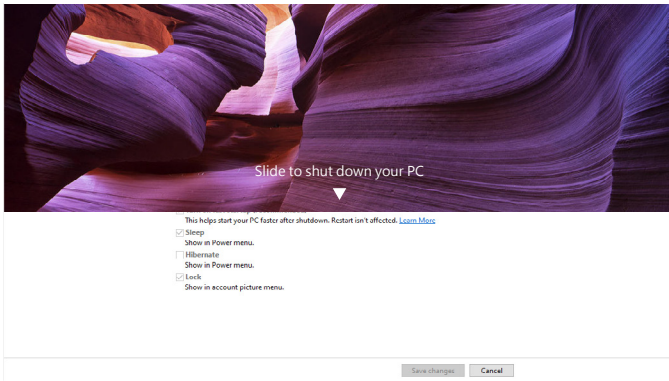

When the monitor and PC power state are both ON, while **you press and hold 10 seconds on monitor power button**, the PC will shut down.

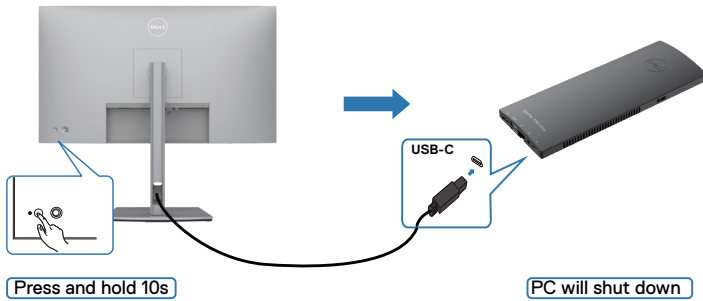

Connecting the Monitor for USB-C Multi-Stream Transport (MST) function

A PC is connected to two monitors in an initially OFF power state, and the PC system power state is in sync with Monitor 1 power button. When you press the Monitor 1 or PC power button, both the Monitor 1 and PC turns ON. Meanwhile the Monitor 2 will remain OFF. You need to manually press the power button on Monitor 2 to turn it ON.

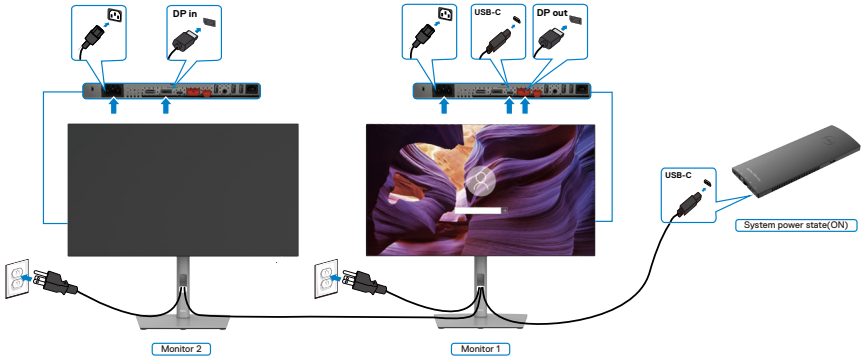

Similarly, a PC is connected to two monitors in an initially ON power state, and the PC system power state is in sync with Monitor 1 power button. When you press the Monitor 1 or PC power button, both the Monitor 1 and PC turns OFF. Meanwhile the Monitor 2 will be in Standby mode. You need to manually press the power button on Monitor 2 to turn it OFF.

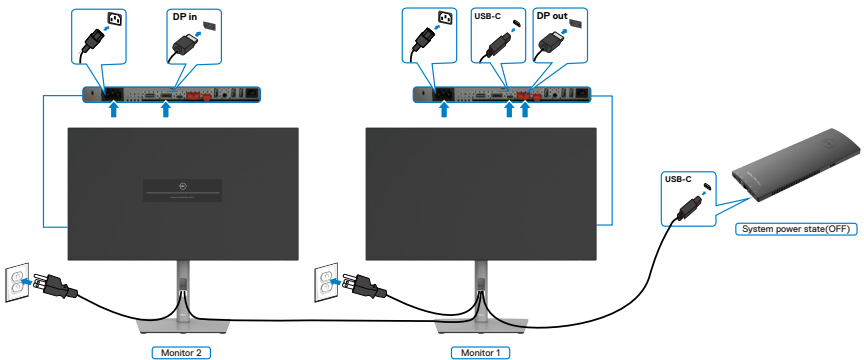

Connecting the Monitor for USB-C

The Dell OptiPlex 7090 Ultra platform has two USB-C ports, so both Monitor 1 and Monitor 2 power state can sync with the PC.

While the PC and two monitors are in an initially ON power state, by pressing the power button on Monitor 1 or Monitor 2 will turn OFF the PC, Monitor 1, and Monitor 2.

NOTE: DPBS only supports the port with  icon.

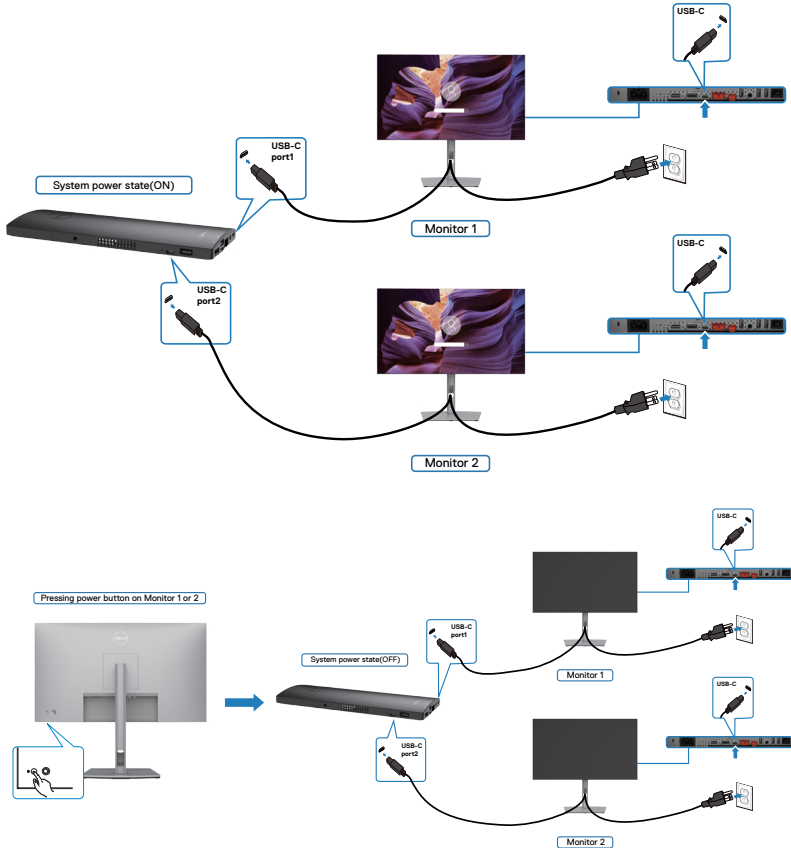

Make sure to set **USB-C Charging** to On in Off Mode. While the PC and two monitors are in an initially OFF power state, by pressing the power button on Monitor 1 or Monitor 2 will turn ON the PC, Monitor1, and Monitor 2.

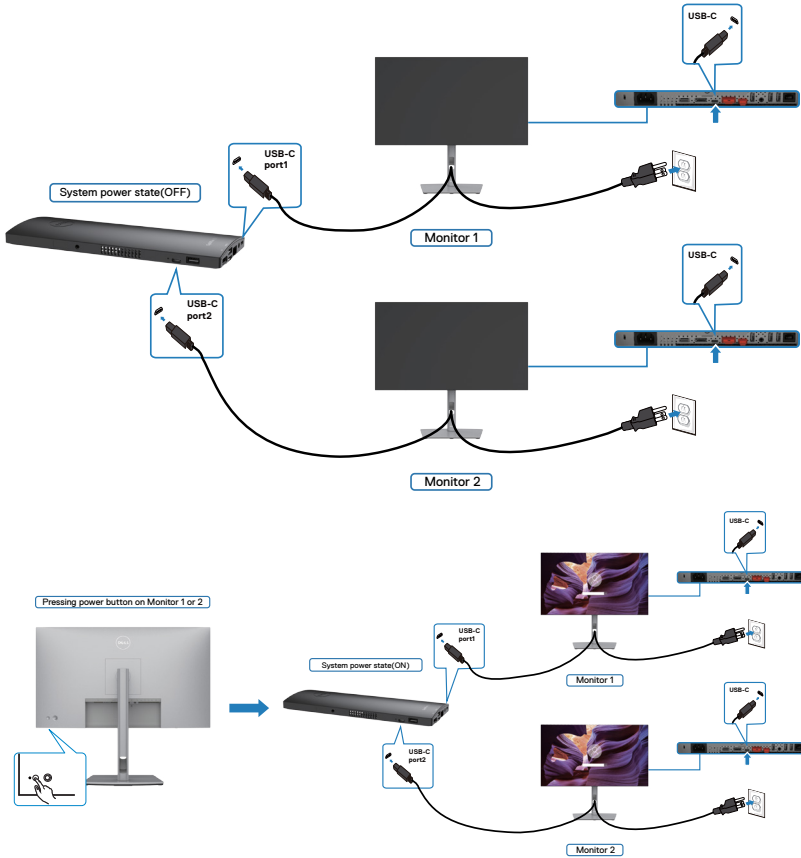

Securing Your Monitor Using Kensington Lock (Optional)

The security lock slot is located at the bottom of the monitor. (See [Security lock slot](#))

For more information on using the Kensington lock (purchased separately), see the documentation that is shipped with the lock.

Secure your monitor to a table using the Kensington security lock.

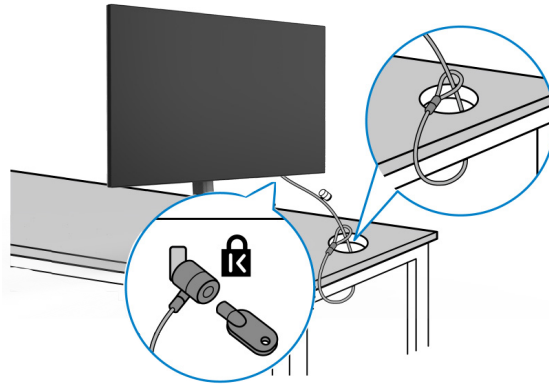

NOTE: The image is for the purpose of illustration only. Appearance of the lock may vary.



Removing the Monitor Stand

CAUTION: To prevent scratches on the LCD screen when removing the stand, ensure that the monitor is placed on a soft, clean surface.

NOTE: The following instructions are applicable only for the stand that was shipped with your monitor. If you are connecting a stand that you purchased from any other source, follow the set up instructions that were included with the stand.

To Remove the Stand:

1. Place the monitor on a soft cloth or cushion.
2. Press and hold the stand-release button.
3. Lift the stand up and away from the monitor.

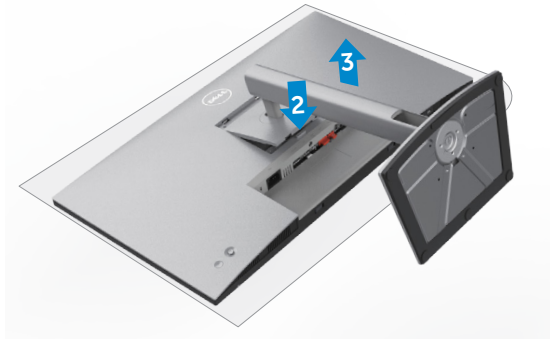

Wall Mounting (Optional)



NOTE: Use M4 x 10 mm screws to connect the monitor to the wall-mounting kit.

Refer to the instructions that come with the VESA-compatible wall mounting kit.

1. Place the monitor on a soft cloth or cushion on a stable flat table.
2. Remove the stand.
3. Use a Phillips crosshead screwdriver to remove the four screws securing the plastic cover.
4. Attach the mounting bracket from the wall mounting kit to the monitor.
5. Mount the monitor on the wall as instructed in the documentation that shipped with the wall-mounting kit.

NOTE: For use only with UL or CSA or GS-listed wall mount bracket with minimum weight/load bearing capacity of 17.52 kg (38.6 lb) (U2722D/ U2722DX) / 19.12 kg (42.15 lb) (U2722DE).



Operating the Monitor

Power On the Monitor

Press the  button to turn on the monitor.

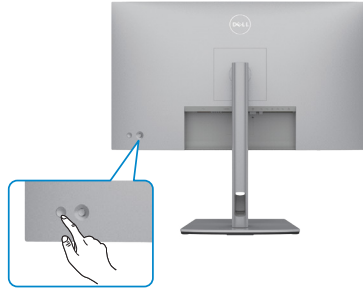

Using the Joystick Control





To modify the OSD adjustments using the Joystick control on the rear end of the monitor, do the following:

1. Press the Joystick to open the OSD Menu Launcher.
2. Move the Joystick up/down/left/right to toggle between the OSD menu options.



Joystick Functions

Function	Description
	Press Joystick to open the OSD Menu Launcher.
	For right and left navigation.
	For up and down navigation.

Using the Menu Launcher

Press the Joystick to open the OSD Menu Launcher.

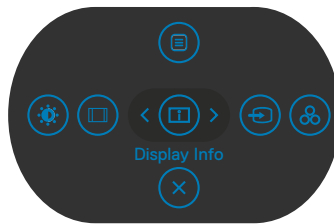







Menu Launcher

- Toggle the Joystick **Up** to open the **Main Menu**.
- Toggle the Joystick **Left** or **Right** to select the desired **Shortcut Keys**.
- Toggle the Joystick **Down** to **Exit**.



Menu Launcher Details

The following table describes the Menu Launcher icons:





Menu Launcher Icon	Description
 Main Menu	Opens the On-Screen Display (OSD). See Using the Main Menu
 Display Info (Shortcut key 1)	Displays the monitor's current status.
 Input Source (Shortcut key 2)	Sets the Input Source .
 Preset Modes (Shortcut key 3)	Allows to choose from a list of Preset color modes .
 Brightness/Contrast (Shortcut key 4)	To directly access the Brightness/Contrast adjustment sliders.
 Aspect Ratio (Shortcut key 5)	Adjusts the aspect ratio of your screen.
 Exit	Exits from the OSD main menu.

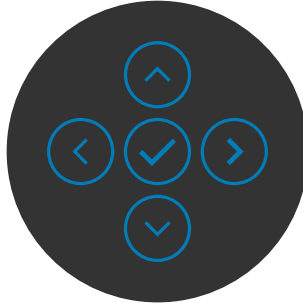

Front-Panel Button



Use the buttons on the front of the monitor to adjust the image settings.







Front Panel	Description
1   Up Down	Use the Up (increase) and Down (decrease) buttons to adjust items in the OSD menu.
2  Previous	Use the Previous button to go back to the previous menu.
3  Next	Use the Next button to confirm your selection.
4  Tick	Use the Tick button to confirm your selection.

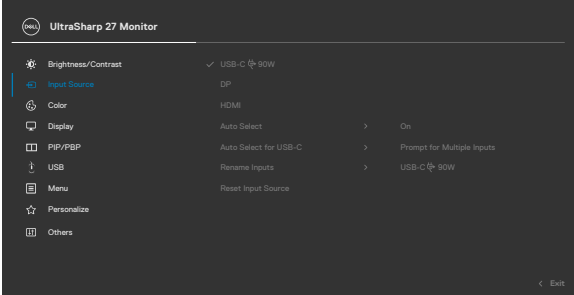

Using the Main Menu

Icon	Menu and Submenus	Description
	Brightness/Contrast	Activates Brightness/Contrast adjustment.
		 
	Brightness	Adjusts the luminance of the backlight (Range: 0 - 100). Move the Joystick Up to increase brightness. Move the Joystick Down to decrease brightness.
	Contrast	Adjust the Brightness first, and then adjust Contrast only if further adjustment is necessary. Move the Joystick Up to increase contrast and Move the Joystick Down to decrease contrast (Range: 0 - 100). The Contrast function adjusts the degree of difference between darkness and lightness on the monitor screen.



Icon	Menu and Submenus	Description
	Input Source	Selects between different video inputs that are connected to your monitor.
		
		
USB-C 90W (U2722DE only)	Select USB-C 90W input when you are using the USB-C 90W connector. Press the Joystick button to confirm the selection.	
DP	Select DP input when you are using the DP (DisplayPort) connector. Press the Joystick button to confirm the selection.	
HDMI	Select the HDMI input when you are using the HDMI connector. Press the Joystick button to confirm the selection.	
Auto Select	Allows you to scan for available input sources. Press  to select this function.	
Auto Select for USB-C (U2722DE only)	<p>Press  to select these functions:</p> <ul style="list-style-type: none"> ◆ Prompt for Multiple Inputs: always show Switch to USB-C Video Input message for user to choose whether to switch or not. ◆ Yes: The monitor always switch to USB-C video without asking while USB-C connected. ◆ No: The monitor will NOT auto switch to USB-C video from another available input. 	
Rename Inputs	Allows you to Rename Inputs .	
Reset Input Source	Resets all settings under the Input Source menu to the factory defaults. Press  to select this function.	



Icon Menu and Submenus

Description



Color

Adjusts the color setting mode.

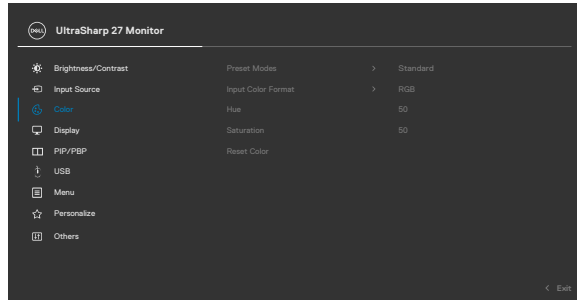

Preset Modes

When you select Preset Modes, you can choose **Standard**, **Movie**, **Game**, **Color Temp.**, **Color Space** or **Custom Color** from the list.

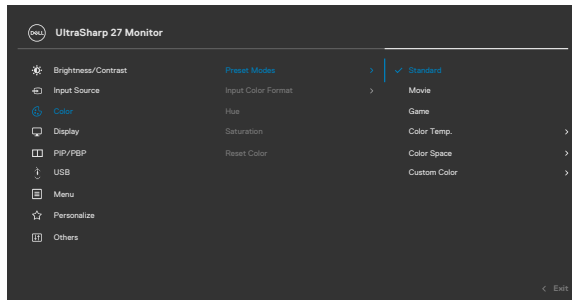

- ◆ **Standard:** Default Color setting, This monitor uses a low blue light panel, and is certified by TUV to reduce blue light output and create a more relaxing and less stimulating image while reading content on the screen.
- ◆ **Movie:** Ideal for movies.
- ◆ **Game:** Ideal for most gaming applications.
- ◆ **Color Temp.:** The screen appears warmer with a red/yellow tint with slider set at 5,000K or cooler with blue tint with slider set at 10,000K.



Icon	Menu and Submenus	Description
		<ul style="list-style-type: none"> • Color Space: Allows users to select the color space: sRGB, Rec. 709, DCI-P3. • Custom Color: Allows you to manually adjust the color settings. Press the Joystick left and right buttons to adjust the Red, Green, and Blue values and create your own preset color mode.

Input Color Format

Allows you to set the video input mode to:

- **RGB:** Select this option if your monitor is connected to a computer or a media player that supports RGB output.
- **YCbCr:** Select this option if your media player supports only YCbCr output.

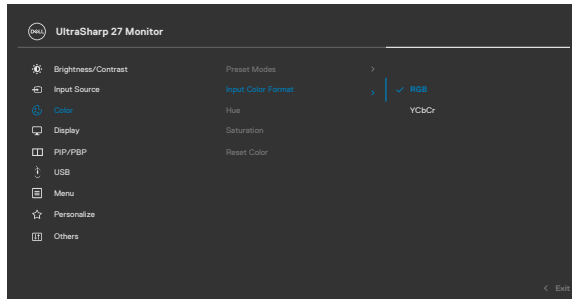

Hue	Use Joystick Up or Down to adjust the Hue from 0 to 100. NOTE: Hue adjustment is available only for Movie and Game mode.
------------	---

Saturation	Use Joystick Up or Down to adjust the Saturation from 0 to 100. NOTE: Saturation adjustment is available only for Movie and Game mode.
-------------------	---

Reset Color	Resets your monitor's color settings to the factory defaults. Press  to select this function.
--------------------	--



Icon	Menu and Submenus	Description
------	-------------------	-------------



Display

Use the **Display** menu to adjust image.

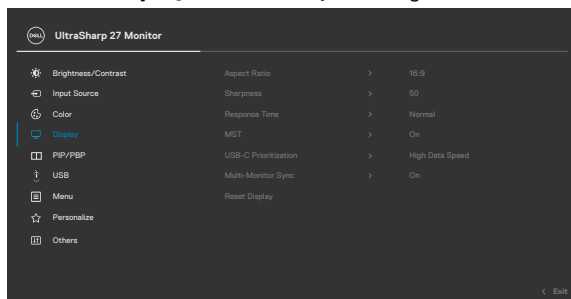

Aspect Ratio Adjust the image ratio to **Wide 16:9, Auto Resize, 4:3, 1:1**.

Sharpness Makes the image look sharper or softer.

Move the Joystick up and down to adjust the sharpness from '0' to '100'.

Response Time Allows you to set the **Response Time** to **Normal** or **Fast**.

MST

DP Multi Stream Transport, Set to **ON** enables MST (DP out), Set to **OFF** disables MST function.

NOTE: When DP/USB-C upstream cable and DP downstream cable is connected, monitor will set MST = ON automatically, this action will only be done once after Factory Reset or Display Reset. Please refer to **“Connecting the Monitor for DP Multi-Stream Transport (MST) Function”**.

USB-C

Prioritization (U2722DE Only)

Allows you to specify the priority to transfer the data with high resolution (High Resolution) or high speed (High Data Speed) when using the USB-C port/DisplayPort.



Icon	Menu and Submenus	Description
------	-------------------	-------------

Multi-Monitor Sync

Multi-Monitor Sync allows multiple monitors that are daisy chained via DisplayPort to synchronize a pre-defined group of OSD settings in the background.

An OSD option, “**Multi-Monitor Sync**” will be created in Display Menu to allow user to enable/disable syncing.

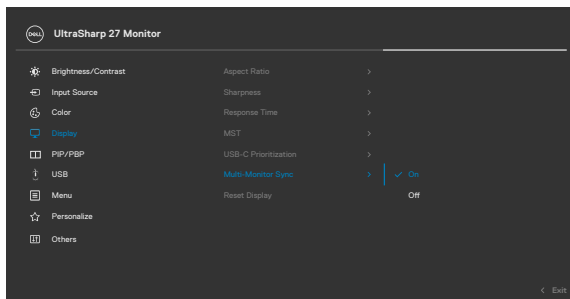

Reset Display

Resets all settings under the **Display** menu to the factory defaults.

Press  to select this function.



Icon Menu and Submenus

Description



PIP/PBP

This function brings up a window displaying image from another input source.

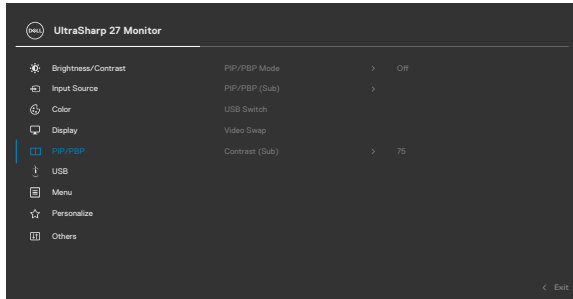

Main Window	Sub-Window	
	USB-C	DP
USB-C	✓	✓
DP	✓	✓

NOTE: The images under PBP will be displayed at the center of the screen, not full screen.



Icon	Menu and Submenus	Description
------	-------------------	-------------

PIP/PBP Mode Adjusts the PIP or PBP (Picture by Picture) mode. You can disable this feature by selecting Off.

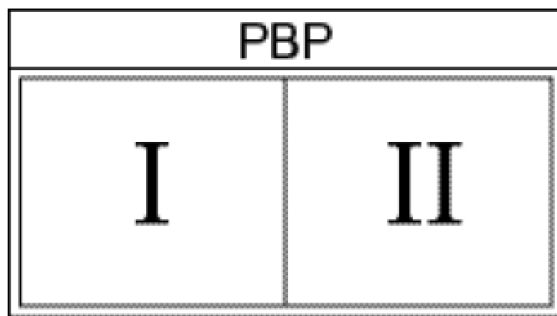
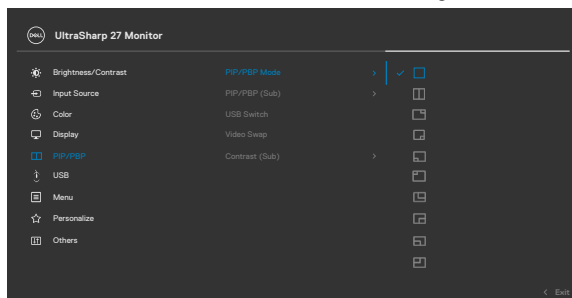

Icon	Menu and Submenus	Description
------	-------------------	-------------

PIP/PBP (Sub) Select between the different video signals that may be connected to your monitor for the PBP sub-window. Press the  button to select the PBP sub-window source signal.

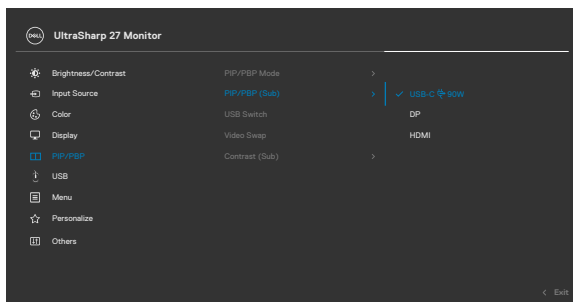

USB Switch (U2722DE Only) Select to switch between the USB upstream sources in PBP mode. Move the Joystick to switch among USB upstream sources in PBP mode.

Video Swap Select to swap videos between main window and sub-window in PBP mode. Move the Joystick to swap main window and sub-window.

Contrast (Sub) Adjust the **Contrast** level of the picture in PBP Mode. Move the Joystick to increase or decrease the contrast.



Icon	Menu and Submenus	Description
	USB (U2722DE Only)	Allows you to set the USB upstream port for the DP input signals, thus the monitor's USB downstream port (For example, keyboard and mouse) can be used by the current input signals when you connect a computer to either one of the upstream ports. When you use only one upstream port, the connected upstream port is active.

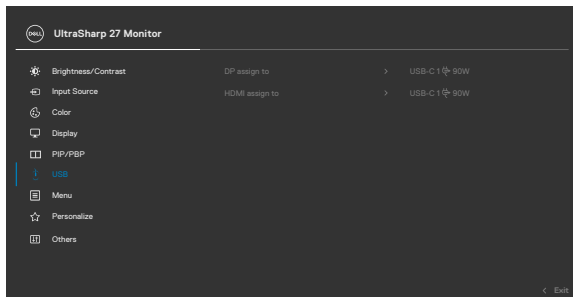

NOTE: To prevent data damage or loss, before changing USB upstream ports, make sure that no USB storage devices are in use by the computer connected to the monitor's USB upstream port.

	Menu	Select this option to adjust the settings of the OSD, such as the languages of the OSD, the amount of time the menu remains on screen, and so on.
--	-------------	---

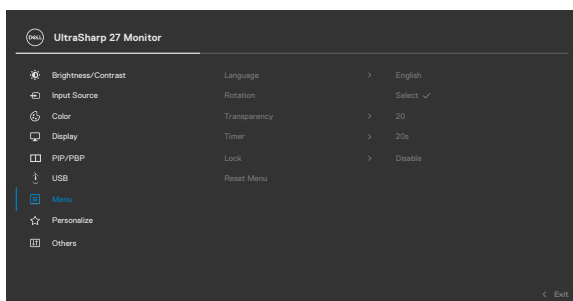

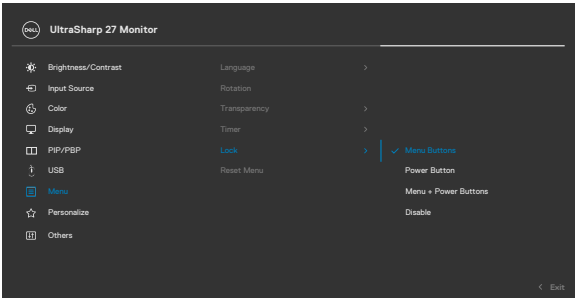

Icon	Menu and Submenus	Description
	Language	Set the OSD display to one of eight languages. (English, Spanish, French, German, Brazilian Portuguese, Russian, Simplified Chinese, or Japanese).
	Rotation	Rotates the OSD by 0/90/270 degrees. You can press the Joystick to rotate each time.
	Transparency	Select this option to change the menu transparency by moving the Joystick up or down (Range: 0 - 100).
	Timer	OSD Hold Time: Sets the length of time the OSD remains active after you press a button. Move the Joystick to adjust the slider in 1-second increments, from 5 to 60 seconds.
	Lock	With the control buttons on the monitor locked, you can prevent people from accessing the controls. It also prevents accidental activation in multiple monitors side-by-side setup.



- **Menu Buttons:** Through OSD to lock the Menu buttons.
- **Power Button:** Through OSD to lock the Power button.
- **Menu + Power Buttons:** Through OSD to lock the all of Menu and Power buttons.
- **Disable:** Move the Joystick left and hold for 4 seconds.

Reset Menu Resets all settings under the **Reset Menu** to the factory defaults. Press  to select this function.

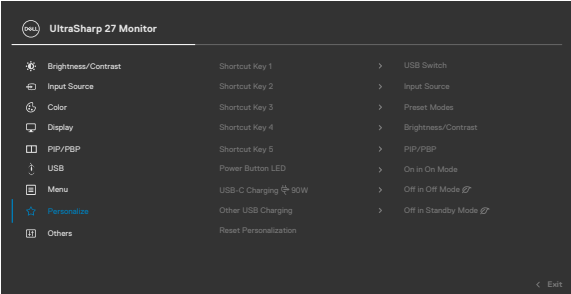

Icon	Menu and Submenus	Description
	Personalize	
		
	Shortcut key 1	<p>Select from Preset Modes, Brightness/Contrast, Input Source, Aspect Ratio, Rotation, PIP/PBP, Video Swap, Display Info, USB Switch (U2722DE Only) set as shortcut key.</p>
	Shortcut key 2	
	Shortcut key 3	
	Shortcut key 4	
	Shortcut key 5	
	Power Button LED	Allows you to set the state of the power light to save energy.
	USB-C Charging 90W (U2722DE Only)	<p>Allows you to enable or disable USB-C Charging 90W charging function during monitor power off mode.</p> <p>NOTE: When this function is enabled, you will be able to charge your notebook or mobile devices through the USB-C cable even when the monitor is powered Off.</p>
	Other USB Charging (U2722DE)	<p>Allows you to enable or disable Other USB Charging function during monitor Standby Mode.</p> <p>NOTE: When this function is enabled, you will be able to charge your mobile phone through the USB-A cable even when the monitor is in standby mode.</p>
	USB Charging (U2722D/ U2722DX)	Allows you to enable or disable USB Charging function during monitor Standby Mode.
	Reset Personalization	<p>Resets all settings under the Personalize menu to the factory preset values.</p> <p>Press  to select this function.</p>



Icon	Menu and Submenus	Description
------	-------------------	-------------



Others

Select this option to adjust the OSD settings such as the **DDC/CI**, **LCD** conditioning, and so on.

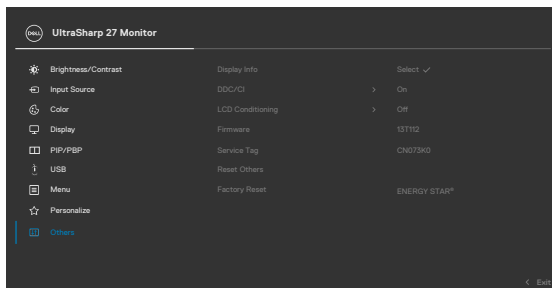

Display Info

Displays the monitor's current settings. Press  to select this function.

U2722D/U2722DX:

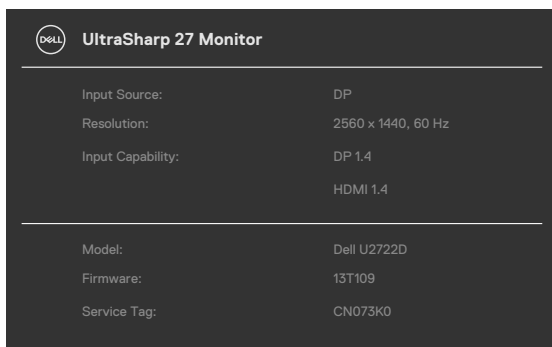

Icon	Menu and Submenus	Description
------	-------------------	-------------



U2722DE:

UltraSharp 27 Monitor	
Input Source:	DP
Resolution:	2560 x 1440, 60 Hz 24-bit
Input Capability:	DP 1.4 (HBR)
	HDMI 1.4
USB:	3.2 Gen2
Link Rate (Current):	HBR
USB Upstream:	USB-C1
<hr/>	
Model:	Dell U2722DE
Firmware:	33T101
Service Tag:	CN073K0

DDC/CI

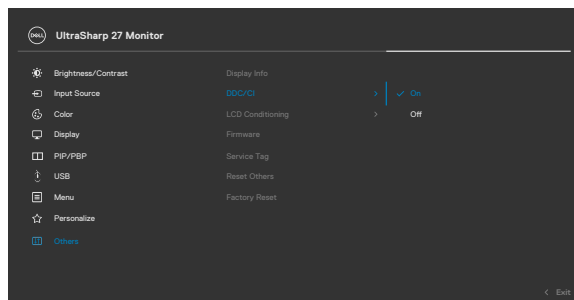
DDC/CI (Display Data Channel/Command Interface) allows your monitor parameters (brightness, color balance, and etc.) to be adjustable via the software on your computer. You can disable this feature by selecting **Off**. Enable this feature for best user experience and optimum performance of your monitor.

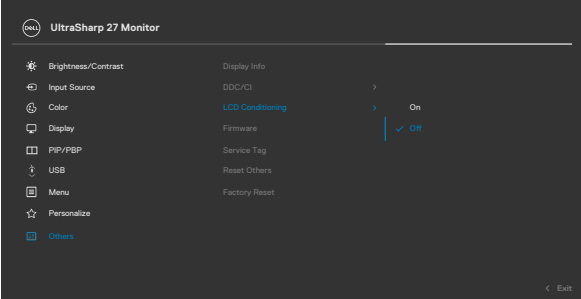

Icon	Menu and Submenus	Description
	LCD Conditioning	Helps reduce minor cases of image retention. Depending on the degree of image retention, the program may take some time to run. You can enable this feature by selecting On .
		
		
Firmware		Displays the Firmware version of your monitor.
Service Tag		Displays the Service Tag . The Service Tag is a unique alphanumeric identifier that allows Dell to identify the product specifications and access warranty information. NOTE: The Service Tag is also printed on a label located at the back of the cover.
Reset Others		Resets all settings under the Others menu to the factory defaults. Press  to select this function.
Factory Reset		Restores all preset values to the factory default settings.



Using the OSD Lock Function

You can lock the front-panel control buttons to prevent access to the OSD menu and/or power button.

Use the Lock Menu to Lock the Button(s).

1. Select one of the following options.

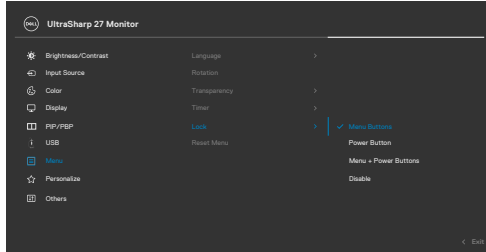

2. The following message appears.

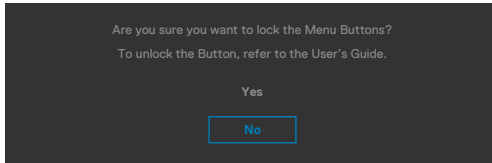

3. Select **Yes** to lock buttons. Once locked, pressing any control button will display the lock icon .





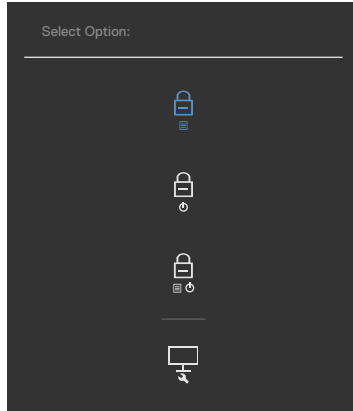

Use the Joystick to Lock the Button(s).

Press the left directional navigation of Joystick for four seconds, a menu appears on the screen.



Select one of the following options:



Options	Description
1  Menu Button Lock	Select this option to lock OSD menu function.
2  Power Button Lock	Use this option to lock power button. This will prevent the user to turn off the monitor using the power button.
3  Menu and Power Button Lock	Use this option to lock OSD menu and power button to turn off the monitor.
4  Built-in Diagnostics	Use this option to run the built-in diagnostics, see Built-in Diagnostics .

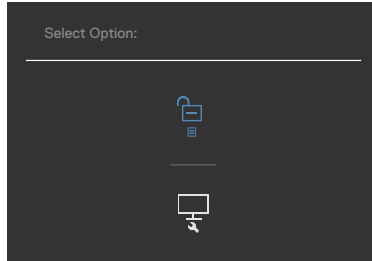

To Unlock the Button(s).

Press the left directional navigation of Joystick for four seconds until a menu appears on the screen. The following table describes the options to unlock the front-panel control buttons.



Options	Description
1  Menu Button Unlock	Use this option to unlock OSD menu function.
2  Power Button Unlock	Use this option to unlock power button to turn off the monitor.
3  Menu and Power Button Unlock	Use this option to unlock OSD menu and power button to turn off the monitor.



Initial Setup

Select OSD items of **Factory Reset** in Other feature, the following message will appear:

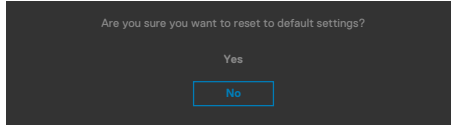

When you select '**Yes**' to reset to default settings, the following message will appear:

U2722D/U2722DX

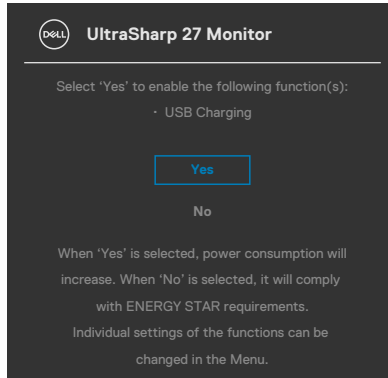

U2722DE

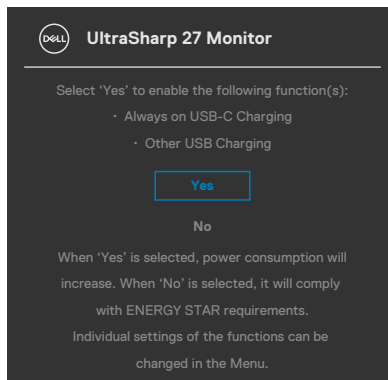

OSD Warning Messages

When the monitor does not support a particular resolution mode, you can see the following message:

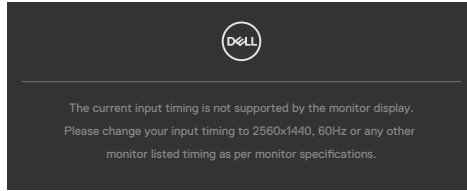

This means that the monitor cannot synchronize with the signal that it is receiving from the computer. See [Monitor Specifications](#) for the Horizontal and Vertical frequency ranges addressable by this monitor. Recommended mode is **2560 x 1440**. You can see the following message before the DDC/CI function is disabled:

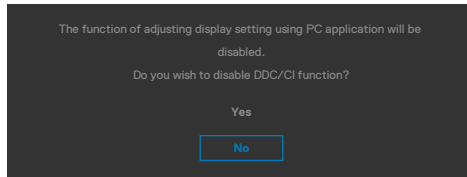

When the monitor enters the **Standby Mode**, the following message will appear:

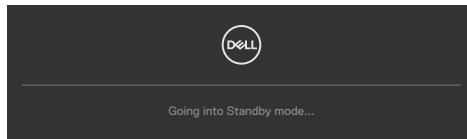

Activate the computer and wake up the monitor to gain access to the **OSD**.

If you press any button other than the power button, the following messages will appear depending on the selected input:

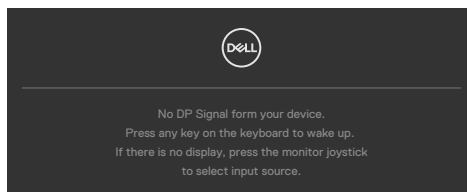

A message is displayed while the cable supporting DP alternate mode is connected to the monitor under the following conditions:

- When Auto Select for **USB-C** is set to **Prompt for Multiple Inputs**.
- When the USB-C cable is connected to the monitor.

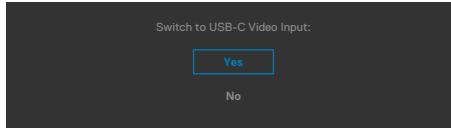

If the monitor connect with two ports or more, when the **Auto** of Input Source is selected, it will turn to the next port with signal.

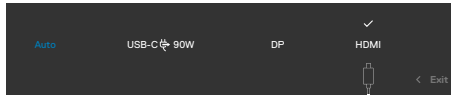

Select OSD items of **On in Standby Mode** in Personalize feature, the following message will appear:

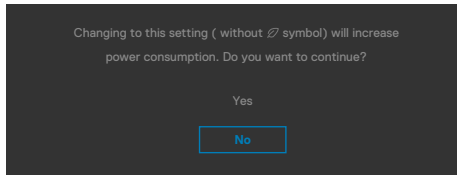

If adjust the Brightness level above the default level over 75%, the following message will appear:

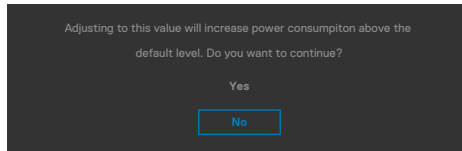

- When user selects “Yes”, the power message is displayed only once.
- When user select ‘No’, the power warning message will pop-up again.
- The power warning message will appear again only when the user does a Factory Reset from the OSD menu.



If either DP, HDMI or USB-C input is selected and the corresponding cable is not connected, a floating dialog box as shown below appears.

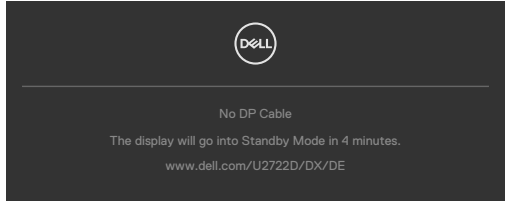

or

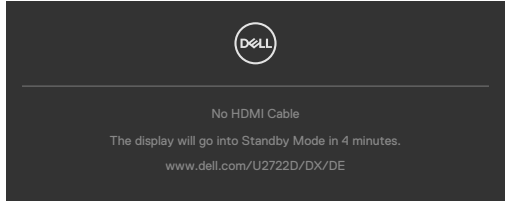

or

(U2722DE Only)

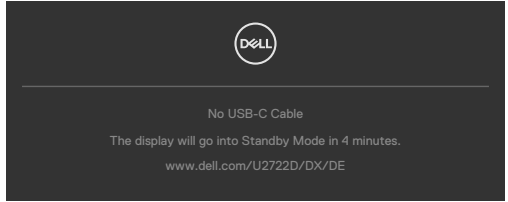

See [Troubleshooting](#) for more information.



Setting the Maximum Resolution

To set the maximum resolution for the monitor:

In Windows 7, Windows 8 or Windows 8.1:

1. For Windows 8 or Windows 8.1 only, select the Desktop tile to switch to classic desktop. For Windows Vista and Windows 7, skip this step.
2. Right-click on the desktop and click **Screen Resolution**.
3. Click the Dropdown list of the **Screen Resolution** and select **2560 x 1440**.
4. Click **OK**.

In Windows 10:

1. Right-click on the desktop and click **Display Settings**.
2. Click **Advanced display settings**.
3. Click the dropdown list of **Resolution** and select **2560 x 1440**.
4. Click **Apply**.

If you do not see **2560 x 1440** as an option, you may need to update your graphics driver. Depending on your computer, complete one of the following procedures:

If you have a Dell desktop or portable computer:

- Go to <https://www.dell.com/support>, enter your service tag, and download the latest driver for your graphics card.

If you are using a non-Dell computer (laptop or desktop):

- Go to your computer manufacturer's support website and download the latest graphic drivers.
- Go to your graphics card manufacturer's website and download the latest graphic drivers.



Multi-Monitor Sync (MMS)

Multi-Monitor Sync allows multiple monitors that are daisy chained via DisplayPort to synchronize a pre-defined group of OSD settings in the background.

An OSD option, “Multi-Monitor Sync” is available in Display Menu to allow user to enable/disable syncing.

 **NOTE: MMS is not supported over HDMI interface.**

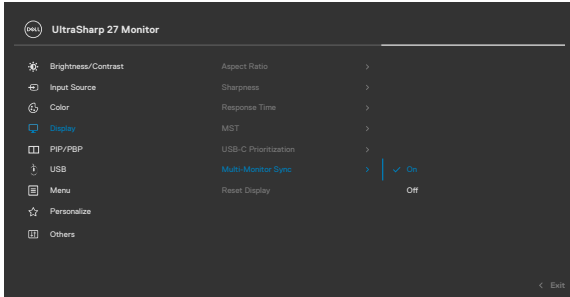

If Monitor 2 supports Multi-Monitor Sync, its MMS option will automatically be set to **On** for syncing as well.

If syncing of OSD settings across monitors is not preferred, this feature can be disabled by setting MMS option of any of the monitor to **Off**.

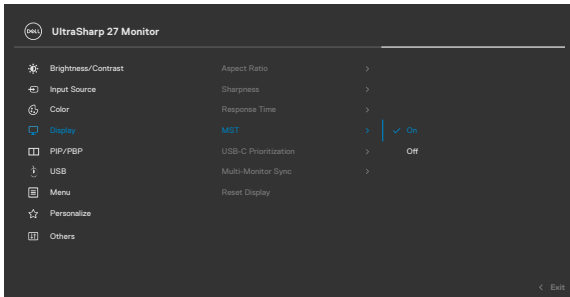

OSD Settings to be Synchronized

- Brightness
- Contrast
- Preset Modes
- Color Temperature
- Custom Color (RGB Gain)
- Hue (Movie, Game mode)
- Saturation (Movie, Game mode)
- Response Time
- Sharpness

Setting Multi-Monitor Sync (MMS)

During initial power on or connection of new monitor, user setting synchronization only start if MMS is **On**. All monitor should synchronize settings from Monitor 1.

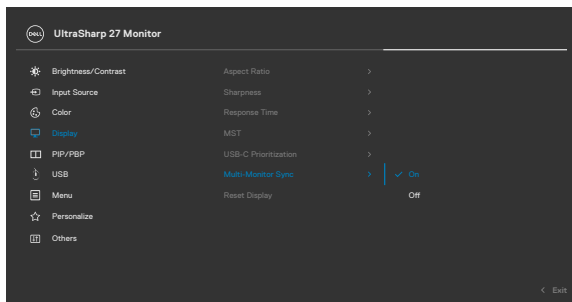

After first synchronization, subsequent syncing is driven by changes to the predefined group of OSD settings from any node in the chain. Any node may initiate the changes downstream and upstream.

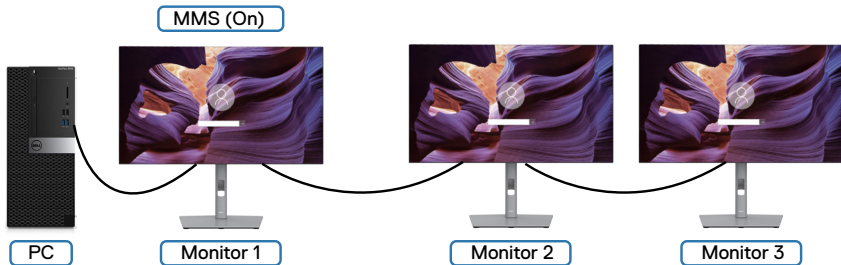

Setting the KVM USB Switch (U2722DE Only)

To set the KVM USB Switch as Shortcut Key for the monitor:

1. Press the Joystick button to launch the OSD main menu.
2. Move the Joystick to select **Personalize**.

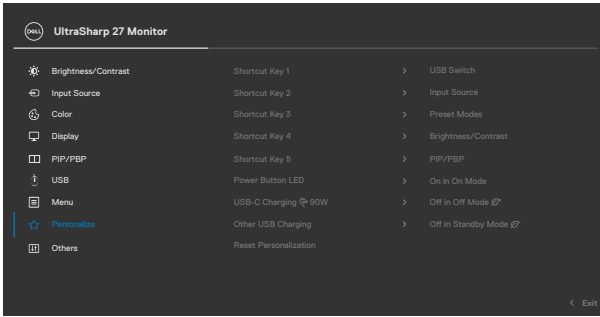

3. Move the Joystick right to activate the highlighted option.
4. Move the Joystick right to activate the **Shortcut Key 1** option.
5. Move the Joystick up or down to select **USB Switch**.

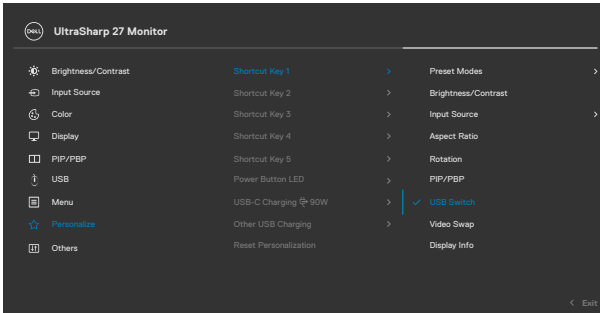

6. Press the Joystick to confirm selection.



NOTE: KVM USB Switch function only work under PBP Mode.



The following are illustrations of several connection scenarios and their USB Selection menu settings, as illustrated in corresponding color frames.

1. When connecting **HDMI + USB A to C** to computer 1 and **DP + USB A to C** to computer 2:

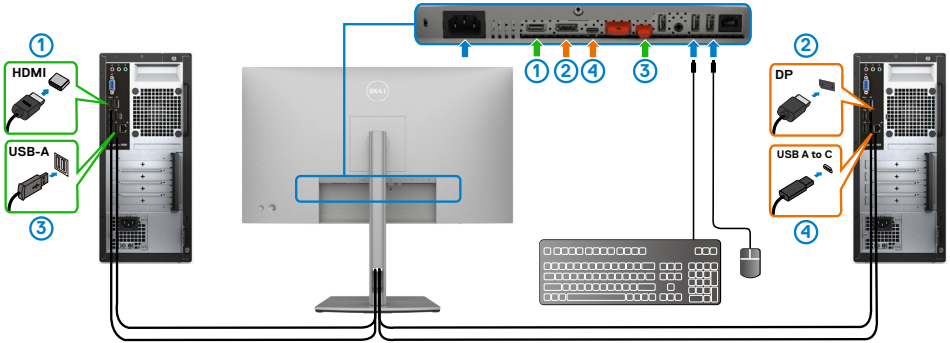

NOTE: The USB-C connection currently supports only data transfer.

Ensure USB Selection for **HDMI** is set to **USB-C 2** and **DP** is set to **USB-C 1** 
90 W.

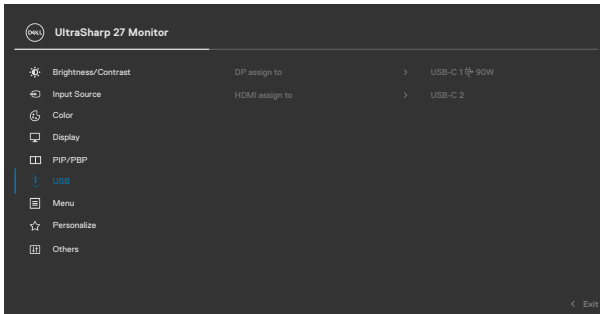

2. When connecting **HDMI + USB A to C** to computer 1 and **USB-C** to computer 2:

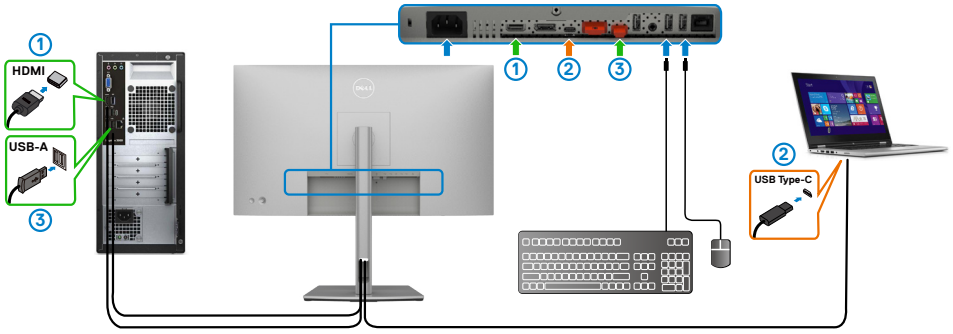

NOTE: The USB-C connection currently supports video and data transfer. Ensure **USB Selection** for **HDMI** is set to **USB-C 2**.

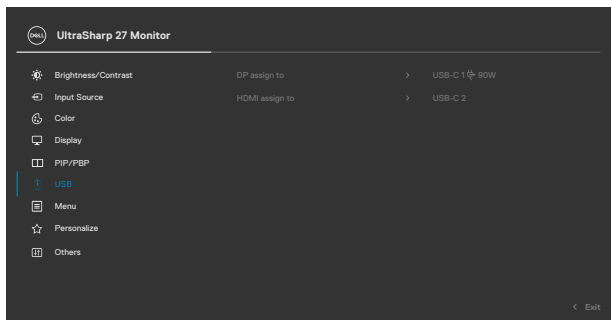

NOTE: As the USB-C port supports the DisplayPort Alternate Mode, there is no need to set USB Selection for USB-C.

NOTE: When connecting to different video input sources not shown above, follow the same method to make correct settings for USB Selection to pair the ports.



Setting the Auto KVM (U2722DE Only)

You can follow below instruction to set up Auto KVM for your monitor:

1. Ensure that **PBP Mode** is **Off**.

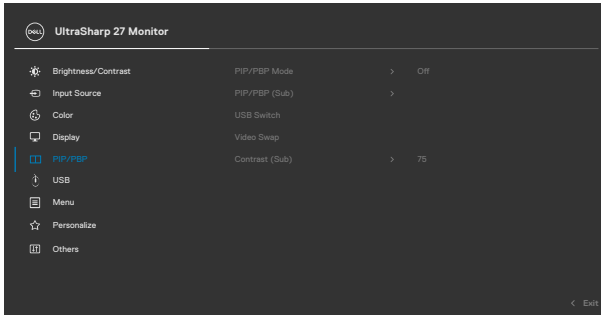

2. Ensure that **Auto Select** is **On** and **Auto Select for USB-C** is **Yes**.

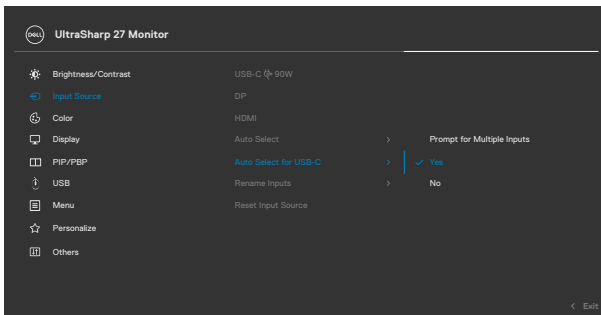
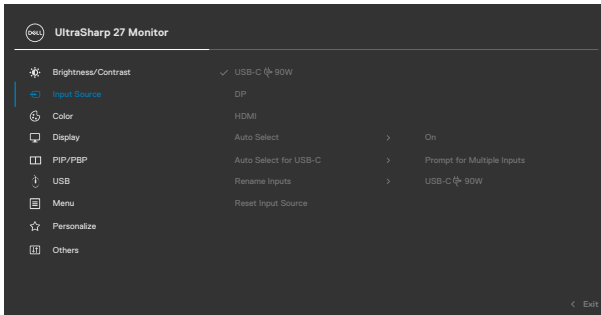

3. Ensure that the USB ports and the video inputs are paired accordingly.

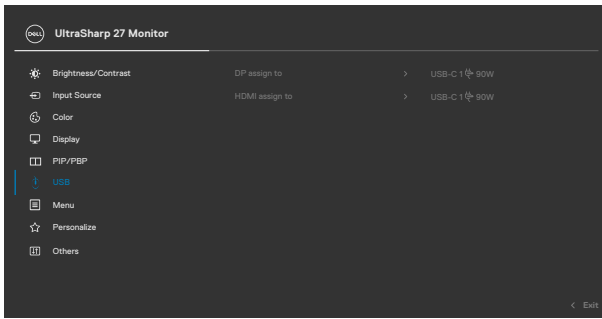

 **NOTE: For USB-C connection, there is no further setting required.**



Troubleshooting

⚠ WARNING: Before you begin any of the procedures in this section, follow the [Safety Instructions](#).

Self-Test

Your monitor provides a self-test feature that allows you to check whether your monitor is functioning properly. If your monitor and computer are properly connected but the monitor screen remains dark, run the monitor self-test by performing the following steps:

1. Turn off both your computer and the monitor.
2. Unplug the video cable from the back of the computer. To ensure proper Self-Test operation, remove all digital and the analog cables from the back of computer.
3. Turn on the monitor.

The floating dialog box should appear on-screen (against a black background), if the monitor cannot sense a video signal and is working correctly. While in self-test mode, the power LED remains white. Also, depending upon the selected input, one of the dialogs shown below will continuously scroll through the screen.

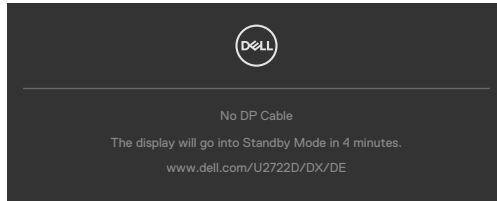

or

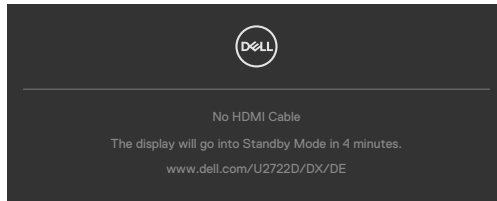

or

(U2722DE only)

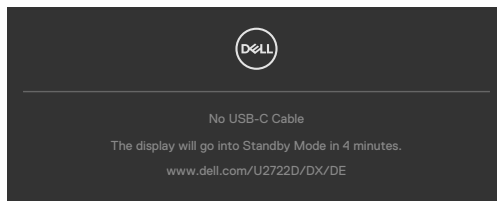

4. This box also appears during normal system operation if the video cable becomes disconnected or damaged.
5. Turn off your monitor and reconnect the video cable; then turn on both your computer and the monitor.

If your monitor screen remains blank after you use the previous procedure, check your video controller and computer, because your monitor is functioning properly.

Built-in Diagnostics

Your monitor has a built-in diagnostic tool that helps you determine if the screen abnormality you are experiencing is an inherent problem with your monitor, or with your computer and video card.

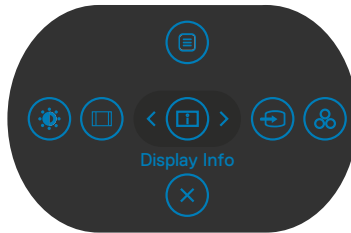

To Run the Built-in Diagnostics:

1. Ensure that the screen is clean (no dust particles on the surface of the screen).
2. Press and hold Up or Down or Left or Right direction for four seconds until a menu appears on the screen.
3. Using the Joystick control, highlight the Diagnostics  option and press the Joystick button to start the diagnostics. A gray screen is displayed.
4. Observe if the screen has any defects or abnormalities.
5. Toggle the Joystick once again until a red screen is displayed.
6. Observe if the screen has any defects or abnormalities.
7. Repeat steps 5 and 6 until the screen displays green, blue, black, and white colors. Note any abnormalities or defects.

The test is complete when a text screen is displayed. To exit, toggle the Joystick control again.

If you do not detect any screen abnormalities upon using the built-in diagnostic tool, the monitor is functioning properly. Check the video card and computer.



Common Problems

The following table contains general information about common monitor problems you might encounter and the possible solutions:

Common Symptoms	What You Experience	Possible Solutions
No Video/ Power LED off	No picture	<ul style="list-style-type: none">· Ensure that the video cable connecting the monitor and the computer is properly connected and secure.· Verify that the power outlet is functioning properly using any other electrical equipment.· Ensure that the power button is depressed fully.· Ensure that the correct input source is selected in the Input Source menu.
No Video/ Power LED on	No picture or no brightness	<ul style="list-style-type: none">· Increase brightness and contrast controls via OSD.· Perform monitor self-test feature check.· Check for bent or broken pins in the video cable connector.· Run the built-in diagnostics.· Ensure that the correct input source is selected in the Input Source menu.
Missing Pixels	LCD screen has spots	<ul style="list-style-type: none">· Cycle power on-off.· Pixel that is permanently off is a natural defect that can occur in LCD technology.· For more information on Dell Monitor Quality and Pixel Policy, see Dell Support site at: https://www.dell.com/pixelguidelines.
Stuck-on Pixels	LCD screen has bright spots	<ul style="list-style-type: none">· Cycle power On-Off.· Pixel that is permanently off is a natural defect that can occur in LCD technology.· For more information on Dell Monitor Quality and Pixel Policy, see Dell Support site at: https://www.dell.com/pixelguidelines.
Brightness Problems	Picture too dim or too bright	<ul style="list-style-type: none">· Reset the monitor to factory settings.· Adjust brightness and contrast controls via OSD.
Safety Related Issues	Visible signs of smoke or sparks	<ul style="list-style-type: none">· Do not perform any troubleshooting steps.· Contact Dell immediately.



Common Symptoms	What You Experience	Possible Solutions
Intermittent Problems	Monitor malfunctions on & off	<ul style="list-style-type: none"> · Ensure that the video cable connecting the monitor to the computer is connected properly and is secure. · Reset the monitor to factory settings. · Perform monitor self-test feature check to determine if the intermittent problem occurs in self-test mode.
Missing Color	Picture missing color	<ul style="list-style-type: none"> · Perform monitor self-test. · Ensure that the video cable connecting the monitor to the computer is connected properly and is secure. · Check for bent or broken pins in the video cable connector.
Wrong Color	Picture color not good	<ul style="list-style-type: none"> · Try different Preset Modes in Color settings OSD. · Adjust R/G/B value under Custom Color in Color menu OSD. · Change the Input Color Format to RGB or YCbCr in the Color settings OSD. · Run the built-in diagnostics.
Image retention from a static image left on the monitor for a long period of time	Faint shadow from the static image displayed appears on the screen	<ul style="list-style-type: none"> · Set the screen to turn off after a few minutes of screen idle time. These can be adjusted in Windows Power Options or Mac Energy Saver setting. · Alternatively, use a dynamically changing screensaver.



Product Specific Problems

Problem	What You Experience	Possible Solutions
Screen image is too small	Image is centered on screen, but does not fill entire viewing area	<ul style="list-style-type: none">· Check the Aspect Ratio setting in the Display menu OSD.· Reset the monitor to factory settings.
Cannot adjust the monitor with the buttons on the front panel	OSD does not appear on the screen	<ul style="list-style-type: none">· Turn off the monitor, unplug the monitor power cable, plug it back, and then turn on the monitor.
No Input Signal when user controls are pressed	No picture, the LED light is white	<ul style="list-style-type: none">· Check the signal source. Ensure the computer is not in the power saving mode by moving the mouse or pressing any key on the keyboard.· Check whether the signal cable is plugged in properly. Connect the signal cable again, if necessary.· Reset the computer or video player.
The picture does not fill the entire screen	The picture cannot fill the height or width of the screen	<ul style="list-style-type: none">· Due to different video formats (aspect ratio) of DVDs, the monitor may display in full screen.· Run the built-in diagnostics.
No image when using DP connection to the PC	Black screen	<ul style="list-style-type: none">· Verify which DP standard (DP 1.1a or DP 1.4) is your Graphics Card certified to. Download and install the latest graphics card driver.· Some DP 1.1a graphics card cannot support DP 1.4 monitors. Go to OSD menu, under Input Source selection, press and hold DP select Joystick key for 8 seconds to change the monitor setting from DP 1.4 to DP 1.1a.



Problem	What You Experience	Possible Solutions
No image when using USB-C connection to computer, laptop, and so on (U2722DE only)	Black screen	<ul style="list-style-type: none"> · Verify if the USB-C interface of the device can support DP alternate mode. · Verify if the device required more than 90 W power charging. · USB-C interface of device cannot support DP alternate mode. · Set Windows to Projection mode. · Ensure that the USB-C cable is not damaged.
No charging when using USB-C connection to computer, laptop, and so on (U2722DE only)	No charging	<ul style="list-style-type: none"> · Verify if the device can support one of 5 V/9 V/15 V/20 V charging profiles. · Verify if the Notebook requires a >90 W power adaptor. · If the Notebook requires a >90 W power adaptor, it may not charge with the USB-C connection. · Ensure that you use only Dell approved adapter or the adapter that comes with the product. · Ensure that the USB-C cable is not damaged.
Intermittent charging when using USB-C connection to computer, laptop, and so on (U2722DE only)	Intermittent charging	<ul style="list-style-type: none"> · Check if the maximum power consumption of device is over 90 W. · Ensure that you use only Dell approved adapter or the adapter that comes with the product. · Ensure that the USB-C cable is not damaged.
No image when using USB-C MST	Black screen or 2nd DUT is not Prime mode	<ul style="list-style-type: none"> · USB-C input, Go to OSD menu, under Display Info check the Link Rate is HBR2 or HBR3, if Link Rate is HBR2, suggest to use USB-C to DP cable to turn on MST.
No network connection	Network dropped or Intermittent	<ul style="list-style-type: none"> · Do not toggle Off/On the power button when network is connected, keeps the power button On.



Problem	What You Experience	Possible Solutions
The LAN port is not functioning (U2722DE only)	OS setting or cable connection issue	<ul style="list-style-type: none">· Ensure that the latest BIOS and drivers for your computer are installed on your computer.· Ensure that the RealTek Gigabit Ethernet Controller is installed in the Windows Device Manager.· If your BIOS Setup has a LAN/GBE Enabled/ Disabled option, make sure it is set to Enabled.· Ensure that the Ethernet cable is connected securely on the monitor and the hub/router/firewall.· Check the status LED of the Ethernet cable to confirm connectivity. Re-connect both ends of the Ethernet cable if the LED is not lit.· First power off the Computer and unplug the Type-C cable and power cord of the monitor. Then, power on the computer, plug in the monitor power cord and Type-C cable.



Universal Serial Bus (USB) Specific Problems

Specific Symptoms	What You Experience	Possible Solutions
USB interface is not working	USB peripherals are not working	<ul style="list-style-type: none">· Check that your display is turned ON.· Reconnect the upstream cable to your computer.· Reconnect the USB peripherals (downstream connector).· Turn off the monitor and turn it on again.· Reboot the computer.· Certain USB devices such as portable hard drives require higher power source; connect the drive to the computer directly.
Super speed USB 3.2 Gen2 interface is slow.	Super speed USB 3.2 Gen2 peripherals working slowly or not working at all	<ul style="list-style-type: none">· Check that your computer is USB 3.0-capable.· Some computers have USB 3.0, USB 2.0, and USB 1.1 ports. Ensure that the correct USB port is used.· Reconnect the upstream cable to your computer.· Reconnect the USB peripherals (downstream connector).· Reboot the computer.
Wireless USB peripherals stop working when a USB 3.0 device is plugged in	Wireless USB peripherals responding slowly or only working as the distance between itself and its receiver decreases	<ul style="list-style-type: none">· Increase the distance between the USB 3.0 peripherals and the wireless USB receiver.· Position your wireless USB receiver as close as possible to the wireless USB peripherals.· Use a USB-extender cable to position the wireless USB receiver as far away as possible from the USB 3.0 port.
USB is not working	No USB functionalities	Refer to input source and USB pairing table.



Appendix

FCC Notices (U.S. Only) and Other Regulatory Information

For FCC notices and other regulatory information, see the regulatory compliance website located at https://www.dell.com/regulatory_compliance.

Contacting Dell

For customers in the United States, call 800-WWW-DELL (800-999-3355).

EU Product Database for Energy Label and Product Information Sheet

U2722D: <https://eprel.ec.europa.eu/qr/414149>

U2722DE: <https://eprel.ec.europa.eu/qr/414156>

 **NOTE: If you do not have an active Internet connection, you can find contact information on your purchase invoice, packing slip, bill, or Dell product catalog.**

Dell provides several online and telephone-based support and service options. Availability varies by country and product, and some services may not be available in your area.

To get online Monitor support content:

See <https://www.dell.com/support/monitors>.

To contact Dell for sales, technical support, or customer service issues:

1. Go to <https://www.dell.com/support>.
2. Verify your country or region in the Choose A Country/Region drop-down menu at the bottom-right corner of the page.
3. Click Contact Us next to the country dropdown.
4. Select the appropriate service or support link based on your need.
5. Choose the method of contacting Dell that is convenient for you.

