

# Dell UltraSharp 24/27

## USB-C Hub Monitor - U2421HE/U2721DE

### User's Guide

Model: U2421HE/U2721DE  
Regulatory model: U2421HEt/U2721DEt





**NOTE:** A NOTE indicates important information that helps you make better use of your computer.



**CAUTION:** A CAUTION indicates potential damage to hardware or loss of data if instructions are not followed.



**WARNING:** A WARNING indicates a potential for property damage, personal injury, or death.

**Copyright © 2020 Dell Inc. or its subsidiaries. All rights reserved.** Dell, EMC, and other trademarks are trademarks of Dell Inc. or its subsidiaries. Other trademarks may be trademarks of their respective owners.

# Contents

|  |           |
|--|-----------|
| <b>About Your Monitor</b> . . . . .                              | <b>5</b>  |
| Package Contents . . . . .                                       | 5         |
| Product Features . . . . .                                       | 6         |
| Identifying Parts and Controls . . . . .                         | 7         |
| Monitor Specifications . . . . .                                 | 10        |
| Plug-and-Play . . . . .  | 24        |
| LCD Monitor Quality and Pixel Policy . . . . .                   | 24        |
| <b>Setting Up the Monitor</b> . . . . .                          | <b>25</b> |
| Attaching the Stand . . . . .                                    | 25        |
| Using the Tilt, Swivel, and Vertical Extension . . . . .         | 27        |
| Adjusting the Rotation Display Settings of Your System . . . . . | 28        |
| Connecting Your Monitor . . . . .                                | 29        |
| Organizing Your Cables . . . . .                                 | 32        |
| Removing the Monitor Stand . . . . .                             | 32        |
| Wall Mounting (Optional) . . . . .                               | 33        |
| <b>Operating the Monitor</b> . . . . .                           | <b>34</b> |
| Turning on the Monitor . . . . .                                 | 34        |
| Using the Front Panel Controls . . . . .                         | 34        |
| Using the OSD Lock function . . . . .                            | 36        |
| Using the On-Screen Display (OSD) Menu . . . . .                 | 39        |



|  |            |
|--|------------|
| <b>Troubleshooting</b> . . . . .   | <b>.56</b> |
| Self-Test . . . . .  | .56        |
| Built-in Diagnostics . . . . .   | .57        |
| Setting USB-C Prioritization when USB-C Charging is set to On                |            |
| During Power Off. . . . .  | .58        |
| Common Problems . . . . .  | .59        |
| Product Specific Problems. . . . .   | .60        |
| <b>Appendix.</b> . . . . .   | <b>.63</b> |
| Safety Instructions . . . . .  | .63        |
| FCC Notices (U.S. only) and Other Regulatory Information . . . . .           | .63        |
| Contacting Dell . . . . .  | .63        |
| EU product database for energy label and product information sheet . . . . . | .64        |
| Setting Up Your Monitor . . . . .  | .64        |
| Maintenance Guidelines . . . . .   | .66        |







# About Your Monitor

## Package Contents

Your monitor ships with the components shown below. Make sure that you have received all the components and [contact Dell](#) if something is missing.

 **NOTE:** Some items may be optional and may not ship with your monitor. Some features may not be available in certain countries.

|   |                                 |
|---|---------------------------------|
|    | Display                         |
|    | Stand riser                     |
|  | Stand base                      |
|  | Power cable (varies by country) |
|  | USB Type-C cable (C to C)       |

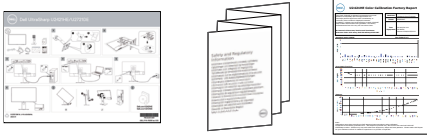

|   |  |
|---|--|
|   | <p>DP cable</p>  |
|  | <ul style="list-style-type: none"> <li>• Quick Setup Guide</li> <li>• Safety, Environmental, and Regulatory Information</li> <li>• Factory Calibration Report</li> </ul> |

## Product Features

The **Dell UltraSharp U2421HE/U2721DE** monitor has an active matrix, thinfilm transistor (TFT), liquid crystal display (LCD), and LED backlight. The monitor features include:

- **U2421HE:** 60.47 cm (23.8 in.) active area display (Measured diagonally) 1920 x 1080 (16:9) resolution, plus full-screen support for lower resolutions.
- **U2721DE:** 68.47 cm (27 in.) active area display (Measured diagonally) 2560 x 1440 (16:9) resolution, plus full-screen support for lower resolutions.
- Wide viewing angles with 99% sRGB color with an average Delta E < 2.
- Tilt, swivel, pivot and vertical extension adjustment capabilities.
- Removable pedestal and Video Electronics Standards Association (VESA™) 100 mm mounting holes for flexible mounting solutions.
- Ultra-thin bezel minimizes the bezel gap in multi-monitor usage, enabling easier set up with an elegant viewing experience.
- Extensive digital connectivity with DP helps future-proof your monitor.
- Single USB Type-C to supply power to compatible notebook while receiving video signal.
- USB-C and RJ45 ports enable a single-cable, network-connected experience.
- Plug and play capability if supported by your system.
- On-Screen Display (OSD) adjustments for ease of set-up and screen optimization.
- Power and OSD buttons lock.
- Security lock slot.
- ≤ 0.3 W in Standby Mode.
- Optimize eye comfort with a flicker-free screen.

NOTE: The possible long-term effects of blue light emission from the monitor may cause damage to the eyes, including eye fatigue or digital eye strain. ComfortView feature is designed to reduce the amount of blue light emitted from the monitor to optimize eye comfort.



# Identifying Parts and Controls

## Front view

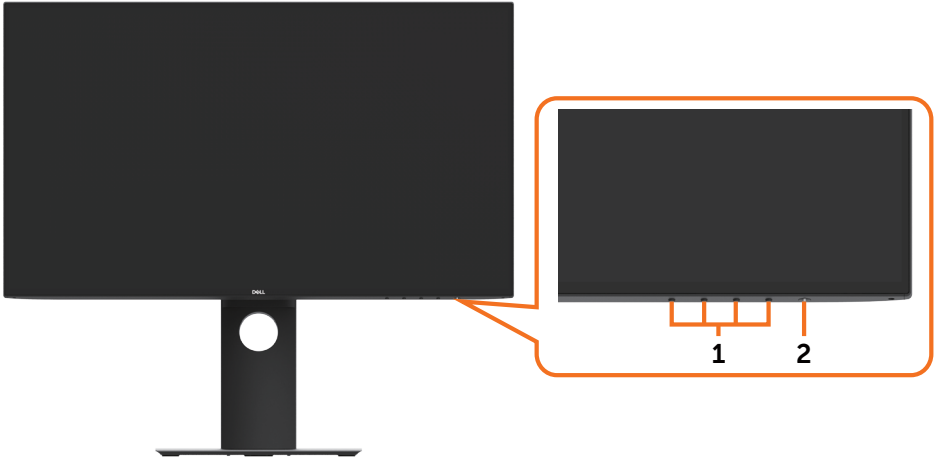

| Label | Description   |
|-------|---|
| 1     | Function buttons (For more information, see <a href="#">Operating the Monitor</a> ) |
| 2     | Power on/off button (with LED indicator)  |



## Back View



| Label | Description  | Use  |
|-------|--|--|
| 1     | VESA mounting holes (100 mm x 100 mm-behind attached VESA cover) | Wall mount monitor using VESA-compatible wall mount kit (100 mm x 100 mm). |
| 2     | Regulatory label   | Lists the regulatory approvals.  |
| 3     | Stand release button   | Release stand from monitor.  |
| 4     | Security lock slot   | Secures monitor with security cable lock (sold separately).                |
| 5     | Mac address, Barcode, serial number, and Service Tag label       | Refer to this label if you need to contact Dell for technical support.     |
| 6     | Cable management slot  | Use to organize cables by placing them through the slot.                   |

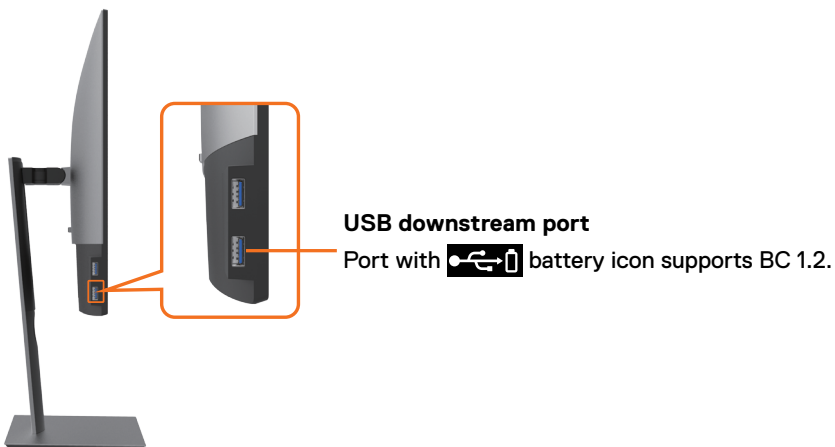

## Side View



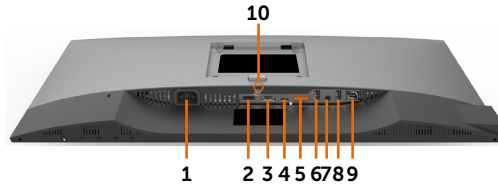

## Bottom View



| Label | Description  | Use   |
|-------|--|---|
| 1     | AC power port  | To connect the monitor power cable.   |
| 2     | HDMI port  | Connect your computer with HDMI cable (optional).   |
| 3     | DP port (in)   | Connect your computer with DP cable.  |
| 4     | USB Type-C/DisplayPort   | Connect to your computer using the USB Type-C cable.<br>The USB 3.1 Type-C port offer the fastest transfer rate and the alternate mode with DP 1.4 support the maximum resolution of 1920 x 1080 at 60 Hz(U2421HE) and 2560 x 1440 at 60 Hz(U2721DE), PD 20 V/3.25 A, 15 V/3 A, 9 V/3 A, 5 V/3 A.<br><b>NOTE:</b> USB Type-C is not supported on Windows versions that are prior to Windows 10. |
| 5     | DP port (out)<br> | DP output for MST (multi-stream transport) capable monitor. To enable MST, refer to instruction on section " <a href="#">Connecting the Monitor for DP MST Function</a> ".<br><b>NOTE:</b> Remove the rubber plug when using DP out connector.  |
| 6&8   | USB downstream ports(2)  | Connect your USB device. You can use these ports only after you have connected the USB cable (Type-C to Type-C) from the computer to the monitor. Port with  battery icon supports Battery Charging Rev. 1.2.   |
| 7     | Audio line-out port  | Connect speakers to playback audio coming through USB Type-C or DP audio channels.<br>Only supports 2-channel audio.<br><b>NOTE:</b> The audio line-out port does not support headphones.   |
| 9     | RJ-45 connector  | Connect Internet. You can surf Internet via RJ45 only after you have connected the USB cable(Type-A to Type-C or Type-C to Type-C) from the computer to the monitor.  |
| 10    | Stand lock   | Lock the stand to the monitor using a M3 x 6 mm (U2721DE)/ M3 x 8 mm (U2421HE) screw (screw not included).  |



# Monitor Specifications

| Model                        | U2421HE   | U2721DE   |
|------------------------------|---|---|
| Screen type                  | Active matrix - TFT LCD                                       | Active matrix - TFT LCD                                       |
| Panel Type                   | In-plane switching Technology                                 | In-plane switching Technology                                 |
| Aspect ratio                 | 16:9  | 16:9  |
| Viewable image dimensions    |   |   |
| Diagonal                     | 60.47 cm (23.8 in.)   | 68.47 cm (27 in.)   |
| Active Area                  |   |   |
| Horizontal                   | 527.04 mm (20.75 in.)   | 596.74 mm (23.49 in.)   |
| Vertical                     | 296.46 mm (11.67 in.)   | 335.66 mm (13.21 in.)   |
| Area                         | 156246.3 mm <sup>2</sup> (242.15 in. <sup>2</sup> )           | 200301.7 mm <sup>2</sup> (310.30 in. <sup>2</sup> )           |
| Pixel pitch                  | 0.2745 mm x 0.2745 mm   | 0.233 mm x 0.233 mm   |
| Pixel per inch (PPI)         | 92.5  | 109   |
| Viewing angle                |   |   |
| Horizontal                   | 178° (typical)  | 178° (typical)  |
| Vertical                     | 178° (typical)  | 178° (typical)  |
| Brightness                   | 250 cd/m <sup>2</sup> (typical)                               | 350 cd/m <sup>2</sup> (typical)                               |
| Contrast ratio               | 1000 to 1 (typical)   | 1000 to 1 (typical)   |
| Display screen coating       | Anti-glare treatment of the front polarizer (3H) hard coating | Anti-glare treatment of the front polarizer (3H) hard coating |
| Backlight                    | LED   | LED   |
| Response Time (Gray to Gray) | 5 ms (FAST mode)<br>8 ms (NORMAL mode)                        | 5 ms (FAST mode)<br>8 ms (NORMAL mode)                        |
| Color depth                  | 16.7 million colors   | 16.7 million colors   |
| Color gamut*                 | 99% sRGB<br>99% REC709<br>85% DCI-P3                          | 99% sRGB<br>99% REC709<br>85% DCI-P3                          |
| Calibration accuracy         | Delta E < 2 (average)   | Delta E < 2 (average)   |



|   |  |  |
|---|--|--|
| Connectivity                                  | <ul style="list-style-type: none"> <li>• 1 x DP 1.4 (HDCP 1.4)</li> <li>• 1 x HDMI1.4 (HDCP 1.4)</li> <li>• 1 x USB Type-C (Alternate mode with DisplayPort 1.4, USB 3.1 upstream port, Power Delivery PD up to 65 W)</li> <li>• 1 x DP (Out) with MST (HDCP 1.4)</li> <li>• 2 x USB 3.0 downstream port</li> <li>• 2 x USB 3.0 with BC1.2 charging capability at 2A (max)</li> <li>• 1 x Analog 2.0 audio line out (3.5 mm jack)</li> <li>• 1 x RJ45</li> </ul> | <ul style="list-style-type: none"> <li>• 1 x DP 1.4 (HDCP 1.4)</li> <li>• 1 x HDMI1.4 (HDCP 1.4)</li> <li>• 1 x USB Type-C (Alternate mode with DisplayPort 1.4, USB 3.1 upstream port, Power Delivery PD up to 65 W)</li> <li>• 1 x DP (Out) with MST (HDCP 1.4)</li> <li>• 2 x USB 3.0 downstream port</li> <li>• 2 x USB 3.0 with BC1.2 charging capability at 2A (max)</li> <li>• 1 x Analog 2.0 audio line out (3.5 mm jack)</li> <li>• 1 x RJ45</li> </ul> |
| Border width (edge of monitor to active area) | 5.0 mm (Top)<br>5.1 mm (Left/Right)<br>8.0 mm (Bottom)   | 6.90 mm (Top)<br>6.90 mm (Left/Right)<br>8.1 mm (Bottom)   |
| Adjustability                                 |  |  |
| Height adjustable stand                       | 130 mm   | 130 mm   |
| Tilt  | -5° to 21°   | -5° to 21°   |
| Swivel  | -40° to 40°  | -40° to 40°  |
| Cable management                              | Yes  | Yes  |
| Dell Display Manager (DDM)Compatibility       | Easy Arrange and other key features  | Easy Arrange and other key features  |
| Security                                      | Security lock slot (cable lock sold separately) Anti-theft stand lock slot (to panel)  | Security lock slot (cable lock sold separately) Anti-theft stand lock slot (to panel)  |

\* At panel native only, under Custom Mode preset.

## Resolution Specifications

| Model   | U2421HE                                    | U2721DE                                    |
|---|--|--|
| Horizontal scan range                                 | 30 kHz to 83 kHz                           | 30 kHz to 90 kHz                           |
| Vertical scan range                                   | 56 Hz to 76 Hz                             | 56 Hz to 76 Hz                             |
| Maximum preset resolution                             | 1920 x 1080 at 60 Hz                       | 2560 x 1440 at 60 Hz                       |
| Video display capabilities (DP & USB Type-C playback) | 480i, 480p, 576i, 576p, 720p, 1080i, 1080p | 480i, 480p, 576i, 576p, 720p, 1080i, 1080p |



# Preset Display Modes

## U2421HE

| Display Mode      | Horizontal Frequency (kHz) | Vertical Frequency (Hz) | Pixel Clock (MHz) | Sync Polarity (Horizontal/Vertical) |
|-------------------|----------------------------|-------------------------|-------------------|-------------------------------------|
| 720 x 400         | 31.5                       | 70.0                    | 28.3              | -/+                                 |
| VESA, 640 x 480   | 31.5                       | 60.0                    | 25.2              | -/-                                 |
| VESA, 640 x 480   | 37.5                       | 75.0                    | 31.5              | -/-                                 |
| VESA, 800 x 600   | 37.9                       | 60.3                    | 40.0              | +/+                                 |
| VESA, 800 x 600   | 46.9                       | 75.0                    | 49.5              | +/+                                 |
| VESA, 1024 x 768  | 48.4                       | 60.0                    | 65.0              | -/-                                 |
| VESA, 1024 x 768  | 60.0                       | 75.0                    | 78.8              | +/+                                 |
| VESA, 1152 x 864  | 67.5                       | 75.0                    | 108.0             | +/+                                 |
| VESA, 1280 x 1024 | 64.0                       | 60.0                    | 108.0             | +/+                                 |
| VESA, 1280 x 1024 | 80.0                       | 75.0                    | 135.0             | +/+                                 |
| VESA, 1600 x 900  | 60.0                       | 60.0                    | 108.0             | -/+                                 |
| VESA, 1920 x 1080 | 67.5                       | 60.0                    | 148.5             | +/+                                 |

## U2721DE

| Display Mode      | Horizontal Frequency (kHz) | Vertical Frequency (Hz) | Pixel Clock (MHz) | Sync Polarity (Horizontal/Vertical) |
|-------------------|----------------------------|-------------------------|-------------------|-------------------------------------|
| 720 x 400         | 31.5                       | 70.0                    | 28.3              | -/+                                 |
| VESA, 640 x 480   | 31.5                       | 60.0                    | 25.2              | -/-                                 |
| VESA, 640 x 480   | 37.5                       | 75.0                    | 31.5              | -/-                                 |
| VESA, 800 x 600   | 37.9                       | 60.3                    | 40.0              | +/+                                 |
| VESA, 800 x 600   | 46.9                       | 75.0                    | 49.5              | +/+                                 |
| VESA, 1024 x 768  | 48.4                       | 60.0                    | 65.0              | -/-                                 |
| VESA, 1024 x 768  | 60.0                       | 75.0                    | 78.8              | +/+                                 |
| VESA, 1152 x 864  | 67.5                       | 75.0                    | 108.0             | +/+                                 |
| VESA, 1280 x 1024 | 64.0                       | 60.0                    | 108.0             | +/+                                 |
| VESA, 1280 x 1024 | 80.0                       | 75.0                    | 135.0             | +/+                                 |
| VESA, 1600 x 1200 | 75.0                       | 60.0                    | 162.0             | +/+                                 |
| VESA, 1920 x 1080 | 67.5                       | 60.0                    | 148.5             | +/+                                 |
| VESA, 2048 x 1080 | 66.58                      | 60.0                    | 147.16            | +/-                                 |
| CVR, 2560 x 1440  | 88.8                       | 60.0                    | 241.5             | +/-                                 |



## DP MST Multi-Stream Transport (MST) Modes

### U2421HE

| MST Source Monitor | Maximum number of external monitors that can be supported |
|--------------------|---|
|                    | 1920 x 1080/60 Hz   |
| 1920 x 1080/60 Hz  | 3   |

**NOTE:** Maximum external monitor resolution supported is 1920 x 1080 60 Hz only.

### U2721DE

| MST Source Monitor | Maximum number of external monitors that can be supported |
|--------------------|---|
|                    | 2560 x 1440/60 Hz   |
| 2560 x 1440/60 Hz  | 1   |

**NOTE:** Maximum external monitor resolution supported is 2560 x 1440 60 Hz only.

## USB-C MST Multi-Stream Transport (MST) Modes

### U2421HE

| OSD Display Info: Link rate(current) | Maximum number of external monitors that can be supported |
|--------------------------------------|---|
|                                      | 1920 x 1080/60 Hz   |
| HBR3                                 | 2   |
| HBR2                                 | 1   |

### U2721DE

| OSD Display Info: Link rate(current) | Maximum number of external monitors that can be supported |
|--------------------------------------|---|
|                                      | 2560 x 1440/60 Hz   |
| HBR3 (High Resolution)               | 1   |
| HBR3 (High Data Speed)               | 0   |
| HBR2 (High Resolution)               | 1   |
| HBR2 (High Data Speed)               | 0   |



# Electrical Specifications

| Model                            |         | U2421HE/U2721DE  |
|----------------------------------|---------|--|
| Video input signals              |         | <ul style="list-style-type: none"> <li>• Digital video signal for each differential line<br/>Per differential line at 100 ohm impedance</li> <li>• DP/USB Type-C signal input support</li> </ul> |
| Input voltage/ frequency/current |         | 100-240 VAC / 50 or 60 Hz $\pm$ 3 Hz / 1.8 A (maximum)   |
| Inrush current                   |         | 120 V: 30 A (Max.)<br>240 V: 60 A (Max.)   |
| Power Consumption                | U2421HE | 0.2 W (Off Mode) <sup>1</sup><br>0.2 W (Standby Mode) <sup>1</sup><br>12.9 W (On Mode) <sup>1</sup><br>140 W (Max) <sup>2</sup><br>12.87 W (Pon) <sup>3</sup><br>43.56 kWh (TEC) <sup>3</sup>    |
|                                  | U2721DE | 0.2 W (Off Mode) <sup>1</sup><br>0.2 W (Standby Mode) <sup>1</sup><br>22.6 W (On Mode) <sup>1</sup><br>160 W (Max) <sup>2</sup><br>19.9 W (Pon) <sup>3</sup><br>64.3 kWh (TEC) <sup>3</sup>      |

<sup>1</sup> As defined in EU 2019/2021 and EU 2019/2013.

<sup>2</sup> Max brightness and contrast setting with maximum power loading on all USB ports.

<sup>3</sup> Pon: Power consumption of On Mode as defined in Energy Star 8.0 version.

TEC: Total energy consumption in kWh as defined in Energy Star 8.0 version.

This document is informational only and reflects laboratory performance. Your product may perform differently, depending on the software, components and peripherals you ordered and shall have no obligation to update such information. Accordingly, the customer should not rely upon this information in making decisions about electrical tolerances or otherwise. No warranty as to accuracy or completeness is expressed or implied.





**NOTE:** This monitor is ENERGY STAR certified.

This product qualifies for ENERGY STAR in the factory default settings which can be restored by “Factory Reset” function in the OSD menu. Changing the factory default settings or enabling other features may increase power consumption that could exceed the ENERGY STAR specified limit.



## Physical Characteristics

| Model   | U2421HE  | U2721DE  |
|---|--|--|
| Connector type  | <ul style="list-style-type: none"> <li>• DP connector (include DP in and DP out)</li> <li>• HDMI connector</li> <li>• USB Type-C connector</li> <li>• Audio line-out</li> <li>• RJ45 connector</li> <li>• USB 3.0 downstream port connector x 4</li> </ul> (Port with  battery icon supports BC 1.2.) | <ul style="list-style-type: none"> <li>• DP connector (include DP in and DP out)</li> <li>• HDMI connector</li> <li>• USB Type-C connector</li> <li>• Audio line-out</li> <li>• RJ45 connector</li> <li>• USB 3.0 downstream port connector x 4</li> </ul> (Port with  battery icon supports BC 1.2.) |
| Signal cable type   | DP to DP 1.8 M cable<br>USB Type-C 1.0 M cable   | DP to DP 1.8 M cable<br>USB Type-C 1.0 M cable   |
| Dimensions (with stand)   |  |  |
| Height (extended)   | 478.4 mm (18.84 in.)   | 520.2 mm (20.48 in.)   |
| Height (compressed)   | 348.4 mm (13.72 in.)   | 390.2 mm (15.36 in.)   |
| Width   | 538.5 mm (21.20 in.)   | 612.2 mm (24.10 in.)   |
| Depth   | 165.0 mm (6.50 in.)  | 180.0 mm (7.09 in.)  |
| Dimensions (without stand)  |  |  |
| Height  | 313.7 mm (12.35 in.)   | 355.0 mm (13.98 in.)   |
| Width   | 538.5 mm (21.20 in.)   | 612.2 mm (24.10 in.)   |
| Depth   | 39.0 mm (1.54 in.)   | 39.0 mm (1.54 in.)   |
| Stand dimensions  |  |  |
| Height (extended)   | 393.5 mm (15.49 in.)   | 413.6 mm (16.28 in.)   |
| Height (compressed)   | 347.0 mm (13.66 in.)   | 367.1 mm (14.45 in.)   |
| Width   | 218.0 mm (8.58 in.)  | 230.0 mm (9.06 in.)  |
| Depth   | 165.0 mm (6.50 in.)  | 180.0 mm (7.09 in.)  |
| Weight  |  |  |
| Weight with packaging   | 7.55 kg (16.64 lb)   | 8.72 kg (19.22 lb)   |
| Weight with stand assembly and cables   | 5.32 kg (11.73 lb)   | 6.24 kg (13.75 lb)   |
| Weight without stand assembly (For wall mount or VESA mount considerations - no cables) | 3.37 kg (7.43 lb)  | 4.19 kg (9.23 lb)  |



|                          |                   |                   |
|--------------------------|-------------------|-------------------|
| Weight of stand assembly | 1.59 kg (3.50 lb) | 1.72 kg (3.79 lb) |
|--------------------------|-------------------|-------------------|

## Environmental Characteristics

|   |   |  |
|---|---|--|
| <b>Model</b>  | <b>U2421HE/U2721DE</b>                                |  |
| <b>Compliant Standards</b>  |   |  |
| <ul style="list-style-type: none"> <li>• ENERGY STAR certified Monitor.</li> <li>• EPEAT registered where applicable. EPEAT registration varies by country. See <a href="http://www.epeat.net">www.epeat.net</a> for registration status by country.</li> <li>• TCO Certified Display.</li> <li>• RoHS Compliant.</li> <li>• BFR/PVC Free monitor (excluding external cables).</li> <li>• Meets NFPA 99 leakage current requirements.</li> <li>• Arsenic-Free glass and Mercury-Free for the panel only.</li> </ul> |   |  |
| <b>Temperature</b>  |   |  |
| Operating   | 0°C to 40°C (32°F to 104°F)                           |  |
| Non-operating   | -20°C to 60°C (-4°F to 140°F)                         |  |
| <b>Humidity</b>   |   |  |
| Operating   | 10 % to 80 % (non-condensing)                         |  |
| Non-operating   | 5 % to 90 % (non-condensing)                          |  |
| <b>Altitude</b>   |   |  |
| Operating   | 5,000 m (16,404 ft) (maximum)                         |  |
| Non-operating   | 12,192 m (40,000 ft) (maximum)                        |  |
| <b>Thermal dissipation</b>  |   |  |
| U2421HE   | 478.02 BTU/hour (maximum)<br>44.02 BTU/hour (On Mode) |  |
| U2721DE   | 546.30 BTU/hour (maximum)<br>77.11 BTU/hour (On Mode) |  |





# Pin Assignments

## DP port (in)

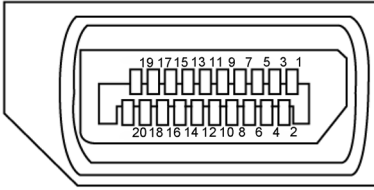

| Pin number | 20-pin side of the connected signal cable |
|------------|---|
| 1          | ML3(n)                                    |
| 2          | GND                                       |
| 3          | ML3(p)                                    |
| 4          | ML2(n)                                    |
| 5          | GND                                       |
| 6          | ML2(p)                                    |
| 7          | ML1(n)                                    |
| 8          | GND                                       |
| 9          | ML1(p)                                    |
| 10         | ML0(n)                                    |
| 11         | GND                                       |
| 12         | ML0(p)                                    |
| 13         | CONFIG1                                   |
| 14         | CONFIG2                                   |
| 15         | AUX CH (p)                                |
| 16         | GND                                       |
| 17         | AUX CH (n)                                |
| 18         | Hot Plug Detect                           |
| 19         | Return                                    |
| 20         | DP_PWR                                    |



## DP port (out)

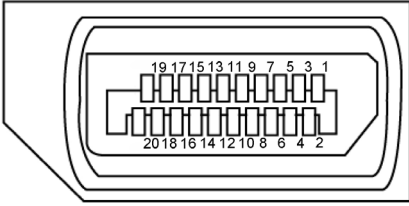

| Pin number | 20-pin side of the connected signal cable |
|------------|---|
| 1          | ML0(p)                                    |
| 2          | GND                                       |
| 3          | ML0(n)                                    |
| 4          | ML1(p)                                    |
| 5          | GND                                       |
| 6          | ML1(n)                                    |
| 7          | ML2(p)                                    |
| 8          | GND                                       |
| 9          | ML2(n)                                    |
| 10         | ML3(p)                                    |
| 11         | GND                                       |
| 12         | ML3(n)                                    |
| 13         | CONFIG1                                   |
| 14         | CONFIG2                                   |
| 15         | AUX CH(p)                                 |
| 16         | GND                                       |
| 17         | AUX CH(n)                                 |
| 18         | Hot Plug Detect                           |
| 19         | Return                                    |
| 20         | DP_PWR                                    |



## HDMI port

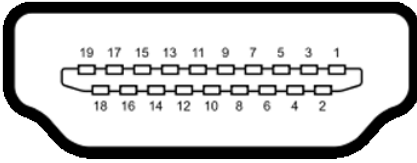

| Pin number | 19-pin side of the connected signal cable |
|------------|---|
| 1          | TMDS DATA 2+                              |
| 2          | TMDS DATA 2 SHIELD                        |
| 3          | TMDS DATA 2-                              |
| 4          | TMDS DATA 1+                              |
| 5          | TMDS DATA 1 SHIELD                        |
| 6          | TMDS DATA 1-                              |
| 7          | TMDS DATA 0+                              |
| 8          | TMDS DATA 0 SHIELD                        |
| 9          | TMDS DATA 0-                              |
| 10         | TMDS CLOCK+                               |
| 11         | TMDS CLOCK SHIELD                         |
| 12         | TMDS CLOCK-                               |
| 13         | CEC                                       |
| 14         | Reserved (N.C. on device)                 |
| 15         | DDC CLOCK (SCL)                           |
| 16         | DDC DATA (SDA)                            |
| 17         | DDC/CEC Ground                            |
| 18         | +5 V POWER                                |
| 19         | HOT PLUG DETECT                           |



## USB Type-C port

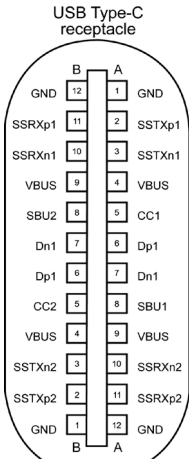



typically connected to a charger through a Type-C cable

| Pin        | Signal | Pin        | Signal |
|------------|--------|------------|--------|
| <b>A1</b>  | GND    | <b>B12</b> | GND    |
| <b>A2</b>  | SSTXp1 | <b>B11</b> | SSRXp1 |
| <b>A3</b>  | SSTXn1 | <b>B10</b> | SSRXn1 |
| <b>A4</b>  | VBUS   | <b>B9</b>  | VBUS   |
| <b>A5</b>  | CC1    | <b>B8</b>  | SBU2   |
| <b>A6</b>  | Dp1    | <b>B7</b>  | Dn1    |
| <b>A7</b>  | Dn1    | <b>B6</b>  | Dp1    |
| <b>A8</b>  | SBU1   | <b>B5</b>  | CC2    |
| <b>A9</b>  | VBUS   | <b>B4</b>  | VBUS   |
| <b>A10</b> | SSRXn2 | <b>B3</b>  | SSTXn2 |
| <b>A11</b> | SSRXp2 | <b>B2</b>  | SSTXp2 |
| <b>A12</b> | GND    | <b>B1</b>  | GND    |



## Universal Serial Bus (USB)

This section gives you information about the USB ports available on your monitor.

 **NOTE:** Up to 2 A on USB downstream port (port with  battery icon) with BC 1.2 compliance devices; up to 0.9 A on the other 2 USB downstream ports.

Your computer has the following USB ports:

- 4 downstream - 2 at left side, 2 at bottom

Power Charging Port - the ports with  battery icon supports fast current charging capability if the device is BC 1.2 compatible.

 **NOTE:** The monitor's USB ports work only when the monitor is on or in standby mode. In standby mode, if the USB cable (Type-C to Type-C) is plugged in, the USB ports can work normally. Otherwise, follow the OSD setting of USB, if the setting is "On During Standby" then USB work normally, otherwise USB is disabled. If you turn off the monitor and then turn it on, the attached peripherals may take a few seconds to resume normal functionality.

| Transfer speed | Data rate | Maximum power consumption (each port) |
|----------------|-----------|---------------------------------------|
| SuperSpeed     | 5 Gbps    | 4.5 W                                 |
| Hi-Speed       | 480 Mbps  | 2.5 W                                 |
| Full speed     | 12 Mbps   | 2.5 W                                 |

### USB downstream port

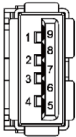

| Pin number | Signal     |
|------------|------------|
| 1          | VBUS       |
| 2          | D-         |
| 3          | D+         |
| 4          | GND        |
| 5          | StdA_SSRX- |
| 6          | StdA_SSRX+ |
| 7          | GND_DRAIN  |
| 8          | StdA_SSTX- |
| 9          | StdA_SSTX+ |
| Shell      | Shield     |



## RJ45 port (connector side)

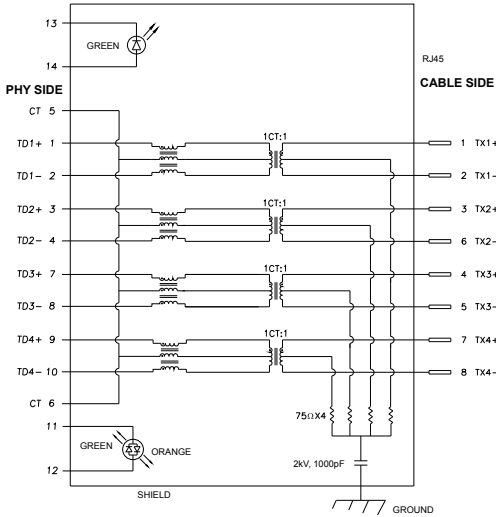

| Pin | Signal | Pin | Signal       |
|-----|--------|-----|--------------|
| 1   | TD1 +  | 8   | TD3 -        |
| 2   | TD1 -  | 9   | TD4 +        |
| 3   | TD2 +  | 10  | TD4 -        |
| 4   | TD2 -  | 11  | GREEN_ORANGE |
| 5   | CT     | 12  | GREEN_ORANGE |
| 6   | CT     | 13  | GREEN        |
| 7   | TD3 +  | 14  | GREEN        |

## Driver installation

Install the Realtek USB GBE Ethernet Controller Driver for Dell U2421HE/U2721DE available for your system. This is available for download at [www.dell.com/support](http://www.dell.com/support) under the “Driver and download” section.

Network (RJ45) data rate via USB-C at:

- 1). video priority: 480 Mbps
- 2). data priority: 1000 Mbps

**NOTE:** This LAN port is 1000Base-T IEEE 802.3az compliant, supporting Mac Address (Printed on model label) Pass-thru, Wake-on-LAN (WOL) from standby mode (S3 only) and PXE Boot function, these 3 features depend on BIOS setting and OS version.



## RJ45 Connector LED status:



| LED       | Color          | Description   |
|-----------|----------------|---|
| Right LED | Amber or Green | Speed indicator : <ul style="list-style-type: none"><li>• Amber On - 1000 Mbps</li><li>• Green On - 100 Mbps</li><li>• Off - 10 Mbps</li></ul>  |
| Left LED  | Green          | Link / Activity indicator : <ul style="list-style-type: none"><li>• <b>Blinking - Activity on the port.</b></li><li>• Green On -Link is being established.</li><li>• Off - Link is not established.</li></ul> |

 **NOTE:** RJ45 cable is non in-box standard accessory.



## Plug-and-Play

You can install the monitor in any Plug-and-Play-compatible system. The monitor automatically provides the computer system with its extended display identification data (EDID) using display data channel (DDC) protocols so the computer can configure itself and optimize the monitor settings. Most monitor installations are automatic; you can select different settings if desired. For more information about changing the monitor settings, see [Operating the Monitor](#).

## LCD Monitor Quality and Pixel Policy



During the LCD monitor manufacturing process, it is not uncommon for one or more pixels to become fixed in an unchanging state which are hard to see and do not affect the display quality or usability. For more information on LCD Monitor Pixel Policy, see Dell support site at: [www.dell.com/support/monitors](http://www.dell.com/support/monitors).





# Setting Up the Monitor

## Attaching the Stand

-  **NOTE:** The stand riser and stand base are detached when the monitor is shipped from the factory.
-  **NOTE:** The procedure below is applicable for the default stand. If you purchased any other stand, see the documentation shipped with the stand to set it up.
-  **CAUTION:** Place monitor on a flat, clean, and soft surface to avoid scratching the display panel.

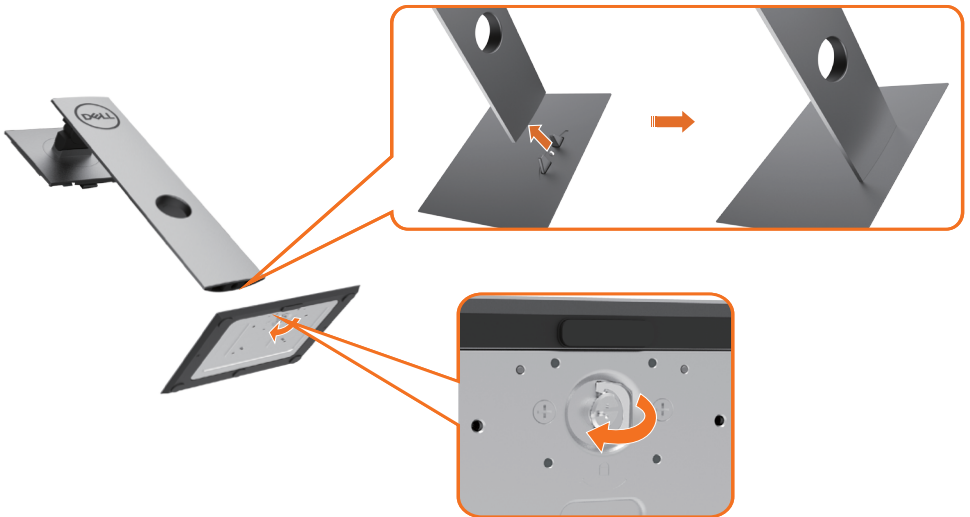

To attach the monitor stand:

- 1 Align the stand base protruded blocks to the matching slot on the stand.
- 2 Insert the stand base blocks fully into the stand slot.
- 3 Lift the screw handle and turn the screw clockwise.
- 4 After fully tightening the screw, fold the screw handle flat within the recess.





- 1 Remove the monitor protective cover and place the monitor with its front facing downward on it.
- 2 Insert the two tabs on the upper part of the stand to the groove on the back of the monitor.
- 3 Press the stand down till it snaps into its place.



# Using the Tilt, Swivel, and Vertical Extension

**NOTE:** This is applicable for a monitor with a stand. If you purchased any other stand, refer to the respective stand setup guide for set up instructions.

## Tilt, Swivel and Vertical Extension

With the stand attached to the monitor, you can tilt the monitor for the most comfortable viewing angle.

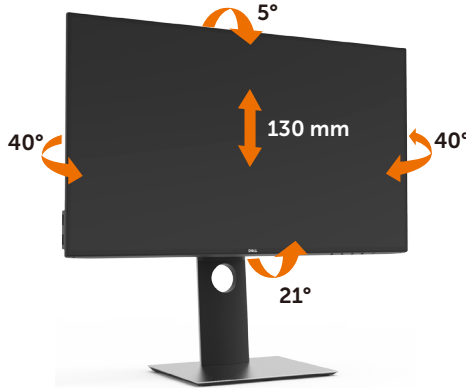

**NOTE:** The stand is detached when the monitor is shipped from the factory.

## Rotating the Monitor

Before you rotate the monitor, your monitor should be fully vertically extended and fully tilted up to avoid hitting the bottom edge of the monitor.



**NOTE:** To use the Display Rotation function (Landscape versus Portrait view) with your Dell computer, you require an updated graphics driver that is not included with this monitor. To download the graphics driver, go to [www.dell.com/support](http://www.dell.com/support) and see the Download section for Video Drivers for latest driver updates.

**NOTE:** When in the Portrait View Mode, you may experience performance degradation in graphic-intensive applications (3D Gaming and etc.).



# Adjusting the Rotation Display Settings of Your System

After you have rotated your monitor, you need to complete the procedure below to adjust the Rotation Display Settings of your System.

 **NOTE:** If you are using the monitor with a non-Dell computer, you need to go the graphics driver website or your computer manufacturer website for information on rotating the 'contents' on your display.

## To adjust the Rotation Display Settings:

- 1 Right-click on the desktop and click Properties.
- 2 Select the Settings tab and click Advanced.
- 3 If you have an AMD graphics card, select the Rotation tab and set the preferred rotation.
- 4 If you have an nVidia graphics card, click the nVidia tab, in the left-hand column select NVRotate, and then select the preferred rotation.
- 5 If you have an Intel® graphics card, select the Intel graphics tab, click Graphic Properties, select the Rotation tab, and then set the preferred rotation.

 **NOTE:** If you do not see the rotation option or it is not working correctly, go to [www.dell.com/support](http://www.dell.com/support) and download the latest driver for your graphics card.



# Connecting Your Monitor

**⚠ WARNING:** Before you begin any of the procedures in this section, follow the [Safety Instructions](#).

To connect your monitor to the computer:

- 1 Turn off your computer.
- 2 Connect the DP/USB type-C cable from your monitor to the computer.
- 3 Switch on your monitor.
- 4 Select the correct input source at monitor OSD Menu and turn on your computer.

**🔧 NOTE:** U2421HE/U2721DE default setting is DP 1.4. A DP 1.1 Graphic card may not display normally. Please refer to [“product specific problems – No image when using DP connection to the PC”](#) to change default setting.

## Connecting the HDMI cable (Optional)



## Connecting the DP cable



## Connecting the monitor for DP Multi-Stream Transport (MST) function

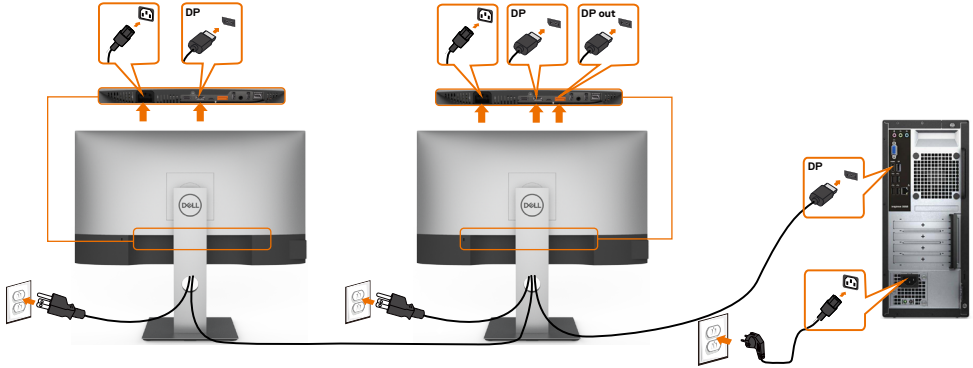

**NOTE:** Supports the DP MST feature. To make use of this feature, your PC Graphics Card must be certified to DP1.2 with MST option.

**NOTE:** Remove the rubber plug when using DP out connector.

## Connecting the USB Type-C cable



The USB Type-C port on your monitor:

- Can be used as USB Type-C or DisplayPort 1.4, alternatively.
- Supports USB Power Delivery (PD), with profiles up to 65 W.

**NOTE:** Regardless of the power requirement/actual power consumption of your laptop, or the remaining power runtime in your battery, the Dell U2421HE/U2721DE monitor is designed to supply power delivery of up to 65 W to your laptop.

| Rated power (on laptops that have USB Type-C with PowerDelivery) | Maximum charging power |
|--|------------------------|
| 45 W   | 45 W                   |
| 65 W   | 65 W                   |
| 90 W   | Not supported          |
| 130 W  | Not supported          |



## Connecting the monitor for USB-C Multi-Stream Transport (MST) function

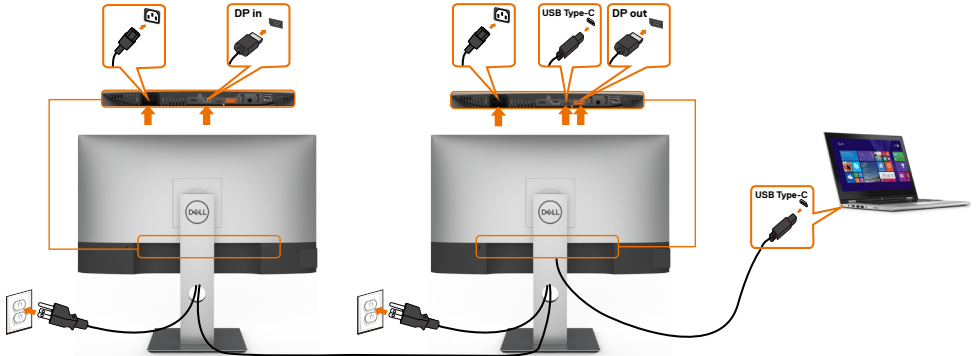

**NOTE:** The maximum number of supported U2721DE via MST is subjected to the bandwidth of the USB-C source. Please refer to “[product specific problems –No image when using USB-C MST](#)”.

**NOTE:** Remove the rubber plug when using DP out connector.

## Connecting the monitor for RJ45 Cable (Optional)



# Organizing Your Cables



After attaching all necessary cables to your monitor and computer, (see [Connecting Your Monitor](#) for cable attachment) organize all cables as shown above.

## Removing the Monitor Stand



**CAUTION:** To prevent scratches on the LCD screen while removing the stand, make sure that the monitor is placed on a soft, clean surface.



**NOTE:** The procedure below is applicable for the default stand. If you purchased any other stand, see the documentation shipped with the stand to set it up.

To remove the stand:

- 1 Place the monitor on a soft cloth or cushion.
- 2 Press and hold the stand-release button.
- 3 Lift the stand up and away from the monitor.

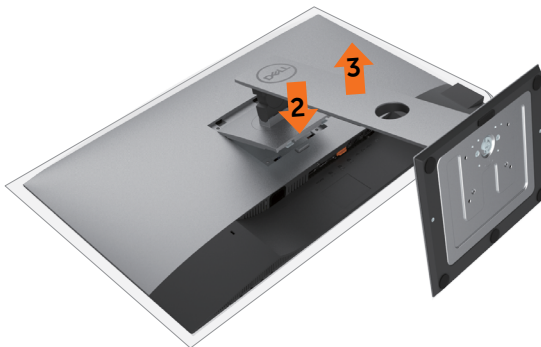



## Wall Mounting (Optional)



 **NOTE:** Use M4 x 10 mm screws to connect the monitor to the wall-mounting kit.

Refer to the instructions that come with the VESA-compatible wall mounting kit.

- 1 Place the monitor on a soft cloth or cushion on a stable, flat table.
- 2 Remove the stand.
- 3 Use a Phillips crosshead screwdriver to remove the four screws securing the plastic cover.
- 4 Attach the mounting bracket from the wall mounting kit to the monitor.
- 5 Mount the monitor on the wall by following the instructions that comes with the wall mounting kit.

 **NOTE:** For use only with UL or CSA or GS-listed wall mount bracket with minimum weight/load bearing capacity of 3.37 kg (U2421HE)/4.19 kg (U2721DE).



# Operating the Monitor

---

## Turning on the Monitor

Press the  button to turn on the monitor.

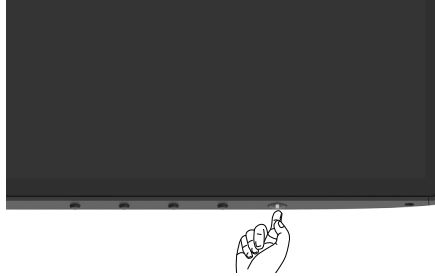



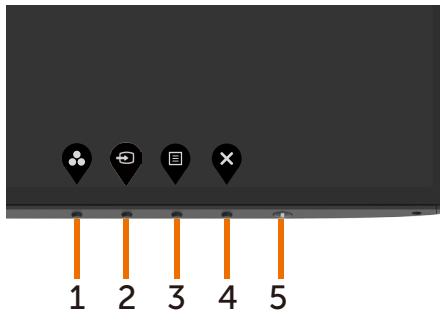

## Using the Front Panel Controls

Use the control buttons at the bottom edge of the monitor to adjust the characteristics of the image being displayed. As you use these buttons to adjust the controls, an OSD shows the numeric values of the characteristics as they change.



The following table describes the front panel buttons:

| Front-Panel Button  | Description   |
|---|---|
| 1<br><br><b>Shortcut key:<br/>Preset Modes</b>             | Use this button to choose from a list of preset color modes.  |
| 2<br><br><b>Shortcut key:<br/>Input Source</b>             | Use this button to choose from a list of Input Source.  |
| 3<br><br><b>Menu</b>                                       | Use this menu button to launch the on-screen display (OSD) and select the OSD menu.<br>See <a href="#">Accessing the Menu System</a> .  |
| 4<br><br><b>Exit</b>                                       | Use this button to go back to the main menu or exit the OSD main menu.  |
| 5<br><br><b>Power Button<br/>(with power-status light)</b> | To turn the monitor on or off.<br>Solid white light indicates the monitor is turned on and functioning normally. Blinking white light indicates the monitor is in Standby Mode. |



# Using the OSD Lock function

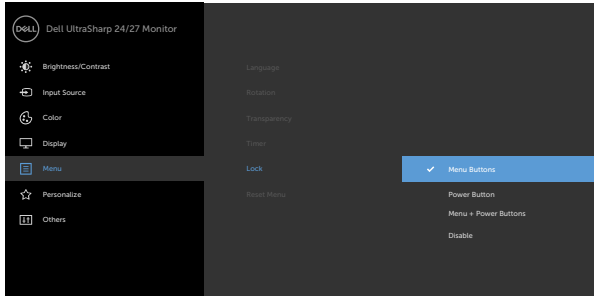

With the control buttons on the monitor locked, you can prevent people from accessing the controls. It also prevents accidental activation in multiple monitors side-by-side setup.

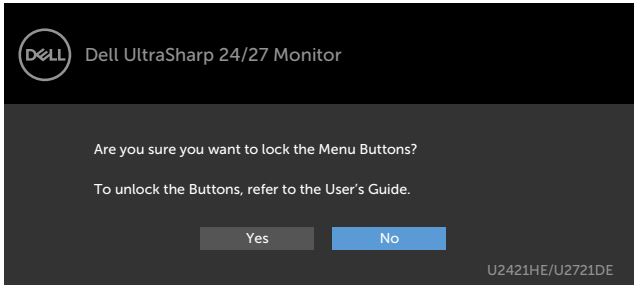

1. The following message will appear:





2. Select 'Yes' to Lock the buttons, the following table describes the control icons:

| Options  | Description  |
|--|--|
| 1<br><br><b>Menu Buttons lock</b>           | Use this icon to lock OSD menu function.                           |
| 2<br><br><b>Power button lock</b>           | Use this icon to lock power button from powering off.              |
| 3<br><br><b>Menu and Power buttons lock</b> | Use this icon to lock OSD menu and power button from powering off. |



| Options                     |   | Description   |
|-----------------------------|---|---|
| 4                           |  | Use this icon to run the built-in diagnostics, see <a href="#">Built-in Diagnostics</a> . |
| <b>Built-in Diagnostics</b> |   |   |

3. Hold  for 4 seconds, Select the following table describes the unlock icons:





| Options                            |   | Description  |
|------------------------------------|---|--|
| 1                                  |  | Use this icon to unlock OSD menu function.                           |
| <b>Menu Buttons lock</b>           |   |  |
| 2                                  |  | Use this icon to unlock power button from powering off.              |
| <b>Power button lock</b>           |   |  |
| 3                                  |  | Use this icon to unlock OSD menu and power button from powering off. |
| <b>Menu and Power buttons lock</b> |   |  |



## Front-Panel Button

Use the buttons on the front of the monitor to adjust the image settings.





| Front Panel Button   | Description   |
|--|---|
| 1  <br>Up Down | Use the <b>Up</b> (increase) and <b>Down</b> (decrease) keys to adjust items in the OSD menu. |
| 2 <br>OK  | Use the <b>OK</b> button to confirm your selection.   |
| 3 <br>Back  | Use the <b>Back</b> button to go back to the previous menu.                                   |











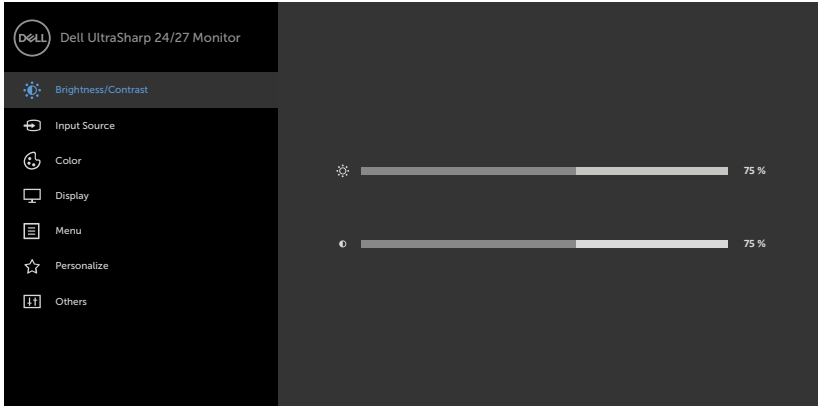



# Using the On-Screen Display (OSD) Menu

## Accessing the Menu System

 **NOTE:** Any changes you make using the OSD menu are automatically saved if you move to another OSD menu, exit the OSD menu, or wait for the OSD menu to disappear.

- 1 Press the  button to launch the OSD menu and display the main menu.



- 2 Press the  and  buttons to move between options. As you move from one icon to another, the option name is highlighted.
- 3 Press the , , or  button once to activate the highlighted option.
- 4 Press the  and  buttons to select the desired parameter.
- 5 Press  to enter the slide bar and then use the  or  button, according to the indicators on the menu, to make your changes.
- 6 Select the  to return to previous menu or  to accept and return to previous menu.



---

| Icon | Menu and Submenus | Description |
|------|-------------------|-------------|
|------|-------------------|-------------|

---



### Brightness/Contrast

Use this menu to activate **Brightness/Contrast** adjustment.

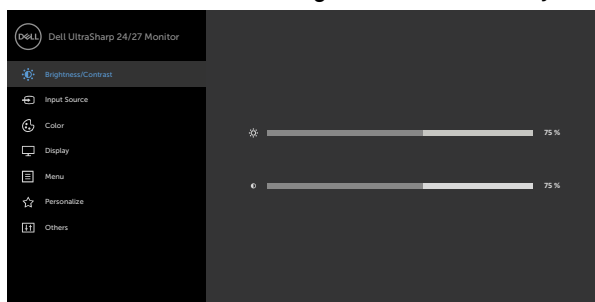

---

#### Brightness

**Brightness** adjusts the luminance of the backlight (minimum 0; maximum 100).



Press the  button to increase brightness.

Press the  button to decrease brightness.

---

#### Contrast

Adjust the **Brightness** first, and then adjust **Contrast** only if further adjustment is necessary.

Press the  button to increase contrast and press the  button to decrease contrast (between 0 and 100).

Contrast adjusts the difference between darkness and lightness on the monitor.





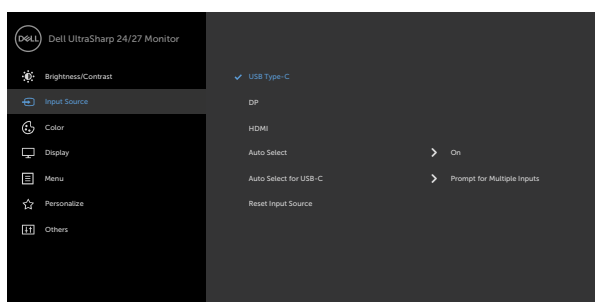

### Input Source

Use the **Input Source** menu to select between different video inputs that are connected to your monitor.





| Icon | Menu and Submenus            | Description   |
|------|------------------------------|---|
|      | <b>USB Type-C</b>            | Select <b>USB Type-C</b> input when you are using the USB Type-C connector.<br>Use  to select the USB Type-C input source.   |
|      | <b>DP</b>                    | Select <b>DP</b> input when you are using the DP (DisplayPort) connector.<br>Use  to select the DP input source.   |
|      | <b>HDMI</b>                  | Select <b>HDMI</b> input when you are using the HDMI connector.<br>Use  to select the HDMI input source.   |
|      | <b>Auto Select</b>           | Use  to select <b>Auto Select</b> , the monitor scans for available input sources.   |
|      | <b>Auto Select for USB-C</b> | Allows you to set Auto Select for USB Type-C to: <ul style="list-style-type: none"> <li>• <b>Prompt for Multiple Inputs</b> : always show Switch to USB Type-C Video Input message for user to choose whether to switch or not.</li> <li>• <b>Yes</b>: The monitor always switch to USB Type-C video without asking while USB Type-C connected.</li> <li>• <b>No</b>: The monitor will NOT auto switch to USB Type-C video from another available input.</li> </ul> |
|      | <b>Reset Input Source</b>    | Resets your monitor's Input Source settings to the factory defaults.  |



## Color

Use the **Color** menu to adjust the color setting mode.

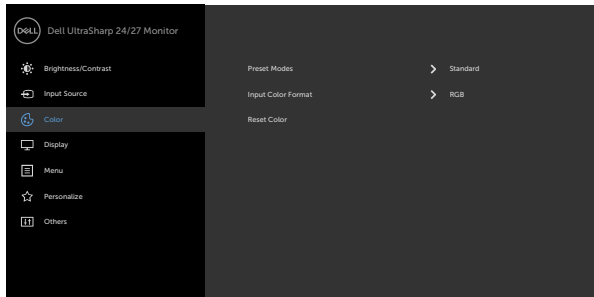

| Icon | Menu and Submenus | Description |
|------|-------------------|-------------|
|------|-------------------|-------------|

**Preset Modes** When you select **Preset Modes**, you can choose **Standard**, **ComfortView**, **Multiscreen Match**, **Movie**, **Game**, **Color Temp.** or **Custom Color** from the list.

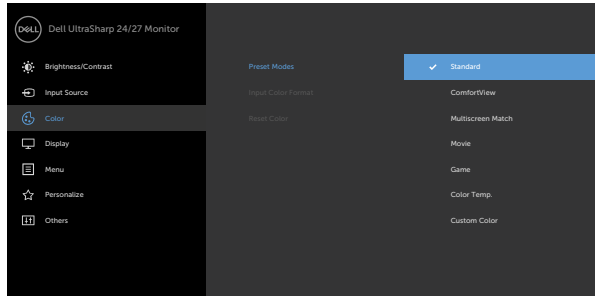



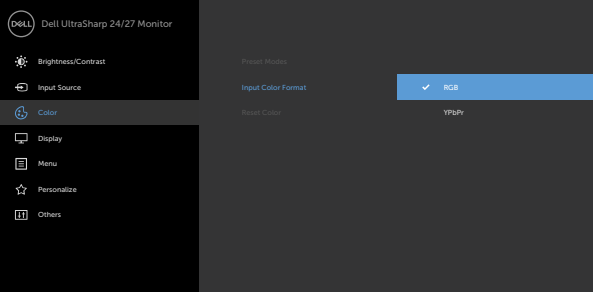

- **Standard:** Default color settings. This is the default preset mode.
- **ComfortView:** Decreases the level of blue light emitted from the screen to make viewing more comfortable for your eyes.  
**NOTE:** To reduce the risk of eye strain and neck/arm/back/shoulders pain from using the monitor for long periods of time, we suggest you to :
  - Set the screen about 20 to 28 in. (50-70 cm) from your eyes.
  - Blink frequently to moisten or rewet your eyes when working with the monitor.
  - Take regular and frequent breaks for 20 minutes every two hours.
  - Look away from your monitor and gaze at a distant object at 20 feet away for at least 20 seconds during the breaks.
  - Perform stretches to relieve tension in the neck/arm/back/shoulders during the breaks.
- **Multiscreen Match:** Option to allow matching of the white backgrounds on multiple monitors.
- **Movie:** Ideal for movies.
- **Game:** Ideal for most gaming applications.
- **Color Temp.:** The screen appears warmer with a red/yellow tint with slider set at 5,000K or cooler with blue tint with slider set at 10,000K.
- **Custom Color:** Allows you to manually adjust the color settings. Press the ◀ and ▶ buttons to adjust the Red, Green, and Blue values and create your own preset color mode.



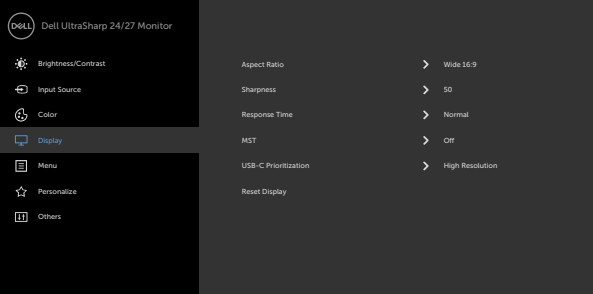





| Icon | Menu and Submenus         | Description  |
|------|---------------------------|--|
|      | <b>Input Color Format</b> | <p>Allows you to set the video input mode to:</p> <ul style="list-style-type: none"> <li>• <b>RGB:</b> Select this option if your monitor is connected to a computer (or DVD player) using the USB Type-C, DP cable.</li> <li>• <b>YPbPr:</b> Select this option if your DVD player supports only YPbPr output.</li> </ul> |
|      |                           |  <p style="text-align: right;"> <span>⬆</span> <span>⬇</span> <span>⬆</span> <span>⬇</span> </p>  |
|      | <b>Hue</b>                | <p>Use <span>⬆</span> or <span>⬇</span> to adjust the hue from 0 to 100.</p> <p><b>NOTE:</b> Hue adjustment is available only for Movie and Game mode.</p>   |
|      | <b>Saturation</b>         | <p>Use <span>⬆</span> or <span>⬇</span> to adjust the saturation from 0 to 100.</p> <p><b>NOTE:</b> Saturation adjustment is available only for Movie and Game mode.</p>   |
|      | <b>Reset Color</b>        | <p>Resets your monitor's color settings to the factory defaults.</p>   |

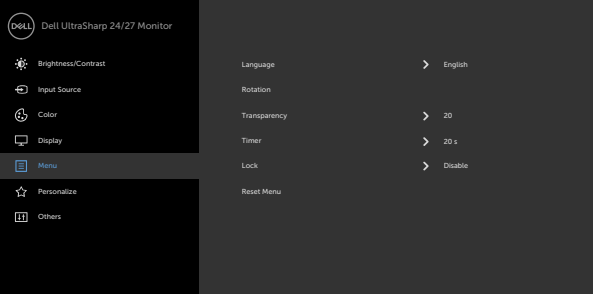



| Icon  | Menu and Submenus   | Description                                  |
|---|---|--|
|   | <b>Display</b>  | Use the <b>Display</b> menu to adjust image. |
|  |   |  |
|  |   |  |
| <b>Aspect Ratio</b>   | Adjust the image ratio to <b>Wide 16:9, Auto Resize, 4:3, 1:1</b> .   |  |
| <b>Sharpness</b>  | Makes the image look sharper or softer.<br>Use  or  to adjust the sharpness from '0' to '100'.  |  |
| <b>Response Time</b>  | Allows you to set the <b>Response Time</b> to <b>Normal</b> or <b>Fast</b> .  |  |
| <b>MST</b>  | DP Multi Stream Transport, Set to ON enables MST(DP out), Set to OFF disables MST function.<br><br><b>NOTE:</b> When DP/USB Type-C upstream cable and DP downstream cable is connected, monitor will set MST = ON automatically, this action will only be done once after Factory Reset or Display Reset.   |  |
| <b>USB-C Prioritization (U2721DE only)</b>  | Allows you to specify the priority to transfer the data with high resolution ( <b>High Resolution</b> ) or high speed ( <b>High Data Speed</b> ) when using the USB Type-C port/DisplayPort.<br><b>NOTE:</b> If your PC does not have a built-in battery pack and is powered directly from the monitor USB Type-C port (such as the Dell OptiPlex Ultra Desktop), changing <b>USB-C Prioritization</b> on the fly would interrupt the power from monitor to the PC. Please set <a href="#">USB-C Charging</a> to <b>On During Power Off</b> and refer to <a href="#">Setting USB-C Prioritization when USB-C Charging is set to On During Power Off</a> . |  |
| <b>Reset Display</b>  | Restores the display settings to factory defaults.  |  |



| Icon   | Menu and Submenus   | Description   |
|--|---------------------|---|
|  | Menu                | <p>Select this option to adjust the settings of the OSD, such as the languages of the OSD, the amount of time the menu remains on screen, and so on.</p>   |
|  |                     |    |
|  | <b>Language</b>     | <p>Set the OSD display to one of eight languages. (English, Spanish, French, German, Brazilian Portuguese, Russian, Simplified Chinese, or Japanese).</p>   |
|  | <b>Rotation</b>     | <p>Rotates the OSD by 0/90/180/270 degrees. You can adjust the menu according to your display rotation.</p>   |
|  | <b>Transparency</b> | <p>Select this option to change the menu transparency by using  and  (min. 0 / max. 100).</p>  |
|  | <b>Timer</b>        | <p><b>OSD Hold Time:</b> Sets the length of time the OSD remains active after you press a button.</p> <p>Use the  and  buttons to adjust the slider in 1-second increments, from 5 to 60 seconds.</p> |

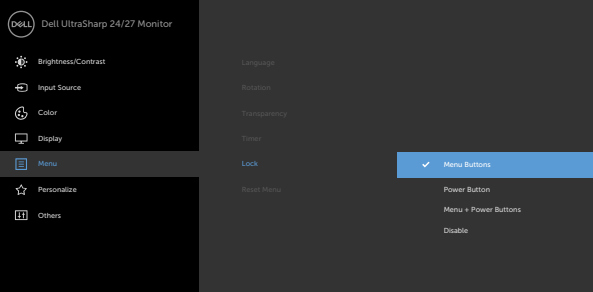

| Icon  | Menu and Submenus                              | Description   |
|---|--|---|
|  | <b>Lock</b>                                    | Controls user access to adjustments. the buttons are locked.  |
|  |  |    |
|   |  | <ul style="list-style-type: none"> <li>• <b>Menu Buttons:</b> Through OSD to lock the Menu buttons.</li> <li>• <b>Power Button:</b> Through OSD to lock the Power button.</li> <li>• <b>Menu + Power Buttons:</b> Through OSD to lock the all of Menu and Power buttons.</li> <li>• <b>Disable:</b> Press and hold the  button on the left of the power button for 4 sec.</li> </ul> |
| <b>Reset Menu</b>   | Restore the menu settings to factory defaults. |   |



| Icon   | Menu and Submenus   | Description   |
|--|---|---|
|  | <b>Personalize</b>  |  |
| <b>Shortcut key 1</b>  | Select from <b>Preset Modes, Brightness/Contrast, Input Source, Aspect Ratio, Rotation</b> set as shortcut key 1.   |   |
| <b>Shortcut key 2</b>  | Select from <b>Preset Modes, Brightness/Contrast, Input Source, Aspect Ratio, Rotation</b> set as shortcut key 2.   |   |
| <b>Power Button LED</b>  | Allows you to set the state of the power light to save energy.  |   |
| <b>USB-A Charging</b>  | <p>Allows you to enable or disable USB Type-A (Downstream Ports) charging function during monitor standby mode.</p> <p><b>NOTE:</b> This option is only available when the USB Type-C (Upstream Port) cable is unplugged. If the USB Type-C cable is connected, USB-A Charging follows the USB host power status and the option is not accessible.</p> <p><b>NOTE:</b> This option was previously called “USB” in older monitor firmware revisions.</p> |   |
| <b>USB-C Charging</b>  | Allows you to enable or disable Always On USB Type-C Charging function during monitor Power Off mode.   |   |
| <b>Reset Personalization</b>   | Restores shortcut keys to factory defaults.   |   |



---

| Icon | Menu and Submenus | Description |
|------|-------------------|-------------|
|------|-------------------|-------------|

---



### Others

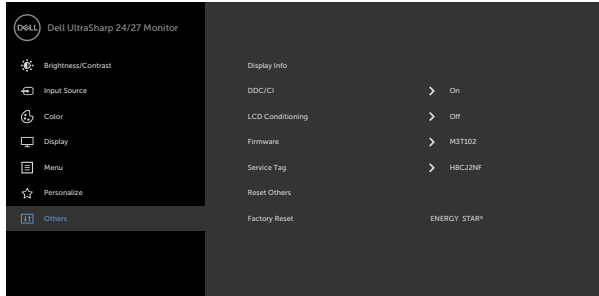

Select this option to adjust the OSD settings such as the **DDC/CI**, **LCD conditioning**, and so on.

---

### Display Info

Displays the monitor's current settings.

---

### DDC/CI

**DDC/CI** (Display Data Channel/Command Interface) allows you to adjust the monitor settings using software on your computer. Select **Off** to turn off this feature.

Enable this feature for best user experience and optimum performance of your monitor.

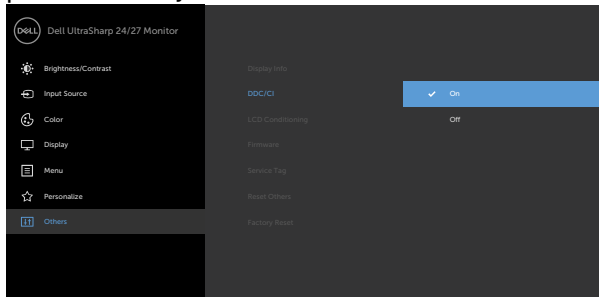



| Icon | Menu and Submenus | Description |
|------|-------------------|-------------|
|------|-------------------|-------------|

**LCD Conditioning**

Helps reduce minor cases of image retention. Depending on the degree of image retention, the program may take some time to run. Select **On** to start the process.

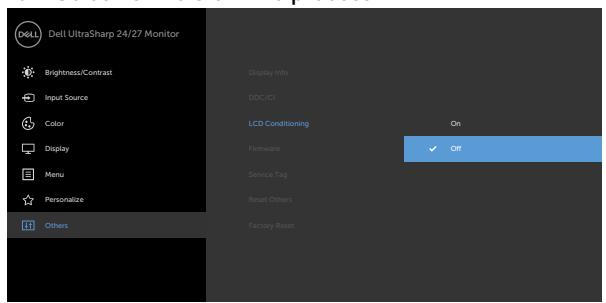

|                 |                   |
|-----------------|-------------------|
| <b>Firmware</b> | Firmware version. |
|-----------------|-------------------|

|                    |  |
|--------------------|--|
| <b>Service Tag</b> | <p>Displays the Service Tag. The Service Tag is a unique alphanumeric identifier that allows Dell to identify the product specifications and access warranty information.</p> <p><b>NOTE:</b> The Service Tag is also printed on a label located at the back of the cover.</p> |
|--------------------|--|

|                     |   |
|---------------------|---|
| <b>Reset Others</b> | Restores other settings, such as <b>DDC/CI</b> , to factory defaults. |
|---------------------|---|

|                      |   |
|----------------------|---|
| <b>Factory Reset</b> | Restores all preset values to the factory default settings. These are also the settings for ENERGY STAR® tests. |
|----------------------|---|

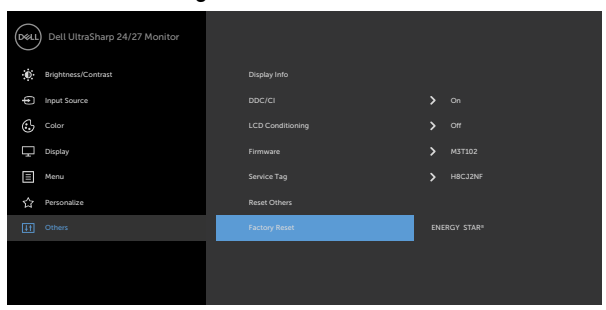

# OSD Warning Messages

When the monitor does not support a particular resolution mode, you can see the following message:

## U2421HE

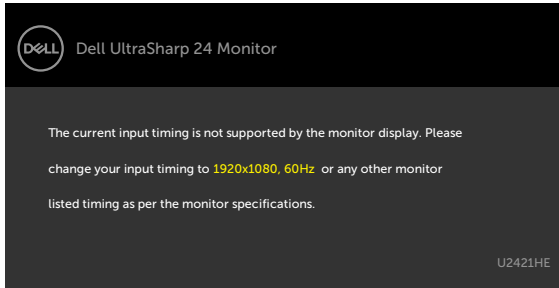

## U2721DE

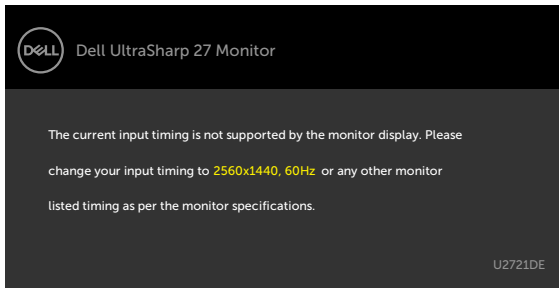

This means that the monitor cannot synchronize with the signal that it is receiving from the computer. See [Monitor Specifications](#) for the Horizontal and Vertical frequency ranges addressable by this monitor. Recommended mode is 1920 x 1080 (U2421HE) / 2560 x 1440 (U2721DE).

You can see the following message before the DDC/CI function is disabled:

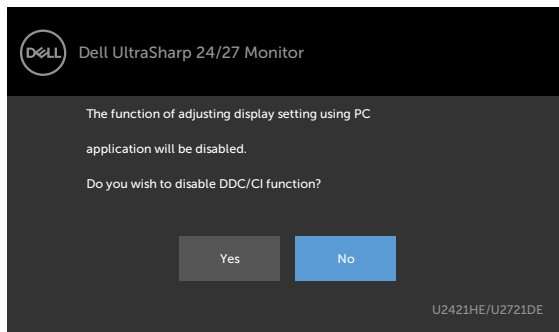

When the monitor enters the **Standby** mode, the following message will appear:

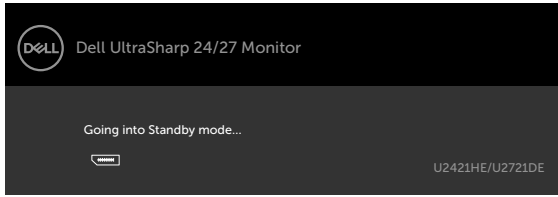

Activate the computer and wake up the monitor to gain access to the **OSD**.

If you press any button other than the power button, the following messages will appear depending on the selected input:

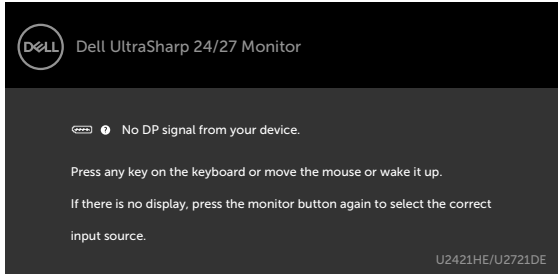

If either DP, USB Type-C input is selected and the corresponding cable is not connected, a floating dialog box as shown below appears.

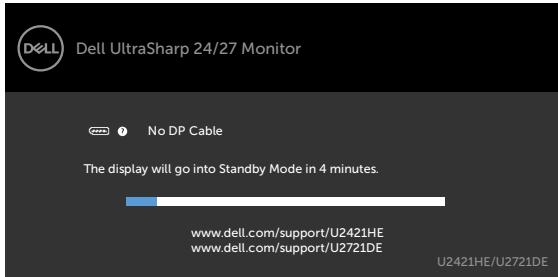

or

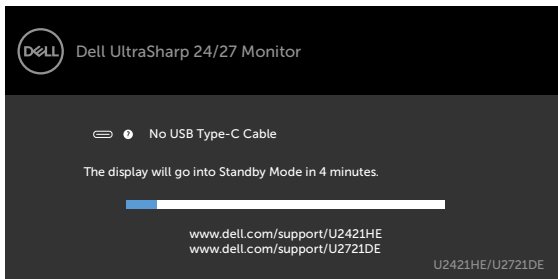

A message is displayed while the cable supporting DP alternate mode is connected to the monitor under the following conditions:

- When **Auto Select for USB-C** is set to **Prompt for Multiple Inputs**.
- When the DP cable is connected to the monitor.

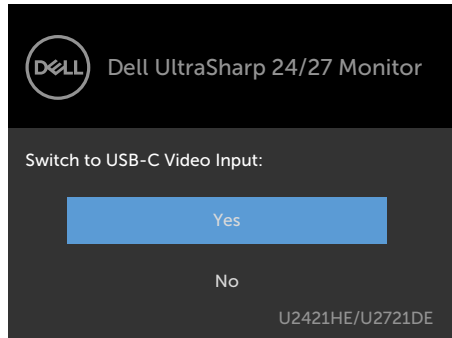

If **USB-C Charging** is set to **Off During Power Off** :

- When you select OSD items of **USB-C Prioritization to High Resolution** in Display feature, the following message will appear:



- When you select OSD items of **USB-C Prioritization to High Data Speed** in Display feature, the following message will appear:

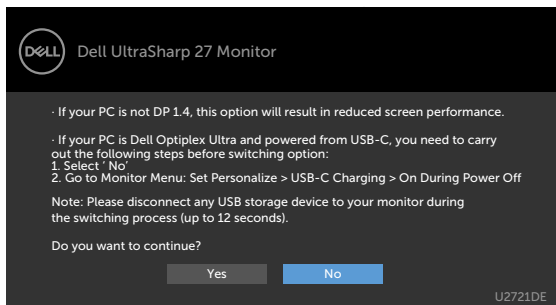

If **USB-C Charging** is set to **On During Power Off**, when you select OSD item of **USB-C Prioritization** to **High Resolution** or **High Data Speed** in Display feature, the following message will appear:

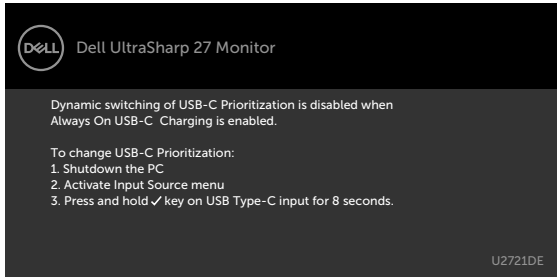

When **USB-C Charging** is set to **Off During Power Off** and **USB-C Prioritization** is set to **High Data Speed**:

- Select OSD items of **Factory Reset** in **Other** feature, the following message will appear:

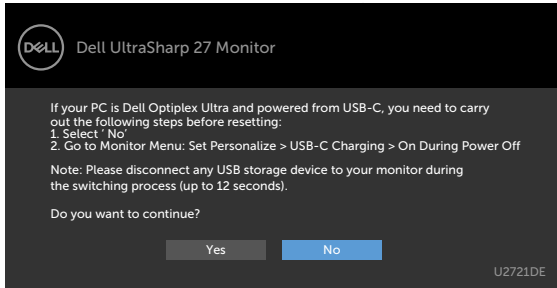

- Select OSD items of **Display Reset** in **Display** feature, the following message will appear:

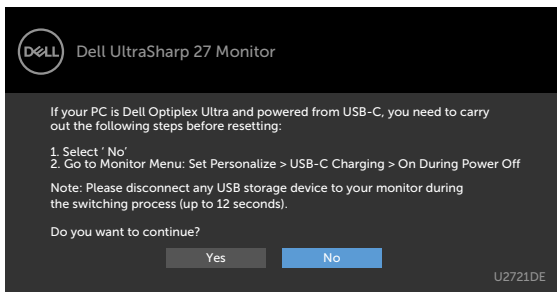

Select OSD items of **On in Standby Mode** in Personalize feature, the following message will appear:

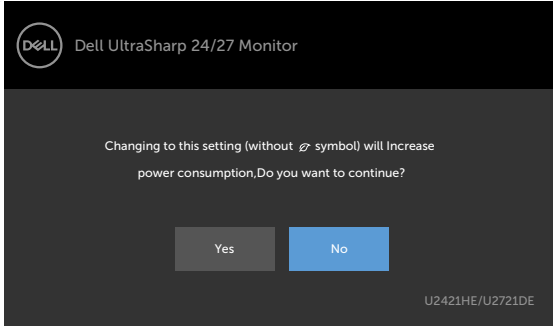

If adjust the Brightness level above the default level over 75%, the following message will appear:

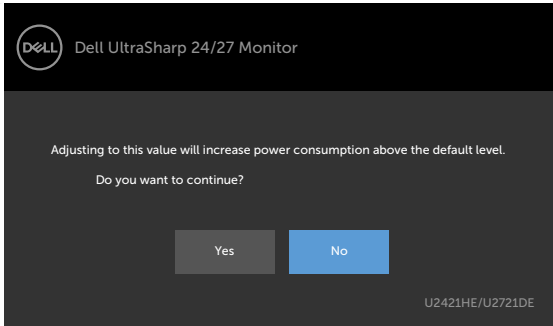

When **USB-C Charging** is set to **On During Power Off** and USB-C Prioritization is set to **High Data Speed**, select OSD items of Factory Reset in Other feature, the following message will appear:

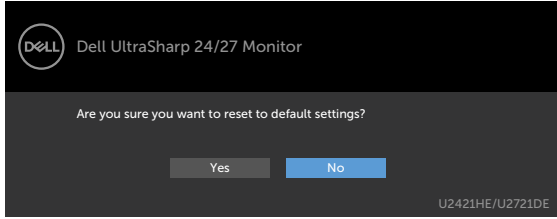

When you select 'Yes' to reset to default settings, the following message will appear:

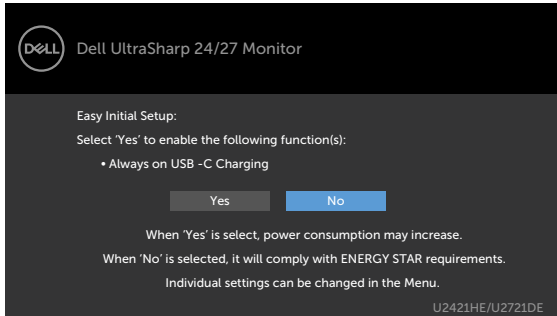

When you select 'No', then do the second **Factory Reset**, the following message will appear:

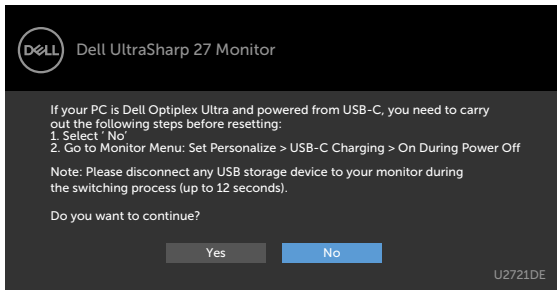

See [Troubleshooting](#) for more information.



# Troubleshooting

**⚠ WARNING:** Before you begin any of the procedures in this section, follow the [Safety Instructions](#).

## Self-Test

Your monitor provides a self-test feature that allows you to check whether your monitor is functioning properly. If your monitor and computer are properly connected but the monitor screen remains dark, run the monitor self-test by performing the following steps:

- 1 Turn off both your computer and the monitor.
- 2 Unplug the video cable from the back of the computer. To ensure proper Self-Test operation, remove all digital and the analog cables from the back of computer.
- 3 Turn on the monitor.

The floating dialog box should appear on-screen (against a black background), if the monitor cannot sense a video signal and is working correctly. While in self-test mode, the power LED remains white. Also, depending upon the selected input, one of the dialogs shown below will continuously scroll through the screen.

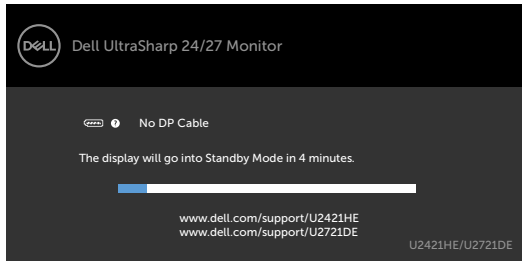

or

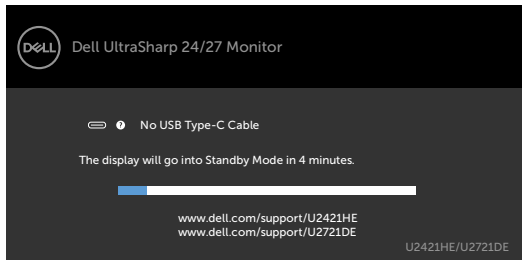

- 4 This box also appears during normal system operation if the video cable becomes disconnected or damaged.
- 5 Turn off your monitor and reconnect the video cable; then turn on both your computer and the monitor.

If your monitor screen remains blank after you use the previous procedure, check your video controller and computer, because your monitor is functioning properly.





# Built-in Diagnostics

Your monitor has a built-in diagnostic tool that helps you determine if the screen abnormality you are experiencing is an inherent problem with your monitor, or with your computer and video card.

 **NOTE:** You can run the built-in diagnostics only when the video cable is unplugged and the monitor is in self-test mode.

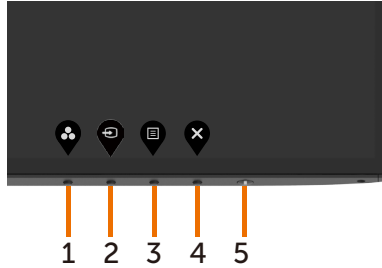

To run the built-in diagnostics:



- 1 Make sure that the screen is clean (no dust particles on the surface of the screen).
- 2 Unplug the video cable(s) from the back of the computer or monitor. The monitor then goes into the self-test mode.
- 3 Press and hold **Button 1** for 5 seconds. A gray screen appears.
- 4 Carefully inspect the screen for abnormalities.
- 5 Press **Button 1** on the front panel again. The color of the screen changes to red.
- 6 Inspect the display for any abnormalities.
- 7 Repeat steps 5 and 6 to inspect the display in green, blue, black, white, and text screens.

The test is complete when the text screen appears. To exit, press **Button 1** again. If you do not detect any screen abnormalities upon using the built-in diagnostic tool, the monitor is functioning properly. Check the video card and computer.



# Setting USB-C Prioritization when USB-C Charging is set to On During Power Off

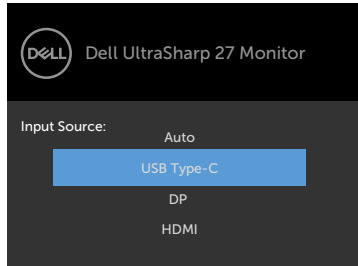

If **USB-C Charging** is set to **On During Power Off**, the monitor allows you to specify the USB-C Prioritization settings only when your PC is powered off.

- 1 Ensure that your PC is powered off.
- 2 Press any control button other than the power button to display the shortcut menu of **Input Source**.
- 3 Use the  or  button to highlight **USB Type-C**.

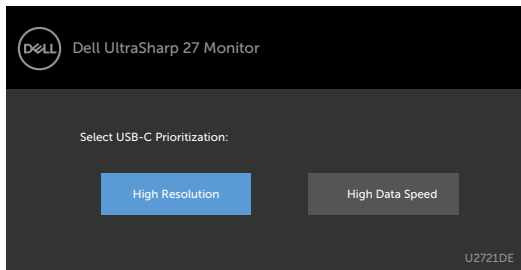

- 4 Press and hold the  button for approximately 8 seconds.
- 5 The **USB-C Prioritization** configuration message will appear.



- 6 Use the  or  button to specify the preferred transfer priority.
- 7 The setting will be effective after you turn on the PC.



# Common Problems

The following table contains general information about common monitor problems you might encounter and the possible solutions:

| Common Symptoms        | What You Experience              | Possible Solutions   |
|------------------------|----------------------------------|--|
| No Video/Power LED off | No picture                       | <ul style="list-style-type: none"><li>• Ensure that the video cable connecting the monitor and the computer is properly connected and secure.</li><li>• Verify that the power outlet is functioning properly using any other electrical equipment.</li><li>• Ensure that the power button is depressed fully.</li><li>• Ensure that the correct input source is selected in the <a href="#">Input Source</a> menu.</li></ul> |
| No Video/Power LED on  | No picture or no brightness      | <ul style="list-style-type: none"><li>• Increase brightness and contrast controls via OSD.</li><li>• Perform monitor self-test feature check.</li><li>• Check for bent or broken pins in the video cable connector.</li><li>• Run the built-in diagnostics.</li><li>• Ensure that the correct input source is selected in the <a href="#">Input Source</a> menu.</li></ul>   |
| Missing Pixels         | LCD screen has spots             | <ul style="list-style-type: none"><li>• Cycle power on-off.</li><li>• Pixel that is permanently off is a natural defect that can occur in LCD technology.</li><li>• For more information on Dell Monitor Quality and Pixel Policy, see Dell Support site at: <a href="http://www.dell.com/support/monitors">www.dell.com/support/monitors</a>.</li></ul>   |
| Stuck-on Pixels        | LCD screen has bright spots      | <ul style="list-style-type: none"><li>• Cycle power On-Off.</li><li>• Pixel that is permanently off is a natural defect that can occur in LCD technology.</li><li>• For more information on Dell Monitor Quality and PixelPolicy, see Dell Support site at: <a href="http://www.dell.com/support/monitors">www.dell.com/support/monitors</a>.</li></ul>  |
| Brightness Problems    | Picture too dim or too bright    | <ul style="list-style-type: none"><li>• Reset the monitor to factory settings.</li><li>• Adjust brightness and contrast controls via OSD.</li></ul>  |
| Safety Related Issues  | Visible signs of smoke or sparks | <ul style="list-style-type: none"><li>• Do not perform any troubleshooting steps.</li><li>• Contact Dell immediately.</li></ul>  |
| Intermittent Problems  | Monitor malfunctions on & off    | <ul style="list-style-type: none"><li>• Ensure that the video cable connecting the monitor to the computer is connected properly and is secure.</li><li>• Reset the monitor to factory settings.</li><li>• Perform monitor self-test feature check to determine if the intermittent problem occurs in self-test mode.</li></ul>  |



| Common Symptoms   | What You Experience  | Possible Solutions  |
|---|--|---|
| Missing Color   | Picture missing color  | <ul style="list-style-type: none"> <li>• Perform monitor self-test.</li> <li>• Ensure that the video cable connecting the monitor to the computer is connected properly and is secure.</li> <li>• Check for bent or broken pins in the video cable connector.</li> </ul>  |
| Wrong Color   | Picture color not good   | <ul style="list-style-type: none"> <li>• Change the settings of the <b>Preset Modes</b> in the <b>Color</b> menu OSD depending on the application.</li> <li>• Adjust R/G/B value under <b>Custom Color</b> in <b>Color</b> menu OSD.</li> <li>• Change the <b>Input Color Format</b> to PC RGB or YPbPr in the <b>Color</b> menu OSD.</li> <li>• Run the built-in diagnostics.</li> </ul> |
| Image retention from a static image left on the monitor for a long period of time | Faint shadow from the static image displayed appears on the screen | <ul style="list-style-type: none"> <li>• Set the screen to turn off after a few minutes of screen idle time. These can be adjusted in Windows Power Options or Mac Energy Saver setting.</li> <li>• Alternatively, use a dynamically changing screensaver.</li> </ul>   |

## Product Specific Problems

| Problem   | What you experience  | Possible solutions   |
|---|--|--|
| Screen image is too small                                     | Image is centered on screen, but does not fill entire viewing area | <ul style="list-style-type: none"> <li>• Check the <b>Aspect Ratio</b> setting in the <b>Display</b> menu OSD.</li> <li>• Reset the monitor to factory settings.</li> </ul>  |
| Cannot adjust the monitor with the buttons on the front panel | OSD does not appear on the screen                                  | <ul style="list-style-type: none"> <li>• Turn off the monitor, unplug the monitor power cable, plug it back, and then turn on the monitor.</li> </ul>  |
| No Input Signal when user controls are pressed                | No picture, the LED light is white                                 | <ul style="list-style-type: none"> <li>• Check the signal source. Ensure the computer is not in the power saving mode by moving the mouse or pressing any key on the keyboard.</li> <li>• Check whether the signal cable is plugged in properly. Connect the signal cable again, if necessary.</li> <li>• Reset the computer or video player.</li> </ul> |



| <b>Problem</b>  | <b>What you experience</b>                                | <b>Possible solutions</b>   |
|---|---|---|
| The picture does not fill the entire screen   | The picture cannot fill the height or width of the screen | <ul style="list-style-type: none"> <li>• Due to different video formats (aspect ratio) of DVDs, the monitor may display in full screen.</li> <li>• Run the built-in diagnostics.</li> </ul>   |
| No image when using USB Type-C connection to computer, laptop, and so on              | Black screen  | <ul style="list-style-type: none"> <li>• Verify if the USB Type-C interface of the device can support DP alternate mode.</li> <li>• Verify if the device required more than 65 W power charging.</li> <li>• USB Type-C interface of device cannot support DP alternate mode.</li> <li>• Set Windows to Projection mode.</li> <li>• Ensure that the USB Type-C cable is not damaged.</li> </ul>  |
| No charging when using USB Type-C connection to computer, laptop, and so on           | No charging   | <ul style="list-style-type: none"> <li>• Verify if the device can support one of 5 V/9 V/15 V/20 V charging profiles.</li> <li>• Verify if the Notebook requires a &gt;65 W power adaptor.</li> <li>• If the Notebook requires a &gt;65 W power adaptor, it may not charge with the USB Type-C connection.</li> <li>• Ensure that you use only Dell approved adapter or the adapter that comes with the product.</li> <li>• Ensure that the USB Type-C cable is not damaged.</li> </ul>         |
| Intermittent charging when using USB Type-C connection to computer, laptop, and so on | Intermittent charging                                     | <ul style="list-style-type: none"> <li>• Check if the maximum power consumption of device is over 65 W.</li> <li>• Ensure that you use only Dell approved adapter or the adapter that comes with the product.</li> <li>• Ensure that the USB Type-C cable is not damaged.</li> </ul>  |
| No image when using DP connection to the PC   | Black screen  | <ul style="list-style-type: none"> <li>• Verify which DP standard (DP 1.1a or DP 1.4) is your Graphics Card certified to. Download and install the latest graphics card driver.</li> <li>• Some DP 1.1a graphics card cannot support DP 1.4 monitors. Go to OSD menu, under Input Source selection, press and hold DP select  key for 8 sec to change the monitor setting from DP 1.4 to DP 1.1a.</li> </ul> |
| No image when using USB Type-C MST  | Black screen or 2nd DUT is not Prime mode                 | <ul style="list-style-type: none"> <li>• USB Type-C input, Go to OSD menu, under Display Info check the Link Rate is HBR2 or HBR3, if Link Rate is HBR2, suggest to use USB Type-C to DP cable to turn on MST.</li> </ul>   |
| No network connection   | Network dropped or Intermittent                           | <ul style="list-style-type: none"> <li>• check to ensure data priority is selected in OSD. Do not toggle Off/On the power button when network is connected, keeps the power button On.</li> </ul>   |



---

| <b>Problem</b>                  | <b>What you experience</b>           | <b>Possible solutions</b>   |
|---------------------------------|--------------------------------------|---|
| The LAN port is not functioning | OS setting or cable connection issue | <ul style="list-style-type: none"><li>• Ensure that the latest BIOS and drivers for your computer are installed on your computer.</li><li>• Ensure that the RealTek Gigabit Ethernet Controller is installed in the Windows Device Manager.</li><li>• If your BIOS Setup has a LAN/GBE Enabled/Disabled option, make sure it is set to <b>Enabled</b>.</li><li>• Ensure that the Ethernet cable is connected securely on the monitor and the hub/router/firewall.</li><li>• Check the status LED of the Ethernet cable to confirm connectivity. Re-connect both ends of the Ethernet cable if the LED is not lit.</li><li>• First power off the Computer and unplug the Type-C cable and power cord of the monitor. Then, power on the computer, plug in the monitor power cord and Type-C cable.</li></ul> |

---



# Appendix

---

## Safety Instructions

For displays with glossy bezels the user should consider the placement of the display as the bezel may cause disturbing reflections from surrounding light and bright surfaces.

 **WARNING: Use of controls, adjustments, or procedures other than those specified in this documentation may result in exposure to shock, electrical hazards, and/or mechanical hazards.**

For information on safety instructions, see the Safety, Environmental, and Regulatory Information (SERI).

## FCC Notices (U.S. only) and Other Regulatory Information

For FCC notices and other regulatory information, see the regulatory compliance website located at [www.dell.com/regulatory\\_compliance](http://www.dell.com/regulatory_compliance).

## Contacting Dell

For customers in the United States, call 800-WWW-DELL (800-999-3355).

 **NOTE:** If you do not have an active Internet connection, you can find contact information on your purchase invoice, packing slip, bill, or Dell product catalog.

Dell provides several online and telephone-based support and service options. Availability varies by country and product, and some services may not be available in your area.

**To get online Monitor support content:**

See [www.dell.com/support/monitors](http://www.dell.com/support/monitors).

**To contact Dell for sales, technical support, or customer service issues:**

- 1 Go to [www.dell.com/support](http://www.dell.com/support).
- 2 Verify your country or region in the Choose A Country/Region drop-down menu at the bottom-right corner of the page.
- 3 Click **Contact Us** next to the country dropdown.
- 4 Select the appropriate service or support link based on your need.
- 5 Choose the method of contacting Dell that is convenient for you.



# EU product database for energy label and product information sheet

U2421HE: <https://eprel.ec.europa.eu/qr/344902>

U2721DE: <https://eprel.ec.europa.eu/qr/344911>

## Setting Up Your Monitor

### Setting Display Resolution to 1920 x 1080 (U2421HE)/ 2560 x 1440 (U2721DE) (maximum)

For best performance, set the display resolution to **1920 x 1080 U2421HE)/2560 x 1440(U2721DE)** pixels by performing the following steps:

#### In Windows Vista, Windows 7, Windows 8 or Windows 8.1:

- 1 For Windows 8 or Windows 8.1 only, select the Desktop tile to switch to classic desktop. For Windows Vista and Windows 7, skip this step.
- 2 Right-click on the desktop and click **Screen Resolution**.
- 3 Click the Dropdown list of the Screen Resolution and select **1920 x 1080 (U2421HE)/2560 x 1440 (U2721DE)**.
- 4 Click **OK**.

#### In Windows 10:

- 1 Right-click on the desktop and click **Display Settings**.
- 2 Click **Advanced display settings**.
- 3 Click the dropdown list of **Resolution** and select **1920 x 1080 (U2421HE)/2560 x 1440 (U2721DE)**.
- 4 Click **Apply**.

If you do not see the recommended resolution as an option, you may need to update your graphics driver. Please choose the scenario below that best describes the computer system you are using, and follow the given steps.

### Dell computer

- 1 Go to [www.dell.com/support](http://www.dell.com/support), enter your service tag, and download the latest driver for your graphics card.
- 2 After installing the drivers for your graphics adapter, attempt to set the resolution to **1920 x 1080 (U2421HE)/2560 x 1440 (U2721DE)** again.

 **NOTE:** If you are unable to set the resolution to **1920 x 1080 (U2421HE)/2560 x 1440 (U2721DE)**, please contact Dell to inquire about a graphics adapter that supports these resolutions.





## Non-Dell computer

### In Windows Vista, Windows 7, Windows 8 or Windows 8.1:

- 1 For Windows 8 or Windows 8.1 only, select the Desktop tile to switch to classic desktop. For Windows Vista and Windows 7, skip this step.
- 2 Right-click on the desktop and click **Personalization**.
- 3 Click **Change Display Settings**.
- 4 Click **Advanced Settings**.
- 5 Identify your graphics controller supplier from the description at the top of the window (e.g. NVIDIA, AMD, Intel etc.).
- 6 Refer to the graphic card provider website for updated driver (for example, [www.amd.com](http://www.amd.com) or [www.nvidia.com](http://www.nvidia.com)).
- 7 After installing the drivers for your graphics adapter, attempt to set the resolution to **1920 x 1080 (U2421HE)/2560 x 1440 (U2721DE)** again.

### In Windows 10:

- 1 Right-click on the desktop and click **Display Settings**.
- 2 Click **Advanced display settings**.
- 3 Click **Display adapter properties**.
- 4 Identify your graphics controller supplier from the description at the top of the window (e.g. NVIDIA, AMD, Intel etc.).
- 5 Refer to the graphic card provider website for updated driver (for example, [www.amd.com](http://www.amd.com) or [www.nvidia.com](http://www.nvidia.com)).
- 6 After installing the drivers for your graphics adapter, attempt to set the resolution to **1920 x 1080 (U2421HE)/2560 x 1440 (U2721DE)** again.

 **NOTE:** If you are unable to set the recommended resolution, please contact the manufacturer of your computer or consider purchasing a graphics adapter that supports the video resolution.



# Maintenance Guidelines

## Cleaning Your Monitor



**WARNING:** Before cleaning the monitor, unplug the monitor power cable from the electrical outlet.



**CAUTION:** Read and follow the [Safety Instructions](#) before cleaning the monitor.

For best practices, follow these instructions in the list below while unpacking, cleaning, or handling your monitor:

- To clean your anti-static screen, lightly dampen a soft, clean cloth with water. If possible, use a special screen-cleaning tissue or solution suitable for the anti-static coating. Do not use benzene, thinner, ammonia, abrasive cleaners, or compressed air.
- Use a lightly-dampened, soft cloth to clean the monitor. Avoid using detergent of any kind as some detergents leave a milky film on the monitor.
- If you notice white powder when you unpack your monitor, wipe it off with a cloth.
- Handle your monitor with care as a darker-colored monitor may get scratched and show white scuff marks more than a lighter-colored monitor.
- To help maintain the best image quality on your monitor, use a dynamically changing screen saver and turn off your monitor when not in use.

