



# Dell S2421HS/S2721HS/S2421HSX/ S2721HSX Monitor

## User's Guide

**Monitor Model:** S2421HS/S2721HS/S2421HSX/S2721HSX  
**Regulatory Model:** S2421Ht/S2721Ht



-  **NOTE: A NOTE indicates important information that helps you make better use of your monitor.**
-  **CAUTION: A CAUTION indicates potential damage to hardware or loss of data if instructions are not followed.**
-  **WARNING: A WARNING indicates a potential for property damage, personal injury, or death.**

**Copyright © 2020 Dell Inc. or its subsidiaries. All rights reserved.** Dell, EMC, and other trademarks are trademarks of Dell Inc. or its subsidiaries. Other trademarks may be trademarks of their respective owners.

# Contents

<b>Safety instructions</b> . . . . .	<b>5</b>
<b>About your monitor</b> . . . . .	<b>6</b>
Package contents . . . . .	6
Product features . . . . .	7
<b>Identifying parts and controls</b> . . . . .	<b>8</b>
Front view . . . . .	8
Back view . . . . .	9
Bottom view . . . . .	10
<b>Monitor specifications</b> . . . . .	<b>11</b>
Resolution specifications . . . . .	12
Preset display modes . . . . .	12
Electrical specifications. . . . .	13
Physical characteristics. . . . .	14
Environmental characteristics . . . . .	15
Pin assignments . . . . .	16
Plug-and-play . . . . .	18
LCD monitor quality and pixel policy . . . . .	18
Ergonomics. . . . .	19
Handling and moving your display. . . . .	21
<b>Maintenance guidelines</b> . . . . .	<b>22</b>
Cleaning your monitor. . . . .	22
<b>Setting up the monitor</b> . . . . .	<b>23</b>
Connecting the stand . . . . .	23
Using the tilt, swivel, and vertical extension . . . . .	25



Tilt, Swivel, and Vertical Extension . . . . .	25
Rotating the display . . . . .	26
Configuring the display settings on your computer after rotation . . . . .	26
Connecting your monitor . . . . .	27
Organizing your cables. . . . .	28
Securing your monitor using Kensington lock (optional)	28
Removing the monitor stand . . . . .	29
Wall mounting (optional) . . . . .	30
<b>Operating the monitor . . . . .</b>	<b>31</b>
Power on the monitor . . . . .	31
Using the front panel controls. . . . .	31
Using the OSD lock function . . . . .	33
Front-panel button. . . . .	35
Using the On-Screen Display (OSD) menu . . . . .	36
Accessing the menu system . . . . .	36
OSD warning messages . . . . .	47
Setting the maximum resolution . . . . .	50
<b>Troubleshooting . . . . .</b>	<b>51</b>
Self-test . . . . .	51
Built-in diagnostics . . . . .	52
Common problems . . . . .	53
Product specific problems. . . . .	55
<b>Appendix. . . . .</b>	<b>56</b>
FCC notices (U.S. only) and other regulatory information	56
Contacting Dell. . . . .	56
EU product database for energy label and product information sheet . . . . .	56



# Safety instructions

**△ CAUTION: Use of controls, adjustments, or procedures other than those specified in this documentation may result in exposure to shock, electrical hazards, and/or mechanical hazards.**

- Place the monitor on a solid surface and handle it carefully. The screen is fragile and can be damaged if dropped or hit sharply.
- Always be sure that your monitor is electrically rated to operate with the AC power available in your location.
- Keep the monitor in room temperature. Excessive cold or hot conditions can have an adverse effect on the liquid crystal of the display.
- Do not subject the monitor to severe vibration or high impact conditions. For example, do not place the monitor inside a car trunk.
- Unplug the monitor when it is going to be left unused for an extended period of time.
- To avoid electric shock, do not attempt to remove any cover or touch the inside of the monitor.

For information on safety instructions, see the Safety, Environmental, and Regulatory Information (SERI).









# About your monitor

## Package contents

Your monitor ships with the components shown below. Ensure that you have received all the components and see [Contacting Dell](#) if anything is missing.

**NOTE: Some components may be optional and may not ship with your monitor. Some features may not be available in certain countries.**

	Display
S2421HS/S2721HS      S2421HSX/S2721HSX  	Stand riser
S2421HS/S2721HS      S2421HSX/S2721HSX  	Stand base
	Power cable (varies by country)
	HDMI cable





- Quick Start Guide
- Safety, Environmental, and Regulatory Information

## Product features

The **Dell S2421HS/S2721HS/S2421HSX/S2721HSX** monitor has an active matrix, Thin Film Transistor (TFT), Liquid Crystal Display (LCD), and LED backlight. The monitor features include:

- **S2421HS/S2421HSX:** 60.45 cm (23.80 in.) active area display (measured diagonally). 1920 x 1080 (16:9) resolution, plus full-screen support for lower resolutions.
- **S2721HS/S2721HSX:** 68.6 cm (27 in.) active area display (measured diagonally). 1920 x 1080 (16:9) resolution, plus full-screen support for lower resolutions.
- Tilt, swivel, pivot and vertical extension adjustment capabilities.
- Removable pedestal and Video Electronics Standards Association (VESA™) 100 mm mounting holes for flexible mounting solutions.
- Ultra-thin bezel minimizes the bezel gap in multi-monitor usage, enabling easier set up with an elegant viewing experience.
- Extensive digital connectivity with HDMI and DP helps future-proof your monitor.
- Plug and play capability if supported by your computer.
- On-Screen Display (OSD) adjustments for ease of set-up and screen optimization.
- Supports AMD FreeSync™ technology. AMD Freesync™ certified range from 48 Hz - 75 Hz.
- Power and OSD buttons lock.
- Security lock slot.
- ≤ 0.3 W in Standby Mode.
- Optimize eye comfort with a flicker-free screen.

**⚠ WARNING: The possible long-term effects of blue light emission from the monitor may cause damage to the eyes, including eye fatigue or digital eye strain. ComfortView feature is designed to reduce the amount of blue light emitted from the monitor to optimize eye comfort.**



# Identifying parts and controls

## Front view

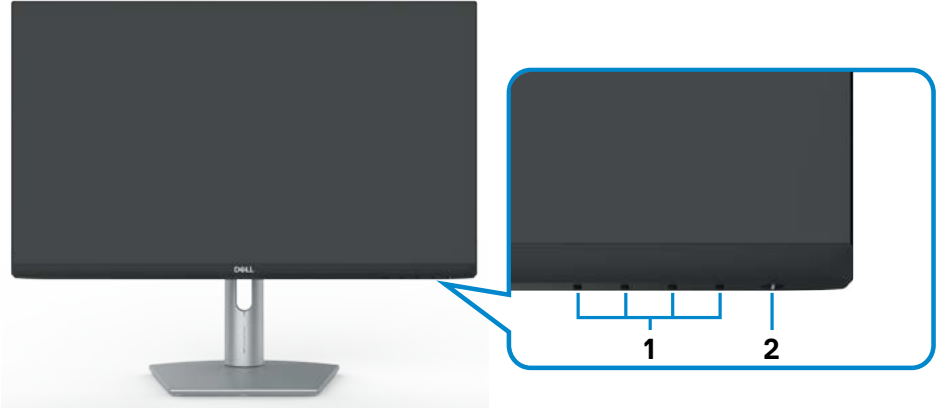

S2421HS/S2721HS

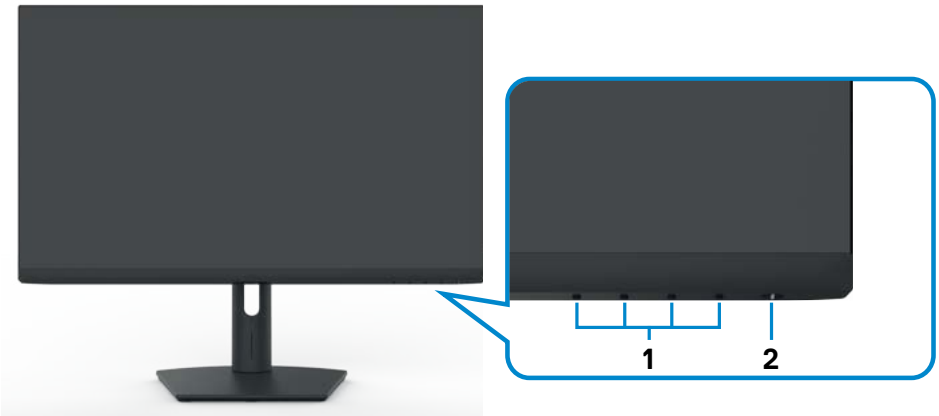

S2421HSX/S2721HSX

Label	Description	Use
1	Function buttons	For more information, see <a href="#">Operating the Monitor</a> .
2	Power on/off button (with LED indicator)	To turn the monitor on or off.





## Back view



**S2421HS/S2721HS**



**S2421HSX/S2721HSX**

Label	Description	Use
<b>1</b>	VESA mounting holes (100 mm x 100 mm-behind attached VESA cover)	Wall mount monitor using VESA-compatible wall mount kit (100 mm x 100 mm).
<b>2</b>	Regulatory label	Lists the regulatory approvals.
<b>3</b>	Stand release button	Releases stand from monitor.
<b>4</b>	Barcode, serial number, and Service Tag label	Refer to this label if you need to contact Dell for technical support. The Service Tag is a unique alphanumeric identifier that enables Dell service technicians to identify the hardware components in your display and access warranty information.
<b>5</b>	Cable management slot	Use to organize cables by placing them through the slot.



## Bottom view

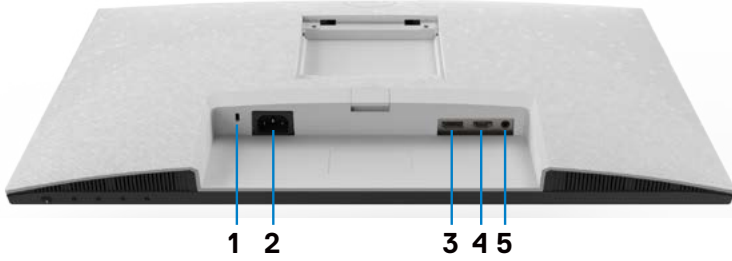

**S2421HS/S2721HS**

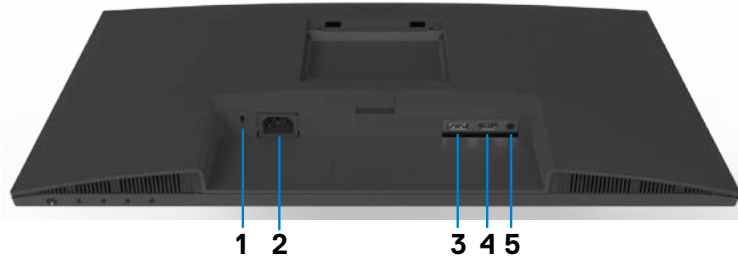

**S2421HSX/S2721HSX**

Label	Description	Use
1	Security lock slot	Secures monitor with security cable lock (sold separately).
2	Power connector	Connect the power cable (shipped with your monitor).
3	DisplayPort	Connect your computer with the DisplayPort cable (optional).
4	HDMI port	Connect your computer with the HDMI cable (shipped with your monitor).
5	Audio line-out port	Connect speakers to playback audio through HDMI or DisplayPort audio channels. Only two-channel audio is supported. <b>NOTE:</b> The audio line-out port does not support headphones.



## Monitor specifications

Model	S2421HS/S2421HSX	S2721HS/S2721HSX
Screen type	Active matrix - TFT LCD	
Panel type	In-plane switching technology	
Aspect ratio	16:9	
Viewable image dimensions:		
Diagonal	60.45 cm (23.8 in.)	68.6 cm (27.0 in.)
Active Area:		
Horizontal	527.04 mm (20.75 in.)	597.89 mm (23.54 in.)
Vertical	296.46 mm (11.67 in.)	336.31 mm (13.24 in.)
Area	156246.28 mm <sup>2</sup> (242.15 in. <sup>2</sup> )	201073.02 mm <sup>2</sup> (311.67 in. <sup>2</sup> )
Pixel pitch	0.2745 mm x 0.2745 mm	0.3114 mm x 0.3114 mm
Pixel per inch (PPI)	92.56	81.59
Viewing angle:		
Horizontal	178° (typical)	
Vertical	178° (typical)	
Brightness	250 cd/m <sup>2</sup> (typical)	300 cd/m <sup>2</sup> (typical)
Contrast ratio	1,000 to 1 (typical)	
Display screen coating	Anti-glare treatment of the front polarizer (3H) hard coating	
Backlight	LED edgelight system	
Response Time (Gray to Gray)	8 ms (normal) 5 ms (fast) 4 ms (extreme)	
Color depth	16.7 million colors	
Color gamut*	NTSC 72%	
Connectivity	<ul style="list-style-type: none"> <li>• 1 x HDMI 1.4</li> <li>• 1 x DisplayPort 1.2</li> <li>• 1 x Audio line-out port (3.5 mm jack)</li> </ul>	
Border width (edge of monitor to active area)		
Top/Left/Right	5.4 mm	6.0 mm
Bottom	20.7 mm	21.3 mm
Adjustability		



Height adjustable stand	100 mm	110mm
Tilt	-5° to 21°	
Swivel	-30° to 30°	
Pivot	-90° to 90°	
Cable management	Yes	
Dell Display Manager (DDM)Compatibility	Easy Arrange and other key features	
Security	Security-lock slot (cable lock sold separately)	

\*At panel native resolution only, under Custom Mode preset.

## Resolution specifications

<b>Model</b>	<b>S2421HS/S2421HSX/S2721HS/S2721HSX</b>	
	<b>DisplayPort</b>	<b>HDMI</b>
Horizontal scan range	83 kHz to 83 kHz	30 kHz to 83 kHz
Vertical scan range	48 Hz to 75 Hz	
Maximum preset resolution	1920 x 1080 at 60 Hz	
Video display capabilities (HDMI and DP alternate mode)	480i, 480p, 576i, 576p, 720p, 1080i, 1080p	

## Preset display modes

Display mode	Horizontal frequency (kHz)	Vertical frequency (Hz)	Pixel clock (MHz)	Sync polarity (Horizontal/Vertical)
VGA, 720 x 400	31.5	70.0	28.3	-/+
VGA, 640 x 480	31.5	60.0	25.2	-/-
VESA, 640 x 480	37.5	75.0	31.5	-/-
VESA, 800 x 600	37.9	60.0	40.0	+/+
VESA, 800 x 600	46.9	75.0	49.5	+/+
VESA, 1024 x 768	48.4	60.0	65.0	-/-
VESA, 1024 x 768	60.0	75.0	78.8	+/+
MAC, 1152 x 864	67.5	75.0	108.0	+/+
VESA, 1280 x 1024	64.0	60.0	108.0	+/+
VESA, 1280 x 1024	80.0	75.0	135.0	+/+



VESA, 1600 x 900	60.0	60.0	108.0	+/+
CVT, 1920 x 1080	67.5	60.0	148.5	+/+
CVT, 1920 x 1080	83.89	75.0	174.5	+/-

## Electrical specifications

Model	S2421HS/S2421HSX/S2721HS/S2721HSX
Video input signals	<ul style="list-style-type: none"> <li>• Digital video signal for each differential line Per differential line at 100 ohm impedance</li> <li>• DP/HDMI signal input support</li> </ul>
Input voltage/frequency/current	100-240 VAC/50 or 60 Hz $\pm$ 3 Hz/1.5 A (maximum)
Inrush current	120 V: 30 A (maximum) 240 V: 60 A (maximum)
Power consumption	
S2421HS/S2421HSX	S2721HS/S2721HSX
0.2 W (Off Mode) <sup>1</sup>	0.2 W (Off Mode) <sup>1</sup>
0.2 W (Standby Mode) <sup>1</sup>	0.2 W (Standby Mode) <sup>1</sup>
11.6 W (On Mode) <sup>1</sup>	15.7 W (On Mode) <sup>1</sup>
23 W (Max) <sup>2</sup>	31 W (Max) <sup>2</sup>
11.04 W (P <sub>on</sub> ) <sup>3</sup>	12.59 W (P <sub>on</sub> ) <sup>3</sup>
35.04 kWh (TEC) <sup>3</sup>	40.14 kWh (TEC) <sup>3</sup>

<sup>1</sup> As defined in EU 2019/2021 and EU 2019/2013.

<sup>2</sup> Max brightness and contrast setting.

<sup>3</sup> P<sub>on</sub>: Power consumption of On Mode as defined in Energy Star 8.0 version.

TEC: Total energy consumption in kWh as defined in Energy Star 8.0 version.

This document is informational only and reflects laboratory performance. Your product may perform differently, depending on the software, components and peripherals you ordered and shall have no obligation to update such information. Accordingly, the customer should not rely upon this information in making decisions about electrical tolerances or otherwise. No warranty as to accuracy or completeness is expressed or implied.

 **NOTE: This monitor is ENERGY STAR certified.**



This product qualifies for ENERGY STAR in the factory default settings, which can be restored by “Factory Reset” function in the OSD menu. Changing the factory default settings or enabling other features may increase power consumption that could exceed the ENERGY STAR specified limit.

### Physical characteristics

Model	S2421HS/S2421HSX	S2721HS/S2721HSX
Connector type	<ul style="list-style-type: none"> <li>· 1 x HDMI1.4 port</li> <li>· 1 x DisplayPort 1.2</li> <li>· 1 x Audio line-out port</li> </ul>	
Signal cable type	1.8 m HDMI1.4 cable	
Dimensions (with stand):		
Height (extended)	446.8 mm (17.59 in.)	509.0 mm (20.04 in.)
Height (compressed)	346.8 mm (13.65 in.)	399.0 mm (15.71 in.)
Width	537.8 mm (21.17 in.)	609.9 mm (24.01 in.)
Depth	159.7 mm (6.29 in.)	174.7 mm (6.88 in.)
Dimensions (without stand):		
Height	322.6 mm (12.70 in.)	363.6 mm (14.32 in.)
Width	537.8 mm (21.17 in.)	609.9 mm (24.01 in.)
Depth	53.8 mm (2.12 in.)	54.0 mm (2.13 in.)
Stand dimensions:		
Height (extended)	361.5 mm (14.23 in.)	403.1 mm (15.87 in.)
Height (compressed)	325.4 mm (12.81 in.)	364.8 mm (14.36 in.)
Width	237.0 mm (9.33 in.)	257.0 mm (10.12 in.)
Depth	159.7 mm (6.29 in.)	174.7 mm (6.88 in.)
Weight:		
Weight with packaging	7.0 kg (15.43 lb)	8.9 kg (19.62 lb)
Weight with stand assembly and cables	4.8 kg (10.58 lb)	6.0 kg (13.23 lb)
Weight without stand assembly (For wall mount or VESA mount considerations - no cables)	3.2 kg (7.05 lb)	4.3 kg (9.48 lb)



Weight of stand assembly	1.3 kg (2.87 lb)	1.5 kg (3.31 lb)
--------------------------	------------------	------------------

## Environmental characteristics

Compliant standards	
<ul style="list-style-type: none"> <li>• ENERGY STAR certified Monitor</li> <li>• TCO Certified Display</li> <li>• RoHS Compliant</li> <li>• BFR/PVC Reduce monitor (excluding external cables)</li> <li>• Arsenic-Free glass and Mercury-Free for the panel only</li> </ul>	
Temperature:	
Operating	0°C to 40°C (32°F to 104°F)
Non-operating	-20 °C to 60 °C (-4 °F to 140 °F)
Humidity:	
Operating	10% to 80% (non-condensing)
Non-operating	5% to 90% (non-condensing)
Altitude:	
Operating (maximum)	5,000 m (16,404 ft)
Non-operating (maximum)	12,192 m (40,000 ft)
Thermal dissipation	
<b>S2421HS/S2421HSX</b>	78.48 BTU/hour (maximum) 39.58 BTU/hour (On Mode)
<b>S2721HS/S2721HSX</b>	105.78 BTU/hour (maximum) 53.57 BTU/hour (On Mode)



## Pin assignments

### DisplayPort

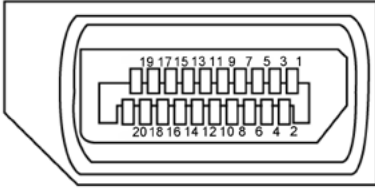

Pin number	20-pin side of the connected signal cable	Pin number	20-pin side of the connected signal cable
1	ML3 (n)	11	GND
2	GND	12	ML0 (p)
3	ML3 (p)	13	CONFIG1
4	ML2 (n)	14	CONFIG2
5	GND	15	AUX CH (p)
6	ML2 (p)	16	GND
7	ML1 (n)	17	AUX CH (n)
8	GND	18	Hot Plug Detect
9	ML1 (p)	19	Return
10	ML0 (n)	20	DP_PWR





## HDMI port

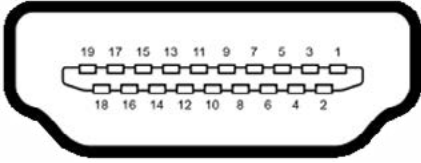

Pin number	19-pin side of the connected signal cable
1	TMDS DATA 2+
2	TMDS DATA 2 SHIELD
3	TMDS DATA 2-
4	TMDS DATA 1+
5	TMDS DATA 1 SHIELD
6	TMDS DATA 1-
7	TMDS DATA 0+
8	TMDS DATA 0 SHIELD
9	TMDS DATA 0-
10	TMDS CLOCK+
11	TMDS CLOCK SHIELD
12	TMDS CLOCK-
13	CEC
14	Reserved (N.C. on device)
15	DDC CLOCK (SCL)
16	DDC DATA (SDA)
17	DDC/CEC Ground
18	+5 V POWER
19	HOT PLUG DETECT



## Plug-and-play

You can install the monitor in any Plug-and-Play-compatible system. The monitor automatically provides the computer with its extended display identification data (EDID) using display data channel (DDC) protocols so that the computer can configure itself and optimize the monitor settings. Most monitor installations are automatic; you can select different settings if desired. For more information about changing the monitor settings, see [Operating the monitor](#).

## LCD monitor quality and pixel policy

During the LCD monitor manufacturing process, it is not uncommon for one or more pixels to become fixed in an unchanging state, which are hard to see and do not affect the display quality or usability. For more information about LCD Monitor Pixel Policy, see Dell support site at: <https://www.dell.com/pixelguidelines>.



## Ergonomics

**△ CAUTION: Improper or prolonged usage of keyboard may result in injury.**

**△ CAUTION: Viewing the monitor screen for extended periods of time may result in eye strain.**

For comfort and efficiency, observe the following guidelines when setting up and using your computer workstation:

- Position your computer so that the monitor and keyboard are directly in front of you as you work. Special shelves are commercially available to help you correctly position your keyboard.
- To reduce the risk of eye strain and neck/arm/back/shoulder pain from using the monitor for long periods of time, we suggest you to:
  1. Set the distance of the screen between 20 to 28 in. (50 - 70 cm) from your eyes.
  2. Blink frequently to moisten your eyes or wet your eyes with water after prolonged usage of the monitor.
  3. Take regular and frequent breaks for 20 minutes every two hours.
  4. Look away from your monitor and gaze at a distant object at 20 feet away for at least 20 seconds during the breaks.
  5. Perform stretches to relieve tension in the neck, arm, back, and shoulders during the breaks.
- Ensure that the monitor screen is at eye level or slightly lower when you are sitting in front of the monitor.
- Adjust the tilt of the monitor, its contrast, and brightness settings.
- Adjust the ambient lighting around you (such as overhead lights, desk lamps, and the curtains or blinds on nearby windows) to minimize reflections and glare on the monitor screen.
- Use a chair that provides good lower-back support.
- Keep your forearms horizontal with your wrists in a neutral, comfortable position while using the keyboard or mouse.
- Always leave space to rest your hands while using the keyboard or mouse.
- Let your upper arms rest naturally on both sides.
- Ensure that your feet are resting flat on the floor.
- When sitting, ensure that the weight of your legs is on your feet and not on the front portion of your seat. Adjust your chair's height or use a footrest if necessary to maintain a proper posture.



- Vary your work activities. Try to organize your work so that you do not have to sit and work for extended periods of time. Try to stand or get up and walk around at regular intervals.
- Keep the area under your desk clear of obstructions and cables or power cords that may interfere with comfortable seating or present a potential trip hazard.

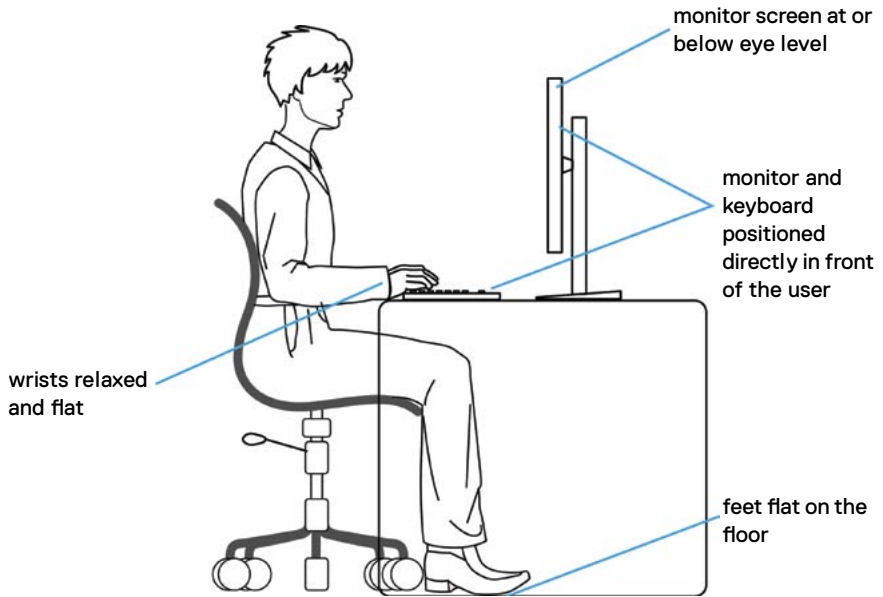

## Handling and moving your display

To ensure that the monitor is handled safely when lifting or moving it, follow the guidelines mentioned below:

- Before moving or lifting the monitor, turn off your computer and the monitor.
- Disconnect all cables from the monitor.
- Place the monitor in the original box with the original packing materials.
- Hold the bottom edge and the side of the monitor firmly without applying excessive pressure when lifting or moving the monitor.

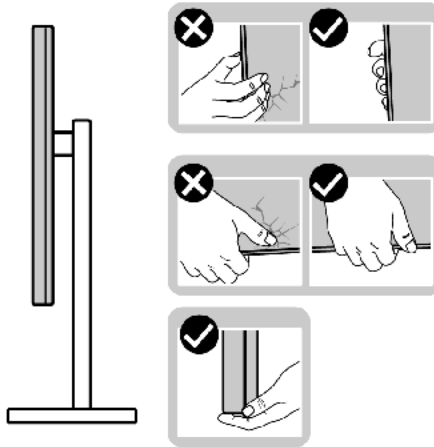

- When lifting or moving the monitor, ensure that the screen is facing away from you and do not press on the display area to avoid any scratches or damage.

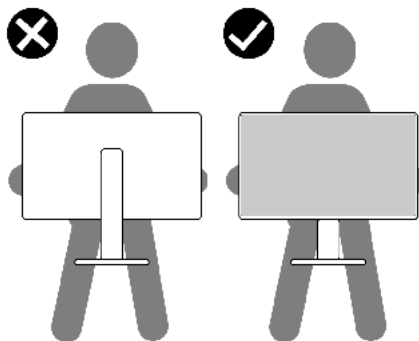

- When transporting the monitor, avoid any sudden shock or vibration to it.



- When lifting or moving the monitor, do not turn the monitor upside down while holding the stand base or stand riser. This may result in accidental damage to the monitor or cause personal injury.

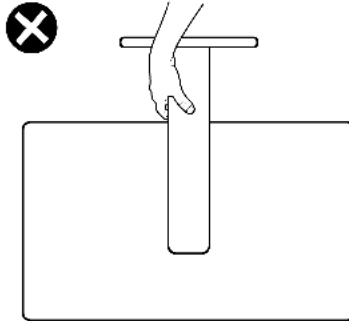

## Maintenance guidelines

### Cleaning your monitor

**△ CAUTION:** Read and follow the [Safety instructions](#) before cleaning the monitor.

**⚠ WARNING:** Before cleaning the monitor, unplug the monitor power cable from the electrical outlet.

For best practices, follow the instructions in the list below when unpacking, cleaning, or handling your monitor:

- To clean your anti-static screen, lightly dampen a soft, clean cloth with water. If possible, use a special screen-cleaning tissue or solution suitable for the anti-static coating. Do not use benzene, thinner, ammonia, abrasive cleaners, or compressed air.
- Use a lightly-dampened, warm cloth to clean the monitor. Avoid using detergent of any kind as some detergents leave a milky film on the monitor.
- If you notice white powder when you unpack your monitor, wipe it off with a cloth.
- Handle your monitor with care as a darker-colored monitor may get scratched and show white scuff marks more than a lighter-colored monitor.
- To help maintain the best image quality on your monitor, use a dynamically changing screen saver and turn off your monitor when not in use.



# Setting up the monitor

## Connecting the stand

- NOTE: The stand riser and stand base are detached when the monitor is shipped from the factory.
- NOTE: The following instructions are applicable only for the stand that was shipped with your monitor. If you are connecting a stand that you purchased from any other source, follow the set up instructions that were included with the stand.

CAUTION: Place monitor on a flat, clean, and soft surface to avoid scratching the display panel.

To attach the monitor stand:

1. Align the tabs on the stand base with the slots on the stand riser.
2. Insert the stand riser on the stand base firmly.
3. Open the screw handle at the bottom of the stand base, and rotate it clockwise to tighten the screw firmly. Then close the screw handle.

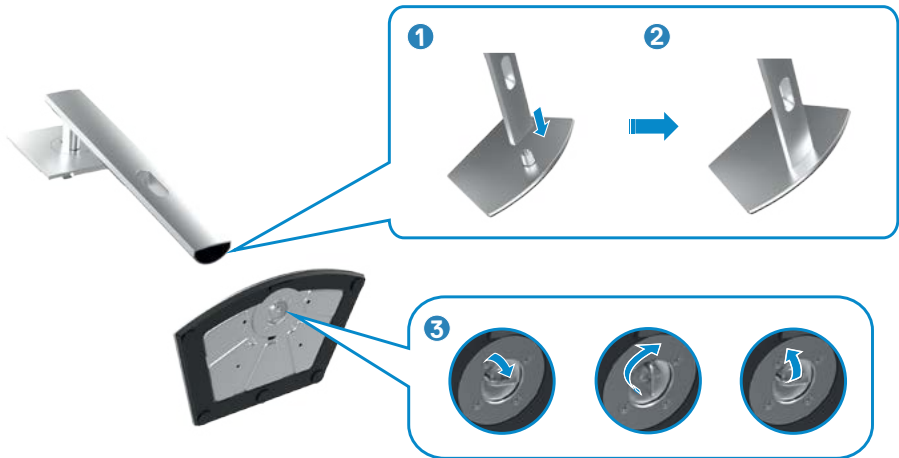

- Slide the tabs on the stand riser into the slots on the display back cover and press down the stand assembly to snap it into place.

**⚠ CAUTION: Hold the stand riser firmly when lifting the monitor to avoid any accidental damage.**

- Hold the stand riser and lift the monitor carefully, then place it on a flat surface.

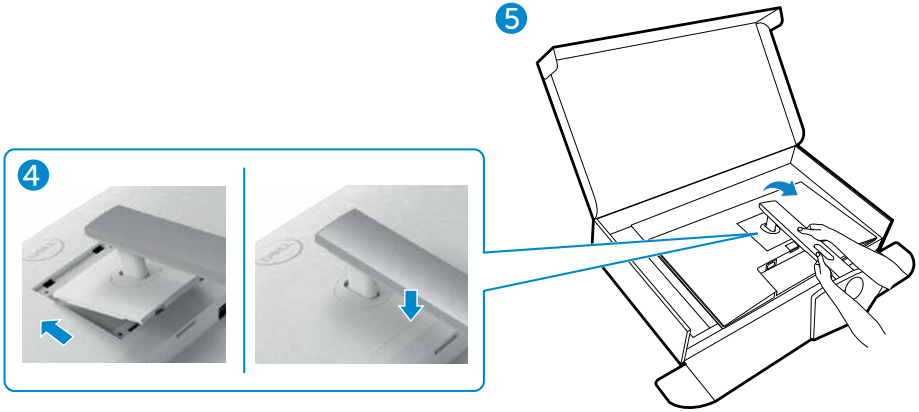



## Using the tilt, swivel, and vertical extension

**Note:** The following instructions are applicable only for the stand that was shipped with your monitor. If you are connecting a stand that you purchased from any other source, follow the setup instructions that were included with the stand.

### Tilt, Swivel, and Vertical Extension

With the stand attached to the monitor, you can tilt the monitor for the most comfortable viewing angle.

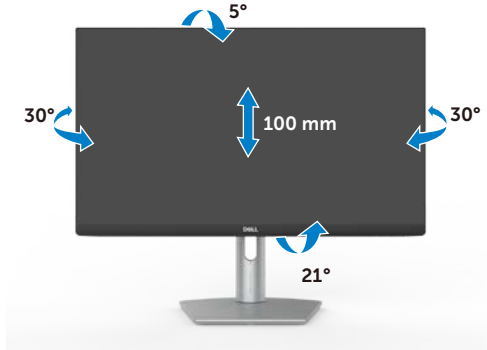

**S2421HS/S2421HSX**

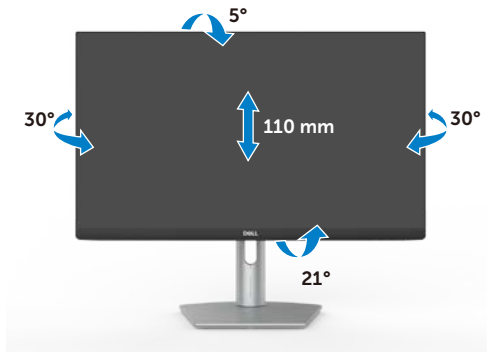

**S2721HS/S2721HSX**

**Note:** The stand is detached when the monitor is shipped from the factory.



## Rotating the display

Before you rotate the display, extend the display vertically until the top of the stand riser, and then tilt the display backwards until the maximum to avoid hitting the bottom edge of the display.



**NOTE:** To toggle the display setting on your Dell computer between landscape and portrait when rotating the display, download and install the latest graphics driver. To download, go to <https://www.dell.com/support/drivers> and search for the appropriate driver.

**NOTE:** When the display is in portrait mode, you may experience performance degradation when using graphic-intensive applications such as 3D gaming.

## Configuring the display settings on your computer after rotation

After you have rotated the display, complete the procedure given below to configure the display settings on your computer.

**NOTE:** If you are using the monitor with a non-Dell computer, go to the graphics card manufacturer's website or your computer manufacturer website for information on how to rotate the contents of your display.

### To configure the display settings

1. Right-click on the **Desktop** and click **Properties**.
2. Select the **Settings** tab and click **Advanced**.
3. If you have an AMD graphics card, select the **Rotation** tab and set the preferred rotation.
4. If you have an **nVidia** graphics card, click the **nVidia** tab, in the left-hand column select **NVRotate**, and then select the preferred rotation.
5. If you have an Intel® graphics card, select the Intel graphics tab, click **Graphic Properties**, select the **Rotation** tab, and then set the preferred rotation.



**NOTE:** If you do not see the rotation option or it is not working correctly, go to <https://www.dell.com/support> and download the latest driver for your graphics card.

## Connecting your monitor

**WARNING:** Before you begin any of the procedures in this section, follow the [Safety instructions](#).

To connect your monitor to the computer:

1. Turn off your computer.
2. Connect the DisplayPort or HDMI cable from your monitor to the computer.
3. Turn on your monitor.
4. Select the correct input source from the OSD Menu on your monitor and then turn on your computer.

### Connecting the HDMI cable



### Connecting the DP cable (optional)

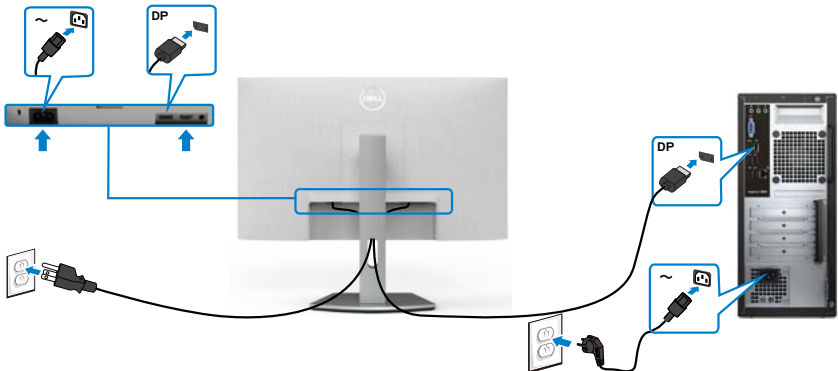

## Organizing your cables



After connecting all necessary cables to your monitor and computer, (see [Connecting your monitor](#) for cable attachment) organize all cables as shown above.

## Securing your monitor using Kensington lock (optional)

The security lock slot is located at the bottom of the monitor. (See [Security lock slot](#)) For more information about using the Kensington lock (purchased separately), see the documentation that is shipped with the lock.

Secure your monitor to a table using the Kensington security lock.

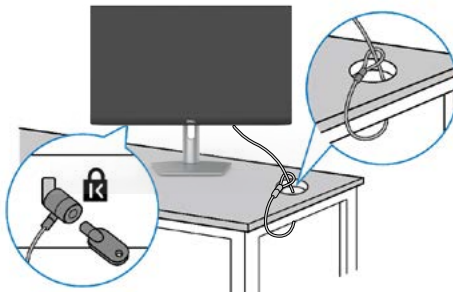

**NOTE:** The image is for the purpose of illustration only. Appearance of the lock may vary.



## Removing the monitor stand

**△ CAUTION:** To prevent scratches on the LCD screen while removing the stand, ensure that the monitor is placed on a soft, clean surface.

**✎ NOTE:** The following instructions are applicable only for the stand that was shipped with your monitor. If you are connecting a stand that you purchased from any other source, follow the setup instructions that were included with the stand.

### To remove the stand:

1. Place a flat cushion or a sitting mat near the edge of a table and place the monitor on it with the display facing down.
2. Press and hold the stand-release button.
3. Lift the stand up and away from the monitor.

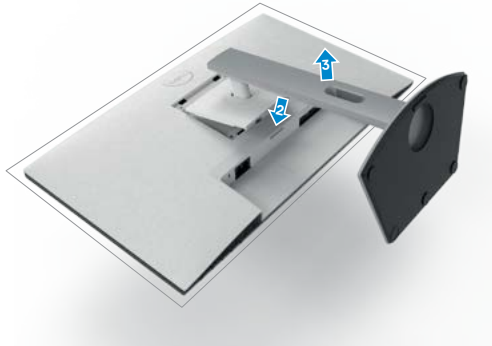

## Wall mounting (optional)

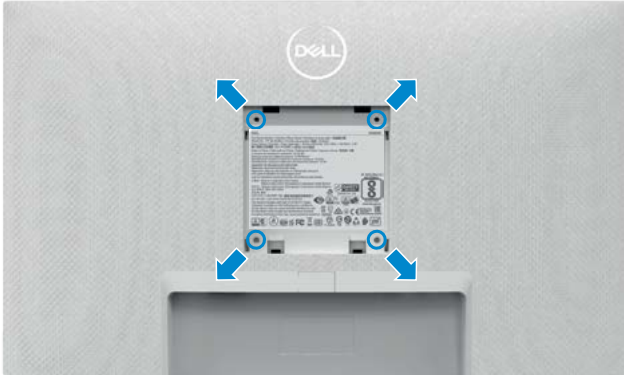

**NOTE:** Use M4 x 10 mm screws to secure the wall-mounting kit to the monitor.

See the documentation that is shipped with the VESA-compatible wall mounting kit.

1. Place a flat cushion or a sitting mat near the edge of a table and place the monitor on it with the display facing down.
2. Remove the stand.
3. Using a Phillips crosshead screwdriver, remove the four screws that secure the back panel.
4. Connect the mounting bracket from the wall mounting kit to the monitor.
5. Follow the instructions that shipped with the wall-mounting kit and mount the monitor on the wall.

**NOTE:** For use only with UL or CSA or GS-listed wall mount bracket with minimum weight/load bearing capacity of 12.8 kg (S2421HS/S2421HSX)/17.2 kg (S2721HS/S2721HSX).



# Operating the monitor

## Power on the monitor

Press the  button to turn on the monitor.





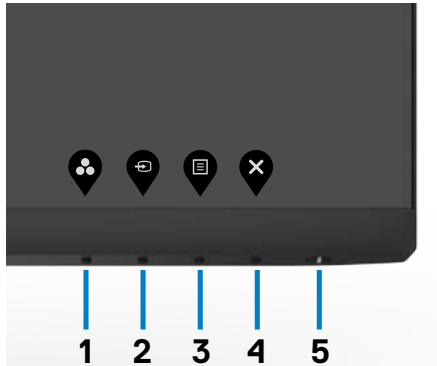

## Using the front panel controls

Use the control buttons at the bottom edge of the monitor to adjust the specifications of the image being displayed. When using the control buttons, an On-Screen Display (OSD) menu appears on the screen with numeric values.



The following table describes the front panel buttons:

Front-panel button	Description
1  <b>Shortcut key: Preset Modes</b>	Use this button to choose from a list of preset color modes.
2  <b>Shortcut key: Input source</b>	Use this button to choose from a list of input sources.
3  <b>Menu</b>	Use this menu button to launch the on-screen display (OSD) and select the OSD menu. See <a href="#">Accessing the menu system</a> .
4  <b>Exit</b>	Use this button to go back to the main menu or exit the OSD main menu.
5  <b>Power Button (with power-status light)</b>	To turn the monitor on or off. Solid white light indicates the monitor is turned on and functioning normally. Blinking white light indicates the monitor is in Standby Mode.





## Using the OSD lock function

You can lock the front-panel control buttons to prevent access to the OSD menu and/or power button.

### Use the Lock menu to lock the button(s).

1. Select one of the following options.

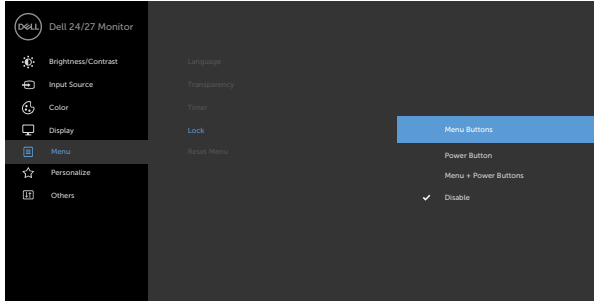

2. The following message appears.

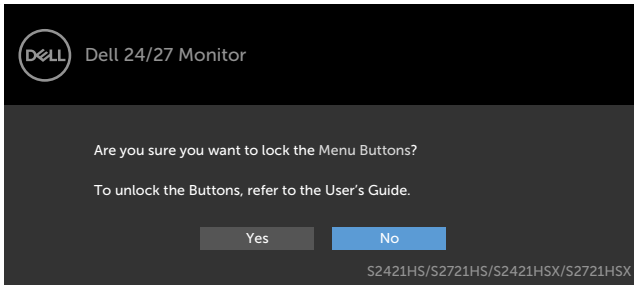

3. Select **Yes** to lock the buttons. Once locked, pressing any control button will display the lock icon 



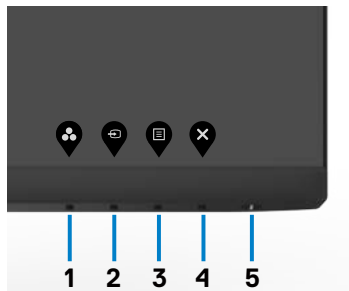

### Use the front-panel control button to lock the button(s).

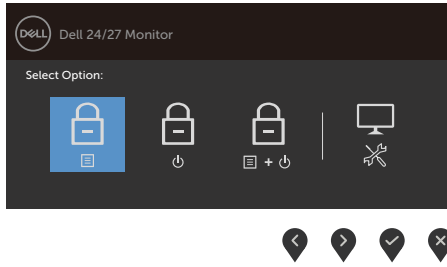

1. Press and hold **Button 4** for four seconds, a menu appears on the screen.







2. Select one of the following options:

Options	Description
<p>1</p>  <p><b>Menu Buttons lock</b></p>	Select this option to lock OSD menu function.
<p>2</p>  <p><b>Power Button lock</b></p>	Use this option to lock power button. This will prevent the user to turn off the monitor using the power button.
<p>3</p>  <p><b>Menu and Power Buttons lock</b></p>	Use this option to lock OSD menu and power button to turn off the monitor.
<p>4</p>  <p><b>Built-in Diagnostics</b></p>	Use this option to run the built-in diagnostics, see <a href="#">Built-in diagnostics</a> .

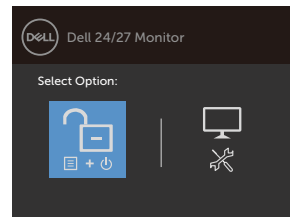
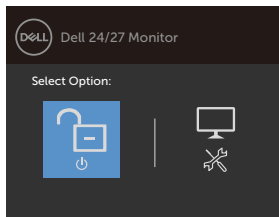
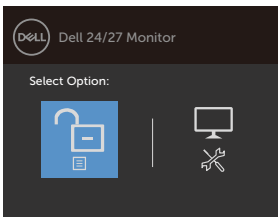
**To unlock the button(s):**

Press and hold **Button 4** for four seconds until a menu appears on the screen. The following table describes the options to unlock the front-panel control buttons.





Options	Description
1  <b>Menu Buttons unlock</b>	Use this option to unlock OSD menu function.
2  <b>Power Button unlock</b>	Use this option to unlock power button to turn off the monitor.
3  <b>Menu and Power Buttons unlock</b>	Use this option to unlock OSD menu and power button to turn off the monitor.
4  <b>Built-in Diagnostics</b>	Use this option to run the built-in diagnostics, see <a href="#">Built-in diagnostics</a> .

## Front-panel button

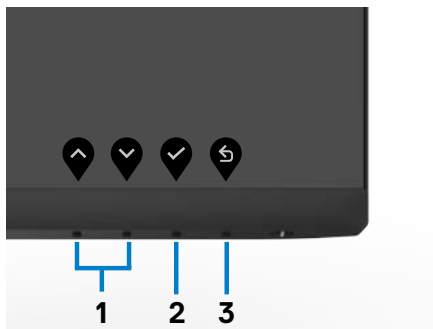
Use the buttons on the front of the monitor to adjust the image settings.



Front-panel button	Description
1  <b>Up</b>  <b>Down</b>	Use the <b>Up</b> (increase) and <b>Down</b> (decrease) buttons to adjust items in the OSD menu.
2  <b>OK</b>	Use the <b>OK</b> button to confirm your selection.





Back

Use the **Back** button to go back to the previous menu.













## Using the On-Screen Display (OSD) menu

### Accessing the menu system

**NOTE:** The changes you make using the OSD menu are automatically saved when you move to another OSD menu, when you exit the OSD menu, or when the OSD menu disappears automatically.

1. Press the  button to launch the OSD menu and display the main menu.







2. Press the  and  buttons to move between options. As you move from one icon to another, the option name is highlighted.
3. Press the  or  or  button once to activate the highlighted option.
4. Press the  and  buttons to select the desired parameter.
5. Press  to enter the slide bar and then use the  or  button, according to the indicators on the menu, to make your changes.
6. Select the  to return to previous menu or  to accept and return to previous menu.

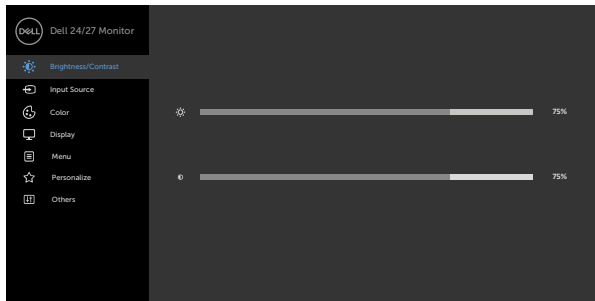

Icon	Menu and submenus	Description
	<b>Brightness/Contrast</b>	Use this menu to activate <b>Brightness/Contrast</b> adjustment.



**Brightness** **Brightness** adjusts the luminance of the backlight (minimum 0; maximum 100).  
 Press the  button to increase brightness.  
 Press the  button to decrease brightness.

**Contrast** Adjust the **Brightness** first, and then adjust **Contrast** only if further adjustment is necessary.  
 Press the  button to increase contrast and press the  button to decrease contrast (between 0 and 100).  
 Contrast adjusts the difference between darkness and lightness on the monitor.



---

Icon	Menu and submenus	Description
------	-------------------	-------------

---



### Input Source

Use the **Input Source** menu to select between different video inputs that are connected to your monitor.

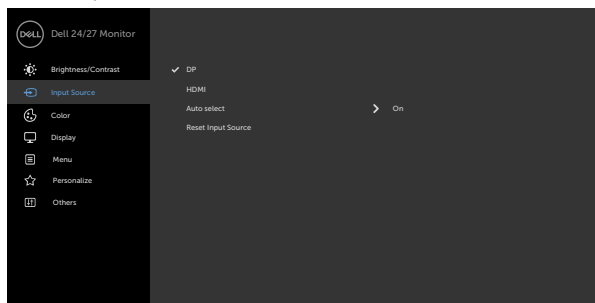

---

### DP

Use  to select the **DP** input source.

---

### HDMI

Use  to select the **HDMI** input source.

---

### Auto Select

Use  to select **Auto Select** to scan for available input signals.

---

### Reset Input Source

Resets your monitor's **Input Source** settings to the factory defaults.



### Color

Use the **Color** menu to adjust the color setting mode.

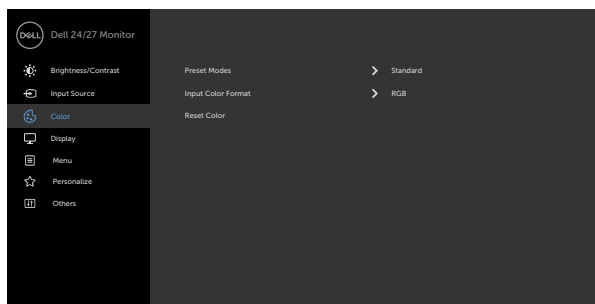

Icon	Menu and submenus	Description
------	-------------------	-------------

**Preset Modes**

When you select **Preset Modes**, you can choose **Standard**, **ComfortView**, **Movie**, **FPS**, **RTS**, **RPG**, **Warm**, **Cool**, or **Custom Color** from the list.

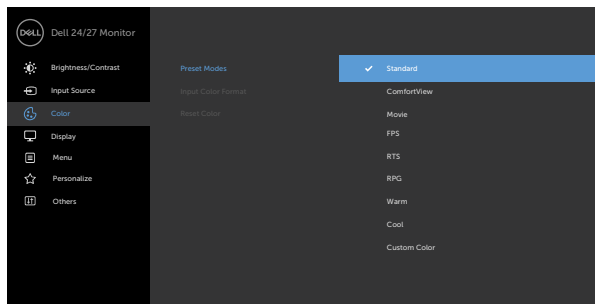



- ◆ **Standard:** Default color settings. This is the default preset mode.
- ◆ **ComfortView:** Decreases the level of blue light emitted from the screen to make viewing more comfortable for your eyes.

**WARNING: The possible long-term effects of blue light emission from the monitor may cause personal injury such as digital eye strain, eye fatigue, and damage to the eyes. Using monitor for extended periods of time may also cause pain in parts of body such as neck, arm, back, and shoulder. For more information, see [Ergonomics](#).**



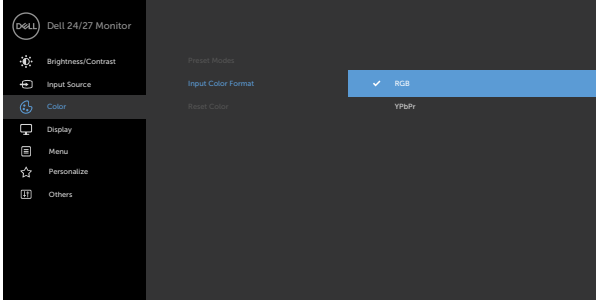

- ◆ **Movie:** Loads color settings ideal for movies.
- ◆ **FPS:** Loads color settings ideal for First-Person Shooter games.
- ◆ **RTS:** Loads color settings ideal for Real-Time Strategy games.
- ◆ **RPG:** Loads color settings ideal for Role-Playing games.
- ◆ **Warm:** Increases the color temperature. The screen appears warmer with a red/yellow tint.
- ◆ **Cool:** Decreases the color temperature. The screen appears cooler with a blue tint.





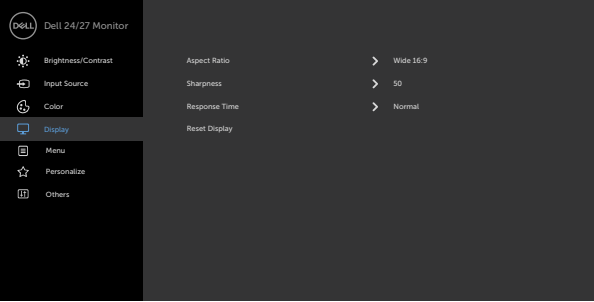

Icon	Menu and submenus	Description
		<ul style="list-style-type: none"> <li>◆ <b>Custom Color:</b> Allows you to manually adjust the color settings. Press the ◀ and ▶ buttons to adjust the Red, Green, and Blue values and create your own preset color mode.</li> </ul>
	<b>Input Color Format</b>	<p>Allows you to set the video input mode to:</p> <ul style="list-style-type: none"> <li>◆ <b>RGB:</b> Select this option if your monitor is connected to a computer (or DVD player) using the HDMI, DP cable.</li> <li>◆ <b>YPbPr:</b> Select this option if your DVD player supports only YPbPr output.</li> </ul>
		
		
	<b>Hue</b>	<p>Use ▲ or ▼ to adjust the hue from 0 to 100.</p> <p><b>NOTE:</b> Hue adjustment is available only for Movie and FPS, RTS, RPG mode.</p>
	<b>Saturation</b>	<p>Use ▲ or ▼ to adjust the saturation from 0 to 100.</p> <p><b>NOTE:</b> Saturation adjustment is available only for Movie and FPS, RTS, RPG mode.</p>
	<b>Reset Color</b>	<p>Resets your monitor's color settings to the factory defaults.</p>





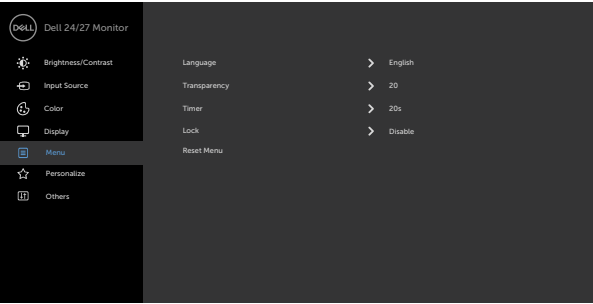

Icon	Menu and submenus	Description
	<b>Display</b>	Use the <b>Display</b> menu to adjust image.
		
		
<b>Aspect Ratio</b>	Select the image ratio between <b>16:9(Wide)</b> , <b>4:3</b> , and <b>5:4</b> .	
<b>Sharpness</b>	Makes the image look sharper or softer. Use  or  to adjust the sharpness from '0' to '100'.	
<b>Response Time</b>	Allows you to set the <b>Response Time</b> to <b>Normal</b> , <b>Fast</b> or <b>Extreme</b> .	
<b>Reset Display</b>	Restores the display settings to factory defaults.	



Icon	Menu and submenus	Description
	<b>Menu</b>	<p>Select this option to adjust the settings of the OSD, such as the languages of the OSD, the amount of time the menu remains on screen, and so on.</p> 
	<b>Language</b>	<p>Set the OSD display to one of eight languages. (English, Spanish, French, German, Brazilian Portuguese, Russian, Simplified Chinese, or Japanese).</p>
	<b>Transparency</b>	<p>Select this option to change the menu transparency by using  and  (min. 0/max. 100).</p>
	<b>Timer</b>	<p><b>OSD Hold Time:</b> Sets the length of time the OSD remains active after you press a button.</p> <p>Use the  and  buttons to adjust the slider in 1-second increments, from 5 to 60 seconds.</p>

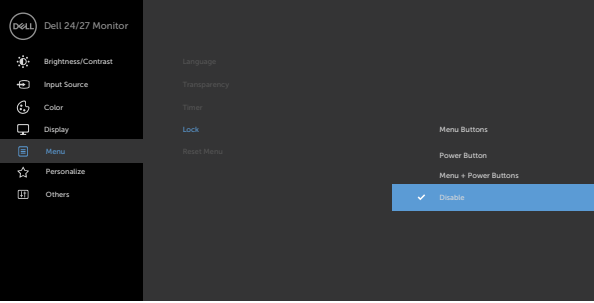

Icon	Menu and submenus	Description
	<b>Lock</b>	Controls user access to adjustments. The buttons are locked.
		
		
<ul style="list-style-type: none"> <li>◆ <b>Menu Buttons:</b> Through OSD to lock the Menu buttons.</li> <li>◆ <b>Power Button:</b> Through OSD to lock the Power button.</li> <li>◆ <b>Menu + Power Buttons:</b> Through OSD to lock the all of Menu and Power buttons.</li> <li>◆ <b>Disable:</b> Press and hold the  button next to the power button for four seconds to unlock the buttons.</li> </ul>		
<b>Reset Menu</b>	Restore the menu settings to factory defaults.	



Icon	Menu and submenus	Description
------	-------------------	-------------



**Personalize**

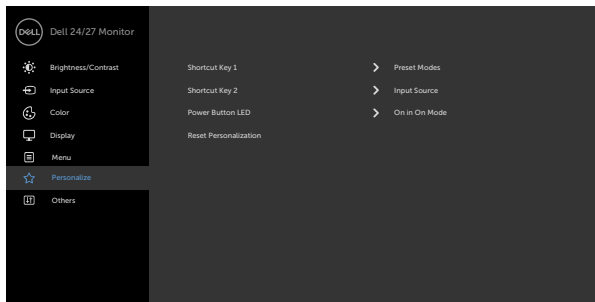

**Shortcut key 1**

Select from **Preset Modes, Brightness/Contrast, Input Source, Aspect Ratio** set as shortcut key 1.

**Shortcut key 2**

Select from **Preset Modes, Brightness/Contrast, Input Source, Aspect Ratio** set as shortcut key 2.

**Power Button LED**

Allows you to set the state of the power light to save energy.

**Reset Personalization**

Restores shortcut keys to factory defaults.



Icon	Menu and submenus	Description
------	-------------------	-------------



**Others**

Select this option to adjust the OSD settings, such as the **DDC/CI, LCD conditioning**, and so on.

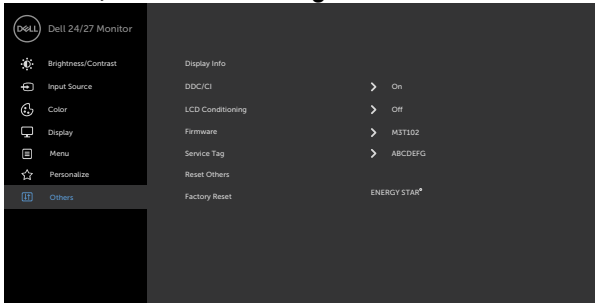

<b>Display Info</b>	Displays the monitor's current settings.
---------------------	--

**DDC/CI** **DDC/CI** (Display Data Channel/Command Interface) allows you to adjust the monitor settings using software on your computer.

Select **Off** to turn off this feature.

Enable this feature for best user experience and optimum performance of your monitor.

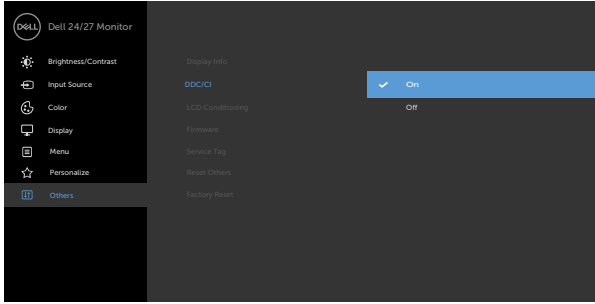

Icon	Menu and submenus	Description
------	-------------------	-------------

**LCD Conditioning**

Helps reduce minor cases of image retention. Depending on the degree of image retention, the program may take some time to run. Select **On** to start the process.

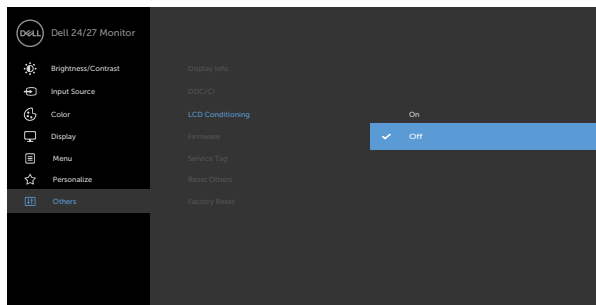

**Firmware**

Displays the firmware version of your monitor.

**Service Tag**

Displays the Service Tag. The Service Tag is a unique alphanumeric identifier that allows Dell to identify the product specifications and access warranty information.

**NOTE:** The Service Tag is also printed on a label located at the back of the cover.

**Reset Others**

Restores other settings, such as **DDC/CI**, to factory defaults.

**Factory Reset**

Restores all preset values to the factory default settings. These are also the setting for ENERGY STAR® tests.

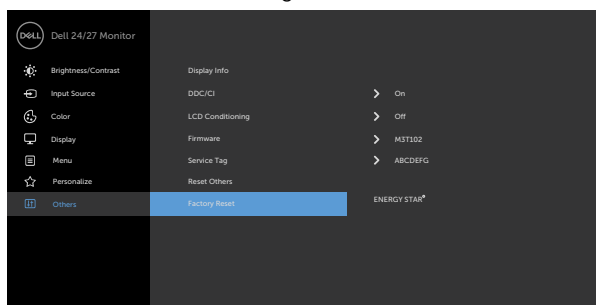

## OSD warning messages

When the monitor does not support a particular resolution mode, you can see the following message:

### S2421HS/S2421HSX

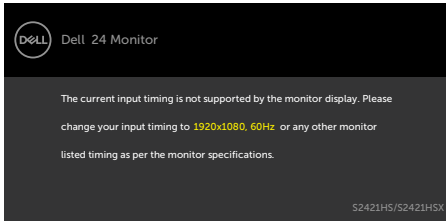

### S2721HS/S2721HSX

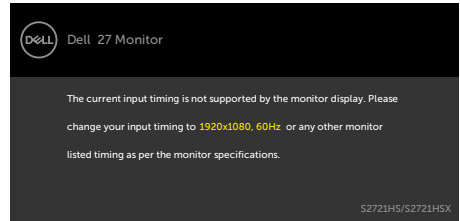

This means that the monitor cannot synchronize with the signal that it is receiving from the computer. See [Resolution specifications](#) for the Horizontal and Vertical frequency ranges addressable by this monitor. Recommended mode is 1920 x 1080. You can see the following message before the DDC/CI function is disabled.

### S2421HS/S2421HSX

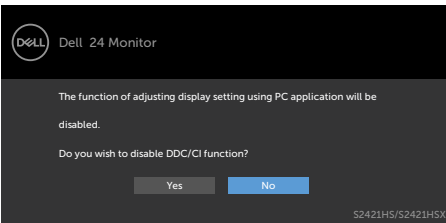

### S2721HS/S2721HSX

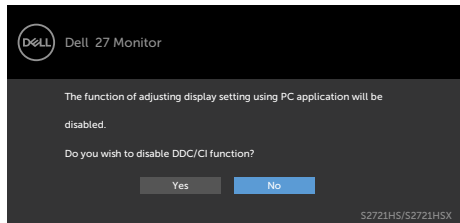

When the monitor enters the **Standby** Mode, the following message appears.

### S2421HS/S2421HSX

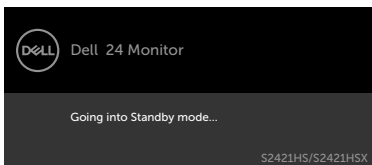

### S2721HS/S2721HSX

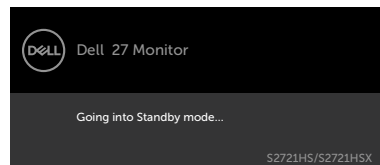

Activate the computer and wake up the monitor to gain access to the [OSD](#).



When you select OSD items of **On in Standby Mode** in Personalize feature, the following message appears.

### S2421HS/S2421HSX

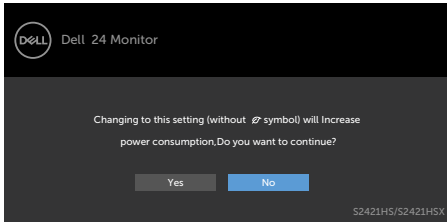

### S2721HS/S2721HSX

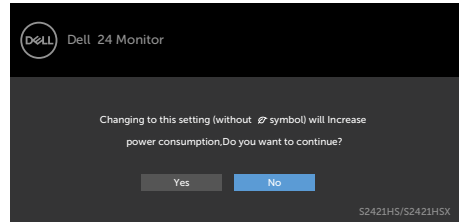

If you adjust the Brightness level above the default level over 75%, the following message appears.

### S2421HS/S2421HSX

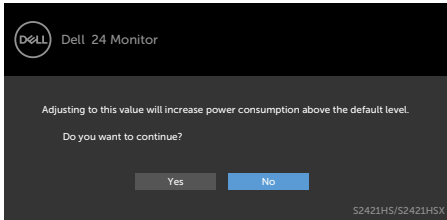

### S2721HS/S2721HSX

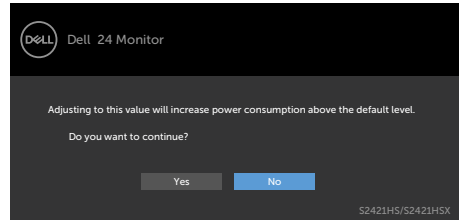

If you press any button other than the power button, the following messages will appear depending on the selected input.

### S2421HS/S2421HSX

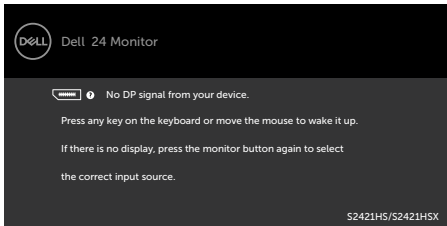

### S2721HS/S2721HSX

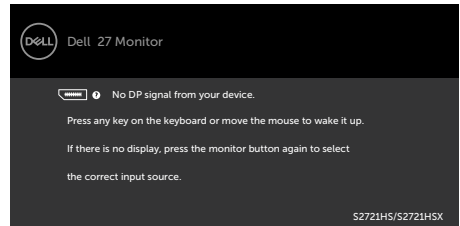



If either DP or HDMI input is selected and the corresponding cable is not connected, the following floating dialog box appears.

### S2421HS/S2421HSX

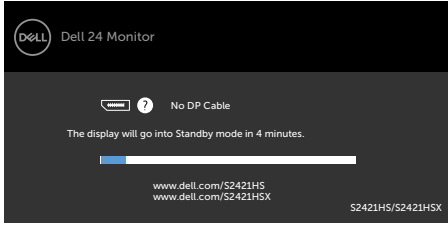

### S2721HS/S2721HSX

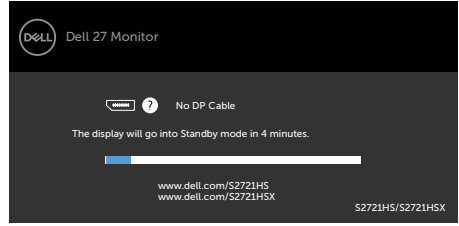

or

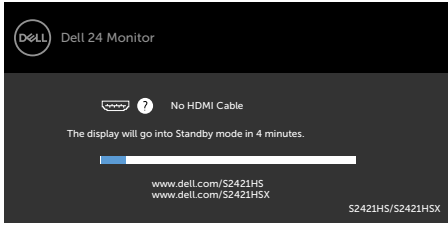

or

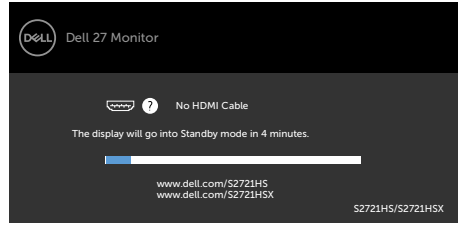

See [Troubleshooting](#) for more information.



## Setting the maximum resolution

To set the maximum resolution for the monitor:

In Windows 7, Windows 8 or Windows 8.1:

1. For Windows 8 or Windows 8.1 only, select the Desktop tile to switch to classic desktop. For Windows Vista and Windows 7, skip this step.
2. Right-click on the desktop and click **Screen Resolution**.
3. Click the drop-down list of the **Screen Resolution** and select **1920 x 1080**.
4. Click **OK**.

In Windows 10:

1. Right-click on the desktop and click **Display Settings**.
2. Click **Advanced display settings**.
3. Click the drop-down list of **Resolution** and select **1920 x 1080**.
4. Click **Apply**.

If you do not see the **1920 x 1080** as an option, you may need to update your graphics driver. Depending on your computer, complete one of the following procedures:

If you have a Dell desktop or portable computer:

- Go to <https://www.dell.com/support>, enter your service tag, and download the latest driver for your graphics card.

### **If you are using a non-Dell computer (laptop or desktop):**

- Go to your computer manufacturer's support website and download the latest graphic drivers.
- Go to your graphics card manufacturer's website and download the latest graphic drivers.



# Troubleshooting

**⚠ WARNING:** Before you begin any of the procedures in this section, follow the [Safety Instructions](#).

## Self-test

Your monitor provides a self-test feature that allows you to check whether your monitor is functioning properly. If your monitor and computer are properly connected but the monitor screen remains dark, run the monitor self-test by performing the following steps:

1. Turn off both your computer and the monitor.
2. Unplug the video cable from the back of the computer. To ensure proper Self-Test operation, remove all video cables from the back of computer.
3. Turn on the monitor.

The floating dialog box should appear on-screen (against a black background), if the monitor cannot sense a video signal and is working correctly. While in self-test mode, the power LED remains white. Also, depending upon the selected input, one of the dialogs shown below will continuously scroll through the screen.

### S2421HS/S2421HSX

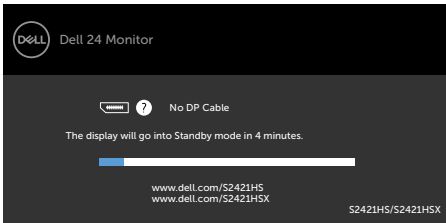

### S2721HS/S2721HSX

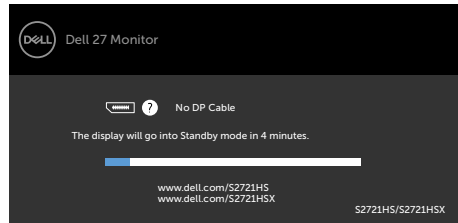

OR

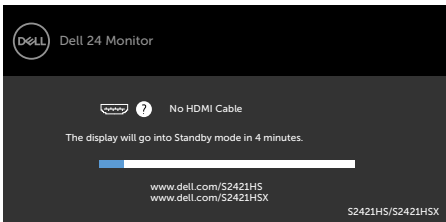

OR

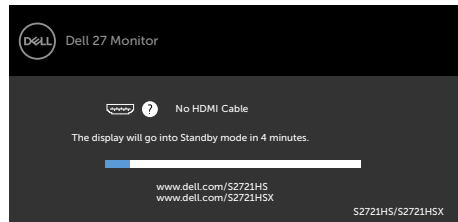

4. This box also appears during normal system operation if the video cable is disconnected or damaged.
5. Turn off your monitor and reconnect the video cable; then turn on both your computer and the monitor.



If your monitor screen remains blank after you use the previous procedure, check your video controller and computer, because your monitor is functioning properly.

## Built-in diagnostics

Your monitor has a built-in diagnostic tool that helps you determine if the screen abnormality you are experiencing is an inherent problem with your monitor, or with your computer and video card.

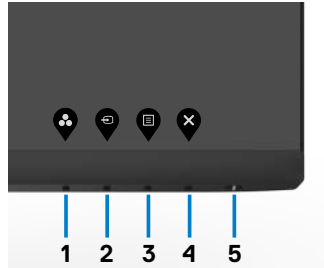

To run the built-in diagnostics:

1. Ensure that the screen is clean (no dust particles on the surface of the screen).
2. Press and hold **Button 4** for four seconds, a menu appears on the screen.
3. Select the built-in diagnostics  option. A gray screen appears.
4. Carefully inspect the screen for abnormalities.
5. Press Button 1 on the front panel again. The color of the screen changes to red.
6. Inspect the display for any abnormalities.
7. Repeat steps 5 and 6 to inspect the display when it changes to green, blue, black, white, and text screens.

The test is complete when the text screen appears. To exit, press Button 1 again.

If you do not detect any screen abnormalities during the built-in diagnostic tool, the monitor is functioning properly. Check the video card and computer.



## Common problems

The following table contains general information about common monitor problems you might encounter and the possible solutions.

Common Symptoms	What You Experience	Possible Solutions
No video/ Power LED off	No picture	<ul style="list-style-type: none"><li>· Ensure that the video cable connecting the monitor and the computer is properly connected and secure.</li><li>· Verify that the power outlet is functioning properly using any other electrical equipment.</li><li>· Ensure that the power button is depressed fully.</li><li>· Ensure that the correct input source is selected in the <a href="#">Input Source</a> menu.</li></ul>
No video/ Power LED on	No picture or no brightness	<ul style="list-style-type: none"><li>· Increase brightness and contrast controls through OSD.</li><li>· Perform monitor self-test feature check.</li><li>· Check for bent or broken pins in the video cable connector.</li><li>· Run the built-in diagnostics.</li><li>· Ensure that the correct input source is selected in the <a href="#">Input Source</a> menu.</li></ul>
Missing pixels	LCD screen has spots	<ul style="list-style-type: none"><li>· Cycle power on-off.</li><li>· Pixel that is permanently off is a natural defect that can occur in LCD technology.</li><li>· For more information about Dell Monitor Quality and Pixel Policy, see Dell Support site at: <a href="https://www.dell.com/support/monitors">https://www.dell.com/support/monitors</a>.</li></ul>
Stuck-on pixels	LCD screen has bright spots	<ul style="list-style-type: none"><li>· Cycle power on-off.</li><li>· Pixel that is permanently off is a natural defect that can occur in LCD technology.</li><li>· For more information about Dell Monitor Quality and Pixel Policy, see Dell Support site at: <a href="https://www.dell.com/support/monitors">https://www.dell.com/support/monitors</a>.</li></ul>
Brightness problems	Picture too dim or too bright	<ul style="list-style-type: none"><li>· Reset the monitor to factory settings.</li><li>· Adjust brightness and contrast controls through OSD.</li></ul>
Safety-related issues	Visible signs of smoke or sparks	<ul style="list-style-type: none"><li>· Do not perform any troubleshooting steps.</li><li>· Contact Dell immediately.</li></ul>



<b>Common Symptoms</b>	<b>What You Experience</b>	<b>Possible Solutions</b>
Intermittent problems	Monitor malfunctions on and off	<ul style="list-style-type: none"> <li>· Ensure that the video cable connecting the monitor to the computer is connected properly and is secure.</li> <li>· Reset the monitor to factory settings.</li> <li>· Perform monitor self-test feature check to determine if the intermittent problem occurs in self-test mode.</li> </ul>
Missing color	Picture missing color	<ul style="list-style-type: none"> <li>· Perform monitor self-test.</li> <li>· Ensure that the video cable connecting the monitor to the computer is connected properly and is secure.</li> <li>· Check for bent or broken pins in the video cable connector.</li> </ul>
Wrong color	Picture color not good	<ul style="list-style-type: none"> <li>· Change the settings of the <b>Preset Modes</b> in the <b>Color</b> menu OSD depending on the application.</li> <li>· Adjust R/G/B value under <b>Custom Color</b> in <b>Color</b> menu OSD.</li> <li>· Change the <b>Input Color Format</b> to PC RGB or YPbPr in the <b>Color</b> menu OSD.</li> <li>· Run the built-in diagnostics.</li> </ul>
Image retention from a static image left on the monitor for a long period of time	Faint shadow from the static image displayed appears on the screen	<ul style="list-style-type: none"> <li>· Set the screen to turn off after a few minutes of screen idle time. These can be adjusted in Windows Power Options or Mac Energy Saver setting.</li> <li>· Alternatively, use a dynamically changing screensaver.</li> </ul>



## Product specific problems

<b>Problem</b>	<b>What You Experience</b>	<b>Possible Solutions</b>
Screen image is too small	Image is centered on screen, but does not fill entire viewing area	<ul style="list-style-type: none"><li>· Check the <b>Aspect Ratio</b> setting in the <b>Display</b> menu OSD.</li><li>· Reset the monitor to factory settings.</li></ul>
Cannot adjust the monitor with the buttons on the front panel	OSD does not appear on the screen	<ul style="list-style-type: none"><li>· Turn off the monitor, unplug the monitor power cable, plug it back, and then turn on the monitor.</li></ul>
No Input Signal when user controls are pressed	No picture, the LED light is white	<ul style="list-style-type: none"><li>· Check the signal source. Ensure that the computer is not in the power saving mode by moving the mouse or pressing any key on the keyboard.</li><li>· Check whether the signal cable is plugged in properly. Re-plug the signal cable if necessary.</li><li>· Reset the computer or video player.</li></ul>
The picture does not fill the entire screen	The picture cannot fill the height or width of the screen	<ul style="list-style-type: none"><li>· Due to different video formats (aspect ratio) of DVDs, the monitor may display in full screen.</li><li>· Run the built-in diagnostics.</li></ul>



# Appendix

## FCC notices (U.S. only) and other regulatory information

For FCC notices and other regulatory information, see the regulatory compliance website located at [https://www.dell.com/regulatory\\_compliance](https://www.dell.com/regulatory_compliance).

## Contacting Dell

For customers in the United States, call 800-WWW-DELL (800-999-3355).

 **NOTE: If you do not have an active Internet connection, you can find contact information on your purchase invoice, packing slip, bill, or Dell product catalog.**

**Dell provides several online and telephone-based support and service options. Availability varies by country and product, and some services may not be available in your area.**

- Online technical assistance — <https://www.dell.com/support/monitors>

## EU product database for energy label and product information sheet

**S2421HS:** <https://eprel.ec.europa.eu/qr/345961>

**S2421HSX:** <https://eprel.ec.europa.eu/qr/349827>

**S2721HS:** <https://eprel.ec.europa.eu/qr/345955>

**S2721HSX:** <https://eprel.ec.europa.eu/qr/349826>

