



Alienware AW5520QF Monitor User's Guide

Model: AW5520QF
Regulatory model: AW5520QFb

A L I E N W A R E™ 

Notes, cautions, and warnings

-  **NOTE:** A NOTE indicates important information that helps you make better use of your product.
-  **CAUTION:** A CAUTION indicates potential damage to hardware or loss of data if instructions are not followed.
-  **WARNING:** A WARNING indicates a potential for property damage, personal injury, or death.

© 2019-2020 Dell Inc. or its subsidiaries. All rights reserved. Dell, EMC, and other trademarks are trademarks of Dell Inc. or its subsidiaries. Other trademarks may be trademarks of their respective owners

2020 - 12

Rev. A01

Contents

About your monitor	6
Package contents	6
Product features	8
Identifying parts and controls	9
Front view	9
Top view	10
Back view	11
Bottom view	12
Side view	13
Monitor specifications	14
Resolution specifications	15
Supported video modes	15
Preset display modes	16
Electrical specifications	18
Speaker Specifications	19
Physical characteristics	19
Environmental characteristics	20
Pin assignments	21
Plug and Play capability	22
Universal Serial Bus (USB) interface	23
USB upstream connector	23
USB downstream connector	24
USB ports	24
OLED monitor quality and pixel policy	24
Maintenance guidelines	25
Cleaning your monitor	25

Setting up the monitor	26
Attaching the stand	26
Attaching the VESA adapter	34
Connecting the computer	36
Remote control	37
Inserting the batteries into the remote control	38
Handling the remote control	39
Operating range of the remote control	39
Operating the monitor	40
Power on the monitor	40
Using the front-panel controls	40
Front-panel button	41
Using the On-Screen Display (OSD) menu	42
Accessing the menu system	42
OSD warning message	57
Setting the maximum resolution	62
Requirements to view or playback HDR content	62
Using AlienFX application	64
Prerequisites	64
Installing AWCC through Windows update	64
Installing AWCC from the Dell Support website	64
Navigating the AlienFX window	65
Creating a theme	67
Setting lighting effects	68
Troubleshooting	71
Self-test	71
Built-in diagnostics	72
Common problems	73
Product specific problems	75

Universal Serial Bus (USB) specific problems.76

Appendix77

FCC notices (U.S. only) and other regulatory
information.77

Contact Dell.77





EU product database for energy label and product
information sheet77

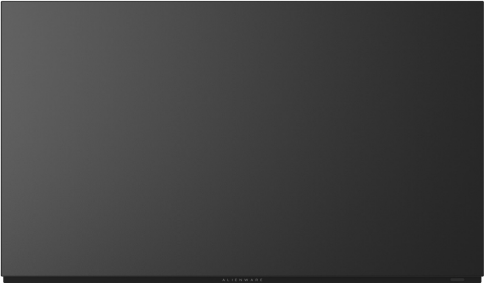

About your monitor

Package contents

Your monitor ships with the components shown below. If any component is missing, contact Dell technical support. For more information see [Contact Dell](#).

 **NOTE: Some components may be optional and may not ship with your monitor. Some features or media may not be available in certain countries.**

Component image	Component description
	Monitor
	Stand
	Mounting bracket for stand
	VESA adapter

	<p>Screw (M4) x 10 (4 for locking stand base on bracket or assembling the VESA adapter; 6 for assembling the stand)</p>
	<p>Remote control and batteries (AAA x 2)</p>
	<p>Power cable (varies by country)</p>
	<p>DisplayPort cable (DisplayPort to DisplayPort)</p>
	<p>HDMI cable</p>
	<p>USB 3.0 upstream cable (enables the USB ports on the monitor)</p>
	<ul style="list-style-type: none"> ▪ Quick Setup Guide ▪ Safety, Environmental, and Regulatory Information ▪ Alienware Welcome Letter

Product features

The **Alienware AW5520QF** monitor has an Active Matrix Organic Light Emitting Diode (AMOLED) that uses Oxide Thin Film Transistor as switching components. The monitor features include:

- 138.78 cm (54.6 inch) viewable area (measured diagonally). Resolution: Up to 3840 x 2160 through DisplayPort and HDMI, with full-screen support or lower resolutions, supporting an extremely high refresh rate of 120 Hz with DisplayPort and 60 Hz with HDMI.
- AMD FreeSync™ Premium Technology minimizes graphic distortions like screen tearing and stuttering for smoother, fluid gameplay.
- Supports a extremely high refresh rate of 120 Hz and a rapid response time of 0.5 ms.
- Color gamut of 98.5% DCI-P3.
- Removable stand and Video Electronics Standards Association (VESA™) mounting holes (200 mm x 200 mm & 300 mm x 200 mm) via VESA adapter for flexible mounting solutions.
- Digital connectivity via 1 DisplayPort and 3 HDMI ports.
- Equipped with 1 USB upstream port and 4 USB downstream ports.
- Plug and play capability if supported by your system.
- On-Screen Display (OSD) adjustments for ease of setup and screen optimization.
- AW5520QF offers a couple of preset modes, including FPS (First-Person Shooter), MOBA/RTS (Multiplayer Online Battle Arena/Real-Time Strategy), RPG (Role-Playing Game), SPORTS (racing games), and three customizable game modes for user's own preference. In addition, key enhanced gaming features such as Timer, Frame Rate, and Display Alignment are provided to help improve gamer's performance and provide best-in game advantage.
- ≤ 0.3 W in Standby Mode.
- Optimize eye comfort with a flicker-free screen.

 **WARNING: The possible long-term effects of blue light emission from the monitor may cause damage to the eyes, including eye fatigue, digital eye strain, and so on. ComfortView feature is designed to reduce the amount of blue light emitted from the monitor to optimize eye comfort.**

Identifying parts and controls

Front view

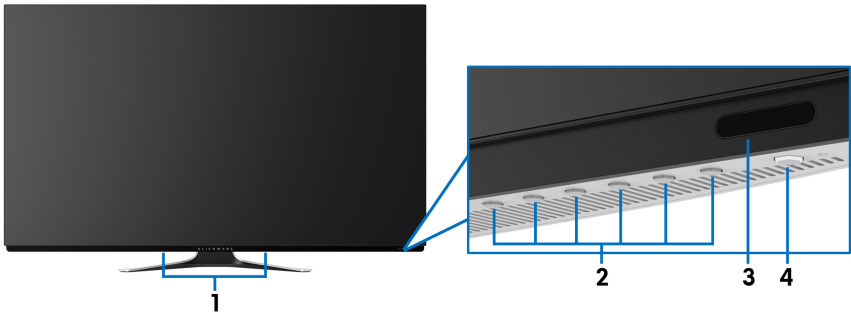

Label	Description	Use
1	Built-in speakers	Allows you to hear the audio content played from them.
2	Function buttons	For more information, see Operating the monitor .
3	IR lens	To receive the infrared light signals sent from the remote control (shipped with your monitor).
4	Power On/Off button (with LED indicator)	To turn the monitor on or off. Solid blue light indicates that the monitor is turned on and functioning normally. Blinking white light indicates that the monitor is in Standby Mode.

Top view

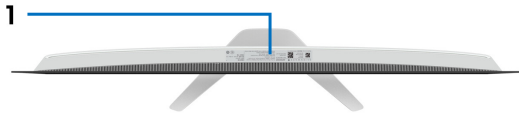

Label	Description	Use
1	Barcode, serial number, and Service Tag label	Refer to this label if you need to contact Dell for technical support.

Back view

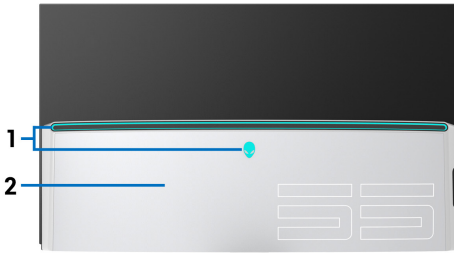

Back view with I/O cover

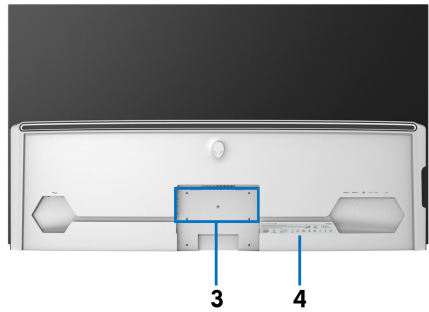

Back view without I/O cover

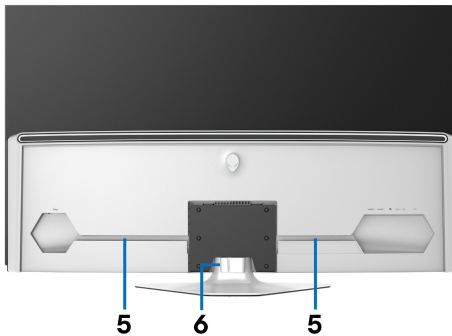

Back view with monitor stand

Label	Description	Use
1	AlienFX LED lights	The Alienware logo and the LED stripe may light on. To change the settings, see AlienFX Lighting .
2	I/O cover	Protects the I/O ports.
3	Stand and VESA adapter mounting holes	For stand or VESA adapter (200 mm x 200 mm & 300 mm x 200 mm) mounting.
4	Regulatory label	Lists the regulatory approvals.
5	Cable-management channels	To organize the cables neatly.
6	Cable-management clip	

Bottom view

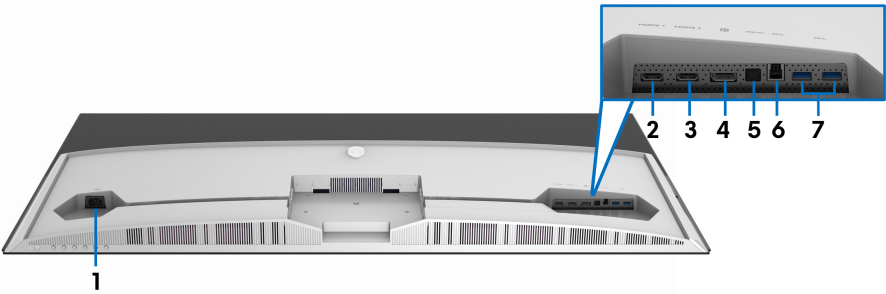

Bottom view without monitor stand

Label	Description	Use
1	Power connector	Connect the power cable (shipped with your monitor).
2	HDMI port (HDMI 1)	Connect your computer with the HDMI cable (shipped with your monitor).
3	HDMI port (HDMI 2)	
4	DisplayPort	Connect your computer with the DisplayPort cable (shipped with your monitor).
5	SPDIF Out port	Connect your S/PDIF device with the S/PDIF cable (sold separately).
6	USB upstream port	Connect the USB cable (shipped with your monitor) to this port and your computer to enable the USB ports on your monitor.
7	USB downstream ports (2)	Connect your USB device. NOTE: To use these ports, you must connect the USB cable (shipped with your monitor) to the USB upstream port on the monitor and to your computer.

Side view

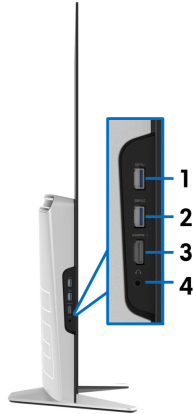

Label	Description	Use
1	USB downstream port	Connect your USB device.* NOTE: To use this port, you must connect the USB cable (shipped with your monitor) to the USB upstream port on the monitor and to your computer.
2	USB downstream port with Power Charging	Connect to charge your device.
3	HDMI port (HDMI 3)	Connect your computer with the HDMI cable (shipped with your monitor).
4	Headphone port	Connect a headphone or speakers.

* To avoid signal interference, when a wireless USB device has been connected to a USB downstream port, it is not recommended to connect any other USB devices to the adjacent port.

Monitor specifications

Model	AW5520QF
Screen type	Color Active Matrix
Panel technology	OLED
Aspect ratio	16:9
Viewable image	
Diagonal	1387.8 mm (54.6 in.)
Width (active area)	1209.6 mm (47.62 in.)
Height (active area)	680.4 mm (26.79 in.)
Total area	823011.8 mm ² (1275.67 in ²)
Pixel pitch	0.315 mm x 0.315 mm
Pixel per inch (PPI)	81
Viewing angle	
Vertical	120° (typical)
Horizontal	120° (typical)
Luminance output	<ul style="list-style-type: none">▪ 130 cd/m² (typical)▪ 400 cd/m² (maximum)
Contrast ratio	130000:1 (typical)
Faceplate coating	Hard coating (2H), anti-reflection treatment of the front polarizer
Backlight	N/A
Response time	0.5 ms gray-to-gray
Color depth	1.07 billion colors
Color gamut	98.5% DCI-P3
Built-in devices	<ul style="list-style-type: none">▪ USB 3.0 Super-Speed hub (with 1 USB 3.0 upstream port)▪ 4 x USB 3.0 downstream port (including 1 port which supports power-charging)

Connectivity	<ul style="list-style-type: none"> ▪ 1 x DisplayPort version 1.4 (bottom) ▪ 3 x HDMI port version 2.0 (bottom: 2; side: 1) ▪ 1 x USB 3.0 upstream port (bottom) ▪ 4 x USB 3.0 downstream port (bottom: 2; side: 2) ▪ 1 x headphone port (side) ▪ 1 x S/PDIF Out port (bottom)
Border width (edge of monitor to active area)	
Top	8.0 mm
Left/Right	8.2 mm/8.2 mm
Bottom	11.9 mm
Dell Display Manager (DDM) Compatibility	Easy Arrange and other key features

 **NOTE: Do not mount or use this monitor in portrait (vertical) orientation or inverse (180°) landscape mount as it may damage the monitor.**

Resolution specifications

Model	AW5520QF
Horizontal scan range	<ul style="list-style-type: none"> ▪ DisplayPort: 27 to 269 kHz (automatic) ▪ HDMI: 27 to 143 kHz (automatic)
Vertical scan range	<ul style="list-style-type: none"> ▪ DisplayPort 1.4: 40 to 120 Hz (automatic) ▪ HDMI 2.0: 40 to 120 Hz (automatic)
Maximum preset resolution	<ul style="list-style-type: none"> ▪ DisplayPort: 3840 x 2160 @ 120 Hz ▪ HDMI: 3840 x 2160 @ 60 Hz

Supported video modes

Model	AW5520QF
Video display capabilities (HDMI & DisplayPort playback)	480i, 480p, 576i, 576p, 720p, 1080i, 1080p, QHD, UHD

Preset display modes

HDMI display modes

Display mode	Horizontal frequency (kHz)	Vertical frequency (Hz)	Pixel clock (MHz)	Sync polarity (Horizontal/Vertical)
VESA, 640 x 400	31.5	70.1	25.2	+/-
VESA, 640 x 480	31.5	59.9	25.2	-/-
VESA, 640 x 480	37.5	75.0	31.5	-/-
VESA, 720 x 400	31.5	70.1	28.3	-/+
VESA, 800 x 600	37.9	60.3	40.0	+/+
VESA, 800 x 600	46.9	75.0	49.5	+/+
VESA, 1024 x 768	48.4	60.0	65.0	-/-
VESA, 1024 x 768	60.0	75.0	78.8	+/+
VESA, 1152 x 864	67.5	75.0	108.0	+/+
VESA, 1280 x 800-R	49.3	59.9	71.0	+/+
VESA, 1280 x 1024	64.0	60.0	108.0	+/+
VESA, 1280 x 1024	80.0	75.0	135.0	+/+
VESA, 1600 x 1200	75.0	60.0	162.0	+/+
VESA, 1920 x 1080	67.5	60.0	148.5	+/+
VESA, 1920 x 1080	137.3	120.0	285.5	+/-
VESA, 2048 x 1280-R	78.9	59.9	174.3	+/+
VESA, 2560 x 1440	88.8	60.0	241.5	+/-
VESA, 3840 x 2160	135.0	60.0	594.0	+/-

DP display modes

Display mode	Horizontal frequency (kHz)	Vertical frequency (Hz)	Pixel clock (MHz)	Sync polarity (Horizontal/Vertical)
VESA, 640 x 400	31.5	70.1	25.2	+/-
VESA, 640 x 480	31.5	59.9	25.2	-/-
VESA, 640 x 480	37.5	75.0	31.5	-/-
VESA, 720 x 400	31.5	70.1	28.3	-/+
VESA, 800 x 600	37.9	60.3	40.0	+/+
VESA, 800 x 600	46.9	75.0	49.5	+/+
VESA, 1024 x 768	48.4	60.0	65.0	-/-
VESA, 1024 x 768	60.0	75.0	78.8	+/+
VESA, 1152 x 864	67.5	75.0	108.0	+/+
VESA, 1280 x 800-R	49.3	59.9	71.0	+/+
VESA, 1280 x 1024	64.0	60.0	108.0	+/+
VESA, 1280 x 1024	80.0	75.0	135.0	+/+
VESA, 1600 x 1200	75.0	60.0	162.0	+/+
VESA, 1920 x 1080	67.5	60.0	148.5	+/+
VESA, 1920 x 1080	137.3	120.0	285.5	+/-
VESA, 2048 x 1280-R	78.9	59.9	174.3	+/+
VESA, 2560 x 1440	88.8	60.0	241.5	+/-
VESA, 3840 x 2160	133.3	60.0	533.3	+/-
VESA, 3840 x 2160	266.6	120.0	1066.5	+/-

 **NOTE: This monitor supports AMD FreeSync™ Premium Technology.**

Electrical specifications

Model	AW5520QF
Video input signals	HDMI 2.0*, DisplayPort 1.4, 600 mV for each differential line, 100 ohm input impedance per differential pair
AC input voltage/frequency/current	100 VAC to 240 VAC / 50 Hz or 60 Hz \pm 3 Hz / 4.5 A (typical)
Inrush current	<ul style="list-style-type: none">▪ 120 V: 50 A (max.) at 0°C (cold start)▪ 220 V: 100 A (max.) at 0°C (cold start)
Power consumption	<ul style="list-style-type: none">▪ 0.3 W (Off mode)¹▪ 0.3 W (Standby Mode)¹▪ 82.5 W (On mode)¹▪ 390 W (Max.)²▪ 84.75 W (Pon)³▪ 262.12 kWh (TEC)³

* Does not support the HDMI 2.0 optional specification, including Consumer Electronics Control (CEC), HDMI Ethernet Channel (HEC), Audio Return Channel (ARC), standard for 3D format and resolutions, and standard for 4K digital cinema resolution.

¹ As defined in EU 2019/2021 and EU 2019/2013.

² Max brightness and contrast setting with maximum power loading on all USB ports.

³ Pon: Power consumption of On Mode measured with reference to Energy Star test method.

TEC: Total energy consumption in kWh measured with reference to Energy Star test method.

This document is informational only and reflects laboratory performance. Your product may perform differently, depending on the software, components and peripherals you ordered and shall have no obligation to update such information.

Accordingly, the customer should not rely upon this information in making decisions about electrical tolerances or otherwise. No warranty as to accuracy or completeness is expressed or implied.

Speaker Specifications

Model	AW5520QF
Speaker rated power	2 x 14 W
Frequency response	180 Hz - 20 kHz
Impedance	8 ohm

Physical characteristics

Model	AW5520QF
Signal cable type	<ul style="list-style-type: none">▪ Digital: HDMI, 19 pins▪ Digital: DisplayPort, 20 pins▪ Universal Serial Bus: USB, 9 pins
NOTE: Dell monitors are designed to work optimally with the video cables that are shipped with your monitor. As Dell does not have control over the different cable suppliers in the market, the type of material, connector and process used to manufacture these cables, Dell does not guarantee video performance on cables that are not shipped with your Dell monitor.	
Dimensions (with stand)	
Height	770.6 mm (30.34 in.)
Width	1225.9 mm (48.26 in.)
Depth	263.9 mm (10.39 in.)
Dimensions (without stand)	
Height	717.2 mm (28.24 in.)
Width	1225.9 mm (48.26 in.)
Depth	80.3 mm (3.16 in.)
Stand dimensions	
Height	246.7 mm (9.71 in.)
Width	546.2 mm (21.50 in.)
Depth	263.9 mm (10.39 in.)
Weight	
Weight with packaging	41.3 kg (90.96 lb)

Weight with stand assembly, cables, and remote control	26.1 kg (57.54 lb)
Weight without stand assembly (For wall mount or VESA mount considerations - no cables)	25.5 kg (59.13 lb)
Weight of stand assembly	1.9 kg (4.23 lb)
Front frame gloss	4-7 GU (only front chin)

Environmental characteristics

Model	AW5520QF
Compliant standards	
<ul style="list-style-type: none"> ▪ Arsenic-free glass and mercury-free for the panel only ▪ BFR/PVC free Monitor (excluding external cables) 	
Temperature	
Operating	0°C to 40°C (32°F to 104°F)
Non-operating	<ul style="list-style-type: none"> ▪ Storage: -20°C to 60°C (-4°F to 140°F) ▪ Shipping: -20°C to 60°C (-4°F to 140°F)
Humidity	
Operating	10% to 80% (non-condensing)
Non-operating	<ul style="list-style-type: none"> ▪ Storage: 5% to 90% (non-condensing) ▪ Shipping: 5% to 90% (non-condensing)
Altitude	
Operating	5,000 m (16,404 ft) (maximum)
Non-operating	12,192 m (40,000 ft) (maximum)
Thermal dissipation	<ul style="list-style-type: none"> ▪ 1331 BTU/hour (maximum) ▪ 341 BTU/hour (typical)

Pin assignments

DisplayPort connector

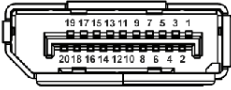

Pin number	20-pin side of the connected signal cable
1	ML3 (n)
2	GND
3	ML3 (p)
4	ML2 (n)
5	GND
6	ML2 (p)
7	ML1 (n)
8	GND
9	ML1 (p)
10	ML0 (n)
11	GND
12	ML0 (p)
13	GND
14	GND
15	AUX (p)
16	GND
17	AUX (n)
18	Hot Plug Detect
19	Re-PWR
20	+3.3 V DP_PWR

HDMI connector

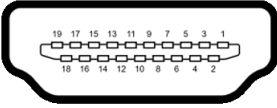

Pin number	19-pin side of the connected signal cable
1	TMDS DATA 2+
2	TMDS DATA 2 SHIELD
3	TMDS DATA 2-
4	TMDS DATA 1+
5	TMDS DATA 1 SHIELD
6	TMDS DATA 1-
7	TMDS DATA 0+
8	TMDS DATA 0 SHIELD
9	TMDS DATA 0-
10	TMDS CLOCK+
11	TMDS CLOCK SHIELD
12	TMDS CLOCK-
13	CEC
14	Reserved (N.C. on device)
15	DDC CLOCK (SCL)
16	DDC DATA (SDA)
17	DDC/CEC Ground
18	+5V POWER
19	HOT PLUG DETECT

Plug and Play capability

You can connect the monitor to any Plug and Play-compatible system. The monitor automatically provides the computer system with its Extended Display Identification Data (EDID) using Display Data Channel (DDC) protocols so that the system can configure itself and optimize the monitor settings. Most monitor installations are automatic; you can select different settings if desired. For more information about changing the monitor settings, see [Operating the monitor](#).

Universal Serial Bus (USB) interface

This section gives you information about the USB ports that are available on the monitor.

 **NOTE: This monitor is Super-Speed USB 3.0 compatible.**

Transfer speed	Data rate	Power consumption*
Super-Speed	5 Gbps	4.5 W (Max, each port)
High speed	480 Mbps	4.5 W (Max, each port)
Full speed	12 Mbps	4.5 W (Max, each port)

* Up to 2 A on USB downstream port (with  battery icon) with battery charging version-compliant devices or normal USB devices.

USB upstream connector

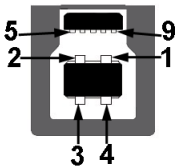

Pin number	9-pin side of the connector
1	VCC
2	D-
3	D+
4	GND
5	SSTX-
6	SSTX+
7	GND
8	SSRX-
9	SSRX+

USB downstream connector



Pin number	9-pin side of the connector
1	VCC
2	D-
3	D+
4	GND
5	SSRX-
6	SSRX+
7	GND
8	SSTX-
9	SSTX+

USB ports

- 1 x upstream - bottom
- 4 x downstream - bottom (2) and side (2)
Power charging port - the port with  icon; supports up to 2 A fast-charging capability if the device is BC1.2 compatible.

 **NOTE: USB 3.0 functionality requires a USB 3.0-capable computer.**

 **NOTE: The USB ports on the monitor work only when the monitor is turned on or in Standby mode. If you turn off the monitor and then turn it on, the attached peripherals may take a few seconds to resume normal functionality.**

OLED monitor quality and pixel policy

During the OLED monitor manufacturing process, it is not uncommon for one or more pixels to become fixed in an unchanging state, which are hard to see and do not affect the display quality or usability. For more information on OLED Monitor Quality and Pixel Policy, see www.dell.com/support/monitors.

Maintenance guidelines

Cleaning your monitor

△ **CAUTION:** Read and follow the [Safety instructions](#) before cleaning the monitor.

⚠ **WARNING:** Before cleaning the monitor, unplug the monitor power cable from the electrical outlet.

For best practices, follow the instructions in the list below when unpacking, cleaning, or handling your monitor:

- To clean your anti-static screen, lightly dampen a soft, clean cloth with water. If possible, use a special screen-cleaning tissue or solution suitable for the anti-static coating. Do not use benzene, thinner, ammonia, abrasive cleaners, or compressed air.
- Use a lightly-dampened, warm cloth to clean the monitor. Avoid using detergent of any kind as some detergents leave a milky film on the monitor.
- If you notice white powder when you unpack your monitor, wipe it off with a cloth.
- Handle your monitor with care as a darker-colored monitor may get scratched and show white scuff marks more than a lighter-colored monitor.
- To help maintain the best image quality on your monitor, use a dynamically changing screen saver and turn off your monitor when not in use.

Setting up the monitor

Attaching the stand

 **NOTE:** The stand is not factory-installed.

 **CAUTION:** The monitor is very heavy and should be handled with extreme care. It requires two people to lift or move this monitor.

 **NOTE:** The following instructions are only applicable for the stand that was shipped with your monitor. If you are attaching a stand that you purchased from any other source, follow the set up instructions that were included with the stand.

 **CAUTION:** The following steps are important to protect your screen. Do follow the instructions below to finish up the installation.

1. Remove the seven clips from the outer box by pulling out the tabs on them.
2. Open the flap and locate the Quick Setup Guide. Refer to the document to do the setup installation.

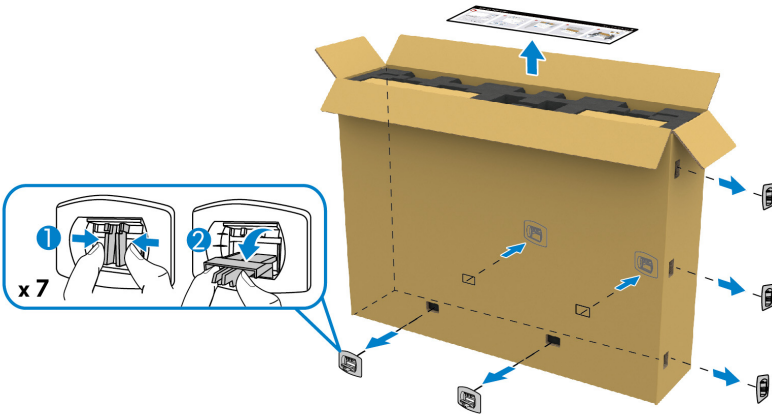

3. Remove the peripheral boxes and mounting bracket from the packaging cushion.

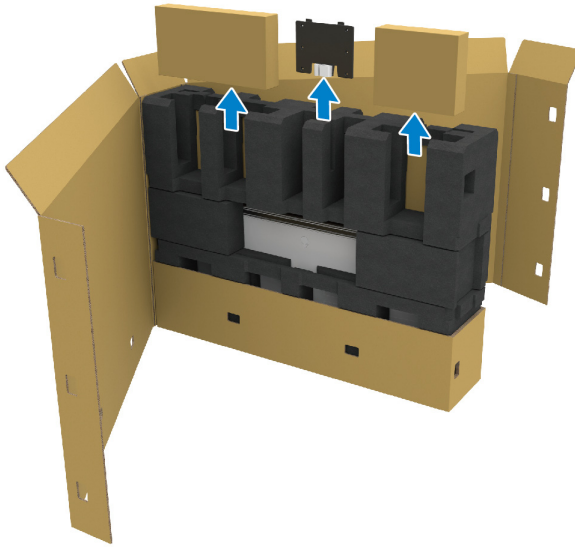

4. Remove the upper and side foam cushions.

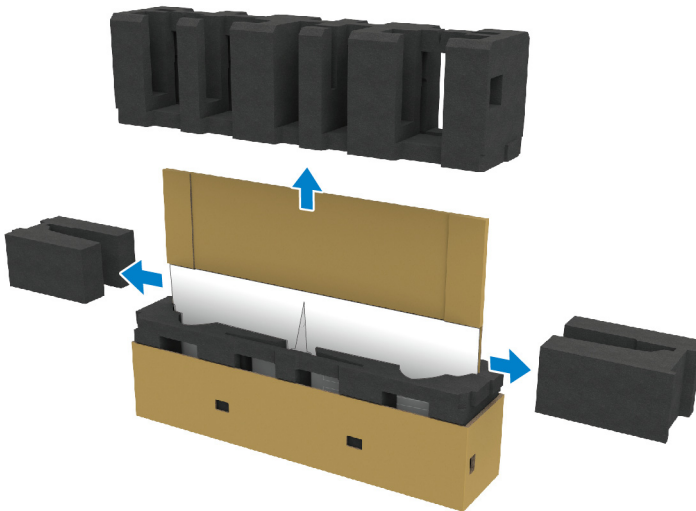

⚠ WARNING: Two people are required to lift the monitor as it is very heavy.

5. Remove the monitor from the packaging cushion.
- a. With your partner, slide one hand in the cutout areas on the bottom cushion, as shown in the image below.
 - b. With your partner, hold the monitor with the other hand by the thicker section of monitor side.

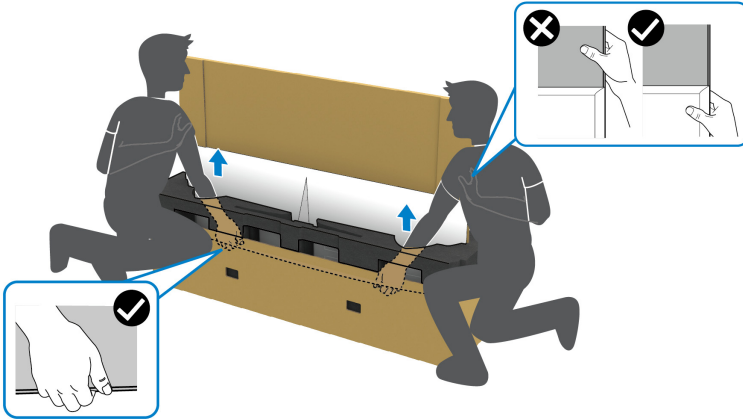

- c. Lift the monitor off the package as shown in the image below.

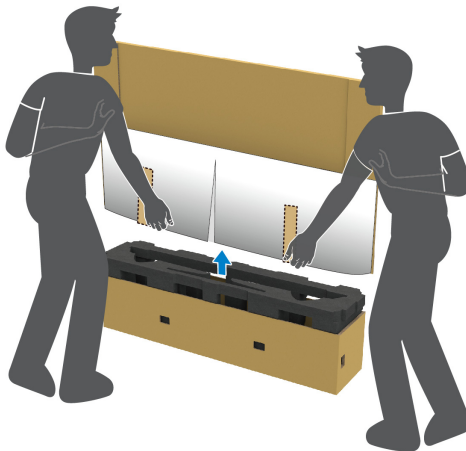

△ **CAUTION:** Do not press on the panel screen when lifting the monitor.

6. Place the monitor face down on a flat, soft surface.

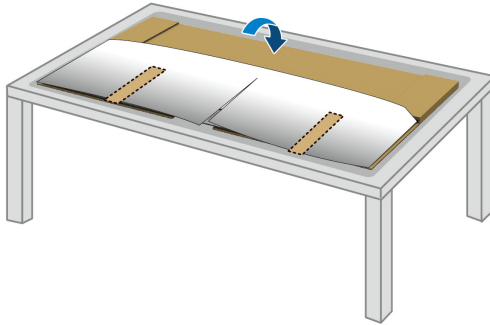

7. Remove the tape strips on the protective cover, and tear the cover along the perforated line to access the I/O cover on the monitor.

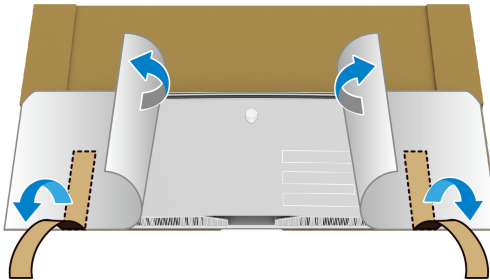

8. Insert a hand into the recess on the bottom edge of the monitor, as shown in the image below, and gently detach the magnetic I/O cover.

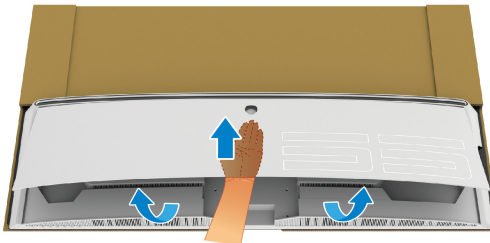

9. Remove the stand base from the packaging cushion.

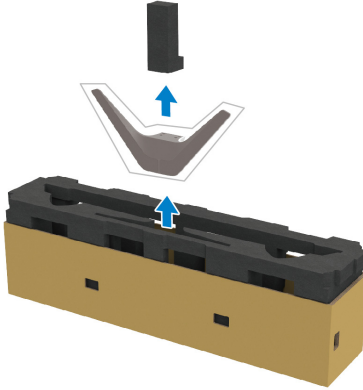

10. Insert the mounting bracket into the stand.

- a. Align the screw holes on the bracket with the screw holes on the stand.
- b. Using a Phillips crosshead screwdriver, tighten the six screws to secure the mounting bracket to the stand.

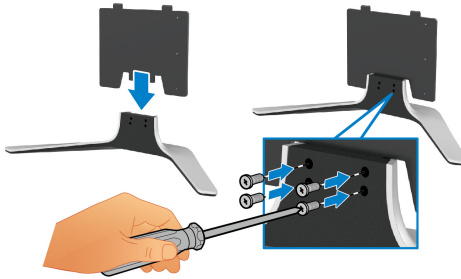

11. Attach the stand assembly to the monitor.

- a. Align the stand with the screw holes on the back of the monitor.

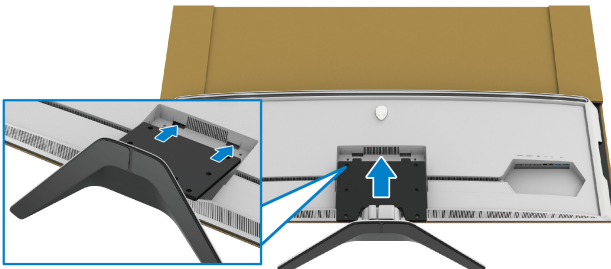

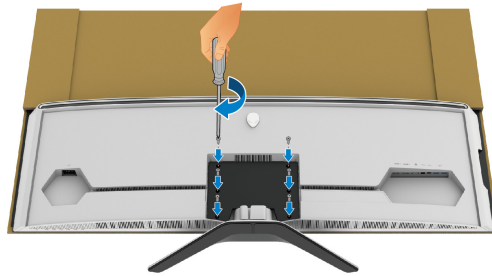

- b. Using a Phillips crosshead screwdriver, tighten the stand assembly to the monitor with the four screws.

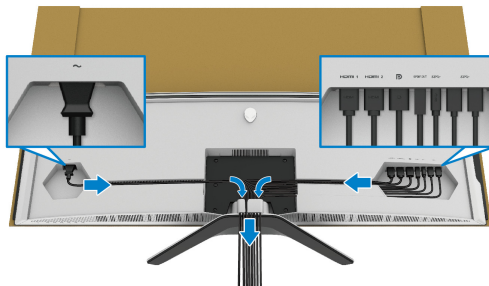

12. Connect the necessary cables to the monitor, and then secure the cables by routing them through the cable-management channels and clip.

- Power cable
- HDMI cable
- DisplayPort cable
- S/PDIF audio cable (optional, cables are not included)
- USB upstream cable
- USB downstream cables (optional, cables are not included)



-  **NOTE:** Route each cable neatly so that the cables are organized before the I/O cover is attached.
-  **NOTE:** Do not plug the power cable into the wall outlet or turn on the monitor until you are instructed to do so.

13. Align and place the I/O cover outer edges to the monitor rear recess. The I/O cover will snap in place with magnetic force.

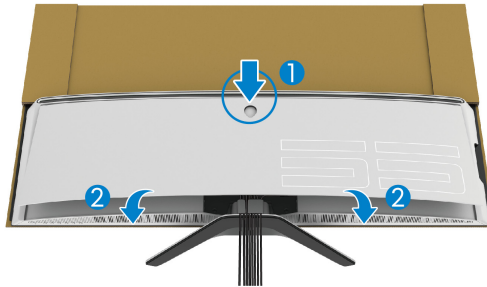

14. Carefully lift the monitor with another person, taking care to place it on an even surface.
- With your partner, use a hand to hold the bottom edge of the monitor, as shown in the image below.
 - With your partner, hold the monitor with the other hand by the thicker section of monitor side.
 - Lift the monitor.
 - Place the monitor in an upright position.

⚠ WARNING: Two people are required to lift the monitor as it is very heavy.

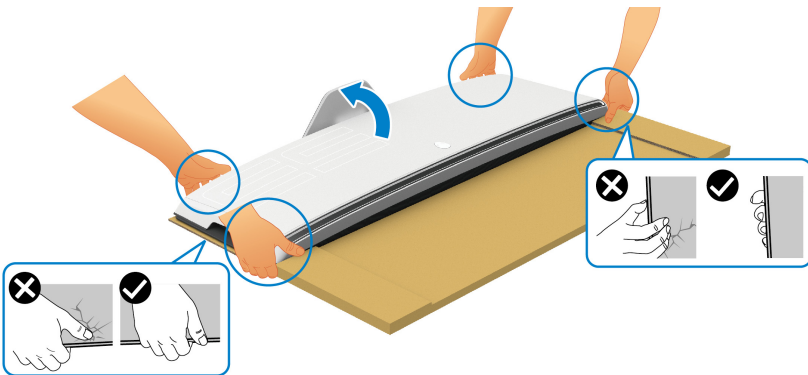

⚠ CAUTION: Hold the monitor firmly and do not press on the panel screen when lifting to avoid any accidental damage.

15. Remove the cardboard from the monitor.

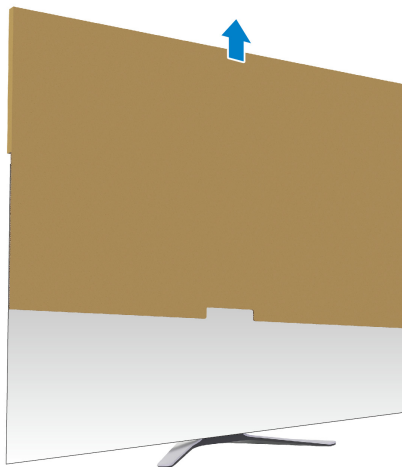

16. Remove the protective cover from the monitor.



Attaching the VESA adapter

By installing the supplied VESA adapter (in the peripheral box) onto the back of the display, you can attach a wall mount kit or 3rd-party arm (sold separately) to the monitor.

NOTE: The wall mount kit or 3rd-party arm is not shipped with this monitor.

Refer to the instructions that come with the VESA-compatible wall mount kit or 3rd-party arm.

(Screw dimension: M4 x 10 mm)

1. Follow step 1 to 8 in [Attaching the stand](#) to access the VESA adapter mounting area.
2. Attach the supplied VESA adapter to the monitor.
 - a. Align the VESA adapter with the screw holes on the back of the monitor.
 - b. Using a Phillips crosshead screwdriver, tighten the upper edge of the VESA adapter with two screws.
 - c. Using a Phillips crosshead screwdriver, tighten the bottom edge of the VESA adapter with two screws.

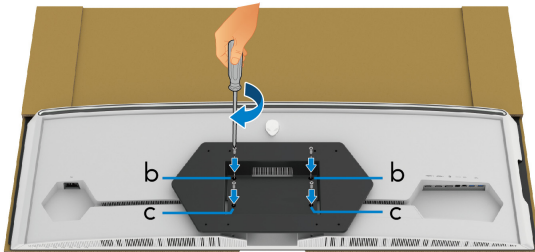
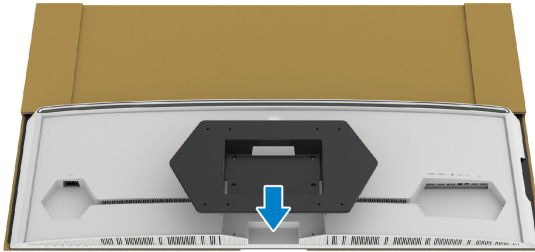

3. Route and connect the necessary cables to the monitor in the direction as shown:
 - Power cable
 - HDMI cable(s)
 - DisplayPort cable
 - S/PDIF audio cable (optional, cables are not included)
 - USB upstream cable
 - USB downstream cables (optional, cables are not included)

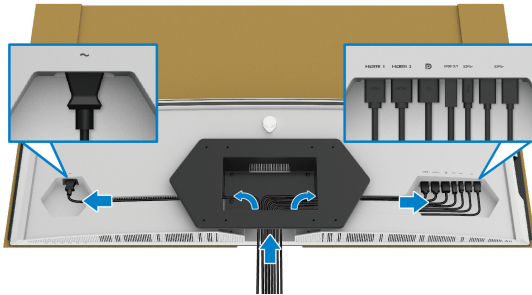

4. Mount the monitor on the wall. For more information, see the documentation that shipped with the purchased wall mount kit/3rd-party arm.
5. Remove the cardboard and protective cover from the monitor.

NOTE: For use only with UL-listed wall mount bracket with minimum weight or load bearing capacity of 102.0 kg.

Connecting the computer

⚠ WARNING: Before you begin any of the procedures in this section, follow the [Safety instructions](#).

🔧 NOTE: Do not connect all cables to the computer at the same time.

🔧 NOTE: The images are for the purpose of illustration only. Appearance of the computer may vary.

To connect your monitor to the computer:

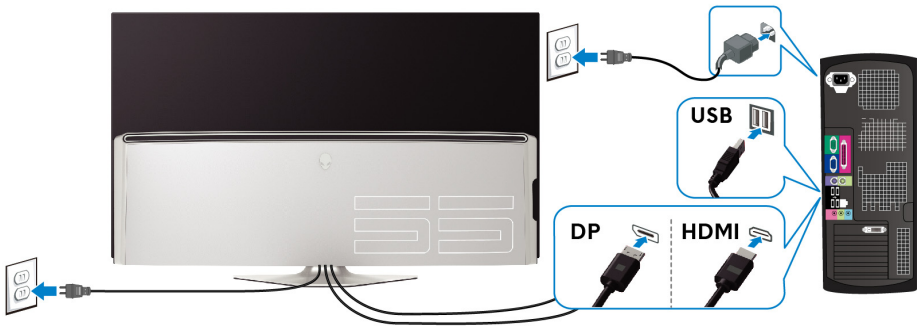

1. Connect the other end of the DisplayPort cable or HDMI cable to your computer.
2. Connect the other end of the USB 3.0 upstream cable to an appropriate USB 3.0 port on your computer.
3. Connect the USB 3.0 peripherals to the USB 3.0 downstream ports on the monitor.
4. Plug the power cables for your computer and monitor into a wall outlet.
5. Turn on the monitor and the computer.

If your monitor displays an image, installation is complete. If it does not display an image, see [Universal Serial Bus \(USB\) specific problems](#).

Remote control

You may use the buttons on the remote control to access the On-Screen Display (OSD) menu and adjust menu settings.

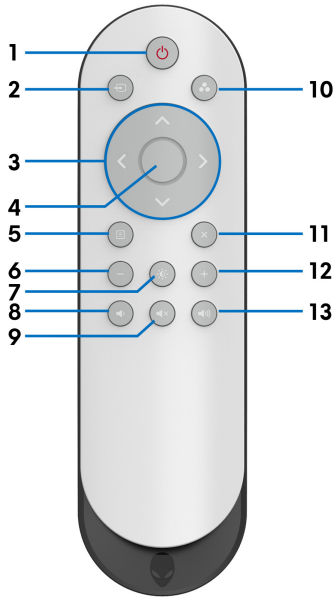

Label	Button	Description
1	Power on/off	To turn this monitor on or off.
2	Input Source	To launch the Input Source menu. Use the directional buttons to select between the different video signals that are connected to your monitor. Then press the OK button to confirm the selection and exit.
3	Directional buttons	Use the buttons (up/down/left/right) to move between the setting options in the OSD menu.
4	OK	To confirm your selection. When the OSD menu is off, selecting this button may launch the OSD menu.
5	Menu	To launch the OSD menu.
6	-	To decrease the adjustment levels.
7	Brightness/Contrast	To directly access the Brightness/Contrast adjustment sliders.
8	Volume -	To decrease the volume level.

9	Mute	To turn off the volume.
10	Preset Modes	To specify a desired color mode from a preset list. For details, see Preset Modes .
11	Exit	To exit the OSD main menu.
12	+	To increase the adjustment levels.
13	Volume +	To increase the volume level.

Inserting the batteries into the remote control

The remote control is powered by two 1.5V AAA batteries.

To install or replace batteries:

1. Remove the battery cover by lifting the bottom edge of the remote control.
2. Align the batteries according to the (+) and (-) indications inside the battery compartment.
3. Replace the battery cover.

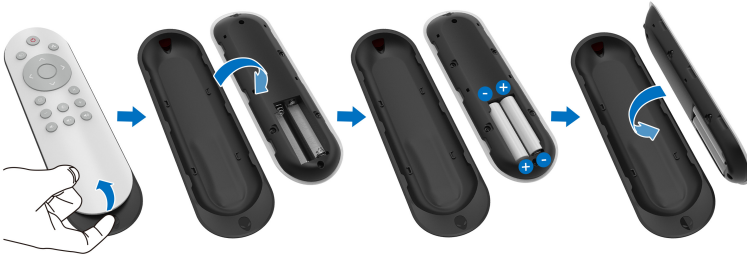

⚠ CAUTION: The incorrect use of batteries can result in leaks or bursting. Be sure to follow these instructions:

- Place "AAA" batteries matching the (+) and (-) signs on each battery to the (+) and (-) signs of the battery compartment.
- Do not mix battery types.
- Do not combine a new battery with the used one. It causes shorter life or leakage of batteries.
- Remove the dead batteries immediately to prevent them from liquid leaking in the battery compartment. Do not touch exposed battery acid, as it can damage your skin.

🔪 NOTE: If you do not intend to use the remote control for a long period, remove the batteries.

Handling the remote control

Refer to these safety tips for properly handling the remote control and the batteries:

- Do not subject to strong shock.
- Do not allow water or other liquid to splash the remote control. If the remote control gets wet, wipe it dry immediately.
- Avoid exposure to heat and steam.
- Open the remote control to install the batteries only.

Operating range of the remote control

Point the top of the remote control toward the IR sensor of the monitor during button operation.

Use the remote control within a straight distance of about 8 m from IR sensor or at a horizontal angle of 120° and vertical angle of 30° within a distance of about 5.6 m.

NOTE: The remote control may not function properly when the IR sensor on the monitor is under direct sunlight or strong illumination, or when there is an obstacle in the path of signal transmission.

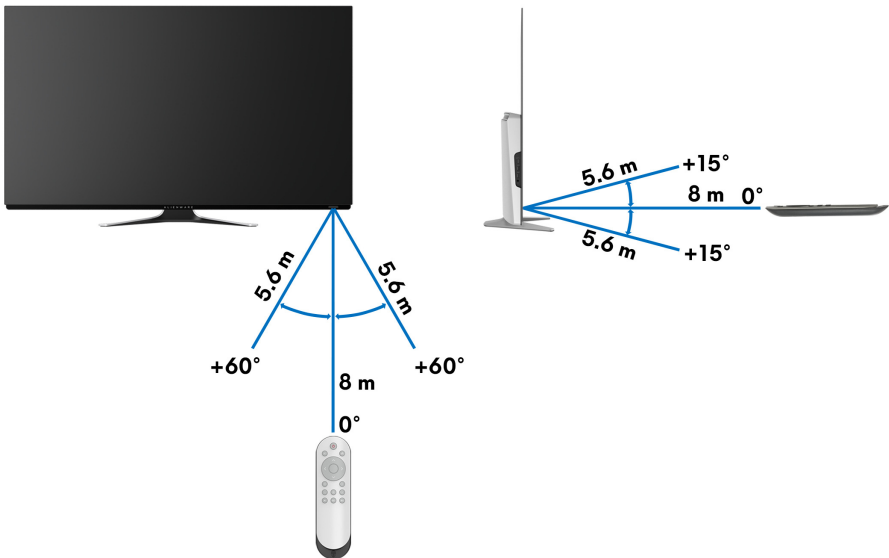

Operating the monitor

Power on the monitor

Press the power button on the monitor or remote control to turn on the monitor.

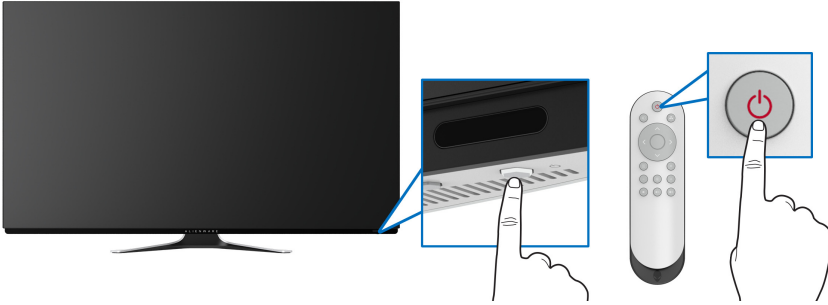





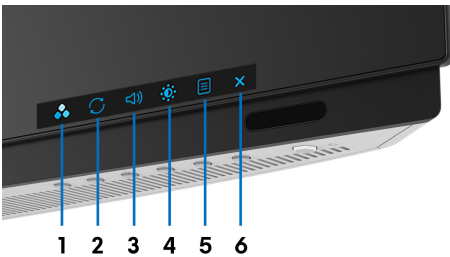

Using the front-panel controls

Use the control buttons on the front of the monitor to access the OSD menu and shortcut keys.



The following table describes the front-panel buttons:

Front-panel button	Description
1  Shortcut key/ Preset Modes	To specify a desired color mode from a preset list.
2  Shortcut key/ AMD FreeSync Premium	To directly access the AMD FreeSync Premium menu.





3		To directly access the Volume adjustment slider.
	Shortcut key/ Volume	
4		To directly access the Brightness/Contrast adjustment sliders.
	Shortcut key/ Brightness/ Contrast	
5		To launch the On-Screen Display (OSD). See Accessing the menu system .
	Menu	
6		To exit the OSD main menu.
	Exit	

Front-panel button

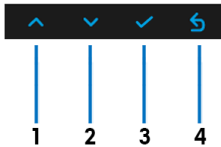
Use the buttons on the front of the monitor to adjust the display settings.

 **NOTE: If you use the remote control to access the OSD menu, the directional buttons illustrated below will not appear on the screen.**



Front-panel button	Description
1  Up	To move up or increase a value in the OSD menu.
2  Down	To move down or decrease a value in the OSD menu.
3  OK	To confirm your selection.
4  Back	To go back to the previous menu.

Using the On-Screen Display (OSD) menu

Accessing the menu system

NOTE: If you change the settings and then either proceed to another menu or exit the OSD menu, the monitor automatically saves those changes. The changes are also saved if you change the settings and then wait for the OSD menu to disappear.

1. Press the **Menu** button on the monitor or remote control to display the main menu.

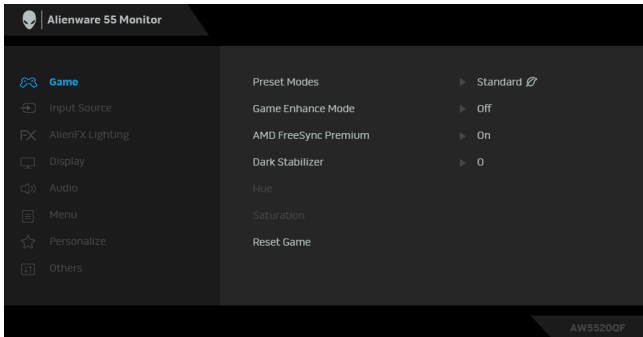

2. Use the up or down buttons to move between the setting options. As you move from one icon to another, the option name is highlighted.
3. Use the right button to enter the submenu.
4. Use the directional buttons to make your changes.
5. Press the **OK** button to confirm your changes.
6. Press the **Back** or left button to return to the previous menu, or press the **Exit** button to close the OSD menu.

NOTE: See the following table for a complete list of the options available for the monitor.

NOTE: If you use the remote control to access the OSD menu, the directional buttons below the menu will not appear on the screen.

Icon**Menu and submenus****Description****Game**

Use this menu to personalize your visual gameplay experience.

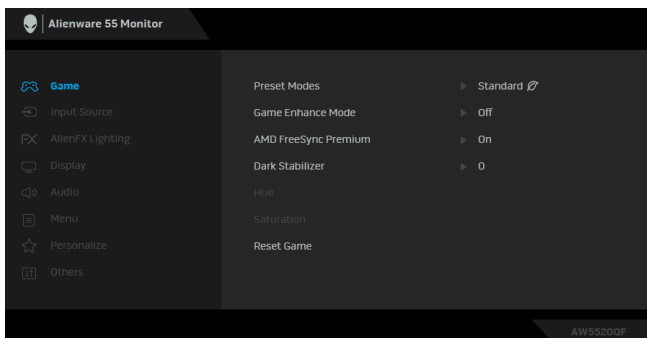

Preset Modes Allows you to choose from a list of preset color modes.

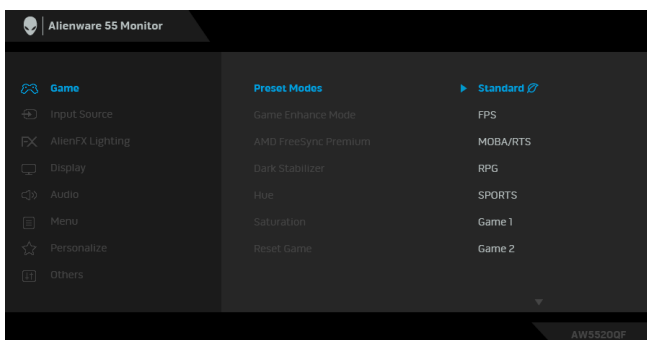

- **Standard:** Loads the monitor's default color settings. This is the default preset mode.
- **FPS:** Loads color settings ideal for First-Person Shooter (FPS) games.
- **RPG:** Loads color settings ideal for Role-Playing Games (RPG).
- **MOBA/RTS:** Loads color settings ideal for Multiplayer Online Battle Arena (MOBA) and Real-Time Strategy (RTS) games.

-
- Preset Modes**
- **SPORTS:** Loads color settings ideal for sports games.
 - **Game 1/Game 2/Game 3:** Allows you to customize the color settings for your gaming needs.
 - **ComfortView:** Decreases the level of blue light emitted from the screen to make viewing more comfortable for your eyes.

WARNING: The possible long-term effects of blue light emission from the monitor may cause personal injury such as digital eye strain, eye fatigue and damage to the eyes. Using monitor for extended periods of time may also cause pain in parts of body such as neck, arm, back and shoulder.

To reduce the risk of eye strain and neck/arm/back/shoulder pain from using the monitor for long periods of time, we suggest you to:

1. Set the distance of the screen between 20 inches to 28 inches (50 cm-70 cm) from your eyes.
 2. Blink frequently to moisten your eyes or wet your eyes with water after prolonged usage of the monitor.
 3. Take regular and frequent breaks for 20 minutes every two hours.
 4. Look away from your monitor and gaze at a distant object at 20 feet away for at least 20 seconds during the breaks.
 5. Perform stretches to relieve tension in the neck, arm, back, and shoulders during the breaks.
- **Warm:** Presents colors at lower color temperatures. The screen appears warmer with a red/yellow tint.
 - **Cool:** Presents colors at higher color temperatures. The screen appears cooler with a blue tint.
 - **Custom Color:** Allows you to manually adjust the color settings. Use the directional buttons (up and down) to adjust the **Gain**, **Offset**, **Hue**, and **Saturation** values and create your own preset color mode.
-

Game Enhance Mode

The feature offers three available functions to enhance your gameplay experience.

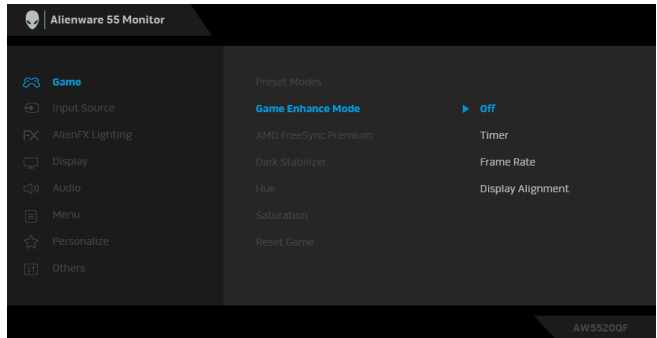

- **Off**

Select to disable the functions under **Game Enhance Mode**.

- **Timer**

Allows you to disable or enable the timer at the upper left corner of the display. The timer shows the time elapsed since the game starts. Select an option from the time-interval list to keep you aware of the remaining time.

- **Frame Rate**

Selecting **On** allows you to display the current frames per second when playing games. The higher the rate, the smoother the motion appears.

- **Display Alignment**

Activate the function to help ensure the perfect alignment of the video contents from multiple displays.

AMD FreeSync Premium

When you select **On**, the monitor runs at the highest frame rate possible to eliminate both input lag and screen tearing, delivering smoother gameplay.

Dark Stabilizer The feature improves the visibility in the dark gaming scenarios. The higher the value (between 0 to 3), the better visibility in dark area of the display image.

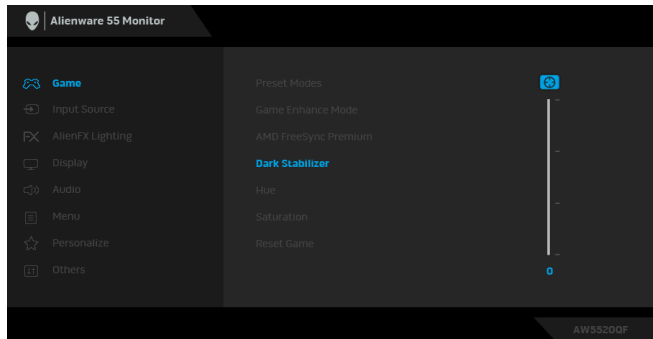

NOTE: The function is not available if **Smart HDR** is activated.

Hue This feature can shift the color of the video image to green or purple. This is used to adjust the desired flesh-tone color. Use the directional buttons (up and down) to adjust the hue level from 0 to 100.

Use the Up button to increase the green shade of the video image.

Use the Down button to increase the purple shade of the video image.

NOTE: The **Hue** adjustment is available only when you select **FPS, MOBA/RTS, SPORTS, or RPG** preset mode.

Saturation This feature can adjust the color saturation of the video image. Use the directional buttons (up and down) to adjust the saturation level from 0 to 100.

Use the Up button to increase the colorful appearance of the video image.

Use the Down button to increase the monochrome appearance of the video image.

NOTE: The **Saturation** adjustment is available only when you select **FPS, MOBA/RTS, SPORTS, or RPG** preset mode.

Reset Game Resets all settings under the **Game** menu to the factory defaults.



Input Source

Use the **Input Source** menu to select between the different video signals that may be connected to your monitor.

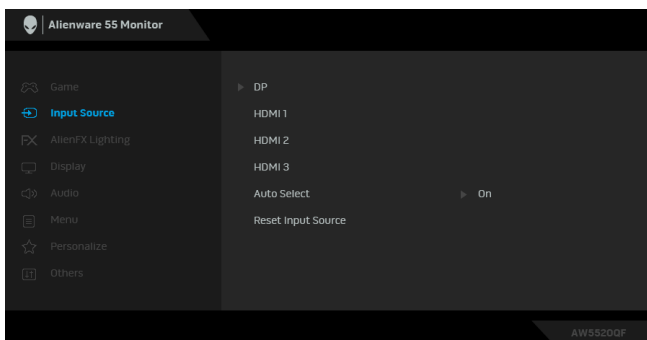

DP

Select the **DP** input when you are using the DisplayPort (DP) connector. Press the **OK** button to confirm the selection.

HDMI 1

Select the **HDMI 1**, **HDMI 2**, or **HDMI 3** input when you are using the HDMI connectors. Press the **OK** button to confirm the selection.

HDMI 2

HDMI 3

Auto Select

Turn on the function to allow the monitor to automatically scan for available input sources.

Reset Input Source

Resets all settings under the **Input Source** menu to the factory defaults.



AlienFX Lighting

Use this menu to adjust the LED light settings for the Power button, Alienware logo, and the light stripe on the I/O cover.

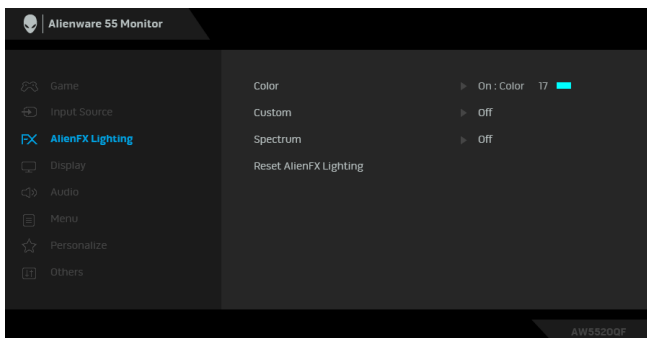

Color

To specify an LED lighting color, select **On** and move down to highlight the **Custom Color** option.

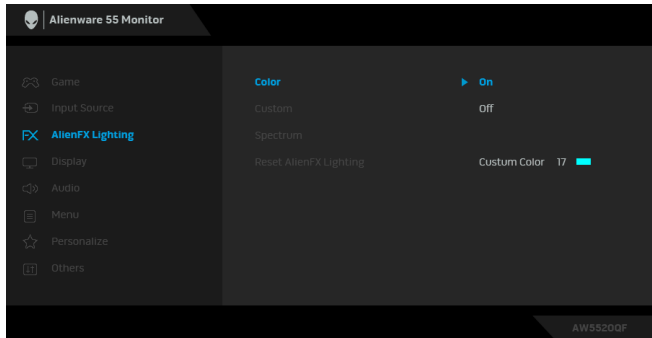

Then you can make a selection from the list of 20 available colors.

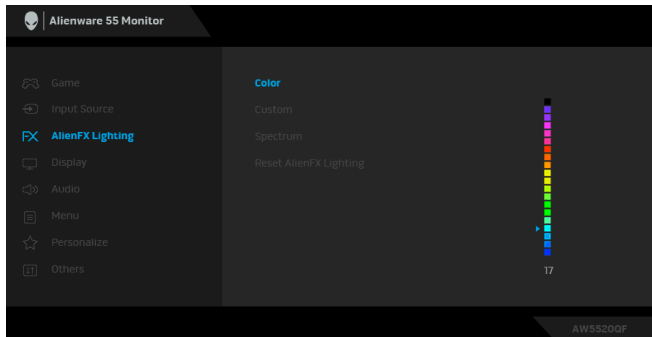

The following table depicts the color number and the RGB codes used for the 20 LED colors.

No.	R	G	B
1	0	0	0
2	100	0	240
3	144	0	240
4	240	0	240
5	240	0	176
6	240	0	112
7	240	0	0
8	240	80	0
9	240	128	0
10	240	224	0
11	120	240	0
12	160	240	0
13	100	245	35
14	0	240	0
15	0	240	85
16	70	240	145
17	0	240	240
18	0	160	240
19	0	96	240
20	0	0	240

To turn off the LED lighting function, select **Off**.

NOTE: The function is only available when **Spectrum** is disabled.

Custom

It is a read-only menu. When you use **Color** or/and **Spectrum** to make LED lighting adjustments, this menu status shows **Off**; when you make the LED lighting adjustments through AlienFX application, the status will change to **On**.

Spectrum

When you select **On**, the LED lighting glows and changes colors in the sequence of the color spectrum: red, orange, yellow, green, blue, indigo, and violet.

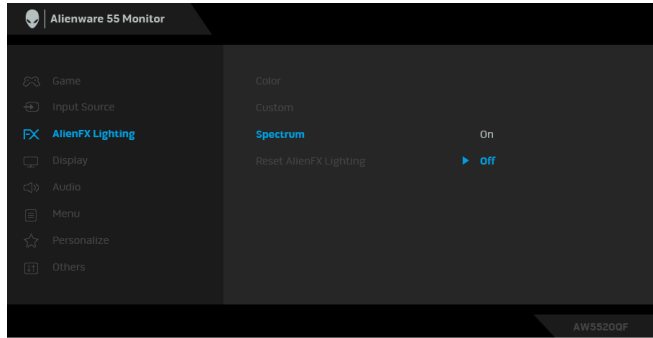

Reset AlienFX Lighting

Resets all settings under the **AlienFX Lighting** menu to the factory defaults.



Display

Use **Display** to adjust images.

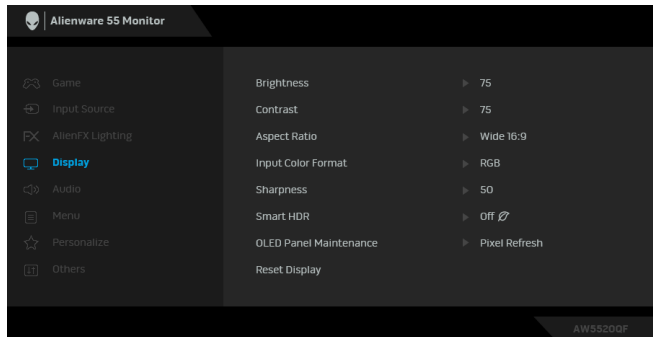

Brightness

Brightness adjusts the luminance of display.

Use the directional buttons (up and down) to increase or decrease the brightness level (min. 0/max. 100).

Contrast

Adjust **Brightness** first, and then adjust **Contrast** only if further adjustment is necessary.

Use the directional buttons (up and down) to increase or decrease the contrast level (min. 0/max. 100).

The **Contrast** function adjusts the degree of difference between darkness and lightness on the monitor screen.

Aspect Ratio	Adjusts the image ratio to Wide 16:9 , Auto Resize , 4:3 , or 1:1 .
Input Color Format	Allows you to set the video input mode to: RGB: Select this option if your monitor is connected to a computer (or media player) using the DP or HDMI cable. YPbPr: Select this option if your media player supports only YPbPr output.
Sharpness	This feature can make the image look sharper or softer. Use the directional buttons (up and down) to increase or decrease the sharpness level from 0 to 100.
Smart HDR	The Smart HDR (High Dynamic Range) menu enhances the display output by optimally adjusting contrast and the ranges of color and luminosity to resemble true-to-life visuals. The default setting is Off . You may set the Smart HDR mode to: <ul style="list-style-type: none">▪ Desktop: Suitable for using the monitor with a desktop computer.▪ Movie HDR: Suitable for the playback of HDR video content.▪ Game HDR: Suitable for playing HDR-compatible games. It displays more realistic scenes and makes the gaming experience immersive and entertaining.▪ Reference: Displays OLED panel's native color gamut. NOTE: When the monitor is processing HDR content, Preset Modes and Brightness will be disabled.

OLED Panel Maintenance

The **OLED Panel Maintenance** menu prevents the screen from image retention by offering these functions:

- **Pixel Refresh:** To reduce temporary image retention on the screen, you can manually activate this function after using the monitor for a long period of time. Alternatively, the function will activate automatically when you have used the monitor for several hours. The process takes approximately 5 minutes to complete.

NOTE: The power LED indicator flashes green during the refresh process.

- **Panel Refresh:** To prevent permanent image retention caused by static content when you use the monitor for a long period of time, you can manually activate this function to refresh the pixels. Alternatively, the function will activate automatically when the accumulated usage time exceeds the factory default setting. The process takes approximately an hour to complete.

NOTE: The power LED indicator flashes green and then turns to blinking red during the refresh process.

Reset Display

Resets all settings under the **Display** menu to the factory defaults.



Audio

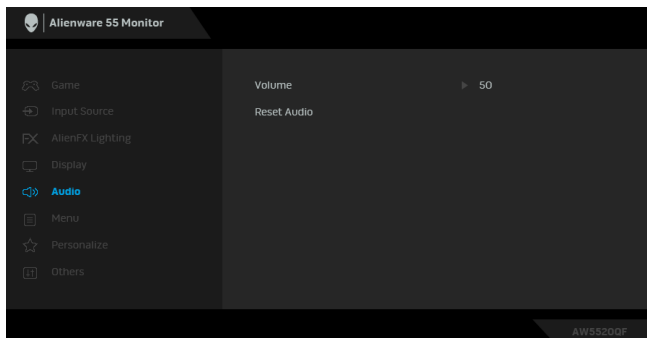

Volume

Allows you to set the volume level of headphone and speaker output.

Use the directional buttons (up and down) to adjust the volume level from 0 to 100.

Reset Audio

Resets all settings under the **Audio** menu to the factory defaults.



Menu

Select this option to adjust the settings of the OSD, such as, the languages of the OSD, the amount of time the menu remains on screen, and so on.

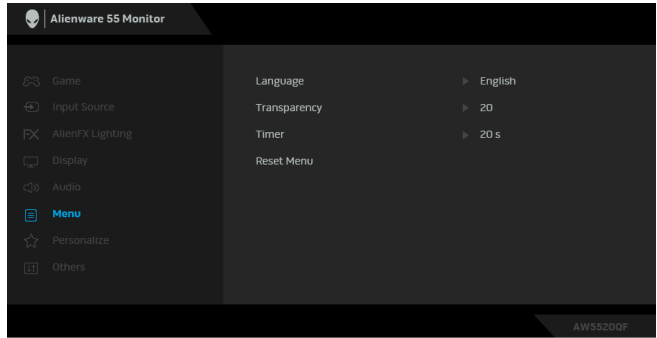

Language Sets the OSD display to one of the eight languages (English, Spanish, French, German, Brazilian Portuguese, Russian, Simplified Chinese, or Japanese).

Transparency Use the directional buttons (up and down) to change the menu transparency (min. 0/max. 100).

Timer Sets the length of time for the OSD to remain active after you press a button.
Use the directional buttons (up and down) to adjust the slider in 1 second increments, from 5 to 60 seconds.

Reset Menu Resets all settings under the **Menu** menu to the factory defaults.



Personalize

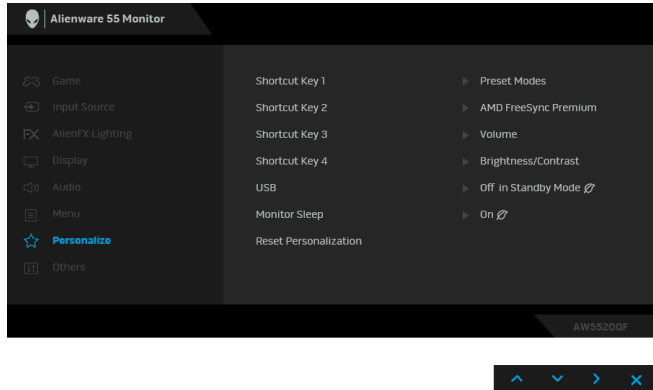

-
- Shortcut Key 1** Allows you to choose a feature from **Preset Modes, Game Enhance Mode, AMD FreeSync Premium, Dark Stabilizer, Brightness/Contrast, Input Source, Aspect Ratio, Volume,** or **Smart HDR** and set it as a shortcut key.
 - Shortcut Key 2**
 - Shortcut Key 3**
 - Shortcut Key 4**
-

USB Allows you to enable or disable USB function during monitor standby mode.

NOTE: USB ON/OFF under standby mode is only available when the USB upstream cable is unplugged. This option will be greyed out when the USB upstream cable plugs in.

Monitor Sleep Allows you to let the monitor turn off automatically or stay on when your computer goes into sleep mode. When **On** is selected, the monitor goes to standby mode as the system sleeps; when **Off** is selected, you may prevent the screen from going off as the system sleeps for speedy display recovery from PC wake up.

Reset Personalization Resets all settings under the **Personalize** menu to the factory defaults.



Others

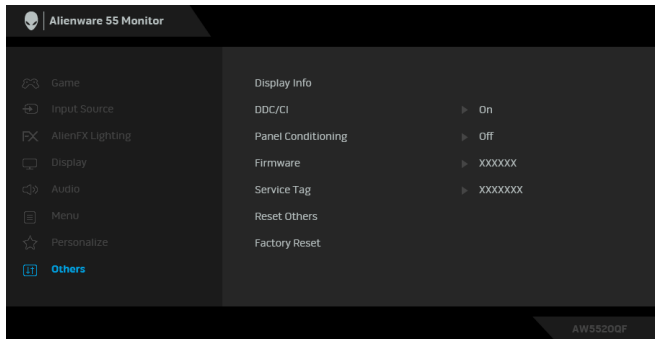

Display Info

Displays the monitor's current settings.

DDC/CI

DDC/CI (Display Data Channel/Command Interface) allows your monitor parameters (brightness, color balance, and etc.) to be adjustable via the software on your computer.

You can disable this feature by selecting **Off**.

Enable this feature for best user experience and optimum performance of your monitor.

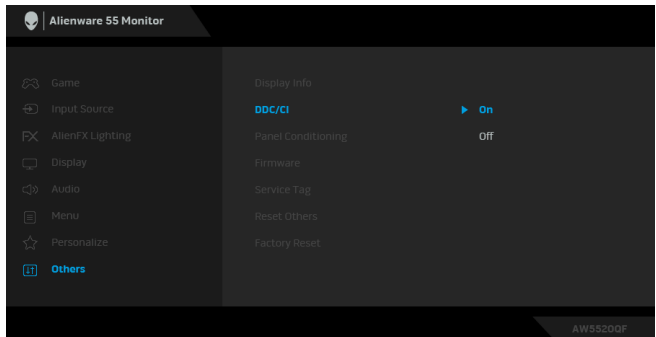

Panel Conditioning

Helps reduce minor cases of image retention. Depending on the degree of image retention, the program may take some time to run. You can enable this feature by selecting **On**.

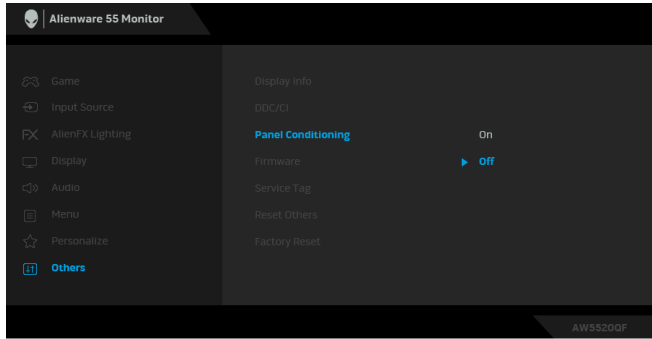

Firmware Displays the firmware version of your monitor.

Service Tag Displays the service tag of your monitor. This string is required when you look for phone support, check your warranty status, update drivers on Dell's website, etc.

Reset Others Resets all settings under the **Others** menu to the factory defaults.

Factory Reset Resets all OSD settings to the factory defaults.

OSD warning message

When the monitor does not support a particular resolution mode, you will see the following message:

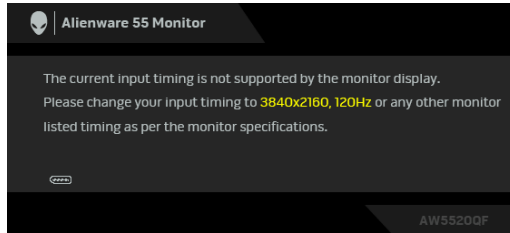

or

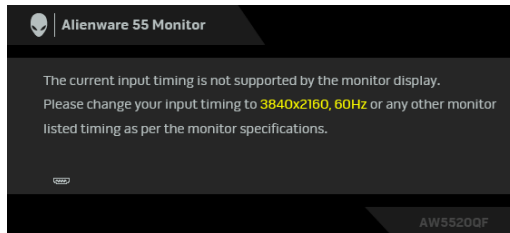

NOTE: The message may be slightly different according to the connected input signal.

This means that the monitor cannot synchronize with the signal that it is receiving from the computer. See [Monitor specifications](#) for the Horizontal and Vertical frequency ranges addressable by this monitor. Recommended mode is 3840 x 2160.

When you adjust the **Brightness** level above the default level for the first time, the following message appears:

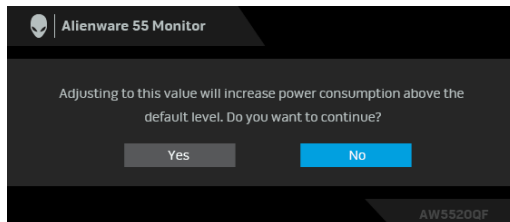

NOTE: If you select Yes, the message will not appear next time when you intend to change the Brightness setting.

When you change the default setting of power saving features for the first time, such as **Preset Modes**, **Smart HDR**, **USB**, or **Monitor Sleep**, the following message appears:

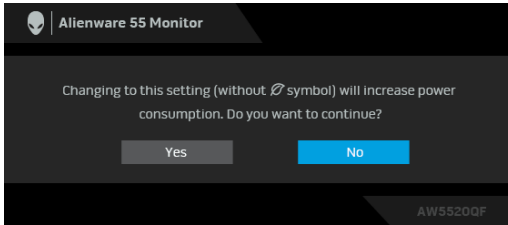

NOTE: If you select **Yes** for either of the features mentioned above, the message will not appear next time when you intend to change the settings of these features. When you perform a factory reset, the message will appear again.

You will see the following message before the **DDC/CI** function is disabled:

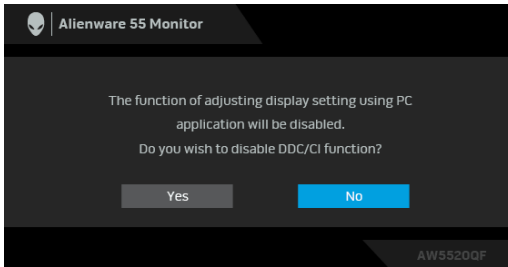

When **Smart HDR** is activated and you try to change the preset mode, the following message appears:

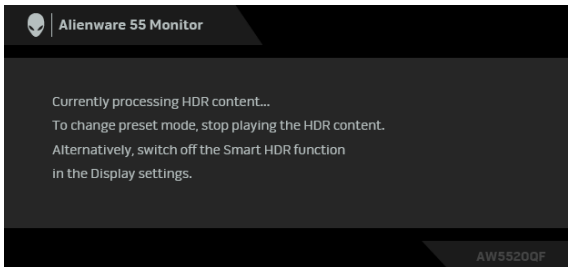

When the monitor goes into Standby mode, the following message appears:

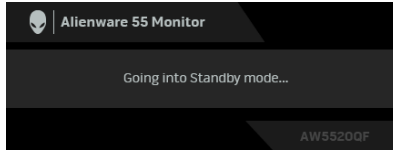

Activate the computer and wake up the monitor to gain access to the **OSD**.

NOTE: The message may be slightly different according to the connected input signal.

The OSD functions only in the normal operation mode. If you press any button other than the power button during the Standby mode, the following message will appear depending on the selected input:

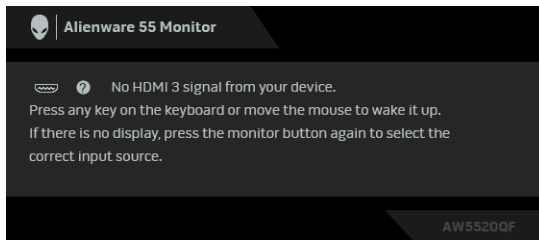

NOTE: The message may be slightly different according to the connected input signal.

If either HDMI or DP input is selected and the corresponding cable is not connected, a floating dialog box as shown below appears:

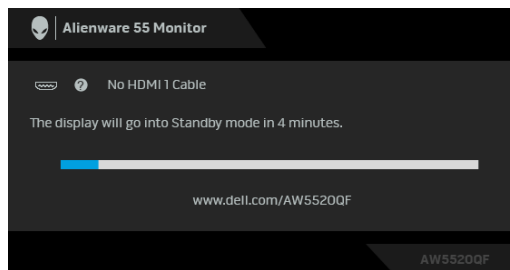

NOTE: The message may be slightly different according to the connected input signal.

When **Pixel Refresh** is selected, the following message appears:

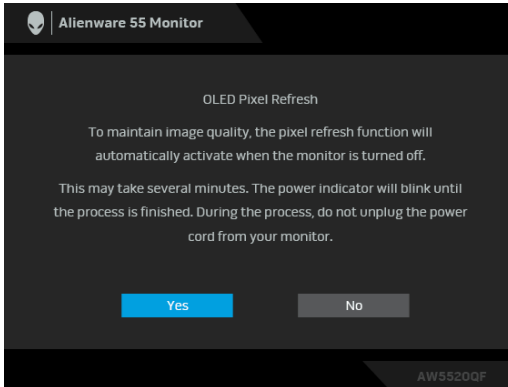

Select **Yes**, and the refresh process will run automatically after the monitor is turned off. The process takes approximately 5 minutes to complete.

When **Panel Refresh** is selected, the following message appears:

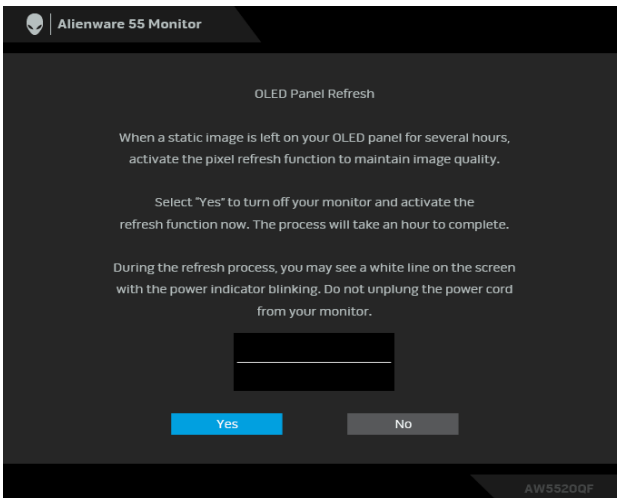

Select **Yes**, and the refresh process will run automatically. The process takes approximately an hour to complete.

If you press any button other than the power button on the monitor or remote control during the process of running **Pixel Refresh** or **Panel Refresh**, the following message appears:

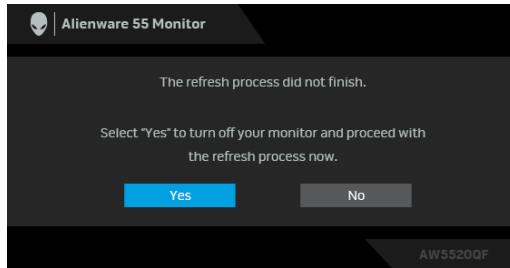

NOTE: If you press the **Power** key on the monitor or remote control during the process of running **Pixel Refresh** or **Panel Refresh**, the monitor will be turned off. Next time when you turn on the monitor, the dialog box shown above will reappear to notify you about continuing the refresh process.

When **Factory Reset** is selected, the following message appears:

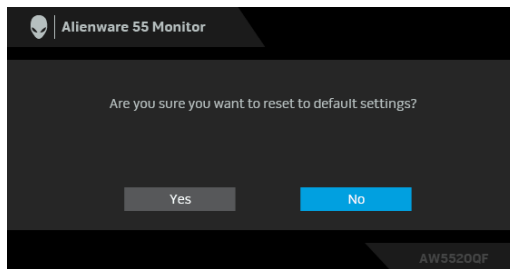

See [Troubleshooting](#) for more information.

Setting the maximum resolution

To set the maximum resolution for the monitor:

In Windows 7, Windows 8, and Windows 8.1:

1. For Windows 8 and Windows 8.1 only, select the Desktop tile to switch to classic desktop.
2. Right-click on the desktop and click **Screen Resolution**.
3. Click the Dropdown list of the Screen Resolution and select **3840 x 2160**.
4. Click **OK**.

In Windows 10:

1. Right-click on the desktop and click **Display settings**.
2. Click **Advanced display settings**.
3. Click the dropdown list of **Resolution** and select **3840 x 2160**.
4. Click **Apply**.

If you do not see 3840 x 2160 as an option, you may need to update your graphics driver. Depending on your computer, complete one of the following procedures:

If you have a Dell desktop or a laptop:

- Go to **www.dell.com/support**, enter your service tag, and download the latest driver for your graphics card.

If you are using a non-Dell computer (laptop or desktop):

- Go to the support site for your computer and download the latest graphic drivers.
- Go to your graphics card website and download the latest graphic drivers.

Requirements to view or playback HDR content

1. via Ultra BluRay DVD or Game consoles

Ensure the DVD player and Game consoles are HDR capable, e.g. Panasonic DMP-UB900, x-Box One S, PS4 Pro. Download and install the appropriate graphics card drivers (for PC applications), see below.

2. via PC

Ensure the graphics card used is HDR capable, i.e., HDMI2.0a (with HDR option) compliant and HDR graphics driver is installed. HDR capable player application must be used, e.g. Cyberlink PowerDVD 17, Windows 10 Movies and TV app.

For example Dell XPS 8910, Alienware Aurora R5, bundled with the below graphics cards.

Dell Graphics driver with HDR support: Refer to Dell support page to download the latest graphics driver that supports HDR playback for your PC/Notebook.

Nvidia

HDR capable NVIDIA graphics cards: GTX1070, GTX1080, P5000, P6000, etc. For a full range of HDR capable NVIDIA graphics cards, refer to NVIDIA website www.nvidia.com

Driver that supports Full Screen Playback mode (e.g. PC games, UltraBluRay players), HDR on Win 10 Redstone 2 OS: 381.65 or later.

AMD

HDR capable AMD graphics cards: RX480, RX470, RX460, WX7100, WX5100, WX4100, etc. For a full range of HDR capable AMD graphics cards, refer to www.amd.com. Check HDR driver support information and download the latest driver from www.amd.com

Intel (Integrated Graphics)

- HDR capable system: CannonLake or later
- Suitable HDR player: Windows 10 Movies and TV app
- OS with HDR support: Windows 10 Redstone 3
- Driver with HDR support: visit downloadcenter.intel.com for the latest HDR driver

 **NOTE: HDR playback via OS (e.g. playback of HDR in a window within desktop) requires Win 10 Redstone 2 or later with appropriate player applications, e.g. PowerDVD17. Playing back protected content will require appropriate DRM software and/or hardware, e.g. Microsoft Playready™. Refer to Microsoft website for HDR support information.**

Using AlienFX application

You can configure the LED lighting effects across multiple distinct zones on your Alienware monitor through AlienFX in AWCC (Alienware Command Center).

 **NOTE: If you have an Alienware Gaming Desktop or Laptop, you can directly access AWCC to control the lightings.**

 **NOTE: For more information, see Alienware Command Center Online Help.**

Prerequisites

Before installing the AWCC on a non-Alienware system:

- Ensure the OS of your computer is Windows 10 R3 or later.
- Ensure your internet connection is active.
- Ensure that the supplied USB cable is connected to both the Alienware monitor and the computer.

Installing AWCC through Windows update

1. The AWCC application is downloaded and will be automatically installed. The installation takes a few minutes to complete.
2. Navigate to the program folder to ensure that the installation is successful. Alternatively, you can find the AWCC application in the **Start** menu.
3. Launch AWCC and perform the following steps to download the additional software components:
 - In the **Settings** window, click **Windows Update**, and then click **Check for updates** to check the Alienware driver update progress.
 - If the driver update is not responding in your computer, install AWCC from the Dell Support website.

Installing AWCC from the Dell Support website

1. Enter AW5520QF in the query field at www.dell.com/support/drivers and download the latest version of the following items:
 - Alienware Command Center Application
 - Alienware Gaming Monitor Control Center Driver
2. Navigate to the folder in which you saved the setup files.
3. Double-click the setup file and follow the on-screen instructions to complete the installation.

Navigating the AlienFX window

With the Alienware Command Center, AlienFX allows you to control the LED lighting colors and transition effects for your Alienware monitor.

In the AWCC home screen, click **FX** in the top menu bar to access the home screen of AlienFX.



The following table describes the functions and features on the home screen:

No.	Functions	Descriptions
A	CREATE NEW THEME...	Click + and then enter a name in the text box to add a theme.
B	Edit controls	<ul style="list-style-type: none"> • EDIT: Provides options for you to customize lighting settings for your theme. • GO DIM: Makes the light dimmer. • GO DARK: Turns off the light.
C	Theme components	You can use these components (LIGHTING , MACROS , SETTINGS) to make the selected theme as an active theme.
D	THEMES list	Displays the themes in list view or grid view.
E	Background controls	Adjusts the background animation effects.
F	Help	Click it to access the AWCC Online Help.
G	Window controls	You can use the buttons to minimize, maximize, or restore the size of the window. When × is selected, the application will close.

When you start to customize a theme, you should see the following screen:

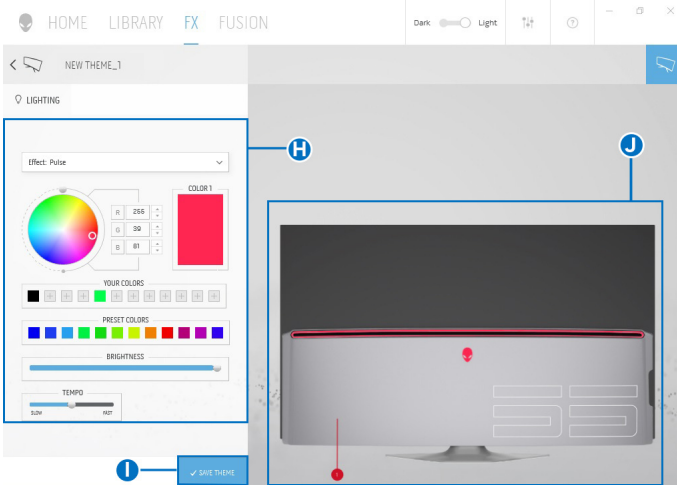

The following table describes the functions and features on the screen:

No.	Functions	Descriptions
H	LIGHTING panel	Use the controls in this panel to set up lighting effects for a theme. See Setting lighting effects for details.
I	SAVE THEME	Click to save all adjustments and changes for the theme.
J	Live preview	The lighting zones are with numbered callouts. You may select a single zone by clicking the number on the image. When you make lighting adjustments, the preview of the monitor displays the new effects simultaneously.

Creating a theme

To create a theme with your preferred lighting settings:

1. Launch AWCC.
2. Click **FX** in the top menu bar to access the home screen of AlienFX.
3. In the top-left corner of the window, click  to create a new theme.
4. In the **CREATE NEW THEME** text box, type the theme name.
5. Specify the lighting zone(s) for which you want to make lighting adjustments by:
 - selecting the zone check box(es) above the live preview area, or
 - clicking the numbered callout on the image of monitor
6. In the **LIGHTING** panel, select your preferred lighting effects from the drop-down list, including **Morph**, **Pulse**, **Color**, **Spectrum**, and **Breathing**. See [Setting lighting effects](#) for details.

 **NOTE: The Spectrum option is only available when you select All Zones to make lighting adjustments.**

7. Repeat step 5 and step 6 to make more configuration options available to your preference.
8. When done, click **SAVE THEME**. A toast notification appears in the right-bottom corner of the screen.

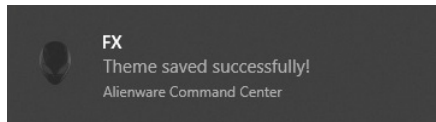

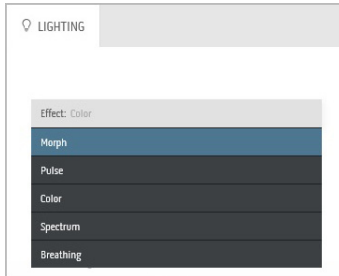

Setting lighting effects

The **LIGHTING** panel provides various lighting effects. You may click **Effect** to open a drop-down menu with available options.

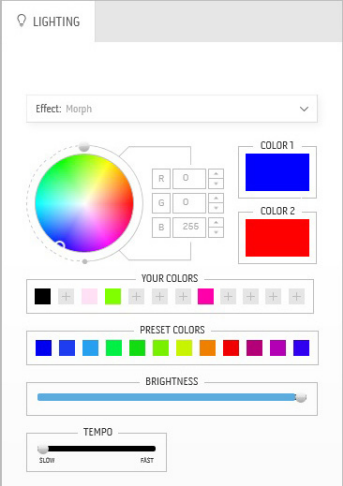

 **NOTE:** The options displayed may vary depending on the lighting zone(s) you specified.

The following table provides an overview of different options:

Morph	Descriptions
 A detailed screenshot of the 'LIGHTING' panel with the 'Morph' effect selected. The panel includes a color wheel, RGB input fields (R: 0, G: 0, B: 255), two color selection boxes labeled 'COLOR 1' (blue) and 'COLOR 2' (red), a 'YOUR COLORS' palette, a 'PRESET COLORS' palette, a 'BRIGHTNESS' slider, and a 'TEMPO' slider with 'SLOW' and 'FAST' markers.	<p>The effect changes the light color into another through a seamless transition.</p> <p>To make the adjustments:</p> <ol style="list-style-type: none">1. Pick a preferred color from the color palette or the list of PRESET COLORS. The selected color and its RGB color codes will be displayed on the right field. <p>NOTE: To change the color, use the up and down arrow buttons beside the R/G/B boxes to edit the color codes.</p> <ol style="list-style-type: none">2. To add the selected color to the list of YOUR COLORS for quick access in the future, click . At most 12 colors can be added to the list. <p>NOTE: To remove an existing color chip from the list, right-click on it.</p> <ol style="list-style-type: none">3. Repeat the previous steps to specify Color 2 to be the ending light color.4. Drag the BRIGHTNESS slider to adjust the lightness of the color.5. Drag the TEMPO slider to adjust the transition speed.

Pulse

Descriptions

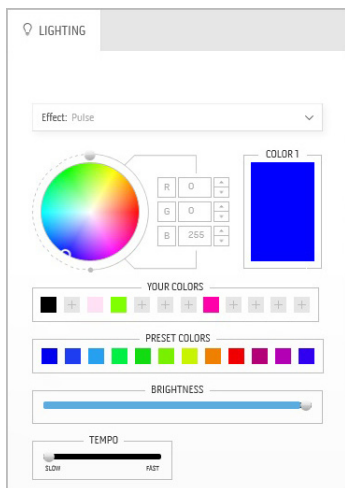

The effect makes the light flash with a short pause.

To make the adjustments:

1. Pick a preferred color from the color palette or the list of **PRESET COLORS**. The selected color and its RGB color codes will be displayed on the right field.

NOTE: To change the color, use the up and down arrow buttons beside the R/G/B boxes to edit the color codes.

2. To add the selected color to the list of **YOUR COLORS** for quick access in the future, click . At most 12 colors can be added to the list.

NOTE: To remove an existing color chip from the list, right-click on it.

3. Drag the **BRIGHTNESS** slider to adjust the lightness of the color.
4. Drag the **TEMPO** slider to adjust the pulsing speed.

Color

Descriptions

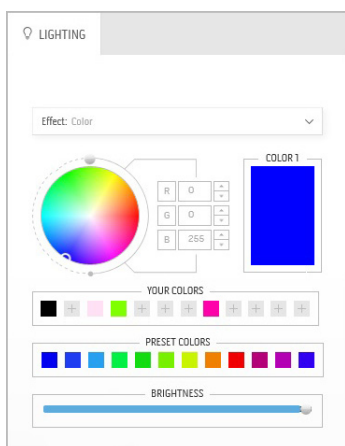

The effect makes the LED light in a single static color.

To make the adjustments:

1. Pick a preferred color from the color palette or the list of **PRESET COLORS**. The selected color and its RGB color codes will be displayed on the right field.

NOTE: To change the color, use the up and down arrow buttons beside the R/G/B boxes to edit the color codes.

2. To add the selected color to the list of **YOUR COLORS** for quick access in the future, click . At most 12 colors can be added to the list.

NOTE: To remove an existing color chip from the list, right-click on it.

3. Drag the **BRIGHTNESS** slider to adjust the lightness of the color.

Spectrum

Descriptions

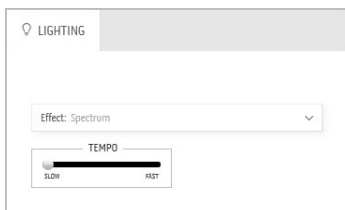

The effect makes the light change in sequence of spectrum: red, orange, yellow, green, blue, indigo, and violet.

You can drag the **TEMPO** slider to adjust the transition speed.

NOTE: The option is available only when you select **All Zones** to make lighting adjustments.

Breathing

Descriptions

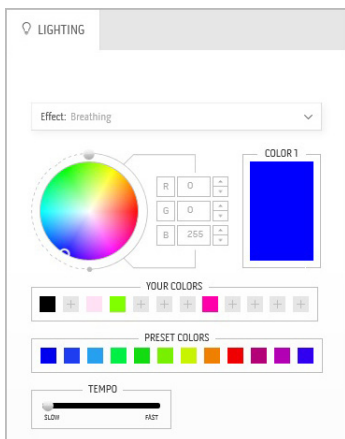

The effect makes the light change from bright to dim.

To make the adjustments:

1. Pick a preferred color from the color palette or the list of **PRESET COLORS**. The selected color and its RGB color codes will be displayed on the right field.

NOTE: To change the color, use the up and down arrow buttons beside the R/G/B boxes to edit the color codes.

2. To add the selected color to the list of **YOUR COLORS** for quick access in the future, click . At most 12 colors can be added to the list.
 3. Drag the **TEMPO** slider to adjust the transition speed.
-

Troubleshooting

⚠ WARNING: Before you begin any of the procedures in this section, follow the [Safety instructions](#).

Self-test

Your monitor provides a self-test feature that allows you to check whether your monitor is functioning properly. If your monitor and computer are properly connected but the monitor screen remains dark, run the monitor self-test by performing the following steps:

1. Turn off both your computer and the monitor.
2. Unplug the video cable from the back of the computer. To ensure proper Self-Test operation, remove all digital cables from the back of computer.
3. Turn on the monitor.

✎ NOTE: A dialog box should appear on-screen (against a black background), if the monitor cannot sense a video signal and is working correctly. While in self-test mode, the power LED blinks blue (default color).

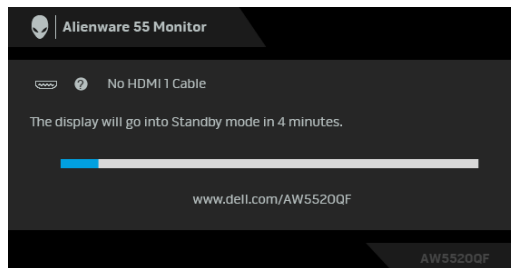

✎ NOTE: This box also appears during normal system operation, if the video cable is disconnected or damaged.

4. Turn off your monitor and reconnect the video cable; then turn on both your computer and the monitor.

If your monitor screen remains blank after you use the previous procedure, check your video controller and computer, because your monitor is functioning properly.

Built-in diagnostics

Your monitor has a built-in diagnostic tool that helps you determine if the screen abnormality you are experiencing is an inherent problem with your monitor, or with your computer and video card.

NOTE: You can run the built-in diagnostics only when the video cable is unplugged and the monitor is in self-test mode.

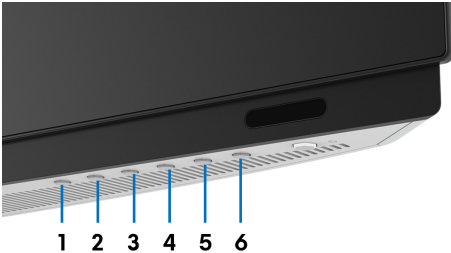

To run the built-in diagnostics:

1. Ensure that the screen is clean (no dust particles on the surface of the screen).
2. Unplug the video cable(s) from the back of the computer or monitor. The monitor then goes into the self-test mode.
3. Press and hold **Button 3** for 5 seconds. A gray screen appears after 1 second.
4. Carefully inspect the screen for abnormalities.
5. Press **Button 3** again. The color of the screen changes to red.
6. Inspect the display for any abnormalities.
7. Repeat steps 5 and 6 to inspect the display in green, blue, black, white, and text screens.

The test is complete when the text screen appears. To exit, press **Button 3** again. If you do not detect any screen abnormalities upon using the built-in diagnostic tool, the monitor is functioning properly. Check the video card and computer.

Common problems

The following table contains general information about common monitor problems you might encounter and the possible solutions:

Common symptoms	What you experience	Possible solutions
No Video/ Power LED off	No picture	<ul style="list-style-type: none">• Ensure that the video cable connecting the monitor and the computer is properly connected and secure.• Verify that the power outlet is functioning properly using any other electrical equipment.• Ensure that the power button is depressed fully.• Ensure that the correct input source is selected in the Input Source menu.
No Video/ Power LED on	No picture or no brightness	<ul style="list-style-type: none">• Increase brightness and contrast controls in the Display menu.• Perform monitor self-test feature check.• Check for bent or broken pins in the video cable connector.• Run the built-in diagnostics.• Ensure that the correct input source is selected in the Input Source menu.
Poor Focus	Picture is fuzzy, blurry, or ghosting	<ul style="list-style-type: none">• Eliminate video extension cables.• Reset the monitor to factory settings.• Change the video resolution to the correct aspect ratio.
Shaky/Jittery Video	Wavy picture or fine movement	<ul style="list-style-type: none">• Reset the monitor to factory settings.• Check environmental factors.• Relocate the monitor and test in another room.
Missing Pixels	OLED screen has spots	<ul style="list-style-type: none">• Cycle power On-Off.• Pixel that is permanently off is a natural defect that can occur in OLED technology.• For more information on Dell Monitor Quality and Pixel Policy, see Dell support site: www.dell.com/support/monitors.
Stuck-on Pixels	OLED screen has bright spots	<ul style="list-style-type: none">• Cycle power On-Off.• Pixel that is permanently off is a natural defect that can occur in OLED technology.• For more information on Dell Monitor Quality and Pixel Policy, see Dell support site: www.dell.com/support/monitors.

Brightness Problems	Picture too dim or too bright	<ul style="list-style-type: none"> Reset the monitor to factory settings. Adjust brightness and contrast controls in the Display menu.
Geometric Distortion	Screen not centered correctly	<ul style="list-style-type: none"> Reset the monitor to factory settings.
Horizontal/Vertical Lines	Screen has one or more lines	<ul style="list-style-type: none"> Reset the monitor to factory settings. Perform monitor self-test feature check and determine if these lines are also in self-test mode. Check for bent or broken pins in the video cable connector. Run the built-in diagnostics.
Synchronization Problems	Screen is scrambled or appears torn	<ul style="list-style-type: none"> Reset the monitor to factory settings. Perform monitor self-test feature check to determine if the scrambled screen appears in self-test mode. Check for bent or broken pins in the video cable connector. Restart the computer in the <i>safe mode</i>.
Safety Related Issues	Visible signs of smoke or sparks	<ul style="list-style-type: none"> Do not perform any troubleshooting steps. Contact Dell immediately.
Intermittent Problems	Monitor malfunctions on & off	<ul style="list-style-type: none"> Ensure that the video cable connecting the monitor to the computer is connected properly and is secure. Reset the monitor to factory settings. Perform monitor self-test feature check to determine if the intermittent problem occurs in self-test mode.
Missing Color	Picture missing color	<ul style="list-style-type: none"> Perform monitor self-test feature check. Ensure that the video cable connecting the monitor to the computer is connected properly and is secure. Check for bent or broken pins in the video cable connector.
Wrong Color	Picture color not good	<ul style="list-style-type: none"> Change the settings of the Preset Modes in the Game menu OSD depending on the application. Adjust Gain/Offset/Hue/Saturation value under Custom Color in the Game menu OSD. Run the built-in diagnostics.

Product specific problems

Specific symptoms	What you experience	Possible solutions
Screen image is too small	Image is centered on screen, but does not fill entire viewing area	<ul style="list-style-type: none">Reset the monitor to factory settings.
Cannot adjust the monitor with the buttons on the front panel	OSD does not appear on the screen	<ul style="list-style-type: none">Turn off the monitor, unplug the power cord, plug it back, and then turn on the monitor.The OSD menu may be locked. Press and hold the Menu/function button next to the Power button for 4 seconds to unlock.
No Input Signal when user controls are pressed	No picture, the LED light is off	<ul style="list-style-type: none">Check the signal source. Ensure the computer is not in the power saving mode by moving the mouse or pressing any key on the keyboard.Check whether the signal cable is plugged in properly. Re-plug the signal cable if necessary.Reset the computer or video player.
The picture does not fill the entire screen	The picture cannot fill the height or width of the screen	<ul style="list-style-type: none">Due to different video formats (aspect ratio), the monitor may display in full screen.Run the built-in diagnostics.
Image retention from a static image left on the monitor for a long period of time	Faint shadow from the static image displayed appears on the screen	<ul style="list-style-type: none">Set the screen to turn off after a few minutes of screen idle time. These can be adjusted in Windows Power Options or Mac Energy Saver setting.Alternatively, use a dynamically changing screensaver.
Unevenness in luminance or color of the screen images	Visible spots (bright or dark) or lines or Mura appear on the screen	<ul style="list-style-type: none">Perform the function of Pixel Refresh or Panel Refresh. See OLED Panel Maintenance.

Universal Serial Bus (USB) specific problems

Specific symptoms	What you experience	Possible solutions
USB interface is not working	USB peripherals are not working	<ul style="list-style-type: none">▪ Check that your monitor is turned on.▪ Reconnect the upstream cable to your computer.▪ Reconnect the USB peripherals (downstream connector).▪ Switch off and then turn on the monitor again.▪ Reboot the computer.▪ Some USB devices like external portable HDD require higher electric current; connect the device directly to the computer system.
Super Speed USB 3.0 interface is slow	Super Speed USB 3.0 peripherals working slowly or not working at all	<ul style="list-style-type: none">▪ Check that your computer is USB 3.0-capable.▪ Some computers have USB 3.0, USB 2.0, and USB 1.1 ports. Ensure that the correct USB port is used.▪ Reconnect the upstream cable to your computer.▪ Reconnect the USB peripherals (downstream connector).▪ Reboot the computer.
Wireless USB peripherals stop working when a USB 3.0 device is plugged in	Wireless USB peripherals responding slowly or only working as the distance between itself and its receiver decreases	<ul style="list-style-type: none">▪ Increase the distance between the USB 3.0 peripherals and the wireless USB receiver.▪ Position your wireless USB receiver as close as possible to the wireless USB peripherals.▪ Use a USB-extender cable to position the wireless USB receiver as far away as possible from the USB 3.0 port.

Appendix

WARNING: Safety instructions

 **WARNING: Use of controls, adjustments, or procedures other than those specified in this documentation may result in exposure to shock, electrical hazards, and/or mechanical hazards.**

For information on safety instructions, see the Safety, Environmental, and Regulatory Information (SERI).

FCC notices (U.S. only) and other regulatory information

For FCC notices and other regulatory information, see the regulatory compliance website located at www.dell.com/regulatory_compliance.

Contact Dell

For customers in the United States, call 800-WWW-DELL (800-999-3355).

 **NOTE: If you do not have an active Internet connection, you can find contact information on your purchase invoice, packing slip, bill, or Dell product catalog.**

Dell provides several online and telephone-based support and service options. Availability varies by country and product, and some services may not be available in your area.

- Online technical assistance: www.dell.com/support/monitors
- Contacting Dell: www.dell.com/contactdell

EU product database for energy label and product information sheet

AW5520QF: <https://eprel.ec.europa.eu/qr/347818>