

Simplified Service Manual–U2520DB

Version: 01

Date:2021/03/04

Content Index

1. General Safety Instructions	3
1.1 SAFETY: General Safety	3
1.2 SAFETY: General Power Safety	5
2. Exploded view diagram with list of items	6
3. Wiring connectivity diagram	7
4. Disassembly and Assembly Procedures	8
4.1 Disassembly SOP	8
4.2 Assembly SOP	12
5. Trouble shooting instructions	16

1. General Safety Instructions

Use the following safety guidelines to help ensure your own personal safety and to help protect your equipment and working environment from potential damage.

NOTE: In this section, equipment refers to monitors.

IMPORTANT NOTICE FOR USE IN HEALTHCARE ENVIRONMENTS:

Dell products are not medical devices and are not listed under UL or IEC 60601 (or equivalent). As a result, they must not be used within 6 feet of a patient or in a manner that directly or indirectly contacts a patient

1.1 SAFETY: General Safety

WARNING: To prevent the spread of fire, keep candles or other open flames away from this product at all times.

When setting up the equipment for use:

- Place the equipment on a hard, level surface. Leave 10.2 cm (4 in) minimum of clearance on all vented sides of the computer to permit the airflow required for proper ventilation.
- Restricting airflow can damage the computer or cause a fire.
- Do not stack equipment or place equipment so close together that it is subject to recalculated or preheated air.
- NOTE: Review the weight limits referenced in your computer documentation before placing a monitor or other devices on top of your computer.
- Ensure that nothing rests on your equipment's cables and that the cables are not located where they can be stepped on or tripped over.
- Ensure that all cables are connected to the appropriate connectors. Some connectors have a similar appearance and may be easily confused (for example, do not plug a telephone cable into the network connector).
- Do not place your equipment in a closed-in wall unit or on a bed, sofa, or rug.
- Keep your device away from radiators and heat sources.
- Keep your equipment away from extremely hot or cold temperatures to ensure that it is used within the specified operating range.
- Do not push any objects into the air vents or openings of your equipment. Doing so can cause fire or electric shock by shorting out interior components.
- Avoid placing loose papers underneath your device. Do not place your device in a closed-in wall unit, or on a soft, fabric surface such as a bed, sofa, carpet, or a rug.

When operating your equipment:

- Do not use your equipment in a wet environment, for example, near a bath tub, sink, or swimming pool or in a wet basement.
- Do not use AC powered equipment during an electrical storm. Battery powered devices may be used if all cables have been disconnected.
- Do not spill food or liquids on your equipment.
- Before you clean your equipment, disconnect it from the electrical outlet. Clean your device with a soft cloth dampened with water. Do not use liquids or aerosol cleaners, which may contain flammable substances.
- Clean the monitor display with a soft, clean cloth and water. Apply the water to the cloth, then stroke the cloth across the display in one direction, moving from the top of the display to the bottom. Remove moisture from the display quickly and keep the display dry.
- Long-term exposure to moisture can damage the display. Do not use a commercial window cleaner to clean your display.
- If your equipment does not operate normally - in particular, if there are any unusual sounds or smells coming from it - unplug it immediately and contact an authorized dealer or service center.

Protecting Against Electrostatic Discharge

Electrostatic discharge (ESD) events can harm electronic components inside your equipment. Under certain conditions, ESD may build up on your body or an object, such as a peripheral, and then discharge into another object, such as your computer. To prevent ESD damage, you should discharge static electricity from your body before you interact with any of your equipment's internal electronic components, such as a memory module. You can protect against ESD by touching a metal grounded object (such as an unpainted metal surface on your computer's I/O panel) before you interact with anything electronic. When connecting a peripheral (including handheld digital assistants) to your equipment, you should always ground both yourself and the peripheral before connecting it. In addition, as you work inside the equipment, periodically discharge any static charge your body may have accumulated.

You can also take the following steps to prevent damage from electrostatic discharge:

- When unpacking a static-sensitive component from its shipping carton, do not remove the component from the antistatic packing material until you are ready to install the component. Just before unwrapping the antistatic package, be sure to discharge static electricity from your body.
- When transporting a sensitive component, first place it in an antistatic container or packaging.
- Handle all electrostatic sensitive components in a static-safe area. If possible, use antistatic floor pads and work bench pads.

1.2 SAFETY: General Power Safety

Observe the following guidelines when connecting your equipment to a power source:

- Check the voltage rating before you connect the equipment to an electrical outlet to ensure that the required voltage and frequency match the available power source.
- Do not plug the equipment power cables into an electrical outlet if the power cable is damaged
- Norway and Sweden: If this product is provided with a 3-prong power cable, connect the power cable to a grounded electrical outlet only.
- If you use an extension power cable, ensure that the total ampere rating of the products plugged in to the extension power cable does not exceed the ampere rating of the extension cable.
- If you must use an extension cable or power strip, ensure the extension cable or power strip is connected to a wall power outlet and not to another extension cable or power strip. The extension cable or power strip must be designed for grounded plugs and plugged into a grounded wall outlet.
- If you are using a multiple-outlet power strip, use caution when plugging the power cable into the power strip. Some power strips may allow you to insert a plug incorrectly. Incorrect insertion of the power plug could result in permanent damage to your equipment, as well as risk of electric shock and/or fire. Ensure that the ground prong of the power plug is inserted into the mating ground contact of the power strip.
- Be sure to grasp the plug, not the cable, when disconnecting equipment from an electric socket.

If your equipment uses an AC adapter:

- Use only the Dell provided AC adapter approved for use with this device. Use of another AC adapter may cause a fire or explosion.
- NOTE: Refer to your system rating label for information on the proper adapter model approved for use with your device.
- Place the AC adapter in a ventilated area, such as a desk top or on the floor, when you use it to run the computer or to charge the battery. Do not cover the AC adapter with papers or other items that will reduce cooling; also, do not use the AC adapter inside a carrying case.
- The AC adapter may become hot during normal operation of your computer. Use care when handling the adapter during or immediately after operation.
- It is recommended that you lay the adapter on the floor or desk so that the green light is visible. This will alert you if the adapter should accidentally go off due to external effects. If for any reason the green light goes off, disconnect the AC power cord from the wall for a period of ten seconds, and then reconnect the power cord.
- Japan Only: Use only the Dell-provided AC power cable with the AC adapter. Use of any other power cable may damage the device or AC adapter or may present risk of fire or electric shock.

2. Exploded view diagram with list of items

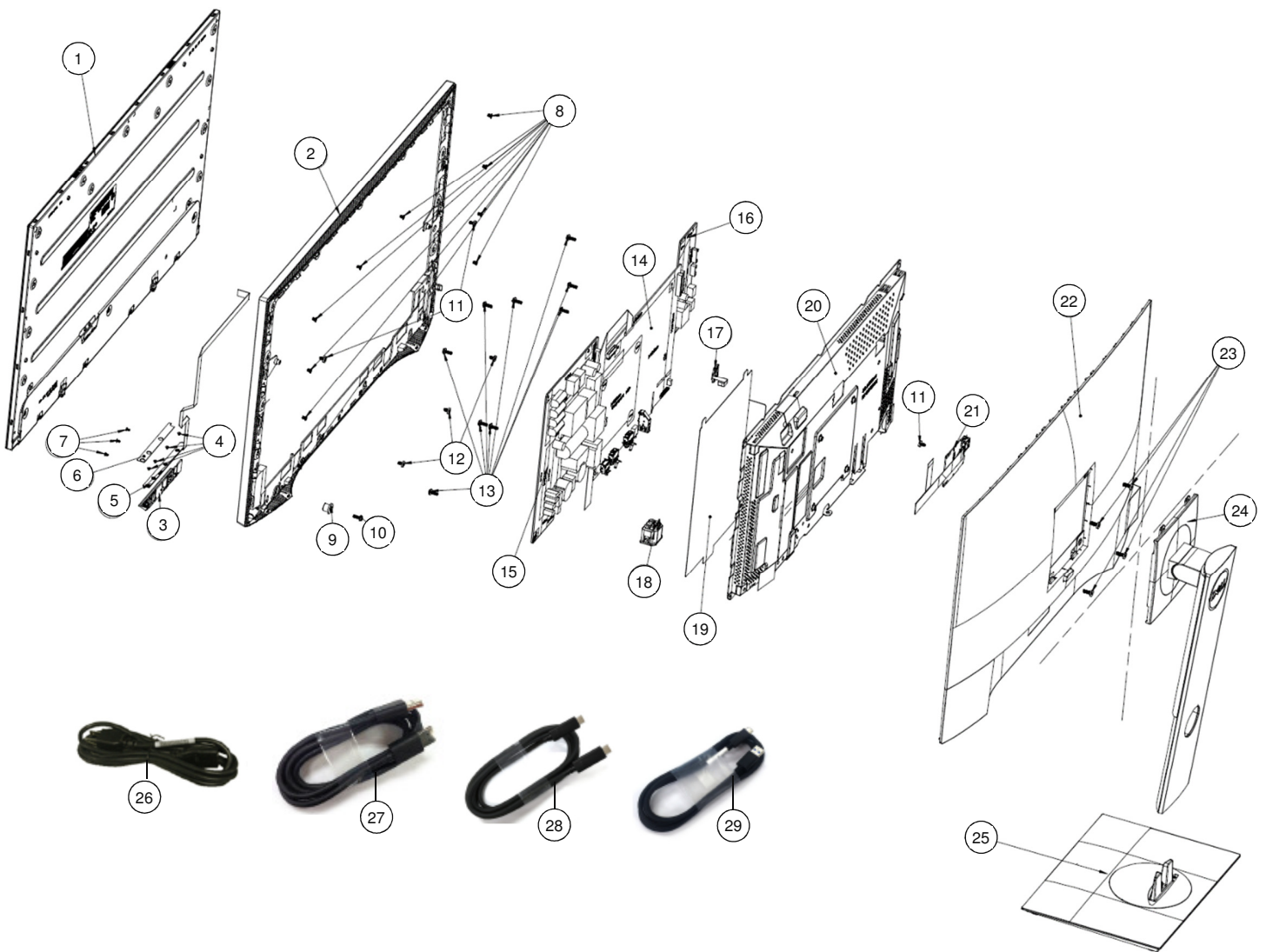

Item	Description	Q'ty	Item	Description	Q'ty
1	Panel	1	16	PCBA LED DRV BD	1
2	ASSY MF	1	17	PCBA SENSOR BD	1
3	BTN PWR	1	18	WIRE AC+3/3P	1
4	SCRW TP-B FPH M2*2.4L ZN	4	19	#MYLAR PWR BD	1
5	PCBA CTRL BD	1	20	#ASSY SHD MAIN	1
6	MYLAR CTRL BD	1	21	#PCBA USB BD	1
7	SCRW TP-B FPH M2*4L B-ZN	3	22	#ASSY RC	1
8	SCRW MACH FLATM3*0.5P*4.5L ZN	11	23	#SCRW M FPH M4*10L ZN NYL	1
9	BOSS PANEL	1	24	#ASSY CLMN	1
10	SCRW TP-S W/FLM3*9.3L(S3.8)ZN	1	25	#ASSY BASE	1
11	SCRW T FPH M3*6L DELTA-PT NI	3	26	Power cable	1
12	SCRW TP-S FPH M3*5.5(7/1.5)NI	3	27	DisplayPort cable	1
13	SCRW PH INT/TOO M3*9TP-S C-ZN	1	28	USB Type-C cable	1
14	PCBA I/F BD	1	29	USB Type-C to Type-A cable	1
15	PCBA SPS BD	1			

3. Wiring connectivity diagram

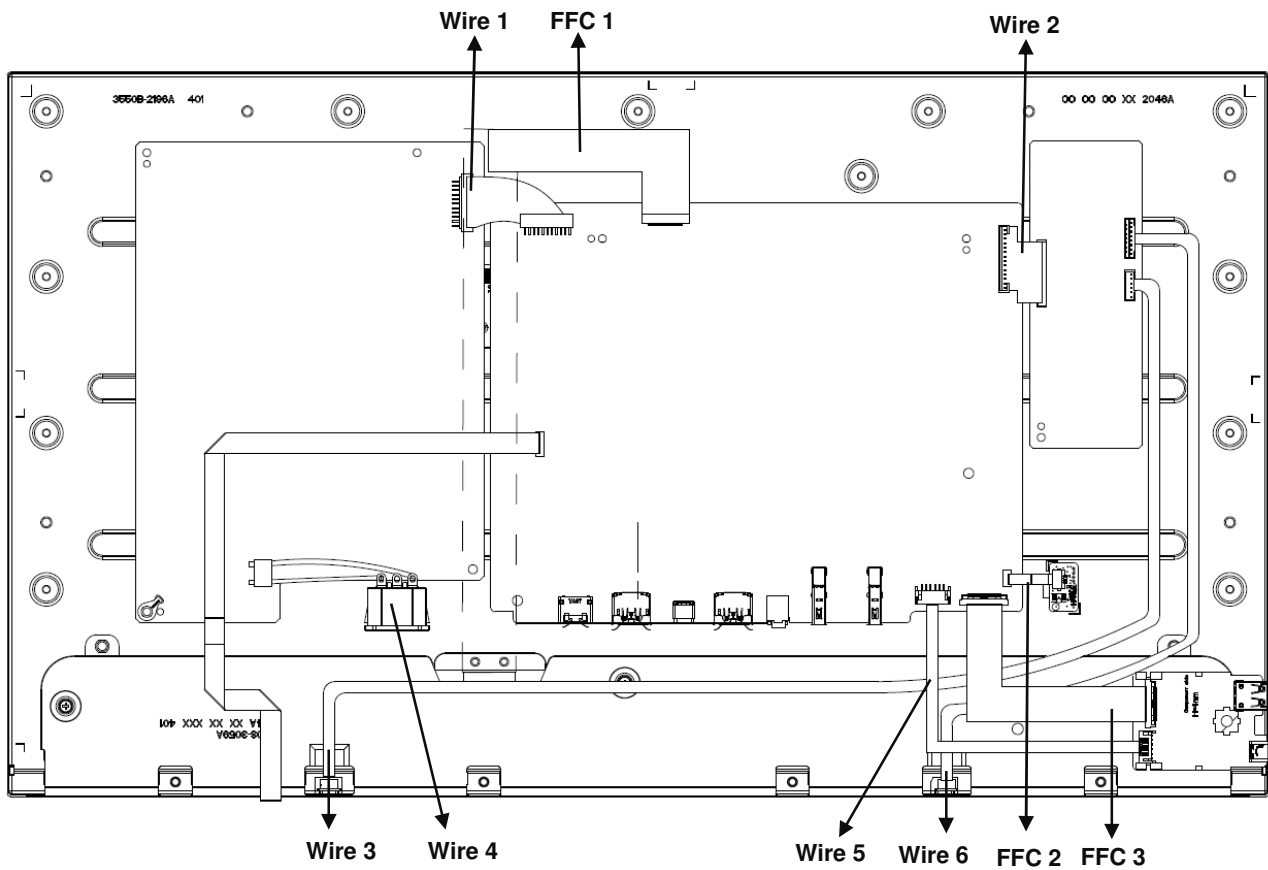

4. Disassembly and Assembly Procedures

4.1 Disassembly SOP

Preparation before disassemble

1. Clean the room for disassemble
2. Identify the area for monitor
3. Check the position that the monitors be placed and the quantity of the monitor; prepare the area for material flow; according to the actual condition plan the disassemble layout
4. Prepare the implement, equipment, material as bellow:
 - 1) Working table
 - 2) Philips-head screwdriver
 - 3) Glove
 - 4) Cleaning cloth
 - 5) ESD protection

Item	Picture	Operation	Tool	Notes
1		<p>To remove the stand:</p> <ol style="list-style-type: none"> 1. Place the monitor on a soft cloth or cushion. 2. Press and hold the stand release button. 3. Lift the stand up and away from the monitor. 		
2		<ol style="list-style-type: none"> 1. Unlock 4 screws on Rear Cover 2. Disassemble Rear Cover from middle frame <p>Notice the disassembly order:</p> <ol style="list-style-type: none"> 1) Disassemble the top side 2) Disassemble the Left/Right side 	<p>Philips-head screwdriver</p> <p>Torsion of Rear Cover screw: 11±1Kg</p>	

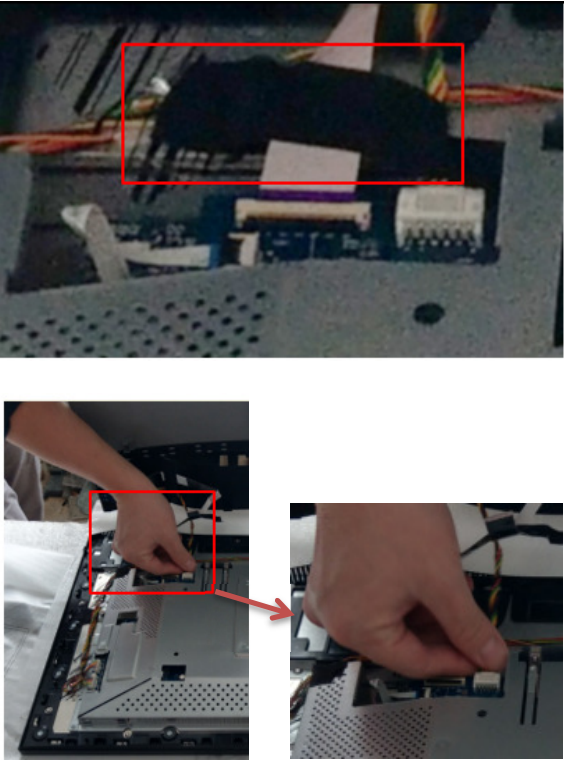
		<p>3) Disassemble the bottom side</p> <p>4) Disassemble Rear Cover from middle frame.</p>		
<p>3</p>		<p>1. Remove the tape which fixed USB FFC cable and USB wire on panel</p> <p>2. Remove USB FFC cable and USB wire from I/F BD</p>		

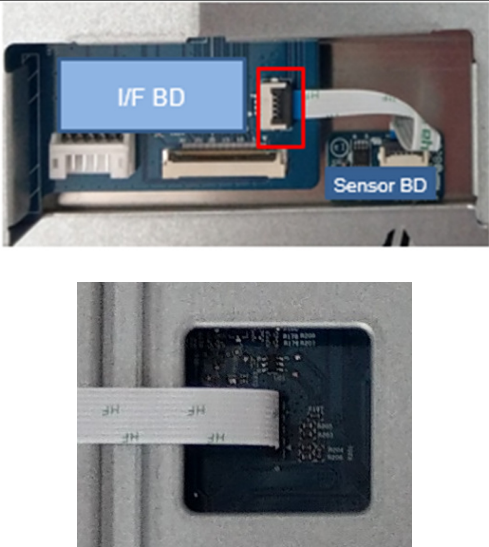
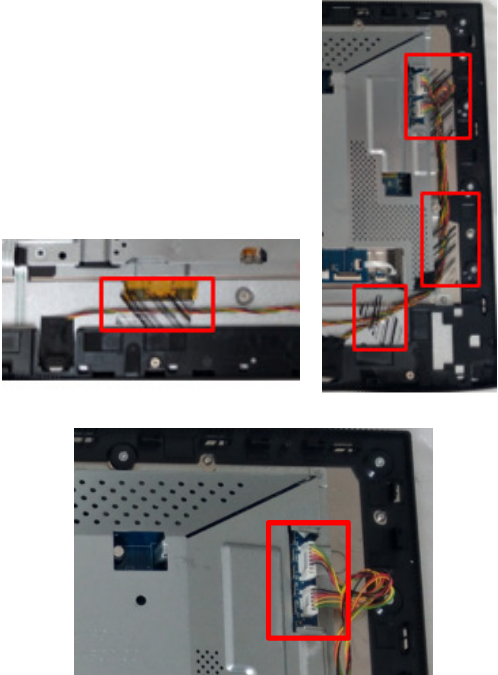
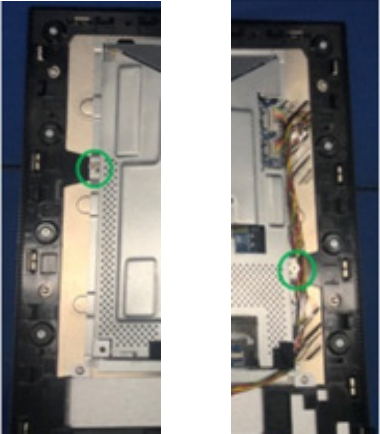
4		<ol style="list-style-type: none"> 1. Remove Sensor BD wire from I/F BD and Sensor BD 2. Remove Control BD wire from I/F BD 		
5		<ol style="list-style-type: none"> 1. Remove 4 black tapes from Panel 2. Remove long and short backlight wire from LED Driver BD 		
6		<ol style="list-style-type: none"> 1. Unlock screws on Middle Frame <ol style="list-style-type: none"> a. FHP screws*2 (See Green mark) 	<p>Philips-head screwdriver</p> <p>Torsion of FPH screw 3.5-4.0kg</p>	

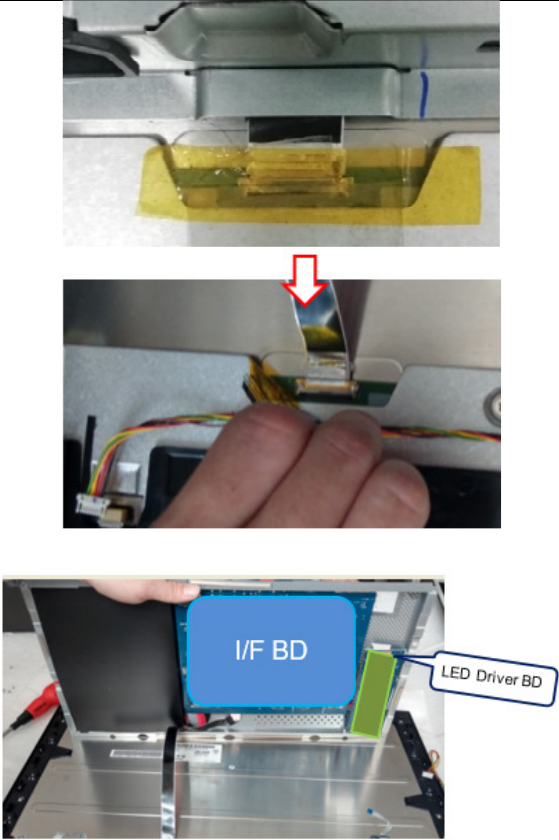
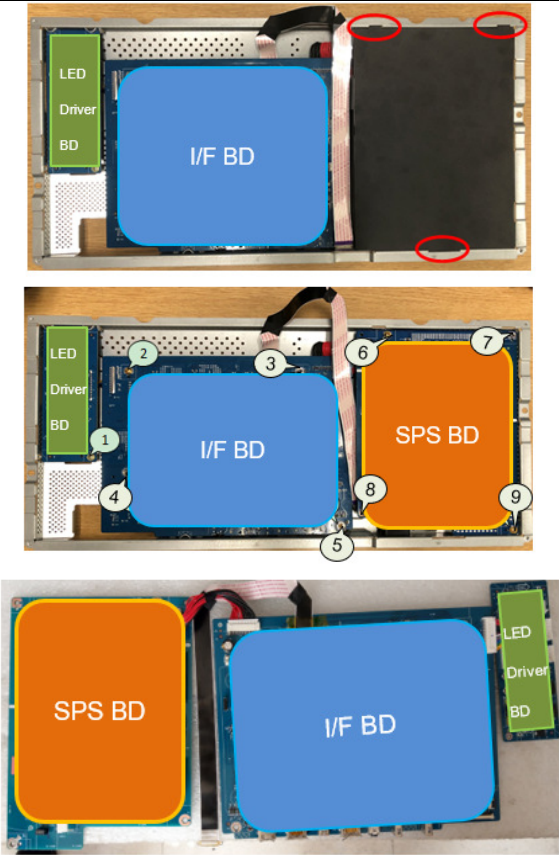
7		<ol style="list-style-type: none"> 1. Tear off the yellow tape from Panel and disassemble LVDS cable from Panel 2. Take off Main SHD from Panel 		
8		<ol style="list-style-type: none"> 1. Take off Mylar from SPS BD 2. Unlock 9 PCBA screws 3. Disassemble LED Driver BD, I/F BD and SPS BD from Main SHD 4. Remove all cables and tapes from LED Driver BD, I/F BD and SPS BD 	<p>Philips-head screwdriver</p> <p>Torsion of PCBA screw: $8.5 \pm 0.5 \text{ Kg}$</p> <p>Torsion of Grounding screw: $6.5 \pm 0.5 \text{ Kg}$</p>	

4.2 Assembly SOP

Preparation before assemble

1. Clean the room for work
2. Identify the area for material
3. Prepare the implement, equipment, material as bellow:
 - 1) Working table
 - 2) Philips-head screwdriver
 - 3) Glove
 - 4) Cleaning cloth
 - 5) ESD protection

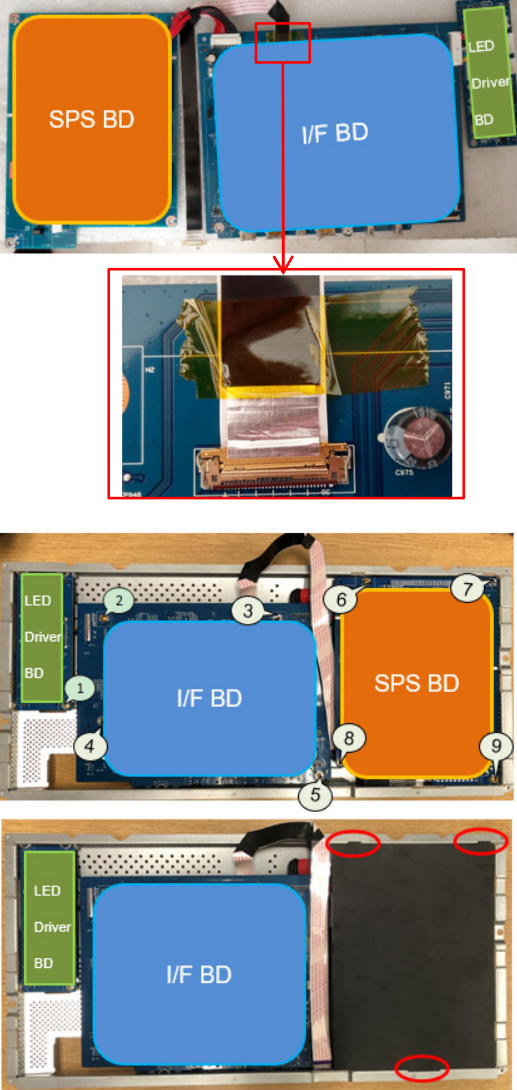
Item	Picture	Operation	Tools	Notes
1		<ol style="list-style-type: none"> 1. Insert SPS BD wire to SPS BD 2. Insert AC wire to SPS BD 3. Assemble SPS BD to Main SHD 4. Insert LVDS cable to I/F BD and paste 1 yellow tape to fix it 5. Insert LED Driver BD wire to I/F BD 6. Insert SPS BD wire to I/F BD 7. Assemble I/F BD to Main SHD 8. Insert LED Driver BD wire to LED Driver BD 9. Assemble LED Driver BD to Main SHD 10. Lock 9 PCBA screws to fix PCBA on Main SHD 11. Assemble Mylar on SPS BD 	<p>Philips-head screwdriver</p> <p>Torsion of PCBA screw: 8.5±0.5Kg</p> <p>Torsion of Grounding screw: 6.5±0.5Kg</p>	

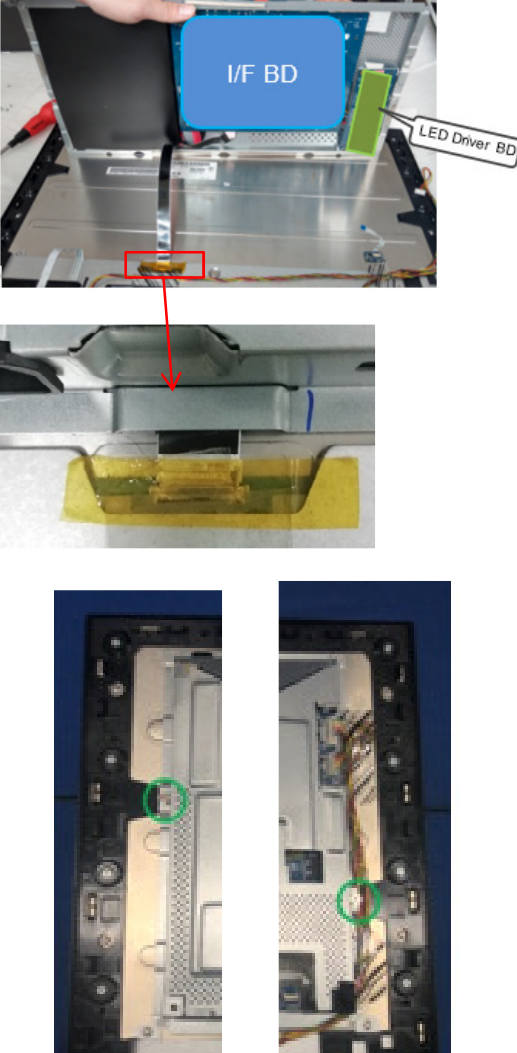
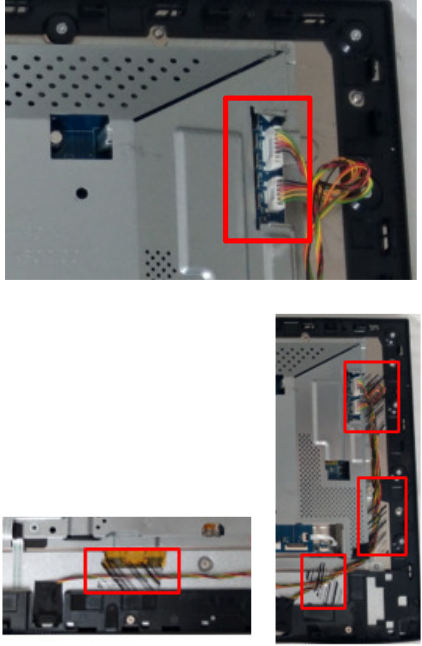
<p>2</p>		<ol style="list-style-type: none"> 1. Insert LVDS cable to panel and paste 1 yellow tape to fix it 2. Place Main SHD on Panel and fix it with Middle Frame by 2 FPH screws (See Green mark) 	<p>Philips-head screwdriver</p> <p>Torsion of FPH screw: 3.5-4.0kg</p>	
<p>3</p>		<ol style="list-style-type: none"> 1. Insert long and short backlight wire to LED Driver BD 2. Paste 4 black tapes to fix backlight wire on Panel 		

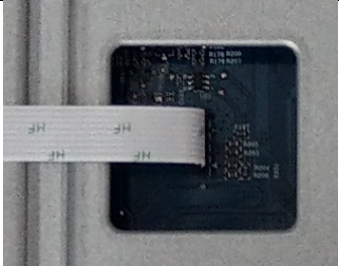
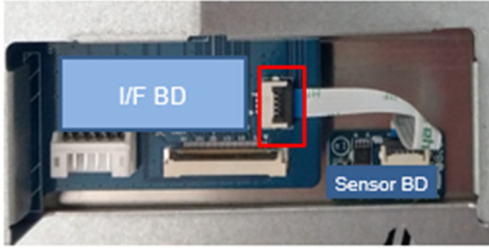
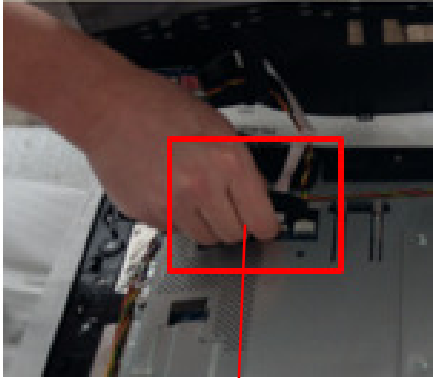
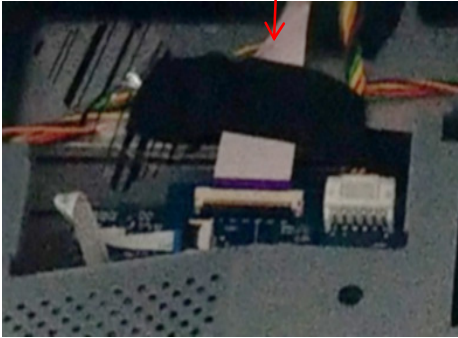
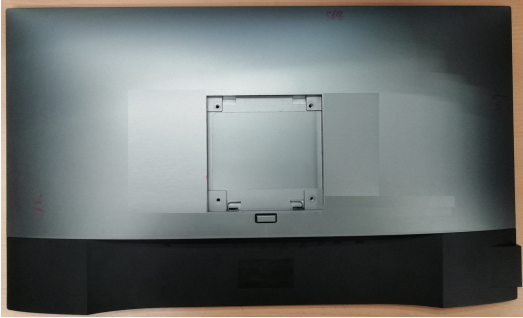
	 	<p>3. Insert Control BD wire to I/F BD</p> <p>4. Insert Sensor BD wire to I/F BD</p>		
<p>4</p>	  	<p>1. Insert USB FFC cable and USB wire to I/F BD</p> <p>2. Paste 1 tape to fix USB FFC cable and USB wire on panel</p> <p>3. Assemble Rear Cover with panel</p>		

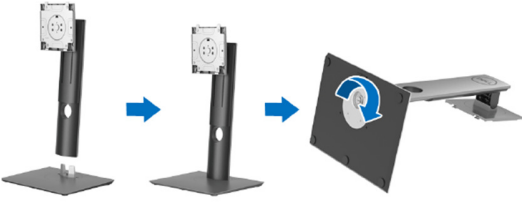
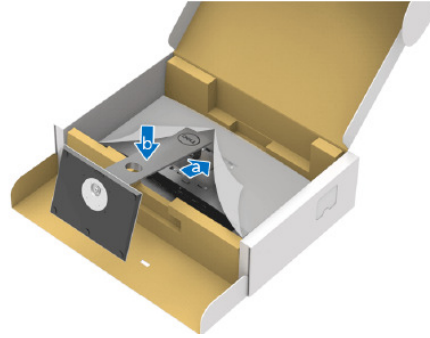
5		<p>1. Lock 4 Rear Cover screws</p>	<p>Philips-head screwdriver</p> <p>Torsion of Rear Cover screw: 11±1Kg</p>	
6		<p>Assemble the Stand:</p> <ol style="list-style-type: none"> Insert the stand base blocks fully into the stand slot Lift the screw handle and turn the screw clockwise After fully tightening the screw, fold the screw handle flat within the recess. 		
7		<p>Attach the Stand assembly to the Monitor:</p> <ol style="list-style-type: none"> Fit the two tabs on the upper part of the stand to the groove on the back of the monitor Press the stand down till it snaps into place. 		

5. Trouble shooting instructions

Troubleshooting

⚠ WARNING: Before you begin any of the procedures in this section, follow the [Safety instructions](#).

Self-test

Your monitor provides a self-test feature that allows you to check whether your monitor is functioning properly. If your monitor and computer are properly connected but the monitor screen remains dark, run the monitor self-test by performing the following steps:

1. Turn off both your computer and the monitor.
2. Unplug the video cable from the back of the computer.
3. Turn on the monitor.

The floating dialog box should appear on-screen (against a black background), if the monitor cannot sense a video signal and is working correctly. While in self-test mode, the power LED remains white. Also, depending upon the selected input, one of the dialogs shown below will continuously scroll through the screen.

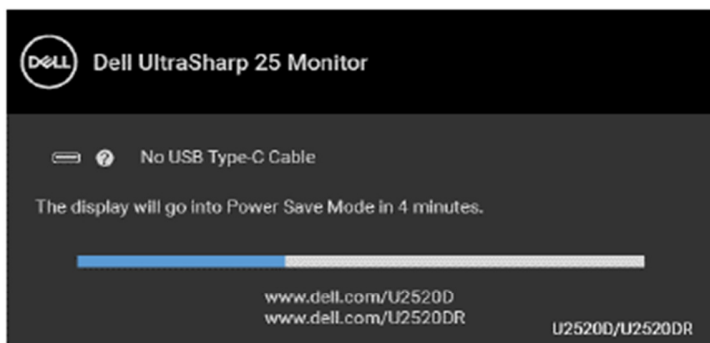

OR

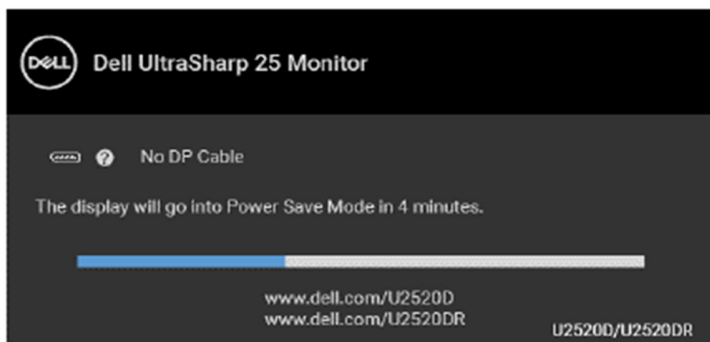

OR

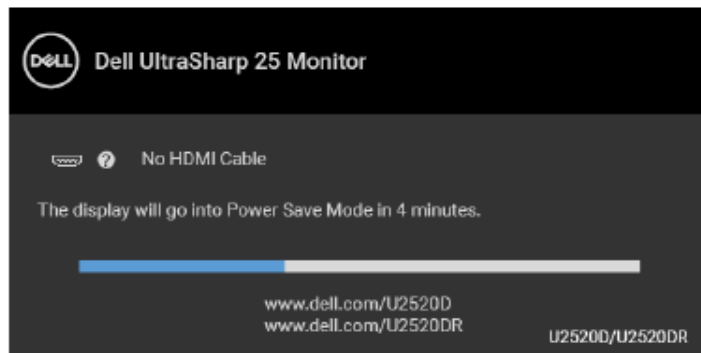

4. This box also appears during normal system operation, if the video cable becomes disconnected or damaged.
5. Turn Off your monitor and reconnect the video cable; then turn On both your computer and the monitor.

If your monitor screen remains blank after you use the previous procedure, check your video controller and computer, because your monitor is functioning properly.

Built-in diagnostics

Your monitor has a built-in diagnostic tool that helps you determine if the screen abnormality you are experiencing is an inherent problem with your monitor, or with your computer and video card.

 **NOTE: You can run the built-in diagnostics only when the video cable is unplugged and the monitor is in self-test mode.**

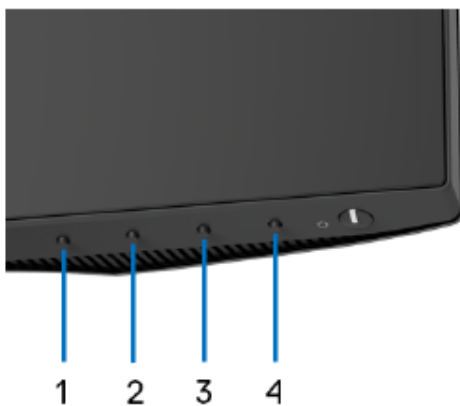

To run the built-in diagnostics:

1. Ensure that the screen is clean (no dust particles on the surface of the screen).
2. Press and hold **Button 4** for about 4 seconds until a pop menu appears.

3. Use **Button 1** or **Button 2** to select the diagnostic tool and use **Button 3** to confirm. A gray test pattern appears at the beginning of the diagnostic program.
4. Carefully inspect the screen for abnormalities.
5. Press **Button 1** again to change the test patterns.
6. Repeat steps 4 and 5 to inspect the display in red, green, blue, black, white, and text screens.
7. Press **Button 1** to end the diagnostic program.

Always On USB Type-C Charging

The monitor allows you to charge your notebook or mobile devices through the USB Type-C cable even when the monitor is powered off. See [USB-C Charging 90W](#) for more information.

You may verify your current firmware revision in [Firmware](#). If this is not available, go to the Dell download support site for the latest application installer (**Monitor Firmware Update Utility.exe**) and refer to the Firmware Update Instruction User's Guide: www.dell.com/U2520D or www.dell.com/U2520DR.

Common problems

The following table contains general information about common monitor problems you might encounter and the possible solutions:

Common symptoms	What you experience	Possible solutions
No Video/Power LED off	No picture	<ul style="list-style-type: none"> • Ensure that the video cable connecting the monitor and the computer is properly connected and secure. • Verify that the power outlet is functioning properly using any other electrical equipment. • Ensure that the power button is pressed fully. • Ensure that the correct input source is selected in the Input Source menu.

No Video/Power LED on	No picture or no brightness	<ul style="list-style-type: none"> • Increase brightness & contrast controls via OSD. • Perform monitor self-test feature check. • Check for bent or broken pins in the video cable connector. • Run the built-in diagnostics. • Ensure that the correct input source is selected in the Input Source menu.
Poor Focus	Picture is fuzzy, blurry, or ghosting	<ul style="list-style-type: none"> • Eliminate video extension cables. • Reset the monitor to factory settings. • Change the video resolution to the correct aspect ratio.
Shaky/Jittery Video	Wavy picture or fine movement	<ul style="list-style-type: none"> • Reset the monitor to factory settings. • Check environmental factors. • Relocate the monitor and test in another room.
Missing Pixels	LCD screen has spots	<ul style="list-style-type: none"> • Cycle power On-Off. • Pixel that is permanently Off is a natural defect that can occur in LCD technology. • For more information on Dell Monitor Quality and Pixel Policy, see Dell Support site at: http://www.dell.com/support/monitors.
Stuck-on Pixels	LCD screen has bright spots	<ul style="list-style-type: none"> • Cycle power On-Off. • Pixel that is permanently off is a natural defect that can occur in LCD technology. • For more information on Dell Monitor Quality and Pixel Policy, see Dell Support site at: http://www.dell.com/support/monitors.

Brightness Problems	Picture too dim or too bright	<ul style="list-style-type: none"> Reset the monitor to factory settings. Adjust brightness & contrast controls via OSD.
Geometric Distortion	Screen not centered correctly	<ul style="list-style-type: none"> Reset the monitor to factory settings.
Horizontal/Vertical Lines	Screen has one or more lines	<ul style="list-style-type: none"> Reset the monitor to factory settings. Perform monitor self-test feature check and determine if these lines are also in self-test mode. Check for bent or broken pins in the video cable connector. Run the built-in diagnostics.
Synchronization Problems	Screen is scrambled or appears torn	<ul style="list-style-type: none"> Reset the monitor to factory settings. Perform monitor self-test feature check to determine if the scrambled screen appears in self-test mode. Check for bent or broken pins in the video cable connector. Restart the computer in the safe mode.
Safety Related Issues	Visible signs of smoke or sparks	<ul style="list-style-type: none"> Do not perform any troubleshooting steps. Contact Dell immediately.
Intermittent Problems	Monitor malfunctions on & off	<ul style="list-style-type: none"> Ensure that the video cable connecting the monitor to the computer is connected properly and is secure. Reset the monitor to factory settings. Perform monitor self-test feature check to determine if the intermittent problem occurs in self-test mode.

Missing Color	Picture missing color	<ul style="list-style-type: none"> Perform monitor self-test feature check. Ensure that the video cable connecting the monitor to the computer is connected properly and is secure. Check for bent or broken pins in the video cable connector.
Wrong Color	Picture color not good	<ul style="list-style-type: none"> Change the settings of the Preset Modes in the Color menu OSD depending on the application. Adjust the R/G/B values under Custom Color in Color menu OSD. Change the Input Color Format to PC RGB or YPbPr in the Color menu OSD. Run the built-in diagnostics.
Image retention from a static image left on the monitor for a long period of time	Faint shadow from the static image displayed appears on the screen	<ul style="list-style-type: none"> Use the Power Management feature to turn off the monitor at all times when not in use (for more information, see Power management modes). Alternatively, use a dynamically changing screensaver.

Product specific problems

Common symptoms	What you experience	Possible solutions
Screen image is too small	Image is centered on screen, but does not fill entire viewing area	<ul style="list-style-type: none">• Check the Aspect Ratio setting in the Display menu OSD.• Reset the monitor to factory settings.
Cannot adjust the monitor with the buttons on the front panel	OSD does not appear on the screen	<ul style="list-style-type: none">• Turn Off the monitor, unplug the power cord, plug it back, and then turn On the monitor.• Check whether the OSD menu is locked. If yes, press and hold the Menu/function button next to the Power button for 4 seconds to unlock (for more information, see Lock).
No Input Signal when user controls are pressed	No picture, the LED light is white	<ul style="list-style-type: none">• Check the signal source. Ensure the computer is not in the power saving mode by moving the mouse or pressing any key on the keyboard.• Check whether the signal cable is plugged in properly. Re-plug the signal cable if necessary.• Reset the computer or video player.
The picture does not fill the entire screen	The picture cannot fill the height or width of the screen	<ul style="list-style-type: none">• Due to different video formats (aspect ratio) of DVDs, the monitor may display in full screen.• Run the built-in diagnostics.
No video at HDMI/DisplayPort/USB Type-C port	When connected to some dongle/docking device at the port, there is no video when unplugging/plugging the Thunderbolt cable from the notebook	<ul style="list-style-type: none">• Unplug the HDMI/DisplayPort/USB Type-C cable from dongle/docking device, then plug the docking Thunderbolt cable to the notebook. Plug the HDMI/DisplayPort/USB Type-C cable 7 seconds later.

Universal Serial Bus (USB) specific problems

Common symptoms	What you experience	Possible solutions
USB interface is not working	USB peripherals are not working	<ul style="list-style-type: none">• Check that your monitor is turned On.• Reconnect the upstream cable to your computer.• Reconnect the USB peripherals (downstream connector).• Switch Off and then turn On the monitor again.• Reboot the computer.• Some USB devices like external portable HDD require higher electric current; connect the device directly to the computer system.
USB Type-C port does not supply power	USB peripherals can not be charged	<ul style="list-style-type: none">• Check that the connected device is compliant with the USB-C specification. The USB Type-C port supports USB 2.0 and an output of 90 W.• Check that you use the USB Type-C cable shipped with your monitor.
Super Speed USB 3.0 interface is slow	Super Speed USB 3.0 peripherals working slowly or not working at all	<ul style="list-style-type: none">• Check that your computer is USB 3.0-capable.• Some computers have USB 3.0, USB 2.0, and USB 1.1 ports. Ensure that the correct USB port is used.• Reconnect the upstream cable to your computer.• Reconnect the USB peripherals (downstream connector).• Reboot the computer.

Wireless USB peripherals stop working when a USB 3.0 device is plugged in	Wireless USB peripherals responding slowly or only working as the distance between itself and its receiver decreases	<ul style="list-style-type: none">• Increase the distance between the USB 3.0 peripherals and the wireless USB receiver.• Position your wireless USB receiver as close as possible to the wireless USB peripherals.• Use a USB-extender cable to position the wireless USB receiver as far away as possible from the USB 3.0 port.
---	--	--
