

Service  
Service  
Service



Simplified

# Service Manual

## Important Safety Notice

Proper service and repair is important to the safe, reliable operation of all DELL Company Equipment. The service procedures recommended by DELL and described in this service manual are effective methods of performing service operations. Some of these service operations require the use of tools specially designed for the purpose. The special tools should be used when and as recommended.

It is important to note that this manual contains various CAUTIONS and NOTICES which should be carefully read in order to minimize the risk of personal injury to service personnel. The possibility exists that improper service methods may damage the equipment. It is also important to understand that these CAUTIONS and NOTICES ARE NOT EXHAUSTIVE. DELL could not possibly know, evaluate and advise the service trade of all conceivable ways in which service might be done or of the possible hazardous consequences of each way. Consequently, DELL has not undertaken any such broad evaluation. Accordingly, a servicer who uses a service procedure or tool which is not recommended by DELL must first satisfy himself thoroughly that neither his safety nor the safe operation of the equipment will be jeopardized by the service method selected.

Hereafter throughout this manual, DELL Company will be referred to as DELL.

### WARNING

Use of substitute replacement parts, which do not have the same, specified safety characteristics may create shock, fire, or other hazards.

Under no circumstances should the original design be modified or altered without written permission from DELL. DELL assumes no liability, express or implied, arising out of any unauthorized modification of design.

Servicer assumes all liability.

### FOR PRODUCTS CONTAINING LASER:

DANGER-Invisible laser radiation when open. AVOID DIRECT EXPOSURE TO BEAM.

CAUTION-Use of controls or adjustments or performance of procedures other than those specified herein may result in hazardous radiation exposure.

CAUTION -The use of optical instruments with this product will increase eye hazard.

TO ENSURE THE CONTINUED RELIABILITY OF THIS PRODUCT, USE ONLY ORIGINAL MANUFACTURER'S REPLACEMENT PARTS, WHICH ARE LISTED WITH THEIR PART NUMBERS IN THE PARTS LIST SECTION OF THIS SERVICE MANUAL.

Take care during handling the LCD module with backlight unit

- Must mount the module using mounting holes arranged in four corners.
- Do not press on the panel, edge of the frame strongly or electric shock as this will result in damage to the screen.
- Do not scratch or press on the panel with any sharp objects, such as pencil or pen as this may result in damage to the panel.
- Protect the module from the ESD as it may damage the electronic circuit (C-MOS).
- Make certain that treatment person's body is grounded through wristband.
- Do not leave the module in high temperature and in areas of high humidity for a long time.
- Avoid contact with water as it may a short circuit within the module.
- If the surface of panel becomes dirty, please wipe it off with a soft material. (Cleaning with a dirty or rough cloth may damage the panel.)

# 1. Exploded view diagram with list of items

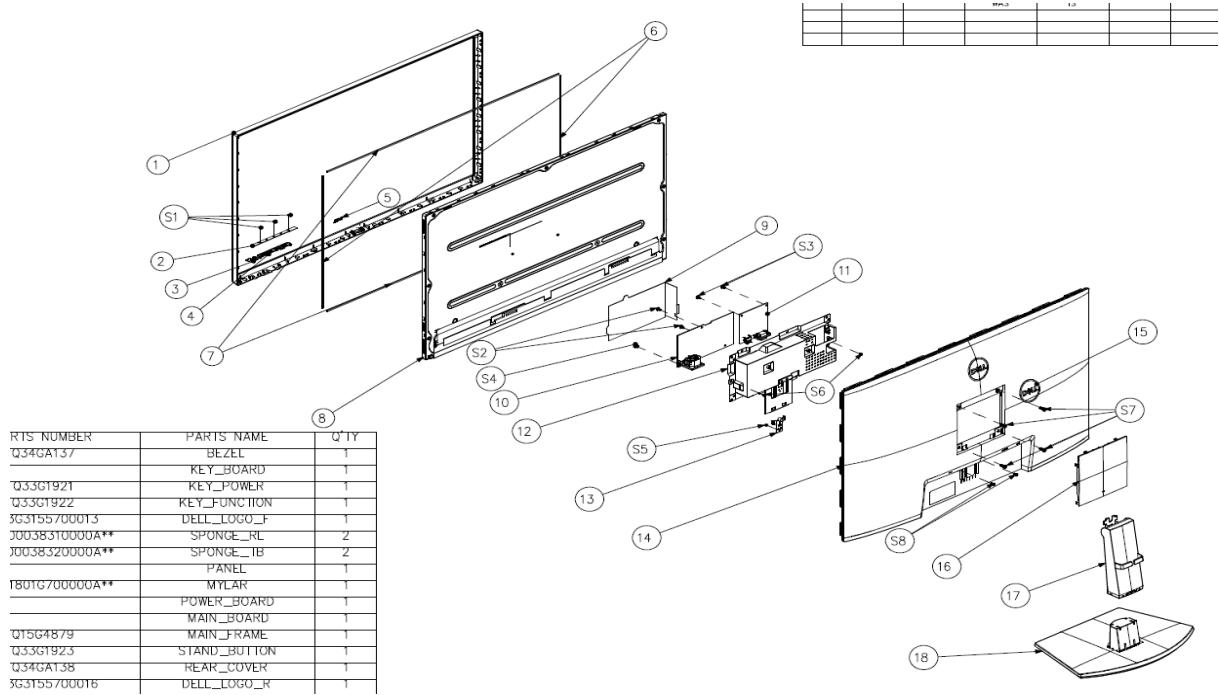

Item	Part NO.	Description	Quantity
1	Q34GA137	BEZEL	1
2		KEY_BOARD	1
3	Q33G1921	KEY_POWER	1
4	Q33G1922	KEY_FUNCTION	1
5	Q23G3155700013	DELL_LOGO_F	1
6	Q16G00038310000A**	SPONGE_RL	2
7	Q16G00038320000A**	SPONGE_TB	2
8		PANEL	1
9	Q52G1801G700000A**	MYLAR	1
10		POWER_BOARD	1
11		MAIN_BOARD	1
12	Q15G4879	MAIN_FRAME	1
13	Q33G1923	STAND_BUTTON	1
14	Q34GA138	REAR_COVER	1
15	Q23G3155700016	DELL_LOGO_R	1
16	Q34GA139	COVER_VESA	1
17	Q37G1385012011	HINGE_ASS? Y	1
18	Q37G1385011011	BASE_ASS? Y	1
S1	Q01G6019--2	SCREW_KEY	3
S2	OD1G1030--7120	SCREW_POWER_BOARD	2
S3	OD1G1030--7120	SCREW_MAIN_BOARD	2
S4	OM1G3840--8120	SCREW_AC	1

S5	0M1G30302. 5120	SCREW_BUTTON	1
S6	0M1G30302. 5120	SCREW_PANEL	2
S7	0M1G2940-10-225	SCREW_VESA	4
S8	0M1G3030-6-47-CR3	SCREW_REAR_COVER	2

## 2. Wiring connectivity diagram

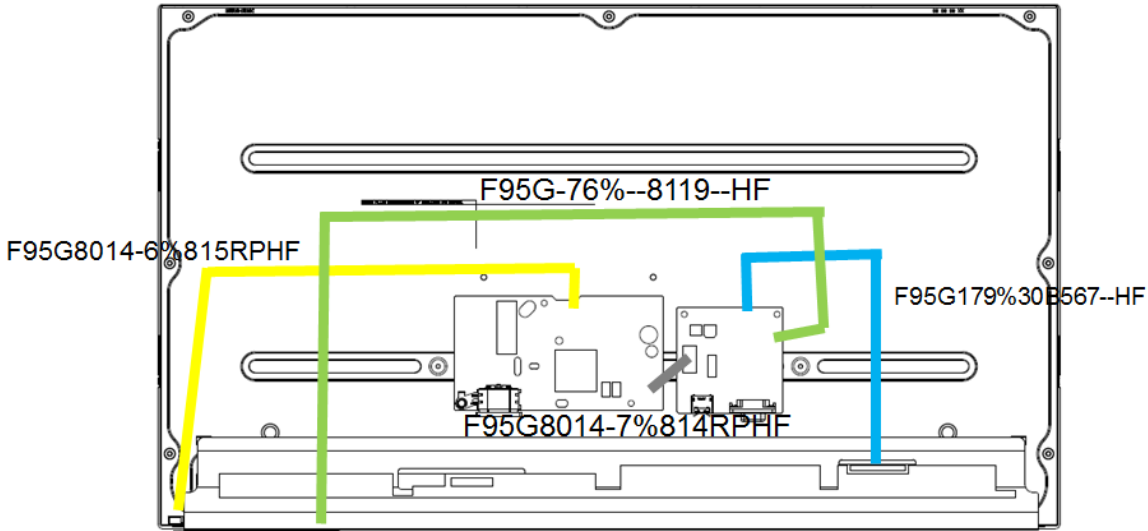

## 3. Tools Required

List the type and size of the tools that would typically can be used to disassemble the product to a point where components and materials requiring selective treatment can be removed.

Tool Description:

- Screwdriver (Phillip-head, Hexagonal head)
- Penknife

### 3.1 Disassembly Procedures

Tools: 2 Power screwdrivers ( $\phi=5\text{mm}$ ,  $L=60\text{mm}$ ); 1 small cross screwdriver; turnbuckle driver;

Setting: Power screwdriver torque  $A=6\text{ kgF.Cm}$

Step	Figure	TOOI	Remark
------	--------	------	--------

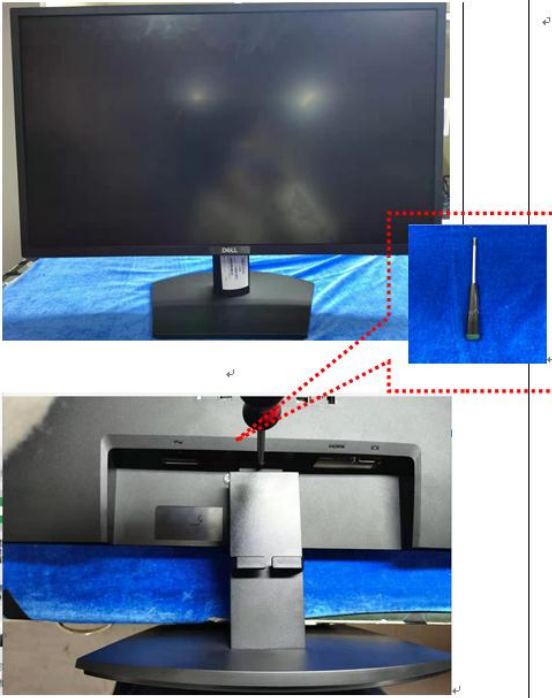
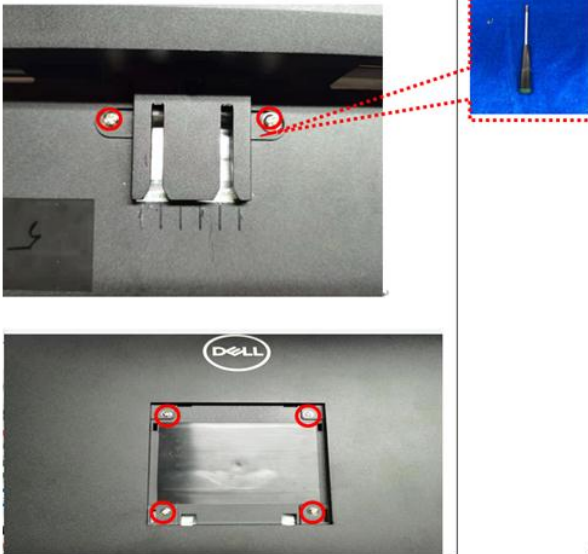
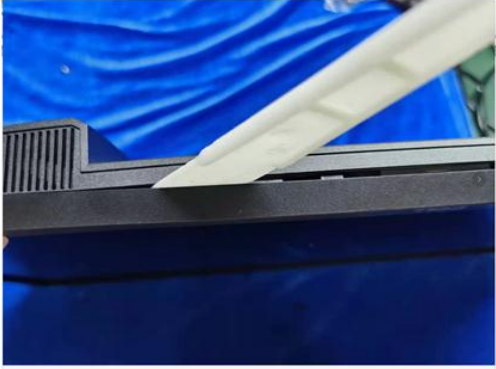
<p><b>Remove the Base ass'y.</b></p>			<p>Use the tip of the screw driver to press the hidden button and pull out the stand.</p> <p>Note: Put the monitor on a flat, soft and clean surface.</p>
			<p>Unscrew the 6 screws by the Philips-head Screwdriver. Torque=6±1 kgf.cm</p>
<p><b>Remove the Rear cover</b></p>			<p>Take scraper insert the bezel bottom site</p>

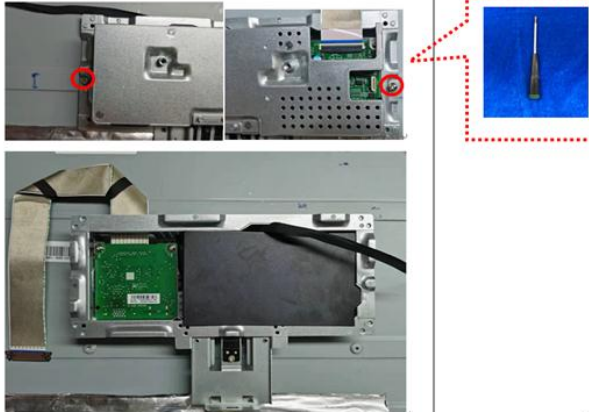
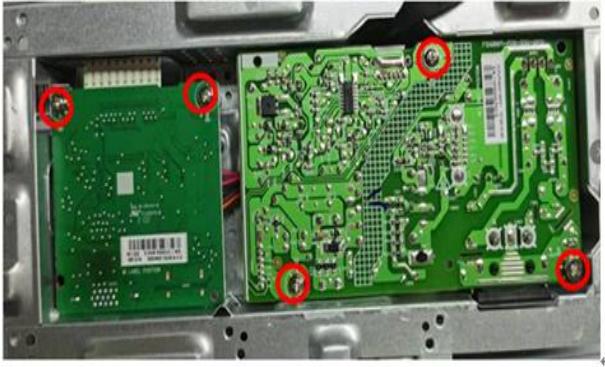
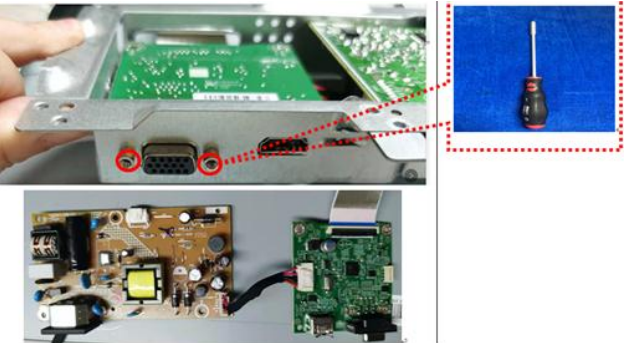

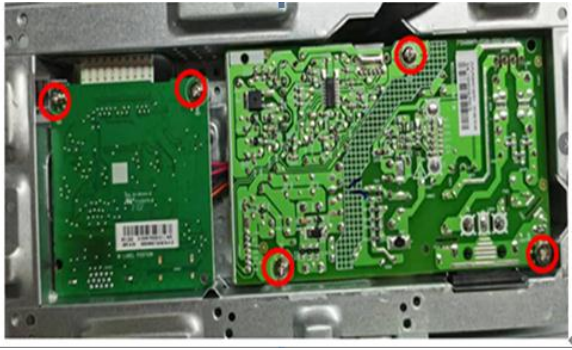

<p><b>Disconnect the FFC cables and LVDS cable.</b></p>			
			<p>tear out all the tapes.</p> <p>Unscrew the 2 screws on the mainframe.</p> <p>Torque=6±1kgf.cm</p> <p>Tear out the wires and mylar.</p>
			<p>remove the screws on the board by the Philips-head.</p> <p>Torque=6±1kgf.cm</p>
<p><b>Remove the mainboard and power board</b></p>			<p>Unscrew the screws by the hexagon screwdriver.</p>

<p><b>Remove the bezel</b></p>			<p>Remove the screws on the keyboard</p>
<p><b>Panel</b></p>			

### 3.2 Assembly Procedures:

<p><b>Assemble the keyboard</b></p>			<p>screw the screws on the keyboard</p>
<p><b>Assemble the Mainboard and powerboard</b></p>			<p>Tighten the screws by the Screwdriver.</p>

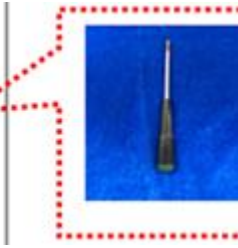

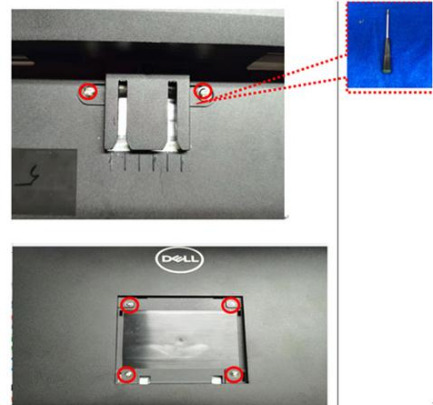
			
<p>Assemble the mylar</p>			<p>t</p>
<p>Assemble the mainframe</p>			<p>Tighten the 2 screws on the mainframe.</p>
<p>connect the FFC cables and LVDS cabel.</p>			<p>Stick the tape and foil</p>
<p>Assemble the rear cover</p>			<p>Tighten the 6 screws by the Philips-head Screwdriver. Torque=6±1kgf.cm</p>

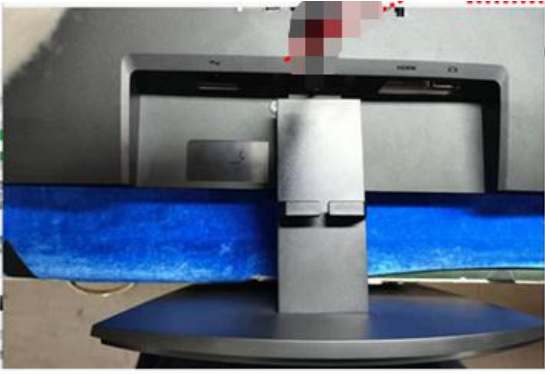

<p><b>Assemble the stand ass'y</b></p>			
--	---	--	--

#### 4. Trouble shooting instructions

**⚠ WARNING: Before you begin any of the procedures in this section, follow the [Safety instructions](#).**

#### Self-Test

Your monitor provides a self-test feature that allows you to check if your monitor is functioning properly. If your monitor and computer are properly connected but the monitor screen remains dark, run the monitor self-test by performing the following steps:

1. Turn off both your computer and the monitor.
2. Disconnect all video cables from the monitor. This way, the computer doesn't have to be involved.
3. Turn on the monitor.

If the monitor is working correctly, it detects that there is no signal and one of the following message appears. While in self-test mode, the power LED remains white.

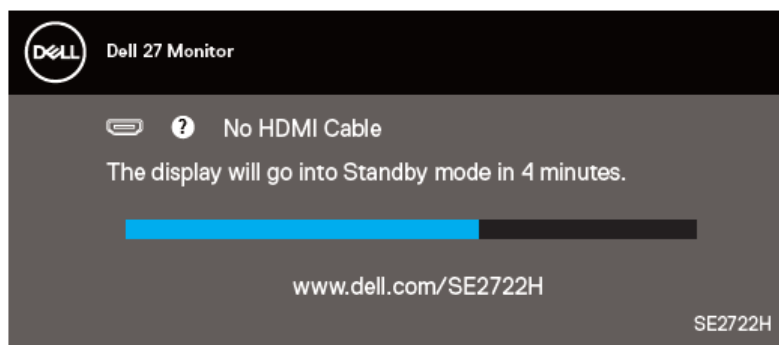

OR

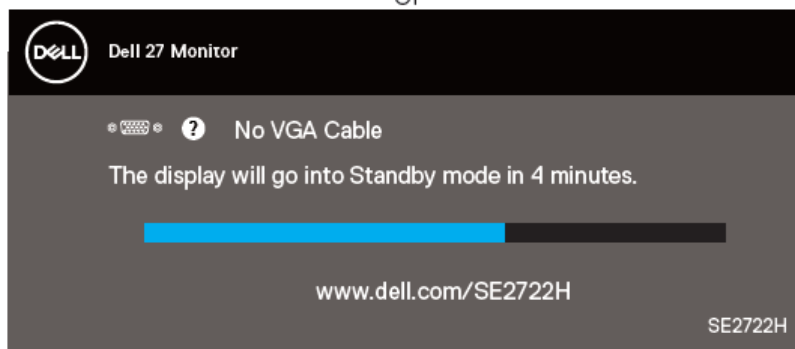

**NOTE:** This box also appears during normal system operation, if the video cable is disconnected or damaged.

4. Turn Off your monitor and reconnect the video cable; then turn on your computer and the monitor.

If your monitor remains dark after you reconnect the cables, check your video controller and computer.

### Built-in diagnostics

Your monitor has a built-in diagnostic tool that helps you determine if any screen abnormality you experience is an inherent problem with your monitor, or with your computer and video card.

 **NOTE: You can run the built-in diagnostics only when the video cable is unplugged and the monitor is in self-test mode.**

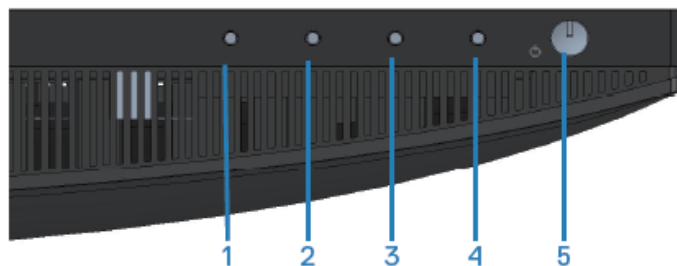

To run the built-in diagnostics:

1. Ensure that the screen is clean (no dust particles on the surface of the screen).
2. Unplug the video cable(s) from the back of the computer or monitor. The monitor then goes into the self-test mode.
3. Press and hold the Exit button (button 4) for four seconds to enter the OSD lock/unlock menu.

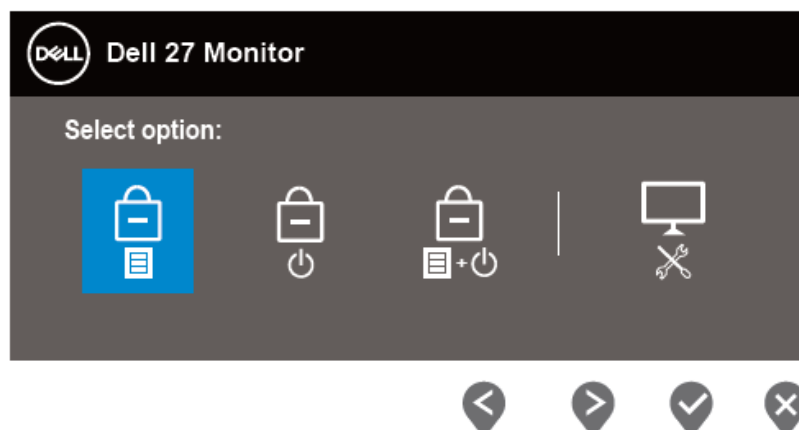

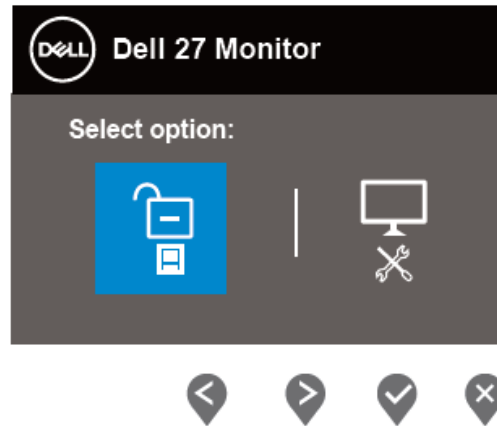

4. Select the  icon to run the built-in diagnostics.
5. Carefully inspect the screen for abnormalities.
6. Press the Up button (button 1) on the back cover again. The color of the screen changes to grey.
7. Inspect the display for any abnormalities.
8. Repeat step 6 and 7 to inspect the display in red, green, blue, black, white and text pattern screens.

The test is complete when the text pattern screen appears. To exit, press the Up button (button 1) again.

If you do not detect any screen abnormalities upon using the built-in diagnostic tool, the monitor is functioning properly. Check the video card and computer.