



# Dell S3222HS Monitor

## User's Guide

Monitor Model: S3222HS  
Regulatory Model: S3222HSc



-  **NOTE:** A NOTE indicates important information that helps you make better use of your computer.
-  **CAUTION:** A CAUTION indicates potential damage to hardware or loss of data if instructions are not followed.
-  **WARNING:** A WARNING indicates a potential for property damage, personal injury, or death.

Copyright © 2021 Dell Inc. or its subsidiaries. All rights reserved. Dell, EMC, and other trademarks are trademarks of Dell Inc. or its subsidiaries. Other trademarks may be trademarks of their respective owners.

2021 – 08

Rev. A00



# Contents

<b>Safety instructions</b>	<b>6</b>
<b>About your monitor</b>	<b>7</b>
Package contents	7
Product features	9
<b>Identifying parts and controls</b>	<b>10</b>
Front view	10
Back view	11
Side view	12
Bottom view	12
<b>Monitor specifications</b>	<b>14</b>
Speaker Specifications	15
Resolution specifications	16
Supported video modes	16
Preset display modes	17
Physical characteristics	19
Environmental characteristics	20
<b>Plug and play capability</b>	<b>21</b>
<b>LCD monitor quality and pixel policy</b>	<b>21</b>
<b>Setting up the monitor</b>	<b>22</b>
Connecting the stand	22
Connecting your monitor	24
Connecting the HDMI cable	24



Organizing cables . . . . .	25
Securing your monitor using Kensington lock (optional)	26
Removing the stand . . . . .	27
Wall mounting (optional) . . . . .	29
<b>Operating your monitor . . . . .</b>	<b>30</b>
Power on the monitor . . . . .	30
Using the control buttons . . . . .	30
Control buttons . . . . .	31
OSD controls . . . . .	32
Using the On-Screen Display (OSD) menu . . . . .	33
Accessing the OSD menu . . . . .	33
Menu and Power button lock . . . . .	43
OSD warning messages . . . . .	45
Setting the maximum resolution . . . . .	47
Using the tilt and vertical extension. . . . .	48
Tilt Extension . . . . .	48
Vertical Extension . . . . .	48
<b>Ergonomics. . . . .</b>	<b>49</b>
Handling and moving your display. . . . .	51
Maintenance guidelines . . . . .	52
Cleaning your monitor. . . . .	52
<b>Troubleshooting . . . . .</b>	<b>53</b>
Self-Test . . . . .	53
Built-in diagnostics . . . . .	54
Common problems . . . . .	56



Product-specific problems . . . . . 59

**Appendix. . . . . 60**

FCC notices (U.S. Only) and other regulatory information 60

Contacting Dell. . . . . 60



# Safety instructions

Use the following safety guidelines to protect your monitor from potential damage and to ensure your personal safety. Unless otherwise noted, each procedure included in this document assumes that you have read the safety information that shipped with your monitor.

 **Before using the monitor, read the safety information that is shipped with your monitor and also printed on the product. Keep the documentation at a secure location for future reference.**

 **CAUTION: Use of controls, adjustments, or procedures other than those specified in this documentation may result in exposure to shock, electrical hazards, and/or mechanical hazards.**

- Place the monitor on a solid surface and handle it carefully. The screen is fragile and can be damaged if dropped or hit with a sharp object.
- Ensure that your monitor is electrically rated to operate with the AC power available in your location.
- Keep the monitor in room temperature. Excessive cold or hot conditions can have an adverse effect on the liquid crystal of the display.
- Connect the power cable from the monitor to a wall outlet that is near and accessible. See [Connecting your monitor](#).
- Do not place and use the monitor on a wet surface or near water.
- Do not subject the monitor to severe vibration or high impact conditions. For example, do not place the monitor inside a car trunk.
- Unplug the monitor when it is going to be left unused for an extended period of time.
- To avoid electric shock, do not attempt to remove any cover or touch the inside of the monitor.
- Read these instructions carefully. Keep this document for future reference. Follow all warnings and instructions marked on product.
- Excessive sound pressure from earphones and headphones can cause hearing loss. Adjustment of the equalizer to maximum increases the earphones and headphones output voltage and therefore the sound pressure level.
- The equipment can be installed on wall or ceiling mounting in horizontal position.







# About your monitor

## Package contents

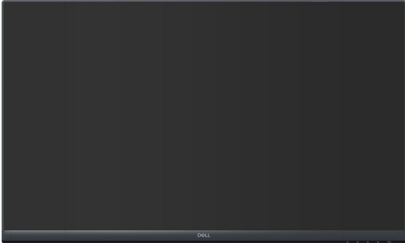
Your monitor ships with the components shown in the table below. If any component is missing, contact Dell. For more information, see [Contacting Dell](#).

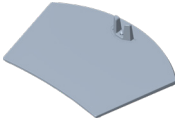
**NOTE:** Some items may be optional and may not ship with your monitor. Some features or media may not be available in certain countries.

	Display
	Stand riser
	Stand base
	Power cable (varies by countries)



	HDMI 1.4 cable
	<ul style="list-style-type: none"><li>• Quick Setup Guide</li><li>• Safety, Environmental and Regulatory Information</li></ul>





## Product features

The Dell S3222HS monitor has an active matrix, Thin-Film Transistor (TFT), Liquid Crystal Display (LCD), anti-static, and LED backlight. The monitor features include:

- 80.13 cm (31.5 in.) viewable area display (measured diagonally).
- 1920 x 1080 resolution, with full-screen support for lower resolutions.
- AMD FreeSync™ Technology, which minimizes graphic distortions like screen tearing and stuttering for smoother, fluid gameplay.
- Supports 48 Hz to 75 Hz (HDMI) in FreeSync Mode.
- Built-in speaker 5 W x 2.
- Supports Audio line out to connect external speaker or sub-woofer.
- Color gamut of 99% sRGB (typical).
- Digital connectivity with HDMI.
- On-Screen Display (OSD) adjustments for ease of setup and screen optimization.
- Removable stand and Video Electronics Standards Association (VESA™) 100 mm mounting holes for flexible mounting solutions.
- Tilt and height adjustment capabilities.
- Security-lock slot.
- ≤0.3 W in the Standby Mode.
- Supports Dell Display Manager.
- Optimize eye comfort with a flicker-free screen.

**⚠ WARNING: The possible long-term effects of blue light emission from the monitor may cause damage to the eyes, including eye fatigue, digital eye strain, and so on. ComfortView feature is designed to reduce the amount of blue light emitted from the monitor to optimize eye comfort.**



# Identifying parts and controls

## Front view

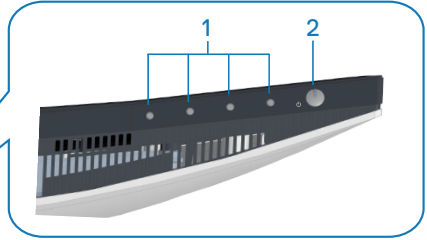

## Control buttons

Label	Description	Use
1	Function buttons	Press the function buttons to adjust items in the OSD menu. (For more information, see <a href="#">Using the control buttons</a> )
2	Power On/Off button (with power-status light)	To turn the monitor on or off.  Solid white light indicates that the monitor is turned on and functioning normally. Blinking white light indicates that the monitor is in Standby Mode.



## Back view

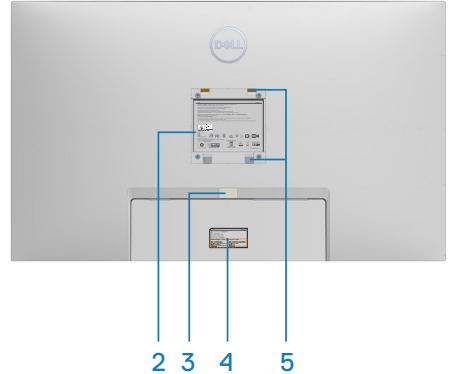
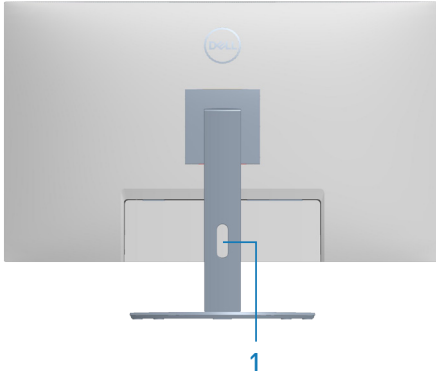

### Back View with monitor stand

Label	Description	Use
1	Cable management slot	Use to organize cables by routing them through the slot.
2	Regulatory information label	Lists the regulatory approvals.
3	Stand release button	Releases the stand from the monitor.
4	Regulatory label (including Barcode serial number and Service Tag label)	Lists the regulatory approvals. Refer to this label if you need to contact Dell for technical support. The Service Tag is a unique alphanumeric identifier that enables Dell service technicians to identify the hardware components in your computer and access warranty information.
5	VESA mounting holes (4)	Four VESA mounting holes (100 mm x 100 mm) accessible behind the VESA cover used for wall mounting the monitor through a VESA-compatible wall mount kit. See <a href="#">Wall mounting (optional)</a> .



## Side view

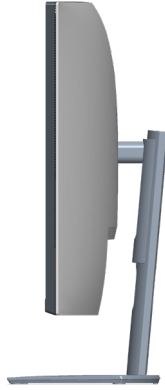

## Bottom view

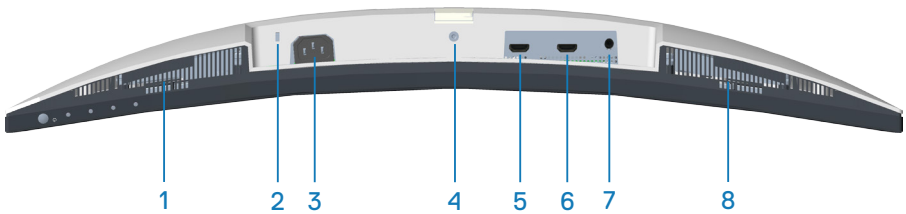

### Bottom view without monitor stand

Label	Description	Use
1	Built-in right speaker	Provides audio output.
2	Security-lock slot	Secure your monitor using a security lock (purchased separately) to prevent unauthorized movement of your monitor. See <a href="#">Securing your monitor using Kensington lock (optional)</a> .
3	Power connector	Connect the power cable (shipped with your monitor).
4	Stand lock feature	To lock the stand to the monitor using a M3 x 6 mm screw (screw not included).
5	HDMI1.4 port	Connect to your computer using a HDMI cable.



<b>6</b>	HDMI2 1.4 port	Connect to your computer using a HDMI cable.
<b>7</b>	Audio line out port	Connect to an external speaker or a sub-woofer (purchased separately).*
<b>8</b>	Built-in left speaker	Provides audio output.

\*Audio line out port does not support headphones.



## Monitor specifications

<b>Model</b>	<b>S3222HS</b>
Screen type	Active matrix-TFT LCD
Panel type	Vertical Alignment
Viewable image	
Diagonal	801.30 mm (31.55 in.)
Horizontal, Active Area	698.40 mm (27.50 in.)
Vertical, Active Area	392.85 mm (15.47 in.)
Area	274366.44 mm <sup>2</sup> (425.27 in. <sup>2</sup> )
Native resolution and refresh rate	1920 x 1080 at 60 Hz
Pixel pitch	0.36375 mm x 0.36375 mm
Pixel per inch (PPI)	70
Viewing angle	
Horizontal	178° (typical)
Vertical	178° (typical)
Luminance output	300 cd/m <sup>2</sup> (typical)
Contrast ratio	3000 to 1 (typical)
Faceplate coating	SAG 40%, 3H
Backlight	LED edgelight system
Response time	8 ms gray to gray in <b>Normal</b> mode 5 ms gray to gray in <b>Fast</b> mode 4 ms gray to gray in <b>Extreme</b> mode  <b>NOTE: The 4 ms gray-to-gray mode is achievable in the Extreme mode to reduce visible motion blur and increased image responsiveness. However this may introduce some slight and noticeable visual artifacts into the image. As every system setup and every user's needs are different modes to find the setting that is right for them.</b>
Curvature	1800R (typical)



Color depth	16.7M colors (RGB 8-bits)
Color gamut	99% sRGB (typical)
Connectivity	2 x HDMI 1.4 with HDCP 1.4 (1920 x 1080, up to 75 Hz) 1 x Audio line out
Bezel width (edge of monitor to active area)	
Top	7.57 mm
Left/Right	7.61 mm
Bottom	24.35 mm
Adjustability	
Height adjustable stand	70 mm
Tilt	-5° to 21°
Swivel	N/A
Slant Adjust	-4° to 4°
Dell display manager compatibility	Easy Arrange and other key features
Security	Security-lock slot (cable lock optional purchase)

## Speaker Specifications

Speaker rated power	2 x 5 W
Frequency Response	200 Hz - 16 kHz
Impedance	8 ohm



## Resolution specifications

<b>Model</b>	<b>S3222HS</b>
Horizontal scan range	30 kHz to 83 kHz
Vertical scan range	48 Hz to 75 Hz
Maximum preset resolution	1920 x 1080 at 75 Hz

## Supported video modes

<b>Model</b>	<b>S3222HS</b>
Video display capabilities	480p, 480i, 576p, 720p, 1080p, 576i, 1080i

 **NOTE: This monitor supports AMD FreeSync™.**





## Preset display modes

Display Mode	Horizontal Frequency (kHz)	Vertical Frequency (Hz)	Pixel Clock (MHz)	Sync Polarity (Horizontal / Vertical)
VESA, 640 x 480	31.47	60.0	25.175	-/-
VESA, 640 x 480	37.5	75.0	31.5	-/-
VESA, 720 x 400	31.47	70.0	28.32	-/+
VESA, 800 x 600	37.88	60.0	40	+/+
VESA, 800 x 600	46.86	75.0	49.5	+/+
VESA, 1024 x 768	48.36	60.0	65	-/-
VESA, 1024 x 768	60.02	75.0	78.75	+/+
VESA, 1152 x 864	67.5	75.0	108	+/+
VESA, 1280 x 1024	63.98	60.0	108	+/+
VESA, 1280 x 1024	79.98	75.0	135	+/+
VESA, 1600 x 900	60	60	108	+/+
VESA, 1920 x 1080	67.5	60	148.5	+/+
VESA, 1920 x 1080	83.89	75	174.5	-/+



## Electrical specifications

Model	S3222HS
Video input signals	HDMI 1.4 (HDCP), 600 mV for each differential line, 100 ohm input impedance per differential pair
AC input voltage/ frequency/current	100 VAC to 240 VAC / 50 Hz or 60 Hz $\pm$ 3 Hz / 1.6 A (max.)
Inrush current	120 V: 30 A (max.) at 0°C (cold start) 240 V: 60 A (max.) at 0°C (cold start)
Power consumption	0.3 W (Off mode) <sup>1</sup> 0.3 W (Standby Mode) <sup>1</sup> 26 W (On Mode) <sup>1</sup> 52 W (Max.) <sup>2</sup> 25 W (Pon) <sup>3</sup> 78.36 kWh (TEC) <sup>3</sup>

<sup>1</sup> As defined in EU 2019/2021 and EU 2019/2013.

<sup>2</sup> Max brightness and contrast setting with maximum.

<sup>3</sup> Pon: Power consumption of On Mode measured with reference to Energy Star test method.

TEC: Total energy consumption in kWh measured with reference to Energy Star test method.

This document is informational only and reflects laboratory performance. Your product may perform differently, depending on the software, components and peripherals you ordered and shall have no obligation to update such information.

Accordingly, the customer should not rely upon this information in making decisions about electrical tolerances or otherwise. No warranty as to accuracy or completeness is expressed or implied.



## Physical characteristics

<b>Model</b>	<b>S3222HS</b>
Signal cable type	Digital: HDMI, 19 pins
<b>Dimensions (with stand)</b>	
Height (extended)	518.11 mm (20.40 in.)
Height (compressed)	448.11mm (17.64 in.)
Width	709.22 mm (27.92 in.)
Depth	217.05 mm (8.55 in.)
<b>Dimensions (without stand)</b>	
Height	424.77 mm (16.72 in.)
Width	709.22 mm (27.92 in.)
Depth	64.04 mm (2.52 in.)
<b>Stand dimensions</b>	
Height	382.20 mm (15.05 in.)
Width	302.01 mm (11.89 in.)
Depth	217.05 mm (8.55 in.)
<b>Weight</b>	
Weight with packaging	14.95 kg (32.96 lb)
Weight with stand assembly and cables	10.26 kg (22.62 lb)
Weight without stand assembly (no cables)	6.78 kg (14.95 lb)
Weight of stand assembly	3.12 kg (6.88 lb)
Front-frame gloss	Black frame 2-4 gloss units



## Environmental characteristics

<b>Model</b>	<b>S3222HS</b>
<b>Compliant Standards</b>	
<ul style="list-style-type: none"> <li>• RoHS-compliant</li> <li>• BFR/PVC reduce monitor (Its circuit boards are made from BFR/PVC-free laminates.)</li> <li>• Arsenic-free glass and Mercury-free for the panel only</li> </ul>	
<b>Temperature</b>	
Operating	0°C to 40°C (32°F to 104°F)
Non-operating	<ul style="list-style-type: none"> <li>• Storage: -20°C to 60°C (-4°F to 140°F)</li> <li>• Shipping: -20°C to 60°C (-4°F to 140°F)</li> </ul>
<b>Humidity</b>	
Operating	10% to 80% (non-condensing)
Non-operating	<ul style="list-style-type: none"> <li>• Storage 10% to 90% (non-condensing)</li> <li>• Shipping 10% to 90% (non-condensing)</li> </ul>
<b>Altitude</b>	
Operating (maximum)	5,000 m (16,400 ft)
Non-operating (maximum)	12,192 m (40,000 ft)
<b>Thermal dissipation</b>	<ul style="list-style-type: none"> <li>• 177.84 BTU/hour (maximum)</li> <li>• 88.92 BTU/hour (On Mode)</li> </ul>



## Plug and play capability

You can install the monitor in any Plug and Play-compatible system. The monitor automatically provides the computer system with its Extended Display Identification Data (EDID) using Display Data Channel (DDC) protocols so the system can configure itself and optimize the monitor settings. Most monitor installations are automatic, you can select different settings if desired. For more information about changing the monitor settings, see [Operating your monitor](#).

## LCD monitor quality and pixel policy

During the LCD Monitor manufacturing process, it is not uncommon for one or more pixels to become fixed in an unchanging state which are hard to see and do not affect the display quality or usability. For more information on Dell Monitor Quality and Pixel Policy, see Dell Support site at [www.dell.com/pixelguidelines](http://www.dell.com/pixelguidelines).



# Setting up the monitor

## Connecting the stand

 **NOTE:** The stand is detached when the monitor is shipped from the factory.

 **NOTE:** The following procedure is applicable for the stand that shipped with your monitor. If you are connecting a third-party stand, see the documentation that shipped with the stand.

To attach the monitor stand:

1. Follow the instructions on the flaps of packaging box to remove the stand from the top cushion that secures it.
2. Connect the stand base to the stand riser.
3. Open the screw handle on the stand base and tighten the screw to secure the stand riser to the stand base.
4. Close the screw handle.

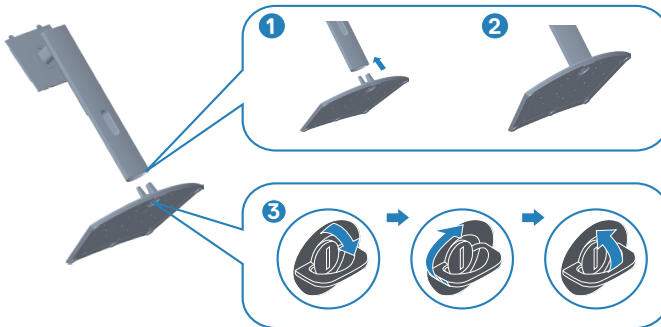

5. Slide the tabs on the stand assembly into the slots on the monitor and press the stand assembly down to snap it into place.



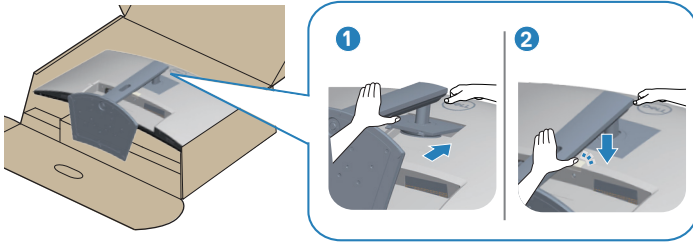

6. Place the monitor in an upright position.

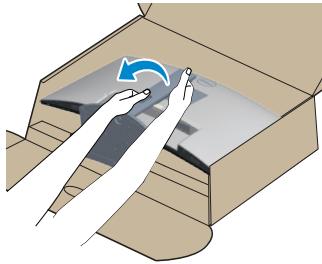

## Connecting your monitor

**⚠ WARNING:** Before you begin any of the procedures in this section, follow the [Safety instructions](#).

**📎 NOTE:** Do not connect all cables to the monitor at the same time. It is recommend to route the cables through the cable-management slot before you connect them to the monitor.

To connect your monitor to the computer:

1. Turn off your computer and disconnect the power cable.
2. Connect the HDMI cable from your monitor to the computer.

## Connecting the HDMI cable

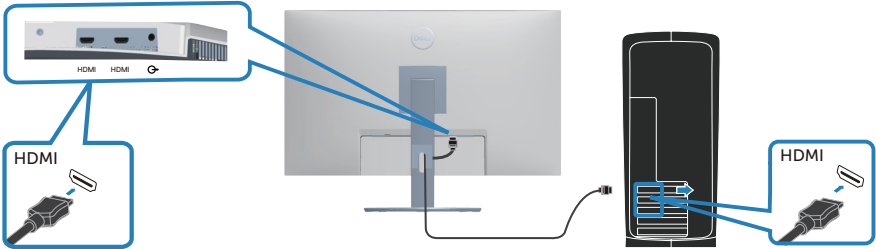

3. Connect the power cable from your computer and monitor into a wall outlet.

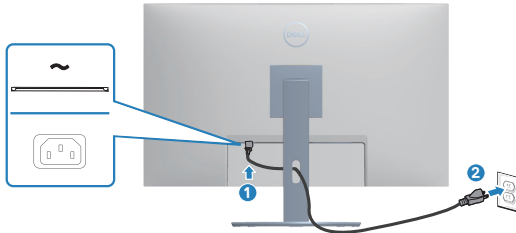



## Organizing cables

Use the cable-management slot to route the cables connected to your monitor.

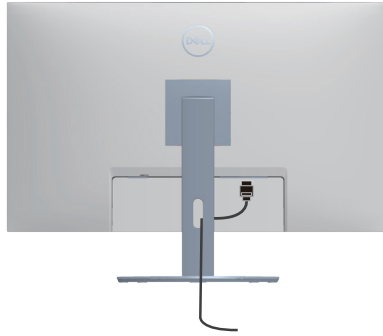

4. Turn on the Monitor.

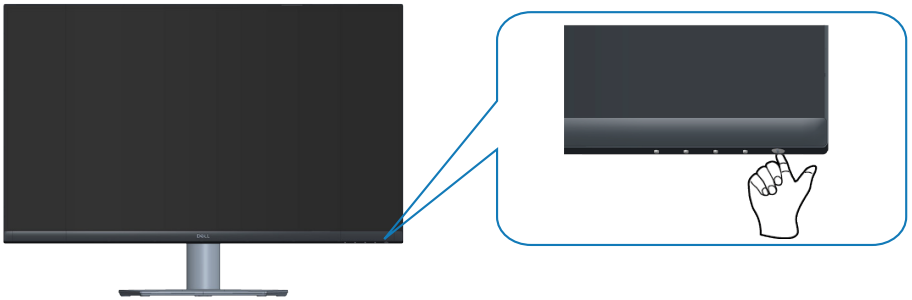

## Securing your monitor using Kensington lock (optional)

You can fasten the monitor using a Kensington security lock to a fixed object that could support the weight of the monitor to prevent it from falling accidentally.

The security lock slot is located at the bottom of the monitor. (See [Security-lock slot](#))

For more information on using the Kensington lock (purchased separately), see the documentation that is shipped with the lock.

Secure your monitor to a table using the Kensington security lock.

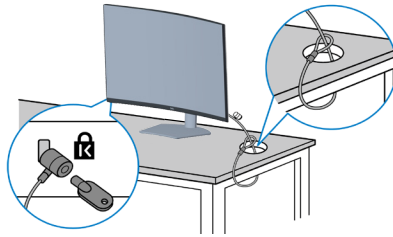

**NOTE:** The image is for the purpose of illustration only. Appearance of the lock may vary.



## Removing the stand

- NOTE: To prevent scratches on the screen when removing the stand, ensure that the monitor is placed on a soft and clean surface.
- NOTE: The following procedure is applicable only for the stand that shipped with your monitor. If you are connecting a third-party stand, see the documentation that shipped with the stand.

To remove the stand:

1. Place the monitor on a soft cloth or cushion at the edge of the desk.

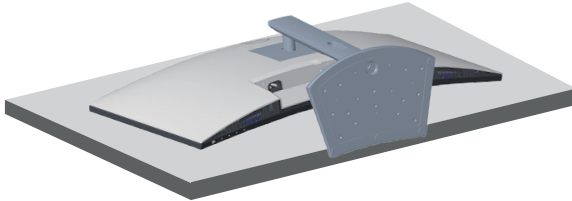

2. Press and hold the stand release button at the back of the display.

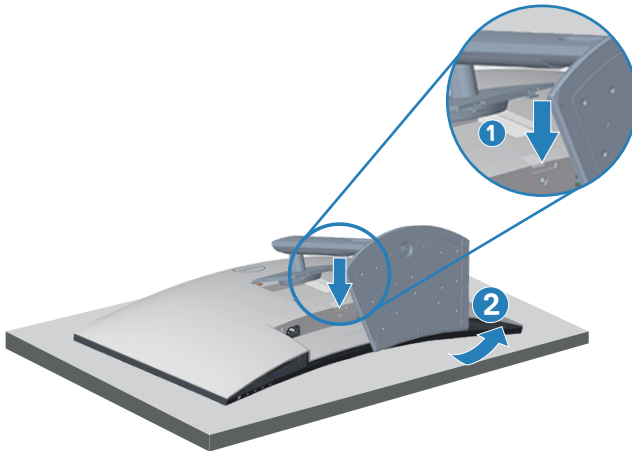

3. Lift the stand assembly up and away from the monitor.



## Wall mounting (optional)

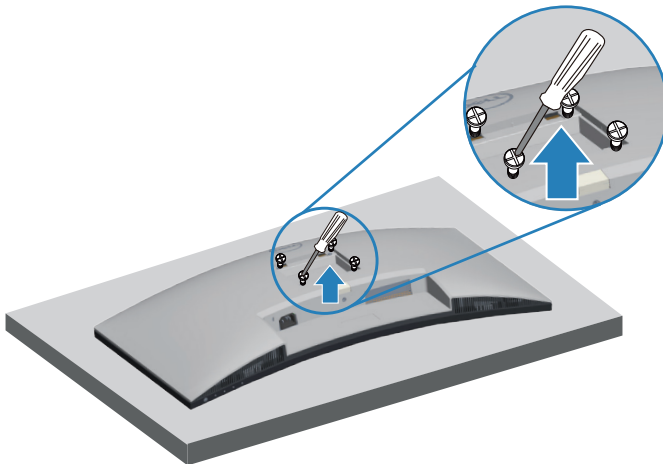

(Screw dimension: M4 x 10 mm).

See the documentation that shipped with the VESA-compatible wall mounting kit.

1. Place the display on a soft cloth or cushion at the edge of the desk.
2. Remove the stand. See [Removing the stand](#) .
3. Remove the four screws that secure the display back cover.
4. Install the mounting bracket from the wall mounting kit to the display.
5. To mount the monitor on the wall, see the documentation that shipped with the wall mounting kit.

 **NOTE: For use only with UL or CSA or GS-listed wall mount bracket with minimum weight/load bearing capacity of 27.12 kg.**



# Operating your monitor

## Power on the monitor

Press the  button to turn on the monitor.

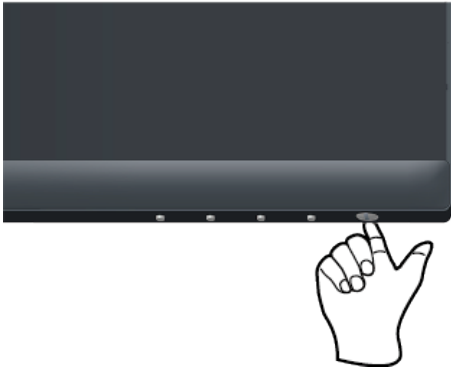



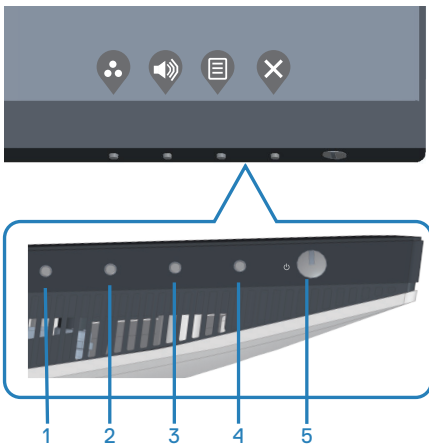

## Using the control buttons

Use the control buttons at the bottom edge of the monitor to adjust the image being displayed.



## Control buttons

The following table describes the control buttons:





Control Buttons	Description
1  Shortcut key/Preset Modes	Use this button for choose from a list of preset modes.
2  Shortcut key/Volume	Use this button to adjust the volume. Minimum is '0' (-). Maximum is '100' (+).
3  Menu	Use the <b>Menu</b> button to launch the On-Screen Display (OSD) menu. See <a href="#">Accessing the OSD menu</a> .
4  Exit	Use this button to go back to the main menu or exit the OSD main menu.
5  Power (with power light indicator)	To turn the monitor on or off. Solid white light indicates that the monitor is turned on and functioning normally. Blinking white light indicates that the monitor is in Standby Mode.

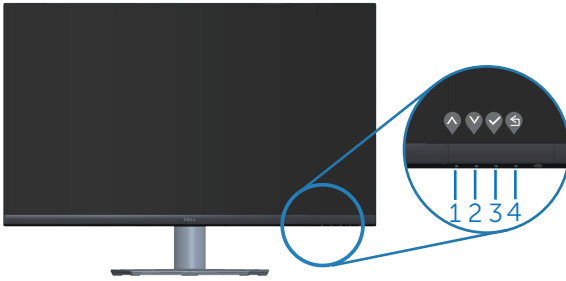

## OSD controls

Use the buttons on the bottom of the monitor to adjust the image settings.



	Control Buttons	Description
1	 Up	Use the <b>Up</b> button to increase values or move up in a menu.
2	 Down	Use the <b>Down</b> button to decrease values or move down in a menu.
3	 OK	Use the <b>OK</b> button to confirm your selection in a menu.
4	 Back	Use the <b>Back</b> button to go back to the previous menu.

















# Using the On-Screen Display (OSD) menu

## Accessing the OSD menu







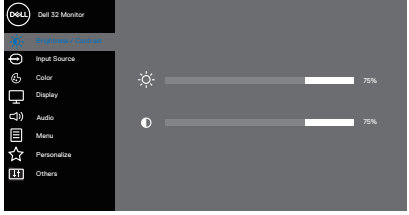

 **NOTE:** Any changes you make are automatically saved when you move to another menu, exit the OSD menu, or wait for the OSD menu to automatically close.

1. Press the  button to display the OSD main menu.









2. Press the  and  buttons to move between the setting options. As you move from one icon to another, the option is highlighted.
3. Press the , , or  button once to activate the highlighted option.
4. Press  and  button to select the desired parameter.
5. Press  and then use the  and  buttons, according to the indicators on the menu, to make your changes.
6. Select the  to return to previous menu or  to accept and return to previous menu.

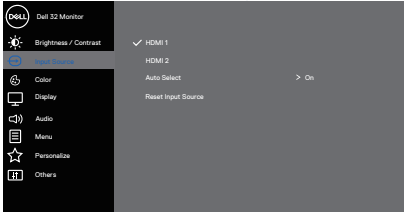

Icon	Menu and Submenus	Description
	<b>Brightness/ Contrast</b>	<p>Use this menu to activate Brightness/Contrast adjustment.</p>  <p style="text-align: right;">     </p>
	<b>Brightness</b>	<p>Brightness adjusts the luminance of the backlight. Press the  button to increase the brightness and press the  button to decrease the brightness (min. 0 / max. 100).</p>
	<b>Contrast</b>	<p>Adjust the brightness first, and then adjust the contrast only if further adjustment is necessary. Press the  button to increase the contrast and press the  button to decrease the contrast (min. 0 / max. 100).</p> <p>The <b>contrast</b> function adjusts the degree of difference between darkness and lightness on the monitor screen.</p>

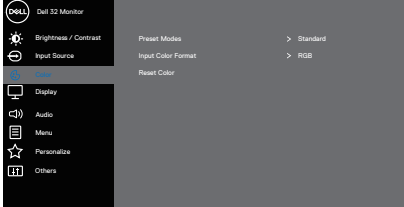

	<p><b>Input Source</b></p>	<p>Use the input source menu to select between the different video signals that may be connected to your monitor.</p>  
	<p><b>HDMI 1</b></p>	<p>Select HDMI 1 input when you are using the HDMI 1 connector. Push  to select the HDMI input source.</p>
	<p><b>HDMI 2</b></p>	<p>Select HDMI 2 input when you are using the HDMI 2 connector. Push  to select the HDMI input source.</p>
	<p><b>Auto Select</b></p>	<p>Choose <b>Auto Select</b> to scan for available input signals.</p>
	<p><b>Reset Input Source</b></p>	<p>Select this option to restore default Input Source.</p>
	<p><b>Color</b></p>	<p>Use color to adjust the color setting mode.</p>  



## Preset Modes

When you select **preset modes**, you can choose **Standard**, **Comfortview**, **Movie**, **FPS**, **RTS**, **RPG**, **Warm**, **Cool**, or **Custom color** from the list.





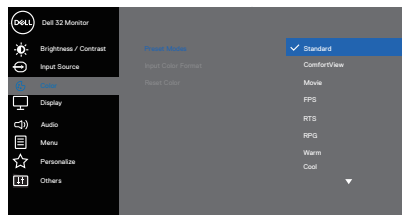

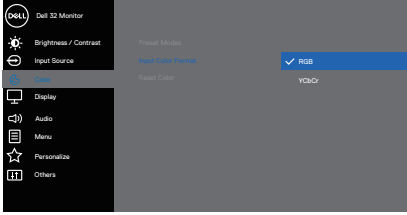
- **Standard:** Loads the monitor's default color settings. This is the default preset mode.
- **ComfortView:** Decreases the level of blue light emitted from the screen to make viewing more comfortable for your eyes.
- **Movie:** Loads color settings ideal for movies.
- **FPS:** Loads color settings ideal for First-Person Shooter games.
- **RTS:** Loads color settings ideal for Real-time Strategy games.
- **RPG:** Loads color settings ideal for Role-Playing games.
- **Warm:** Increases the color temperature. The screen appears warmer with a red/yellow tint.
- **Cool:** Decreases the color temperature. The screen appears cooler with a blue tint.
- **Custom Color:** Allows you to manually adjust the color settings.

Press the ▲ and ▼ buttons to adjust the three colors (R, G, B) values and create your own preset color mode.

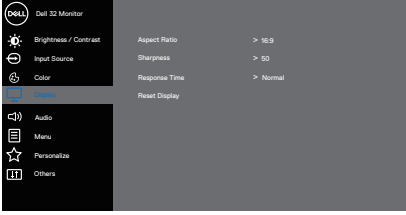

<p><b>Input Color Format</b></p>	<p>Allows you to set the video input mode to:</p> <ul style="list-style-type: none"> <li>• <b>RGB:</b> Select this option if your monitor is connected to a computer or a media player that supports RGB output.</li> <li>• <b>YCbCr:</b> Select this option if your media player supports only YCbCr output.</li> </ul> 
<p><b>Hue</b></p>	<p>This feature can shift the color of the video image to green or purple. This is used to adjust the desired flesh tone color. Use ▲ or ▼ to adjust the hue from 0 to 100.</p> <p>Press ▲ to increase the green shade of the video image.</p> <p>Press ▼ to increase the purple shade of the video image.</p> <p><b>NOTE: Hue adjustment is available only when you select Movie, FPS, RTS, or RPG mode.</b></p>
<p><b>Saturation</b></p>	<p>This feature can adjust the color saturation of the video image. Use ▲ or ▼ to adjust the saturation from 0 to 100.</p> <p>Press ▲ to increase the colorful appearance of the video image.</p> <p>Press ▼ to increase the monochrome appearance of the video image.</p> <p><b>NOTE: Saturation adjustment is available only when you select Movie, FPS, RTS, or RPG mode.</b></p>
<p><b>Reset Color</b></p>	<p>Resets your monitor's color settings to the factory default.</p>

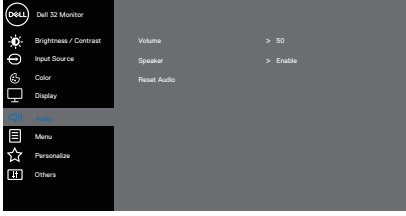

	<p><b>Display</b></p>	<p>Use the <b>display</b> to adjust image.</p>  
	<p><b>Aspect Ratio</b></p>	<p>Adjusts the image ratio to 16:9, 4:3 or 5:4.</p>
	<p><b>Sharpness</b></p>	<p>This feature can make the image look sharper or softer. Use  or  to adjust the sharpness from 0 to 100.</p>
	<p><b>Response Time</b></p>	<p>User can select between Normal, Fast or Extreme.</p>
	<p><b>Reset Display</b></p>	<p>Resets all display settings to the factory default values.</p>
	<p><b>Audio</b></p>	<p>Use the <b>Audio</b> to adjust audio.</p>  
	<p><b>Volume</b></p>	<p>Use the buttons to adjust the volume. Minimum is '0' (-).Maximum is '100' (+).</p>
	<p><b>Speaker</b></p>	<p>Select this option to active the speaker.</p>
	<p><b>Reset Audio</b></p>	<p>Select this option to restore default display settings.</p>





## Menu

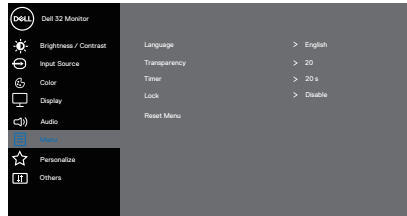

Select this option to adjust the settings of the OSD, such as, the languages of the OSD, the amount of time the menu remains on screen and so on.





## Language

Language options set the OSD display to one of the eight languages (English, Spanish, French, German, Brazilian Portuguese, Russian, Simplified Chinese, or Japanese).

## Transparency

Select this option to change the menu transparency by pressing the  and  buttons from 0 to 100.

## Timer

OSD hold time: sets the length of time the OSD will remain active after the last time you pressed a button. Use  or  to adjust the slider in 1 second increments, from 5 to 60 seconds.

## Lock

Controls user access to adjustments. User can select one of the following: Menu Buttons, Power Button, Menu + Power Buttons, Disable.

## Reset Menu

Reset all OSD settings to the factory preset values.





## Personalize

Select this option to adjust the settings of the personalization.

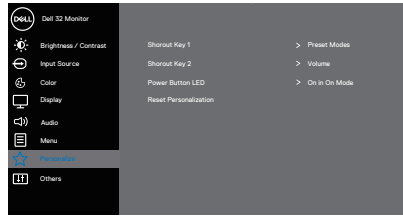

## Shortcut Key 1

User can select one of the following: Preset Modes, Brightness/Contrast, Input Source, Aspect Ratio, Volume to set the shortcut key 1.

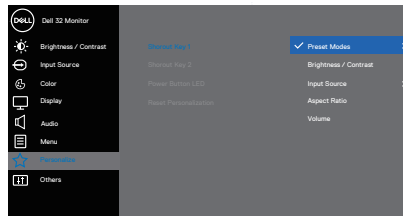



## Shortcut Key 2

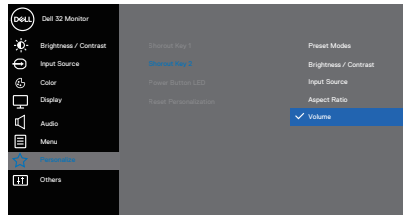

User can select one of the following: Preset Modes, Brightness/Contrast, Input Source, Aspect Ratio, Volume to set the shortcut key 2.

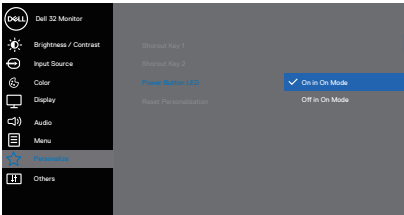

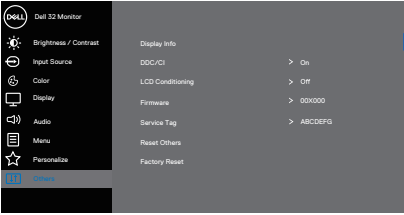
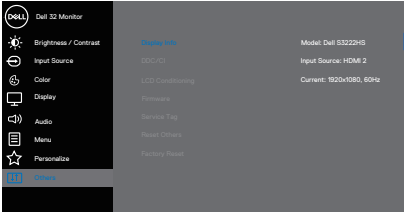

	<p><b>Power Button LED</b></p>	<p>Allows you to set the power LED indicator <b>On in On Mode</b> or <b>Off in On Mode</b> to save energy.</p>  <p style="text-align: right;">▲ ▼ ✓ ✎</p>
	<p><b>Reset Personalization</b></p>	<p>Reset all settings under the personalize menu to the default setting.</p>
	<p><b>Others</b></p>	<p>Select this option to adjust the OSD settings, such as the DDC/CI, LCD conditioning, and so on.</p>  <p style="text-align: right;">▲ ▼ ▶ ✕</p>
	<p><b>Display Info</b></p>	<p>Displays the monitor's current settings.</p>  <p style="text-align: right;">▲ ▼ ✓ ✎</p>

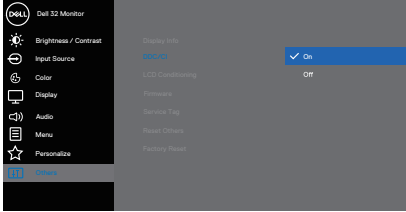

<p><b>DDC/CI</b></p>	<p>DDC/CI (display data channel/command interface) allows your monitor parameters (brightness, color balance and etc.) to be adjustable via the software on your computer.</p> <p>You can disable this feature by selecting off.</p> <p>Enable this feature by selecting on for best user experience and optimum performance of your monitor.</p> 
<p><b>LCD Conditioning</b></p>	<p>Helps reduce minor cases of image retention. Depending on the degree of image retention, the program may take some time to run. To start LCD conditioning, select on.</p>
<p><b>Firmware</b></p>	<p>Display the version of the firmware about the display.</p>
<p><b>Service Tag</b></p>	<p>Display the service tag number of the display. The Service Tag is a unique alphanumeric identifier that allows Dell to identify the product specifications and access warranty information.</p> <p> <b>NOTE: The Service Tag is also printed on a label located at the back of the cover.</b></p>
<p><b>Reset Others</b></p>	<p>Reset all settings under the others setting menu to the factory preset values.</p>
<p><b>Factory Reset</b></p>	<p>Restore all preset values to the factory default settings.</p>

 **NOTE: Your monitor has a built-in feature to automatically calibrate the brightness to compensate for LED aging.**



## Menu and Power button lock

Prevents users to access or change OSD menu settings on the display.

By default, the Menu and Power button lock setting is disabled.

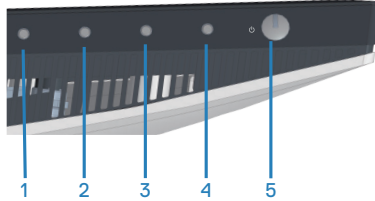

To access the lock menu, press and hold the **Exit** button (button 4) for four seconds. A lock menu appears at the bottom right corner of the display.

**NOTE:** The lock menu can be accessed using this method when the Menu and Power buttons are in unlocked state.

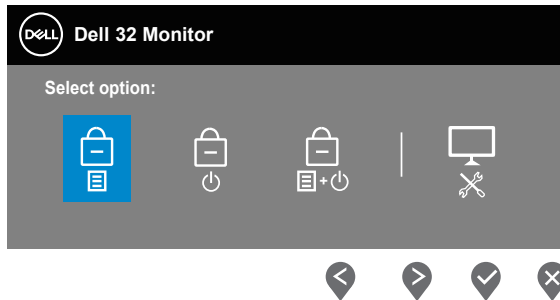



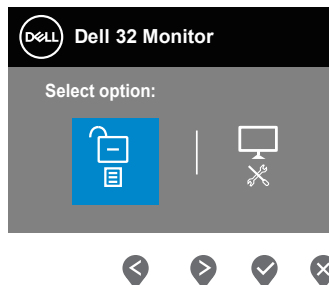

To access the unlock menu, press and hold the **Exit** button (button 4) for four seconds. An unlock menu appears at the bottom right corner of the display.

**NOTE:** The unlock menu can be accessed when the Menu and Power buttons are in locked state.



There are three lock options.

	<b>Menu</b>	<b>Description</b>
1	Menu Buttons 	When <b>Menu Buttons</b> is selected, the OSD menu settings cannot be changed. All buttons are locked except Power button.
2	Power Button 	When <b>Power Button</b> is selected, the display cannot be turned off using the Power button.
3	Menu + Power Buttons 	When <b>Menu + Power Buttons</b> is selected, the OSD menu settings cannot be changed and the Power button is locked.
4	Built-in Diagnostics 	See <a href="#">Built-in diagnostics</a> for more information.

 **NOTE: To access the Lock or Unlock menu – Press and hold the Exit button (button 4) for four seconds.**

In the following scenarios, the  icon appears at the center of the display:

- When Up button (button 1), Down button (button 2), Menu button (button 3), or Exit button (button 4) are pressed. This indicates the OSD menu buttons are in lock state.
- When the Power button (button 5) is pressed. This indicates the Power button is in lock state.
- When any one of the five buttons are pressed. This indicates OSD menu buttons and the Power button is in lock state.

#### **Unlocking the OSD menu and Power buttons :**

1. Press and hold the Exit button (button 4) for four seconds. The unlock menu appears.
2. Select the unlock icon  to unlock the buttons on the display.



## OSD warning messages

When the monitor does not support a particular resolution mode, the following message is displayed:

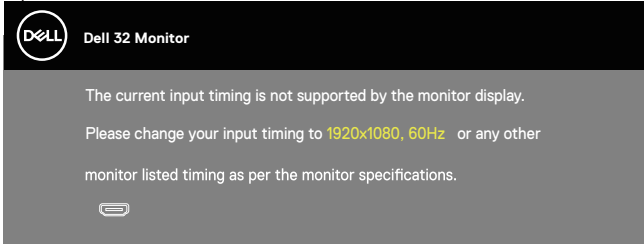

This means that the monitor cannot synchronize with the signal that it is receiving from the computer. See [Resolution specifications](#) for the Horizontal and Vertical frequency ranges addressable by this monitor. Recommended mode is 1920 x 1080.

Before the **DDC/CI** function is disabled, the following message is displayed:

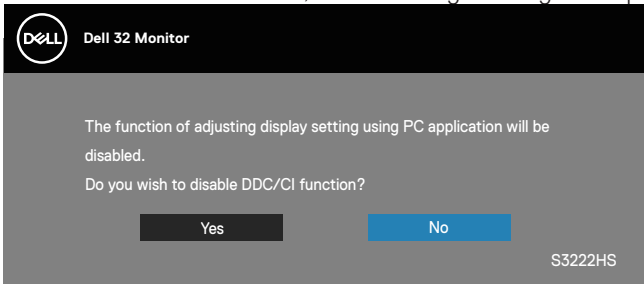

When the monitor enters the **Standby Mode**, the following message appears:

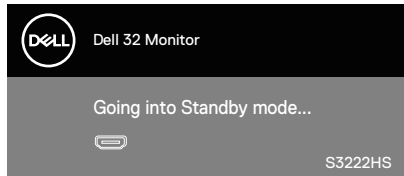

If HDMI cable is not connected, a floating dialog box as shown below appears. The monitor will enter Standby Mode after 4 minutes if left at this state.

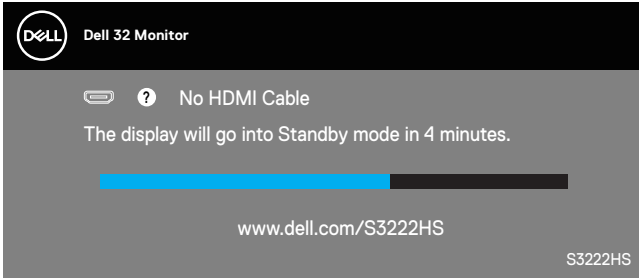

The OSD functions only in the normal operation mode. When any button is pressed in the Standby Mode, the following message will be displayed:

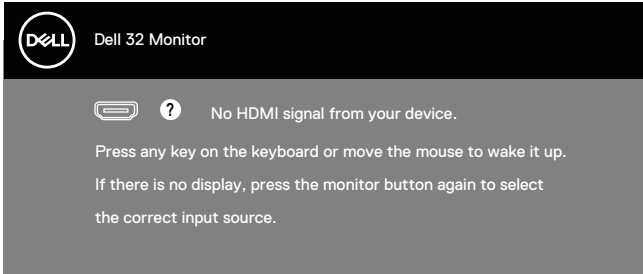

Activate the computer and the monitor to gain access to the OSD.



## Setting the maximum resolution

To set the maximum resolution for the monitor:

In Windows® 8, Windows® 8.1:

1. For Windows 8 and Windows 8.1 only, select the Desktop tile to switch to classic desktop.
2. Right-click on the desktop and click **Screen Resolution**.
3. Click the dropdown list of the Screen Resolution and select **1920 x 1080**.
4. Click **OK**.

In Windows® 10:

1. Right-click on the desktop and click **Display settings**.
2. Click **Advanced display settings**.
3. Click the dropdown list of the **Choose display** and select the correct display model number.
4. Click **Display adapter properties**.
5. Click **List All Modes** on the new pop-up window and select **1920 x 1080**.
6. Click **OK** and **OK**.

If you do not see **1920 x 1080** as an option, you may need to update your graphics driver. Depending on your computer, complete one of the following procedures:

If you have a Dell desktop or portable computer:

- Go to [www.dell.com/support](http://www.dell.com/support), enter your computer's Service Tag, and download the latest driver for your graphics card.

If you are using a non-Dell computer (portable or desktop):

- Go to the support site for your computer and download the latest graphic drivers.
- Go to your graphics card website and download the latest graphic drivers.



## Using the tilt and vertical extension

 **NOTE:** These values are applicable to the stand that was shipped with your monitor. To set up with any other stand, see the documentation that shipped with the stand.

### Tilt Extension

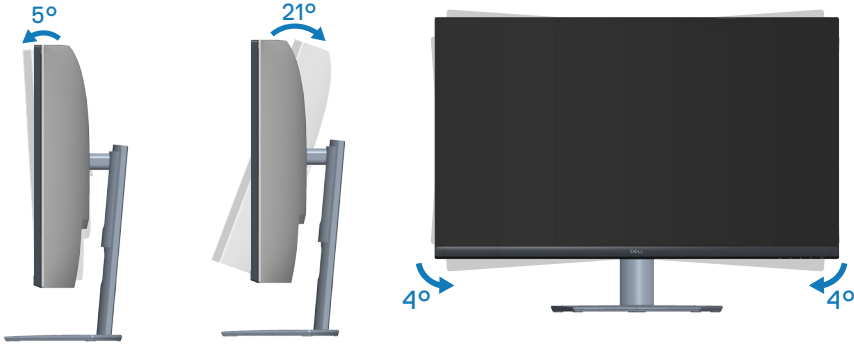

 **NOTE:** The stand is detached when the monitor is shipped from the factory.

 **NOTE:** The slant angle of this monitor is between  $-4^{\circ}$  and  $+4^{\circ}$ , it does not allow pivot movements.

### Vertical Extension

 **NOTE:** The stand can be extended vertically up to 70 mm.





# Ergonomics

△ **CAUTION: Improper or prolonged usage of keyboard may result in injury.**

△ **CAUTION: Viewing the monitor screen for extended periods of time may result in eye strain.**

For comfort and efficiency, observe the following guidelines when setting up and using your computer workstation:

- Position your computer so that the monitor and keyboard are directly in front of you as you work. Special shelves are commercially available to help you correctly position your keyboard.
- To reduce the risk of eye strain and neck/arm/back/shoulder pain from using the monitor for long periods of time, we suggest you to:
  1. Set the distance of the screen between 20 to 28 in. (50 to 70 cm) from your eyes.
  2. Blink frequently to moisten your eyes or wet your eyes with water after prolonged usage of the monitor.
  3. Take regular and frequent breaks for 20 minutes every two hours.
  4. Look away from your monitor and gaze at a distant object at 20 feet away for at least 20 seconds during the breaks.
  5. Perform stretches to relieve tension in the neck, arm, back, and shoulders during the breaks.
- Make sure that the monitor screen is at eye level or slightly lower when you are sitting in front of the monitor.
- Adjust the tilt of the monitor, its contrast, and brightness settings.
- Adjust the ambient lighting around you (such as overhead lights, desk lamps, and the curtains or blinds on nearby windows) to minimize reflections and glare on the monitor screen.
- Use a chair that provides good lower-back support.
- Keep your forearms horizontal with your wrists in a neutral, comfortable position while using the keyboard or mouse.
- Always leave space to rest your hands while using the keyboard or mouse.
- Let your upper arms rest naturally on both sides.
- Ensure that your feet are resting flat on the floor.



- When sitting, make sure that the weight of your legs is on your feet and not on the front portion of your seat. Adjust your chair's height or use a footrest if necessary to maintain a proper posture.
- Vary your work activities. Try to organize your work so that you do not have to sit and work for extended periods of time. Try to stand or get up and walk around at regular intervals.
- Keep the area under your desk clear of obstructions and cables or power cords that may interfere with comfortable seating or present a potential trip hazard.

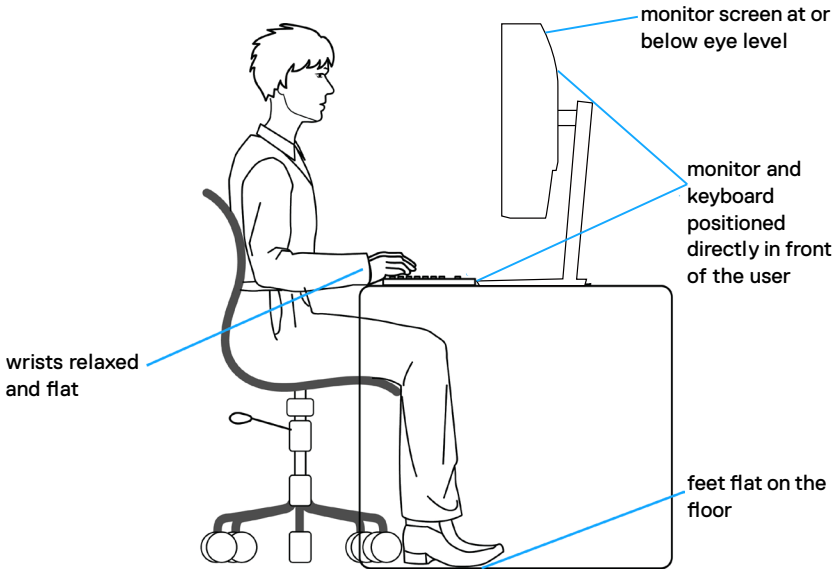

## Handling and moving your display

To ensure the monitor is handled safely when lifting or moving it, follow the guidelines mentioned below:

- Before moving or lifting the monitor, turn off your computer and the monitor.
- Disconnect all cables from the monitor.
- Place the monitor in the original box with the original packing materials.
- Hold the bottom edge and the side of the monitor firmly without applying excessive pressure when lifting or moving the monitor.

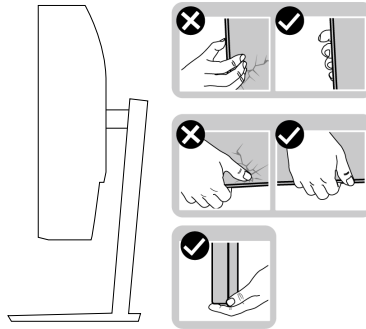

- When lifting or moving the monitor, ensure the screen is facing away from you and do not press on the display area to avoid any scratches or damage.

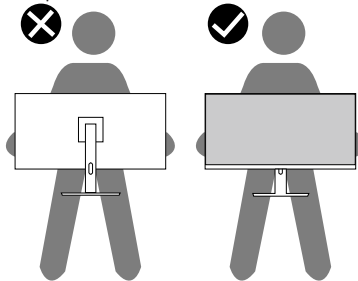

- When transporting the monitor, avoid any sudden shock or vibration to it.
- When lifting or moving the monitor, do not turn the monitor upside down while holding the stand base or stand riser. This may result in accidental damage to the monitor or cause personal injury.



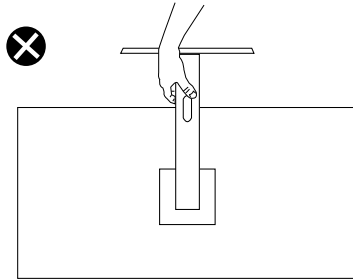

## Maintenance guidelines

### Cleaning your monitor

**⚠ WARNING:** Before cleaning the monitor, unplug the monitor power cable from the electrical outlet.

**⚠ CAUTION:** Read and follow the [Safety instructions](#) before cleaning the monitor.

For best practices, follow the instructions in the list below while unpacking, cleaning or handling your monitor:

- To clean your screen, lightly dampen a soft, clean cloth with water. If possible, use a special screen-cleaning tissue or solution suitable for the anti-static coating. Do not use benzene, thinner, ammonia, abrasive cleaners or compressed air.
- Use a lightly-dampened cloth to clean the monitor. Avoid using detergent of any kind as some detergents leave a milky film on the monitor.
- If you notice white powder when you unpack your monitor, wipe it off with a cloth.
- Handle your monitor with care as the black-colored monitor may get scratched and show white scuff marks.
- To help maintain the best image quality on your monitor, use a dynamically changing screen saver and turn off your monitor when not in use.



# Troubleshooting

**⚠ WARNING:** Before you begin any of the procedures in this section, follow the [Safety instructions](#).

## Self-Test

Your monitor provides a self-test feature that allows you to check if your monitor is functioning properly. If your monitor and computer are properly connected but the monitor screen remains dark, run the monitor self-test by performing the following steps:

1. Turn off both your computer and the monitor.
2. Disconnect all video cables from the monitor. This way, the computer doesn't have to be involved.
3. Turn on the monitor.

If the monitor is working correctly, it detects that there is no signal and one of the following message appears. While in self-test mode, the power LED remains white.

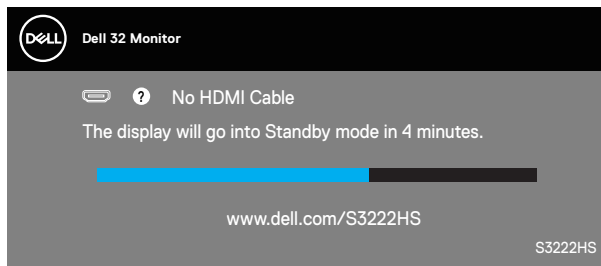

**✎ NOTE:** This box also appears during normal system operation, if the video cable is disconnected or damaged.

4. Turn Off your monitor and reconnect the video cable; then turn on your computer and the monitor.

If your monitor remains dark after you reconnect the cables, check your video controller and computer.



## Built-in diagnostics

Your monitor has a built-in diagnostic tool that helps you determine if any screen abnormality you experience is an inherent problem with your monitor, or with your computer and video card.

**NOTE:** You can run the built-in diagnostics only when the video cable is unplugged and the monitor is in self-test mode.

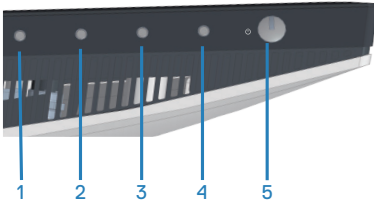

To run the built-in diagnostics:

1. Ensure that the screen is clean (no dust particles on the surface of the screen).
2. Unplug the video cable(s) from the back of the computer or monitor. The monitor then goes into the self-test mode.
3. Press and hold the Exit button (button 4) for four seconds to enter the OSD lock/unlock menu.

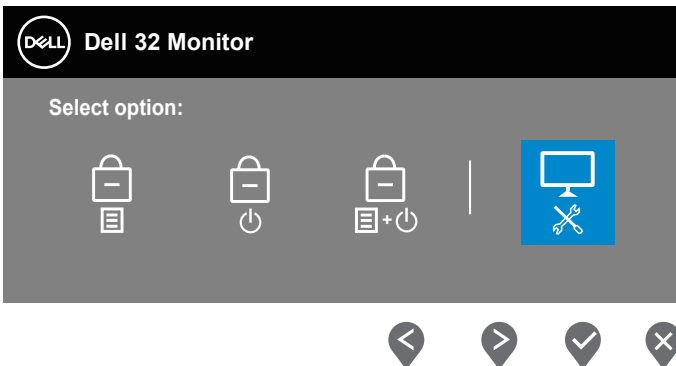

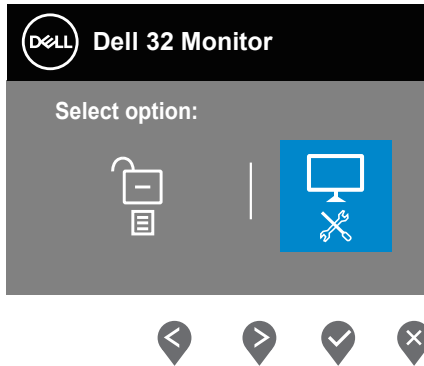

4. Select the  icon to run the built-in diagnostics.
5. Carefully inspect the screen for abnormalities.
6. Press the Up button (button 1) on the back cover again. The color of the screen changes to grey.
7. Inspect the display for any abnormalities.
8. Repeat step 6 and 7 to inspect the display in red, green, blue, black, white and text pattern screens.

The test is complete when the text pattern screen appears. To exit, press the Up button (button 1) again.

If you do not detect any screen abnormalities upon using the built-in diagnostic tool, the monitor is functioning properly. Check the video card and computer.



## Common problems

The following table contains general information about common monitor problems you might encounter and the possible solutions:

Common Symptoms	Possible Solutions
No Video/Power LED off	<p>Ensure that the video cable connecting the monitor and the computer is properly connected and secure.</p> <ul style="list-style-type: none"><li>• Verify that the power outlet is functioning properly using any other electrical equipment.</li><li>• Ensure that the power button is pressed.</li><li>• Ensure that the correct input source is selected via the <a href="#">Input Source</a> menu.</li></ul>
No Video/Power LED on	<ul style="list-style-type: none"><li>• Increase brightness and contrast controls using the OSD.</li><li>• Perform monitor self-test feature check.</li><li>• Check for bent or broken pins in the video cable connector.</li><li>• Run the built-in diagnostics.</li><li>• Ensure that the correct input source is selected via the <a href="#">Input Source</a> menu.</li></ul>
Poor Focus	<ul style="list-style-type: none"><li>• Eliminate video extension cables.</li><li>• Reset the monitor to Factory Settings (<b>Factory Reset</b>).</li><li>• Change the video resolution to the correct aspect ratio.</li></ul>
Shaky/Jittery Video	<ul style="list-style-type: none"><li>• Reset the monitor to Factory Settings (<b>Factory Reset</b>).</li><li>• Check environmental factors.</li><li>• Relocate the monitor and test in another room.</li></ul>
Missing Pixels	<ul style="list-style-type: none"><li>• Cycle power On-Off.</li><li>• Pixel that is permanently Off is a natural defect that can occur in LCD technology.</li><li>• For more information on Dell Monitor Quality and Pixel Policy, see Dell Support site at: <a href="http://www.dell.com/pixelguidelines">www.dell.com/pixelguidelines</a>.</li></ul>





Stuck-on Pixels	<ul style="list-style-type: none"> <li>• Cycle power On-Off.</li> <li>• Pixel that is permanently off is a natural defect that can occur in LCD technology.</li> <li>• For more information on Dell Monitor Quality and Pixel Policy, see Dell Support site at: <a href="http://www.dell.com/pixelguidelines">www.dell.com/pixelguidelines</a>.</li> </ul>
Brightness Problems	<ul style="list-style-type: none"> <li>• Reset the monitor to Factory Settings (<b>Factory Reset</b>).</li> <li>• Adjust brightness &amp; contrast controls via OSD.</li> </ul>
Geometric Distortion	<ul style="list-style-type: none"> <li>• Reset the monitor to Factory Settings (<b>Factory Reset</b>).</li> <li>• Adjust horizontal &amp; vertical controls via OSD.</li> </ul>
Horizontal/Vertical Lines	<ul style="list-style-type: none"> <li>• Reset the monitor to Factory Settings (<b>Factory Reset</b>).</li> <li>• Perform monitor self-test feature check and determine if these lines are also in self-test mode.</li> <li>• Check for bent or broken pins in the video cable connector.</li> <li>• Run the built-in diagnostics.</li> </ul>
Synchronization Problems	<ul style="list-style-type: none"> <li>• Reset the monitor to Factory Settings (<b>Factory Reset</b>).</li> <li>• Perform monitor self-test feature check to determine if the scrambled screen appears in self-test mode.</li> <li>• Check for bent or broken pins in the video cable connector.</li> <li>• Restart the computer in the safe mode.</li> </ul>
Safety Related Issues	<ul style="list-style-type: none"> <li>• Do not perform any troubleshooting steps.</li> <li>• Contact Dell immediately.</li> </ul>
Intermittent Problems	<ul style="list-style-type: none"> <li>• Ensure that the video cable connecting the monitor to the computer is connected properly and is secure.</li> <li>• Reset the monitor to Factory Settings (<b>Factory Reset</b>).</li> <li>• Perform monitor self-test feature check to determine if the intermittent problem occurs in self-test mode.</li> </ul>



Missing Color	<ul style="list-style-type: none"> <li>• Perform monitor self-test feature check.</li> <li>• Ensure that the video cable connecting the monitor to the computer is connected properly and is secure.</li> <li>• Check for bent or broken pins in the video cable connector.</li> </ul>
Wrong Color	<ul style="list-style-type: none"> <li>• Try different <b>Preset Modes</b> in <b>Color</b> settings OSD. Adjust <b>R/G/B</b> value in <b>Custom Color</b> in <b>Color</b> settings OSD.</li> <li>• Change the <b>Input Color Format</b> to <b>RGB</b> or <b>YCbCr</b> in the <b>Color settings</b> OSD.</li> <li>• Run the built-in diagnostics.</li> </ul>
Image retention from a static image left on the monitor for a long period of time	<ul style="list-style-type: none"> <li>• Set the screen to turn off after a few minutes of screen idle time. These can be adjusted in Windows Power Options or Mac Energy Saver setting.</li> <li>• Alternatively, use a dynamically changing screensaver.</li> </ul>
Video Ghosting or Overshooting	<ul style="list-style-type: none"> <li>• Change the <b>Response Time</b> in the <b>Display</b> OSD to <b>Normal, Fast</b> or <b>Extreme</b> depending on your application and usage.</li> </ul>



## Product-specific problems

Specific Symptoms	Possible Solutions
Screen image is too small	<ul style="list-style-type: none"><li>• Check the <b>Aspect Ratio</b> setting in the <b>Display</b> settings OSD.</li><li>• Reset the monitor to Factory Settings (<b>Factory Reset</b>).</li></ul>
Cannot adjust the monitor with the buttons on the bottom of the panel	<ul style="list-style-type: none"><li>• Turn Off the monitor, unplug the power cord, plug it back, and then turn On the monitor.</li><li>• Check if the OSD menu is locked. If yes, press and hold the Exit button (button 4) for four seconds to unlock.</li></ul>
No Input Signal when user controls are pressed	<ul style="list-style-type: none"><li>• Check the signal source. Ensure the computer is not in Standby Mode by moving the mouse or pressing any key on the keyboard.</li><li>• Check if the video cable is plugged in properly. Disconnect and reconnect the video cable if necessary.</li><li>• Reset the computer or video player.</li></ul>
The picture does not fill the entire screen	<ul style="list-style-type: none"><li>• Due to different video formats (aspect ratio) of DVDs, the monitor may display in full screen.</li><li>• Run the built-in diagnostics.</li></ul>



# Appendix

 **WARNING: Use of controls, adjustments, or procedures other than those specified in this documentation may result in exposure to shock, electrical hazards, and/or mechanical hazards.**

For information on safety instructions, see the **Safety Environment and Regulatory Information (SERI)**.

## FCC notices (U.S. Only) and other regulatory information

For FCC notices and other regulatory information, see the regulatory compliance website located at [www.dell.com/regulatory\\_compliance](http://www.dell.com/regulatory_compliance).

## Contacting Dell

**For customers in the United States, call 800-WWW-DELL (800-999-3355).**

 **NOTE: If you do not have an active Internet connection, you can find contact information on your purchase invoice, packing slip, bill, or Dell product catalog.**

Dell provides several online and telephone-based support and service options. Availability varies by country and product, and some services may not be available in your area.

- Online technical assistance — [www.dell.com/support/monitors](http://www.dell.com/support/monitors)
- Contacting Dell — [www.dell.com/contactdell](http://www.dell.com/contactdell)

