

## 1. Important Safety Notice

### Product Announcement:

This product is certificated to meet RoHS Directive and Lead-Free produced definition. Using approved critical components only is recommended when the situation to replace defective parts. Vender assumes no liability express or implied, arising out of any unauthorized modification of design or replacing non-RoHS parts. Service providers assume all liability.

### Qualified Repairability:

Proper service and repair is important to the safe, reliable operation of all series products. The service providers recommended by vender should be aware of notices listed in this service manual in order to minimize the risk of personal injury when perform service procedures. Furthermore, the possible existed improper repairing method may damage equipment or products. It is recommended that service engineers should have repairing knowledge, experience, as well as appropriate product training per new model before performing the service procedures.

### NOTICE:

- ! To avoid electrical shocks, the products should be connected to an authorized power cord, and turn off the master power switch each time before removing the AC power cord.
- ! To prevent the product away from water or expose in extremely high humidity environment.
- ! To ensure the continued reliability of this product, use only original manufacturer's specified parts.
- ! To ensure following safety repairing behavior, put the replaced part on the components side of PWBA, not solder side.

- ! To ensure using a proper screwdriver, follow the torque and force listed in assembly and disassembly procedures to unscrew screws.
- ! Using Lead-Free solder to well mounted the parts.
- ! The fusion point of Lead-Free solder requested in the degree of 220°C.

## 2. Exploded view diagram with list of items

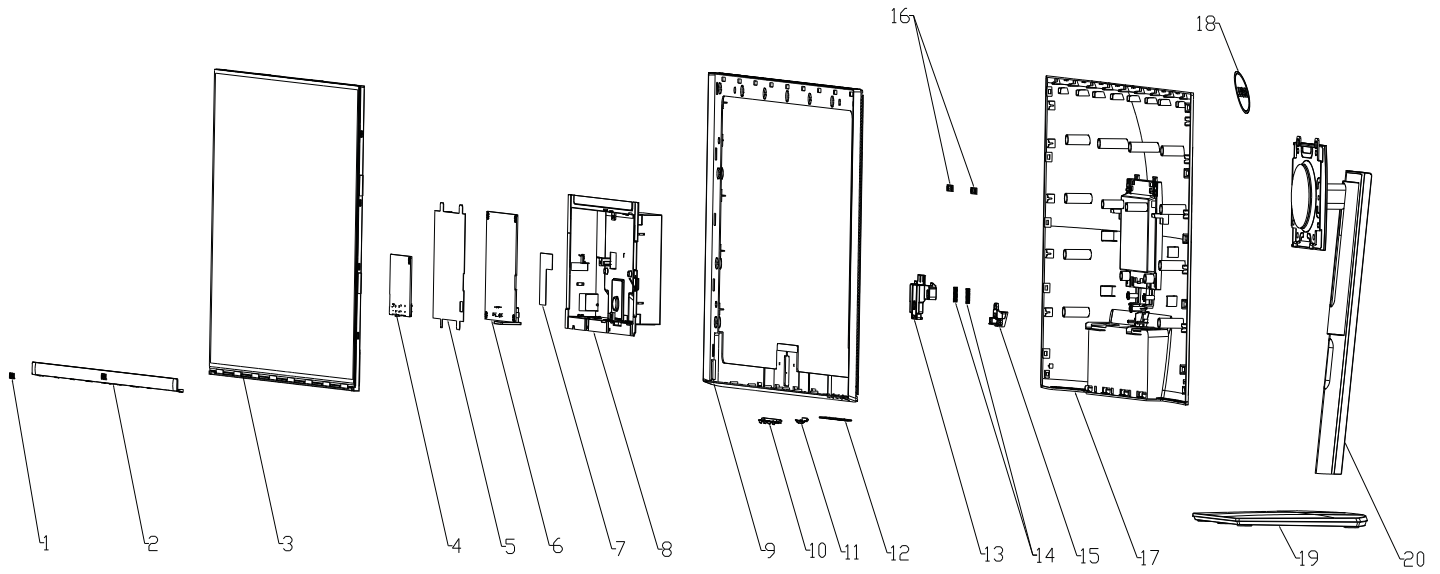

ITEM	PART NAME	QUANTITY
1	DELL front logo	1
2	Front trim	1
3	Panel	1
4	Interface board	1
5	Power mylar	1
6	Power board	1
7	Chassis mylar	1
8	Main chassis	1
9	Mid frame	1
10	OSD button	1
11	Power button	1
12	Function key board	1
13	Stand slider	1
14	Spring	2
15	Release button	1
16	Wallmount metal sheet	2
17	Back cover	1
18	Dell back logo	1
19	Base	1
20	Riser	1

### 3. Wiring Connectivity Diagram

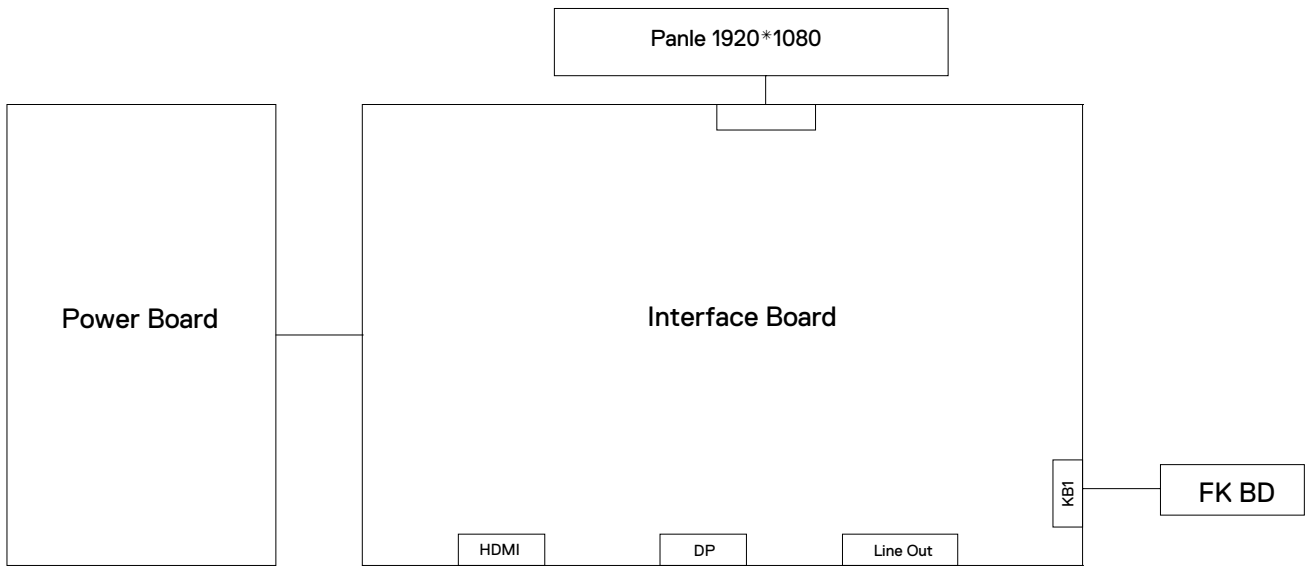

## 4. Disassembly and Assembly Procedures

Necessary repair and test equipment:

1. Philips-head screwdriver

### 4.1 Disassembly Procedures:

Remove the monitor stand base:

S1

1. Place the monitor on a soft cloth or cushion.
2. Press and hold the stand-release button.
3. Lift the stand up and away from the monitor.

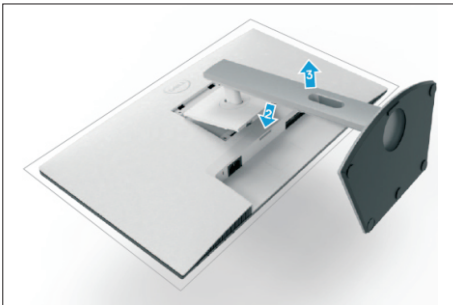

S2

Use a Philips-head screwdriver to remove 4pcs screws for unlocking mechanisms.

(No.1~4 screw size=M4x11; Torque=7~8kgfxcM)

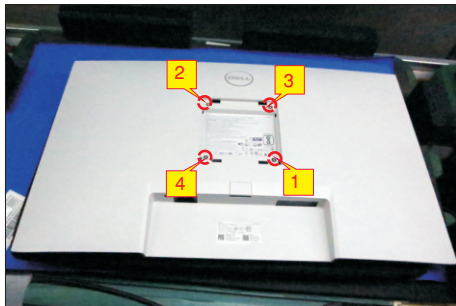

Wedge your fingers between the rear cover and the middle bezel on the corners of the top side of the monitor to release the rear cover, then use one hand to press the middle bezel, the other hand to pull up carefully the rear cover in order of arrow preference for unlocking mechanisms of rear cover.

S3

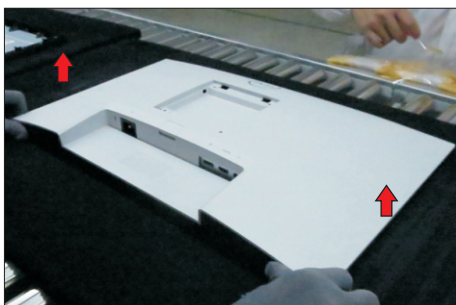
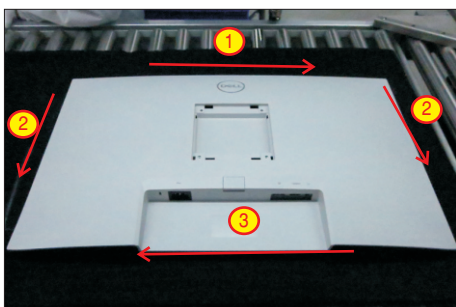

S4

Tear off 1pcs acetate tape and then disconnect the panel lamp cable away from the connector of panel. Tear off 2pcs aluminum foils, and then disconnect the function key cable away from the connector.

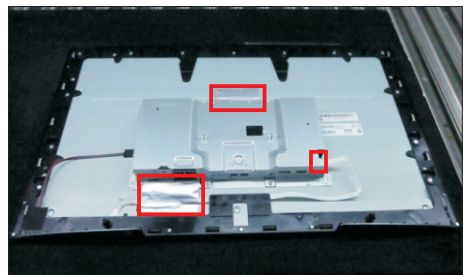
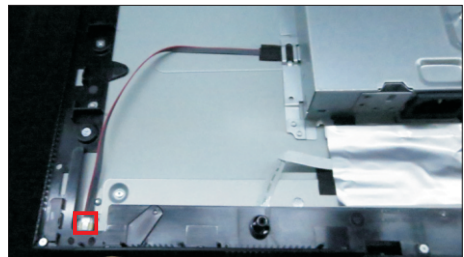
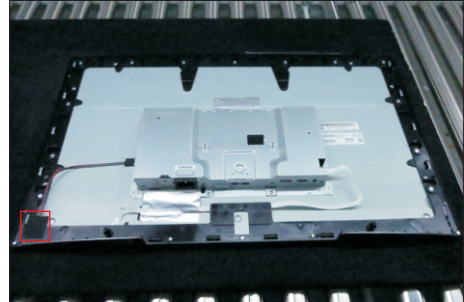

S5

Use a Philips-head screwdriver to remove 18pcs screws for unlocking the middle bezel.

(No.1~13 screw size=M3x4, Torque=3~4kgfxcM;  
No.14~18 screw size=M2x3.3, Torque=1±0.2kgfxcM)

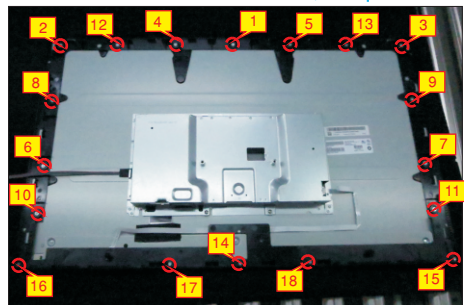

S6

Use a Philips-head screwdriver to remove 2pcs screws for unlocking the bracket with panel module.

(No.1~2 screw size=M3x3, Torque=3~4kgfxcM )

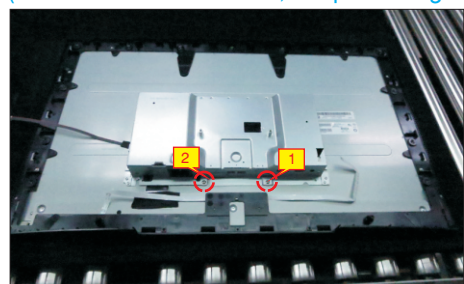

## 4. Disassembly and Assembly Procedures

S7

Take away the middle bezel, and put it on a fixture. Use a Philips-head screwdriver to remove 3pcs screws for unlocking the function key board, and then tear off the tapes for releasing the key cables.

(No.1~3 screw size=M2x2.4, Torque=0.8±0.2kgfxcm)

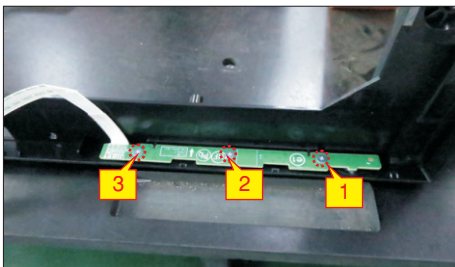
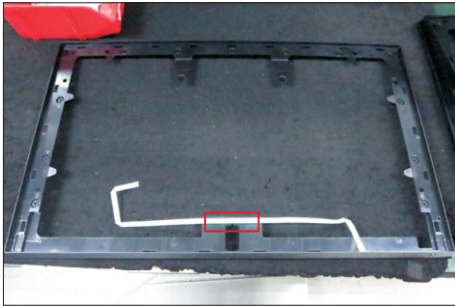

S8

Tear off the tape, then lift up the panel module with the bracket chassis for releasing the front bezel away from the panel module.

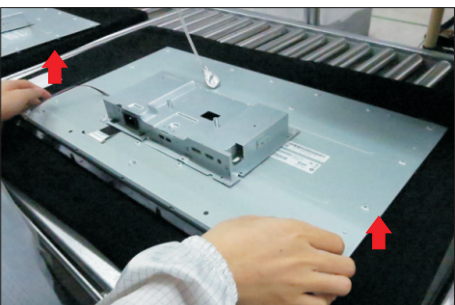
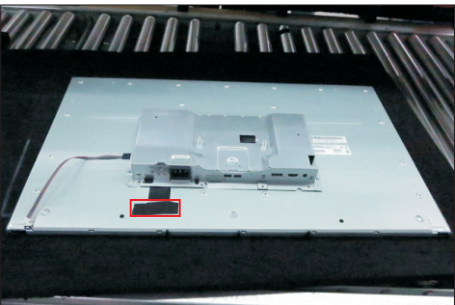

S9

Unplug the LVDS cable from the connector of the panel module by pushing the earing-locks.

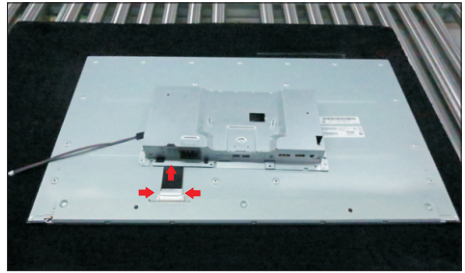

S10

Take away the bracket chassis module and then put the bracket chassis module on a protective cushion.

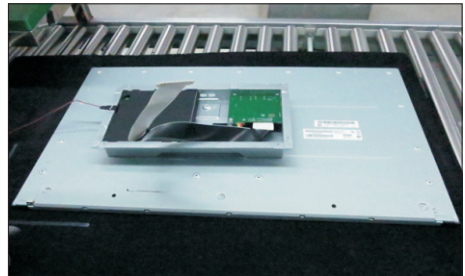

S11

Remove the Mylar from the hooks of the bracket chassis module.

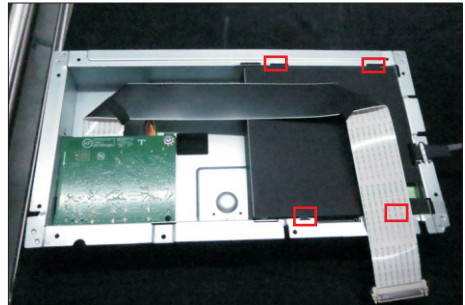

S12

Use a Philips-head screwdriver to remove 5pcs screws for unlocking the circuit board, release all the cables from the hooks.

(No.1 screw size=M4x8, Torque=6±0.5kgfxcm;  
No. 2~5 screw size=M3x7.5, Torque=6±0.5kgfxcm)

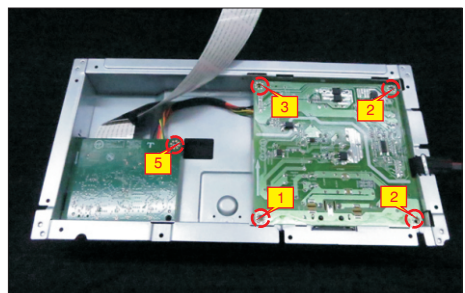

## 4. Disassembly and Assembly Procedures

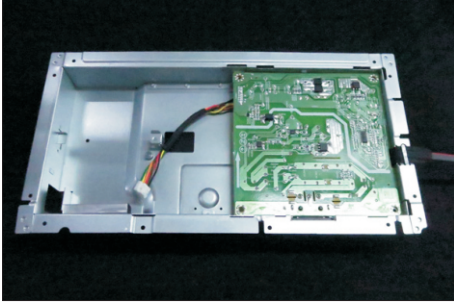

S13

Remove the interface board and power board from the bracket chassis module carefully, and disconnect all the cables.

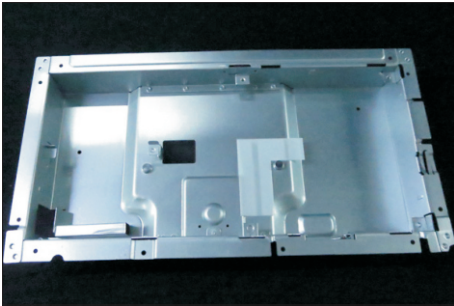

## 4. Disassembly and Assembly Procedures

### 4.2 Assembly Procedures:

S1

Place a bracket chassis base on a protective cushion.

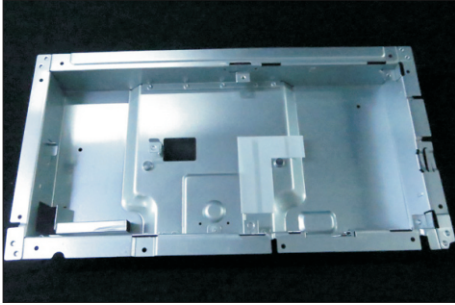

S2

Turn over a power board and put the power board into the bracket chassis, locate the panel power cable into the hook of the bracket chassis.

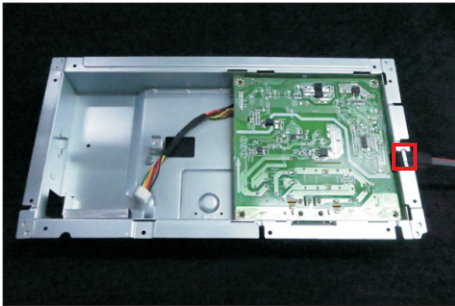

S3

Take a interface board, connect a LVDS cable to the connector of the interface board, then connect the cable of the power board to the connector of the interface board. Turn over the interface board and locate it into the bracket. Use a Philips-head screwdriver to tighten 5pcs screws for locking the power board and interface board.

(No.1 screw size=M4x8, Torque=6±0.5kgfxcm;  
No.2~5 screw size=M3x7.5, Torque=6±0.5kgfxcm)

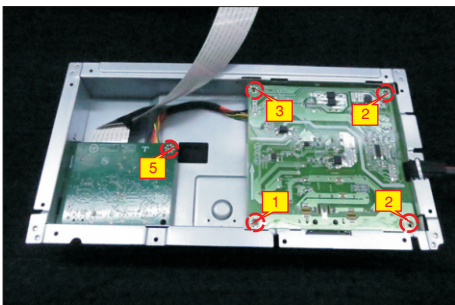

S5

Take a mylar to insert the hooks of the bracket to cover the power board.

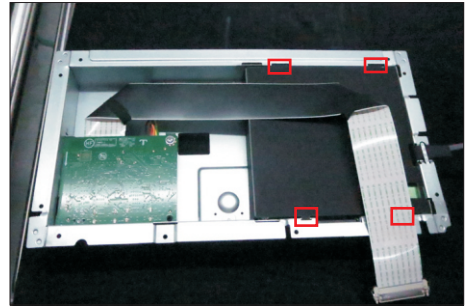

Panel preparation: Take out 1pcs panel module from the carton, then remove the protective film by tearing off the tapes, and then examine the panel surface according to inspection criteria. Turn over the panel, and then place screen faced down for later assembling.

S6



S7

Move the bracket chassis close to the panel module, then connect LVDS cable to the connector of the panel. Turn over the bracket and put it on the back of panel.

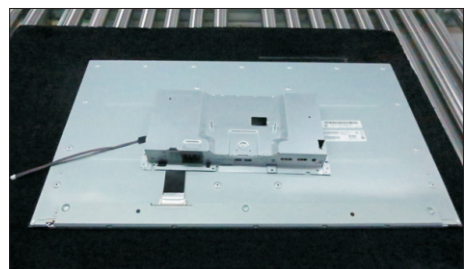
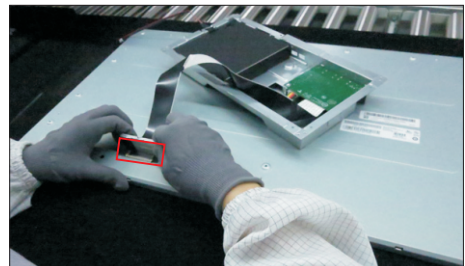

## 4. Disassembly and Assembly Procedures

S8

Take 1pcs front bezel, then lift up the panel with bracket and assemble the front bezel with the panel module. Paste 1pcs tape to cover the LVDS connector.

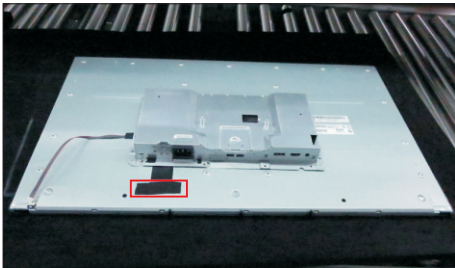
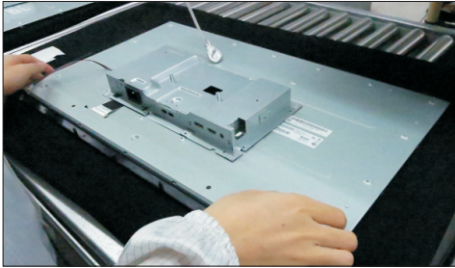

S9

Take a function key board and a middle bezel, then fix the middle bezel with a fixture, and locate the function keyboard into the hooks of the bezel. Use a Philips-head screwdriver to tighten 3pcs screws for locking the function key board with the middle bezel. (No.1~3 screw size=M2x2.4, Torque=0.8±0.2kgfxcM)

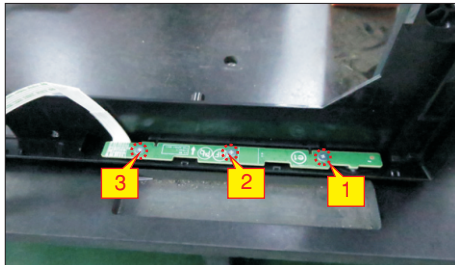

S10

Tear off the papers of the tapes on the back of the key cable, and then fix the function key cable on the back of bezel by 1pcs tape, then assemble the middle bezel with the front bezel and panel module.

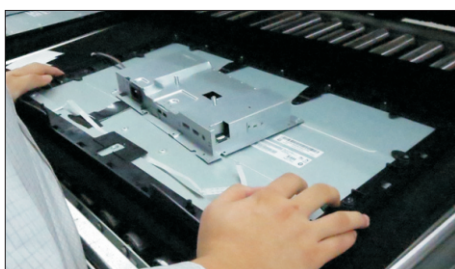
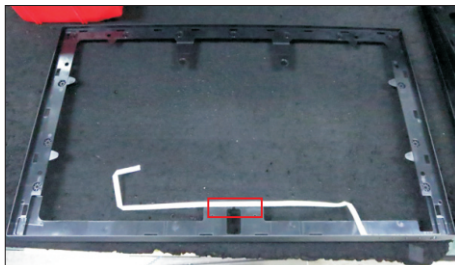

S11

Use a Philips-head screwdriver to tighten 2pcs screws for locking the bracket with panel module. (No.1~2 screw size=M3x3, Torque=3~4kgfxcM)

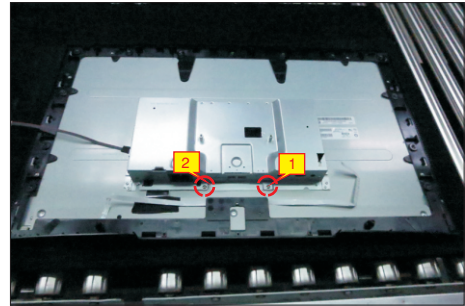

S12

Use a Philips-head screwdriver to lock 13pcs screws for locking the middle bezel with the panel module, then lock 5pcs screws for locking the middle bezel with front bezel.

(No.1~13 screw size=M3x4, Torque=3~4kgfxcM;  
No.14~18 screw size=M2x3.3, Torque=1±0.2kgfxcM)

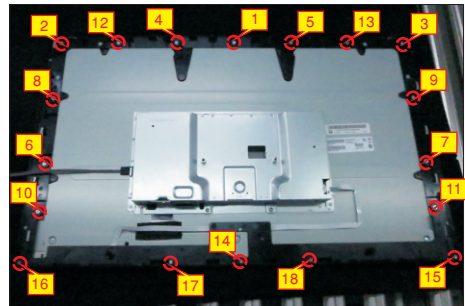

S13

Connect the function key cable to the connector of board, then paste 2pcs aluminum foils on the specific positions as the picture below shown.

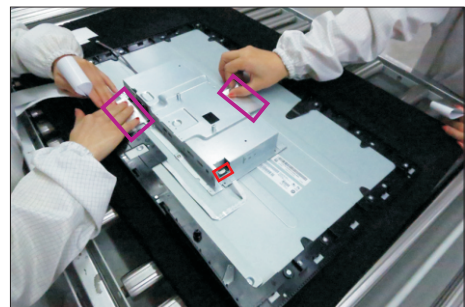

S14

Connect the panel lamp cable to the connector of panel, then paste 1pcs acetate tape to cover the panel lamp connector.

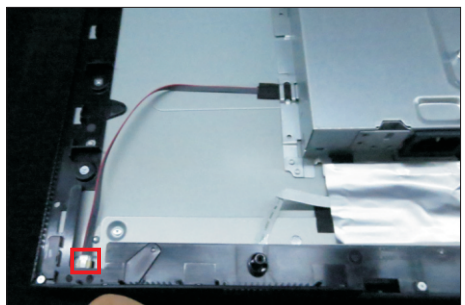



## 4. Disassembly and Assembly Procedures

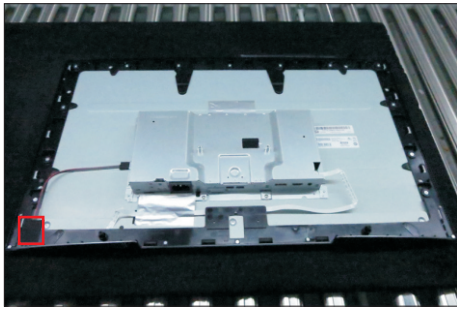

S15

Take 1pcs rear cover, put down the rear cover and push the rear cover on the positions marked as the picture below shown for mechanisms engagement.

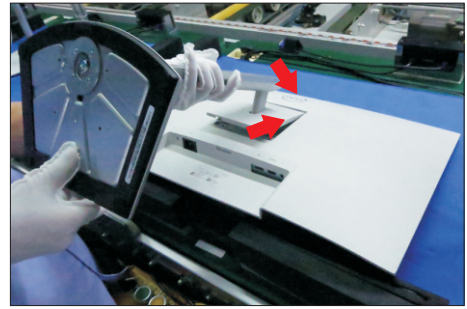

S18

Lift up the monitor to checking the gap between the front bezel with panel module , then provide power supply and a video signal to the monitor, then turn on the monitor for functionality check.

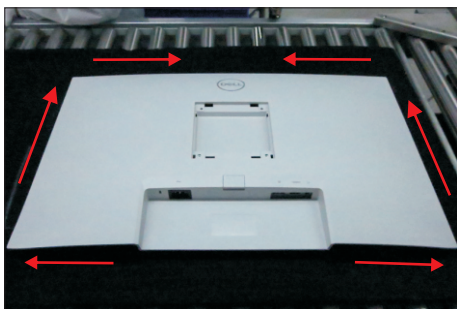

S16

Use a Philips-head screwdriver to tighten 4pcs screws for locking rear cover with the assembled unit.

(No.1~4 screw size=M4x11; Torque=7~8kgfxcm)

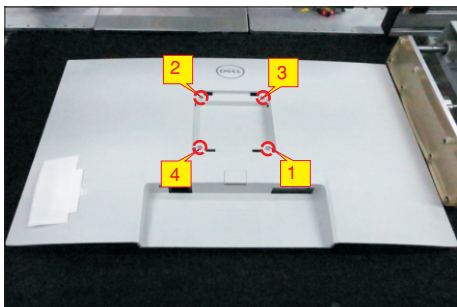

S17

Stick 2pcs labels on the specific positions as the picture below shown. Take 1pcs stand riser and 1pcs stand base, assemble the stand base with stand riser, then rotate the screw clockwise to lock the stand base and stand riser. Insert the stand-riser into monitor groove until it snaps into its place.

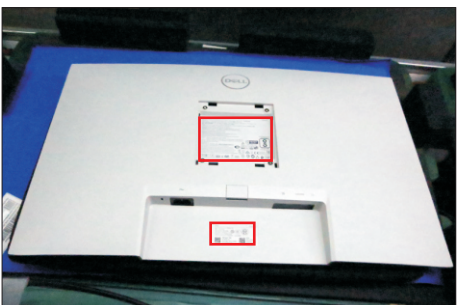

## 5. Trouble Shooting Instructions

### Self-test

Your monitor provides a self-test feature that allows you to check whether your monitor is functioning properly. If your monitor and computer are properly connected but the monitor screen remains dark, run the monitor self-test by performing the following steps:

1. Turn off both your computer and the monitor.
2. Unplug the video cable from the back of the computer. To ensure proper Self-Test operation, remove all video cables from the back of computer.
3. Turn on the monitor.

The floating dialog box should appear on-screen (against a black background), if the monitor cannot sense a video signal and is working correctly. While in self-test mode, the power LED remains white. Also, depending upon the selected input, one of the dialogs shown below will continuously scroll through the screen.

#### S2421HS/S2421HSX

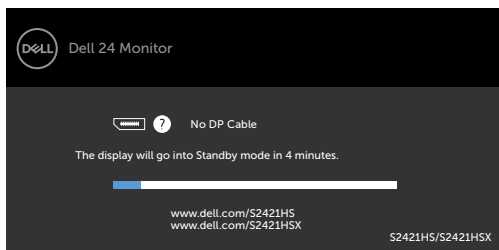

#### S2721HS/S2721HSX

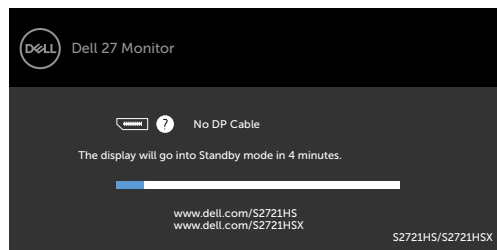

or

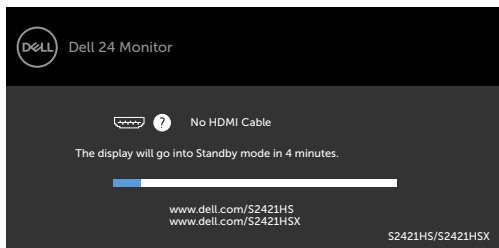

or

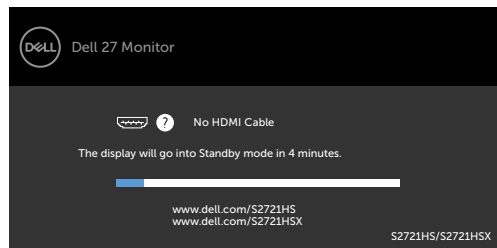

4. This box also appears during normal system operation if the video cable is disconnected or damaged.
5. Turn off your monitor and reconnect the video cable; then turn on both your computer and the monitor.

If your monitor screen remains blank after you use the previous procedure, check your video controller and computer, because your monitor is functioning properly.

## 5. Trouble Shooting Instructions

### Common problems

The following table contains general information about common monitor problems you might encounter and the possible solutions.

Common Symptoms	What You Experience	Possible Solutions
No video/ Power LED off	No picture	<ul style="list-style-type: none"><li>· Ensure that the video cable connecting the monitor and the computer is properly connected and secure.</li><li>· Verify that the power outlet is functioning properly using any other electrical equipment.</li><li>· Ensure that the power button is depressed fully.</li><li>· Ensure that the correct input source is selected in the <a href="#">Input Source</a> menu.</li></ul>
No video/ Power LED on	No picture or no brightness	<ul style="list-style-type: none"><li>· Increase brightness and contrast controls through OSD.</li><li>· Perform monitor self-test feature check.</li><li>· Check for bent or broken pins in the video cable connector.</li><li>· Run the built-in diagnostics.</li><li>· Ensure that the correct input source is selected in the <a href="#">Input Source</a> menu.</li></ul>
Missing pixels	LCD screen has spots	<ul style="list-style-type: none"><li>· Cycle power on-off.</li><li>· Pixel that is permanently off is a natural defect that can occur in LCD technology.</li><li>· For more information about Dell Monitor Quality and Pixel Policy, see Dell Support site at: <a href="https://www.dell.com/support/monitors">https://www.dell.com/support/monitors</a>.</li></ul>
Stuck-on pixels	LCD screen has bright spots	<ul style="list-style-type: none"><li>· Cycle power on-off.</li><li>· Pixel that is permanently off is a natural defect that can occur in LCD technology.</li><li>· For more information about Dell Monitor Quality and PixelPolicy, see Dell Support site at: <a href="https://www.dell.com/support/monitors">https://www.dell.com/support/monitors</a>.</li></ul>
Brightness problems	Picture too dim or too bright	<ul style="list-style-type: none"><li>· Reset the monitor to factory settings.</li><li>· Adjust brightness and contrast controls through OSD.</li></ul>
Safety-related issues	Visible signs of smoke or sparks	<ul style="list-style-type: none"><li>· Do not perform any troubleshooting steps.</li><li>· Contact Dell immediately.</li></ul>

## 5. Trouble Shooting Instructions

<b>Common Symptoms</b>	<b>What You Experience</b>	<b>Possible Solutions</b>
Intermittent problems	Monitor malfunctions on and off	<ul style="list-style-type: none"><li>• Ensure that the video cable connecting the monitor to the computer is connected properly and is secure.</li><li>• Reset the monitor to factory settings.</li><li>• Perform monitor self-test feature check to determine if the intermittent problem occurs in self-test mode.</li></ul>
Missing color	Picture missing color	<ul style="list-style-type: none"><li>• Perform monitor self-test.</li><li>• Ensure that the video cable connecting the monitor to the computer is connected properly and is secure.</li><li>• Check for bent or broken pins in the video cable connector.</li></ul>
Wrong color	Picture color not good	<ul style="list-style-type: none"><li>• Change the settings of the <b>Preset Modes</b> in the <b>Color</b> menu OSD depending on the application.</li><li>• Adjust R/G/B value under <b>Custom Color</b> in <b>Color</b> menu OSD.</li><li>• Change the <b>Input Color Format</b> to PC RGB or YPbPr in the <b>Color</b> menu OSD.</li><li>• Run the built-in diagnostics.</li></ul>
Image retention from a static image left on the monitor for a long period of time	Faint shadow from the static image displayed appears on the screen	<ul style="list-style-type: none"><li>• Set the screen to turn off after a few minutes of screen idle time. These can be adjusted in Windows Power Options or Mac Energy Saver setting.</li><li>• Alternatively, use a dynamically changing screensaver.</li></ul>

## 5. Trouble Shooting Instructions

### Product specific problems

<b>Problem</b>	<b>What You Experience</b>	<b>Possible Solutions</b>
Screen image is too small	Image is centered on screen, but does not fill entire viewing area	<ul style="list-style-type: none"><li>· Check the <b>Aspect Ratio</b> setting in the <b>Display</b> menu OSD.</li><li>· Reset the monitor to factory settings.</li></ul>
Cannot adjust the monitor with the buttons on the front panel	OSD does not appear on the screen	<ul style="list-style-type: none"><li>· Turn off the monitor, unplug the monitor power cable, plug it back, and then turn on the monitor.</li></ul>
No Input Signal when user controls are pressed	No picture, the LED light is white	<ul style="list-style-type: none"><li>· Check the signal source. Ensure that the computer is not in the power saving mode by moving the mouse or pressing any key on the keyboard.</li><li>· Check whether the signal cable is plugged in properly. Re-plug the signal cable if necessary.</li><li>· Reset the computer or video player.</li></ul>
The picture does not fill the entire screen	The picture cannot fill the height or width of the screen	<ul style="list-style-type: none"><li>· Due to different video formats (aspect ratio) of DVDs, the monitor may display in full screen.</li><li>· Run the built-in diagnostics.</li></ul>