

Simplified Service Manual–S2721DB/ S2721DSB

Version: 01

Date:2021/03/08

Content Index

1. General Safety Instructions	3
1.1 SAFETY: General Safety	3
1.2 SAFETY: General Power Safety	5
2. Exploded view diagram with list of items	6
3. Wiring connectivity diagram	8
4. Disassembly and Assembly Procedures	9
4.1 Disassembly SOP	9
4.2 Assembly SOP	13
5. Trouble shooting instructions	17

1. General Safety Instructions

Use the following safety guidelines to help ensure your own personal safety and to help protect your equipment and working environment from potential damage.

NOTE: In this section, equipment refers to monitors.

IMPORTANT NOTICE FOR USE IN HEALTHCARE ENVIRONMENTS:

Dell products are not medical devices and are not listed under UL or IEC 60601 (or equivalent). As a result, they must not be used within 6 feet of a patient or in a manner that directly or indirectly contacts a patient

1.1 SAFETY: General Safety

WARNING: To prevent the spread of fire, keep candles or other open flames away from this product at all times.

When setting up the equipment for use:

- Place the equipment on a hard, level surface. Leave 10.2 cm (4 in) minimum of clearance on all vented sides of the computer to permit the airflow required for proper ventilation.
- Restricting airflow can damage the computer or cause a fire.
- Do not stack equipment or place equipment so close together that it is subject to recirculated or preheated air.
- NOTE: Review the weight limits referenced in your computer documentation before placing a monitor or other devices on top of your computer.
- Ensure that nothing rests on your equipment's cables and that the cables are not located where they can be stepped on or tripped over.
- Ensure that all cables are connected to the appropriate connectors. Some connectors have a similar appearance and may be easily confused (for example, do not plug a telephone cable into the network connector).
- Do not place your equipment in a closed-in wall unit or on a bed, sofa, or rug.
- Keep your device away from radiators and heat sources.
- Keep your equipment away from extremely hot or cold temperatures to ensure that it is used within the specified operating range.
- Do not push any objects into the air vents or openings of your equipment. Doing so can cause fire or electric shock by shorting out interior components.
- Avoid placing loose papers underneath your device. Do not place your device in a closed-in wall unit, or on a soft, fabric surface such as a bed, sofa, carpet, or a rug.

When operating your equipment:

- Do not use your equipment in a wet environment, for example, near a bath tub, sink, or swimming pool or in a wet basement.
- Do not use AC powered equipment during an electrical storm. Battery powered devices may be used if all cables have been disconnected.
- Do not spill food or liquids on your equipment.
- Before you clean your equipment, disconnect it from the electrical outlet. Clean your device with a soft cloth dampened with water. Do not use liquids or aerosol cleaners, which may contain flammable substances.
- Clean the monitor display with a soft, clean cloth and water. Apply the water to the cloth, then stroke the cloth across the display in one direction, moving from the top of the display to the bottom. Remove moisture from the display quickly and keep the display dry.
- Long-term exposure to moisture can damage the display. Do not use a commercial window cleaner to clean your display.
- If your equipment does not operate normally - in particular, if there are any unusual sounds or smells coming from it - unplug it immediately and contact an authorized dealer or service center.

Protecting Against Electrostatic Discharge

Electrostatic discharge (ESD) events can harm electronic components inside your equipment. Under certain conditions, ESD may build up on your body or an object, such as a peripheral, and then discharge into another object, such as your computer. To prevent ESD damage, you should discharge static electricity from your body before you interact with any of your equipment's internal electronic components, such as a memory module. You can protect against ESD by touching a metal grounded object (such as an unpainted metal surface on your computer's I/O panel) before you interact with anything electronic. When connecting a peripheral (including handheld digital assistants) to your equipment, you should always ground both yourself and the peripheral before connecting it. In addition, as you work inside the equipment, periodically discharge any static charge your body may have accumulated.

You can also take the following steps to prevent damage from electrostatic discharge:

- When unpacking a static-sensitive component from its shipping carton, do not remove the component from the antistatic packing material until you are ready to install the component. Just before unwrapping the antistatic package, be sure to discharge static electricity from your body.
- When transporting a sensitive component, first place it in an antistatic container or packaging.
- Handle all electrostatic sensitive components in a static-safe area. If possible, use antistatic floor pads and work bench pads.

1.2 SAFETY: General Power Safety

Observe the following guidelines when connecting your equipment to a power source:

- Check the voltage rating before you connect the equipment to an electrical outlet to ensure that the required voltage and frequency match the available power source.
- Do not plug the equipment power cables into an electrical outlet if the power cable is damaged
- Norway and Sweden: If this product is provided with a 3-prong power cable, connect the power cable to a grounded electrical outlet only.
- If you use an extension power cable, ensure that the total ampere rating of the products plugged in to the extension power cable does not exceed the ampere rating of the extension cable.
- If you must use an extension cable or power strip, ensure the extension cable or power strip is connected to a wall power outlet and not to another extension cable or power strip. The extension cable or power strip must be designed for grounded plugs and plugged into a grounded wall outlet.
- If you are using a multiple-outlet power strip, use caution when plugging the power cable into the power strip. Some power strips may allow you to insert a plug incorrectly. Incorrect insertion of the power plug could result in permanent damage to your equipment, as well as risk of electric shock and/or fire. Ensure that the ground prong of the power plug is inserted into the mating ground contact of the power strip.
- Be sure to grasp the plug, not the cable, when disconnecting equipment from an electric socket.

If your equipment uses an AC adapter:

- Use only the Dell provided AC adapter approved for use with this device. Use of another AC adapter may cause a fire or explosion.
- NOTE: Refer to your system rating label for information on the proper adapter model approved for use with your device.
- Place the AC adapter in a ventilated area, such as a desk top or on the floor, when you use it to run the computer or to charge the battery. Do not cover the AC adapter with papers or other items that will reduce cooling; also, do not use the AC adapter inside a carrying case.
- The AC adapter may become hot during normal operation of your computer. Use care when handling the adapter during or immediately after operation.
- It is recommended that you lay the adapter on the floor or desk so that the green light is visible. This will alert you if the adapter should accidentally go off due to external effects. If for any reason the green light goes off, disconnect the AC power cord from the wall for a period of ten seconds, and then reconnect the power cord.
- Japan Only: Use only the Dell-provided AC power cable with the AC adapter. Use of any other power cable may damage the device or AC adapter or may present risk of fire or electric shock.

2. Exploded view diagram with list of items

S2721D:

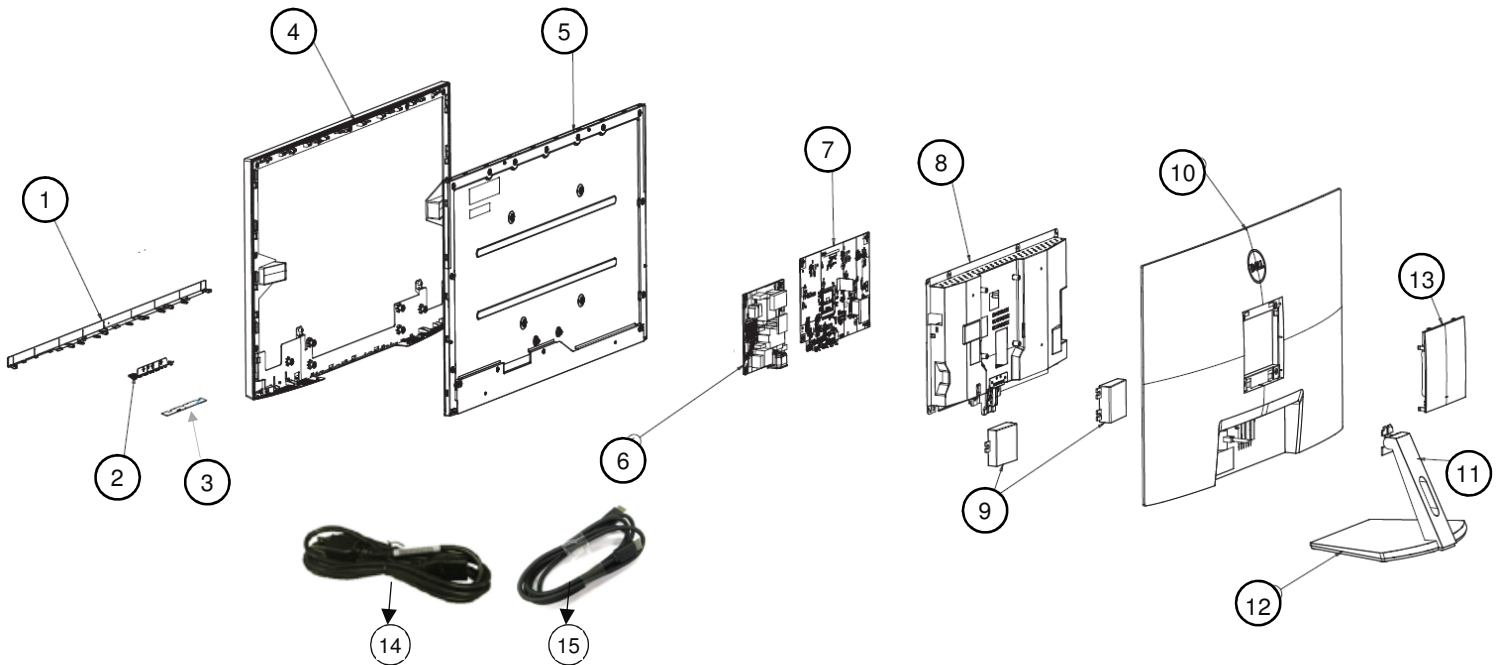

Item	Description	Q'ty
1	ASSY DECO	1
2	BTN OSD	1
3	PCBA CTRL BD	1
4	MF	1
5	Panel	1
6	PCBA SPS BD	1
7	PCBA I/F BD	1
8	ASSY SHD	1
9	SPK*2	1
10	ASSY RC	1
11	ASSY STAND COLUMN	1
12	ASSY STAND BASE	1
13	ASSY COVER VESA	1
14	Power cable	1
15	HDMI cable	1

S2721DS:

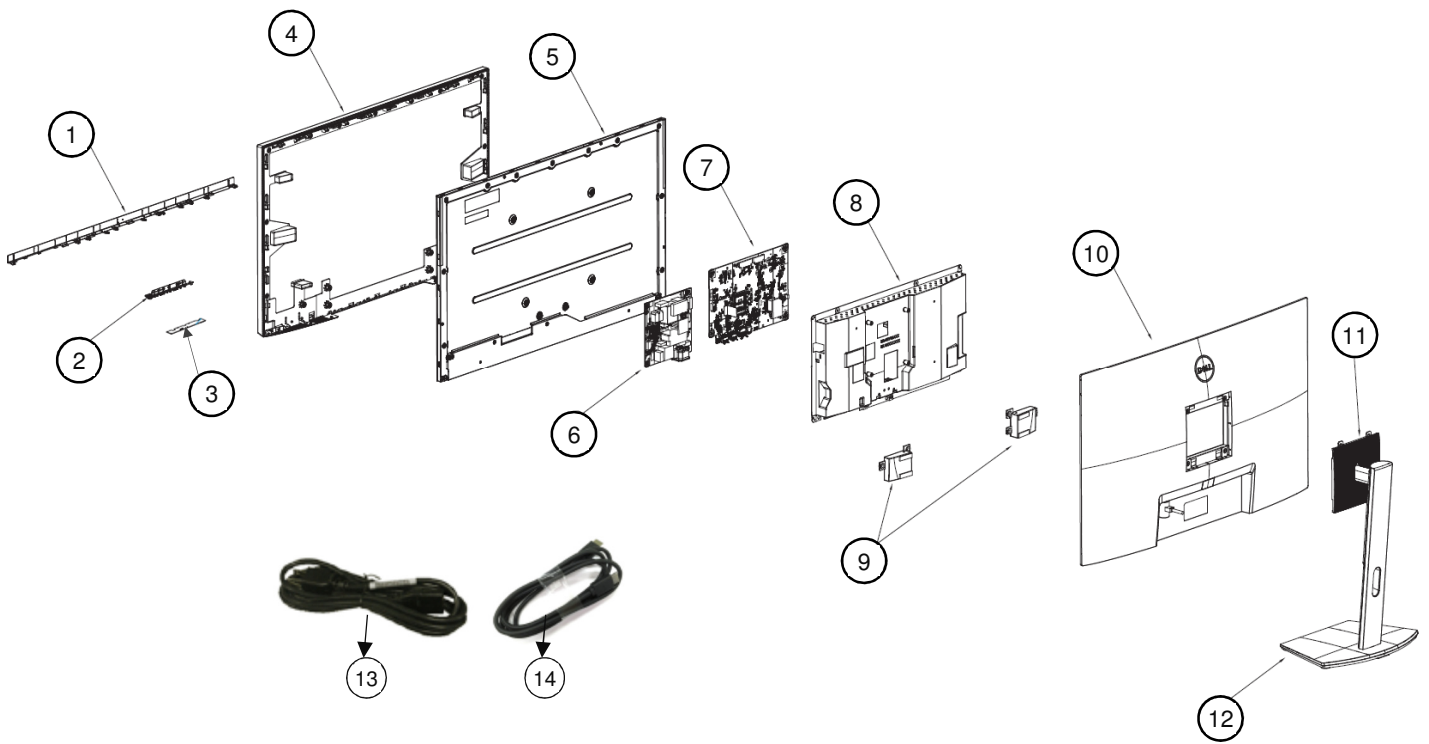

Item	Description	Q'ty
1	ASSY DECO	1
2	BTN OSD	1
3	PCBA CTRL BD	1
4	MF	1
5	Panel	1
6	PCBA SPS BD	1
7	PCBA I/F BD	1
8	ASSY SHD	1
9	SPK*2	1
10	ASSY RC	1
11	ASSY STAND COLUMN	1
12	ASSY STAND BASE	1
13	Power cable	1
14	HDMI cable	1

3. Wiring connectivity diagram

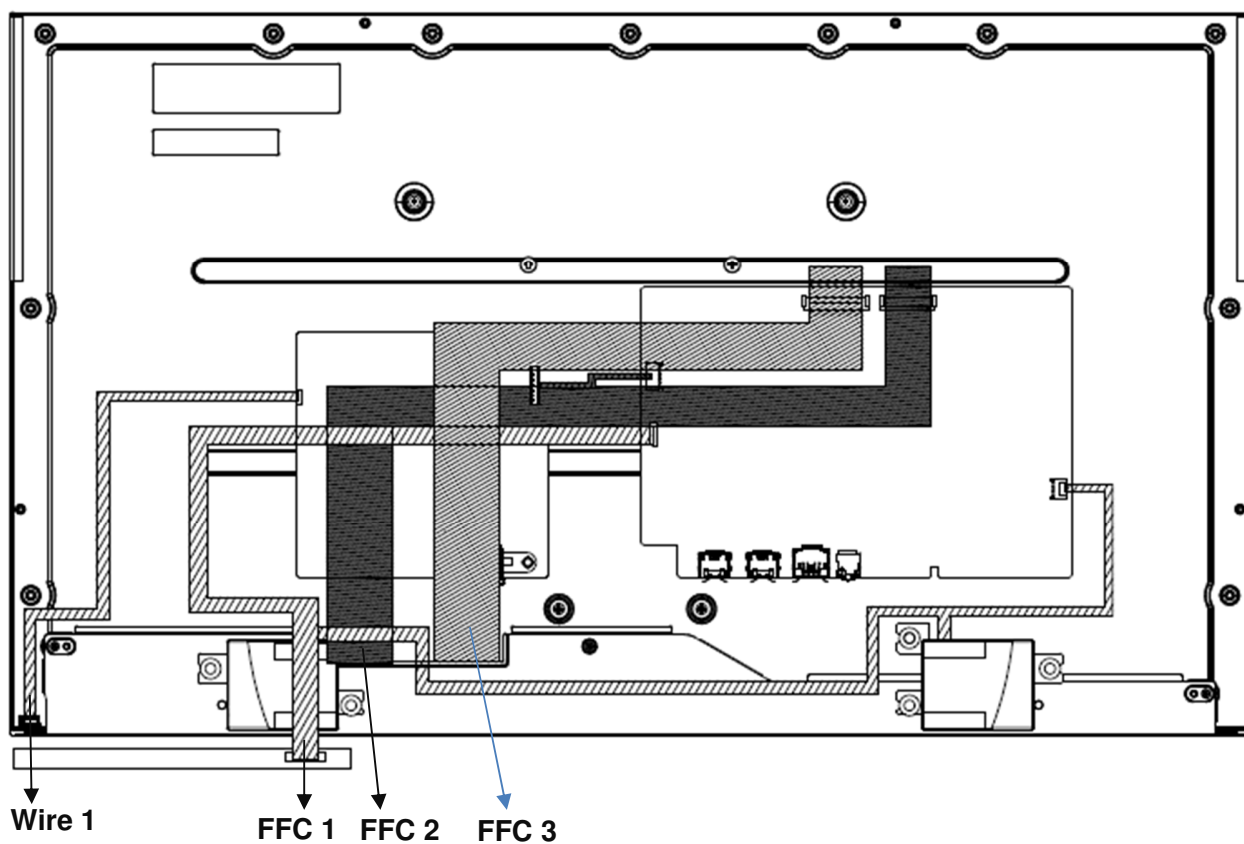



4. Disassembly and Assembly Procedures

4.1 Disassembly SOP

Preparation before disassemble

1. Clean the room for disassemble
2. Identify the area for monitor
3. Check the position that the monitors be placed and the quantity of the monitor; prepare the area for material flow; according to the actual condition plan the disassemble layout
4. Prepare the implement, equipment, material as bellow:
 - 1) Working table
 - 2) Philips-head screwdriver
 - 3) Glove
 - 4) Cleaning cloth
 - 5) ESD protection

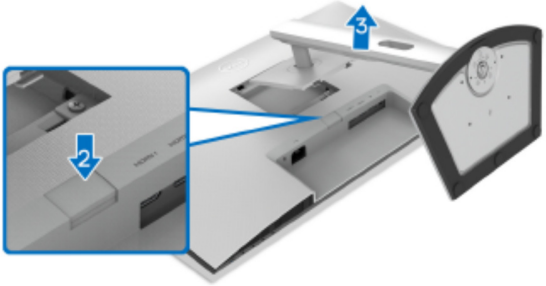
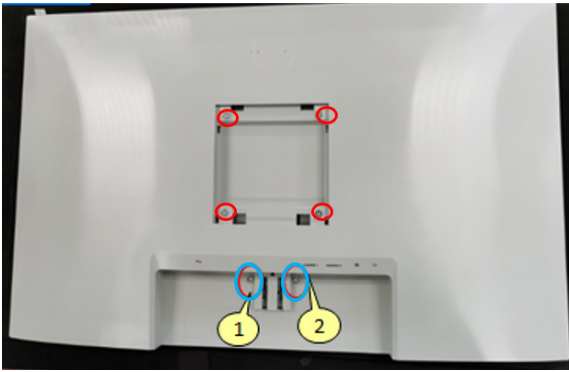
Item	Picture	Operation	Tool	Notes
1		<p>Removing the monitor stand</p> <p>S2720D:</p> <ol style="list-style-type: none"> 1. Place the monitor on a soft cloth or cushion. 2. Press the dimple on the VESA cover to release it from the back of the display. 3. Using a long screwdriver, push the release latch located in the gap just above the stand. 4. Once the latch is released, slide the stand assembly away from the monitor 	Philips-head screwdriver	

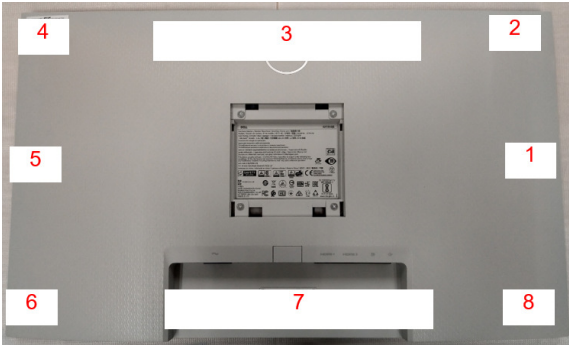
		<p>S2720DS:</p> <ol style="list-style-type: none"> 1. Place the monitor on a soft cloth or cushion. 2. Press and hold the stand release button at the back of the display. <p>Lift the stand assembly up and away from the monitor.</p>		
2		<p>S2721D:</p> <ol style="list-style-type: none"> 1. Unlock 2 Stand screws 2. Unlock 4 screws on Rear Cover 	<p>Philips-head screwdriver</p> <p>Torsion of RC screw: 8.5±1.0kgf</p> <p>Stand screw: 4~5kgf</p>	
		<p>S2721DS:</p> <ol style="list-style-type: none"> 1. Unlock 4 screws on Rear Cover 	<p>Philips-head screwdriver</p> <p>Torsion of RC screw: 8.5±1.0kgf</p>	
3		<ol style="list-style-type: none"> 1. Follow the sequence to disassemble Rear Cover from the monitor 		

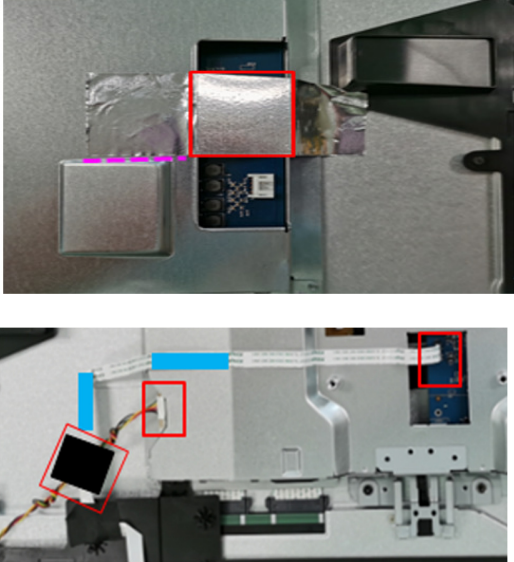
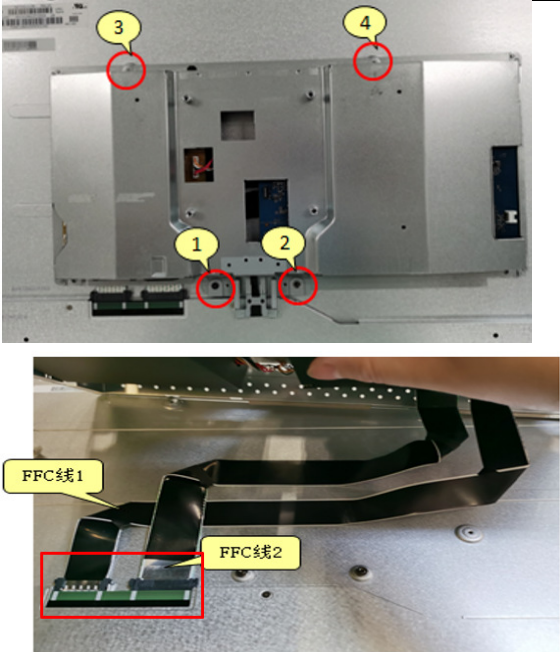
4		<ol style="list-style-type: none"> 1. Pull out SPK wire from I/F BD 		
5		<ol style="list-style-type: none"> 1. Tear off AL Tape 2. Pull out CTRL FFC from I/F BD 3. Pull out backlight wire from SPS BD 		
6		<ol style="list-style-type: none"> 1. Unlock 4 Main SHD screws 2. Pull out FFC LVDS from the Panel 3. Take off Main SHD from Panel 	<p>Philips-head screwdriver</p> <p>Torsion of Main SHD screw: 6~7kgf</p>	

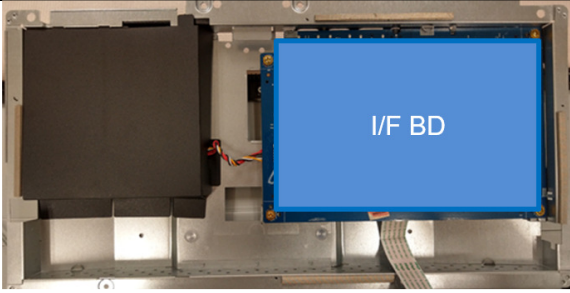
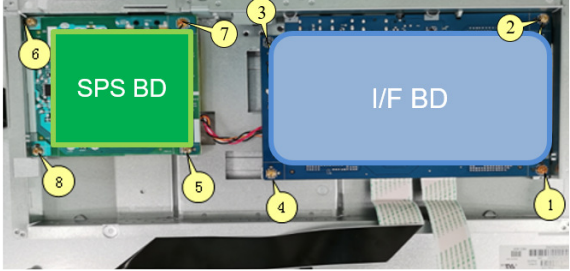
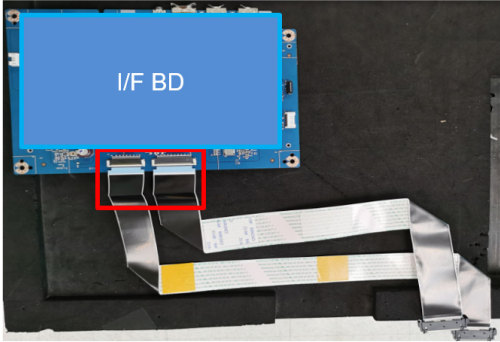
7		<ol style="list-style-type: none"> 1. Disassemble Safety Mylar from SPS BD 		
8	 	<ol style="list-style-type: none"> 1. Unlock 8 PCBA screws 2. Disassemble I/F BD & SPS BD from Main SHD 3. Pull out FFC LVDS from I/F BD 	<p>Philips-head screwdriver</p> <p>Torsion of PCB screw: 6~7kgf</p>	



4.2 Assembly SOP

Preparation before assemble

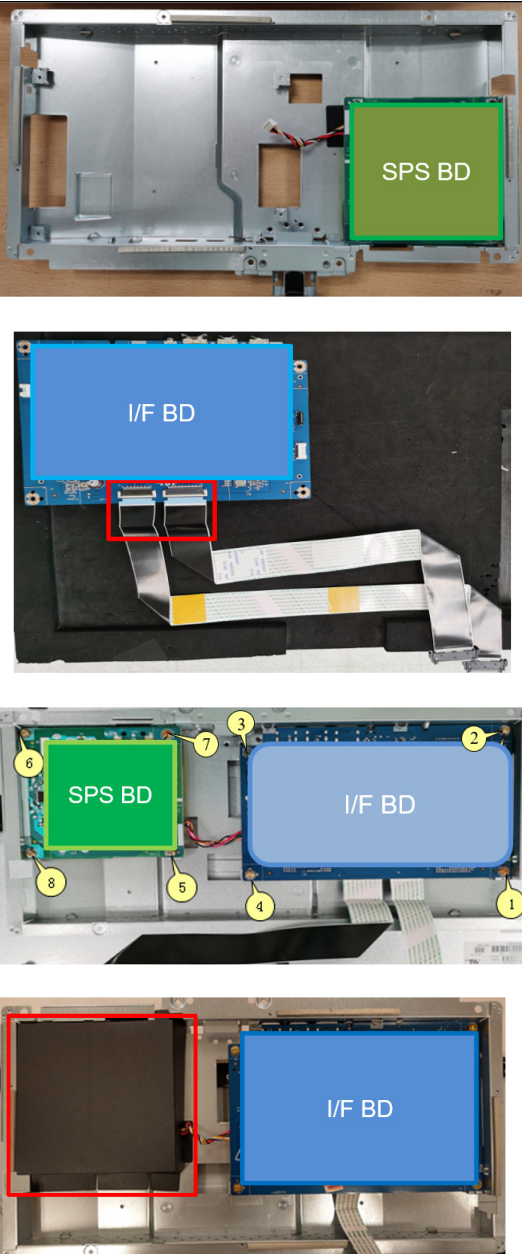
1. Clean the room for work
2. Identify the area for material
3. Prepare the implement, equipment, material as bellow:
 - 1) Working table
 - 2) Philips-head screwdriver
 - 3) Glove
 - 4) Cleaning cloth
 - 5) ESD protection

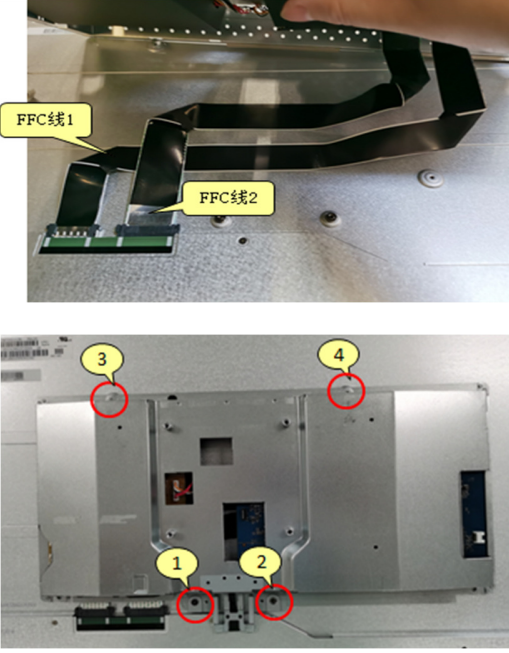
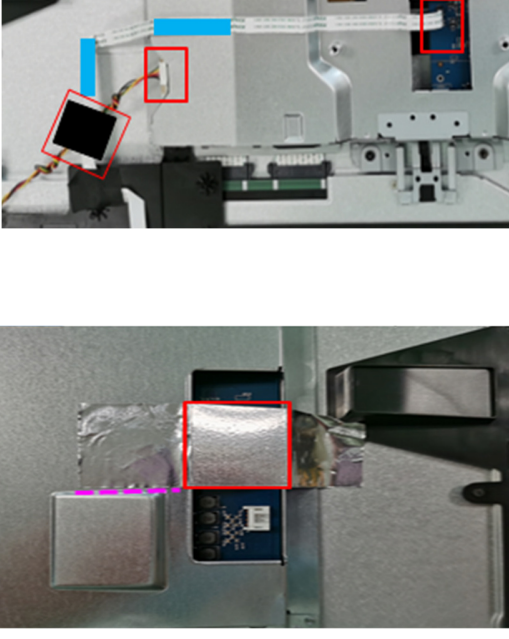
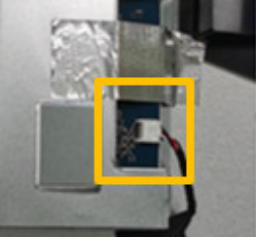
Item	Picture	Operation	Tools	Notes
1		<ol style="list-style-type: none"> 1. Place Main SHD on the worktable. 2. Assemble SPS BD into Main SHD 3. Insert FFC LVDS into I/F BD 4. Insert SPS BD to I/F BD wire into I/F BD. 5. Assemble I/F BD into Main SHD 6. Lock 8 PCBA screws 7. Assemble Safety Mylar on SPS BD 	<p>Philips-head screwdriver</p> <p>Torsion of PCB screw: 6~7kgf</p>	

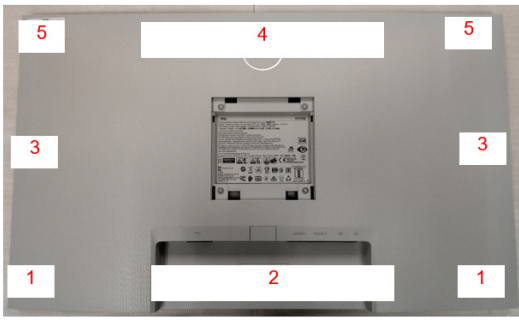
<p>2</p>		<ol style="list-style-type: none"> 1. Insert FFC LVDS into Panel 2. Place Main SHD on panel and lock 4 Main SHD screws 	<p>Philips-head screwdriver</p> <p>Torsion of Main SHD screw: 6~7kgf</p>	
<p>3</p>		<ol style="list-style-type: none"> 1. Insert CTRL FFC into I/F BD and arrange CTRL FFC 2. Insert backlight wire into SPS BD 3. Stick 1 adhesive tape to fix backlight wire and CTRL FFC on Panel 4. Stick the AL Tape on Main SHD and Panel 		
<p>4</p>		<ol style="list-style-type: none"> 1. Insert SPK wire into I/F BD 		

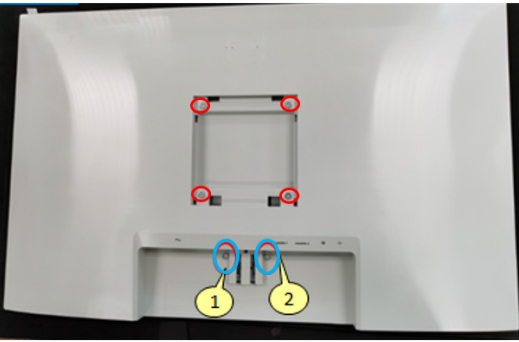
5		<ol style="list-style-type: none"> 1. Assemble Rear Cover with Mid-Frame 2. Follow the sequence to press on Rear Cover to make it be assembled with Mid-Frame tightly 		
6		<p>S2721DS:</p> <ol style="list-style-type: none"> 1. Lock 4 screws on Rear Cover 	<p>Philips-head screwdriver</p> <p>Torsion of RC screw: 8.5±1.0kgf</p>	
6		<p>S2721D:</p> <ol style="list-style-type: none"> 1. Lock 4 screws on Rear Cover 2. Lock 2 Stand screws 	<p>Philips-head screwdriver</p> <p>Torsion of RC screw: 8.5±1.0kgf</p> <p>Stand screw: 4~5kgf</p>	

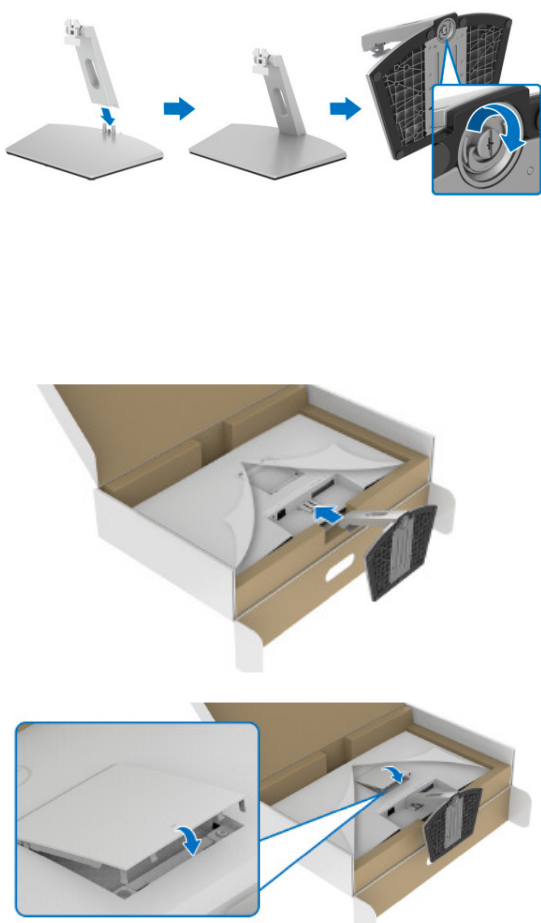
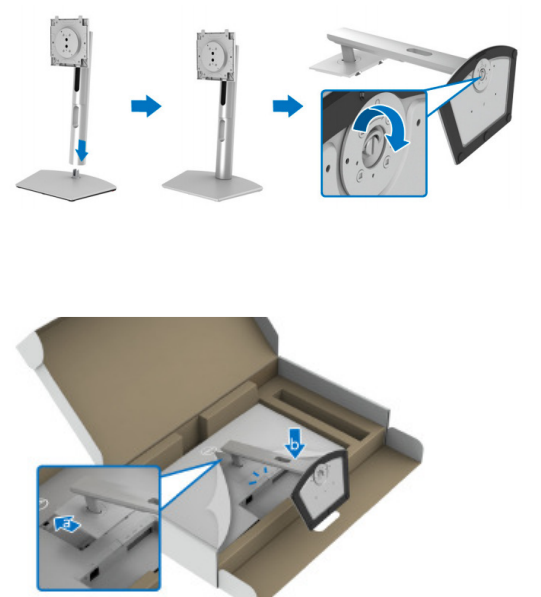
<p>7</p>	<p>S2721D:</p> 	<p>S2721D: To assemble Stand and VESA screw cover with Monitor</p> <ol style="list-style-type: none"> 1. Align and place the stand riser on the stand base 2. Open the screw handle at the bottom of the stand base and turn it clockwise to secure the stand assembly 3. Close the screw handle. 4. Align and insert the stand assembly bracket into the groove on the back of the display until it locks in place. 5. Install the VESA screw cover. 		
	<p>S2721DS:</p> 	<p>S2721DS: To assemble Stand with Monitor</p> <ol style="list-style-type: none"> 1. Align and place the stand riser on the stand base 2. Open the screw handle at the bottom of the stand base and turn it clockwise to secure the stand assembly 3. Close the screw handle. 4. Align and slide the tabs on the stand riser into the VESA slot. 5. Press the stand down until it snaps into place. 		

5. Trouble shooting instructions

Troubleshooting

⚠ WARNING: Before you begin any of the procedures in this section, follow the [Safety instructions](#).

Self-test

Your monitor provides a self-test feature that allows you to check whether your monitor is functioning properly. If your monitor and computer are properly connected but the monitor screen remains dark, run the monitor self-test by performing the following steps:

1. Turn Off both your computer and the monitor.
2. Unplug the video cable from the computer.
3. Turn On the monitor.

The floating dialog box should appear on-screen (against a black background), if the monitor cannot sense a video signal and is working correctly. While in self-test mode, the power LED remains white. Also, depending upon the selected input, one of the dialogs shown below will continuously scroll through the screen.

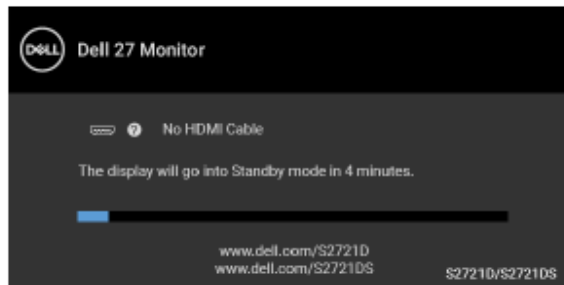

OR



4. This box also appears during normal system operation, if the video cable becomes disconnected or damaged.

5. Turn Off your monitor and reconnect the video cable; then turn On both your computer and the monitor.

If your monitor screen remains blank after you use the previous procedure, check your video controller and computer, because your monitor is functioning properly.

Built-in diagnostics

Your monitor has a built-in diagnostic tool that helps you determine if the screen abnormality you are experiencing is an inherent problem with your monitor, or with your computer and video card.

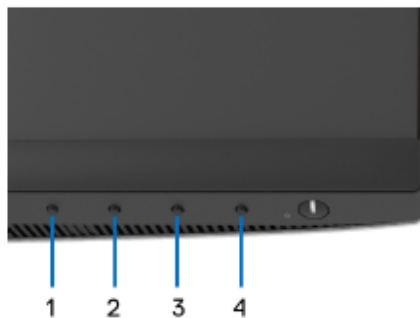

To run the built-in diagnostics:

1. Ensure that the screen is clean (no dust particles on the surface of the screen).
2. Press and hold **Button 4** for about 4 seconds until a pop menu appears.
3. Use **Button 1** or **Button 2** to select the diagnostic tool  and use **Button 3** to confirm. A gray test pattern appears at the beginning of the diagnostic program.
4. Carefully inspect the screen for abnormalities.
5. Press **Button 1** again to change the test patterns.
6. Repeat steps 4 and 5 to inspect the display in red, green, blue, black, white, and text screens.
7. Press **Button 1** to end the diagnostic program.

Common problems

The following table contains general information about common monitor problems you might encounter and the possible solutions:

Common symptoms	What you experience	Possible solutions
No Video/Power LED off	No picture	<ul style="list-style-type: none">• Ensure that the video cable connecting the monitor and the computer is properly connected and secure.• Verify that the power outlet is functioning properly using any other electrical equipment.• Ensure that the power button is pressed fully.• Ensure that the correct input source is selected in the Input Source menu.
No Video/Power LED on	No picture or no brightness	<ul style="list-style-type: none">• Increase brightness & contrast controls via OSD.• Perform monitor self-test feature check.• Check for bent or broken pins in the video cable connector.• Run the built-in diagnostics.• Ensure that the correct input source is selected in the Input Source menu.
Poor Focus	Picture is fuzzy, blurry, or ghosting	<ul style="list-style-type: none">• Eliminate video extension cables.• Reset the monitor to factory settings.• Change the video resolution to the correct aspect ratio.
Shaky/Jittery Video	Wavy picture or fine movement	<ul style="list-style-type: none">• Reset the monitor to factory settings.• Check environmental factors.• Relocate the monitor and test in another room.

Missing Pixels	LCD screen has spots	<ul style="list-style-type: none"> • Cycle power On-Off. • Pixel that is permanently Off is a natural defect that can occur in LCD technology. • For more information on Dell Monitor Quality and Pixel Policy, see Dell support site at: www.dell.com/pixelguidelines.
Stuck-on Pixels	LCD screen has bright spots	<ul style="list-style-type: none"> • Cycle power On-Off. • Pixel that is permanently off is a natural defect that can occur in LCD technology. • For more information on Dell Monitor Quality and Pixel Policy, see Dell support site at: www.dell.com/pixelguidelines.
Brightness Problems	Picture too dim or too bright	<ul style="list-style-type: none"> • Reset the monitor to factory settings. • Adjust brightness & contrast controls via OSD.
Geometric Distortion	Screen not centered correctly	<ul style="list-style-type: none"> • Reset the monitor to factory settings. • Adjust horizontal & vertical controls via OSD. • When using HDMI/DisplayPort input, the positioning adjustments are not available.
Horizontal/Vertical Lines	Screen has one or more lines	<ul style="list-style-type: none"> • Reset the monitor to factory settings. • Perform monitor self-test feature check and determine if these lines are also in self-test mode. • Check for bent or broken pins in the video cable connector. • Run the built-in diagnostics.

Synchronization Problems	Screen is scrambled or appears torn	<ul style="list-style-type: none"> Reset the monitor to factory settings. Perform monitor self-test feature check to determine if the scrambled screen appears in self-test mode. Check for bent or broken pins in the video cable connector. Restart the computer in the safe mode.
Safety Related Issues	Visible signs of smoke or sparks	<ul style="list-style-type: none"> Do not perform any troubleshooting steps. Contact Dell immediately.
Intermittent Problems	Monitor malfunctions on & off	<ul style="list-style-type: none"> Ensure that the video cable connecting the monitor to the computer is connected properly and is secure. Reset the monitor to factory settings. Perform monitor self-test feature check to determine if the intermittent problem occurs in self-test mode.
Missing Color	Picture missing color	<ul style="list-style-type: none"> Perform monitor self-test feature check. Ensure that the video cable connecting the monitor to the computer is connected properly and is secure. Check for bent or broken pins in the video cable connector.
Wrong Color	Picture color not good	<ul style="list-style-type: none"> Change the settings of the Preset Modes in the Color menu OSD depending on the application. Adjust R/G/B value under Custom Color in the Color menu OSD. Run the built-in diagnostics.

Image retention from a static image left on the monitor for a long period of time	Faint shadow from the static image displayed appears on the screen	<ul style="list-style-type: none"> Use the Power Management feature to turn Off the monitor at all times when not in use (for more information, see Power management modes). Alternatively, use a dynamically changing screensaver.
---	--	---

Product specific problems

Common symptoms	What you experience	Possible solutions
Screen image is too small	Image is centered on screen, but does not fill entire viewing area	<ul style="list-style-type: none"> Check the Aspect Ratio setting in the Display menu OSD. Reset the monitor to factory settings.
Cannot adjust the monitor with the buttons on the front panel	OSD does not appear on the screen	<ul style="list-style-type: none"> Turn Off the monitor, unplug the power cord, plug it back, and then turn On the monitor. The OSD menu may be locked. Press and hold the Menu/function button next to the Power button for 4 seconds to unlock (for more information, see Lock).
No Input Signal when user controls are pressed	No picture, the LED light is white	<ul style="list-style-type: none"> Check the signal source. Ensure the computer is not in the power saving mode by moving the mouse or pressing any key on the keyboard. Check whether the signal cable is plugged in properly. Re-plug the signal cable if necessary. Reset the computer or video player.
The picture does not fill the entire screen	The picture cannot fill the height or width of the screen	<ul style="list-style-type: none"> Due to different video formats (aspect ratio) of DVDs, the monitor may display in full screen. Run the built-in diagnostics.

Speakers Specific Problems

Common symptoms	What you experience	Possible solutions
No sound coming from the speakers	Cannot hear any sound	<ul style="list-style-type: none">• Turn Off the monitor, unplug the monitor power cord, replug it, and then turn On the monitor.• Check the audio cable connection is connected correctly to the audio line-out port of the computer.• Unplug the audio cable from the audio line-out port.• Reset the monitor to factory settings.