

1. Disassembly Procedures:

S1 Open the Pizza carton with a proper tool.



Take out all of the accessories including QSG, HDMI cable, power cable, CD&user's manual, stand base, stand riser and EEI label from the carton. (Note: It depends on whether users returning the accessories)

S2

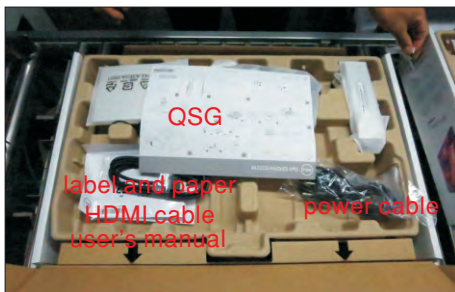

S3

Take out of the molded pulp with base, riser and cover from the carton, then take out the monitor from the EPE bag and put it on a protective cushion.

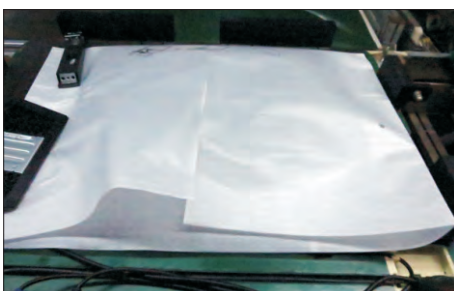

S4

Use a Philips-head screwdriver to remove 6pcs screws for unlocking mechanisms.

(No.1~4 screw size=M4x11; Torque=7~8kgfxcM;
No.5~6 screw size=M4x8; Torque=7~8kgfxcM)

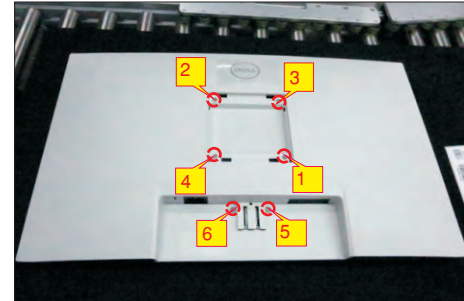

Wedge your fingers between the rear cover and the middle bezel on the corners of the top side of the monitor to release the rear cover, then use one hand to press the middle bezel, the other hand to pull up carefully the rear cover in order of arrow preference for unlocking mechanisms of rear cover.

S5

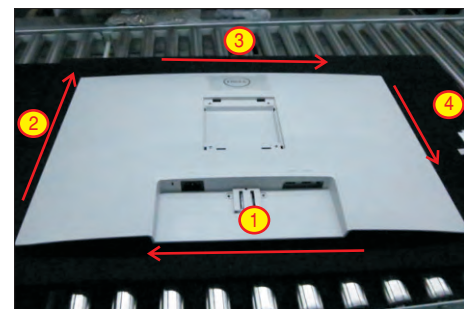

S6

Tear off 2pcs aluminum foils, and then disconnect the function key cable away from the connector of the board. Disconnect the panel lamp cable away from the connector of panel.

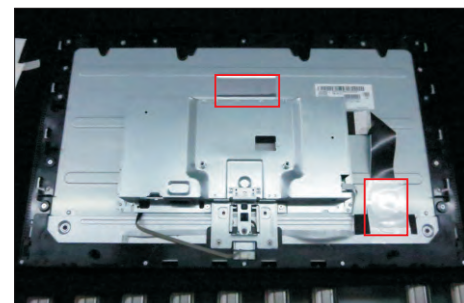

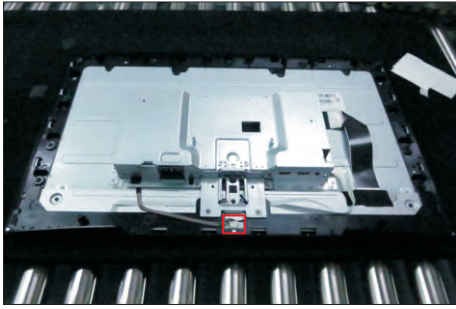

S7

Use a Philips-head screwdriver to remove 16pcs screws for unlocking the middle bezel.

(No.1~11 screw size=M3x4, Torque=3~4kgfxcn;
No.12~16 screw size=M2x3.3, Torque=1±0.2kgfxcn)

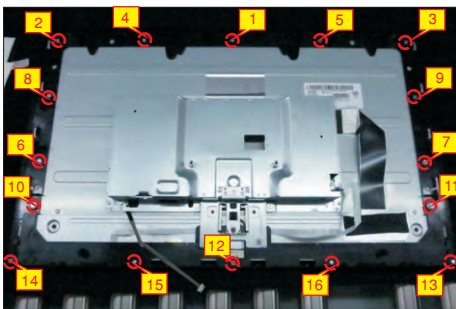

S8

Use a Philips-head screwdriver to remove 2pcs screws for unlocking the bracket with middle bezel, to remove 2pcs screws for unlocking the bracket with panel module.

(No.1~2 screw size=M3x4, Torque=3~4kgfxcn;
No.3~4 screw size=M3x3.5, Torque=2~3kgfxcn)

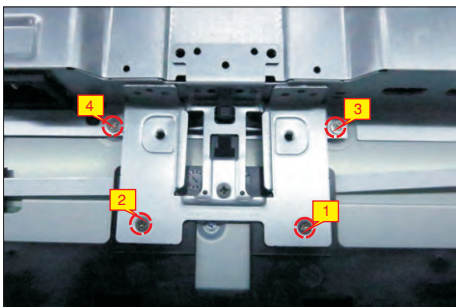

S9

Take away the middle bezel, and put it on a fixture. Use a Philips-head screwdriver to remove 3pcs screws for unlocking the function key board with the middle bezel, and then tear off the tapes for releasing the key cables.

(No.1~3 screw size=M2x2.4, Torque=0.8±0.2kgfxcn)

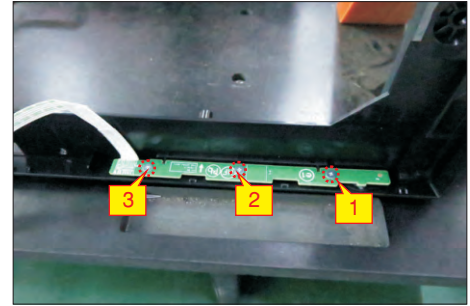
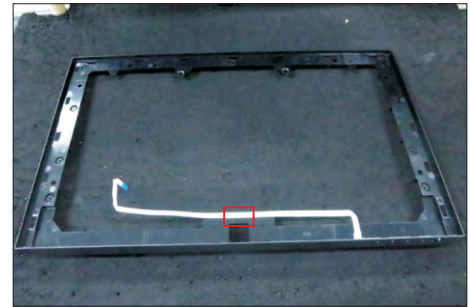
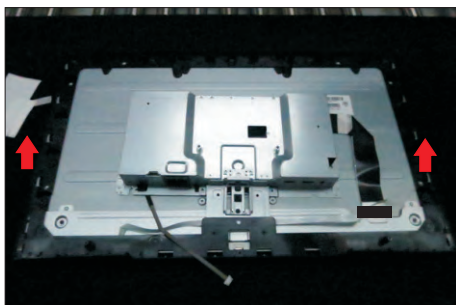

S10

Lift up the panel module with the bracket chassis for releasing the front bezel away from the panel module, and then tear off the tape.

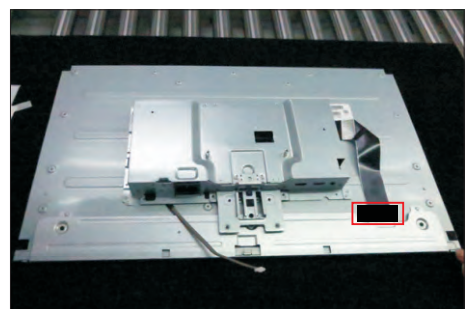

S11

Unplug the LVDS cable from the connector of the panel module by pushing the earing-locks.

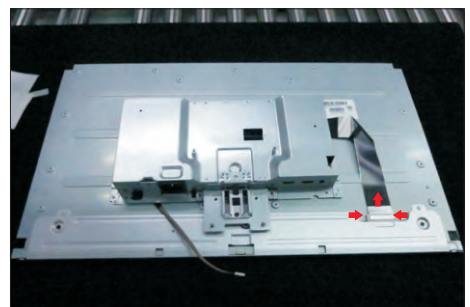

S12

Take away the bracket chassis module and then put the bracket chassis module on a protective cushion.

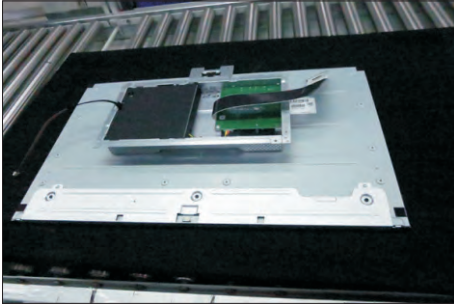

S13

Remove the Mylar from the hooks of the bracket chassis module.

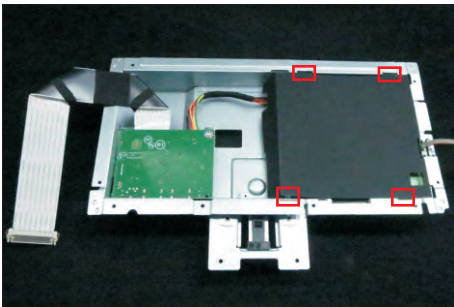

S14

Use a Philips-head screwdriver to remove 5pcs screws for unlocking the circuit board, release all the cables from the hooks.

(No.1 screw size=M4x8, Torque=6±0.5kgfxcn;
No. 2~5 screw size=M3x7.5, Torque=6±0.5kgfxcn)

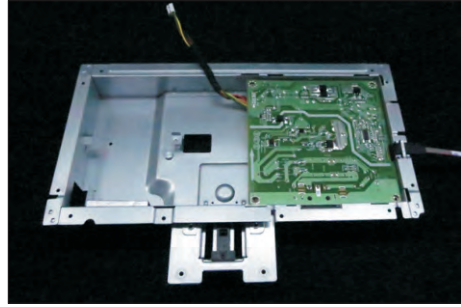
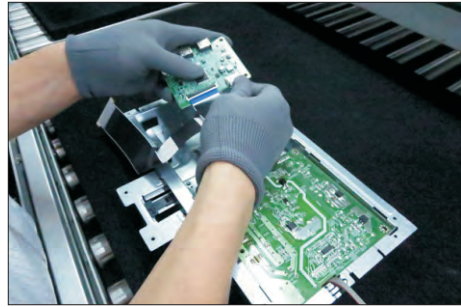
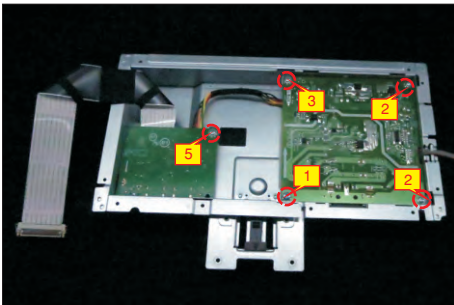

S15

Remove the interface board and power board from the bracket chassis module carefully, and disconnect all the cables.

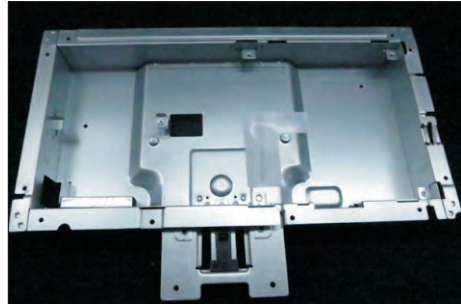

S16

Remove electrolyte capacitors (red mark) from printed circuit boards.



S16-1 Cut the glue between bulk cap. and PCB with a knife.

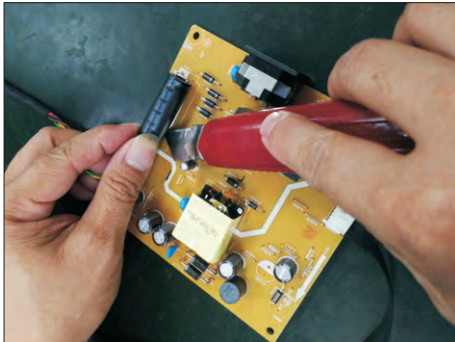

S16-2 Ensure cutting path within the glue, don't touch bulk cap. or PCB.

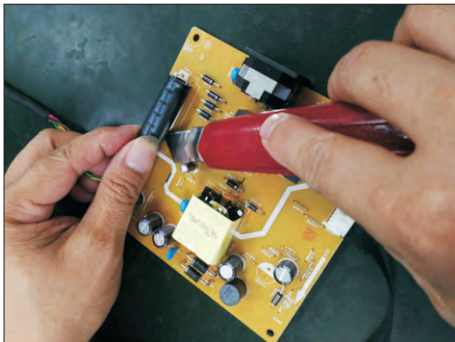

S16-3 Cut into the bottom of bulk cap. and pullit up carefully.

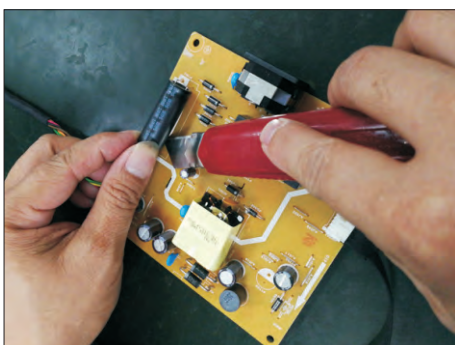

S16-4 Take out bulk cap. pin solder with soldering iron and absorber.



S16-5 Lift the bulk cap. up and away from the PCB.

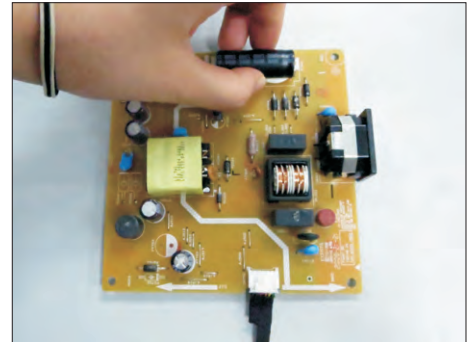

2. Product material information

The following substances, preparations, or components should be disposed of or recovered separately from other WEEE in compliance with Article 4 of EU Council Directive 75/442/EEC.

Capacitors / condensers (containing PCB/PCT)	No used
Mercury containing components	No used
Batteries	No used
Printed circuit boards (with a surface greater than 10 square cm)	Product has printed circuit boards (with a surface greater than 10 square cm)
Component contain toner, ink and liquids	No used
Plastic containing BFR	No used
Component and waste contain asbestos	No used
CRT	No used
Component contain CFC, HCFC, HFC and HC	No used
Gas discharge lamps	No used
LCD display > 100 cm ²	Product has an LCD greater than 100 cm ²
External electric cable	Product has external cables
Component contain refractory ceramic fibers	No used
Component contain radio-active substances	No used
Electrolyte capacitors (height > 25mm, diameter > 25mm)	Product has electrolyte capacitors (height > 25mm, diameter > 25mm)

3. Tools Required

List the type and size of the tools that would typically can be used to disassemble the product to a point where components and materials requiring selective treatment can be removed.

Tool Description:

- Screwdriver (Phillip head) #1
- Screwdriver (Phillip head) #2
- Penknife
- Soldering iron and absorber