

Dell P3222QE Monitor

User's Guide

Model: P3222QE
Regulatory model: P3222QEt





NOTE: A NOTE indicates important information that helps you make better use of your computer.



CAUTION: A CAUTION indicates potential damage to hardware or loss of data if instructions are not followed.



WARNING: A WARNING indicates a potential for property damage, personal injury, or death.

Copyright © 2021 Dell Inc. or its subsidiaries. All rights reserved. Dell, EMC, and other trademarks are trademarks of Dell Inc. or its subsidiaries. Other trademarks may be trademarks of their respective owners.

2021 – 05

Rev. A00

Contents

Safety Instructions	6
About Your Monitor	7
Package Contents	7
Features	8
Identifying Parts and Controls	9
Front View	9
Back View	10
Bottom View	11
Monitor Specifications	12
Resolution Specifications	13
Preset Display Modes	14
Electrical Specifications	15
Physical Characteristics	16
Environmental Characteristics	17
Pin Assignments	18
Plug-and-Play	24
LCD Monitor Quality and Pixel Policy	24
Handling and Moving Your Display	24
Maintenance Guidelines	26
Cleaning Your Monitor	26
Setting Up the Monitor	27
Connecting the Stand	27
Using the Tilt, Swivel, and Vertical Extension	30



Tilt, Swivel and Vertical Extension30
Rotating the Monitor	30
Adjusting the Rotation Display Settings of Your System.	31
Organizing Your Cables	32
Connecting Your Monitor	33
Dell Power Button Sync (DPBS)	36
Connecting the Monitor for DPBS for the First Time.38
Using DPBS Function39
Connecting the Monitor for USB-C41
Securing Your Monitor Using Kensington Lock (Optional).	43
Removing the Monitor Stand	44
Wall Mounting (Optional)	45
Operating the Monitor	46
Turning On the Monitor	46
Using the Joystick Control	46
Using the Menu Launcher	47
Front-Panel Button.49
Using the Main Menu	50
Using the OSD Lock Function61
Initial Setup.64
OSD Warning Messages65
Setting the Maximum Resolution68
Troubleshooting	69
Self-Test	69
Built-in Diagnostics	70
Common Problems.	71
Product Specific Problems	73
Universal Serial Bus (USB) Specific Problems	76



Appendix. 77
 FCC Notices (U.S. Only) and Other Regulatory Information. . 77
 Contacting Dell 77
 EU Product Database for Energy Label and Product Information
 Sheet. 77



Safety Instructions

△ CAUTION: Use of controls, adjustments, or procedures other than those specified in this documentation may result in exposure to shock, electrical hazards, and/or mechanical hazards.

- Place the monitor on a solid surface and handle it carefully. The screen is fragile and can be damaged if dropped or hit sharply.
- Always be sure that your monitor is electrically rated to operate with the AC power available in your location.
- Keep the monitor in room temperature. Excessive cold or hot conditions can have an adverse effect on the liquid crystal of the display.
- Do not subject the monitor to severe vibration or high impact conditions. For example, do not place the monitor inside a car trunk.
- Unplug the monitor when it is going to be left unused for an extended period of time.
- To avoid electric shock, do not attempt to remove any cover or touch the inside of the monitor.

For information on safety instructions, see the Safety, Environmental, and Regulatory Information (SERI).









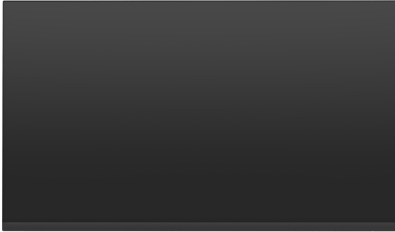

About Your Monitor

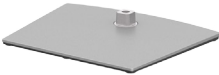
Package Contents

Your monitor ships with the components shown in the following table. Ensure that you have received all the components and see [Contact Dell](#) if anything is missing.

NOTE: Some items may be optional and may not ship with your monitor. Some features or media may not be available in certain countries.

	Display
	Stand riser
	Stand base
	Power cable (varies by country)
	USB Type-C® cable (C to C)
	USB Type-C cable (A to C)
	DP cable
	Cable Tie



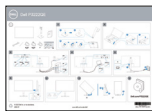

- Quick Setup Guide
- Safety, Environmental, and Regulatory Information

 **NOTE: USB Type-C® and USB-C® are registered trademarks of USB Implementers Forum.**

Features

The **Dell P3222QE** monitor has an active matrix, Thin Film Transistor (TFT), Liquid Crystal Display (LCD), and Light Emitting Diode (LED) backlight. The following are the monitor features:

- 80 cm (31.5 in.) active area display (Measured diagonally) 3840 x 2160 (16:9) resolution, plus full-screen support for lower resolutions.
- Wide viewing angles with 99% sRGB color.
- Tilt, swivel, pivot and vertical extension adjustment capabilities.
- Removable pedestal and Video Electronics Standards Association (VESA™) 100 mm mounting holes for flexible mounting solutions.
- Ultra-thin bezel minimizes the bezel gap in multi-monitor usage, enabling easier set up with an elegant viewing experience.
- Extensive digital connectivity with DP and HDMI helps future-proof your monitor.
- Plug and play capability if supported by your system.
- On-Screen Display (OSD) adjustments for ease of set-up and screen optimization.
- Power and OSD buttons lock.
- Security lock slot.
- ≤ 0.3 W in Standby Mode.
- Optimize eye comfort with a flicker-free screen minimizes hazard blue light emission.
- The monitor uses Low Blue Light panel and is in compliance with TUV Rheinland (Hardware Solution) at factory reset/default setting mode (**Preset mode: Standard**).
- Decreases the level of hazard blue light emitted from the screen to make viewing more comfortable for your eyes.
- The Monitor adopts Flicker-Free technology, which clears the eye visible flicker, brings comfort viewing experience and preventing users suffer from eye strain and fatigue.

 **WARNING: The possible long-term effects of blue light emission from the monitor may cause damage to the eyes, including eye fatigue, digital eye strain, and so on. ComforView Plus feature is designed to reduce the amount of blue light emitted from the monitor to optimize eye comfort.**



Identifying Parts and Controls

Front View

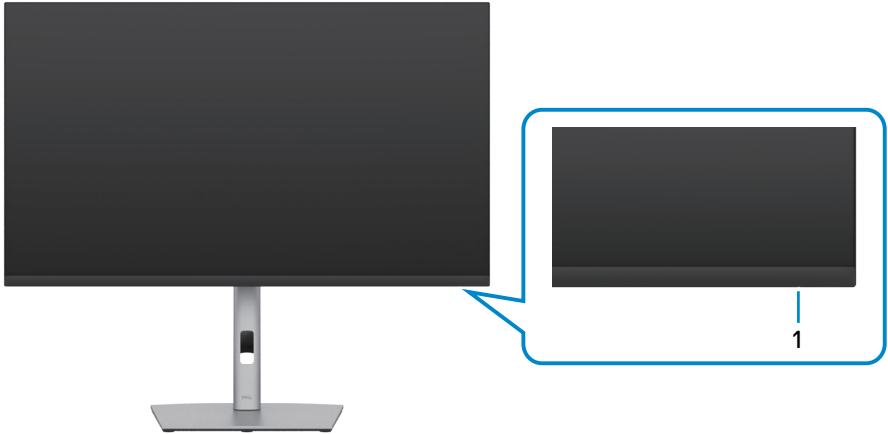

Label	Description	Use
1	Power LED indicator	Solid white light indicates the monitor is turned on and functioning normally. The blinking white light indicates the monitor is in Standby Mode.



Back View

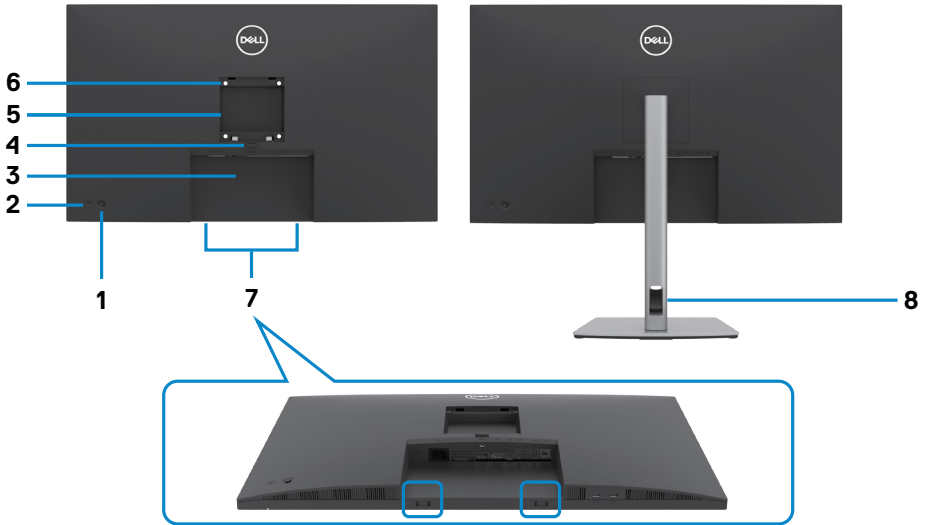

Label	Description	Use
1	Joystick	Controls the OSD menu.
2	Power on/off button	Turns the monitor on or off.
3	Barcode, serial number, and Service Tag label	Refer to this label if you need to contact Dell for technical support.
4	Stand release button	Release stand from monitor.
5	Regulatory label	Lists the regulatory approvals.
6	VESA mounting holes (100 mm x 100 mm-behind attached VESA cover)	Wall mount monitor using VESA-compatible wall mount kit (100 mm x 100 mm).
7	Dell soundbar mounting slots	Attaches the optional Dell soundbar.
8	Cable management slot	Used to organize cables by placing them through the slot.



Bottom View

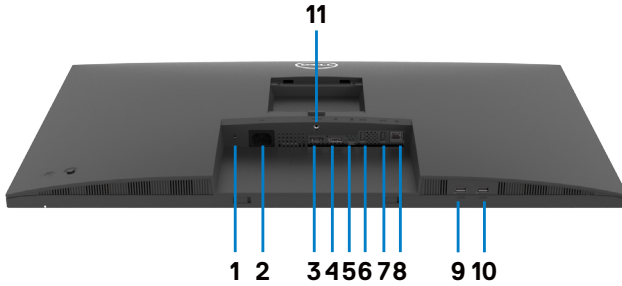

Label	Description	Use
1	Security lock slot	Secures monitor with security cable lock (sold separately).
2	AC power port	To connect the monitor power cable.
3	HDMI port	Connect your computer with HDMI cable (sold separately).
4	DP port (in)	Connect your computer with DP cable.
5	USB-C port	Connect to your computer using the USB-C cable. The USB-C port offer the fastest transfer rate and the alternate mode with DP 1.4 support the maximum resolution of 3840 x 2160 at 60 Hz PD 20 V / 3.25 A, 15 V / 3 A, 9 V / 3 A, 5 V / 3 A. NOTE: USB-C is not supported on Windows versions that are prior to Windows 10.
6&7 9&10	USB-A downstream port (4)	Port with  icon supports 5 V / 0.9 A. Connect your USB device. You can use these ports only after you have connected the USB cable from the computer to the monitor. NOTE: To avoid signal interference, when a wireless USB device has been connected to a USB downstream port, it is NOT recommended to connect any other USB devices to the adjacent port(s).
8	RJ-45 connector	Connect Internet. You can surf Internet via RJ45 only after you have connected the USB cable (A to C or C to C) from the computer to the monitor.
11	Stand lock	Lock the stand to the monitor using a M3 x 6 mm screw (screw not included).



Monitor Specifications

Screen type	Active matrix - TFT LCD
Panel Type	In-plane switching Technology
Aspect ratio	16:9
Viewable image dimensions	
Diagonal	800.01 mm (31.5 in.)
Active Area	
Horizontal	697.31 mm (27.45 in.)
Vertical	392.23 mm (15.44 in.)
Area	273505.9 mm ² (423.94 in. ²)
Pixel pitch	0.18159 mm x 0.18159 mm
Pixel per inch (PPI)	139.87
Viewing angle	
Horizontal	178° (typical)
Vertical	178° (typical)
Brightness	350 cd/m ² (typical)
Contrast ratio	1000 to 1 (typical)
Display screen coating	Anti-glare treatment of the front polarizer (3H) hard coating
Backlight	LED
Response Time (Gray to Gray)	5 ms (Fast mode) 8 ms (Normal mode)
Color depth	1.07 billion colors
Color gamut*	99% sRGB
Connectivity	<ul style="list-style-type: none"> • 1 x DP 1.4 (in) port (HDCP 1.4, HDCP 2.2) • 1 x HDMI 2.0 port (HDCP 1.4, HDCP 2.2) • 1 x USB-C (USB 3.2 Gen 1 (5Gbps) upstream port, Power Delivery PD up to 65 W) • 4 x Super speed USB 5Gbps (USB 3.2 Gen1) downstream port • 1 x RJ45



Border width (edge of monitor to active area)	
Top	7.57 mm
Left/Right	7.55 mm
Bottom	17.40 mm
Adjustability	
Height adjustable stand	150 mm
Tilt	-5° to 21°
Swivel	-30 to 30°
Pivot	-90 to 90°
Cable management	Yes
Dell Display Manager (DDM) Compatibility	Easy Arrange and other key features
Security	Security lock slot (cable lock sold separately)

* At panel native only, under Custom Mode preset.

Resolution Specifications

Horizontal scan range	30 kHz to 140 kHz
Vertical scan range	24 Hz to 75 Hz
Maximum preset resolution	3840 x 2160 at 60 Hz
Video display capabilities (HDMI & DP & USB-C alternate mode)	480p, 576p, 720p, 1080i, 1080p, 2160p



Preset Display Modes

Display Mode	Horizontal Frequency (kHz)	Vertical Frequency (Hz)	Pixel Clock (MHz)	Sync Polarity (Horizontal/Vertical)
720 x 400	31.5	70.0	28.3	-/+
VESA, 640 x 480	31.5	60.0	25.2	-/-
VESA, 640 x 480	37.5	75.0	31.5	-/-
VESA, 800 x 600	37.9	60.3	40.0	+/+
VESA, 800 x 600	46.9	75.0	49.5	+/+
VESA, 1024 x 768	48.4	60.0	65.0	-/-
VESA, 1024 x 768	60.0	75.0	78.8	+/+
VESA, 1152 x 864	67.5	75.0	108.0	+/+
VESA, 1280 x 800	49.3	60.0	71.0	+/-
VESA, 1280 x 1024	64.0	60.0	108.0	+/+
VESA, 1280 x 1024	80.0	75.0	135.0	+/+
VESA, 1600 x 1200	75.0	60.0	162.0	+/+
VESA, 1680 x 1050	65.29	60.0	146.25	-/+
VESA, 1920 x 1080	67.5	60.0	148.5	+/+
VESA, 1920 x 1200	74.04	60.0	154.0	+/-
VESA, 2048 x 1080	66.58	60.0	147.18	+/-
VESA, 2048 x 1152	70.99	60.0	156.75	+/-
CVT, 2048 x 1280	78.91	60.0	174.25	+/-
CVR, 2560 x 1440	88.8	60.0	241.5	+/-
CVT, 3840 x 2160	65.67	30.0	262.75	+/+
CVT, 3840 x 2160	133.31	60.0	534.0	+/+



Electrical Specifications

Video input signals	<ul style="list-style-type: none"> • Digital video signal for each differential line Per differential line at 100 ohm impedance • DP / HDMI / USB-C signal input support
Input voltage/ frequency/ current	100-240 VAC / 50 or 60 Hz \pm 3 Hz / 1.8 A (maximum)
Inrush current	120 V: 42 A (Max.) 240 V: 80 A (Max.)
Power Consumption	0.2 W (Off Mode) ¹ 0.2 W (Standby Mode) ¹ 28.3 W (On Mode) ¹ 145 W (Max) ² 24.66 W (P_{on}) ³ 78.17 kWh (TEC) ³

¹ As defined in EU 2019/2021 and EU 2019/2013.

² Max brightness and contrast setting with maximum power loading on all USB ports.

³ P_{on} : Power consumption of On Mode as defined in Energy Star 8.0 version.

TEC: Total energy consumption in kWh as defined in Energy Star 8.0 version.

This document is informational only and reflects laboratory performance. Your product may perform differently, depending on the software, components and peripherals you ordered and shall have no obligation to update such information. Accordingly, the customer should not rely upon this information in making decisions about electrical tolerances or otherwise. No warranty as to accuracy or completeness is expressed or implied.

 **NOTE: This monitor is ENERGY STAR certified.**



This product qualifies for ENERGY STAR in the factory default settings which can be restored by “Factory Reset” function in the OSD menu. Changing the factory default settings or enabling other features may increase power consumption that could exceed the ENERGY STAR specified limit.



Physical Characteristics

Connector type	<ul style="list-style-type: none"> • DP connector (DP in) • HDMI connector • USB-C connector • USB 3.2 Gen1 (5 Gbps) downstream port connector x 4 • RJ45 connector
Signal cable type	<ul style="list-style-type: none"> • DP to DP 1.8 M cable • USB-C 1 M cable • USB-A to C 1.8 M cable
Dimensions (with stand)	
Height (extended)	618.67 mm (24.36 in.)
Height (compressed)	468.67 mm (18.45 in.)
Width	712.40 mm (28.05 in.)
Depth	233.17 mm (9.18 in.)
Dimensions (without stand)	
Height	417.17 mm (16.42 in.)
Width	712.40 mm (28.05 in.)
Depth	56.18 mm (2.21 in.)
Stand dimensions	
Height (extended)	483.30 mm (19.03 in.)
Height (compressed)	436.50 mm (17.19 in.)
Width	300.00 mm (11.81 in.)
Depth	233.17 mm (9.18 in.)
Base	300.00 mm x 230.00 mm (11.81 in. x 9.06 in.)
Weight	
Weight with packaging	13.40 kg (29.53 lb.)
Weight with stand assembly and cables	10.00 kg (22.04 lb.)



Weight without stand assembly (For wall mount or VESA mount considerations - no cables)	5.30 kg (11.68 lb.)
Weight of stand assembly	4.30 kg (9.48 lb.)

Environmental Characteristics

Compliant Standards	
<ul style="list-style-type: none"> • ENERGY STAR certified Monitor. • EPEAT registered where applicable. EPEAT registration varies by country. See https://www.epeat.net for registration status by country. • TCO and TCO Edge Certified Displays. • RoHS Compliant. • BFR/PVC Free monitor (excluding external cables). • Meets NFPA 99 leakage current requirements. • Arsenic-Free glass and Mercury-Free for the panel only. 	
Temperature	
Operating	0°C to 40°C (32°F to 104°F)
Non-operating	-20°C to 60°C (-4°F to 140°F)
Humidity	
Operating	20% to 80% (non-condensing)
Non-operating	5% to 90% (non-condensing)
Altitude	
Operating	5,000 m (16,404 ft.) (maximum)
Non-operating	12,192 m (40,000 ft.) (maximum)
Thermal dissipation	494.76 BTU/hour (maximum) 70.29 BTU/hour (On Mode)



Pin Assignments

DP Port (in)

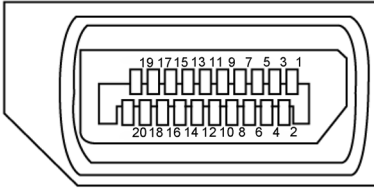

Pin number	20-pin side of the connected signal cable
1	ML3(n)
2	GND
3	ML3(p)
4	ML2(n)
5	GND
6	ML2(p)
7	ML1(n)
8	GND
9	ML1(p)
10	ML0(n)
11	GND
12	ML0(p)
13	CONFIG1
14	CONFIG2
15	AUX CH (p)
16	GND
17	AUX CH (n)
18	Hot Plug Detect
19	Return
20	DP_PWR



HDMI Port

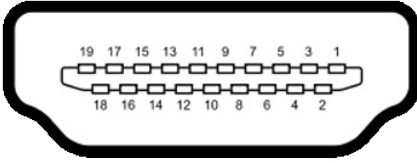

Pin number	19-pin side of the connected signal cable
1	TMDS DATA 2+
2	TMDS DATA 2 SHIELD
3	TMDS DATA 2-
4	TMDS DATA 1+
5	TMDS DATA 1 SHIELD
6	TMDS DATA 1-
7	TMDS DATA 0+
8	TMDS DATA 0 SHIELD
9	TMDS DATA 0-
10	TMDS CLOCK+
11	TMDS CLOCK SHIELD
12	TMDS CLOCK-
13	CEC
14	Reserved (N.C. on device)
15	DDC CLOCK (SCL)
16	DDC DATA (SDA)
17	DDC/CEC Ground
18	+5 V POWER
19	HOT PLUG DETECT



USB-C Port

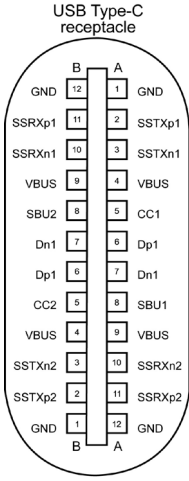

typically connected to a charger through a Type-C cable

Pin	Signal	Pin	Signal
A1	GND	B12	GND
A2	SSTXp1	B11	SSRXp1
A3	SSTXn1	B10	SSRXn1
A4	VBUS	B9	VBUS
A5	CC1	B8	SBU2
A6	Dp1	B7	Dn1
A7	Dn1	B6	Dp1
A8	SBU1	B5	CC2
A9	VBUS	B4	VBUS
A10	SSRXn2	B3	SSTXn2
A11	SSRXp2	B2	SSTXp2
A12	GND	B1	GND



Universal Serial Bus (USB)

This section gives you information about the USB ports available on your monitor.

NOTE: This monitor is Super speed USB 5Gbps (USB 3.2 Gen1) and High-speed USB 2.0 compatible.

Your computer has the following USB ports:

- 4 downstream - Super speed USB 5Gbps (USB 3.2 Gen1)

NOTE: The monitor's USB ports work only when the monitor is on or in Standby mode. If you turn off the monitor and then turn it on, the attached peripherals may take a few seconds to resume normal functionality.

Super speed USB 5Gbps (USB 3.2 Gen1)

Transfer speed	Data rate	Maximum power supported (each port)
Super speed	5 Gbps	4.5 W
Hi-Speed	480 Mbps	2.5 W
Full speed	12 Mbps	2.5 W

USB 3.2 Gen1 (5Gbps) Downstream Port

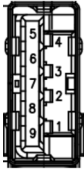

Pin number	Signal	Pin number	Signal
1	VBUS	6	StdA_SSRX+
2	D-	7	GND_DRAIN
3	D+	8	StdA_SSTX-
4	GND	9	StdA_SSTX+
5	StdA_SSRX-	Shell	Shield



RJ45 Port (Connector Side)

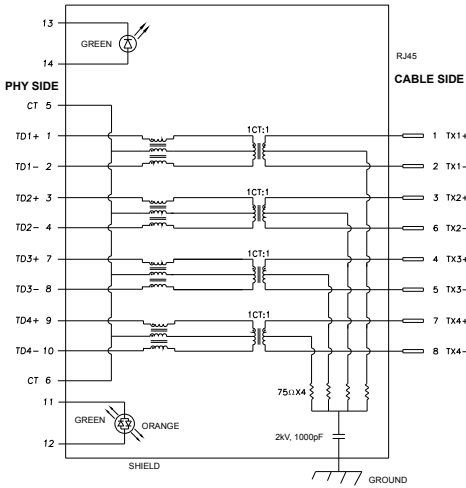

Pin	Signal	Pin	Signal
1	TD1 +	8	TD3 -
2	TD1 -	9	TD4 +
3	TD2 +	10	TD4 -
4	TD2 -	11	GREEN_OR-ANGE
5	CT	12	GREEN_OR-ANGE
6	CT	13	GREEN
7	TD3 +	14	GREEN

Driver Installation

Install the Realtek USB GBE Ethernet Controller Driver available for your system. This is available for download at <https://www.dell.com/support> under the “**Driver and download**” section.

Network (RJ45) data rate via USB-C max speed is 1000 Mbps.

NOTE: This LAN port is 1000Base-T IEEE 802.3az compliant, supporting Mac Address (Printed on model label) Pass-thru (MAPT), Wake-on-LAN (WOL) from standby mode (S3 only) and UEFI*PXE Boot function, these 3 features depend on BIOS setting and OS version.

* UEFI stands for Unified Extensible Firmware Interface.



RJ45 Connector LED Status:



LED	Color	Description
Right LED	Amber or Green	Speed indicator: <ul style="list-style-type: none">• Amber On - 1000 Mbps• Green On - 100 Mbps• Off - 10 Mbps
Left LED	Green	Link / Activity indicator: <ul style="list-style-type: none">• Blinking - Activity on the port.• Green On - Link is being established.• Off - Link is not established.

 **NOTE: RJ45 cable is non in-box standard accessory.**



Plug-and-Play

You can install the monitor in any Plug-and-Play-compatible system. The monitor automatically provides the computer system with its extended display identification data (EDID) using display data channel (DDC) protocols so the computer can configure itself and optimize the monitor settings. Most monitor installations are automatic; you can select different settings if desired. For more information about changing the monitor settings, see [Operating the Monitor](#).

LCD Monitor Quality and Pixel Policy

During the LCD monitor manufacturing process, it is not uncommon for one or more pixels to become fixed in an unchanging state which are hard to see and do not affect the display quality or usability. For more information on LCD Monitor Pixel Policy, see Dell support site at: <https://www.dell.com/pixelguidelines>

Handling and Moving Your Display

To ensure the monitor is handled safely when lifting or moving it, follow the guidelines mentioned below:

- Before moving or lifting the monitor, turn off your computer and the monitor.
- Disconnect all cables from the monitor.
- Place the monitor in the original box with the original packing materials.
- Hold the bottom edge and the side of the monitor firmly without applying excessive pressure when lifting or moving the monitor.

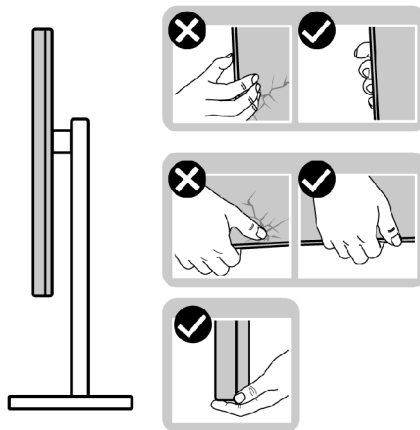

- When lifting or moving the monitor, ensure the screen is facing away from you and do not press on the display area to avoid any scratches or damage.

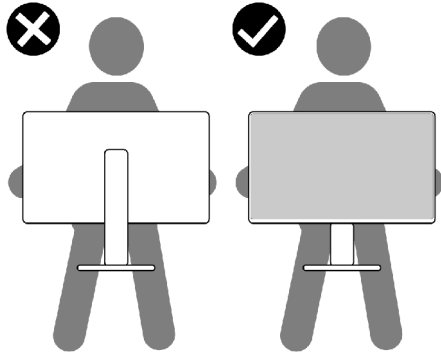

- When transporting the monitor, avoid any sudden shock or vibration to it.
- When lifting or moving the monitor, do not turn the monitor upside down while holding the stand base or stand riser. This may result in accidental damage to the monitor or cause personal injury.

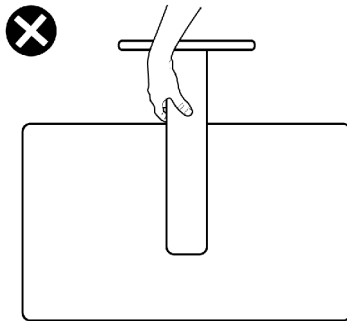

Maintenance Guidelines

Cleaning Your Monitor

 **WARNING:** Before cleaning the monitor, unplug the monitor power cable from the electrical outlet.

 **CAUTION:** Read and follow the [Safety instructions](#) before cleaning the monitor.

For best practices, follow the instructions in the list below when unpacking, cleaning, or handling your monitor:

- To clean your anti-static screen, lightly dampen a soft, clean cloth with water. If possible, use a special screen-cleaning tissue or solution suitable for the anti-static coating. Do not use benzene, thinner, ammonia, abrasive cleaners, or compressed air.
- Use a lightly-dampened, warm cloth to clean the monitor. Avoid using detergent of any kind as some detergents leave a milky film on the monitor.
- If you notice white powder when you unpack your monitor, wipe it off with a cloth.
- Handle your monitor with care as a darker-colored monitor may get scratched and show white scuff marks more than a lighter-colored monitor.
- To help maintain the best image quality on your monitor, use a dynamically changing screen saver and turn off your monitor when not in use.



Setting Up the Monitor

Connecting the Stand

- NOTE: The stand riser and stand base are detached when the monitor is shipped from the factory.
- NOTE: The following instructions are applicable only for the stand that was shipped with your monitor. If you are connecting a stand that you purchased from any other source, follow the set up instructions that were included with the stand.

CAUTION: Place monitor on a flat, clean, and soft surface to avoid scratching the display panel.

To attach the monitor stand:

1. Align and place the stand riser on the stand base.
2. Open the screw handle at the bottom of the stand base and turn it clockwise to secure the stand assembly.
3. Close the screw handle.

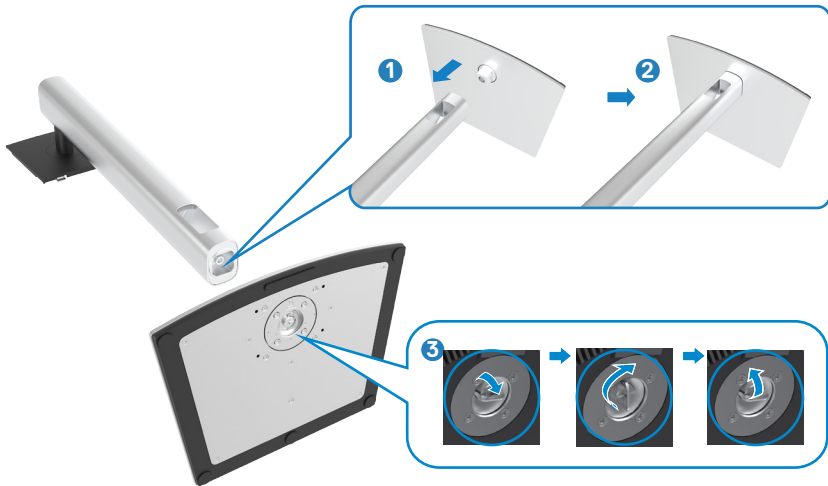

4. Open the protective cover on the monitor to access the VESA slot on the monitor.



5. Slide the tabs on the stand riser into the slots on the display back cover and press down the stand assembly to snap it into place.



6. Hold the stand riser and lift the monitor carefully, then place it on a flat surface.



NOTE: Hold the stand riser firmly when lifting the monitor to avoid any accidental damage.

7. Lift the protective cover from the monitor.

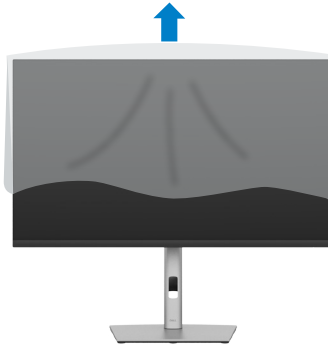

Using the Tilt, Swivel, and Vertical Extension

NOTE: The following instructions are applicable only for the stand that was shipped with your monitor. If you are connecting a stand that you purchased from any other source, follow the set up instructions that were included with the stand.

Tilt, Swivel and Vertical Extension

With the stand attached to the monitor, you can tilt the monitor for the most comfortable viewing angle.

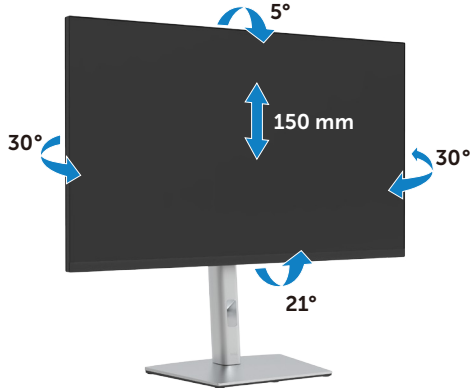



NOTE: The stand is detached when the monitor is shipped from the factory.

Rotating the Monitor

Before you rotate the monitor, your monitor should be fully vertically extended and fully tilted up to avoid hitting the bottom edge of the monitor.



-  **NOTE:** To use the Display Rotation function (Landscape versus Portrait view) with your Dell computer, you require an updated graphics driver that is not included with this monitor. To download the graphics driver, go to <https://www.dell.com/support> and see the Download section for Video Drivers for latest driver updates.
-  **NOTE:** When in the Portrait View Mode, you may experience performance degradation in graphic-intensive applications (3D Gaming and so on).

Adjusting the Rotation Display Settings of Your System

After you have rotated your monitor, you need to complete the procedure below to adjust the Rotation Display Settings of your System.

-  **NOTE:** If you are using the monitor with a non-Dell computer, you need to go the graphics driver website or your computer manufacturer website for information on rotating the 'contents' on your display.

To adjust the Rotation Display Settings:

1. Right-click on the desktop and click Properties.
 2. Select the Settings tab and click Advanced.
 3. If you have an AMD graphics card, select the Rotation tab and set the preferred rotation.
 4. If you have an NVIDIA graphics card, click the NVIDIA tab, in the left-hand column select NVRotate, and then select the preferred rotation.
 5. If you have an Intel® graphics card, select the Intel graphics tab, click Graphic Properties, select the Rotation tab, and then set the preferred rotation.
-  **NOTE:** If you do not see the rotation option or it is not working correctly, go to <https://www.dell.com/support> and download the latest driver for your graphics card.



Organizing Your Cables



After connecting all necessary cables to your monitor and computer, (see [Connecting Your Monitor](#) for cable attachment) organize all cables as shown above.



Connecting Your Monitor

⚠ WARNING: Before you begin any of the procedures in this section, follow the **Safety Instructions**.

To connect your monitor to the computer:

1. Turn off your computer.
2. Connect the HDMI, DP or USB-C cable from your monitor to the computer.
3. Turn on your monitor.
4. Select the correct input source from the OSD Menu on your monitor and then turn on your computer.

📎 NOTE: P3222QE default setting is DP 1.4. A DP 1.1 Graphic card may not display normally.

Connecting the HDMI Cable

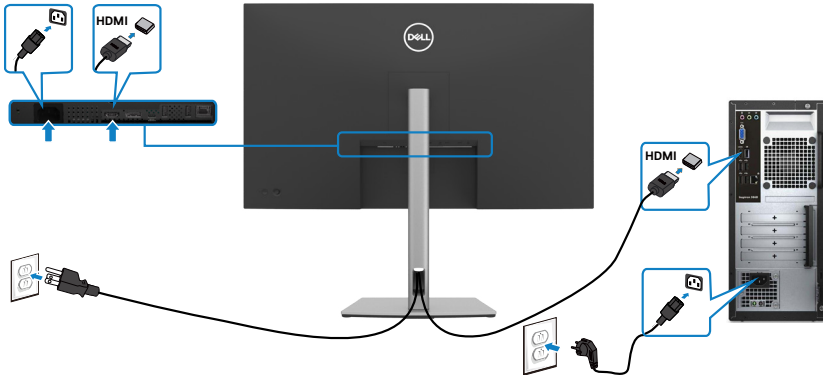

Connecting the DP Cable

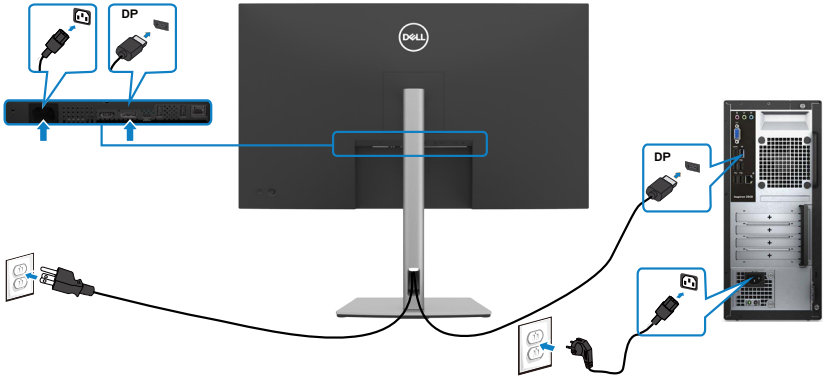

Connecting the USB Type-C® Cable (C to C)

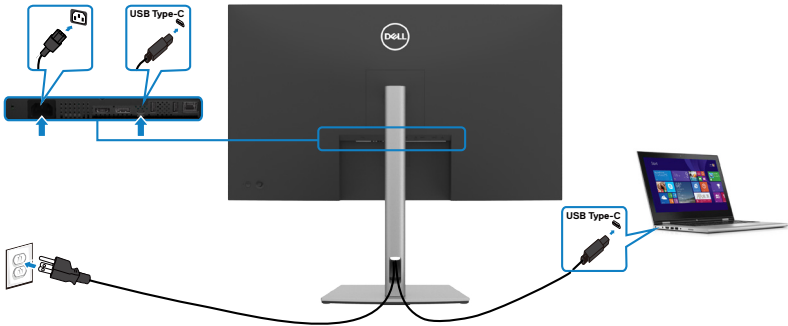

The USB-C port on your monitor:

- Can be used as USB-C or DisplayPort 1.4, alternatively.
- Supports USB Power Delivery (PD), with profiles up to 65 W.

NOTE: Regardless of the power requirement/actual power consumption of your laptop, or the remaining power runtime in your battery, the Dell P3222QE monitor is designed to supply power delivery of up to 65 W to your laptop.



Rated power (on laptops that have USB-C with Power Delivery)	Maximum charging power
45 W	45 W
65 W	65 W
90 W	Not supported
130 W	Not supported

Connecting the USB Type-C Cable (A to C)

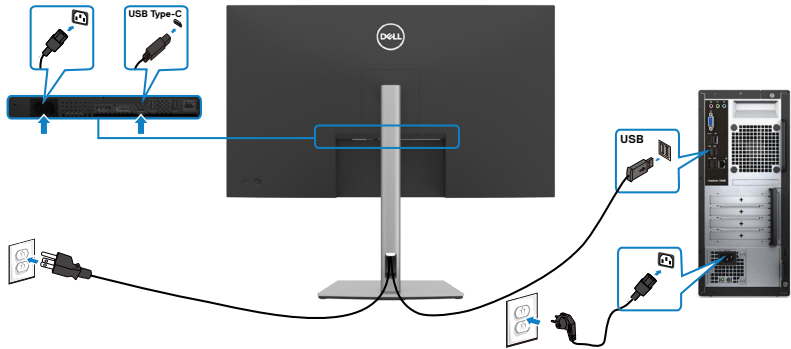

Connecting the Monitor for RJ45 Cable (Optional)

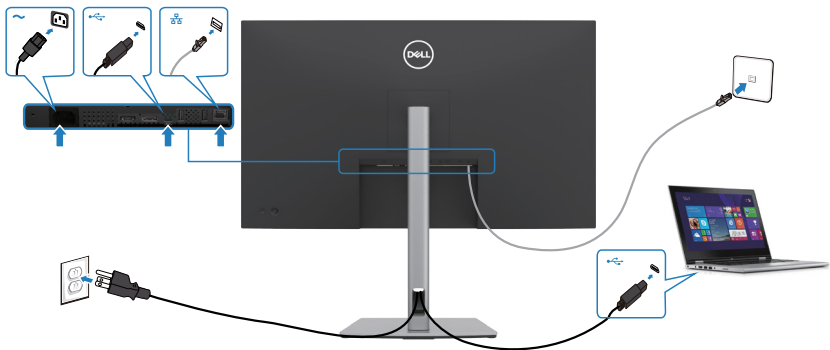

Dell Power Button Sync (DPBS)

Your monitor is designed with Dell Power Button Sync (DPBS) feature to allow you to control PC system power state from the monitor power button. This feature is only supported with Dell platform which has built-in DPBS function, and is only supported over USB-C interface.

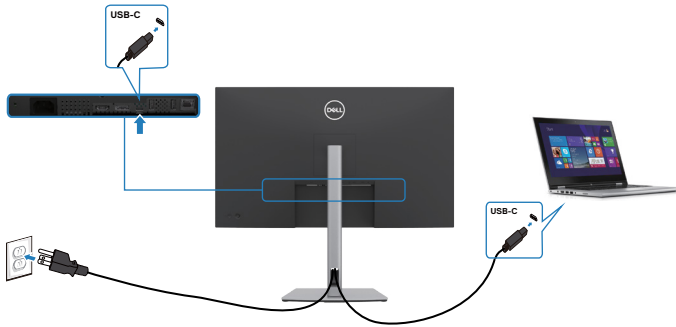

To make sure the DPBS function works for the first time, perform the following steps on the DPBS supported platform in the **Control Panel** first.

NOTE: DPBS only supports the USB-C upstream port.

1. Go to **Control Panel**.

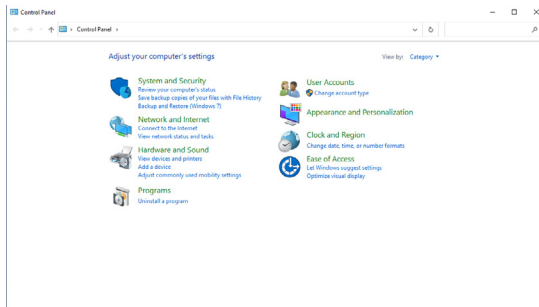

2. Select **Hardware and Sound**, followed by **Power Options**.

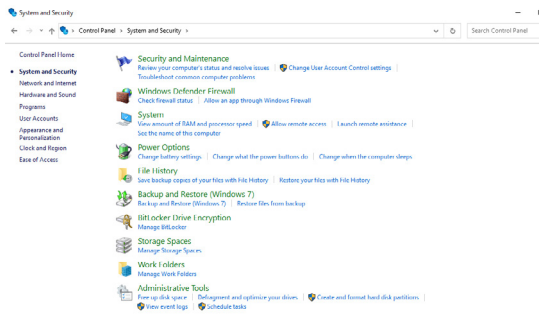

3. Go to **System Settings**.

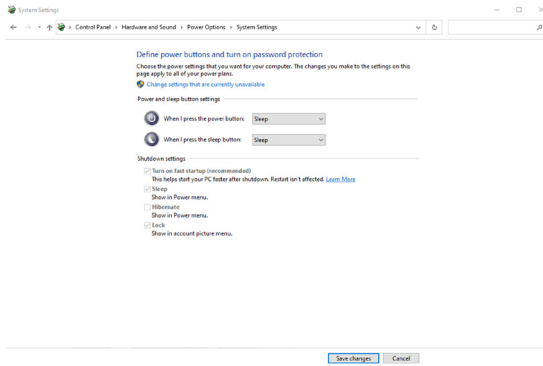

4. In the drop-down menu of **When I press the power button**, there are a few options for selection namely **Do nothing/Sleep/Hibernate/Shut down**. You can select **Sleep/Hibernate/Shut down**.

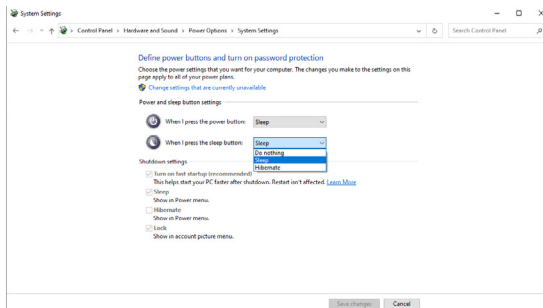
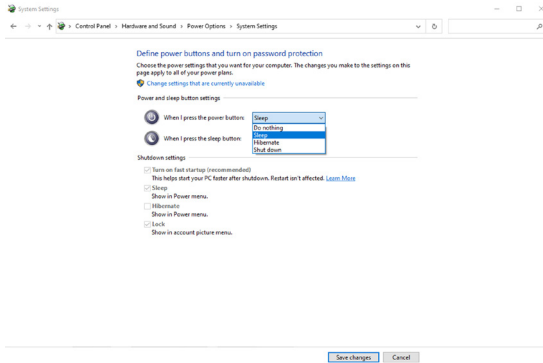

NOTE: Do not select **Do nothing**, otherwise the monitor power button will not be able to sync with PC system power state.



Connecting the Monitor for DPBS for the First Time

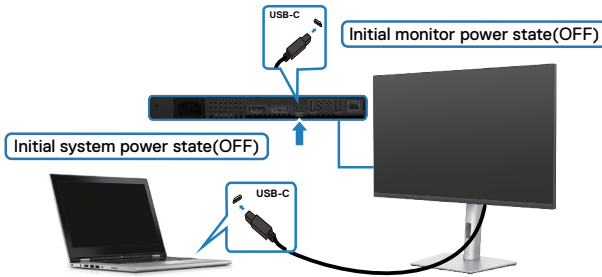

For the first time setting up the DPBS function:

1. Make sure both the PC and monitor is OFF.
2. Press the monitor power button to turn ON the monitor.
3. Connect the USB-C cable from the PC to the monitor.
4. Both the monitor and PC will turn ON normally except Dell Optiplex 7090/3090 Ultra platform.
5. When you connect the Dell Optiplex 7090/3090 Ultra platform, you may see both the monitor and PC will turn ON momentarily. Wait for a while (approximately 6 seconds) and both the PC and monitor will turn OFF. When you press either the monitor power button or PC power button, both the PC and monitor will turn ON. The PC system power state is in sync with the monitor power button.

NOTE: When the monitor and PC are both at power OFF state for the first time, it is recommended that you turn ON the monitor first, then connect the USB-C cable from the PC to the monitor.

NOTE: You can power the Dell PC* Ultra platform using its DC adaptor jack. Alternatively, you can power the Dell PC* Ultra platform using the monitor's USB-C cable via Power Delivery (PD); please set USB-C Charging  65 W to On in Off Mode.

* Ensure to check the Dell PC for DBPS supportability.



Using DPBS Function

Waking on the USB-C cable

When you connect the USB-C cable, the Monitor/PC state is as follows:

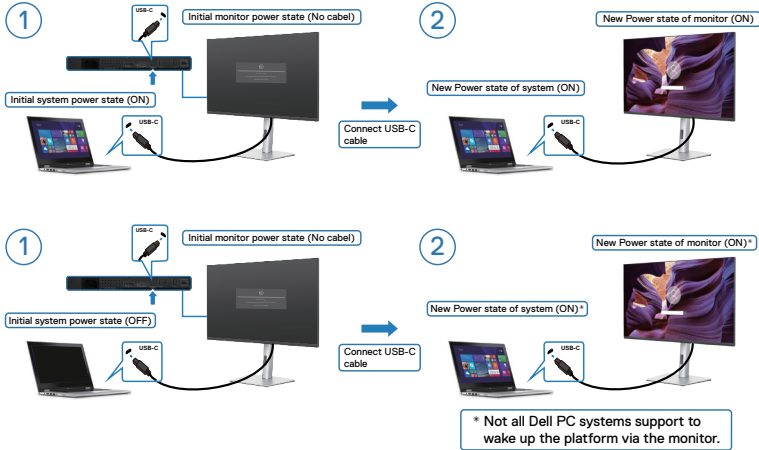

When you press the monitor power button or PC power button, the Monitor/PC state is as follows:

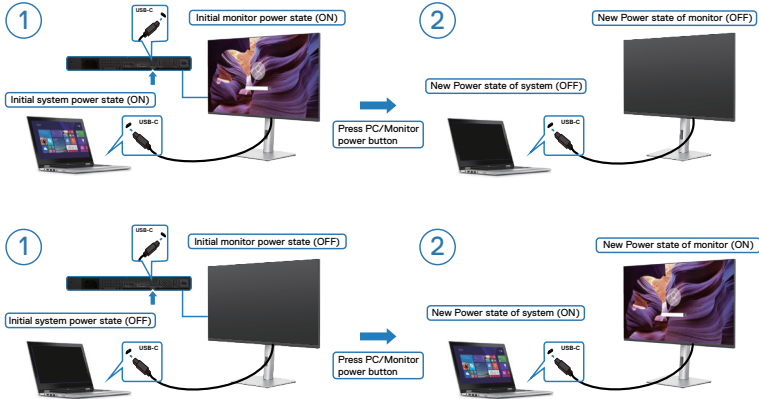

- When the monitor and the PC power state are both ON, **press and hold the monitor power button for 4 seconds**, the screen prompt will ask if you would like to shut down the PC.

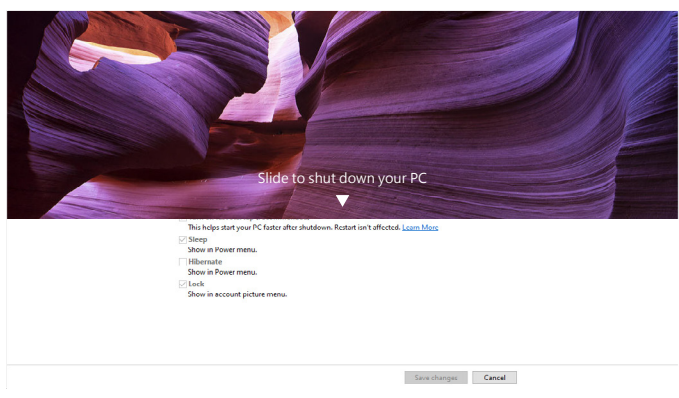
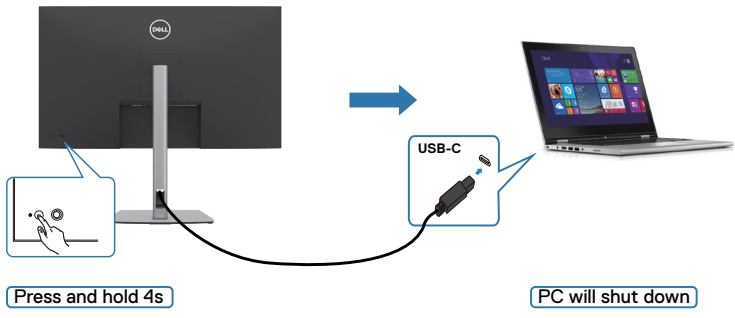

- When the monitor and the PC power state are both ON, **press and hold the monitor power button for 10 seconds**, the PC will shut down.

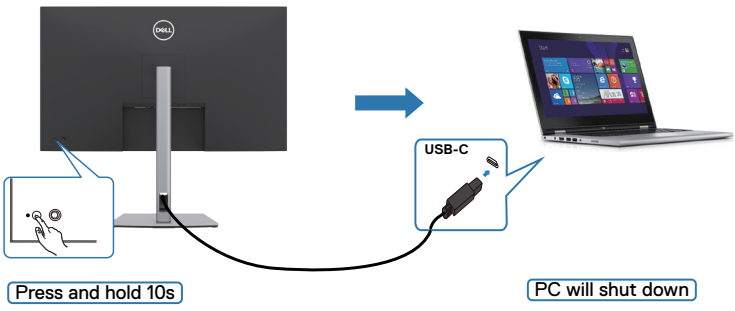

Connecting the Monitor for USB-C

The Dell PC* Ultra platform has two USB-C ports, so both Monitor 1 and Monitor 2 power state can sync with the PC.

While the PC and two monitors are in an initially ON power state, by pressing the power button on Monitor 1 or Monitor 2 will turn OFF the PC, Monitor 1, and Monitor 2.

* Ensure to check the Dell PC for DBPS supportability.

NOTE: DPBS only supports the USB-C upstream port.

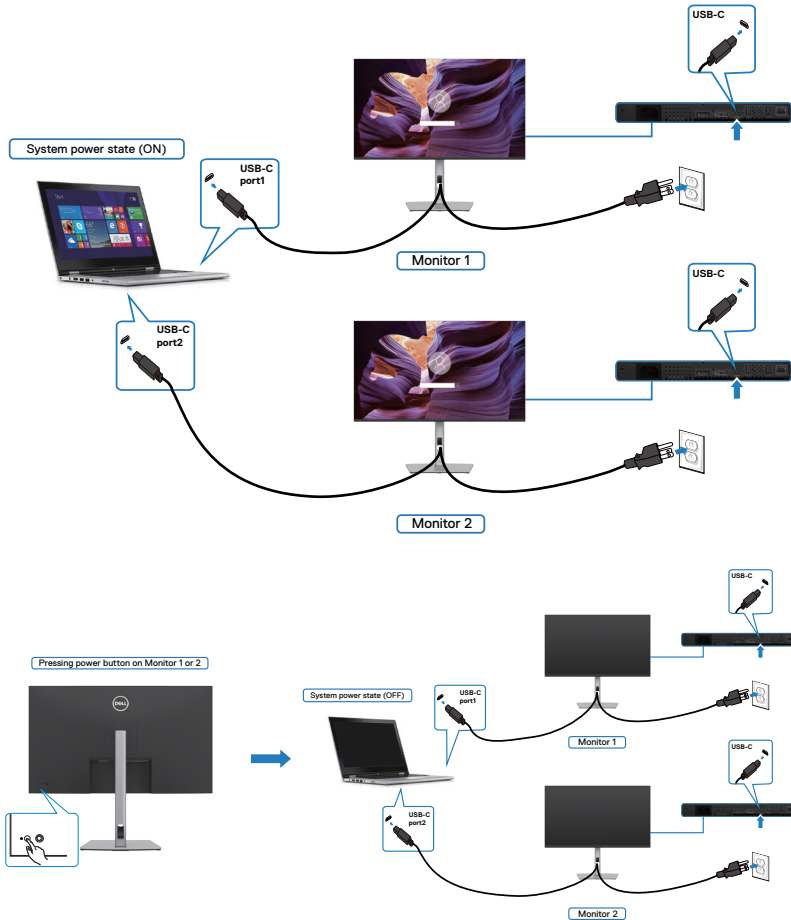

Ensure to set **USB-C Charging 65W** to **On in Off Mode**. When the PC and two monitors are in an initially OFF power state, pressing the power button on Monitor 1 or Monitor 2 will turn ON the PC, Monitor 1, and Monitor 2.

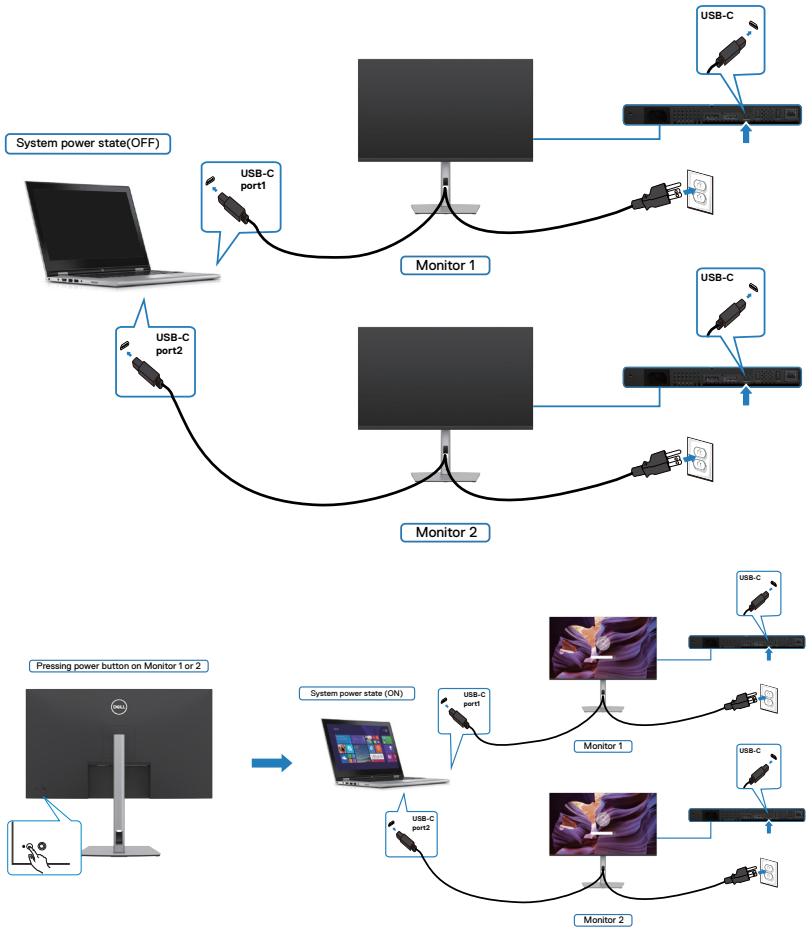

Securing Your Monitor Using Kensington Lock (Optional)

The security lock slot is located at the bottom of the monitor. (See [Security lock slot](#))

For more information on using the Kensington lock (purchased separately), see the documentation that is shipped with the lock.

Secure your monitor to a table using the Kensington security lock.

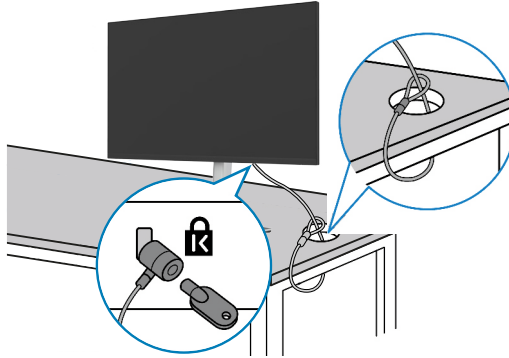

NOTE: The image is for the purpose of illustration only. Appearance of the lock may vary.



Removing the Monitor Stand

△ CAUTION: To prevent scratches on the LCD screen while removing the stand, make sure that the monitor is placed on a soft, clean surface.

✎ NOTE: The following instructions are applicable only for the stand that was shipped with your monitor. If you are connecting a stand that you purchased from any other source, follow the set up instructions that were included with the stand.

To remove the stand:

1. Place the monitor on a soft cloth or cushion.
2. Press and hold the stand-release button.
3. Lift the stand up and away from the monitor.

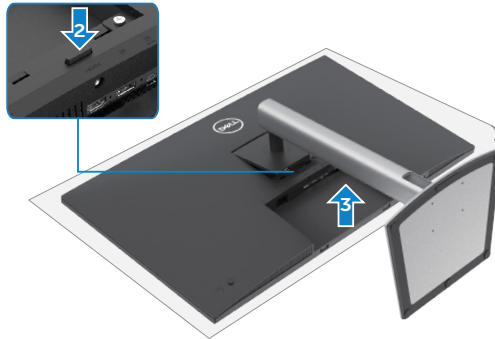

Wall Mounting (Optional)

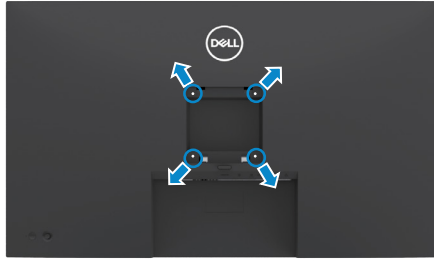

NOTE: Use M3 x 6 mm screws to connect the monitor to the wall-mounting kit.

Refer to the instructions that come with the VESA-compatible wall mounting kit.

1. Place the monitor on a soft cloth or cushion on a stable, flat table.
2. Remove the stand.
3. Use a Phillips crosshead screwdriver to remove the four screws securing the plastic cover.
4. Attach the mounting bracket from the wall mounting kit to the monitor.
5. Mount the monitor on the wall by following the instructions that comes with the wall mounting kit.

NOTE: For use only with UL or CSA or GS-listed wall mount bracket with minimum weight/load bearing capacity of 21.2 kg (46.7 lb.).



Operating the Monitor

Turning On the Monitor

Press the ● button to turn on the monitor.

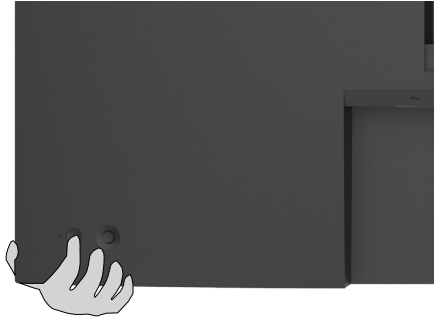

Using the Joystick Control





To modify the OSD adjustments using the Joystick control on the rear end of the monitor, do the following:

1. Press the Joystick to open the OSD Menu Launcher.
2. Move the Joystick up/down/left/right to toggle between the OSD menu options.



Joystick Functions

Functions	Description
	Press Joystick to open the OSD Menu Launcher.
	For right and left navigation.
	For up and down navigation.

Using the Menu Launcher

Press the Joystick to open the OSD Menu Launcher.

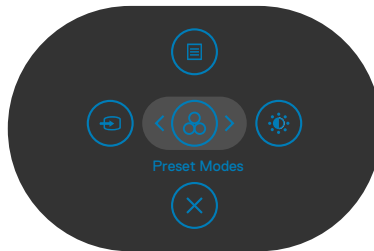





Menu Launcher

- Toggle the Joystick **Up** to open the **Main Menu**.
- Toggle the Joystick **Left** or **Right** to select the desired **Shortcut Keys**.
- Toggle the Joystick **Down** to **Exit**.



Menu Launcher Details

The following table describes the Menu Launcher icons:





Menu Launcher icons	Description
 Main Menu	Opens the On-Screen Display (OSD). See Using the Main Menu .
 Input Source (Shortcut key 1)	Sets the Input Source .
 Preset Modes (Shortcut key 2)	Allows to choose from a list of Preset Color Modes .
 Brightness/Contrast (Shortcut key 3)	To directly access the Brightness/Contrast adjustment sliders.
 Exit	Exits from the OSD main menu.

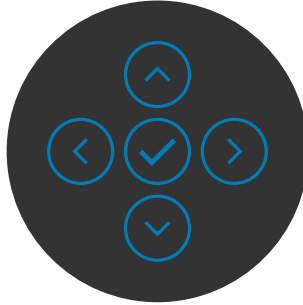

Front-Panel Button



Use the buttons on the front of the monitor to adjust the image settings.







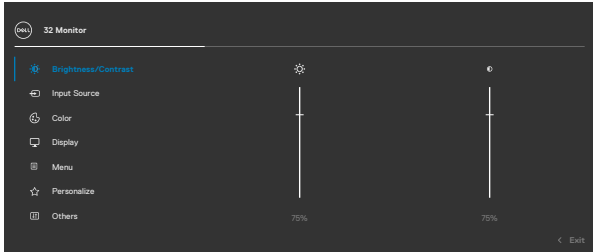



Front Panel Button	Description
1   Up Down	Use the Up (increase) and Down (decrease) buttons to adjust items in the OSD menu.
2  Previous	Use the Previous button to go back to the previous menu.
3  Next	Use the Next button to confirm your selection.
4  Tick	Use the Tick button to confirm your selection.

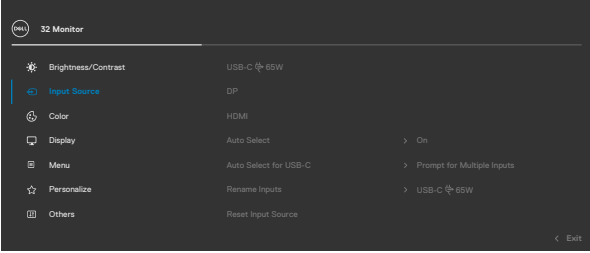

Using the Main Menu

Icon	Menu and Submenus	Description
	Brightness/Contrast	Activates Brightness/Contrast adjustment.
		
		
Brightness		Adjusts the luminance of the backlight (Range: 0 - 100). Move the Joystick Up to increase brightness. Move the Joystick Down to decrease brightness.
Contrast		Adjust the Brightness first, and then adjust Contrast only if further adjustment is necessary. Move the Joystick Up to increase contrast and Move the Joystick Down to decrease contrast (Range: 0 - 100). The Contrast function adjusts the degree of difference between darkness and lightness on the monitor screen.



Icon	Menu and Submenus	Description
	Input Source	Selects between different video inputs that are connected to your monitor.
		
		
USB-C  65W	Select USB-C  65W input when you are using the USB-C  65W connector. Press the Joystick button to confirm the selection.	
DP	Select DP input when you are using the DP (DisplayPort) connector. Press the joystick button to confirm the selection.	
HDMI	Select HDMI input when you are using the HDMI connector. Press the joystick button to confirm the selection.	
Auto Select	Allows you to scan for available input sources. Press  to select this function.	
Auto Select for USB-C	<p>Press  to select these function.</p> <ul style="list-style-type: none"> ◆ Prompt for Multiple Inputs: always show Switch to USB-C Video Input message for user to choose whether to switch or not. ◆ Yes: The monitor always switch to USB-C video without asking while USB-C connected. ◆ No: The monitor will NOT auto switch to USB-C video from another available input. 	
Rename Inputs	Allows you to Rename Inputs .	
Reset Input Source	<p>Resets your monitor's Input Source settings to the factory defaults.</p> <p>Press  to select this function.</p>	



Icon Menu and Submenus

Description



Color

Adjusts the color setting mode.

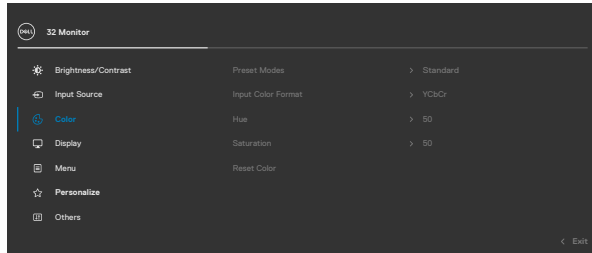

Preset Modes

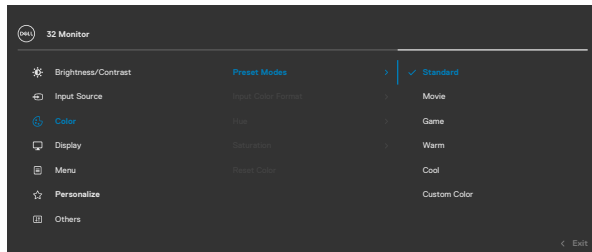

Allows you to choose from a list of preset color mode.







- ♦ **Standard:** Default color settings. This is the default preset mode.
- ♦ **Movie:** Ideal for movies.
- ♦ **Game:** Ideal for most gaming applications.
- ♦ **Warm:** Increases the color temperature. The screen appears warmer with a red/yellow tint.
- ♦ **Cool:** Decreases the color temperature. The screen appears cooler with blue tint.
- ♦ **Custom Color:** Allows you to manually adjust the color settings.

Press the joystick button to confirm the selection.

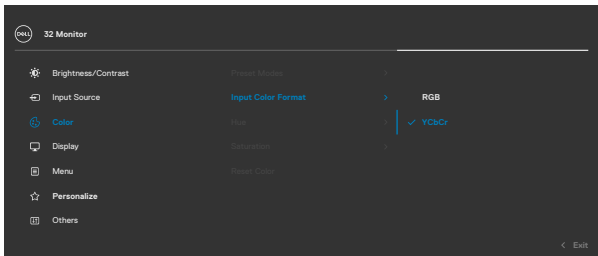

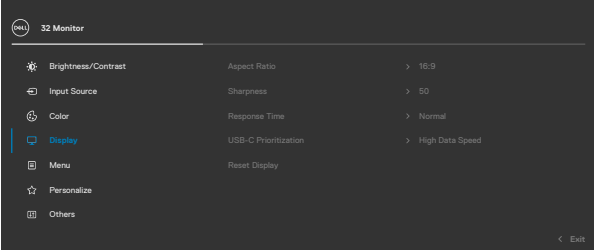

Icon	Menu and Submenus	Description
	Input Color Format	<p>Allows you to set the video input mode to:</p> <ul style="list-style-type: none"> ◆ RGB: Select this option if your monitor is connected to a computer or a media player that supports RGB output. ◆ YCbCr: Select this option if your media player supports only YCbCr output.
	Hue	<p>Use Joystick Up or Down to adjust the Hue from 0 to 100. NOTE: Hue adjustment is available only for Movie and Game mode.</p>
Saturation		<p>Use Joystick Up or Down to adjust the Saturation from 0 to 100. NOTE: Saturation adjustment is available only for Movie and Game mode.</p>
Reset Color		<p>Resets your monitor's color settings to the factory defaults. Press  to select this function.</p>



Icon	Menu and Submenus	Description
	Display	Use the Display menu to adjust image.
		
		
Aspect Ratio	Adjust the image ratio to 16:9, Auto Resize, 4:3, 1:1 .	
Sharpness	Makes the image look sharper or softer. Move the joystick up and down to adjust the sharpness from '0' to '100'.	
Response Time	Allows you to set the Response Time to Normal or Fast .	
USB-C Prioritization	Allows you to specify the priority to transfer the data with high resolution (High Resolution) or high speed (High Data Speed) when using the USB-C port/DP alt mode.	
Reset Display	Resets all settings under the Display menu to the factory defaults. Press  to select this function.	

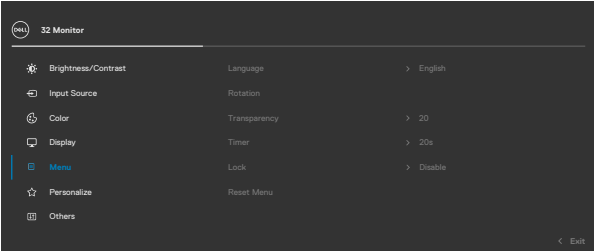

Icon	Menu and Submenus	Description
	Menu	<p>Select this option to adjust the settings of the OSD, such as the languages of the OSD, the amount of time the menu remains on screen, and so on.</p>  
	Language	<p>Set the OSD display to one of eight languages. (English, Spanish, French, German, Brazilian Portuguese, Russian, Simplified Chinese, or Japanese).</p>
	Rotation	<p>Rotates the OSD by 0/90/270 degrees. You can press the Joystick to rotate each time.</p>
	Transparency	<p>Select this option to change the menu transparency by moving the Joystick up or down (Range: 0 - 100).</p>
	Timer	<p>OSD Hold Time: Sets the length of time the OSD remains active after you press a button. Move the joystick to adjust the slider in 1-second increments, from 5 to 60 seconds.</p>



Icon	Menu and Submenus	Description
------	-------------------	-------------

Lock

With the control buttons on the monitor locked, you can prevent people from accessing the controls. It also prevents accidental activation in multiple monitors side-by-side setup.

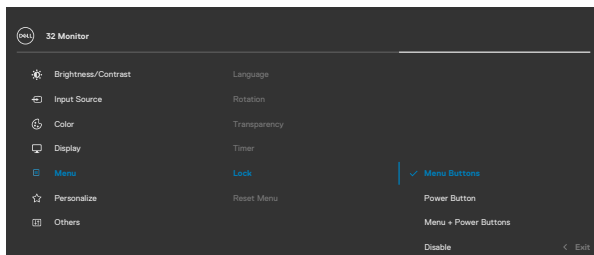





- ◆ **Menu Buttons:** Through OSD to lock the Menu buttons.
- ◆ **Power Button:** Through OSD to lock the Power button.
- ◆ **Menu + Power Buttons:** Through OSD to lock the all of Menu and Power buttons.
- ◆ **Disable:** Move the Joystick left and hold for 4 seconds.

Reset Menu

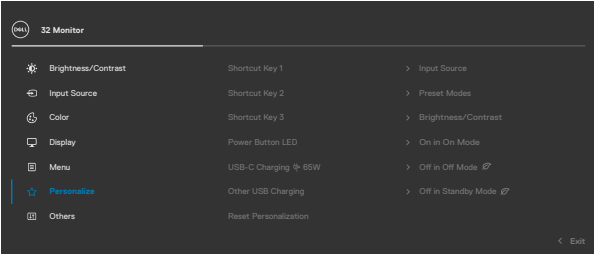
Resets all settings under the **Reset** menu to the factory defaults.
Press  to select this function.



Icon	Menu and Submenus	Description
	Personalize	
		
	Shortcut key 1	Select from Preset Modes, Brightness/Contrast, Input
	Shortcut key 2	Source, Aspect Ratio, Rotation, Display Info set as
	Shortcut key 3	shortcut key.
	Power Button LED	Allows you to set the state of the power light to save energy.
	USB-C Charging 65 W 	Allows you to enable or disable USB-C Charging 65 W charging function during monitor power off mode. NOTE: When this function is enabled, you will be able to charge your notebook or mobile devices through the USB-C cable even when the monitor is powered Off.
	Other USB Charging	Allows you to enable or disable Other USB Charging function during monitor Standby Mode. NOTE: This option was previously called “USB” in older monitor firmware revisions.
	Reset Personalization	Resets all settings under the Personalize menu to the factory preset values. Press  to select this function.



Icon Menu and Submenus

Description



Others

Select this option to adjust the OSD settings such as the **DDC/CI, LCD conditioning**, and so on.

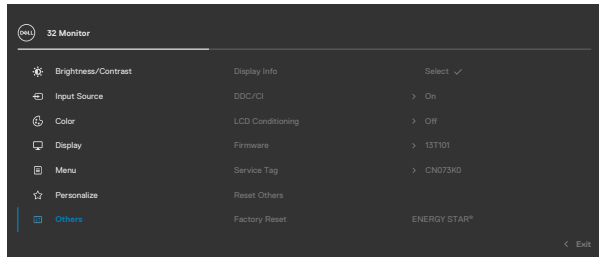

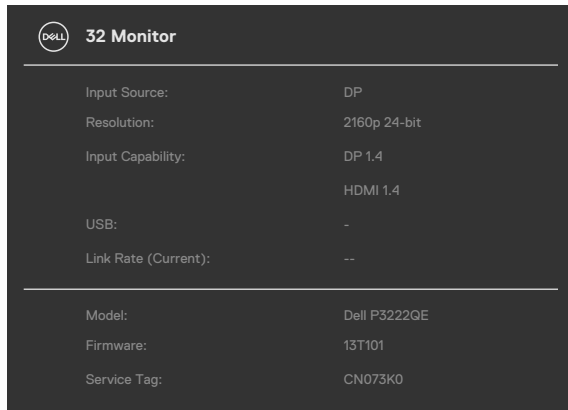

Display Info

Displays the monitor's current settings. Press  to select this function.

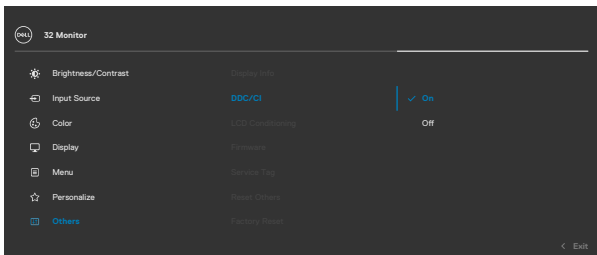

Icon	Menu and Submenus	Description
	DDC/CI	<p>DDC/CI (Display Data Channel/Command Interface) allows your monitor parameters (brightness, color balance, and etc.) to be adjustable via the software on your computer. You can disable this feature by selecting Off. Enable this feature for best user experience and optimum performance of your monitor.</p>

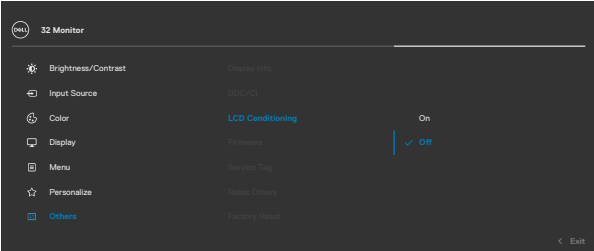

Icon	Menu and Submenus	Description
LCD	Conditioning	Helps reduce minor cases of image retention. Depending on the degree of image retention, the program may take some time to run. You can enable this feature by selecting On .
		
		
	Firmware	Displays the Firmware version of your monitor.
	Service Tag	Displays the Service Tag . The Service Tag is a unique alphanumeric identifier that allows Dell to identify the product specifications and access warranty information. NOTE: The Service Tag is also printed on a label located at the back of the cover.
	Reset Others	Resets all settings under the Others menu to the factory defaults. Press  to select this function.
	Factory Reset	Restores all preset values to the factory default settings.



Using the OSD Lock Function

You can lock the front-panel control buttons to prevent access to the OSD menu and/or power button.

Use the Lock Menu to Lock the Button(s).

1. Select one of the following options.

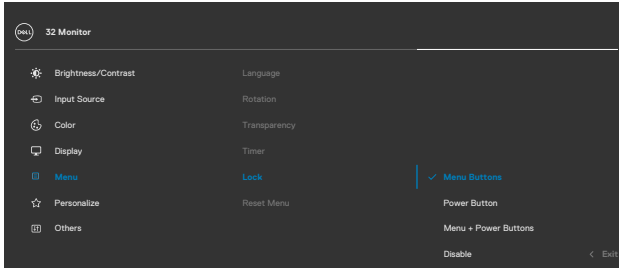

2. The following message appears.

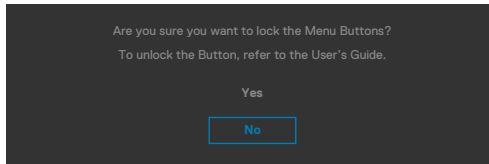

3. Select **Yes** to lock buttons. Once locked, pressing any control button will display the lock icon .





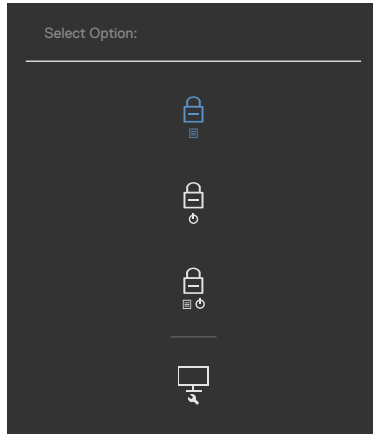

Use the Joystick to Lock the Button(s).

Press the left directional navigation of Joystick for four seconds, a menu appears on the screen.



Select one of the following options:



Options	Description
1  Menu Button lock	Select this option to lock OSD menu function.
2  Power Button lock	Use this option to lock power button. This will prevent the user to turn off the monitor using the power button.
3  Menu and Power Button lock	Use this option to lock OSD menu and power button to turn off the monitor.
4  Built-in Diagnostics	Use this option to run the built-in diagnostics, see Built-in Diagnostics .

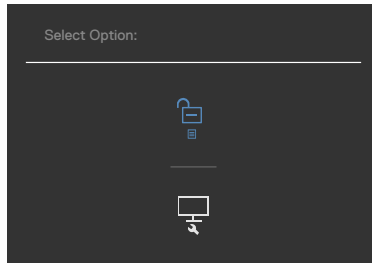

To Unlock the Button(s).

Press the left directional navigation of Joystick for four seconds until a menu appears on the screen. The following table describes the options to unlock the front-panel control buttons.



Options	Description
1  Menu Button unlock	Use this option to unlock OSD menu function.
2  Power Button unlock	Use this option to unlock power button to turn off the monitor.
3  Menu and Power Button unlock	Use this option to unlock OSD menu and power button to turn off the monitor.



Initial Setup

When you select OSD items of **Factory Reset** in Other feature, the following message will appear:

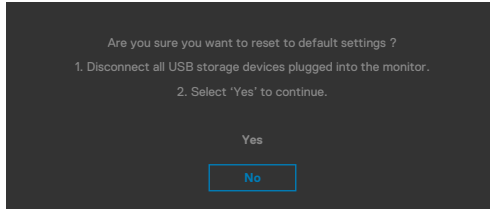

When you select '**Yes**' to reset to default settings, the following message will appear:

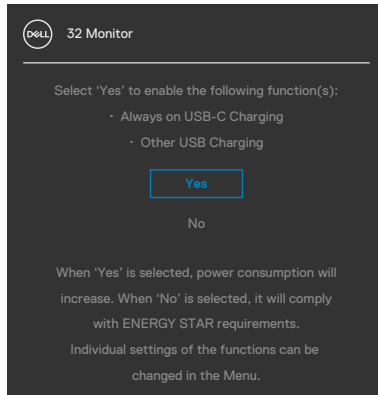

OSD Warning Messages

When the monitor does not support a particular resolution mode, you can see the following message:

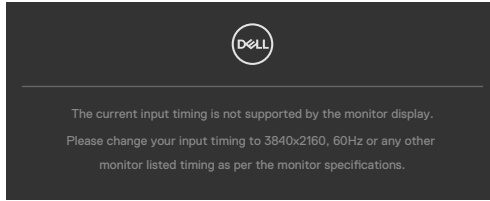

This means that the monitor cannot synchronize with the signal that it is receiving from the computer. See [Resolution specifications](#) for the Horizontal and Vertical frequency ranges addressable by this monitor. Recommended mode is **3840 x 2160**. You can see the following message before the DDC/CI function is disabled:

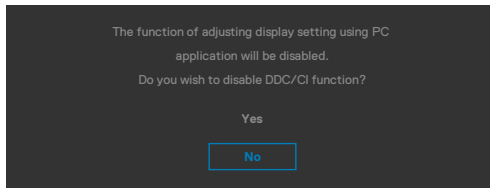

When the monitor enters the **Standby Mode**, the following message will appear:

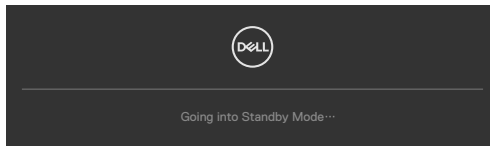

Activate the computer and wake up the monitor to gain access to the **OSD**.

If you press any button other than the power button, the following messages will appear depending on the selected input:

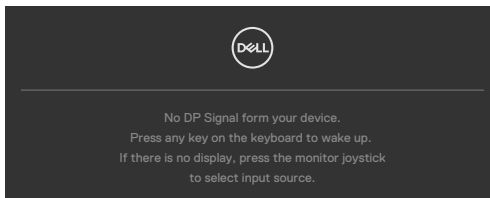

A message is displayed while the cable supporting DP alternate mode is connected to the monitor under the following conditions:

- When **Auto Select for USB-C** is set to **Prompt for Multiple Inputs**.
- When the DP cable is connected to the monitor.

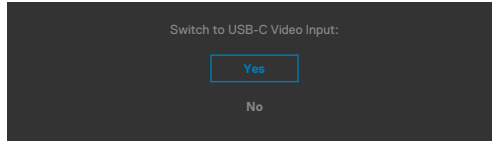

If the monitor connect with two ports or more, when the **Auto** of Input Source is selected, it will turn to the next port with signal.

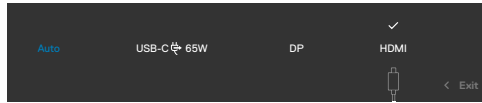

Select OSD items of **Off in Standby Mode** *℘* in Personalize feature, the following message will appear:

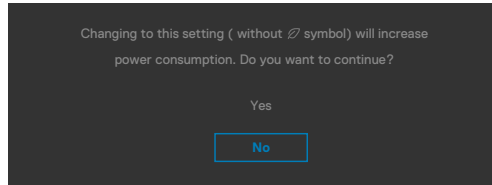

If adjust the Brightness level above the default level over 75%, the following message will appear:

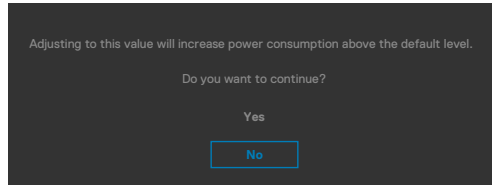

- When user selects "Yes", the power message is displayed only once.
- When user select 'No', the power warning message will pop-up again.
- The power warning message will appear again only when the user does a Factory Reset from the OSD menu.



If either HDMI, DP or USB-C input is selected and the corresponding cable is not connected, a floating dialog box as shown below appears.

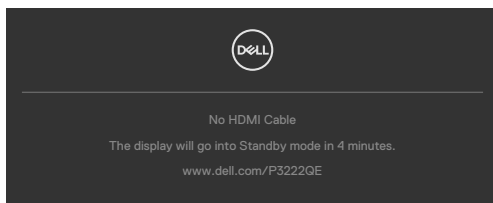

or

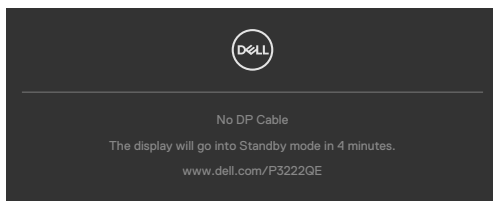

or

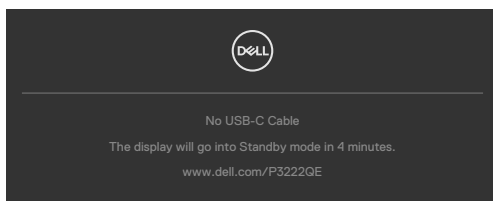

See [Troubleshooting](#) for more information.



Setting the Maximum Resolution

To set the maximum resolution for the monitor:

In Windows 7, Windows 8 or Windows 8.1:

1. For Windows 8 or Windows 8.1 only, select the Desktop tile to switch to classic desktop. For Windows Vista and Windows 7, skip this step.
2. Right-click on the desktop and click **Screen Resolution**.
3. Click the Dropdown list of the **Screen Resolution** and select **3840 x 2160**.
4. Click **OK**.

In Windows 10:

1. Right-click on the desktop and click **Display Settings**.
2. Click **Advanced display settings**.
3. Click the dropdown list of Resolution and select **3840 x 2160**.
4. Click **Apply**.

If you do not see **3840 x 2160** as an option, you may need to update your graphics driver. Depending on your computer, complete one of the following procedures:

If you have a Dell desktop or portable computer:

- Go to <https://www.dell.com/support> enter your service tag, and download the latest driver for your graphics card.

If you are using a non-Dell computer (laptop or desktop):

- Go to your computer manufacturer's support website and download the latest graphic drivers.
- Go to your graphics card manufacturer's website and download the latest graphic drivers.



Troubleshooting

⚠ WARNING: Before you begin any of the procedures in this section, follow the **Safety Instructions**.

Self-Test

Your monitor provides a self-test feature that allows you to check whether your monitor is functioning properly. If your monitor and computer are properly connected but the monitor screen remains dark, run the monitor self-test by performing the following steps:

1. Turn off both your computer and the monitor.
2. Unplug the video cable from the back of the computer. To ensure proper Self-Test operation, remove all digital and the analog cables from the back of computer.
3. Turn on the monitor.

The floating dialog box should appear on-screen (against a black background), if the monitor cannot sense a video signal and is working correctly. While in self-test mode, the power LED remains white. Also, depending upon the selected input, one of the dialogs shown below will continuously scroll through the screen.

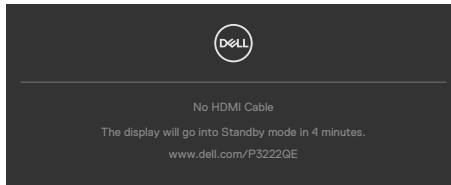

or

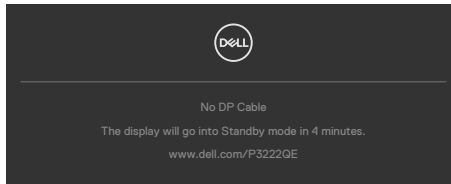

or

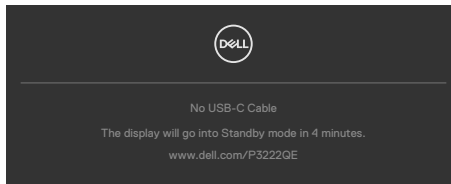

4. This box also appears during normal system operation if the video cable becomes disconnected or damaged.
5. Turn off your monitor and reconnect the video cable; then turn on both your computer and the monitor.

If your monitor screen remains blank after you use the previous procedure, check your video controller and computer, because your monitor is functioning properly.

Built-in Diagnostics

Your monitor has a built-in diagnostic tool that helps you determine if the screen abnormality you are experiencing is an inherent problem with your monitor, or with your computer and video card.

NOTE: You can run the built-in diagnostics only when the video cable is unplugged and the monitor is in self-test mode.

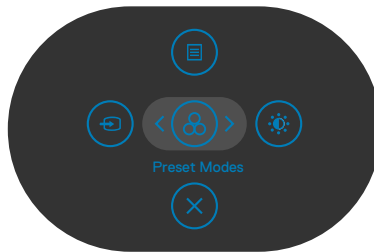

To run the built-in diagnostics:

1. Ensure that the screen is clean (no dust particles on the surface of the screen).
2. Press the left directional navigation of Joystick for four seconds until a menu appears on the screen.
3. Using the joystick control, highlight the Diagnostics  option and press the joystick button to start the diagnostics. A gray screen is displayed.
4. Observe if the screen has any defects or abnormalities.
5. Toggle the joystick once again until a red screen is displayed.
6. Observe if the screen has any defects or abnormalities.
7. Repeat steps 5 and 6 until the screen displays green, blue, black, and white colors. Note any abnormalities or defects.

The test is complete when the text screen appears. To exit, toggle the joystick control again.

If you do not detect any screen abnormalities upon using the built-in diagnostic tool, the monitor is functioning properly. Check the video card and computer.



Common Problems

The following table contains general information about common monitor problems you might encounter and the possible solutions:

Common Symptoms	What You Experience	Possible Solutions
No Video/ Power LED off	No picture	<ul style="list-style-type: none">· Ensure that the video cable connecting the monitor and the computer is properly connected and secure.· Verify that the power outlet is functioning properly using any other electrical equipment.· Ensure that the power button is depressed fully.· Ensure that the correct input source is selected in the Input Source menu.
No Video/ Power LED on	No picture or no brightness	<ul style="list-style-type: none">· Increase brightness and contrast controls via OSD.· Perform monitor self-test feature check.· Check for bent or broken pins in the video cable connector.· Run the built-in diagnostics.· Ensure that the correct input source is selected in the Input Source menu.
Missing Pixels	LCD screen has spots	<ul style="list-style-type: none">· Cycle power on-off.· Pixel that is permanently off is a natural defect that can occur in LCD technology.· For more information on Dell Monitor Quality and Pixel Policy, see Dell Support site at: https://www.dell.com/support/monitors
Stuck-on Pixels	LCD screen has bright spots	<ul style="list-style-type: none">· Cycle power on-off.· Pixel that is permanently off is a natural defect that can occur in LCD technology.· For more information on Dell Monitor Quality and Pixel Policy, see Dell Support site at: https://www.dell.com/support/monitors
Brightness Problems	Picture too dim or too bright	<ul style="list-style-type: none">· Reset the monitor to factory settings.· Adjust brightness and contrast controls via OSD.
Safety Related Issues	Visible signs of smoke or sparks	<ul style="list-style-type: none">· Do not perform any troubleshooting steps.· Contact Dell immediately.



Common Symptoms	What You Experience	Possible Solutions
Intermittent Problems	Monitor malfunctions on & off	<ul style="list-style-type: none"> · Ensure that the video cable connecting the monitor to the computer is connected properly and is secure. · Reset the monitor to factory settings. · Perform monitor self-test feature check to determine if the intermittent problem occurs in self-test mode.
Missing Color	Picture missing color	<ul style="list-style-type: none"> · Perform monitor self-test. · Ensure that the video cable connecting the monitor to the computer is connected properly and is secure. · Check for bent or broken pins in the video cable connector.
Wrong Color	Picture color not good	<ul style="list-style-type: none"> · Try different Preset Modes in Color settings OSD. · Adjust R/G/B value under Custom Color in Color menu OSD. · Change the Input Color Format to RGB or YCbCr in the Color settings OSD. · Run the built-in diagnostics.
Image retention from a static image left on the monitor for a long period of time	Faint shadow from the static image displayed appears on the screen	<ul style="list-style-type: none"> · Set the screen to turn off after a few minutes of screen idle time. These can be adjusted in Windows Power Options or Mac Energy Saver setting. · Alternatively, use a dynamically changing screensaver.



Product Specific Problems

Problem	What you experience	Possible solutions
Screen image is too small	Image is centered on screen, but does not fill entire viewing area	<ul style="list-style-type: none">• Check the Aspect Ratio setting in the Display menu OSD.• Reset the monitor to factory settings.
Cannot adjust the monitor with the buttons on the front panel	OSD does not appear on the screen	<ul style="list-style-type: none">• Turn off the monitor, unplug the monitor power cable, plug it back, and then turn on the monitor.
No Input Signal when user controls are pressed	No picture, the LED light is white	<ul style="list-style-type: none">• Check the signal source. Ensure the computer is not in the power saving mode by moving the mouse or pressing any key on the keyboard.• Check whether the signal cable is plugged in properly. Connect the signal cable again, if necessary.• Reset the computer or video player.
The picture does not fill the entire screen	The picture cannot fill the height or width of the screen	<ul style="list-style-type: none">• Due to different video formats (aspect ratio) of DVDs, the monitor may display in full screen.• Run the built-in diagnostics.
No image when using USB-C connection to computer, laptop, and so on	Black screen	<ul style="list-style-type: none">• Verify if the USB-C interface of the device can support DP alternate mode.• Verify if the device required more than 65 W power charging.• USB-C interface of device cannot support DP alternate mode.• Set Windows to Projection mode.• Ensure that the USB-C cable is not damaged.



Problem	What you experience	Possible solutions
No charging when using USB-C connection to computer, laptop, and so on	No charging	<ul style="list-style-type: none"> · Verify if the device can support one of 5 V/9 V/15 V/20 V charging profiles. · Verify if the Notebook requires a >65 W power adaptor. · If the Notebook requires a >65 W power adaptor, it may not charge with the USB-C connection. · Ensure that you use only Dell approved adapter or the adapter that comes with the product. · Ensure that the USB-C cable is not damaged.
Intermittent charging when using USB-C connection to computer, laptop, and so on	Intermittent charging	<ul style="list-style-type: none"> · Check if the maximum power consumption of device is over 65 W. · Ensure that you use only Dell approved adapter or the adapter that comes with the product. · Ensure that the USB-C cable is not damaged.
Refresh rate drop to 30 Hz or color bits drop to 6 bits	Refresh rate drop or color bits drop	<ul style="list-style-type: none"> · The monitor is 2 Lane default for USB-C, it need to switch the USB-C prioritization to high resolution for full performance image for DP 1.2 platform.
No network connection	Network dropped or intermittent	<ul style="list-style-type: none"> · Do not toggle Off/On the power button when network is connected, keeps the power button On.



Problem	What you experience	Possible solutions
The LAN port is not functioning	OS setting or cable connection issue	<ul style="list-style-type: none">· Ensure that the latest BIOS and drivers for your computer are installed on your computer.· Ensure that the RealTek Gigabit Ethernet Controller is installed in the Windows Device Manager.· If your BIOS Setup has a LAN/GBE Enabled/ Disabled option, make sure it is set to Enabled.· Ensure that the Ethernet cable is connected securely on the monitor and the hub/router/firewall.· Check the status LED of the Ethernet cable to confirm connectivity. Re-connect both ends of the Ethernet cable if the LED is not lit.· First power off the Computer and unplug the Type-C cable and power cord of the monitor. Then, power on the computer, plug in the monitor power cord the Type-C cable.



Universal Serial Bus (USB) Specific Problems

Specific Symptoms	What You Experience	Possible Solutions
USB interface is not working	USB peripherals are not working	<ul style="list-style-type: none">· Check that your display is turned ON.· Reconnect the upstream cable to your computer.· Reconnect the USB peripherals (downstream connector).· Turn off the monitor and turn it on again.· Reboot the computer.· Certain USB devices such as portable hard drives require higher power source; connect the drive to the computer directly.
Super speed USB 5Gbps (USB 3.2 Gen1) interface is slow.	USB 3.2 Gen1 peripherals working slowly or not working at all	<ul style="list-style-type: none">· Check that your computer is USB 3.2 Gen1-capable.· Some computers have USB 3.2 Gen1, USB 2.0, and USB 1.1 ports. Ensure that the correct USB port is used.· Reconnect the upstream cable to your computer.· Reconnect the USB peripherals (downstream connector).· Reboot the computer.
Wireless USB peripherals stop working when a USB 3.2 Gen1 device is plugged in	Wireless USB peripherals responding slowly or only working as the distance between itself and its receiver decreases	<ul style="list-style-type: none">· Increase the distance between the USB 3.2 Gen1 peripherals and the wireless USB receiver.· Position your wireless USB receiver as close as possible to the wireless USB peripherals.· Use a USB-extender cable to position the wireless USB receiver as far away as possible from the USB 3.2 Gen1 port.
USB is not working	No USB functionalities	Refer to input source and USB pairing table.



Appendix

FCC Notices (U.S. Only) and Other Regulatory Information

For FCC notices and other regulatory information, see the regulatory compliance website located at https://www.dell.com/regulatory_compliance

Contacting Dell

For customers in the United States, call 800-WWW-DELL (800-999-3355).

EU Product Database for Energy Label and Product Information Sheet

P3222QE: <https://eprel.ec.europa.eu/qr/557066>

 **NOTE: If you do not have an active Internet connection, you can find contact information on your purchase invoice, packing slip, bill, or Dell product catalog.**

Dell provides several online and telephone-based support and service options. Availability varies by country and product, and some services may not be available in your area.

To get online Monitor support content:

See <https://www.dell.com/support/monitors>

To contact Dell for sales, technical support, or customer service issues:

1. Go to <https://www.dell.com/support>
2. Verify your country or region in the Choose A Country/Region drop-down menu at the bottom-right corner of the page.
3. Click Contact Us next to the country dropdown.
4. Select the appropriate service or support link based on your need.
5. Choose the method of contacting Dell that is convenient for you.

