

Simplified Service Manual

LCD Monitor

E2420HS

Service Manual Versions and Revision

No.	Version	Release Date	Revision
1	1.0	2020/03/20	Initial Release
2	2.0	2021/03/15	ErP lot 5 additional requirements

1.	IMPORTANT SAFETY NOTICE	4
2.	EXPLODED VIEW DIAGRAM WITH LIST OF ITEMS	4
3.	WIRING CONNECTIVITY DIAGRAM	5
4.	LIST OF TOOLS / EQUIPMENT	5
5.	DISASSEMBLY AND ASSEMBLY PROCEDURES	6
6.	TROUBLE SHOOTING INSTRUCTIONS	8

Simplified Service Manual

1. Important Safety notice

Connecting your monitor

⚠ WARNING: Before you begin any of the procedures in this section, follow the [Safety Instructions](#).

✎ NOTE: Do not connect all cables to the computer at the same time. It is recommended to route the cables through the cable-management slot before you connect them to the monitor.

✎ NOTE: Dell monitors are designed to work optimally with Dell supplied inbox cables. Dell does not guarantee the video quality and performance when using non-Dell cables.

To connect your monitor to the computer:

1. Turn off your computer and disconnect the power cable.
2. Connect DP or HDMI or VGA cable from your monitor to the computer.

2. Exploded view diagram with list of items

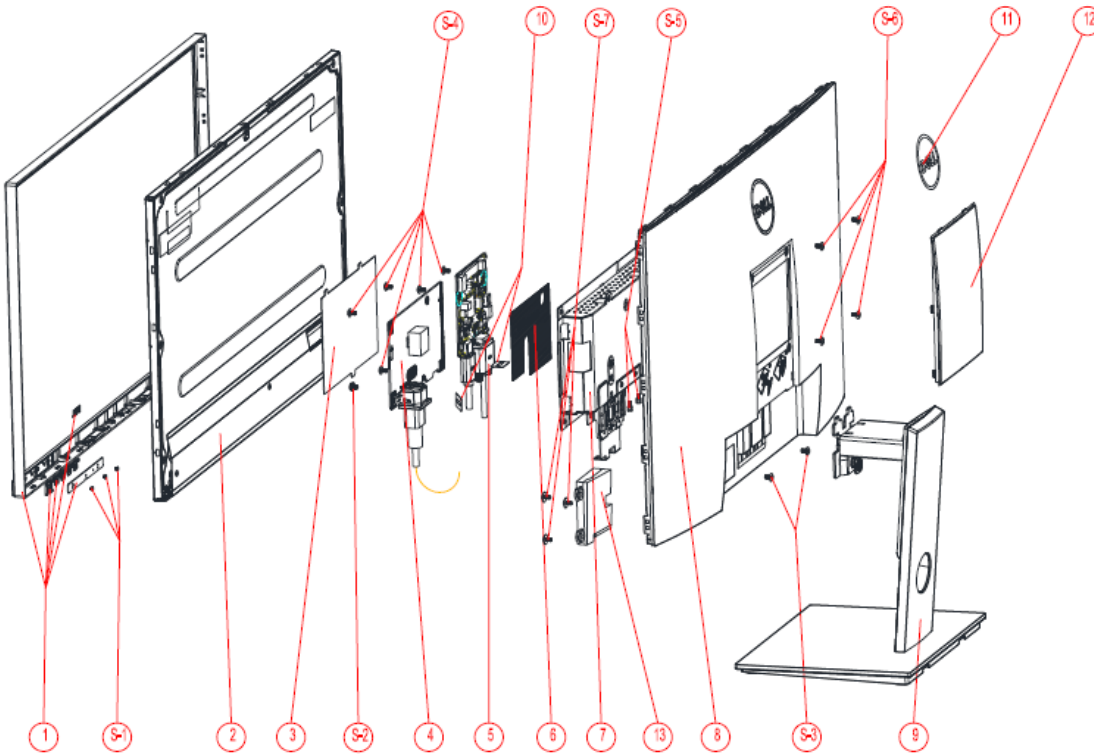

3. Wiring connectivity diagram

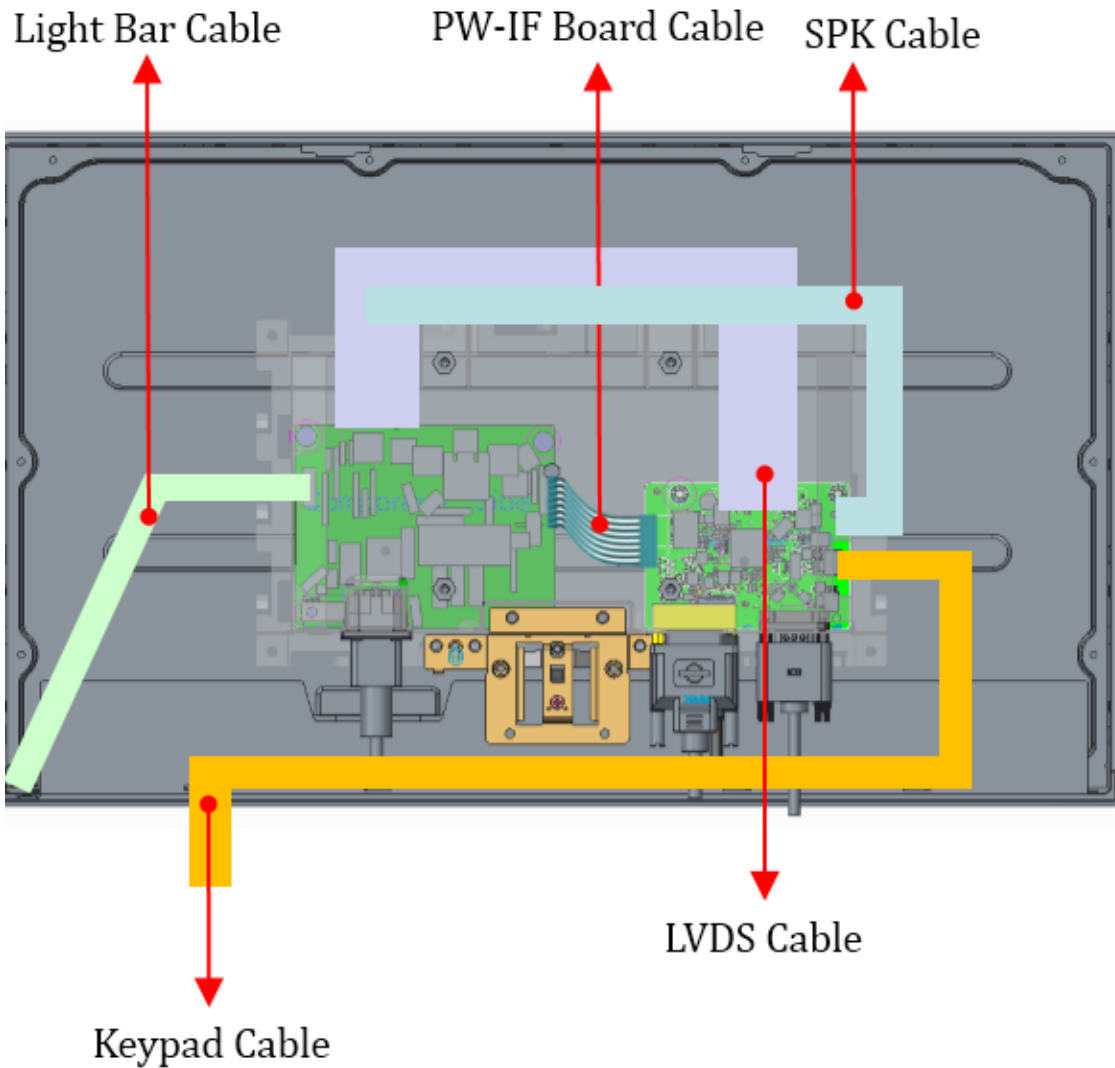

4. List of tools / equipment

1. Philips-head screwdriver
2. Hex-head screwdriver

5. Disassembly and Assembly Procedures

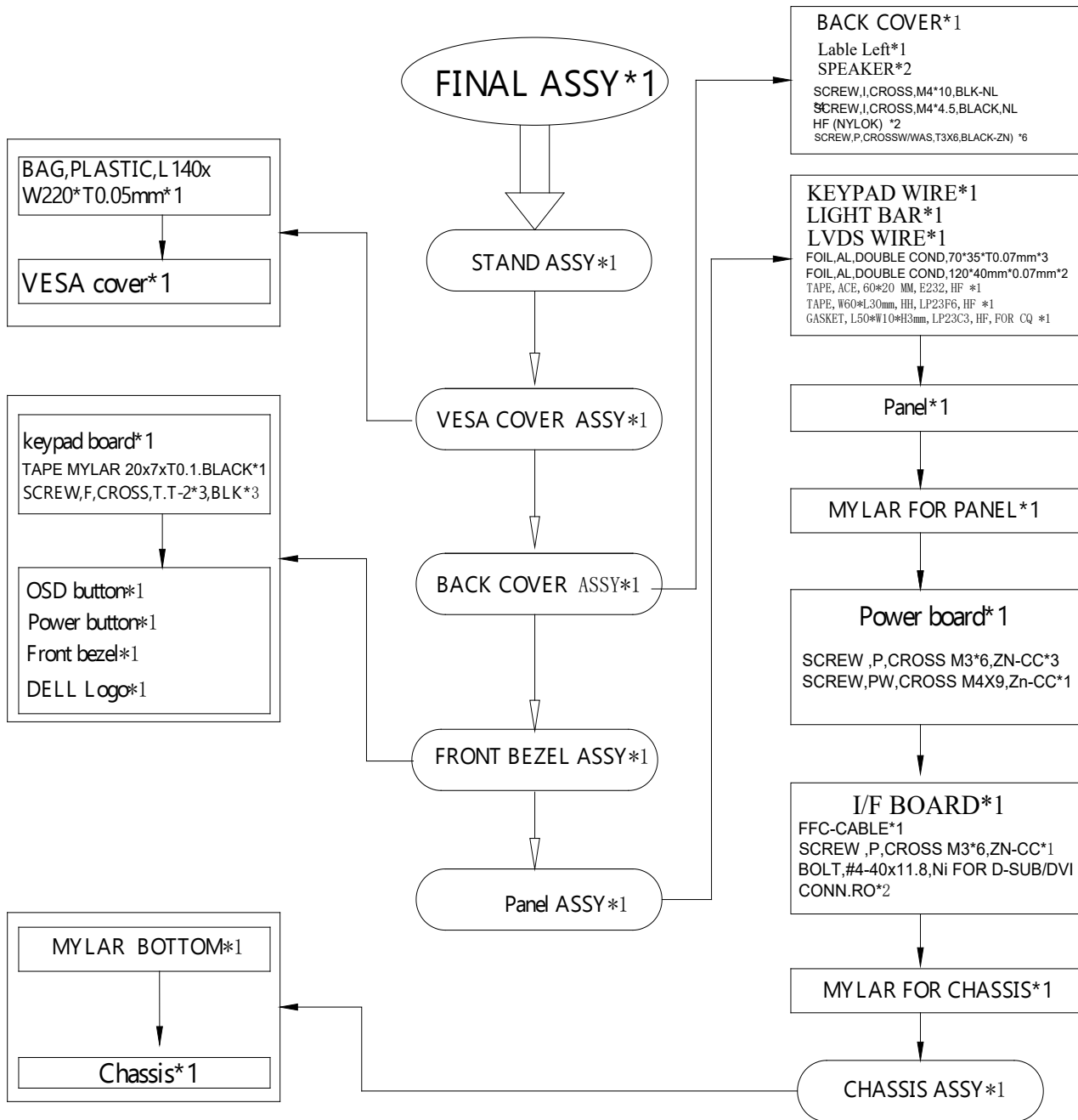

Note: 1. The arrows point out the direction of disassembly.
Disassemble the slot of Back cover from monitor

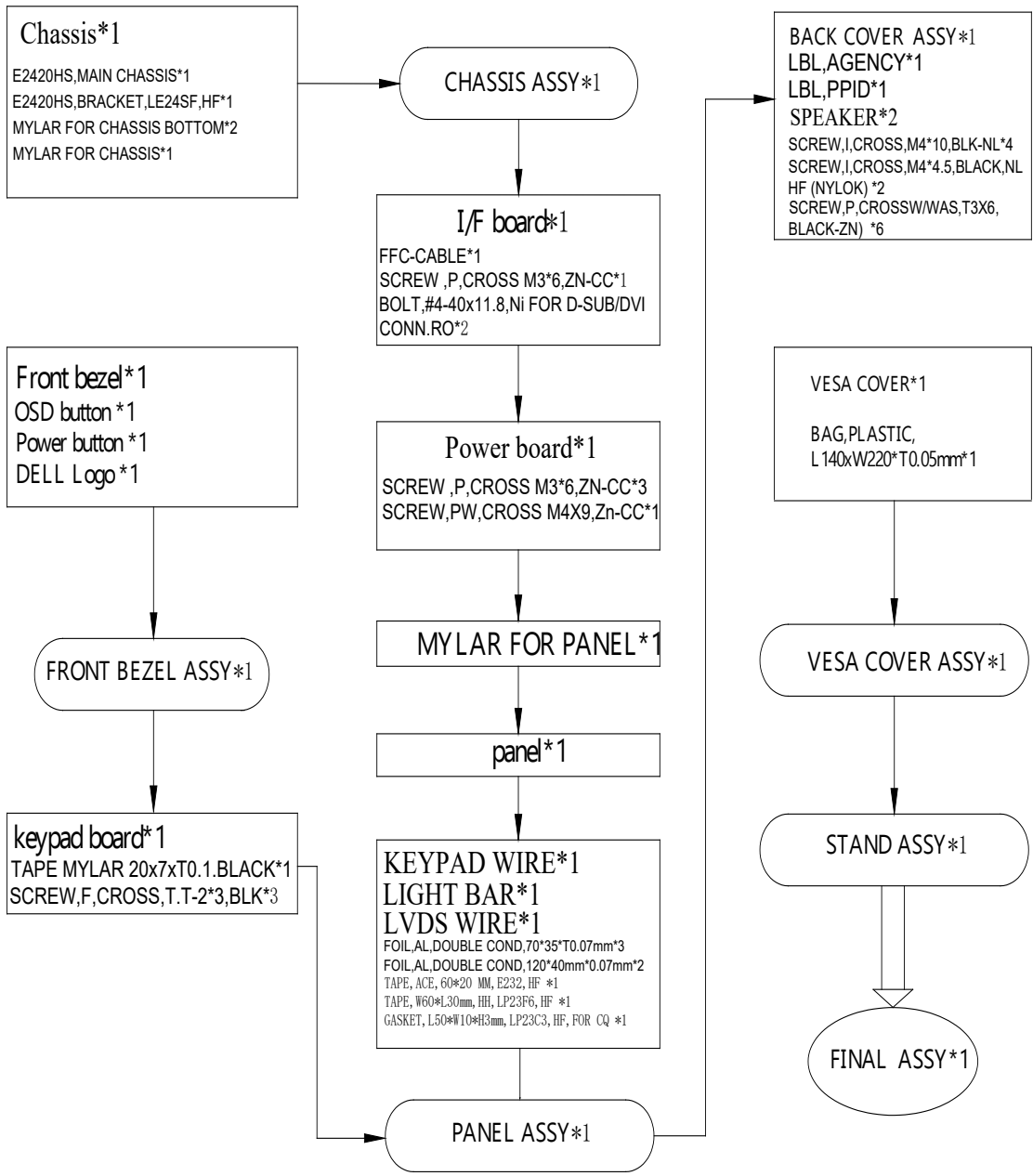

6. Trouble shooting instructions

Troubleshooting

⚠ WARNING: Before you begin any of the procedures in this section, follow the [Safety Instructions](#).

Self-test

Your monitor provides a self-test feature that allows you to check if your monitor is functioning properly. If your monitor and computer are properly connected but the monitor screen remains dark, run the monitor self-test by performing the following steps:

1. Turn off both your computer and the monitor.
2. Disconnect all video cables from the monitor. This way, the computer doesn't have to be involved.
3. Turn on the monitor.

If the monitor is working correctly, it detects that there is no signal and one of the following message appears. While in self-test mode, the power LED remains white.

E1920H

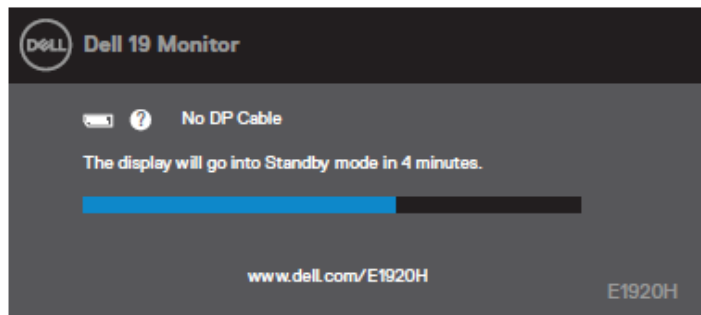

E2020H

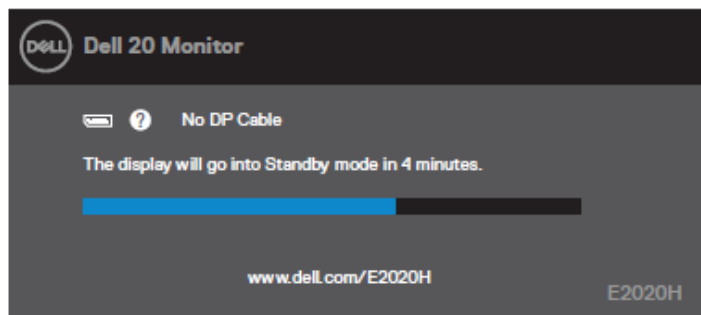

E2220H

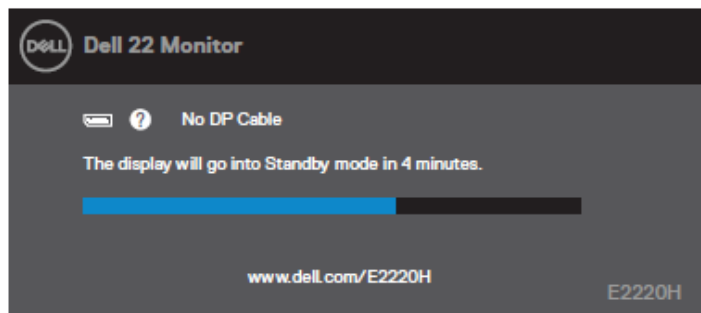

E2420H

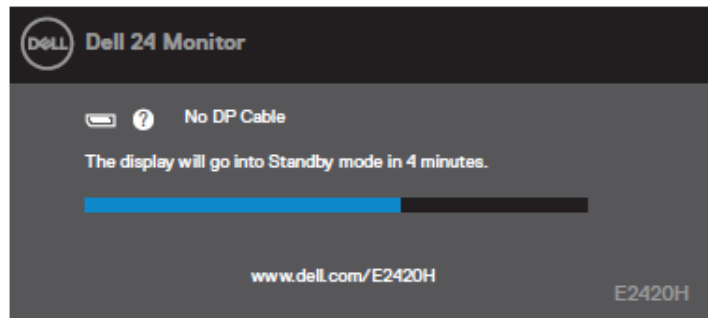

E2420HS

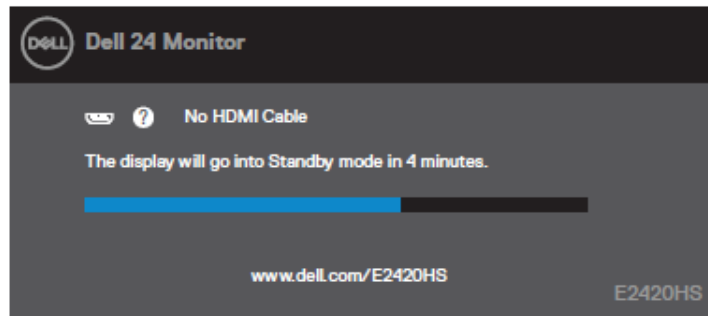

E2720H

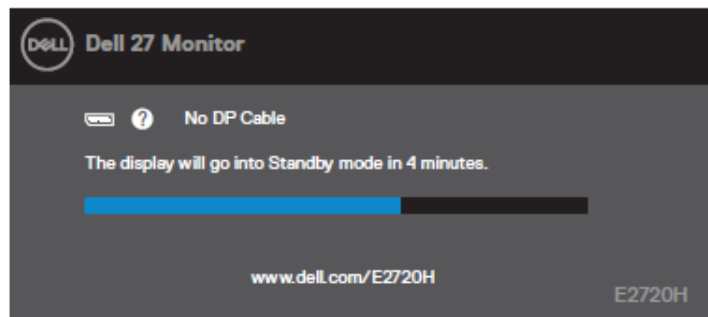

E2720HS

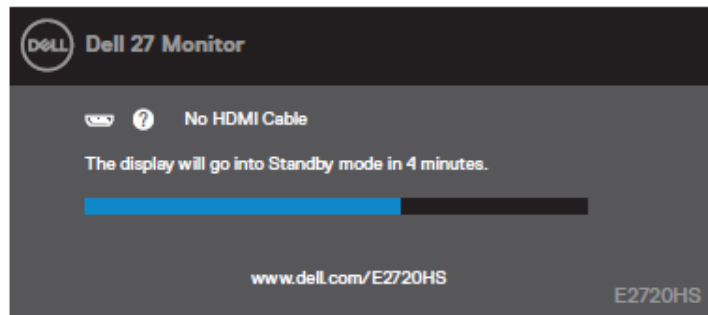

NOTE: This box also appears during normal operation, when the video cable is disconnected or damaged.

4. Turn off your monitor and reconnect the video cable; then turn on your computer and the monitor.

If your monitor remains dark after you reconnect the cables, check your video controller and computer.

Built-in diagnostics

Your monitor has a built-in diagnostic tool that helps you determine if any screen abnormality you experience is an inherent problem with your monitor, or with your computer and video card.

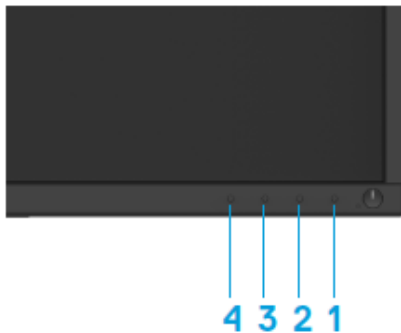

Label	Description
1	Button 1
2	Button 2
3	Button 3
4	Button 4

To run the built-in diagnostics:

1. Ensure that the screen is clean (no dust particles on the surface of the screen).
2. Press and Hold button 1 for about 4 seconds and wait for a pop up menu.
3. Press button 3 or 4 to select the diagnostic tool and confirm with button 2.
A gray test pattern appears at the beginning of the diagnostic program.
4. Carefully inspect the screen for abnormalities.
5. Press button 4 to change the test patterns.
6. Repeat steps 4 and 5 to inspect red, green, blue, black, white and text screens.
7. Press button 4 to end the diagnostic program.

Common problems

The following table contains general information about common monitor problems you might encounter and the possible solutions:

Common Symptoms	Possible Solutions
No Video/Power LED off	<ul style="list-style-type: none"> • Ensure that the video cable connecting the monitor and the computer is properly connected and secure. • Verify that the power outlet is functioning properly using any other electrical equipment. • Ensure that the power button is pressed. • Ensure that the correct input source is selected via the Input Source menu.
No Video/Power LED on	<ul style="list-style-type: none"> • Increase brightness and contrast controls using the OSD. • Perform monitor self-test feature check. • Check for bent or broken pins in the video cable connector. • Run the built-in diagnostics. • Ensure that the correct input source is selected via the Input Source menu.
Poor focus	<ul style="list-style-type: none"> • Eliminate video extension cables. • Reset the monitor to Factory Settings (Factory Reset). • Change the video resolution to the correct aspect ratio.
Shaky/Jittery video	<ul style="list-style-type: none"> • Reset the monitor to Factory Settings (Factory Reset). • Check environmental factors. • Relocate the monitor and test in another room.
Missing pixels	<ul style="list-style-type: none"> • Cycle power On-off. • Pixel that is permanently off is a natural defect that can occur in LCD technology. • For more information on Dell Monitor Quality and Pixel Policy, see Dell Support site at: www.dell.com/support/monitors.
Stuck-on pixels	<ul style="list-style-type: none"> • Cycle power On-off. • Pixel that is permanently off is a natural defect that can occur in LCD technology. • For more information on Dell Monitor Quality and Pixel Policy, see Dell Support site at: www.dell.com/support/monitors.
Brightness problems	<ul style="list-style-type: none"> • Reset the monitor to Factory Settings (Factory Reset). • Adjust brightness & contrast controls via OSD.
Geometric distortion	<ul style="list-style-type: none"> • Reset the monitor to Factory Settings (Factory Reset). • Adjust brightness & contrast controls via OSD.
Horizontal/Vertical lines	<ul style="list-style-type: none"> • Reset the monitor to Factory Settings (Factory Reset). • Perform monitor self-test feature check and determine if these lines are also in self-test mode. • Check for bent or broken pins in the video cable connector. • Run the built-in diagnostics.

Synchronization problems	<ul style="list-style-type: none"> • Reset the monitor to Factory Settings (Factory Reset). • Perform monitor self-test feature check to determine if the scrambled screen appears in self-test mode. • Check for bent or broken pins in the video cable connector. • Restart the computer in safe mode.
Safety related issues	<ul style="list-style-type: none"> • Do not perform any troubleshooting step. • Contact Dell immediately.
Intermittent problems	<ul style="list-style-type: none"> • Try different Preset Modes in Color settings OSD. Adjust R/G/B value in Custom Color in Color settings OSD. • Change the Input Color Format to RGB or YPbPr in the Color settings OSD. • Run the built-in diagnostics.
Image retention from a static image left on the monitor for a long period of time	<ul style="list-style-type: none"> • Set the screen to turn off after a few minutes of screen idle time. These can be adjusted in Windows Power Options or Mac Energy Saver setting. • Alternatively, use a dynamically changing screensaver.
Video ghosting or overshooting	<ul style="list-style-type: none"> • Change the Response Time in the Display OSD to Fast or Normal depending on your application and usage.

Product-specific problems

Specific Symptoms	Possible Solutions
Screen image is too small	<ul style="list-style-type: none"> • Check the Aspect Ratio setting in the Display settings OSD. • Reset the monitor to Factory Settings (Factory Reset).
Cannot adjust the monitor with the buttons on the bottom of the panel	<ul style="list-style-type: none"> • Turn off the monitor, unplug the power cord, plug it back, and then turn on the monitor.
No input signal when user controls are pressed	<ul style="list-style-type: none"> • Check the signal source. Ensure the computer is not in standby or sleep mode by moving the mouse or pressing any key on the keyboard. • Check if the video cable is plugged in properly. Disconnect and reconnect the video cable if necessary. • Reset the computer or video player.
The picture does not fill the entire screen	<ul style="list-style-type: none"> • Due to different video formats (aspect ratio) of DVDs, the monitor may display in full screen. • Run the built-in diagnostics.