

Dell C2422HE
Dell C2722DE
Dell C3422WE Curved
Video Conferencing Monitor
User's Guide

Model: C2422HE/C2722DE/C3422WE
Regulatory model: C2422HEt/C2722DEt/C3422WEt





NOTE: A NOTE indicates important information that helps you make better use of your computer.



CAUTION: A CAUTION indicates potential damage to hardware or loss of data if instructions are not followed.



WARNING: A WARNING indicates a potential for property damage, personal injury, or death.

Copyright © 2020 - 2021 Dell Inc. or its subsidiaries. All rights reserved. Dell, EMC, and other trademarks are trademarks of Dell Inc. or its subsidiaries. Other trademarks may be trademarks of their respective owners.

Reproduction of these materials in any manner whatsoever without the written permission of Dell Inc. is strictly forbidden.

Trademarks used in this text: Dell and the DELL logo are trademarks of Dell Inc.; Microsoft and Windows are either trademarks or registered trademarks of Microsoft Corporation in the United States and/or other countries. ENERGY STAR is a registered trademark of the U.S. Environmental Protection Agency. As an ENERGY STAR partner, Dell Inc. has determined that this product meets the ENERGY STAR guidelines for energy efficiency.

Other trademarks and trade names may be used in this document to refer to either the entities claiming the marks and names or their products. Dell Inc. disclaims any proprietary interest in trademarks and trade names other than its own.

Contents

Safety instructions	6
About your monitor	7
Package contents	7
Product features	8
Identifying parts and controls	10
Front view	10
Back view	12
Bottom view	13
Monitor specifications	14
Resolution specifications	17
Preset display modes	18
DP Multi-Stream Transport (MST) Modes	21
USB-C Multi-Stream Transport (MST) Modes	21
Unified Communications (UC) Platform Compatibility List	22
Electrical specifications	23
Webcam – microphone specifications	24
Speaker Specifications	24
Physical characteristics	24
Environmental characteristics	26
Pin assignments	27
Plug-and-Play	34
LCD monitor quality and pixel policy	34
Ergonomics	35
Handling and moving your display	37
Maintenance guidelines	38
Cleaning your monitor	38
Setting up the monitor	39
Connecting the stand	39
Using the tilt, swivel, and vertical extension	42



Tilt, swivel and vertical extension42
Rotating the Display (C2422HE/C2722DE only)	43
Configuring the display settings on your computer after rotation (C2422HE/C2722DE only)	44
Operating the monitor webcam	45
Connecting your monitor	46
Dell Power Button Sync (DPBS)	50
Connecting the monitor for DPBS for the first time52
Using DPBS function53
Connecting the monitor for USB-C Multi-Stream Transport (MST) function (C2422HE/C2722DE only) in DPBS mode55
Connecting the monitor for USB-C in DPBS mode56
Organizing your cables	58
Securing your monitor using Kensington lock (optional)	58
Removing the monitor stand	59
Wall mounting (Optional)	60
Operating the monitor	61
Power on the monitor	61
Using the joystick control	61
Using the rear-panel controls	62
Using the OSD lock function	63
Front-panel button66
Using the On-Screen Display (OSD) Menu	67
Accessing the menu system67
OSD warning messages82
Setting the maximum resolution.87
Setting the KVM USB Switch88
Setting the Auto KVM91
Setting up Windows Hello	93
Setting up the monitor webcam as default setting.	97
Setting up the monitor speaker as default setting	101



Troubleshooting 104
 Self-test 104
 Built-in diagnostics 105
 Common Problems. 106
 Product specific problems 108
 Microsoft® Teams® / Skype for Business® specific problems . 116
 Universal Serial Bus (USB) specific problems 118

Appendix. 119
 FCC notices (U.S. only) and other regulatory information . . . 119
 Contacting Dell 119
 EU product database for energy label and product information
 sheet 119



Safety instructions

⚠ WARNING: Use of controls, adjustments, or procedures other than those specified in this documentation may result in exposure to shock, electrical hazards, and/or mechanical hazards.

- Place the monitor on a solid surface and handle it carefully. The screen is fragile and can be damaged if dropped or hit sharply.
- Always be sure that your monitor is electrically rated to operate with the AC power available in your location.
- Keep the monitor in room temperature. Excessive cold or hot conditions can have an adverse effect on the liquid crystal of the display.
- Do not subject the monitor to severe vibration or high impact conditions. For example, do not place the monitor inside a car trunk.
- Unplug the monitor when it is going to be left unused for an extended period of time.
- To avoid electric shock, do not attempt to remove any cover or touch the inside of the monitor.

For information on safety instructions, see the Safety, Environmental, and Regulatory Information (SERI).



About your monitor



Package contents

Your monitor ships with the components shown in the table below. If any component is missing, contact Dell. For more information, see [Contact Dell](#).

 **NOTE: Some components may be optional and may not ship with your monitor. Some features may not be available in certain countries.**

	Display
	Stand riser
	Stand base
	Power cable (varies by country)
	DisplayPort cable (DisplayPort to DisplayPort)



	USB 3.2 Gen1 Type-A to Type-B upstream cable
	USB Type-C cable (C to C)
	<ul style="list-style-type: none"> • Quick Setup Guide • Safety, Environmental, and Regulatory Information

Product features

The **Dell C2422HE/C2722DE/C3422WE** monitor has an active matrix, Thin-Film Transistor (TFT), Liquid Crystal Display (LCD), and LED backlight. The monitor features include:

- **C2422HE:** 60.47 cm (23.8 in.) active area display (Measured diagonally) 1920 x 1080 (16:9) resolution, plus full-screen support for lower resolutions.
- **C2722DE:** 68.47 cm (27.0 in.) active area display (Measured diagonally) 2560 x 1440 (16:9) resolution, plus full-screen support for lower resolutions.
- **C3422WE:** 86.71 cm (34.14 in.) active area display (Measured diagonally) 3440 x 1440 (21:9) resolution, plus full-screen support for lower resolutions.
- Wide viewing angles with 99% sRGB color.
- **C2422HE/C2722DE:** Tilt, swivel, pivot and vertical extension adjustment capabilities.
- **C3422WE:** Tilt, swivel and vertical extension adjustment capabilities.
- Built-in speakers (2 x 5 W).
- Removable pedestal stand and Video Electronics Standards Association (VESA™) 100 mm mounting holes for flexible mounting solutions.
- Ultra-thin bezel minimizes the bezel gap during multi-monitor usage, enabling easier set up with an elegant viewing experience.
- Extensive digital connectivity with DP helps future-proof your monitor.
- Single USB Type-C to supply power to compatible notebook while receiving video signal.
- USB-C and RJ45 ports enable a single-cable, network-connected experience.
- Plug and play capability if supported by your computer.
- On-Screen Display (OSD) adjustments for ease of set-up and screen optimization.



- Power and OSD buttons lock.
 - Security lock slot.
 - **C2422HE/C2722DE:** ≤ 0.3 W in Standby Mode.
 - **C3422WE:** ≤ 0.5 W in Standby Mode.
 - Supports Picture by Picture (PBP) Select mode on C3422WE.
 - Allow user to switch USB KVM function in PBP mode on C3422WE.
 - The monitor is designed with Dell Power Button Sync (DPBS) feature to control PC system power state from monitor power button.*
 - Premium Panel Exchange for peace of mind.
 - Optimize eye comfort with a flicker-free screen minimizes hazard blue light emission.
 - The monitor use Low Blue Light panel and compliance with TUV Rheinland (Hardware Solution) at factory reset/default setting model.
 - Decreases the level of hazard blue light emitted from the screen to make viewing more comfortable for your eyes.
 - The monitor adopts Flicker-Free technology, which clears the eye visible flicker , brings comfort viewing experience and preventing users suffer from eye strain and fatigue.
 - Certified for Microsoft Teams®.
 - Certified for Windows Hello® (Face Authentication) and supports Microsoft Cortana®.
- * PC system that supports DPBS is the Dell OptiPlex 7090/3090 Ultra platform.

⚠ WARNING: The possible long-term effects of blue light emission from the monitor may cause damage to the eyes, including eye fatigue or digital eye strain.



Identifying parts and controls

Front view

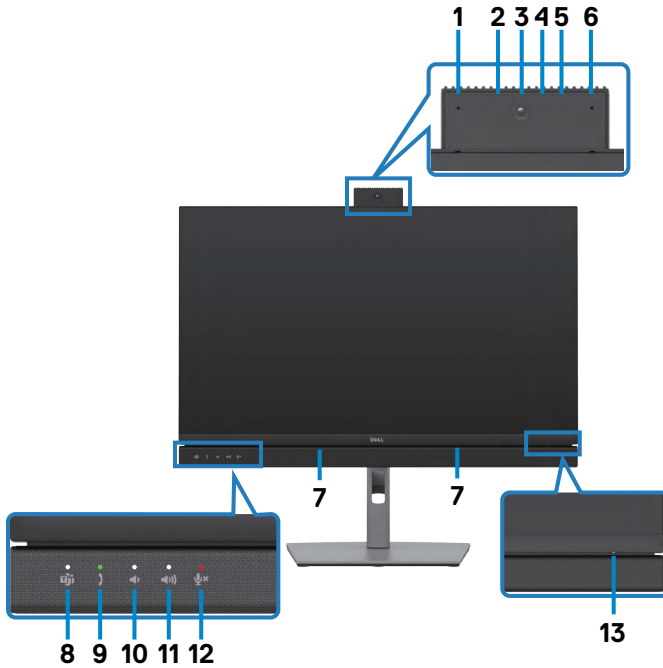

Label	Description	Use
1,6	Microphones	Monitor microphones (Mic). Mic is enabled when the webcam & Mic module is popped up. Mic is disabled when the module is retracted.
3	Webcam lens	Transmits your image in a video conference. Webcam is enabled when the webcam & mic module is popped up. Webcam is disabled when the module is retracted.
2,4	IR LED	Indicator of infrared (IR).
5	Webcam LED indicator	Indicator of Webcam. It will light up in white when webcam is in use.
7	Built-in speakers	To output the sound from audio input.



8	Teams button & LED	<p>LED will light in static white when Microsoft Teams® is signed in and running.</p> <p>LED will blink when there is a Teams notification.</p> <p>Short press on the button to bring up Teams and open notification. Ensure that the Teams application is signed in and is already running at the background.</p> <p>NOTE: For the Teams button to work, ensure that the Teams account is provisioned / setup as 'Teams Only' mode. The tenant administrator should enable the account to 'Teams Only' mode.</p> <p>NOTE: Teams button will only work with Teams application in 'Teams Only' mode. Setting might vary in corporate environment, resulting in Teams button not working on the monitor. Please check with your system administrator.</p>
9	Hookswitch & LED	<p>LED will blink in green when there is an incoming Teams/Skype for Business (SfB) call.</p> <p>LED will light up in static green during Teams/Skype for Business (SfB) call.</p> <p>Short press to answer / end call.</p> <p>Long press to reject incoming call.</p>
10	Volume down & LED	<p>Short press for 2 unit volume decrement.</p> <p>Long press for continuous volume decrement.</p>
11	Volume up & LED	<p>Short press for 2 unit volume increment.</p> <p>Long press for continuous volume increment.</p>
12	Microphone mute & LED	<p>Press to mute and unmute microphone.</p> <p>LED will light up in static red when mic is muted or when the webcam & mic module is retracted.</p> <p>LED will go dark when mic is enabled/unmuted.</p>
13	Power LED indicator	<p>Solid white light indicates the monitor is turned on and functioning normally. Breathing white light indicates the monitor is in Standby Mode.</p>



Back view



Label	Description	Use
1	VESA mounting holes (100 mm x 100 mm-behind attached VESA cover)	Wall mount monitor using VESA-compatible wall mount kit (100 mm x 100 mm).
2	Regulatory label	Lists the regulatory approvals.
3	Stand release button	Releases stand from the monitor.
4	Power On/Off button	To turn the monitor on or off.
5	Joystick	Use it to control the OSD menu. For more information, see Operating the Monitor .
6	Mac address, Barcode, serial number, and Service Tag label	Refer to this label if you need to contact Dell for technical support. The Service Tag is a unique alphanumeric identifier that enables Dell service technicians to identify the hardware components in your computer and access warranty information.
7	Cable-management slot	Use to organize cables by inserting them through the slot.



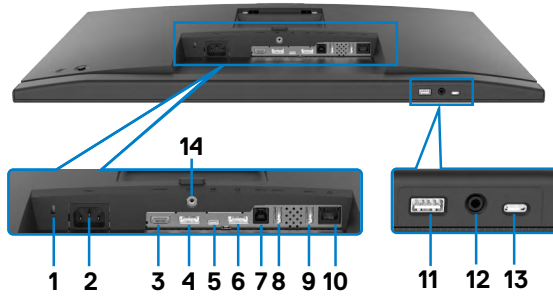

Bottom view



Label	Description	Use
1	Security lock slot	Secures monitor with security cable lock (sold separately).
2	Power connector	Connect the power cable.
3	HDMI port	Connect your computer with the HDMI cable.
4	DisplayPort in	Connect your computer with the DisplayPort cable.
5	USB Type-C upstream/ DisplayPort	<p>Connect to your computer using the USB Type-C cable. The USB Type-C port offer the fastest transfer rate (USB 3.2 Gen 1) and the alternate mode with DP 1.2 (C2422HE/ C3422WE) / DP 1.4 (C2722DE) support the following, and PD 20 V/4.5 A, 15 V/3 A, 9 V/3 A, 5 V/3 A.</p> <ul style="list-style-type: none"> · C2422HE maximum resolution of 1920 x 1080 at 60 Hz · C2722DE maximum resolution of 2560 x 1440 at 60 Hz · C3422WE maximum resolution of 3440 x 1440 at 60 Hz <p>NOTE: USB Type-C is not supported on Windows versions that are prior to Windows 10.</p>
6	DP port (out) 	<p>DP output for MST (multi-stream transport) capable monitor. To enable MST, refer to instruction on section “Connecting the Monitor for DP MST Function”.</p> <p>NOTE: Remove the rubber plug when using DP out connector.</p> <p>NOTE: The port is only for C2422HE/C2722DE.</p>
7	USB-B upstream port	Connect the USB cable that comes with your monitor to the computer. Once this cable is connected, you can use the USB downstream connectors on the monitor.



8,9,11	super speed USB 5 Gbps (USB 3.2 Gen1) (3)	Connect your USB device. You can use these ports only after you have connected the USB cable (Type-A to Type-B or Type-C to Type-C) from the computer to the monitor. Port with  battery icon supports Battery Charging Rev. 1.2.
10	RJ-45 connector	Connect Internet. You can surf Internet via RJ45 only after you have connected the USB cable (Type-A to Type-B or Type-C to Type-C) from the computer to the monitor.
12	Headphone jack	Connect headphones or headset to playback audio through HDMI or DisplayPort or USB Type-C audio channels. NOTE: Excessive sound pressure from earphones or headphones can cause hearing damage or loss. Adjustment of the equalizer to maximum increases the earphones and headphones output voltage and therefore the sound pressure level.
13	USB Type-C downstream port	Port with  icon supports 5 V/3 A. Connect your USB device. You can use these ports only after you have connected the USB cable (Type-A to Type-B or Type-C to Type-C) from the computer to the monitor.
14	Stand lock	Lock the stand to the monitor using a M3 x 6 mm screw (screw not included).

Monitor specifications

Model	C2422HE	C2722DE	C3422WE
Screen type	Active matrix - TFT LCD		
Panel Type	In-plane switching Technology		
Aspect ratio	16:9	16:9	21:9
Viewable image dimensions			
Diagonal	60.47 cm (23.8 in.)	68.47 cm (27 in.)	86.71 cm (34.14 in.)
Active Area			
Horizontal	527.04 mm (20.75 in.)	596.74 mm (23.49 in.)	799.8 mm (31.49 in.)
Vertical	296.46 mm (11.67 in.)	335.66 mm (13.22 in.)	334.80 mm (13.18 in.)



Area	156246.28 mm ² (242.18 in. ²)	200301.75 mm ² (310.47 in. ²)	267773.04 mm ² (415.05 in. ²)
Pixel pitch	0.2745(H) mm x 0.2745 (V) mm	0.2331 (H) mm x 0.2331 (V) mm	0.2325(H) mm x 0.2325(V) mm
Pixel per inch (PPI)	92.56	108.79	109.68
Viewing angle			
Horizontal	178° (typical)		
Vertical	178° (typical)		
Brightness	250 cd/m ² (typical)	350 cd/m ² (typical)	300 cd/m ² (typical)
Contrast ratio	1000 to 1 (typical)		
Curvature (Only for C3422WE)	NA	NA	3800R (typical)
Display screen coating	Anti-glare treatment of the front polarizer (3H) hard coating		
Backlight	LED		
Response Time (Gray to Gray)	5 ms (Fast mode) 8 ms (Normal mode)	5 ms (Fast mode) 8 ms (Normal mode)	5 ms (Fast mode) 8 ms (Normal mode)
Color depth	16.78 million colors	16.78 million colors	1.07 billion colors ¹
Color gamut ²	99% sRGB		



Connectivity	<ul style="list-style-type: none"> • 1 x DP 1.2 (HDCP1.4) • 1 x HDMI1.4 (HDCP1.4) 	<ul style="list-style-type: none"> • 1 x DP 1.4 (HDCP1.4) • 1 x HDMI1.4 (HDCP1.4) 	<ul style="list-style-type: none"> • 1 x DP 1.2 (HDCP2.2) • 1 x HDMI2.0 (HDCP2.2)
	<ul style="list-style-type: none"> • 1 x USB Type-B (USB 3.2 Gen 1 upstream port) • 1 x USB Type-C (Alternate mode with DisplayPort 1.4/1.2, USB 3.2 Gen 1 upstream port, Power Delivery PD up to 90 W) • 1 x USB Type-C downstream (15 W), USB 3.2 Gen 1 (5 Gbps) • 1 x DP (Out) with MST (only for C2422HE/C2722DE) • 2 x super speed USB 5 Gbps (USB 3.2 Gen 1) • 1 x super speed USB 5 Gbps (USB 3.2 Gen 1) with BC 1.2 charging capability at 2 A (max) • 1 x 3.5 mm headphone jack • 1 x RJ45 		
Border width (edge of monitor to active area)			
Top	5.80 mm	7.80 mm	8.03 mm
Left/Right	5.80 mm	7.80 mm	8.03 mm
Bottom	50.89 mm	51.97 mm	56.60 mm
Adjustability			
Height adjustable stand	140 mm	120 mm	120 mm
Tilt	-5° to 21°	-5° to 21°	-5° to 21°
Swivel	-45° to 45°	-45° to 45°	-30° to 30°
Pivot	-90° to 90°	-90° to 90°	NA
Slant adjust	NA	NA	-4° to 4°
Cable management	Yes		
Dell Display Manager (DDM) Compatibility	Easy Arrange and other key features		
Security	Security lock slot (cable lock sold separately)		

¹ Video output from DP/HDMI port at maximum resolution 3440x1440 at 60Hz is 1.07 billion colors. Video output from USB-C port at maximum resolution 3440x1440 at 60Hz is 16.78 million colors.

² At panel native only, under Custom Mode preset.



Resolution specifications

Model	C2422HE	C2722DE	C3422WE
Horizontal scan range	30 kHz to 83 kHz	30 kHz to 90 kHz	30 kHz to 90 kHz
Vertical scan range	56 Hz to 76 Hz		
Maximum preset resolution	1920 x 1080 at 60 Hz	2560 x 1440 at 60 Hz	3440 x 1440 at 60 Hz
Video display capabilities (HDMI & DP & USB Type-C alternate mode)	480i, 480p, 576i, 560p, 720p, 1080i, 1080p		



Preset display modes

C2422HE

Display mode	Horizontal frequency (kHz)	Vertical frequency (Hz)	Pixel clock (MHz)	Sync polarity (Horizontal/Vertical)
VESA, 720 x 400	31.47	70	28.32	-/+
VESA, 640 x 480	31.47	60	25.17	-/-
VESA, 640 x 480	37.50	75	31.5	-/-
VESA, 800 x 600	37.88	60	40	+/+
VESA, 800 x 600	46.88	75	49.5	+/+
VESA, 1024 x 768	48.36	60	65	-/-
VESA, 1024 x 768	60.02	75	78.75	+/+
VESA, 1152 x 864	67.50	75	108	+/+
VESA, 1280 x 1024	64.0	60	108	+/+
VESA, 1280 x 1024	80.0	75	135	+/+
VESA, 1600 x 900	55.99	60	118.25	+/+
VESA, 1920 x 1080	67.50	60	148.50	+/+



C2722DE

Display Mode	Horizontal Frequency (kHz)	Vertical Frequency (Hz)	Pixel Clock (MHz)	Sync Polarity (Horizontal/Vertical)
VESA, 720 x 400	31.50	70.0	28.30	-/+
VESA, 640 x 480	31.50	60.0	25.20	-/-
VESA, 640 x 480	37.50	75.0	31.50	-/-
VESA, 800 x 600	37.90	60.30	40.0	+/+
VESA, 800 x 600	46.90	75.0	49.50	+/+
VESA, 1024 x 768	48.40	60.0	65.0	-/-
VESA, 1024 x 768	60.0	75.0	78.80	+/+
VESA, 1152 x 864	67.50	75.0	108.0	+/+
VESA, 1280 x 1024	64.0	60.0	108.0	+/+
VESA, 1280 x 1024	80.0	75.0	135.0	+/+
VESA, 1600 x 1200	75.0	60.0	162.0	+/+
VESA, 1920 x 1080	67.50	60.0	148.5	+/+
VESA, 2048 x 1080	58.23	26.37	23.99	+/-
VESA, 2048 x 1080	66.58	60.0	147.16	+/-
VESA, 2560 x 1440	88.80	60.0	241.50	+/-



C3422WE

Display Mode	Horizontal Frequency (kHz)	Vertical Frequency (Hz)	Pixel Clock (MHz)	Sync Polarity (Horizontal/Vertical)
VESA, 720 x 400	31.50	70.0	28.30	-/+
VESA, 640 x 480	31.50	60.0	25.20	-/-
VESA, 640 x 480	37.50	75.0	31.50	-/-
VESA, 800 x 600	37.90	60.30	40.0	+/+
VESA, 800 x 600	46.90	75.0	49.50	+/+
VESA, 1024 x 768	48.40	60.0	65.0	-/-
VESA, 1024 x 768	60.0	75.0	78.80	+/+
VESA, 1152 x 864	67.50	75.0	108.0	+/+
VESA, 1280 x 1024	64.0	60.0	108.0	+/+
VESA, 1280 x 1024	80.0	75.0	135.0	+/+
VESA, 1600 x 1200	75.0	60.0	162.0	+/+
VESA, 1920 x 1080	67.50	60.0	148.50	+/+
VESA, 2048 x 1080	66.58	60.0	147.16	+/-
VESA, 2560 x 1440	88.80	60.0	241.50	+/-
CVT, 3440 x 1440	88.81	60.0	319.75	+/-



DP Multi-Stream Transport (MST) Modes

C2422HE

MST Source Monitor	Maximum number of external monitors that can be supported
	1920 x 1080 at 60 Hz
1920 x 1080 at 60 Hz	3

NOTE: Maximum external monitor resolution supported is 1920 x 1080 at 60 Hz only.

C2722DE

MST Source Monitor	Maximum number of external monitors that can be supported
	2560 x 1440 at 60 Hz
2560 x 1440 at 60 Hz	1

NOTE: Maximum external monitor resolution supported is 2560 x 1440 at 60 Hz only.

NOTE: DP output for MST is supported on C2422HE and C2722DE only.

USB-C Multi-Stream Transport (MST) Modes

C2422HE

MST Source Monitor	Maximum number of external monitors that can be supported
	1920 x 1080 at 60 Hz
1920 x 1080 at 60 Hz	1

C2722DE

OSD Display Info: Link rate(current)	Maximum number of external monitors that can be supported
	2560 x 1440 at 60 Hz
HBR3(DP 1.4)	1
HBR2(DP 1.2)	0

NOTE: If Dell C2722DE MST needs to reach QHD resolution and maintain USB gen1 bandwidth(when OSD Display setting is high data speed) , then it needs to be replaced with a USB 3.2 Gen2 cable (1M) and the PC's type-C port supports HBR3.



Unified Communications (UC) Platform Compatibility List

The table below highlights the call functions that work on the Dell Video Conferencing Monitor – C2422HE, C2722DE and C3422WE when using the following UC platforms#.

Call Functions	Bring up Microsoft Teams	Answer call	End call	Reject call	Adjust Speaker volume down	Adjust Speaker volume up	Mute/ Unmute Microphone
Button	Teams	Hookswitch	Hookswitch	Hookswitch	Volume Down	Volume Up	Mute
Microsoft Teams	√	√	√	√	√	√	√
Skype for Business	×	√	√	√	√	√	√
Zoom	×	×	×	×	√	√	√*
Google Hangouts	×	×	×	×	√	√	√*
BlueJeans	×	×	×	×	√	√	√*
Cisco Webex	×	×	×	×	√	√	√*
FaceTime	×	×	×	×	√	√	√*
Slack	×	×	×	×	√	√	√*
GoToMeeting	×	×	×	×	√	√	√*

√ Call function on the Dell C2422HE/C2722DE/C3422WE works with the UC platform

×

Call function on the Dell C2422HE/C2722DE/C3422WE does not work with the UC platform

* Mute function on the Dell C2422HE/C2722DE/C3422WE works by pressing the Mute button, but the Mute Icon on the UC platform is not sync (Icon shows unmute).

On Windows 10 64 Bit OS



Electrical specifications

Model	C2422HE	C2722DE	C3422WE
Video input signals	<ul style="list-style-type: none"> Digital video signal for each differential line Per differential line at 100 ohm impedance DP/HDMI/USB Type-C signal input support 		
Input voltage/frequency/current	100-240 VAC / 50 or 60 Hz \pm 3 Hz / 2.3 A (maximum)	100-240 VAC / 50 or 60 Hz \pm 3 Hz / 2.5 A (maximum)	100-240 VAC / 50 or 60 Hz \pm 3 Hz / 2.8 A (maximum)
Inrush current	120 V: 42 A (Max.) 240 V: 80 A (Max.)		
Power Consumption	0.2 W (Off Mode) ¹ 0.2 W (Standby Mode) ¹ 18 W (On Mode) ¹ 195 W (Max) ² 13.81 W (P _{on}) ³ 48.60 kWh (TEC) ³	0.2 W (Off Mode) ¹ 0.3 W (Standby Mode) ¹ 26.50 W (On Mode) ¹ 210 W (Max) ² 19.45 W (P _{on}) ³ 64.64 kWh (TEC) ³	0.3 W (Off Mode) ¹ 0.4 W (Standby Mode) ¹ 32.50 W (On Mode) ¹ 220 W (Max) ² 27.70 W (P _{on}) ³ 89.08 kWh (TEC) ³

¹As defined in EU 2019/2021 and EU 2019/2013.

²Max brightness and contrast setting with maximum power loading on all USB ports.

³P_{on}: Power consumption of On Mode as defined in Energy Star 8.0 version.

TEC: Total energy consumption in kWh as defined in Energy star 8.0 version.

This document is informational only and reflects laboratory performance. Your product may perform differently, depending on the software, components and peripherals you ordered and shall have no obligation to update such information. Accordingly, the customer should not rely upon this information in making decisions about electrical tolerances or otherwise. No warranty as to accuracy or completeness is expressed or implied.

 **NOTE:** This monitor is ENERGY STAR certified.



This product qualifies for ENERGY STAR in the factory default settings which can be restored by “Factory Reset” function in the OSD menu. Changing the factory default settings or enabling other features may increase power consumption that could exceed the ENERGY STAR specified limit.



Webcam – microphone specifications

Lens	Field of view (horizontal)	75.4° for 2560 x 1920
	Focus mode	Fixed Focus
	Focus area	35 cm~1.5 m
	Focusing distance (normal mode)	70 cm
Image Sensor	Active array size	5 mega-pixel
Video Specification	Video frame rate	1920 x 1080 (Full HD)- up to 30 frames per second
Audio Specification	Microphone type	Digital microphone x 2
Interface	USB 2.0 High Speed	
Power Supply	3.3 volts +/- 5% for USB and Microphone 5 volts +/- 5% for IR camera	

Speaker Specifications

Model	C2422HE	C2722DE	C3422WE
Speaker rated power	2 x 5 W		
Frequency Response	200 Hz - 16 kHz		
Impedance	8 ohm		

Physical characteristics

Model	C2422HE	C2722DE	C3422WE
Connector type	<ul style="list-style-type: none"> • DP connector (DP in and DP out on C2422HE/C2722DE. Only DP in on C3422WE) • HDMI connector • USB Type-C connector • Audio jack • RJ45 connector • USB upstream connector x 2 • USB 3.2 Gen 1 downstream connector x 3 • USB Type-C downstream connector 		
Signal cable type	DP to DP 1.8 M cable USB 3.2 Gen 1 Type-A to B 1.8 M cable USB 3.2 Gen 1 Type-C to C 1.8 M cable		



Dimensions (with stand)			
Height (extended)	544.08 mm (21.40 in.)	565.57 mm (22.30 in.)	576.20 mm (22.68 in.)
Height (compressed)	404.08 mm (15.90 in.)	445.57 mm (17.54 in.)	456.20 mm (17.96 in.)
Width	538.64 mm (21.21 in.)	612.34 mm (24.11 in.)	815.85 mm (32.10 in.)
Depth	185.00 mm (7.30 in.)	230.00 mm (9.10 in.)	234.95 mm (9.30 in.)
Dimensions (without stand)			
Height	383.15 mm (13.90 in.)	425.43 mm (16.75 in.)	434.43 mm (17.08 in.)
Width	538.64 mm (21.21 in.)	612.34 mm (24.11 in.)	815.85 mm (32.10 in.)
Depth	51.24 mm (2 in.)	53.93 mm (2.10 in.)	81.08 mm (3.20 in.)
Stand dimensions			
Height (extended)	428.30 mm (16.90 in.)	428.30 mm (16.90 in.)	433.32 mm (17.10 in.)
Height (compressed)	381.50 mm (15.02 in.)	381.50 mm (15.02 in.)	386.50 mm (15.20 in.)
Width	267.68 mm (10.50 in.)	300.01 mm (11.81 in.)	306.91 mm (12.10 in.)
Depth	185 mm (7.30 in.)	230 mm (9.10 in.)	234.95 mm (9.25 in.)
Weight			
Weight with packaging	8.82 kg (19.50 lb)	12.62 kg (27.80 lb)	16 kg (35.20 lb)
Weight with stand assembly and cables	6.53 kg (14.40 lb)	9.21 kg (20.30 lb)	11.35 kg (25 lb)
Weight without stand assembly (For wall mount or VESA mount considerations - no cables)	4.33 kg (9.60 lb)	5.74 kg (12.70 lb)	7.30 kg (16.06 lb)
Weight of stand assembly	1.79 kg (3.90 lb)	3.06 kg (6.70 lb)	3.54 kg (7.79 lb)



Environmental characteristics

Compliant Standards	
<ul style="list-style-type: none"> ENERGY STAR certified Monitor. EPEAT registered where applicable. EPEAT registration varies by country. See https://www.epeat.net for registration status by country. TCO and TCO Edge Certified Displays. RoHS Compliant. BFR/PVC Free monitor (excluding external cables). Meets NFPA 99 leakage current requirements. Arsenic-Free glass and Mercury-Free for the panel only. 	
Temperature	
Operating	0°C to 40°C (32°F to 104°F)
Non-operating	-20°C to 60°C (-4°F to 140°F)
Humidity	
Operating	10% to 80% (non-condensing)
Non-operating	5% to 90% (non-condensing)
Altitude	
Operating	5,000 m (16,404 ft) (maximum)
Non-operating	12,192 m (40,000 ft) (maximum)
Thermal dissipation	
C2422HE	665.37 BTU/hour (maximum) 61.42 BTU/hour (on mode)
C2722DE	716.55 BTU/hour (maximum) 90.42 BTU/hour (on mode)
C3422WE	750.67 BTU/hour (maximum) 108.44 BTU/hour (on mode)



Pin assignments

DP port (in)

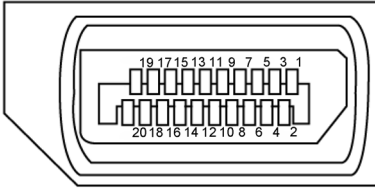

Pin number	20-pin side of the connected signal cable
1	ML3(n)
2	GND
3	ML3(p)
4	ML2(n)
5	GND
6	ML2(p)
7	ML1(n)
8	GND
9	ML1(p)
10	ML0(n)
11	GND
12	ML0(p)
13	CONFIG1
14	CONFIG2
15	AUX CH (p)
16	GND
17	AUX CH (n)
18	Hot Plug Detect
19	Return
20	DP_PWR



DP port (out)

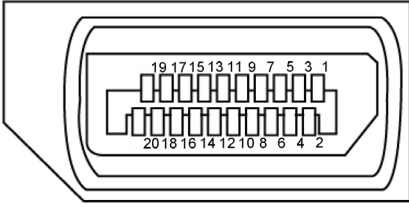

Pin number	20-pin side of the connected signal cable
1	ML0(p)
2	GND
3	ML0(n)
4	ML1(p)
5	GND
6	ML1(n)
7	ML2(p)
8	GND
9	ML2(n)
10	ML3(p)
11	GND
12	ML3(n)
13	CONFIG1
14	CONFIG2
15	AUX CH(p)
16	GND
17	AUX CH(n)
18	Hot Plug Detect
19	Return
20	DP_PWR



HDMI port

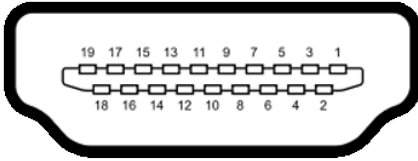

Pin number	19-pin side of the connected signal cable
1	TMDS DATA 2+
2	TMDS DATA 2 SHIELD
3	TMDS DATA 2-
4	TMDS DATA 1+
5	TMDS DATA 1 SHIELD
6	TMDS DATA 1-
7	TMDS DATA 0+
8	TMDS DATA 0 SHIELD
9	TMDS DATA 0-
10	TMDS CLOCK+
11	TMDS CLOCK SHIELD
12	TMDS CLOCK-
13	CEC
14	Reserved (N.C. on device)
15	DDC CLOCK (SCL)
16	DDC DATA (SDA)
17	DDC/CEC Ground
18	+5 V POWER
19	HOT PLUG DETECT



USB Type-C port

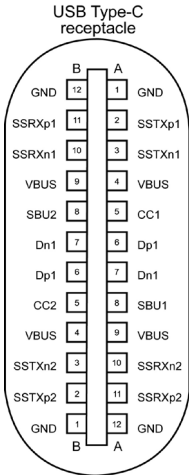



typically connected to a charger through a Type-C cable

Pin	Signal	Pin	Signal
A1	GND	B12	GND
A2	SSTXp1	B11	SSRXp1
A3	SSTXn1	B10	SSRXn1
A4	VBUS	B9	VBUS
A5	CC1	B8	SBU2
A6	Dp1	B7	Dn1
A7	Dn1	B6	Dp1
A8	SBU1	B5	CC2
A9	VBUS	B4	VBUS
A10	SSRXn2	B3	SSTXn2
A11	SSRXp2	B2	SSTXp2
A12	GND	B1	GND





Universal Serial Bus (USB)

This section gives you information about the USB ports available on your monitor.

NOTE: Up to 2 A on USB downstream port (port with  battery icon) with BC 1.2 compliance devices; up to 0.9 A on the other 2 USB downstream ports; Up to 3 A on USB Type-C downstream port (port with  icon) with 5 V/3 A compliance devices.

Your computer has the following USB ports:

- 2 upstream - at rear.
- 4 downstream - 2 at bottom, 2 at rear.

Power Charging Port - the ports with  battery icon supports fast current charging capability if the device is BC 1.2 compatible. The USB Type-C downstream port with  icon supports fast current charging capability if the device is 5V/3A compatible.

NOTE: The monitor's USB ports work only when the monitor is on or on in Standby Mode. On in Standby Mode, if the USB cable (Type-C to Type-C) is plugged in, the USB ports can work normally. Otherwise, follow the OSD setting of Other USB Charging, if the setting is "On in Standby Mode" then USB work normally, otherwise USB is disabled. If you turn off the monitor and then turn it on, the attached peripherals may take a few seconds to resume normal functionality.

Transfer speed	Data rate	Maximum power consumption (each port)
super speed	5 Gbps	4.5 W
hi speed	480 Mbps	2.5 W
full speed	12 Mbps	2.5 W

USB upstream port

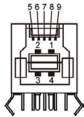

Pin number	Signal name
1	VBUS
2	D-
3	D+
4	GND
5	StdB_SSTX-
6	StdB_SSTX+
7	GND_DRAIN
8	StdB_SSRX-
9	StdB_SSRX+
Shell	Shield

USB downstream port



Pin number	Signal name
1	VBUS
2	D-
3	D+
4	GND
5	StdA_SSRX-
6	StdA_SSRX+
7	GND_DRAIN
8	StdA_SSTX-
9	StdA_SSTX+
Shell	Shield



RJ45 port (connector side)

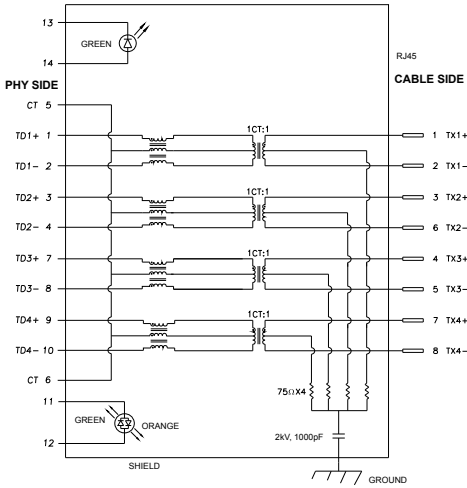

Pin	Signal	Pin	Signal
1	TD1 +	8	TD3 -
2	TD1 -	9	TD4 +
3	TD2 +	10	TD4 -
4	TD2 -	11	GREEN_OR-ANGE
5	CT	12	GREEN_OR-ANGE
6	CT	13	GREEN
7	TD3 +	14	GREEN

Driver installation

Install the Realtek USB GBE Ethernet Controller Driver available for your system. This is available for download at <https://www.dell.com/support> under the “Driver and download” section.

Network (RJ45) data rate via USB-C max speed is 1000 Mbps.

NOTE: This LAN port is 1000Base-T IEEE 802.3az compliant, supporting Mac Address (Printed on model label) Pass-thru (MAPT), Wake-on-LAN (WOL) from standby mode (S3 only) and UEFI* PXE Boot function[UEFI PXE Boot is not supported on Dell Desktop PC’s (except for OptiPlex 7090/3090 Ultra Desktop)], these 3 features depend on BIOS settings and version of the OS. Functionality may vary with Non Dell PC’s.

*UEFI stands for Unified Extensible Firmware Interface.



RJ45 Connector LED status:



LED	Color	Description
Right LED	Amber or Green	Speed indicator: <ul style="list-style-type: none">• Amber On - 1000 Mbps• Green On - 100 Mbps• Off - 10 Mbps
Left LED	Green	Link / Activity indicator: <ul style="list-style-type: none">• Blinking - Activity on the port.• Green On - Link is being established.• Off - Link is not established.

 **NOTE:** RJ45 cable is non in-box standard accessory.



Plug-and-Play

You can install the monitor in any Plug-and-Play-compatible system. The monitor automatically provides the computer system with its extended display identification data (EDID) using display data channel (DDC) protocols so the computer can configure itself and optimize the monitor settings. Most monitor installations are automatic; you can select different settings if desired. For more information about changing the monitor settings, see [Operating the Monitor](#).

LCD monitor quality and pixel policy

During the LCD monitor manufacturing process, it is not uncommon for one or more pixels to become fixed in an unchanging state which are hard to see and do not affect the display quality or usability. For more information on LCD Monitor Pixel Policy, see Dell support site at: <https://www.dell.com/pixelguidelines>.



Ergonomics

△ CAUTION: Improper or prolonged usage of keyboard may result in injury.

△ CAUTION: Viewing the monitor screen for extended periods of time may result in eye strain.

For comfort and efficiency, observe the following guidelines when setting up and using your computer workstation:

- Position your computer so that the monitor and keyboard are directly in front of you as you work. Special shelves are commercially available to help you correctly position your keyboard.
- To reduce the risk of eye strain and neck/arm/back/shoulder pain from using the monitor for long periods of time, we suggest you to:
 1. Set the distance of the screen between 20 to 28 in. (50 - 70 cm) from your eyes.
 2. Blink frequently to moisten your eyes or wet your eyes with water after prolonged usage of the monitor.
 3. Take regular and frequent breaks for 20 minutes every two hours.
 4. Look away from your monitor and gaze at a distant object at 20 feet away for at least 20 seconds during the breaks.
 5. Perform stretches to relieve tension in the neck, arm, back, and shoulders during the breaks.
- Make sure that the monitor screen is at eye level or slightly lower when you are sitting in front of the monitor.
- Adjust the tilt of the monitor, its contrast, and brightness settings.
- Adjust the ambient lighting around you (such as overhead lights, desk lamps, and the curtains or blinds on nearby windows) to minimize reflections and glare on the monitor screen.
- Use a chair that provides good lower-back support.
- Keep your forearms horizontal with your wrists in a neutral, comfortable position while using the keyboard or mouse.
- Always leave space to rest your hands while using the keyboard or mouse.
- Let your upper arms rest naturally on both sides.
- Ensure that your feet are resting flat on the floor.
- When sitting, make sure that the weight of your legs is on your feet and not on the front portion of your seat. Adjust your chair's height or use a footrest if necessary to maintain a proper posture.
- Vary your work activities. Try to organize your work so that you do not have to sit and work for extended periods of time. Try to stand or get up and walk around at regular intervals.



- Keep the area under your desk clear of obstructions and cables or power cords that may interfere with comfortable seating or present a potential trip hazard.

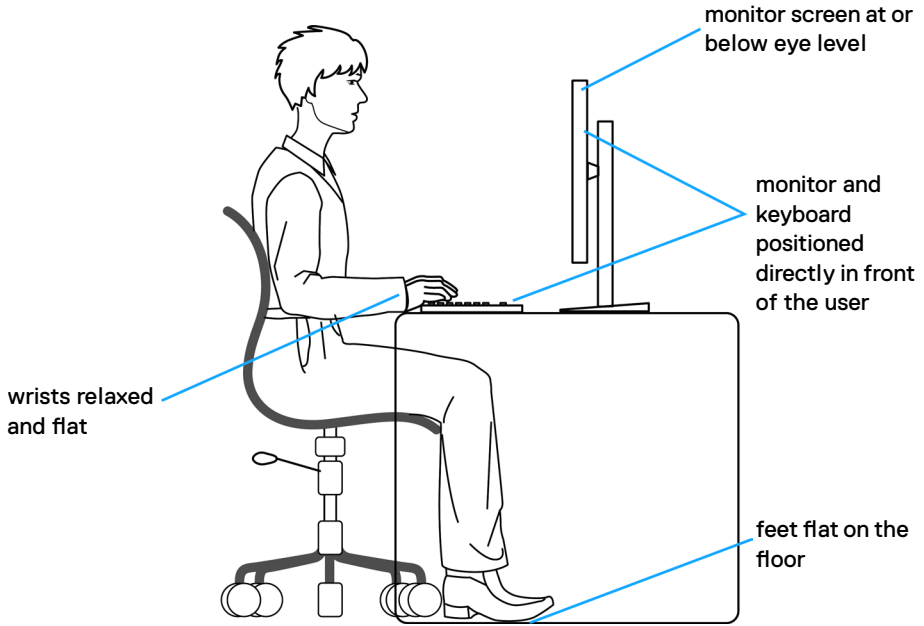

Handling and moving your display

To ensure the monitor is handled safely when lifting or moving it, follow the guidelines mentioned below:

- Before moving or lifting the monitor, turn off your computer and the monitor.
- Disconnect all cables from the monitor.
- Place the monitor in the original box with the original packing materials.
- Hold the bottom edge and the side of the monitor firmly without applying excessive pressure when lifting or moving the monitor.

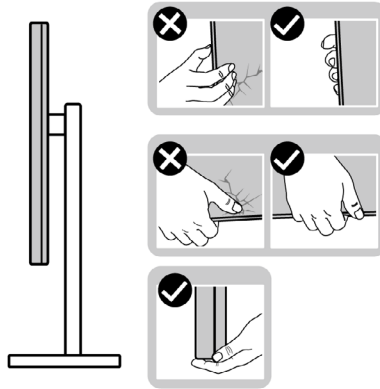

- When lifting or moving the monitor, ensure the screen is facing away from you and do not press on the display area to avoid any scratches or damage.

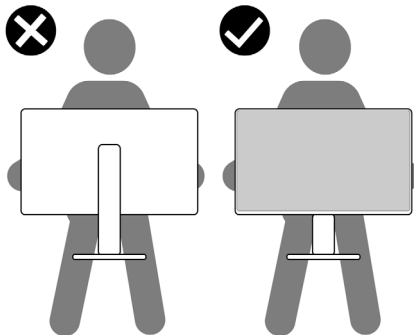

- When transporting the monitor, avoid any sudden shock or vibration to it.



- When lifting or moving the monitor, do not turn the monitor upside down while holding the stand base or stand riser. This may result in accidental damage to the monitor or cause personal injury.

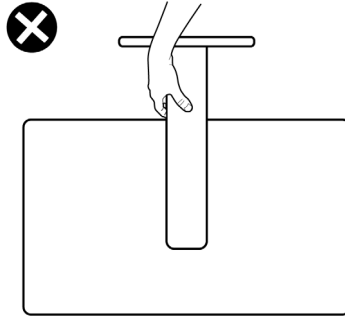

Maintenance guidelines

Cleaning your monitor

⚠ WARNING: Before cleaning the monitor, unplug the monitor power cable from the electrical outlet.

⚠ CAUTION: Read and follow the [Safety Instructions](#) before cleaning the monitor.

For best practices, follow these instructions in the list below while unpacking, cleaning, or handling your monitor:

- To clean your anti-static screen, lightly dampen a soft, clean cloth with water. If possible, use a special screen-cleaning tissue or solution suitable for the anti-static coating. Do not use benzene, thinner, ammonia, abrasive cleaners, or compressed air.
- Use a lightly-dampened, soft cloth to clean the monitor. Avoid using detergent of any kind as some detergents leave a milky film on the monitor.
- If you notice white powder when you unpack your monitor, wipe it off with a cloth.
- Handle your monitor with care as a darker-colored monitor may get scratched and show white scuff marks more than a lighter - colored monitor.
- To help maintain the best image quality on your monitor, use a dynamically changing screen saver and turn off your monitor when not in use.



Setting up the monitor

Connecting the stand

- NOTE: The stand riser and stand base are detached when the monitor is shipped from the factory.
- NOTE: The following instructions are applicable only for the stand that was shipped with your monitor. If you are connecting a stand that you purchased from any other source, follow the set up instructions that were included with the stand.

To attach the monitor stand:

1. Align and place the stand riser on the stand base.
2. Open the screw handle at the bottom of the stand base and turn it clockwise to secure the stand assembly.
3. Close the screw handle.

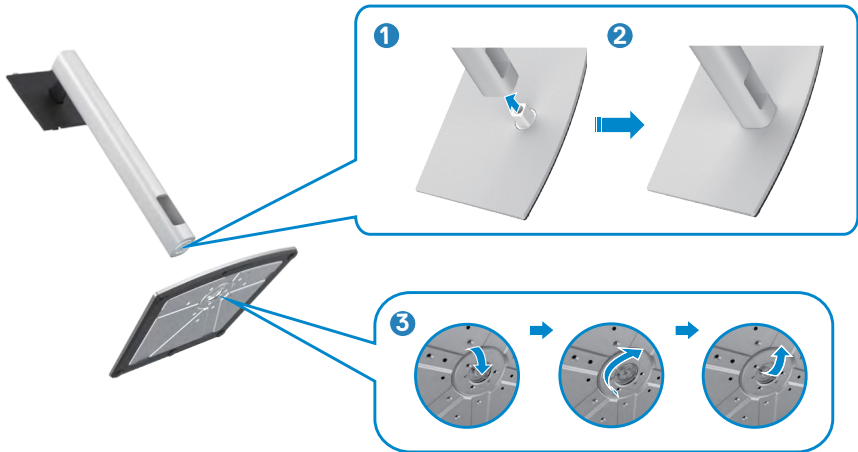

4. Open the protective cover on the monitor to access the VESA slot on the monitor.



5. Slide the tabs on the stand riser into the slots on the display back cover and lower the stand assembly to snap it into place.



6. Hold the stand riser and lift the monitor carefully, then place it on a flat surface.



NOTE: Hold the stand riser firmly when lifting the monitor to avoid any accidental damage.

7. Lift the protective cover from the monitor.



Using the tilt, swivel, and vertical extension

NOTE: The following instructions are applicable only for the stand that was shipped with your monitor. If you are connecting a stand that you purchased from any other source, follow the set up instructions that were included with the stand.

Tilt, swivel and vertical extension

With the stand attached to the monitor, you can tilt the monitor for the most comfortable viewing angle.

C2422HE

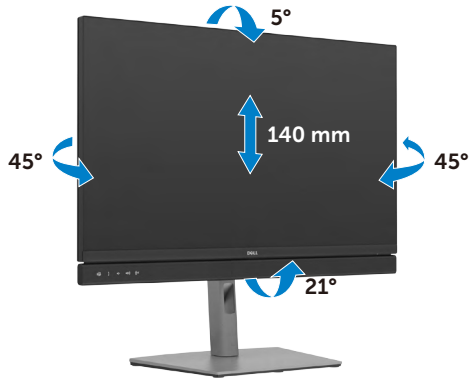

C2722DE

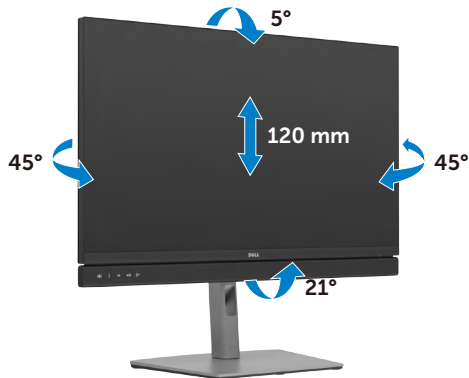

C3422WE

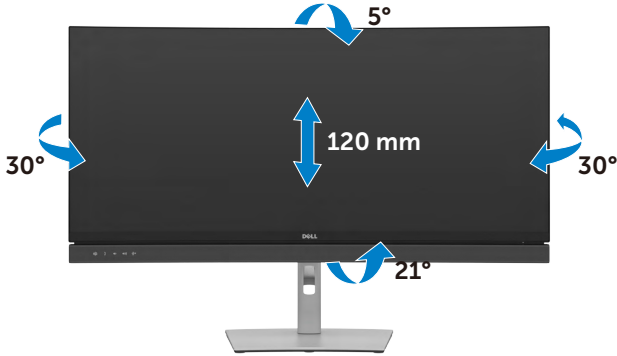

NOTE: The stand is detached when the monitor is shipped from the factory.

Rotating the Display (C2422HE/C2722DE only)

Before you rotate the display, extend the display vertically until the top of the stand riser and then tilt the display backwards until the maximum to avoid hitting the bottom edge of the display.



NOTE: To toggle the display setting on your Dell computer between landscape and portrait when rotating the display, download and install the latest graphics driver. To download, go to <https://www.dell.com/support/drivers> and search for the appropriate driver.

NOTE: When the display is in portrait mode, you may experience performance degradation when using graphic-intensive applications such as 3D gaming.



Configuring the display settings on your computer after rotation (C2422HE/C2722DE only)

After you have rotated the display, complete the procedure given below to configure the display settings on your computer.

 **NOTE:** If you are using the monitor with a non-Dell computer, go to the graphics card manufacturer's website or your computer manufacturer website for information on how to rotate the contents of your display.

To configure the Display Settings:

1. Right-click on the **Desktop** and click **Properties**.
2. Select the **Settings** tab and click **Advanced**.
3. If you have an AMD graphics card, select the **Rotation** tab and set the preferred rotation.
4. If you have an **nVidia** graphics card, click the **nVidia** tab, in the left-hand column select **NVRotate**, and then select the preferred rotation.
5. If you have an Intel® graphics card, select the Intel graphics tab, click **Graphic Properties**, select the **Rotation** tab, and then set the preferred rotation.

 **NOTE:** If you do not see the rotation option or it is not working correctly, go to <https://www.dell.com/support> and download the latest driver for your graphics card.



Operating the monitor webcam

When you want to use the monitor built-in webcam and microphone, press down on the webcam module and then release. The webcam module will pop up.

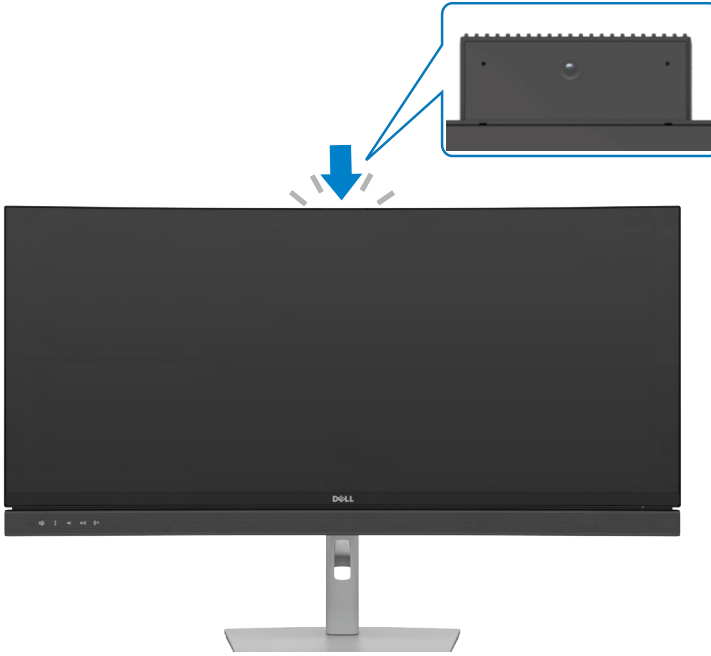

Connecting your monitor

⚠ WARNING: Before you begin any of the procedures in this section, follow the [Safety Instructions](#).

To connect your monitor to the computer:

1. Turn off your computer.
2. Connect the DisplayPort or USB cable, and the USB Type-C cable from your monitor to the computer.
3. Turn on your monitor.
4. Select the correct input source from the OSD Menu on your monitor and then turn on your computer.

NOTE: C2422HE/C3422WE default setting is DisplayPort 1.2, C2722DE default setting is DisplayPort 1.4. A DisplayPort 1.1 Graphic card may not display normally. Please refer to [“product specific problems – No image when using DP connection to the PC”](#) to change default setting.

Connecting the HDMI cable (Optional)

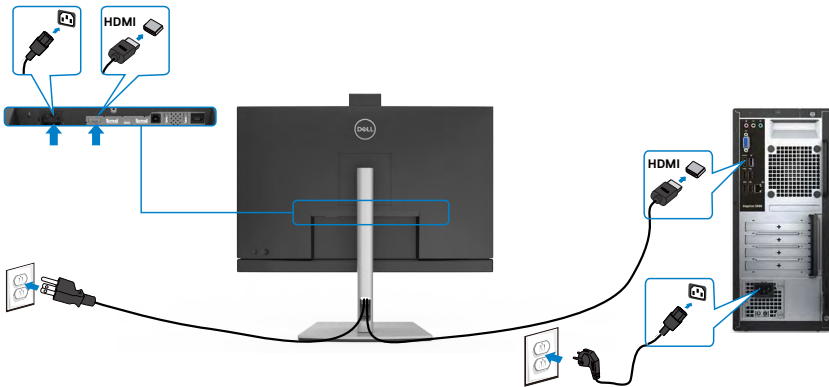

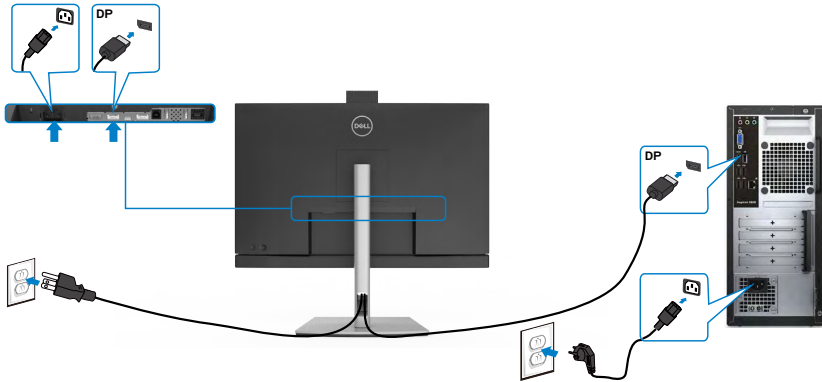

Connecting the DP cable

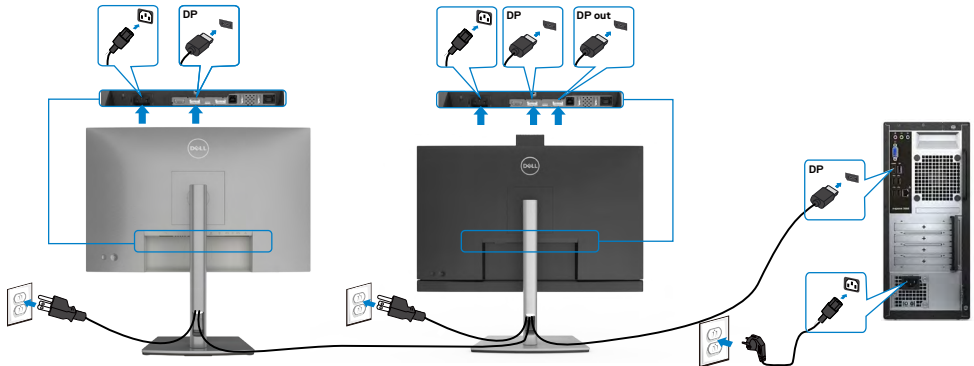

Connecting the monitor for DP Multi-Stream Transport (MST) function (C2422HE/C2722DE only)



-  **NOTE:** Supports the DP MST feature. To make use of this feature, your PC Graphics Card must be certified to at least DP1.2 with MST option.
-  **NOTE:** Remove the rubber plug when using DP out connector.
-  **NOTE:** It is not recommended to connect multiple C2422HE / C2722DE / C3422WE in DP MST function.



Connecting the USB cable

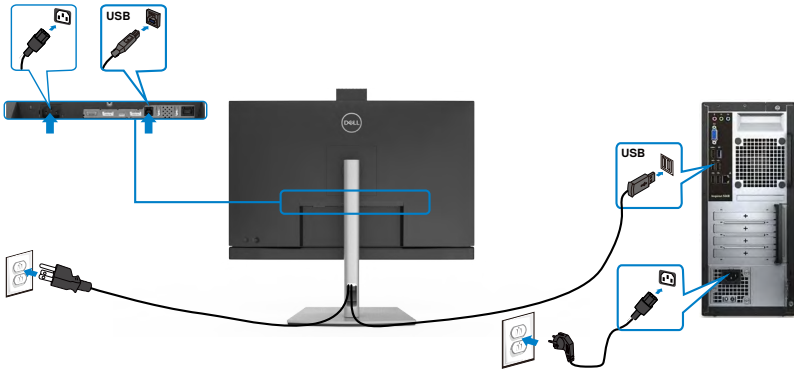

Connecting the USB Type-C cable

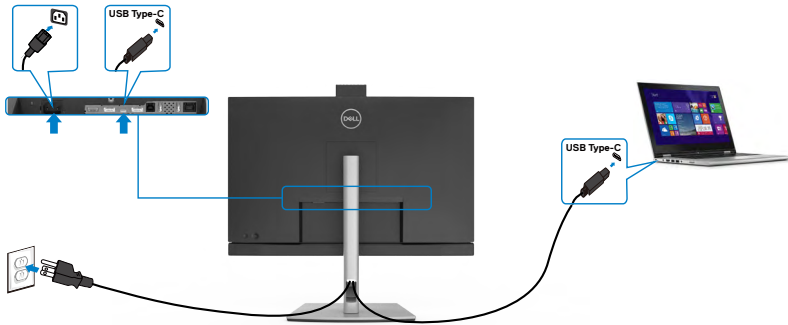

The USB Type-C port on your monitor:

- Can be used as USB Type-C, DisplayPort 1.4 (C2722DE) or DisplayPort 1.2 (C2422HE/C3422WE), alternatively.
- Supports USB Power Delivery (PD), with profiles up to 90 W.

NOTE: Regardless of the power requirement/actual power consumption of your laptop, or the remaining power runtime in your battery, the Dell C2422HE/C2722DE/C3422WE monitor is designed to supply power delivery of up to 90 W to your laptop.

Rated power (on laptops that have USB Type-C with Power Delivery)	Maximum charging power
45 W	45 W
65 W	65 W
90 W	90 W
130 W	Not supported



Connecting the monitor for USB-C Multi-Stream Transport (MST) function (C2422HE/C2722DE only)

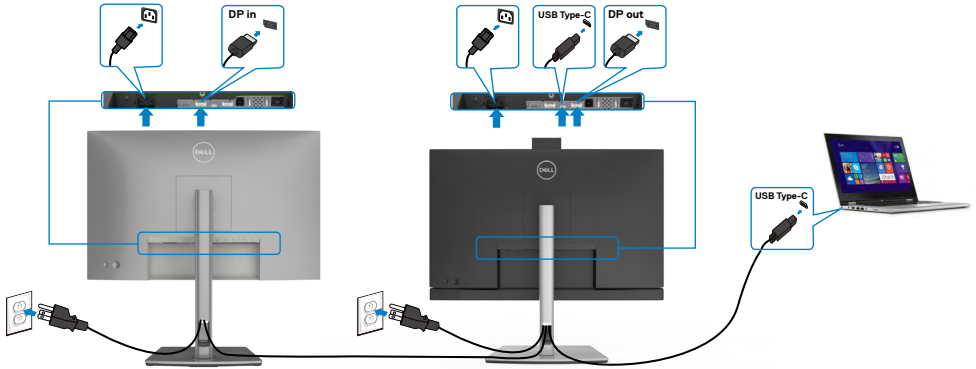

NOTE: The maximum number of supported C2422HE/C2722DE via MST is subjected to the bandwidth of the USB-C source. Please refer to “[product specific problems –No image when using USB Type-C MST](#)”.

NOTE: Remove the rubber plug when using DP out connector.

NOTE: It is not recommended to connect multiple C2422HE / C2722DE / C3422WE in DP MST function.

Connecting the monitor for RJ45 Cable (Optional)

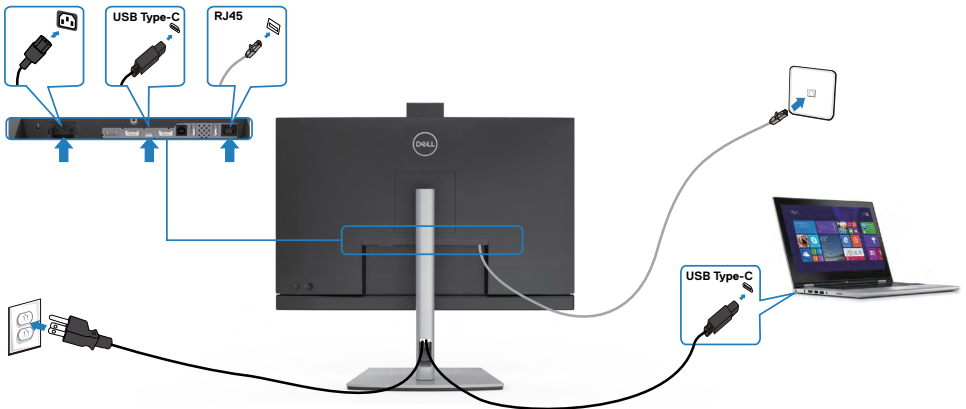

Dell Power Button Sync (DPBS)

Your monitor is designed with Dell Power Button Sync (DPBS) feature to allow you to control PC system power state from the monitor power button. This feature is only supported with Dell platform which has built-in DPBS function, and is only supported over USB-C interface.

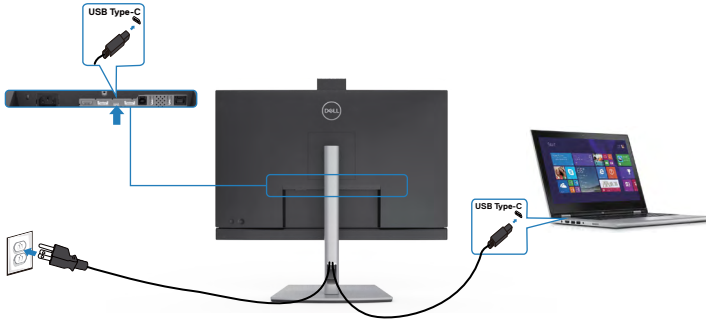

To make sure the DPBS function works for the first time, perform the following steps on the DPBS supported platform in the **Control Panel** first.

NOTE: DPBS only supports the USB-C upstream port.

1. Go to **Control Panel**.

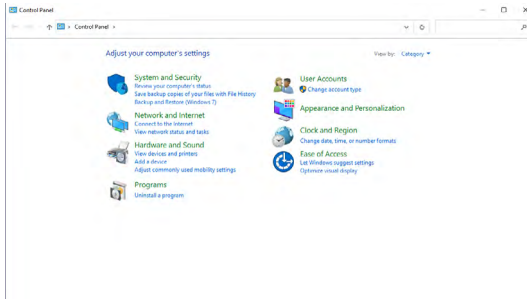

2. Select **Hardware and Sound**, followed by **Power Options**.

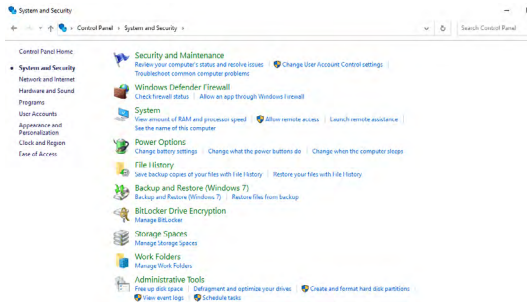

3. Go to **System Settings**

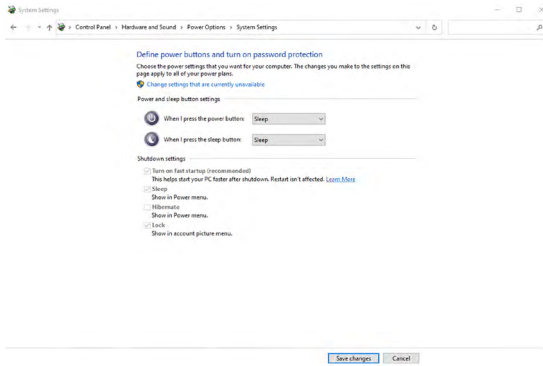

4. In the drop-down menu of **When I press the power button**, there are a few options for selection namely **Do nothing/Sleep/Hibernate/Shut down**, and you can select **Sleep/Hibernate/Shut down**.

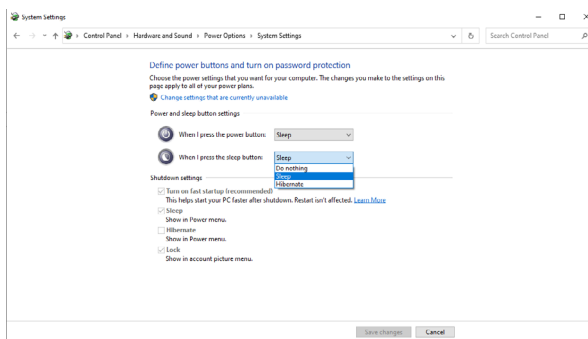
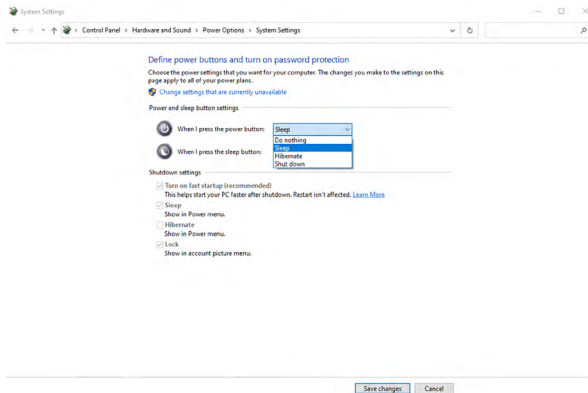

NOTE: Do not select **Do nothing**, otherwise monitor power button cannot sync with PC system power state.



Connecting the monitor for DPBS for the first time

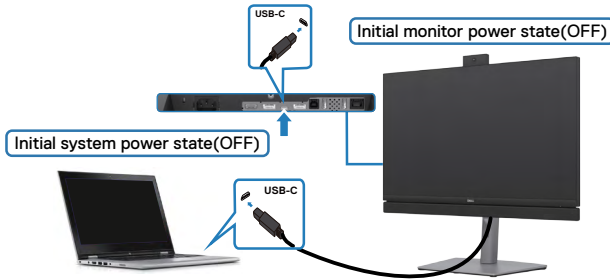

For the first time setting up the DPBS function:

1. Make sure both the PC and monitor is OFF.
2. Press the monitor power button to turn ON the monitor.
3. Connect the USB-C cable from the PC to the monitor.
4. Both the monitor and PC will turn ON normally except Dell Optiplex 7090/3090 Ultra platform.
5. When you connect the Dell Optiplex 7090/3090 Ultra platform, you may see both the monitor and PC will turn ON momentarily. Wait for a while (approximately 6 seconds) and both the PC and monitor will turn OFF. When you press either the monitor power button or PC power button, both the PC and monitor will turn ON. The PC system power state is in sync with the monitor power button.

NOTE: You can power the Dell PC* Ultra platform using its DC adaptor jack. Alternatively, you can power the Dell PC* Ultra platform using the monitor's USB-C cable via Power Delivery (PD); please set USB-C Charging  90 W to On in Off Mode.

* Ensure to check the Dell PC for DPBS supportability.



Using DPBS function

Waking on the USB-C cable

- When you connect the USB-C cable, the Monitor/PC state is as follows:

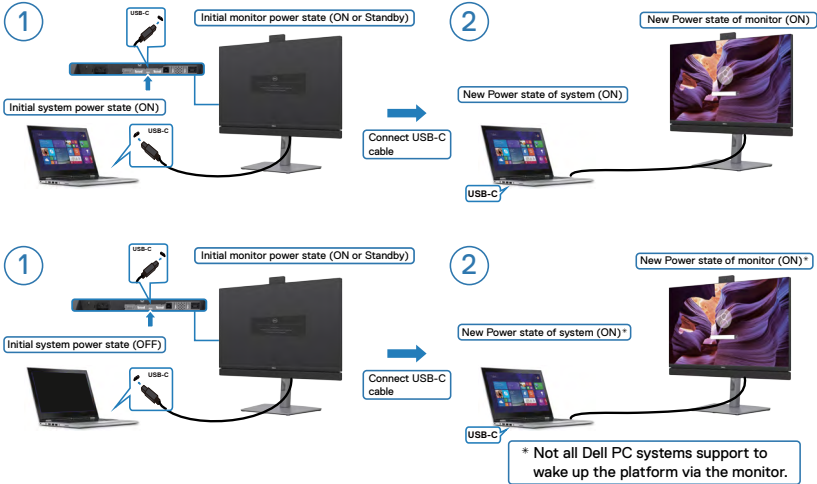

Pressing the power button

- When you press the monitor power button or PC power button, the Monitor/PC state is as follows:

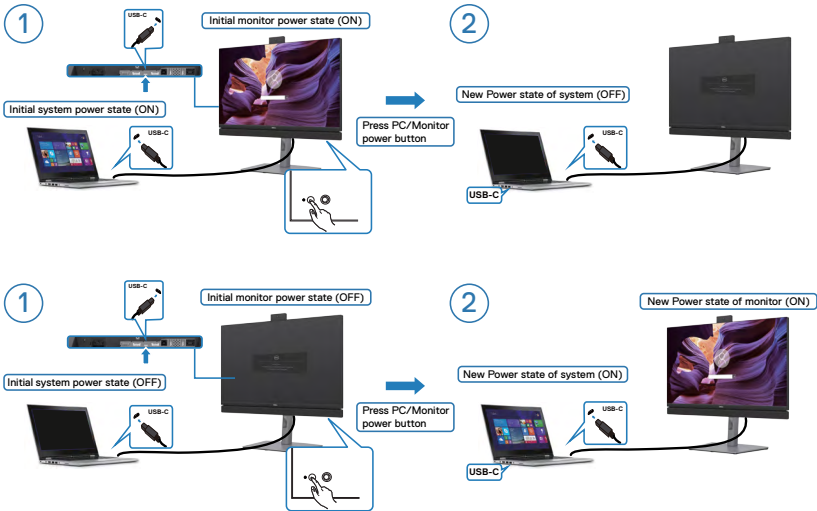

- When the monitor and the PC power state are both ON, **press and hold the monitor power button for 4 seconds**, the screen prompt will ask if you would like to shut down the PC.

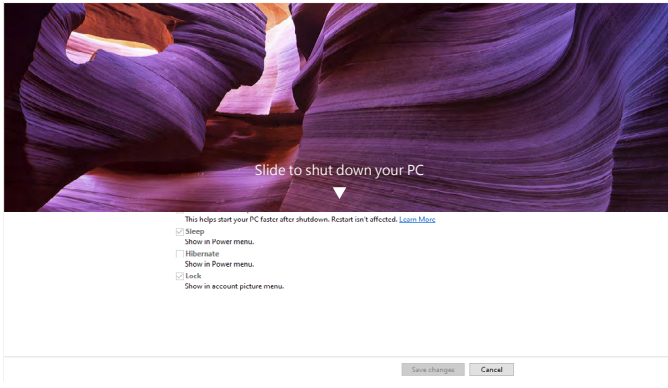
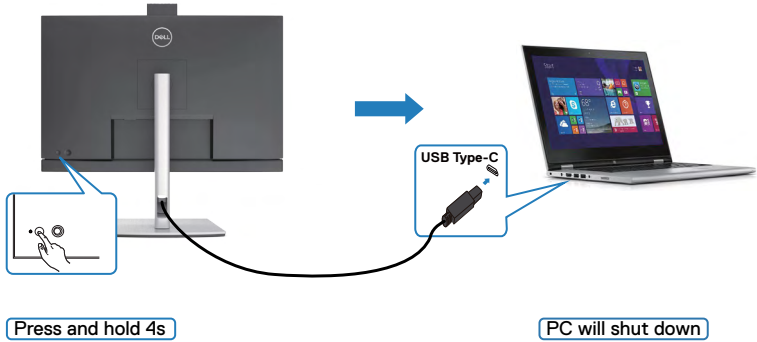

- When the monitor and the PC power state are both ON, **press and hold the monitor power button for 10 seconds**, the PC will shut down.

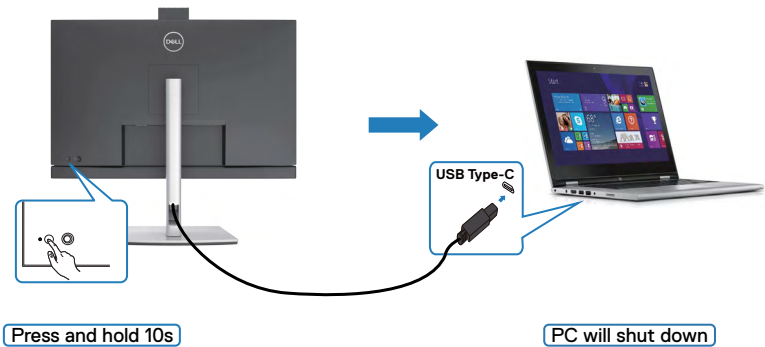

Connecting the monitor for USB-C Multi-Stream Transport (MST) function (C2422HE/C2722DE only) in DPBS mode

A PC is connected to two monitors in an initially OFF power state, and the PC system power state is in sync with Monitor 1 power button. When you press the Monitor 1 or PC power button, both the Monitor 1 and PC turns ON. Meanwhile the Monitor 2 will remain OFF. You need to manually press the power button on Monitor 2 to turn it ON.

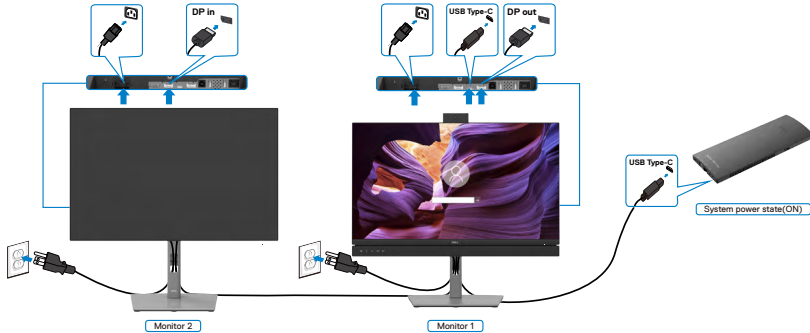

NOTE: Both monitors need to be Dell monitors which support DPBS function.

NOTE: It is not recommended to connect multiple C2422HE / C2722DE / C3422WE in USB-C MST function in DPBS mode.

Similarly, a PC is connected to two monitors in an initially ON power state, and the PC system power state is in sync with Monitor 1 power button. When you press the Monitor 1 or PC power button, both the Monitor 1 and PC turns OFF. Meanwhile the Monitor 2 will be in Standby mode. You need to manually press the power button on Monitor 2 to turn it OFF.

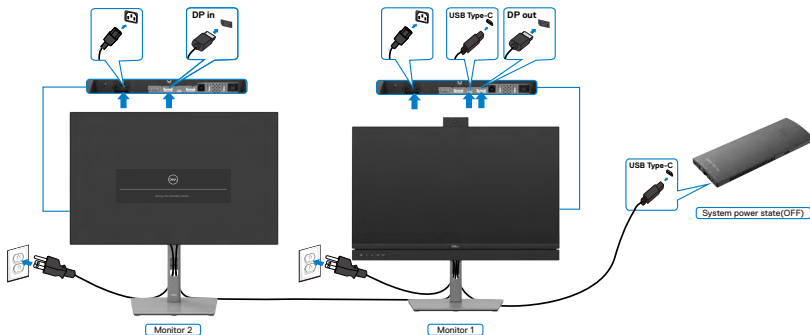

Connecting the monitor for USB-C in DPBS mode

The Dell OptiPlex 7090 Ultra platform has two USB-C ports, so both Monitor 1 and Monitor 2 power state will sync with the PC.

While the PC and two monitors are in an initially ON power state, by pressing the power button on Monitor 1 or Monitor 2 will turn OFF the PC, Monitor 1, and Monitor 2.

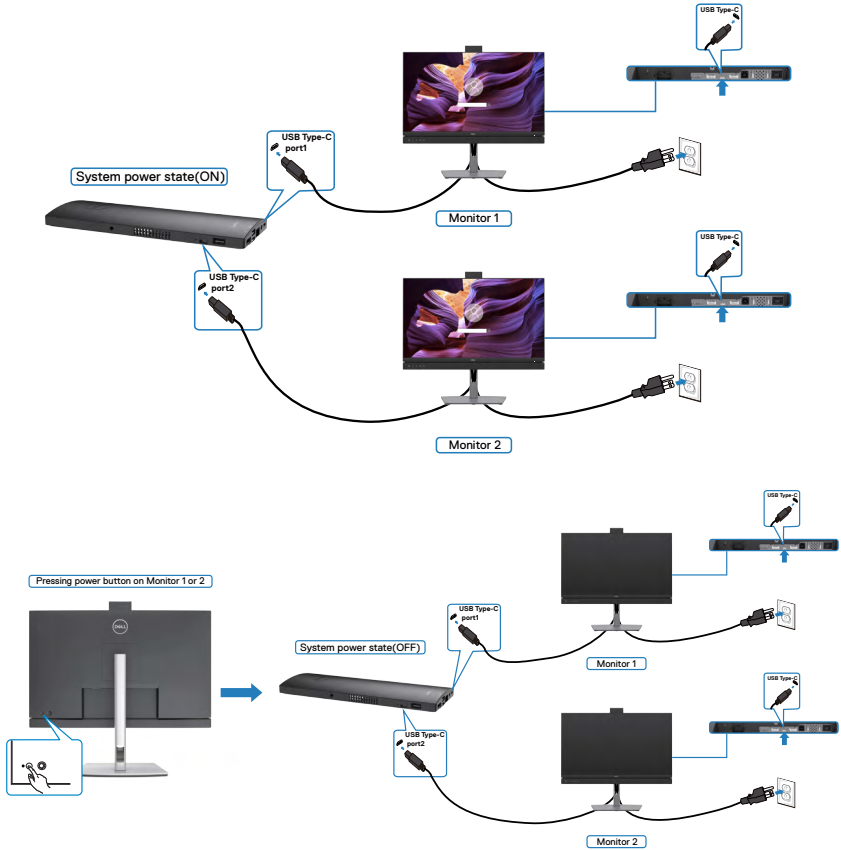

Make sure to set **USB-C Charging** to On in Off Mode. While the PC and two monitors are in an initially OFF power state, by pressing the power button on Monitor 1 or Monitor 2 will turn ON the PC, Monitor 1, and Monitor 2.

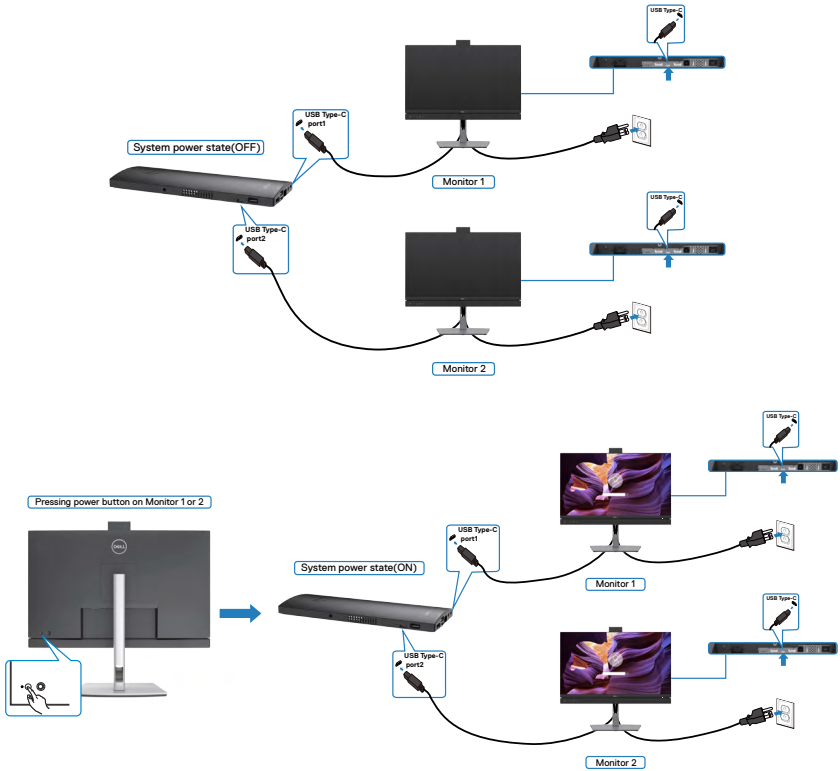

Organizing your cables



After attaching all necessary cables to your monitor and computer, (see [Connecting Your Monitor](#) for cable attachment) organize all cables as shown above.

Securing your monitor using Kensington lock (optional)

The security lock slot is located at the bottom of the monitor. (See [Security lock slot](#))

For more information on using the Kensington lock (purchased separately), see the documentation that is shipped with the lock.

Secure your monitor to a table using the Kensington security lock.

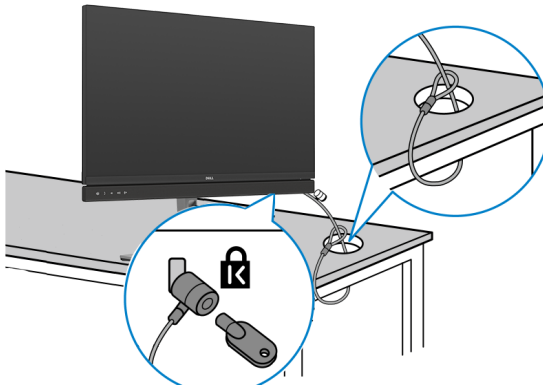

NOTE: The image is for the purpose of illustration only. Appearance of the lock may vary.



Removing the monitor stand

CAUTION: To prevent scratches on the LCD screen when removing the stand, ensure that the monitor is placed on a soft, clean surface.

NOTE: The following instructions are applicable only for the stand that was shipped with your monitor. If you are connecting a stand that you purchased from any other source, follow the set up instructions that were included with the stand.

To remove the stand:

1. Place the monitor on a soft cloth or cushion.
2. Press and hold the stand-release button.
3. Lift the stand up and away from the monitor.

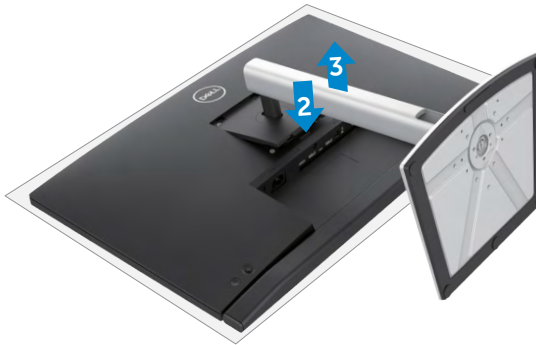

Wall mounting (Optional)

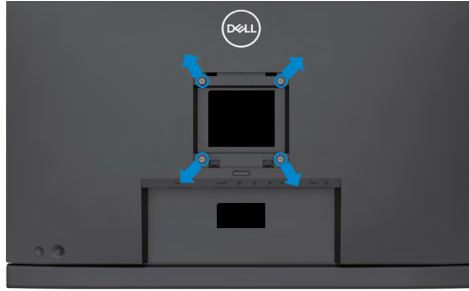

NOTE: Use M4 x 11 mm screws to connect the monitor to the wall-mounting kit.

Refer to the instructions that come with the VESA-compatible wall mounting kit.

1. Place the monitor on a soft cloth or cushion on a stable flat table.
2. Remove the stand.
3. Use a Phillips crosshead screwdriver to remove the four screws securing the plastic cover.
4. Attach the mounting bracket from the wall mounting kit to the monitor.
5. Mount the monitor on the wall as instructed in the documentation that shipped with the wall-mounting kit.

NOTE: For use only with UL or CSA or GS-listed wall mount bracket with minimum weight/load bearing capacity of 17.32 kg (38.40 lb) (C2422HE) / 22.96 kg (50.80 lb) (C2722DE) / 29.20 kg (64.24 lb) (C3422WE).



Operating the monitor

Power on the monitor

Press the  button to turn on the monitor.

Using the joystick control

Use the joystick control on the rear of the monitor to make OSD adjustments.



1. Press the joystick button to launch the OSD main menu.
2. Move the joystick up/down/left/right to toggle between options.
3. Press the joystick button again to confirm the settings and exit.

Joystick Description



- When the OSD menu is on, press the button to confirm the selection or save the settings.
 - When the OSD menu is off, press the button to launch the OSD main menu. See [Accessing the menu system](#).
-



- For 2-way (right and left) directional navigation.
 - Move right to enter the submenu.
 - Move left to exit from the submenu.
 - Increases (right) or decreases (left) the parameters of selected menu item.
-



- For 2-way (up and down) directional navigation.
 - Toggles between the menu items.
 - Increases (up) or decreases (down) the parameters of selected menu item.
-







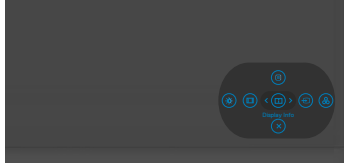

Using the rear-panel controls

Use the joystick control on the rear of the monitor to adjust the display settings. As you use the button to adjust the settings, an OSD shows the numeric values of each feature as they change.



The following table describes the rear-panel buttons:

Options	Description
1  Shortcut key: Menu	Use this Menu button to launch the on-screen display (OSD) and select the OSD menu. See Accessing the menu system
2  Shortcut key: Display Info	Use this button to choose from a list of Display Info .
3  Shortcut key: Input Source	Use this button to choose from a list of Input Source .
4  Shortcut key: Preset Modes	Use this button to choose from a list of preset color modes .
5  Shortcut key: Brightness/Contrast	To directly access the Brightness/Contrast adjustment sliders.
6  Shortcut key: Aspect Ratio	Use this button to choose from a list of Aspect Ratio .
7  Exit	Use this button to go back to the main menu or exit the OSD main menu.



Using the OSD lock function

You can lock the front-panel control buttons to prevent access to the OSD menu and/or power button.

Use the Lock menu to lock the button(s).

1. Select one of the following options.

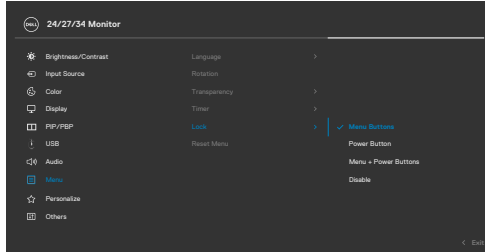

2. The following message appears.

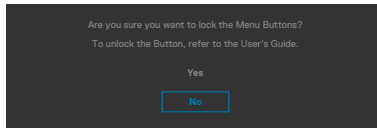

3. Select **Yes** to lock buttons. Once locked, pressing any control button will display the lock icon .





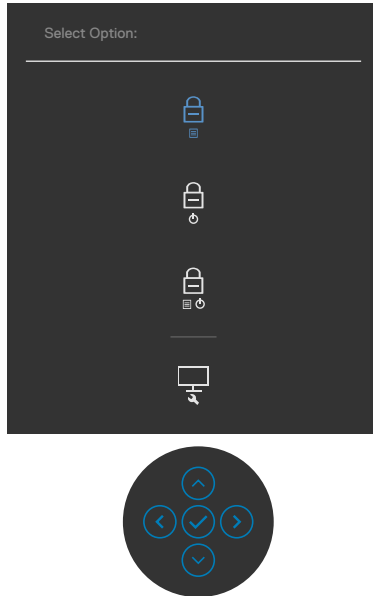

Use the Joystick to lock the button(s).

Press the left directional navigation of Joystick for four seconds, a menu appears on the screen.



Select one of the following options:



Options	Description
1  Menu Button lock	Select this option to lock OSD menu function.
2  Power Button lock	Use this option to lock power button. This will prevent the user to turn off the monitor using the power button.
3  Menu and Power Button lock	Use this option to lock OSD menu and power button to turn off the monitor.
4  Built-in Diagnostics	Use this option to run the built-in diagnostics, see Built-in Diagnostics .

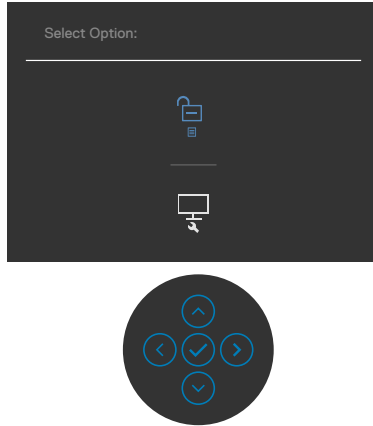

To unlock the button(s).

Press the left directional navigation of Joystick for four seconds until a menu appears on the screen. The following table describes the options to unlock the front-panel control buttons.









Options	Description
1  Menu Button unlock	Use this option to unlock OSD menu function.
2  Power Button unlock	Use this option to unlock power button to turn off the monitor.
3  Menu and Power Button unlock	Use this option to unlock OSD menu and power button to turn off the monitor.

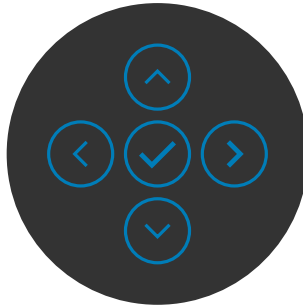

Front-panel button

Use the buttons on the front of the monitor to adjust the image settings.



Front Panel	Description
1   Up Down	Use the Up (increase) and Down (decrease) buttons to adjust items in the OSD menu.
2  Previous	Use the Previous button to go back to the previous menu.
3  Next	Use the Next button to confirm your selection.
4  Tick	Use the Tick button to confirm your selection.



Using the On-Screen Display (OSD) Menu

Accessing the menu system





Icon	Menu and Submenus	Description
	Brightness/Contrast	Use this menu to activate Brightness/Contrast adjustment.

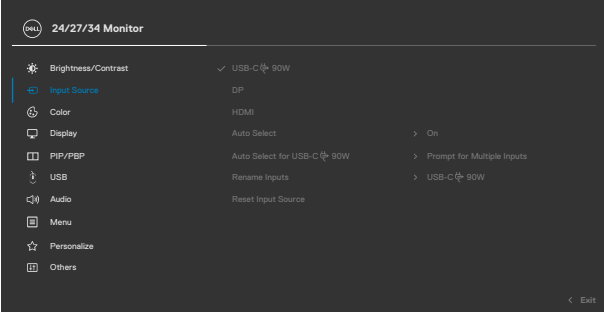

Brightness **Brightness** adjusts the luminance of the backlight (minimum 0; maximum 100).
Move the joystick up to increase brightness.
Move the joystick down to decrease brightness.

Contrast Adjust the **Brightness** first, and then adjust **Contrast** only if further adjustment is necessary.
Move the joystick up to increase contrast and Move the joystick down to decrease contrast (between 0 and 100).
The **Contrast** function adjusts the degree of difference between darkness and lightness on the monitor screen.



Icon	Menu and Submenus	Description
	Input Source	Use the Input Source menu to select between different video inputs that are connected to your monitor.
		
		
USB-C 90 W 	Select USB-C 90 W input when you are using the USB-C 90 W connector. Press the joystick button to confirm the selection.	
DP	Select DP input when you are using the DP (DisplayPort) connector. Press the joystick button to confirm the selection.	
HDMI	Select the HDMI input when you are using the HDMI connector. Press the joystick button to confirm the selection.	
Auto Select	Turn on the function to allow the monitor to automatically scan for available input sources. Press the joystick button to confirm the selection.	
Auto Select for USB-C 90 W 	Allows you to set Auto Select for USB Type-C to: <ul style="list-style-type: none"> • Prompt for Multiple Inputs: always show Switch to USB Type-C Video Input message for user to choose whether to switch or not. • Yes: The monitor always switch to USB Type-C video without asking while USB Type-C connected. • No: The monitor will NOT auto switch to USB Type-C video from another available input. 	
Rename Inputs	Allows you to Rename Inputs.	



Icon	Menu and Submenus	Description
	Reset Input Source	Resets all settings under the Input Source menu to the factory defaults.



Color

Use the **Color** menu to adjust the color setting mode.

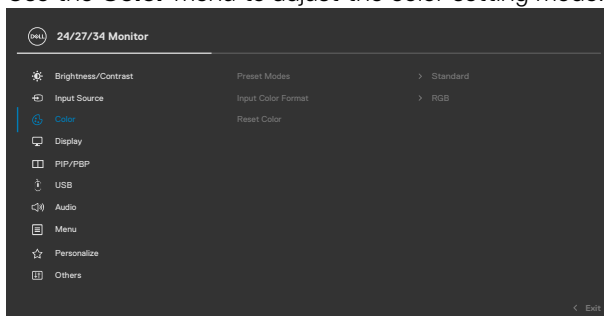

Preset Modes When you select Preset Modes, you can choose **Standard, Movie, Game, Warm, Cool** or **Custom Color** from the list.

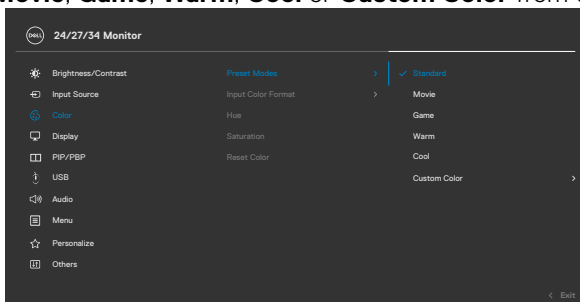

Icon	Menu and Submenus	Description
		<ul style="list-style-type: none"> ◆ Standard: Default Color setting, This monitor uses a low blue light panel, and is certified by TUV to reduce blue light output and create a more relaxing and less stimulating image while reading content on the screen. ◆ Movie: Ideal for movies. ◆ Game: Ideal for most gaming applications. ◆ Warm: Presents colors at lower color temperatures. The screen appears warmer with a red/yellow tint. ◆ Cool: Presents colors at higher color temperatures. The screen appears cooler with a blue tint. ◆ Custom Color: Allows you to manually adjust the color settings. Press the joystick left and right buttons to adjust the Red, Green, and Blue values and create your own preset color mode.

Input Color Format

Allows you to set the video input mode to:

- ◆ **RGB:** Select this option if your monitor is connected to a computer (or DVD player) using the USB Type-C, DP, HDMI cable.
- ◆ **YPbPr:** Select this option if your DVD player supports only YPbPr output.

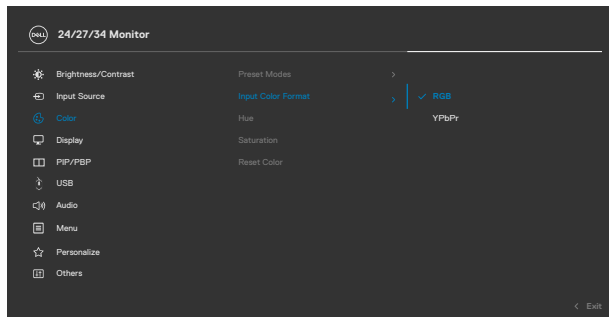

Hue

Use joystick up or down to adjust the hue from 0 to 100.

NOTE: Hue adjustment is available only for Movie and Game mode.



Icon	Menu and Submenus	Description
	Saturation	Use joystick up or down to adjust the saturation from 0 to 100. NOTE: Saturation adjustment is available only for Movie and Game mode.
	Reset Color	Resets your monitor's color settings to the factory defaults.



Display Use the Display menu to adjust image.

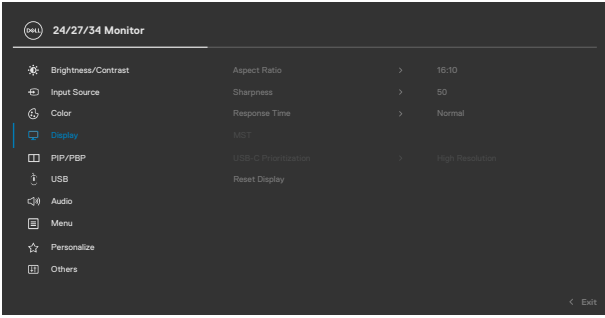

Aspect Ratio **C2422HE:** Adjust the image ratio to **16:9, 4:3, 5:4**.
C2722DE: Adjust the image ratio to **16:9,Auto Resize, 4:3, 1:1**.
C3422WE: Adjust the image ratio to **21:9,4:3, 5:4**.

Sharpness Makes the image look sharper or softer.
 Move the joystick up and down to adjust the sharpness from '0' to '100'.

Response Time Allows you to set the **Response Time** to **Normal** or **Fast**.

MST (C2422HE/ C2722DE only) DP Multi Stream Transport, Set to ON enables MST(DP out), Set to OFF disables MST function.
NOTE: When DP/USB Type-C upstream cable and DP downstream cable is connected, monitor will set MST = ON automatically, this action will only be done once after Factory Reset or Display Reset.



Icon	Menu and Submenus	Description
	USB-C Prioritization (C2722DE only)	Allows you to specify the priority to transfer the data with high resolution (High Resolution) or high speed (High Data Speed) when using the USB Type-C port/DisplayPort. NOTE: If your PC does not have a built-in battery pack and is powered directly from the monitor USB Type-C port (such as the Dell OptiPlex Ultra Desktop), changing USB-C Prioritization on the fly would interrupt the power from monitor to the PC. Please set USB-C Charging to On During Power Off.
	Reset Display	Resets all settings under the Display menu to the factory defaults.



PIP/PBP (C3422WE only)

This function brings up a window displaying image from another input source.

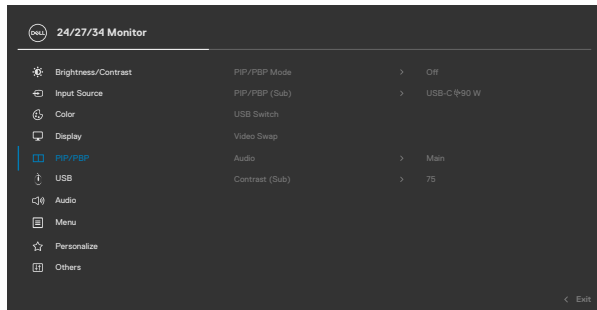

Main Window	Sub-Window	
	USB Type-C	DP
USB Type-C	✓	✓
DP	✓	✓

NOTE: The images under PBP will be displayed at the center of the screen, not full screen.





Icon	Menu and Submenus	Description
------	-------------------	-------------

PIP/PBP Mode

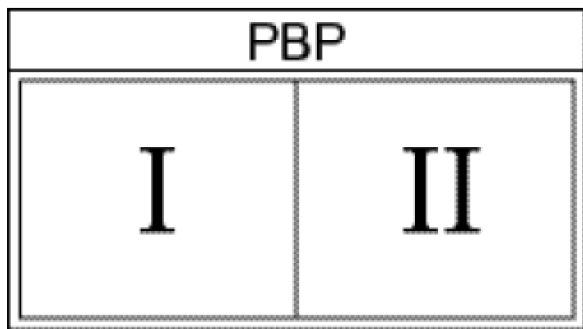
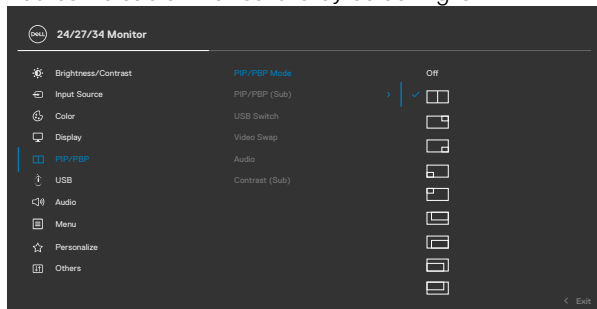
Adjusts the PIP or PBP (Picture by Picture) mode. You can disable this feature by selecting Off.

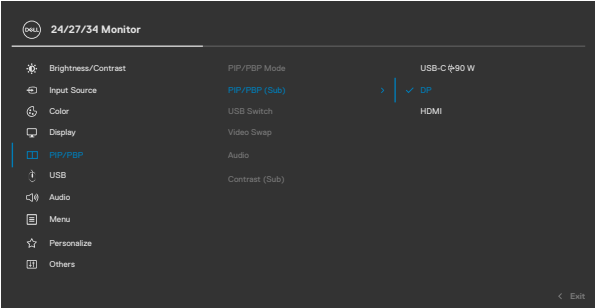

Icon	Menu and Submenus	Description
 PIP/PBP (Sub)	Select between the different video signals that may be connected to your monitor for the PBP sub-window. Press the ✓ button to select the PBP sub-window source signal.	
		
		
USB Switch	Select to switch between the USB upstream sources in PBP mode. Move the joystick to switch among USB upstream sources in PBP mode.	
Video Swap	Select to swap videos between main window and sub-window in PBP mode. Move the joystick to swap main window and sub-window.	
Contrast (Sub)	Adjust the contrast level of the picture in PBP Mode. Move the joystick to increase or decrease the contrast.	



Icon	Menu and Submenus	Description
------	-------------------	-------------



USB

Allows you to set the USB upstream port for the DP input signals, thus the monitor's USB downstream port (eg. keyboard and mouse) can be used by the current input signals when you connect a computer to either one of the upstream ports.

When you use only one upstream port, the connected upstream port is active.

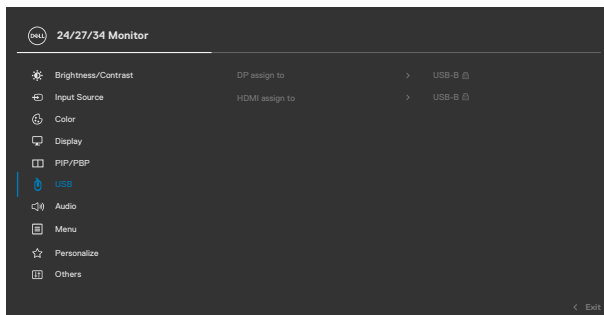

NOTE: To prevent data damage or loss, before changing USB upstream ports, make sure that NO USB storage devices are in use by the computer connected to the monitor's USB upstream port.



Icon	Menu and Submenus	Description
------	-------------------	-------------



Audio

Use the Audio Settings menu to adjust the audio settings.

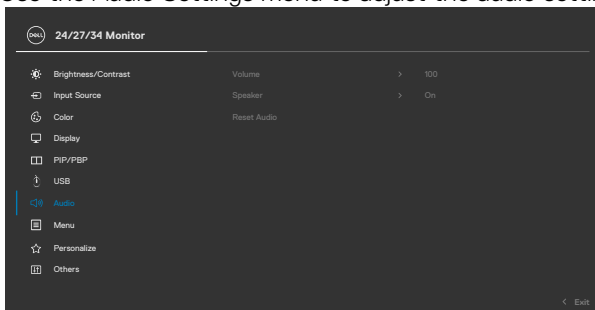

Volume

Allows you to increase the speaker volume.

Move the joystick up and down to adjust the volume from '0' to '100'.

Speaker



Select On or Off the Speaker function.

Reset Audio

Resets all settings under the **Audio** menu to the factory defaults.

NOTE: With the USB cable audio volume sync with windows volume and not to default settings.

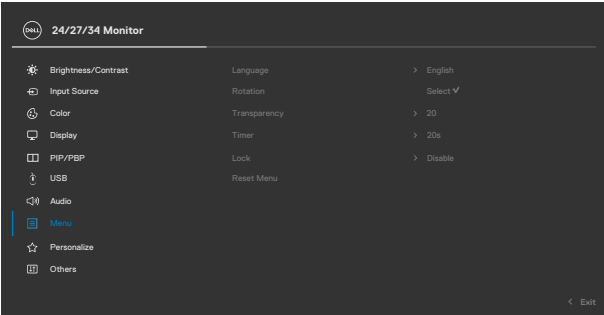

Icon	Menu and Submenus	Description
	Menu	<p>Select this option to adjust the settings of the OSD, such as the languages of the OSD, the amount of time the menu remains on screen, and so on.</p>
		
		
Language	<p>Set the OSD display to one of eight languages. (English, Spanish, French, German, Brazilian Portuguese, Russian, Simplified Chinese, or Japanese).</p>	
Rotation (C2422HE / C2722DE only)	<p>Rotates the OSD by 0/90/270 degrees. You can adjust the menu according to your display rotation.</p>	
Transparency	<p>Select this option to change the menu transparency by moving the joystick up or down (min. 0/max. 100).</p>	
Timer	<p>OSD Hold Time: Sets the length of time the OSD remains active after you press a button. Move the joystick to adjust the slider in 1-second increments, from 5 to 60 seconds.</p>	



Icon	Menu and Submenus	Description
------	-------------------	-------------

Lock

With the control buttons on the monitor locked, you can prevent people from accessing the controls. It also prevents accidental activation in multiple monitors side-by-side setup.

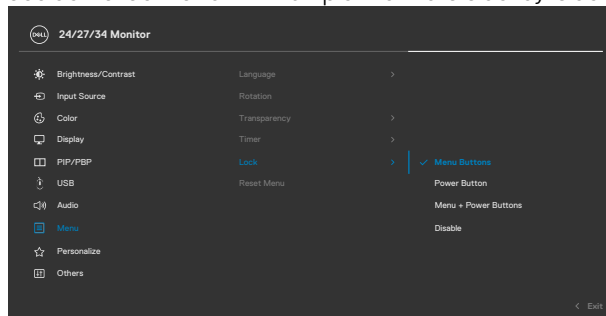



- **Menu Buttons:** Through OSD to lock the Menu buttons.
- **Power Button:** Through OSD to lock the Power button.
- **Menu + Power Buttons:** Through OSD to lock the all of Menu and Power buttons.
- **Disable:** Move the Joystick left and hold for 4 seconds.

Reset Menu

Resets all settings under the **Reset** menu to the factory defaults.

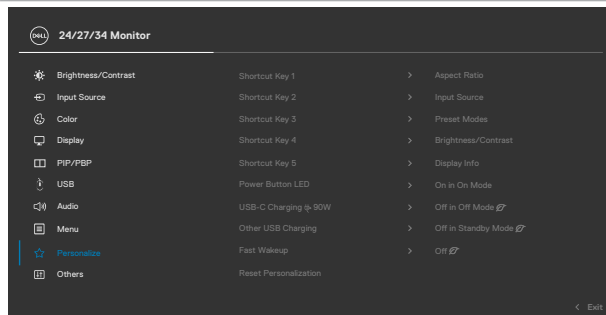
Personalize



Icon	Menu and Submenus	Description
	Shortcut key 1	
	Shortcut key 2	
	Shortcut key 3	Select from Preset Modes, Brightness/Contrast, Input Source, Aspect Ratio, Rotation, Display Info set as shortcut key.
	Shortcut key 4	
	Shortcut key 5	
	Power Button LED	Allows you to set the state of the power light to save energy.
	USB-C Charging 90 W 	Allows you to enable or disable USB-C Charging 90 W charging function during monitor power off mode.
	Other USB Charging	Allows you to enable or disable Other USB Charging function during monitor Standby mode.
	Fast Wakeup (C3422WE only)	Speed up recovery time from sleep mode.
	Reset Personalization	Resets all settings under the Personalize menu to the factory preset values.



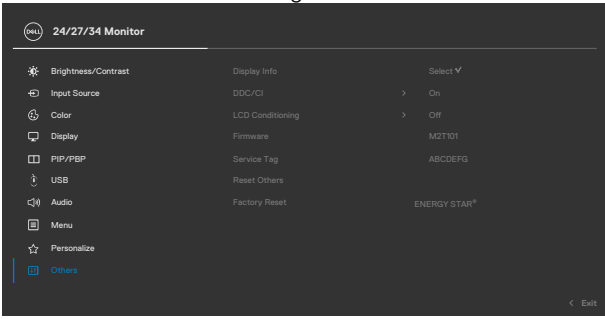

Icon	Menu and Submenus	Description
	Others	Select this option to adjust the OSD settings such as the DDC/CI , LCD conditioning, and so on.

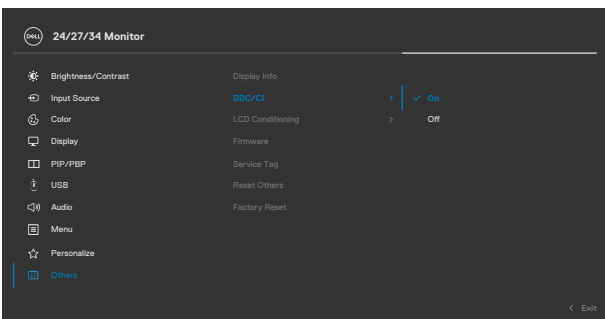

Display Info Displays the monitor's current settings.

DDC/CI **DDC/CI** (Display Data Channel/Command Interface) allows your monitor parameters (brightness, color balance, and etc.) to be adjustable via the software on your computer. You can disable this feature by selecting **Off**. Enable this feature for best user experience and optimum performance of your monitor.

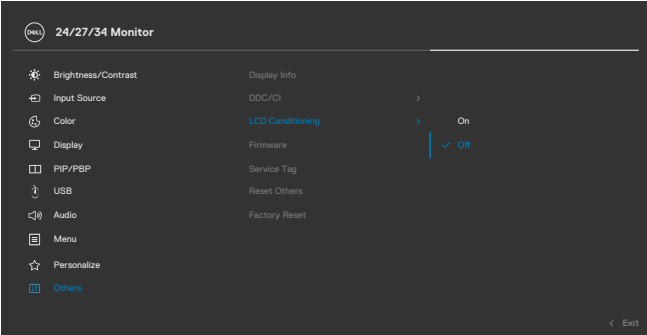

Icon	Menu and Submenus	Description
	LCD Conditioning	Helps reduce minor cases of image retention. Depending on the degree of image retention, the program may take some time to run. You can enable this feature by selecting On .
 <p>The screenshot shows the '24/27/34 Monitor' OSD menu. The 'Color' option is selected, and the 'LCD Conditioning' sub-menu is open, showing 'On' as the selected option. Other visible options include Brightness/Contrast, Input Source, Display, PIP/PBP, USB, Audio, Menu, Personalize, and Others.</p>		
 <p>A circular icon representing the Dell navigation pad, with four directional arrows (up, down, left, right) and a central checkmark.</p>		
Firmware	Service Tag	Displays the firmware version of your monitor. Displays the Service Tag. The Service Tag is a unique alphanumeric identifier that allows Dell to identify the product specifications and access warranty information. NOTE: The Service Tag is also printed on a label located at the back of the cover.
Reset Others	Factory Reset	Resets all settings under the Others menu to the factory defaults. Restores all preset values to the factory default settings.



OSD warning messages

When the monitor does not support a particular resolution mode, you can see the following message:

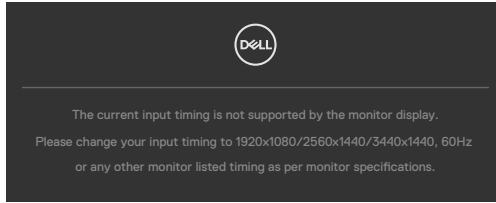

This means that the monitor cannot synchronize with the signal that it is receiving from the computer. See [Monitor Specifications](#) for the Horizontal and Vertical frequency ranges addressable by this monitor. Recommended mode is **1920 x 1080 (C2422HE) / 2560 x 1440 (C2722DE) / 3440 x 1440 (C3422WE)**.

You can see the following message before the DDC/CI function is disabled:

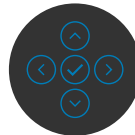
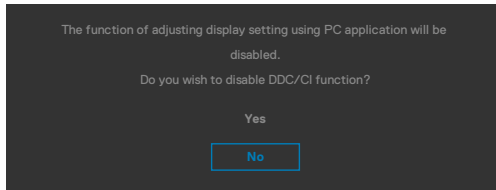

When the monitor enters the **Standby** mode, the following message will appear:

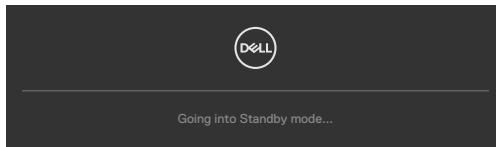

Activate the computer and wake up the monitor to gain access to the **OSD**.



If you press any button other than the power button, the following messages will appear depending on the selected input:

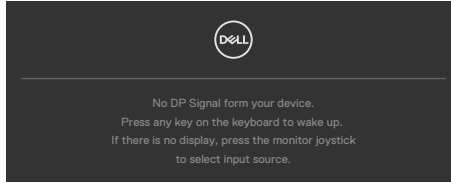

A message is displayed while the cable supporting DP alternate mode is connected to the monitor under the following conditions:

- When Auto Select for **USB-C**  **90 W** is set to **Prompt for Multiple Inputs**.
- When the USB-C cable is connected to the monitor.

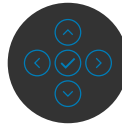
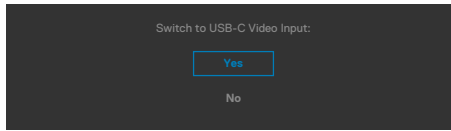

Select OSD items of **Factory Reset** in Other feature, the following message will appear:

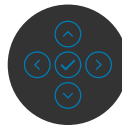
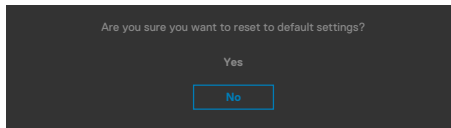

When you select 'Yes' to reset to default settings, the following message will appear:

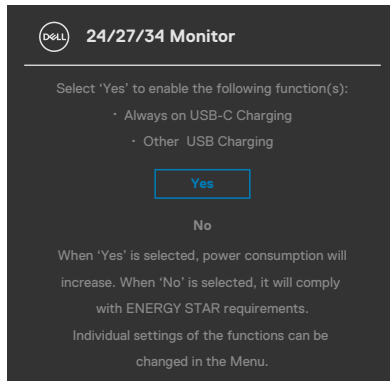

Select OSD items of **On in Standby Mode**  in Personalize feature, the following message will appear:

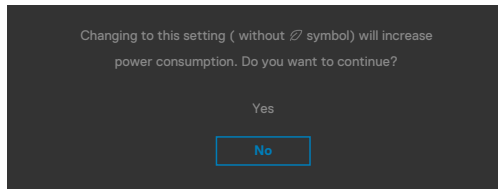

If adjust the Brightness level above the default level over 75%, the following message will appear:

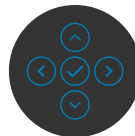
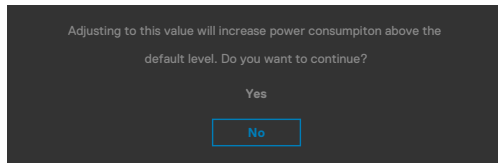

- When user selects "Yes", the power message is displayed only once.
- When user select 'No', the power warning message will pop-up again.
- The power warning message will appear again only when the user does a Factory Reset from the OSD menu.



If either USB Type-C / DP / HDMI input is selected and the corresponding cable is not connected, a floating dialog box as shown below appears.

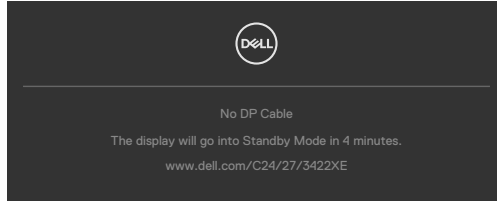

or

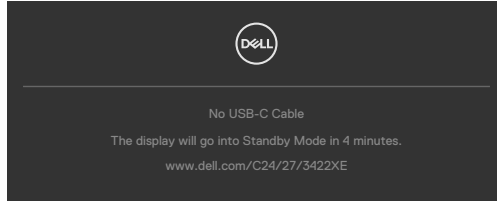

or

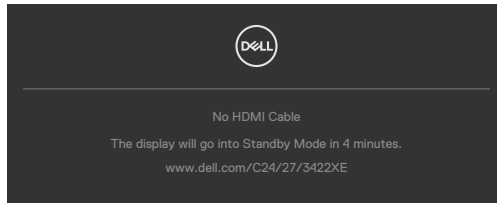

When the webcam module **pop out**, the the following message will appear:

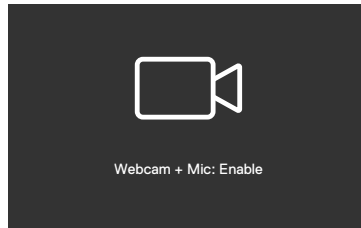

When the webcam module **pop in** (retracted), the following message will appear:

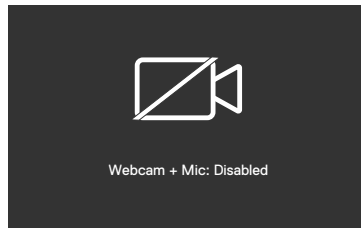

If the webcam is **pop in** (retracted) and you press the **Mute** button, the following message will appear:

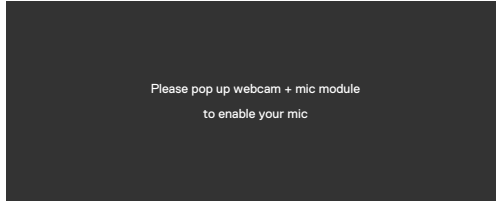

When the USB upstream cable is not connected, and you press the **Teams/ Hookswitch/ Mute** button, the following message will appear:



 **NOTE: For the Teams/ Hookswitch/ Volume down/ Volume up/ Mute buttons to work, you need to connect the USB upstream cable (Type-A to Type-B or Type-C to Type-C) from the PC to the monitor.**

See [Troubleshooting](#) for more information.



Setting the maximum resolution

To set the maximum resolution for the monitor:

In Windows 7, Windows 8 or Windows 8.1:

1. For Windows 8 or Windows 8.1 only, select the Desktop tile to switch to classic desktop. For Windows Vista and Windows 7, skip this step.
2. Right-click on the desktop and click **Screen Resolution**.
3. Click the Dropdown list of the **Screen Resolution** and select **1920 x 1080 (C2422HE) / 2560 x 1440 (C2722DE) / 3440 x 1440 (C3422WE)**.
4. Click **OK**.

In Windows 10:

1. Right-click on the desktop and click **Display Settings**.
2. Click **Advanced display settings**.
3. Click the dropdown list of **Resolution** and select **1920 x 1080 (C2422HE) / 2560 x 1440 (C2722DE) / 3440 x 1440 (C3422WE)**.
4. Click **Apply**.

If you do not see **1920 x 1080 (C2422HE) / 2560 x 1440 (C2722DE) / 3440 x 1440 (C3422WE)** as an option, you may need to update your graphics driver.

Depending on your computer, complete one of the following procedures:

If you have a Dell desktop or portable computer:

- Go to <https://www.dell.com/support>, enter your service tag, and download the latest driver for your graphics card.

If you are using a non-Dell computer (laptop or desktop):

- Go to your computer manufacturer's support website and download the latest graphic drivers.
- Go to your graphics card manufacturer's website and download the latest graphic drivers.



Setting the KVM USB Switch

To set the KVM USB Switch as Shortcut Key for the monitor:

1. Press the joystick button to launch the OSD main menu.
2. Move the joystick to select **Personalize**.

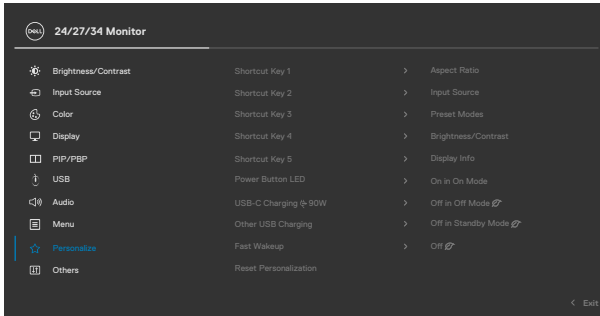

3. Move the joystick right to activate the highlighted option.
4. Move the joystick right to activate the **Shortcut Key 1** option.
5. Move the joystick up or down to select **USB Switch**.

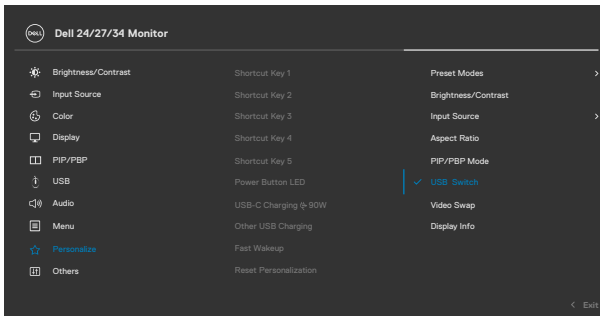

6. Press the joystick to confirm selection.

 **NOTE: KVM USB Switch function only work under PBP Mode (Only for C3422WE).**



The following are illustrations of several connection scenarios and their USB Selection menu settings, as illustrated in corresponding color frames.

1. When connecting **HDMI + USB-B** to computer 1 and **DP + USB A to C** to computer 2:

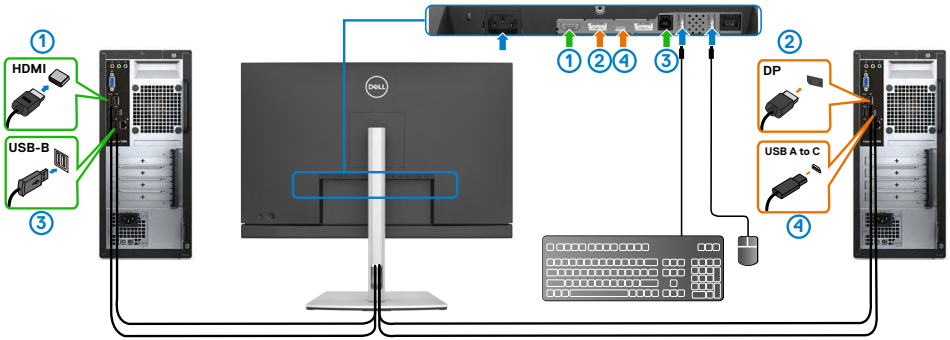

NOTE: The USB Type-C connection currently supports only data transfer.
Ensure USB Selection for **HDMI** is set to **USB-B** and **DP** is set to **USB-C 90 W**.

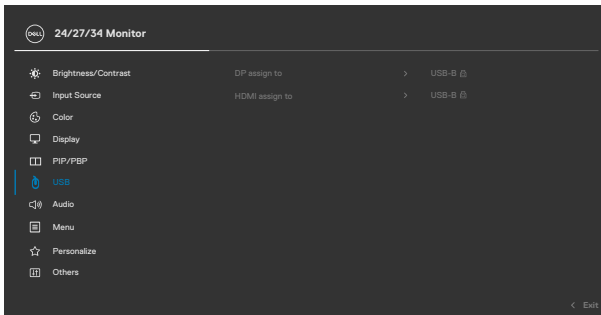

2. When connecting **HDMI + USB-B** to computer 1 and **USB Type-C** to computer 2:

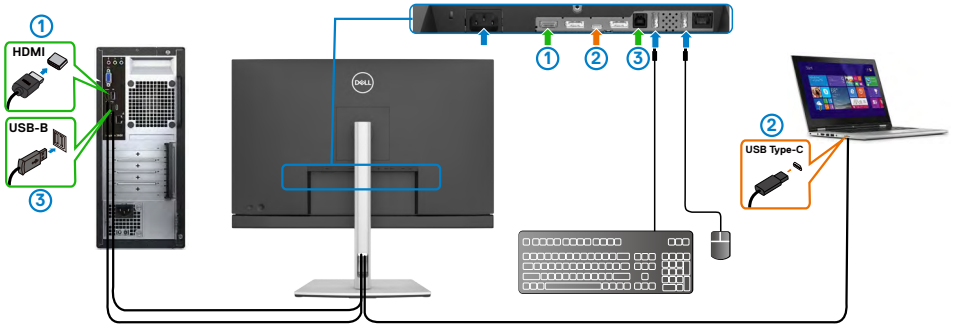

NOTE: The USB Type-C connection currently supports video and data transfer.

Ensure **USB Selection** for **HDMI** is set to **USB-B**.

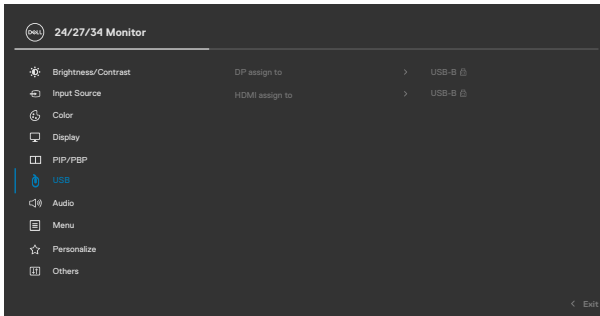

NOTE: As the USB Type-C port supports the DisplayPort Alternate Mode, there is no need to set USB Selection for USB Type-C.

NOTE: When connecting to different video input sources not shown above, follow the same method to make correct settings for USB Selection to pair the ports.



Setting the Auto KVM

You can follow below instruction to set up Auto KVM for your monitor:

1. Ensure that **PIP/PBP Mode** is **Off**.

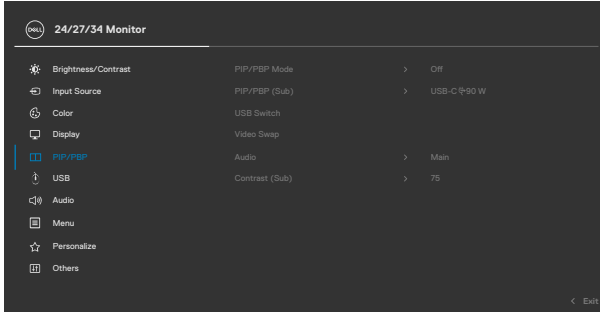

NOTE: This PIP/PBP function is for C3422WE only.

2. Ensure that **Auto Select** is **On** and **Auto Select for USB-C** is **Yes**.

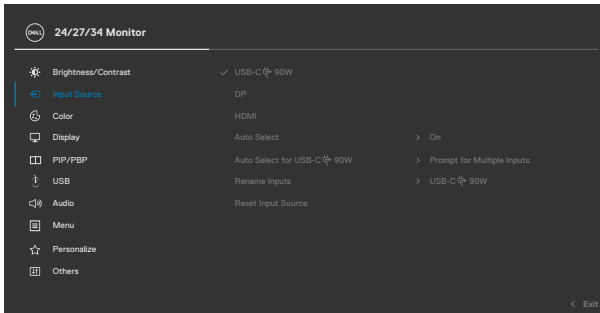

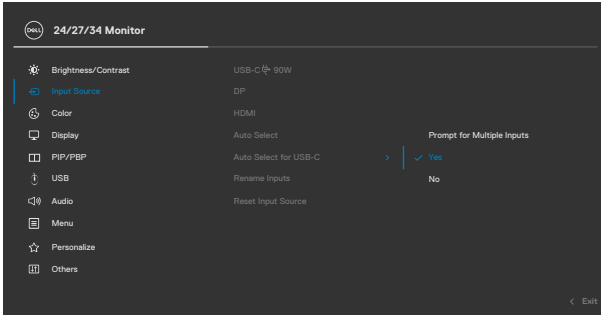

3. Ensure that the USB ports and the video inputs are paired accordingly.

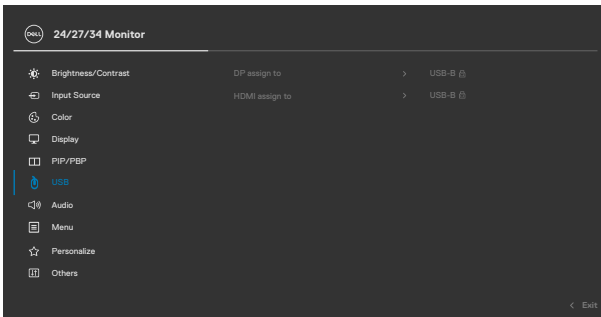

NOTE: For USB Type-C connection, there is no further setting required.



Setting up Windows Hello

In Windows® 10:

Click Windows start menu, click **Settings**.

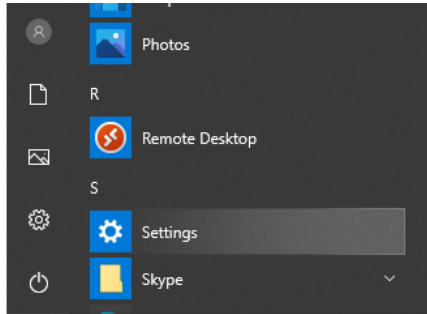

Click **Accounts**.

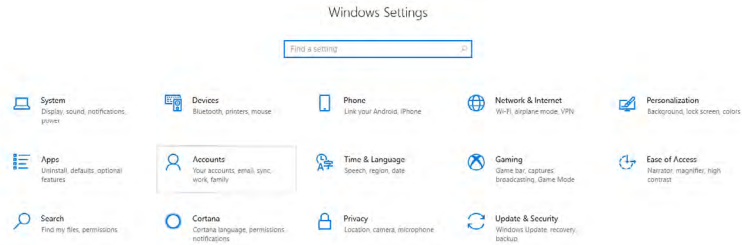

Click **Sign-in options**. You must set up a PIN before you can enroll in Windows Hello.

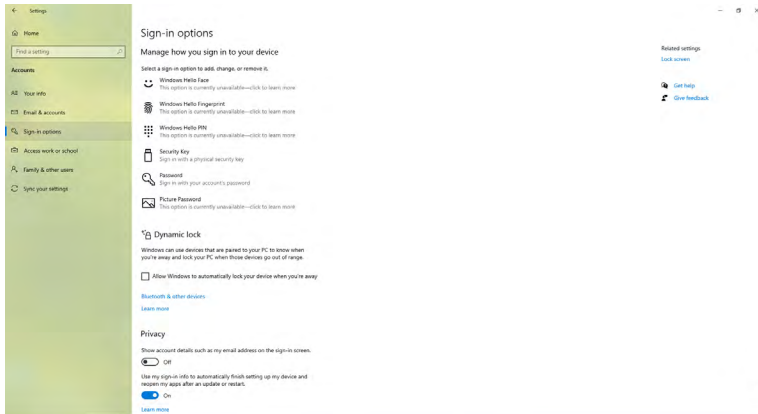

Click **Add** under **PIN** enter to **Set up a PIN**. Enter New PIN and Confirm PIN, and then click **OK**.

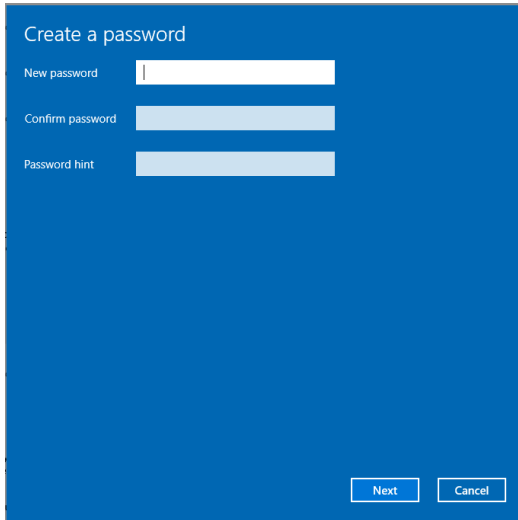

Once you've done that, the options to set up Windows Hello will unlock. Click **Set up** under **Windows Hello**, enter to **Windows Hello setup**.

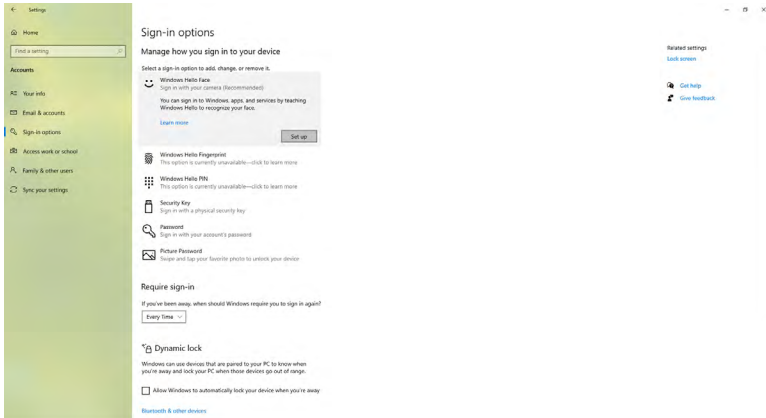

The following message is displayed, click **Get started**.

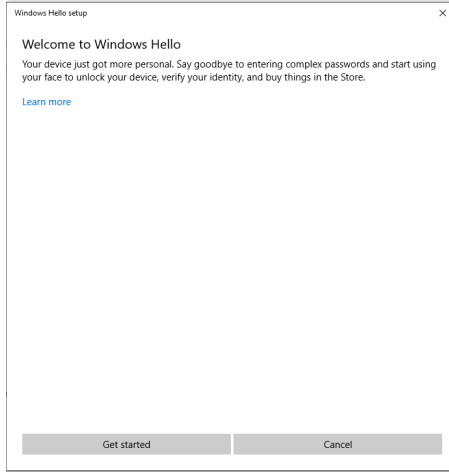

Keep looking directly at your screen and position yourself so that your face is in the center of the frame that appears on screen. The webcam will then register your face.

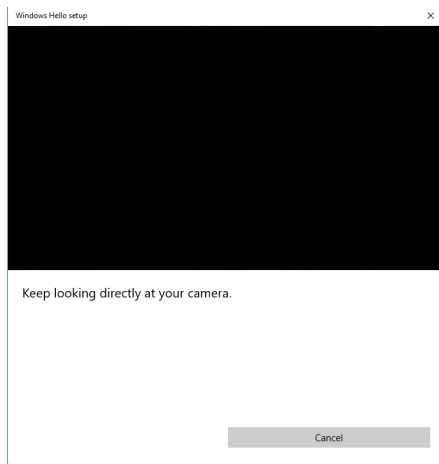

When the following message is displayed, click **Close** to exit **Windows Hello setup**.

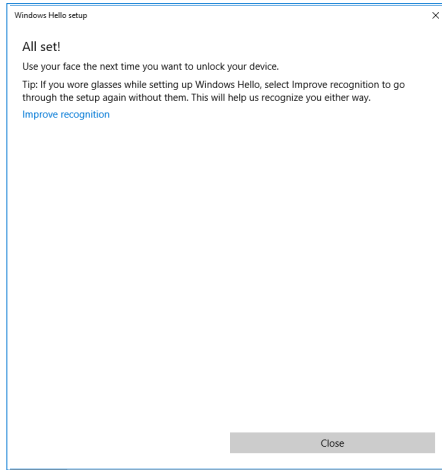

Once you have set up, you have another option to improve the recognition. Click **Improve recognition** if necessary.



Setting up the monitor webcam as default setting

When using a notebook with built-in webcam to connect this monitor, in the device manager interface, you can find the notebook built-in webcam and the monitor webcam. Normally, they are in enable status, and the default setting is using notebook built-in webcam.

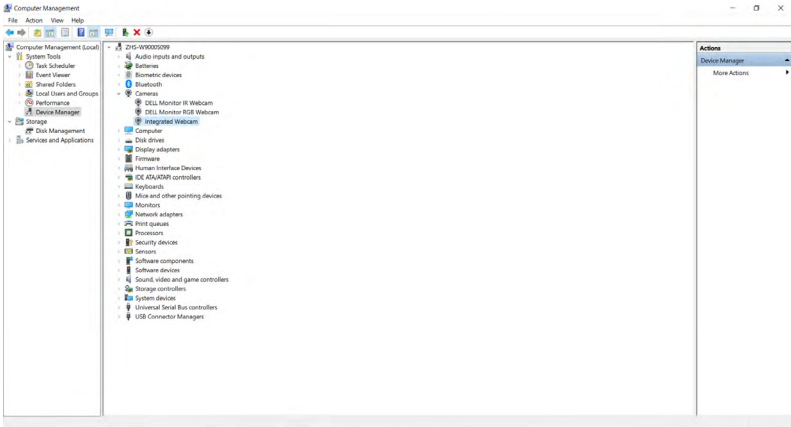

If you want to set up the monitor webcam as default setting, you need disable the notebook built-in webcam. To identify the notebook built-in webcam and disable it, please follow below instructions:

Right-click **Dell Monitor IR Webcam**, and click **Properties** to open the **Dell Monitor IR Webcam Properties**.

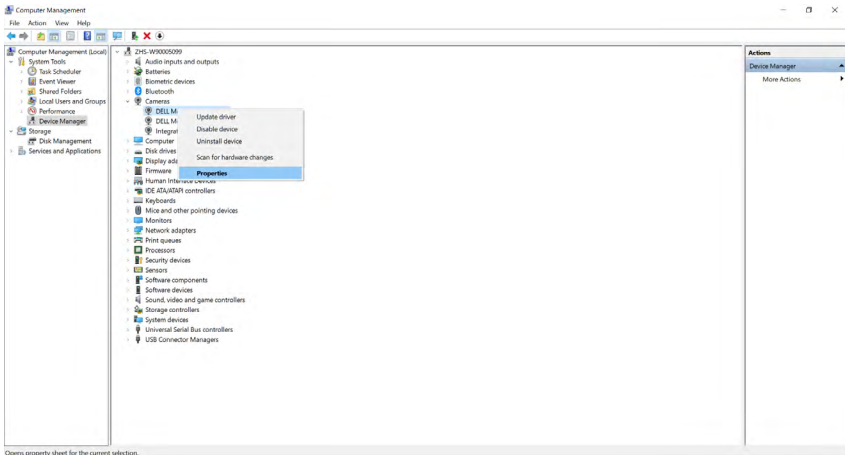

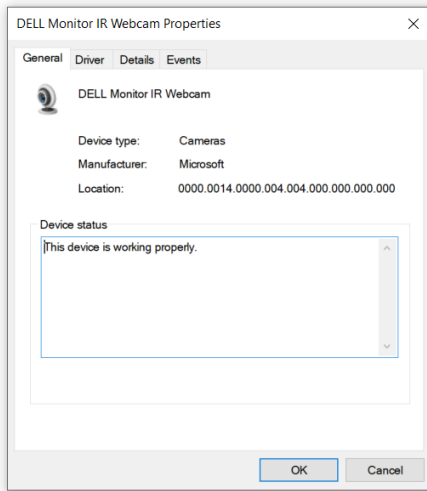

Click **Details > Property** and select **Hardware Ids**.

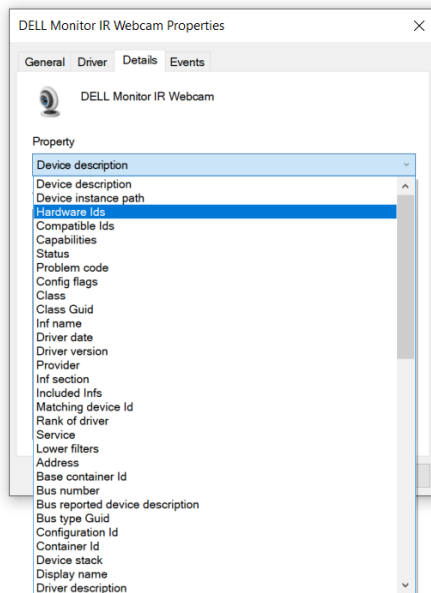

The **Value** will show the detail hardware ids of this Dell Monitor IR Webcam. The hardware ids of the notebook built-in webcam and the monitor webcam are different. For C2422HE/C2722DE/C3422WE, the monitor webcam hardware ids will show as below:

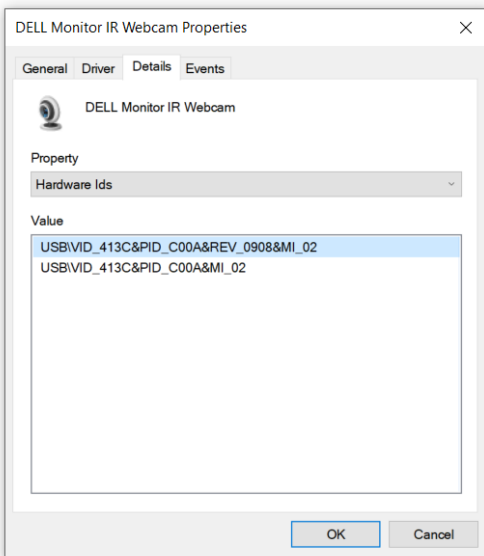

Right click the **PC/Notebook** webcam which has different hardware ids , and then click **Disable**.

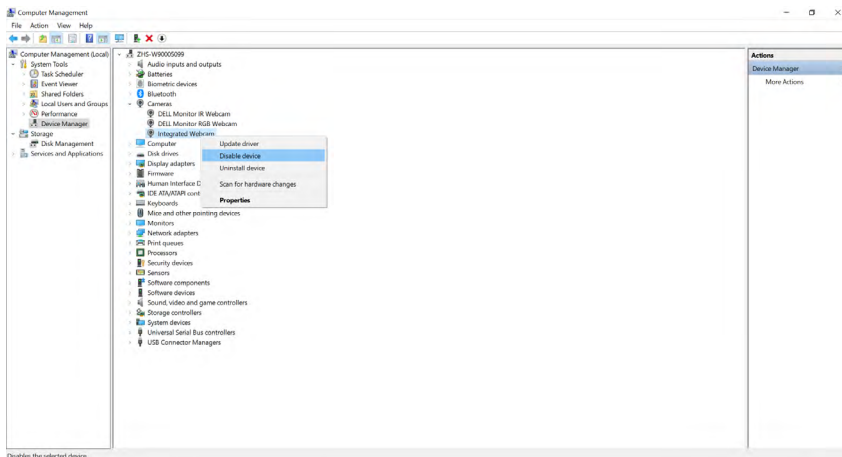

The following message is displayed:

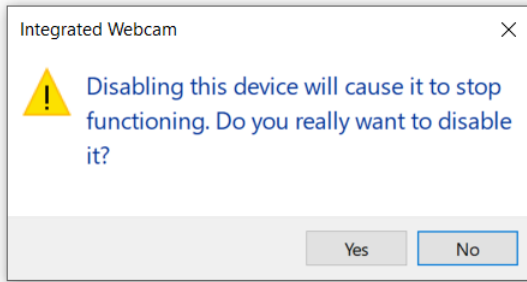

Click Yes. The notebook webcam is now disabled and the monitor webcam will be used as the default setting. Restart the notebook.

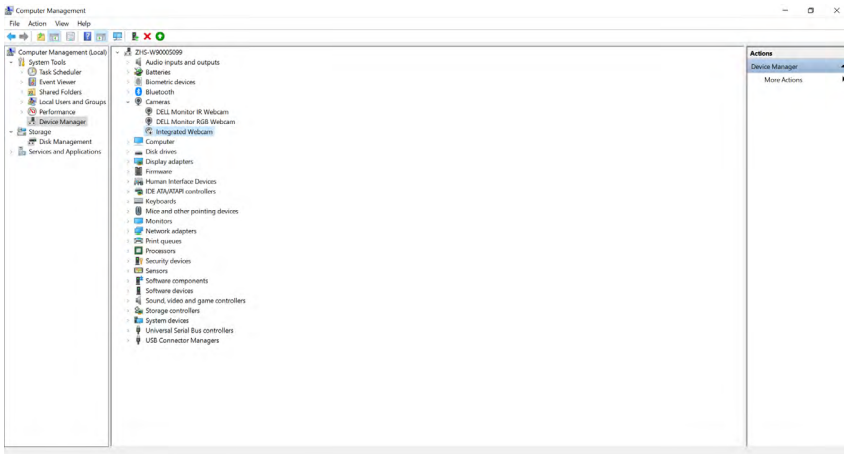

Setting up the monitor speaker as default setting

When your computer connects multiple speakers, if you want to set up the monitor speaker as default setting, please follow below instructions:

Right-click **Volume** in the Windows task bar notification area.



Click **Playback devices** enter to **Sound** setting interface.

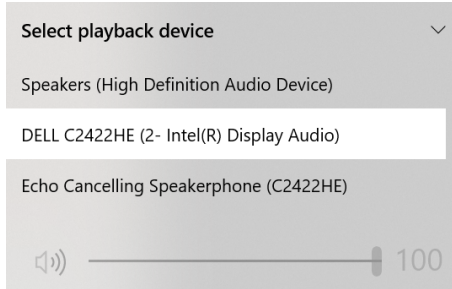

If only the HDMI or DP cable is connected from your monitor to the computer, only one speaker named **DELL C2422HE/C2722DE/C3422WE** from the monitor will show in the **Sound** setting interface.

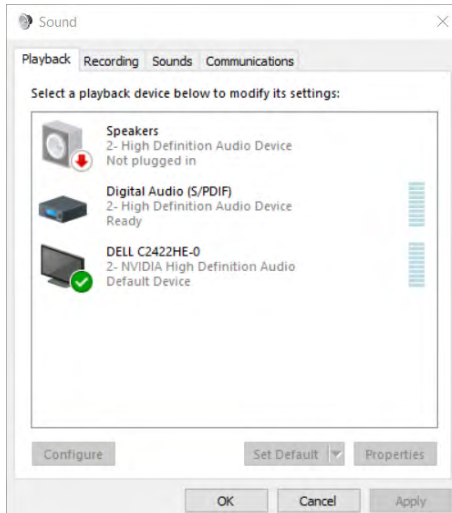

Click **DELL C2422HE/C2722DE/C3422WE**, and then click **Set Default**, the monitor speaker will be used as the default setting.

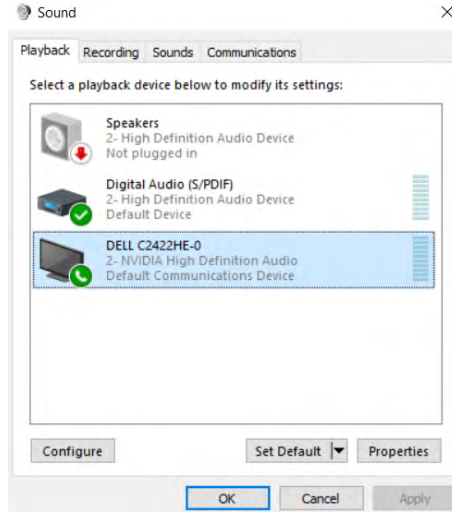

Click **OK** to exit the **Sound** setting.

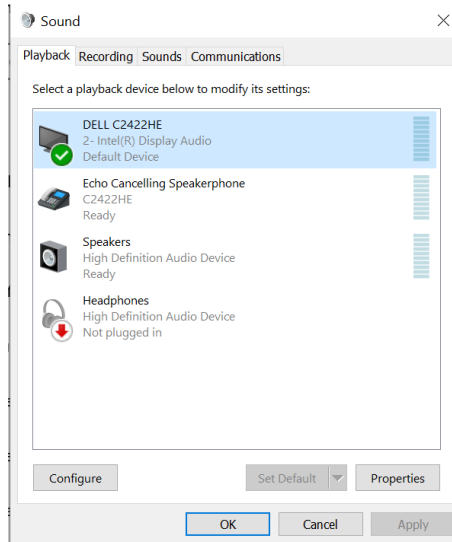

If the USB cable and the HDMI or DP cable are connected from monitor to the computer, two audio paths named **DELL C2422HE/C2722DE/C3422WE** and **Echo Cancelling Speakerphone (C2422HE/C2722DE/C3422WE)** from the monitor will show in the **Sound** setting interface. The **C2422HE/C2722DE/C3422WE** monitor would show options for two audio paths supported in the monitor.



- **Echo Cancelling Speakerphone (C2422HE/C2722DE/C3422WE)** audio path is where audio streams through USB. This is either through USB-C to USB-C cable or USB-A to USB-B cable. As the microphone path streams from monitor back to PC through USB, this selection is required for VoIP/UC conference applications. Audio Recording and Playback will work under this selection.
- **DELL C2422HE/C2722DE/C3422WE** audio path is where audio streams through HDMI/ DP/ DP alternate mode. Under this selection, there will not be microphone support. This selection is suitable for Audio Playback only.

Audio Playback performance would be the same for either audio path selection. Under normal Playback with USB-C to USB-C/USB-A to USB-B and/or for UC conference applications, default selecting the **Echo Cancelling Speakerphone (C2422HE/C2722DE/C3422WE)** audio path is recommended.

NOTE: If you select **DELL C2422HE/C2722DE/C3422WE** audio path, please ensure that the **Echo Cancelling Speakerphone (C2422HE/C2722DE/C3422WE)** volume is set to medium or high. Else, the **DELL C2422HE/C2722DE/C3422WE** maximum volume may sound soft because it is limited by the **Echo Cancelling Speakerphone (C2422HE/C2722DE/C3422WE)** volume. For example, when the **Echo Cancelling Speakerphone (C2422HE/C2722DE/C3422WE)** volume is at 50%, and the **DELL C2422HE/C2722DE/C3422WE** volume is set to 100% will have the same sound level as the former.

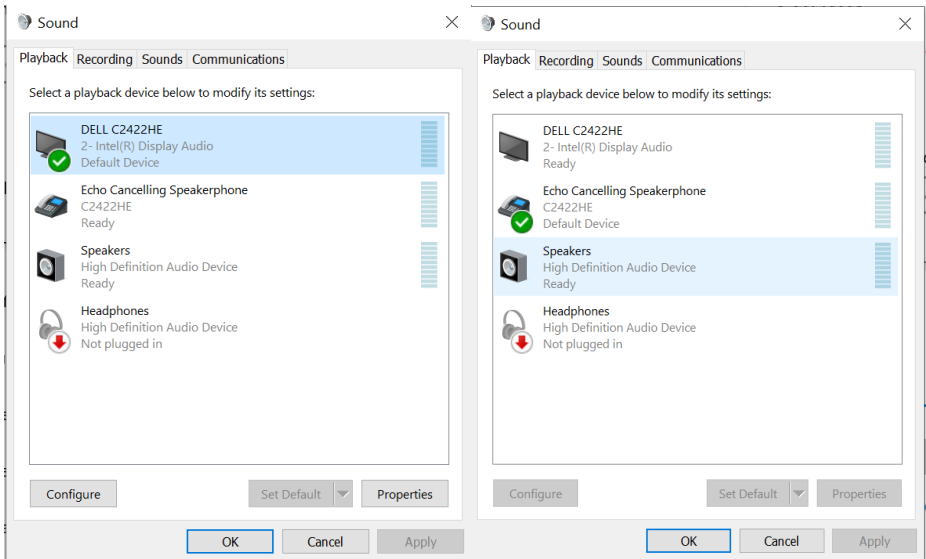

Troubleshooting

⚠ WARNING: Before you begin any of the procedures in this section, follow the **Safety Instructions**.

Self-test

Your monitor provides a self-test feature that allows you to check whether your monitor is functioning properly. If your monitor and computer are properly connected but the monitor screen remains dark, run the monitor self-test by performing the following steps:

1. Turn off both your computer and the monitor.
2. Unplug the video cable from the back of the computer. To ensure proper Self-Test operation, remove all digital and the analog cables from the back of computer.
3. Turn on the monitor.

The floating dialog box should appear on-screen (against a black background), if the monitor cannot sense a video signal and is working correctly. While in self-test mode, the power LED remains white. Also, depending upon the selected input, one of the dialogs shown below will continuously scroll through the screen.

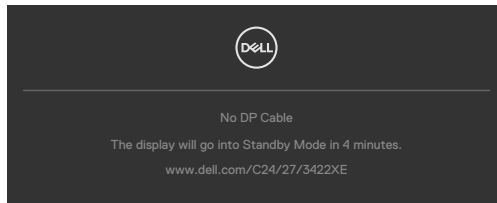

OR

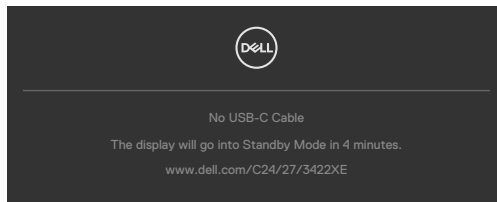

4. This box also appears during normal system operation if the video cable becomes disconnected or damaged.
5. Turn off your monitor and reconnect the video cable; then turn on both your computer and the monitor.

If your monitor screen remains blank after you use the previous procedure, check your video controller and computer, because your monitor is functioning properly.



Built-in diagnostics

Your monitor has a built-in diagnostic tool that helps you determine if the screen abnormality you are experiencing is an inherent problem with your monitor, or with your computer and video card.



To run the built-in diagnostics:

1. Ensure that the screen is clean (no dust particles on the surface of the screen).
2. Press and hold Up or Down or Left or Right direction for four seconds until a menu appears on the screen.
3. Using the joystick control, highlight the Diagnostics  option and press the joystick button to start the diagnostics. A gray screen is displayed.
4. Observe if the screen has any defects or abnormalities.
5. Toggle the joystick once again until a red screen is displayed.
6. Observe if the screen has any defects or abnormalities.
7. Repeat steps 5 and 6 until the screen displays green, blue, black, and white colors. Note any abnormalities or defects.

The test is complete when a text screen is displayed. To exit, toggle the joystick control again.

If you do not detect any screen abnormalities upon using the built-in diagnostic tool, the monitor is functioning properly. Check the video card and computer.



Common Problems

The following table contains general information about common monitor problems you might encounter and the possible solutions:

Common Symptoms	What you experience	Possible solutions
No Video/ Power LED off	No picture	<ul style="list-style-type: none">• Ensure that the video cable connecting the monitor and the computer is properly connected and secure.• Verify that the power outlet is functioning properly using any other electrical equipment.• Ensure that the power button is depressed fully.• Ensure that the correct input source is selected in the Input Source menu.
No Video/ Power LED on	No picture or no brightness	<ul style="list-style-type: none">• Increase brightness and contrast controls via OSD.• Perform monitor self-test feature check.• Check for bent or broken pins in the video cable connector.• Run the built-in diagnostics.• Ensure that the correct input source is selected in the Input Source menu.
Missing Pixels	LCD screen has spots	<ul style="list-style-type: none">• Cycle power on-off.• Pixel that is permanently off is a natural defect that can occur in LCD technology.• For more information on Dell Monitor Quality and Pixel Policy, see Dell Support site at: https://www.dell.com/pixelguidelines.
Stuck-on Pixels	LCD screen has bright spots	<ul style="list-style-type: none">• Cycle power On-Off.• Pixel that is permanently off is a natural defect that can occur in LCD technology.• For more information on Dell Monitor Quality and Pixel Policy, see Dell Support site at: https://www.dell.com/pixelguidelines.
Brightness Problems	Picture too dim or too bright	<ul style="list-style-type: none">• Reset the monitor to factory settings.• Adjust brightness and contrast controls via OSD.



Common Symptoms	What you experience	Possible solutions
Safety Related Issues	Visible signs of smoke or sparks	<ul style="list-style-type: none"> • Do not perform any troubleshooting steps. • Contact Dell immediately.
Intermittent Problems	Monitor malfunctions on & off	<ul style="list-style-type: none"> • Ensure that the video cable connecting the monitor to the computer is connected properly and is secure. • Reset the monitor to factory settings. • Perform monitor self-test feature check to determine if the intermittent problem occurs in self-test mode.
Missing Color	Picture missing color	<ul style="list-style-type: none"> • Perform monitor self-test. • Ensure that the video cable connecting the monitor to the computer is connected properly and is secure. • Check for bent or broken pins in the video cable connector.
Wrong Color	Picture color not good	<ul style="list-style-type: none"> • Change the settings of the Preset Modes in the Color menu OSD depending on the application. • Adjust R/G/B value under Custom Color in Color menu OSD. • Change the Input Color Format to PC RGB or YPbPr in the Color menu OSD. • Run the built-in diagnostics.
Image retention from a static image left on the monitor for a long period of time	Faint shadow from the static image displayed appears on the screen	<ul style="list-style-type: none"> • Set the screen to turn off after a few minutes of screen idle time. These can be adjusted in Windows Power Options or Mac Energy Saver setting. • Alternatively, use a dynamically changing screensaver.



Common Symptoms	What you experience	Possible solutions
Mic/Webcam does not work	<ul style="list-style-type: none"> • Webcam module not pop up • USB cable not plug in or not select the correct USB source • Not set the monitor Mic/webcam as the default device 	<ul style="list-style-type: none"> • Pop up the webcam module. • Plug in the USB Cable (Type-A to Type-B or Type-C to Type-C), and if you connect both USB-B port and USB-C port, please switch the USB source in the OSD menu. • Select the monitor Mic/webcam as the default in the PC side.

Product specific problems

Problem	What you experience	Possible solutions
Screen image is too small	Image is centered on screen, but does not fill entire viewing area	<ul style="list-style-type: none"> • Check the Aspect Ratio setting in the Display menu OSD. • Reset the monitor to factory settings.
Cannot adjust the monitor with the joystick control on the rear of the monitor	OSD does not appear on the screen	<ul style="list-style-type: none"> • Turn off the monitor, unplug the monitor power cable, plug it back, and then turn on the monitor.
No Input Signal when user controls are pressed	No picture, the LED light is white	<ul style="list-style-type: none"> • Check the signal source. Ensure the computer is not in the power saving mode by moving the mouse or pressing any key on the keyboard. • Check whether the signal cable is plugged in properly. Connect the signal cable again, if necessary. • Reset the computer or video player.



Problem	What you experience	Possible solutions
The picture does not fill the entire screen	The picture cannot fill the height or width of the screen	<ul style="list-style-type: none"> • Due to different video formats (aspect ratio) of DVDs, the monitor may display in full screen. • Run the built-in diagnostics.
No image when using DP connection to the PC	Blank screen	<ul style="list-style-type: none"> • Verify which DP standard (C2422HE/C3422WE:DP 1.1a or DP 1.2)(C2722DE:DP 1.1a or DP 1.4) is your Graphics Card certified to. Download and install the latest graphics card driver. • Some DP 1.1a graphics card cannot support DP 1.2(C2422HE/C3422WE),DP1.4(C2722DE) monitors. Go to OSD menu, under Input Source selection, press and hold DP select joystick key for 8 seconds to change the monitor setting from DP 1.2 to DP 1.1a, DP 1.4 to DP 1.1a
No image when using USB Type-C connection to computer, laptop, and so on	Blank screen	<ul style="list-style-type: none"> • Verify if the USB Type-C interface of the device can support DP alternate mode. • Verify if the device required more than 90 W power charging. • USB Type-C interface of device cannot support DP alternate mode. • Set Windows to Projection mode. • Ensure that the USB Type-C cable is not damaged.
No charging when using USB Type-C connection to computer, laptop, and so on	No charging	<ul style="list-style-type: none"> • Verify if the device can support one of 5 V/9 V/15 V/20 V charging profiles. • Verify if the Notebook requires a >90 W power adaptor. • If the Notebook requires a >90 W power adaptor, it may not charge with the USB Type-C connection. • Ensure that you use only Dell approved adapter or the adapter that comes with the product. • Ensure that the USB Type-C cable is not damaged.



Problem	What you experience	Possible solutions
Intermittent charging when using USB Type-C connection to computer, laptop, and so on	Intermittent charging	<ul style="list-style-type: none"> • Check if the maximum power consumption of device is over 90 W. • Ensure that you use only Dell approved adapter or the adapter that comes with the product. • Ensure that the USB Type-C cable is not damaged.
No image when using USB Type-C MST	Blank screen or 2nd DUT is not Prime mode	<ul style="list-style-type: none"> • USB Type-C input, Go to OSD menu, under Display Info check the Link Rate is HBR2 or HBR3, if Link Rate is HBR2, suggest to use USB Type-C to DP cable to turn on MST.
No network connection	Network dropped or Intermittent	<ul style="list-style-type: none"> • Do not toggle Off/On the power button when network is connected, keeps the power button On.
The LAN port is not functioning	OS setting or cable connection issue	<ul style="list-style-type: none"> • Ensure that the latest BIOS and drivers for your computer are installed on your computer. • Ensure that the RealTek Gigabit Ethernet Controller is installed in the Windows Device Manager. • If your BIOS Setup has a LAN/GBE Enabled/ Disabled option, make sure it is set to Enabled. • Ensure that the Ethernet cable is connected securely on the monitor and the hub/router/ firewall. • Check the status LED of the Ethernet cable to confirm connectivity. Re-connect both ends of the Ethernet cable if the LED is not lit. • First power off the Computer and unplug the Type-C cable and power cord of the monitor. Then, power on the computer, plug in the monitor power cord and Type-C cable.



Problem	What you experience	Possible solutions
Monitor buttons (Mute / Volume down / Volume up / Hookswitch) not working with Microsoft Teams® App	Monitor buttons (Mute / Volume down / Volume up / Hookswitch) not working on Microsoft Teams® App with Chrome OS / Ubuntu	Use Microsoft Teams® App to perform the below tasks: <ul style="list-style-type: none"> • Call Icon to accept / hang up call • Volume down / Volume up adjustment • Mic mute / unmute • Camera on / off
Video recording not working	Video recording App not working with Win 7	<ul style="list-style-type: none"> • Windows 7 not support • Switch to Windows 10
Headset with Mic (3.5mm combo jack) not working with monitor mute / unmute button	Headset with Mic (3.5mm combo jack) not working with monitor mute / unmute button when camera module is pop in (retracted)	<ul style="list-style-type: none"> • Use UC App (e.g. Microsoft Teams, Skype for Business, Zoom, etc.) Mic Icon to mute / unmute
When press either Volume down / Volume up or Mute button, LED not blink	When press either Volume down / Volume up or Mute button, LED not blink when connected to HDMI or DP only	Connect USB-A to USB-B cable
Webcam or Mic not working	Webcam or Mic not working when connected to HDMI or DP only	Connect USB-A to USB-B cable



Problem	What you experience	Possible solutions
Ethernet port (RJ45) cannot connect to internet	Ethernet port (RJ45) cannot connect to internet on Win 10	Change the LAN Controller Power Saving from Enable to Disable
Microphone not working or not detect	Microphone not working or not detect on the Voice recorder App with Intel Gen 11th CPU (Tiger Lake) platform	<ul style="list-style-type: none"> • Disable Intel Smart Sound Technology for USB Audio driver in the Device Manager and re-boot the PC • Alternatively, you may choose to download the C2422HE/C2722DE/C3422WE Monitor firmware version M2T104/M3T104/M2T104 respectively or higher. Go to https://www.dell.com/support
No sound can be heard from recorded video	No sound can be heard from recorded video with Intel Gen 11th CPU (Tiger Lake) platform	<ul style="list-style-type: none"> • Disable Intel Smart Sound Technology for USB Audio driver in the Device Manager and re-boot the PC • Alternatively, you may choose to download the C2422HE/C2722DE/C3422WE Monitor firmware version M2T104/M3T104/M2T104 respectively or higher. Go to https://www.dell.com/support
When press either Volume down/ Volume up, OSD volume bar response is lagging/delayed	When press either Volume down/ Volume up, OSD volume bar response is lagging/delayed with monitor connected to Intel Gen 11th CPU (Tiger Lake) platform	<ul style="list-style-type: none"> • Disable Intel Smart Sound Technology for USB Audio driver in the Device Manager and re-boot the PC • Alternatively, you may choose to download the C2422HE/C2722DE/C3422WE Monitor firmware version M2T104/M3T104/M2T104 respectively or higher. Go to https://www.dell.com/support



Problem	What you experience	Possible solutions
No sound coming from the speakers	No sound coming from the speakers when play audio/video on your system	<ul style="list-style-type: none"> • Ensure that you have set the default playback device as Echo Cancelling Speakerphone (C2422HE/C2722DE/C3422WE) or DELL C2422HE/C2722DE/C3422WE on your system. • Turn Off the monitor, unplug the monitor power cord, replug it, and then turn On the monitor. • Reset the monitor to Factory Settings.
Speaker volume is low / sounds soft	Speaker volume is low / sounds soft when speaker option is DELL C2422HE/C2722DE/C3422WE in Sound setting interface	<ul style="list-style-type: none"> • Increase the speaker volume of DELL C2422HE/C2722DE/C3422WE to maximum in the Sound setting interface • Press the Volume Up button to increase the speaker volume of DELL C2422HE/C2722DE/C3422WE • If you select DELL C2422HE/C2722DE/C3422WE audio path, please ensure that the Echo Cancelling Speakerphone (C2422HE/C2722DE/C3422WE) volume is set to medium or high. Else, the DELL C2422HE/C2722DE/C3422WE maximum volume may sound soft because it is limited by the Echo Cancelling Speakerphone (C2422HE/C2722DE/C3422WE) volume. For example, when the Echo Cancelling Speakerphone (C2422HE/C2722DE/C3422WE) volume is at 50%, and the DELL C2422HE/C2722DE/C3422WE volume is set to 100% will have the same sound level as the former.
Webcam is not detected	Webcam is not detected in the Windows Device Manager	<ul style="list-style-type: none"> • Ensure that the webcam module is popped up. • Ensure that the USB upstream cable is connected between the monitor and the computer or notebook. • Reconnect the USB upstream cable to the computer or notebook.



Problem	What you experience	Possible solutions
Webcam cannot connect / Webcam disconnected	Could not detect Monitor camera / Could not switch back to the PC camera	<ul style="list-style-type: none"> • Reset the monitor to Factory Settings. • Turn Off the monitor, unplug the monitor power cord, replug it, and then turn On the monitor. • Select the Monitor camera again in the Camera / Video setting of your UC conference application.
Microphone is muted	Microphone is muted in the Windows Device Manager	<ul style="list-style-type: none"> • Ensure that the webcam & mic module is popped up. • Ensure that the USB upstream cable is connected between the monitor and the computer or notebook. • Reconnect the USB upstream cable to the computer or notebook. • Ensure that the microphone is enabled/unmuted on the monitor. If the microphone mute LED is lighting up in static red (indicates microphone muted), press the microphone button to unmute the microphone. • Ensure that the monitor's microphone is selected and enabled/unmuted on the setting in the UC application.
Microphone volume is low / sounds soft	Microphone volume is low / sounds soft to the other participant when in audio/video call	<ul style="list-style-type: none"> • Ensure that the webcam module is popped up. The Mute button's LED will go dark (indicates microphone unmuted). • Adjust the distance between the user and the microphone. The user should avoid sitting too far away from the microphone. The most optimum distance between the user and the microphone is 70 cm. • Ensure that the monitor's microphone is selected and enabled/unmuted on the setting in the UC application. • Increase the microphone volume in the Sound setting interface at the PC side / in the UC application.



Problem	What you experience	Possible solutions
Front buttons don't work	No response on the UC application when press on the buttons located on the speaker	<ul style="list-style-type: none"> • Ensure that the USB upstream cable (Type-A to Type-B or Type-C to Type-C) is connected from the PC to the monitor. • Ensure that the webcam module is popped up. • For some UC platforms / applications, the Mute function works by pressing the Mute button, but the Mute Icon on the UC platform is not sync (Icon shows unmute). For more information, see Unified Communications (UC) Platform Compatibility List.
Webcam image looks over-exposed	Webcam image shows over-exposed background	<ul style="list-style-type: none"> • Adjust the environment lighting condition. Ensure the monitor is setup at a well lighted environment, preferably under ceiling lights. The user should avoid a dim / dark background. The user should avoid direct facing a window with bright sunlight. • Alternatively, you may choose to download the C2422HE/C2722DE/C3422WE Monitor firmware version M2T105/M3T105/M2T105 respectively or higher, which improves the auto exposure (AE) feature of the webcam. Go to https://www.dell.com/support.
Webcam image looks grainy / dark	Webcam image appears grainy / dark	<ul style="list-style-type: none"> • Adjust the environment lighting condition. Ensure the monitor is setup at a well lighted environment, preferably under ceiling lights. The user should avoid a dim environment.
Webcam image looks blurry	Webcam image appears blurry / not clear.	<ul style="list-style-type: none"> • Peel off the transparent protective film which originally stucked on the front of the webcam. • If the protective film is already peeled off, use a clean and slightly damp cloth to wipe the surface of the front webcam. • Adjust the distance between the user and the camera. The user should avoid sitting too far away from the camera. The most optimum distance between the user and the camera is 70 cm.



Microsoft® Teams® / Skype for Business® specific problems

Problem	What you experience	Possible solutions
The Teams button is not working	Short press on the Teams button does not bring up Teams application to the foreground	<ul style="list-style-type: none"> • Ensure that the USB upstream cable (Type-A to Type-B or Type-C to Type-C) is connected from the PC to the monitor. • Ensure that the Teams application is signed in and is already running at the background. The Teams button's LED will light in static white. • Ensure that the Teams account is provisioned / setup as 'Teams Only' mode. The tenant administrator should enable the account to 'Teams Only' mode. • Teams button will only work with Teams application in 'Teams Only' mode. Setting might vary in corporate environment, resulting in Teams button not working on the monitor. Please check with your system administrator.
The Hookswitch button is not working	Short press on the Hookswitch button does not answer call	<ul style="list-style-type: none"> • Ensure that the USB upstream cable (Type-A to Type-B or Type-C to Type-C) is connected from the PC to the monitor. • Ensure that the Teams account is provisioned / setup as 'Teams Only' mode. The tenant administrator should enable the account to 'Teams Only' mode.
The Mute button is not working	Press on the Mute button does not mute and unmute microphone	<ul style="list-style-type: none"> • Ensure that the USB upstream cable (Type-A to Type-B or Type-C to Type-C) is connected from the PC to the monitor. • Ensure that the webcam module is popped up. The Mute button's LED will go dark (indicates microphone unmuted). • Ensure that the Teams account is provisioned / setup as 'Teams Only' mode. The tenant administrator should enable the account to 'Teams Only' mode.
Webcam no image	Webcam no image when using Skype for Business (SfB)	<ul style="list-style-type: none"> • Ensure that the webcam module is popped up. • Select 'DELL Monitor RGB Webcam' as the camera in Skype Video Device setting.



Problem	What you experience	Possible solutions
Webcam being occupied	Webcam being occupied and can't be used	<ul style="list-style-type: none">· Ensure that the webcam module is popped up.· Avoid running multiple conference softwares at the same time. While you are using 'conference software A', close the other 'conference software B'.



Universal Serial Bus (USB) specific problems

Specific Symptoms	What you experience	Possible solutions
USB interface is not working	USB peripherals are not working	<ul style="list-style-type: none">• Check that your display is turned ON.• Reconnect the upstream cable to your computer.• Reconnect the USB peripherals (downstream connector).• Turn off the monitor and turn it on again.• Reboot the computer.• Certain USB devices such as portable hard drives require higher power source; connect the drive to the computer directly.
super speed USB 3.2 Gen 1 interface is slow.	super speed USB 3.2 Gen 1 peripherals working slowly or not working at all	<ul style="list-style-type: none">• Check that your computer is USB 3.0-capable.• Some computers have USB 3.0, USB 2.0, and USB 1.1 ports. Ensure that the correct USB port is used.• Reconnect the upstream cable to your computer.• Reconnect the USB peripherals (downstream connector).• Reboot the computer.
Wireless USB peripherals stop working when a USB 3.0 device is plugged in	Wireless USB peripherals responding slowly or only working as the distance between itself and its receiver decreases	<ul style="list-style-type: none">• Increase the distance between the USB 3.0 peripherals and the wireless USB receiver.• Position your wireless USB receiver as close as possible to the wireless USB peripherals.• Use a USB-extender cable to position the wireless USB receiver as far away as possible from the USB 3.0 port.
USB is not working	No USB functionalities	Refer to input source and USB pairing table.



Appendix

FCC notices (U.S. only) and other regulatory information

For FCC notices and other regulatory information, see the regulatory compliance website located at https://www.dell.com/regulatory_compliance.

Contacting Dell

For customers in the United States, call 800-WWW-DELL (800-999-3355).

 **NOTE: If you do not have an active Internet connection, you can find contact information on your purchase invoice, packing slip, bill, or Dell product catalog.**

Dell provides several online and telephone-based support and service options. Availability varies by country and product, and some services may not be available in your area.

To get online Monitor support content:

See <https://www.dell.com/support/monitors>.

To contact Dell for sales, technical support, or customer service issues:

1. Go to <https://www.dell.com/support>.
2. Verify your country or region in the Choose A Country/Region drop-down menu at the bottom-right corner of the page.
3. Click Contact Us next to the country dropdown.
4. Select the appropriate service or support link based on your need.
5. Choose the method of contacting Dell that is convenient for you.

EU product database for energy label and product information sheet

C2422HE: <https://eprel.ec.europa.eu/qr/394427>

C2422HE WOST: <https://eprel.ec.europa.eu/qr/420518>

C2722DE: <https://eprel.ec.europa.eu/qr/394149>

C3422WE: <https://eprel.ec.europa.eu/qr/402022>

