

## 1. Disassembly Procedures

**S1** Turn off the monitor.

**S2** To remove the stand:

Place the monitor on a soft cloth or cushion

Press and hold the stand release button

Press and lift the cover latch to release and remove the cover

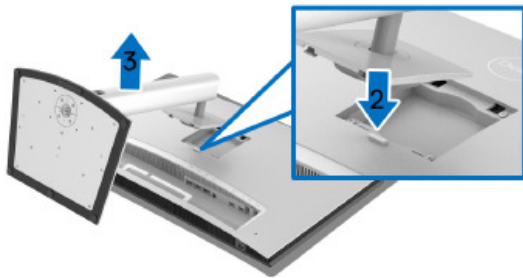

**S3** Unlock 2 RC base screws and 4 RC screws to disassemble Rear Cover



(Screw Torque:  $4.5 \pm 0.5\text{kgf}$ )



(Screw Torque:  $9 \pm 1\text{kgf}$ )

**S4** Use hands or scraper bar and follow the sequence to disassemble Rear Cover from Middle Frame

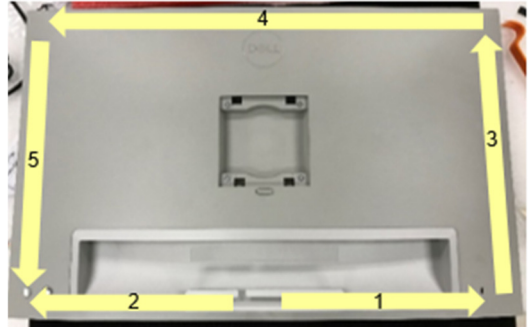

**S5** Disassemble LENS BD from Middle Frame

Unplug CTRL BD FFC from LENS BD

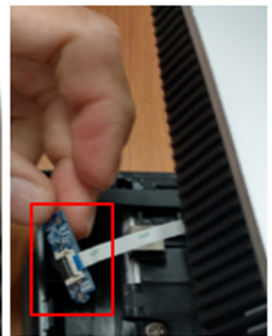
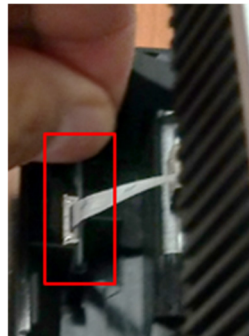

- S6** Tear off "MYLAR SHD VESA" from Main SHD and unplug CTRL FFC from I/F BD

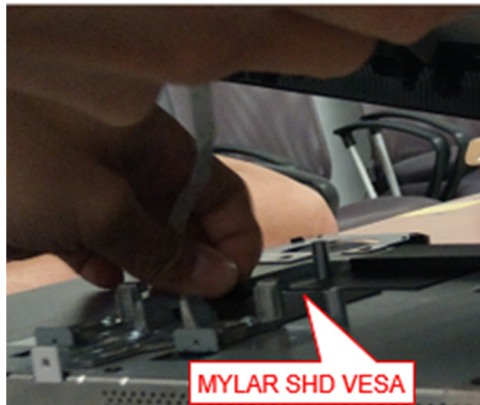

- S7** Tear off "MYLAR SHD SOC" from Main SHD and unplug USB FFC from SOC BD

Take off Rear Cover from Middle Frame

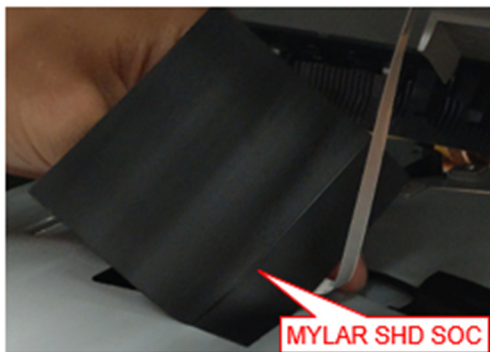

- S8** Tear off an acetate tape from "Mylar SHD MCU" and Middle Frame



- S9** Tear off all mylars from Main SHD

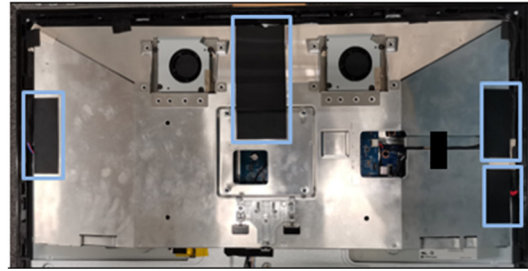

- S10** Tear off an acetate tape from Main SHD (See Green mark)

Tear off 3 conductive tapes from Main SHD to disassemble "SPS BD wire" from Middle Frame (See Orange mark)

Unplug "SPS BD wire" from SPS BD, I/F BD, MCU BD and TBT BD

Unlock screw\*10 to disassemble Main SHD from Panel (See Blue mark)

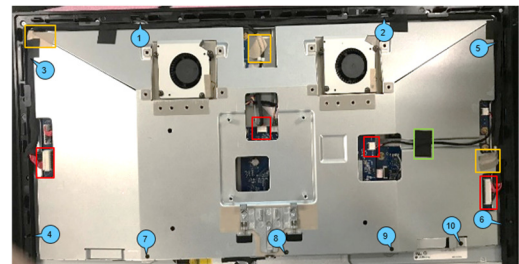

(Screw Torque: 4.0-4.5kgf)

- S11** Unplug FAN wire from I/F BD

Take off Main SHD from Panel

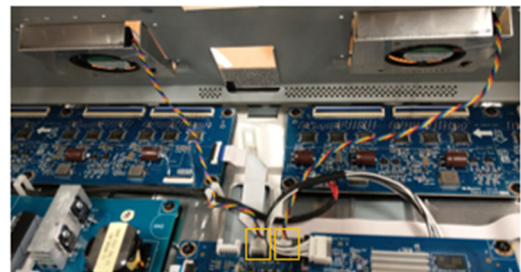

- S12** Tear off 2 yellow tapes from SOC BD

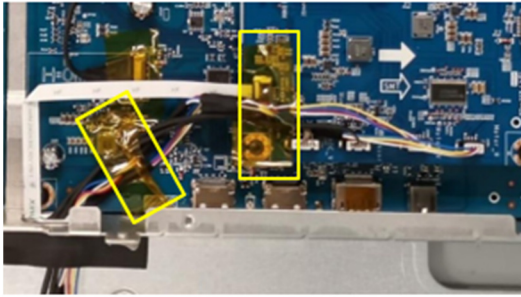

- S13** Unplug "CALIBRATOR FFC" from SOC BD (See Green mark)

Unplug "CALIBRATOR Color Wire" from SOC BD (See Blue mark)

Unplug "CALIBRATOR Black Wire" from SOC BD (See Red mark)

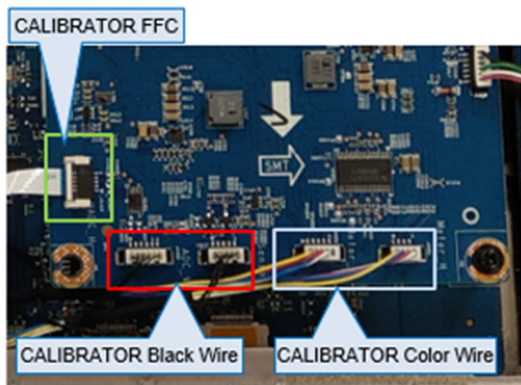

- S14** Tear off the tapes from CALIBRATOR wires and Panel

Take out all CALIBRATOR wires from the hole of Main SHD

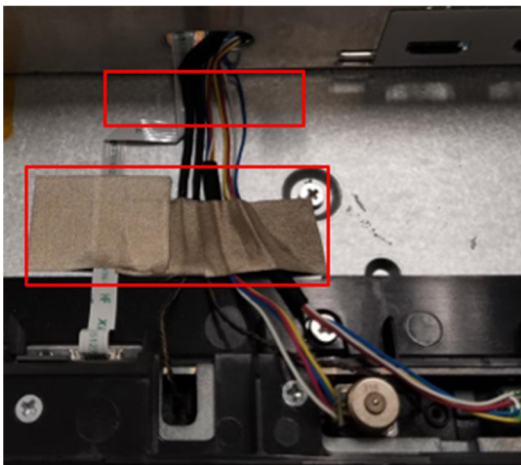

- S15** Tear off "CTRL BD GASKET" and "USB GASKET" from Middle Frame

Unlock MF screws\*13 (See Yellow mark) and TP-S screws\*5 (See White Mark)

Disassemble Middle Frame to Panel

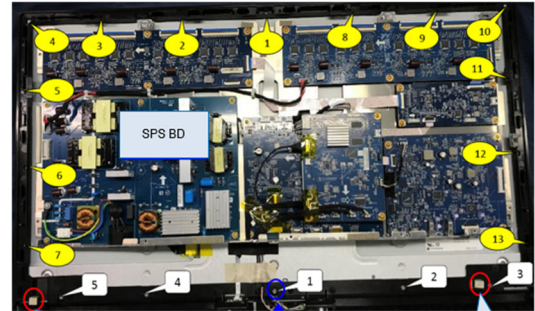

(Screw Torque: 4.0-4.5kgf)

- S16** Unplug "SPS BD to LED DRV BD Wire" from SPS BD and LED DRV BD (See Orange mark)

Disassemble "SPS BD to LED DRV BD Wire" from the clips (See Yellow mark)

Unplug "TBT BD Wire" from "TBT BD" and "SOC BD" (See Blue mark)

Unplug "SOC Backlight wire" from "SOC BD" (See Green mark)

Tear off a yellow tape and unplug "SOC wire" from "SOC BD" (See Purple mark)

Unlock 2 PCBA screws to disassemble "SOC BD" from I/F BD (See Red mark)

Disassemble "Short Spacer" from SOC BD (See Pink mark)

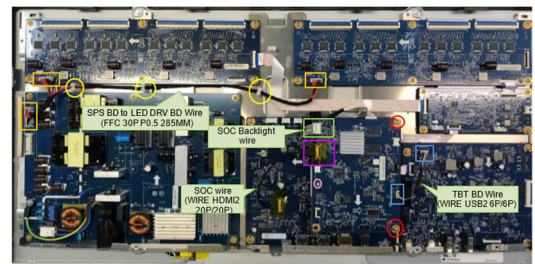

(Screw Torque: 5.0-5.5kgf)

**S17** Unlock 1 grounding screw

Disassemble "AC Wire" from "ASSY BKT PLATE"

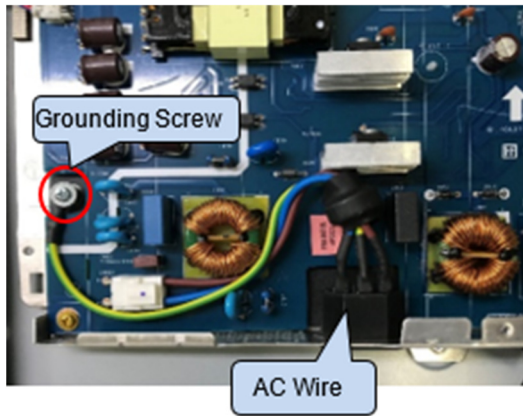

(Screw Torque: 5.0-5.5kgf)

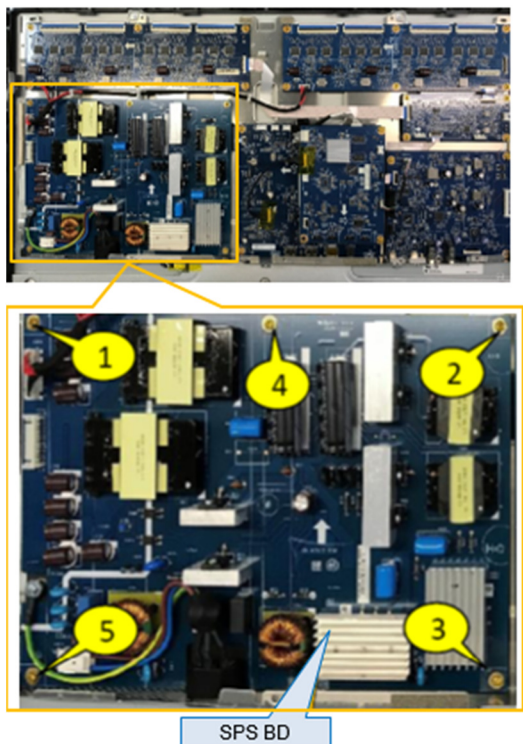
**S18** Unlock PCBA screw\*5 to disassemble SPS BD from "ASSY BKT PLATE"

(Screw Torque: 5.0-5.5kgf)

**S19** Unplug all "Backlight FFC" from LED DRV BD

Unplug "Short FFC 30P" from "LED DRV BD (Right)" and "MCU BD"

Unplug "Long FFC 30P" from "LED DRV BD(Left)" and "MCU BD"

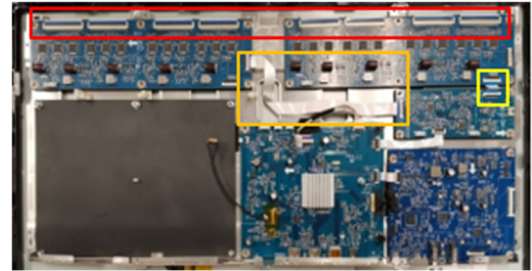
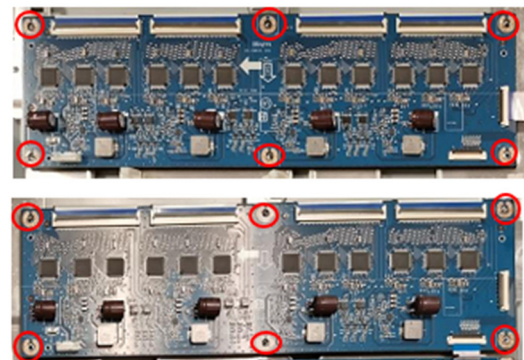
**S20** Unlock PCBA screws\*12 to disassemble 2 "LED Driver BD" from "ASSY BKT PLATE"

(Screw Torque: 5.0-5.5kgf)

**S21** Unplug "MCU BD FFC" from I/F BD and MCU BD

Unlock PCBA screw\*4 to disassemble "MCU BD" from "ASSY BKT PLATE"

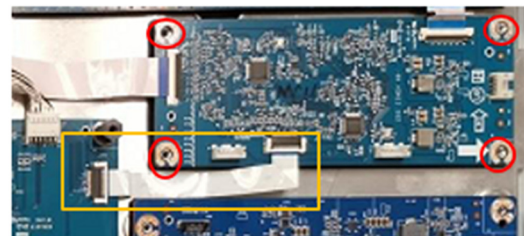

(Screw Torque: 5.0-5.5kgf)

**S22** Tear off a tape from EDP wire and TBT BD

Unplug "TBT BD FFC" and "EDP wire" from "TBT BD"

Unlock PCBA screw\*2 to disassemble "TBT BD" from "ASSY BKT PLATE"



(Screw Torque: 5.0-5.5kgf)

**S23** Tear off a yellow tape from "SOC wire" and I/F BD (See White mark)

Unplug "SOC wire" and "SOC Backlight wire" from I/F BD

Tear off a tape from "EDP FFC" (See Green mark)

Unplug "Thermal Sensor FFC" and "EDP FFC" from I/F BD (See Pink mark)

Disassemble "Spacer" from I/F BD (See Blue mark)

Unlock 2 Bolts (See Orange mark) and 2 PCBA screws (See Red mark) from I/F BD to disassemble I/F BD from "ASSY BKT PLATE"

Tear off a tape from EDP wire and I/F BD (See Yellow mark)

Unplug "TBT BD FFC" and "EDP wire" from I/F BD

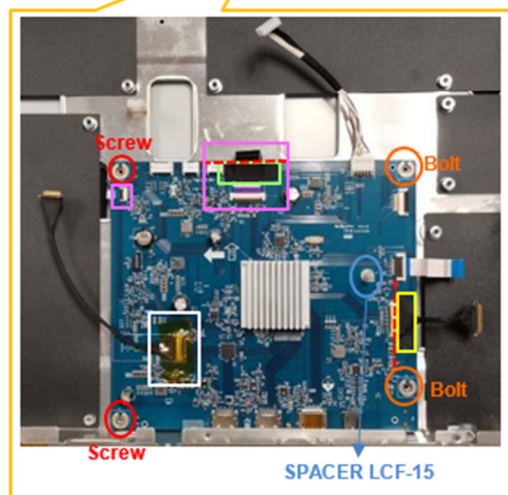
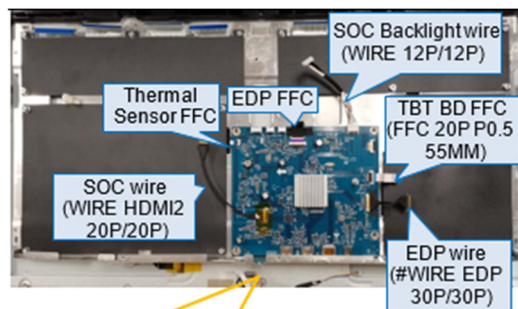

(Screw Torque: 5.0-5.5kgf)

**S24** Unlock screws\*4 to disassemble "ASSY BKT PLATE" from panel

Note:

Insert "Thermal Sensor FFC" and "EDP FFC" through the hole of "ASSY BKT PLATE" while disassembling "ASSY BKT PLATE" from Panel

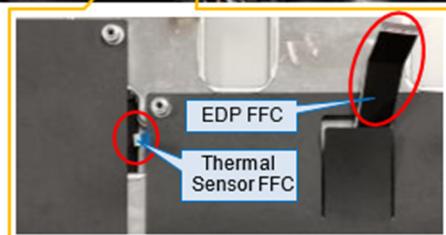
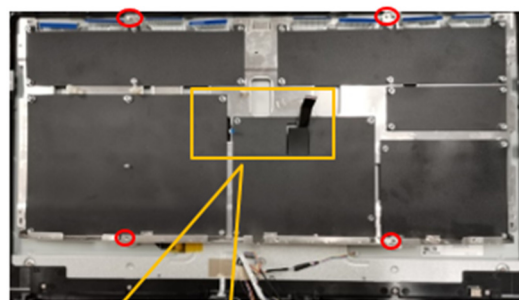

(Screw Torque: 5.0-5.5kgf)

- S25** Tear off two tapes from the lower-left corner and lower-right corner of the panel

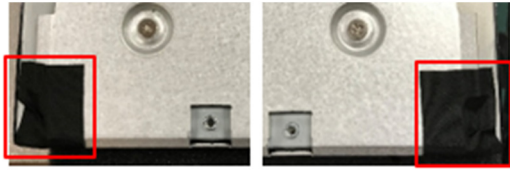

- S26** Tear off a yellow tape from EDP FFC and unplug EDP FFC from panel

Unplug all "Backlight FFC" from panel

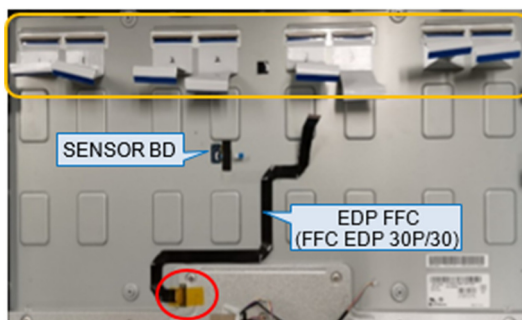

- S27** Tear off a tape from Thermal Sensor FFC

Unplug Thermal Sensor FFC from Thermal Sensor BD and disassemble Thermal Sensor BD from panel



- S28** Tear off tapes and "CTRL BD FFC" from Rear Cover

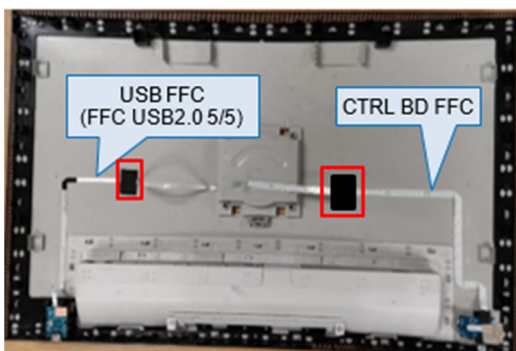

- S29** Unlock screw\*1 to disassemble USB BD from Rear Cover

Unplug "USB FFC" from USB BD



(Screw Torque: 4.0-4.5kgf)

- S30** Tear off a conductive tape from CTRL BD and Rear Cover

Unlock screw\*3 to disassemble CTRL BD from Rear Cover

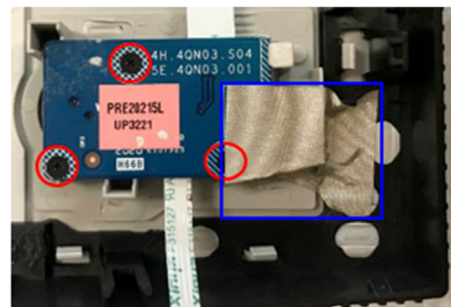

(Screw Torque: 1.2-1.3kgf)

- S31** Tear off 2 tapes from Main SHD

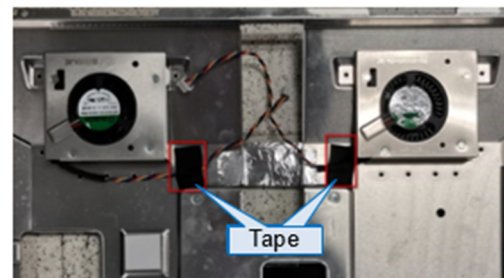

- S32** Take out FAN wire from the hole of Main SHD (See Blue mark)



**S33** Unlock screws\*8 to disassemble FAN from Main SHD

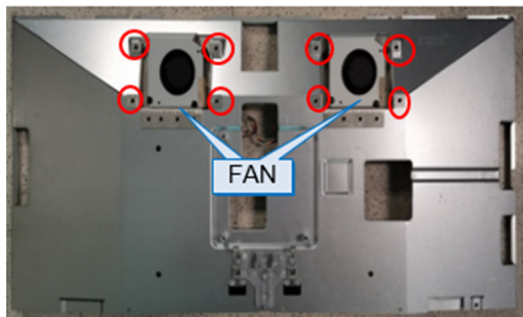

(Screw Torque: 5.0-5.5kgf)

**S34** Disassemble Calibrator Cover from Middle Frame.



**S35** Disassemble "Spring L" and "Spring R" from Calibrator Cover.

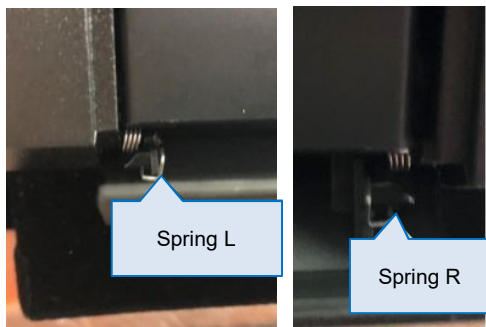

Note: You can use screwdriver to make spring unhook from Calibrator Cover.



**S36** Take off the Calibrator Cover from middle frame.



**S37** Unlock 6 screws to disassemble CALIBRATOR Module from middle frame

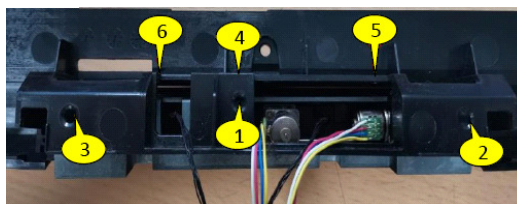

(Screw Torque: 4.5 ±0.5kgf)

**S38** Take off CALIBRATOR Module from Middle Frame

Unplug "CALIBRATOR FFC Cable" from CALIBRATOR module

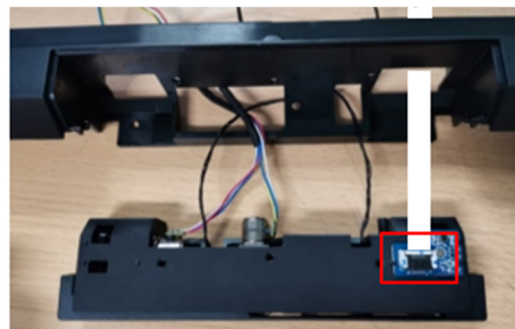

**S39** Disassemble "Spring R" and "Spring L" from Middle Frame

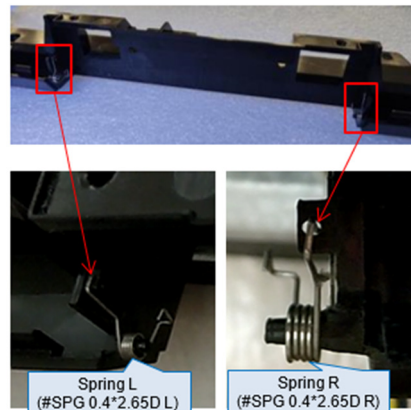

**S40** Remove electrolyte capacitors (red mark) from printed circuit boards

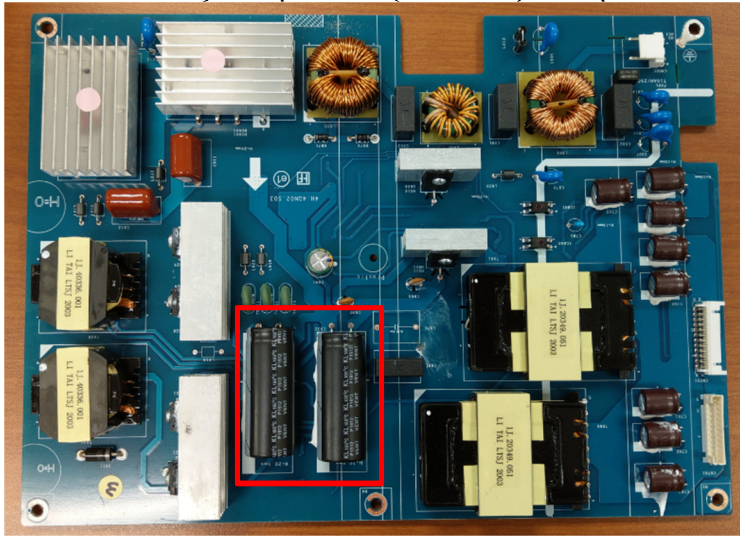

S40-1 Cut the glue between bulk cap. and PCB with a knife

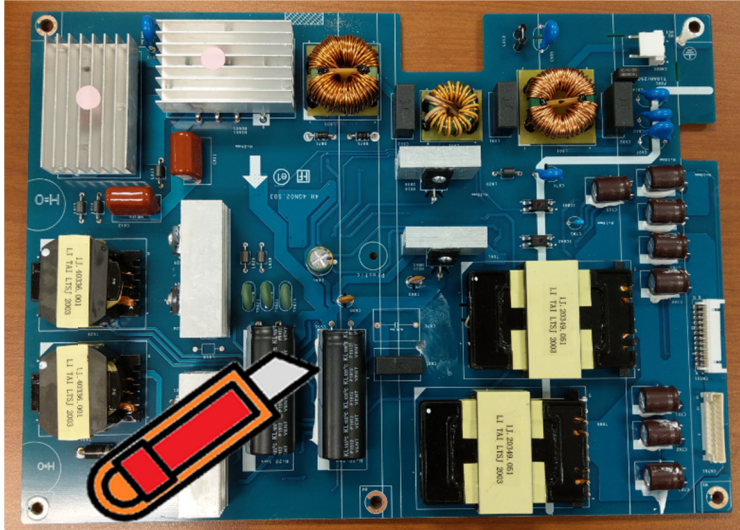

S40-2 Ensure cutting path within the glue, don't touch bulk cap. or PCB

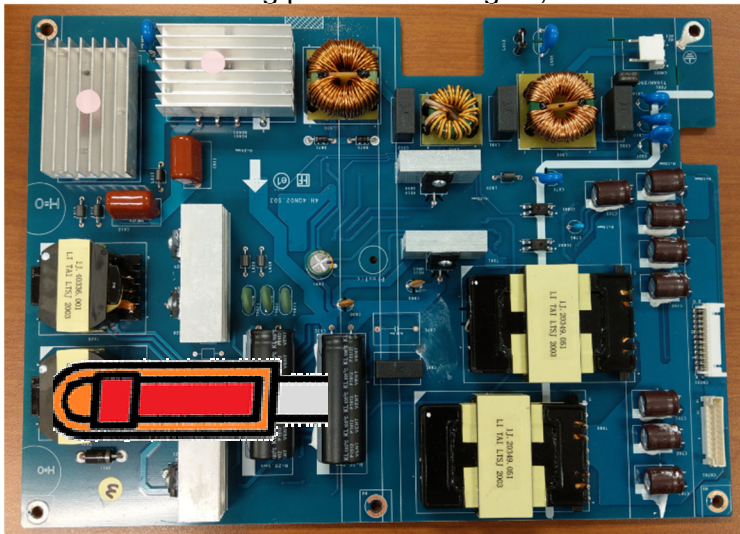



S40-3 Take out bulk cap. pin solder with soldering iron and absorber

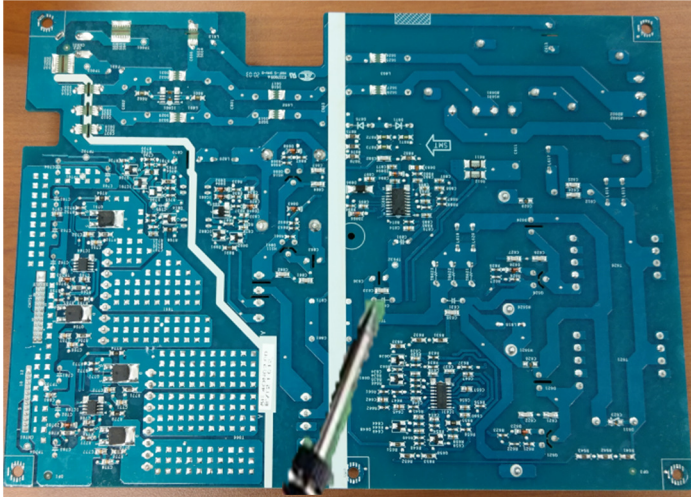

S40-4 Lift the bulk cap. up and away from the PCB

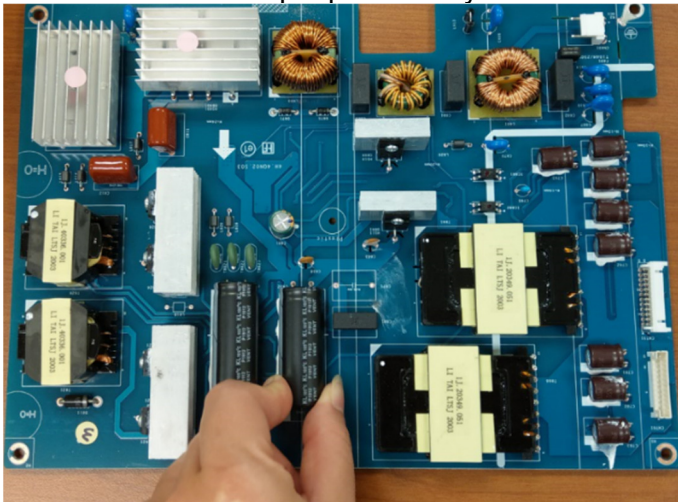

## 2. Product material information

The following substances, preparations, or components should be disposed of or recovered separately from other WEEE in compliance with Article 4 of EU Council Directive 75/442/EEC.

Capacitors / condensers (containing PCB/PCT)	No used
Mercury containing components	No used
Batteries	No used
Printed circuit boards (with a surface greater than 10 square cm)	Product has printed circuit boards (with a surface greater than 10 square cm)
Component contain toner, ink and liquids	No used
Plastic containing BFR	No used
Component and waste contain asbestos	No used
CRT	No used
Component contain CFC, HCFC, HFC and HC	No used
Gas discharge lamps	No used
LCD display > 100 cm <sup>2</sup>	Product has an LCD greater than 100 cm <sup>2</sup>
External electric cable	Product has external cables
Component contain refractory ceramic fibers	No used
Component contain radio-active substances	No used
Electrolyte capacitors (height > 25mm, diameter > 25mm)	Product has electrolyte capacitors (height >25mm, diameter > 25mm)

## 3. Tools Required

List the type and size of the tools that would typically can be used to disassemble the product to a point where components and materials requiring selective treatment can be removed.

Tool Description:

- Screwdriver
- Scraper Bar
- Penknife
- Soldering iron and absorber