

Dell 24 Monitor

SE2422H/SE2422HX

User's Guide

Model: SE2422H/SE2422HX
Regulatory model: SE2422Ht/SE2422Hf/SE2422Hb



-  **NOTE:** A NOTE indicates important information that helps you make better use of your monitor.
-  **CAUTION:** A CAUTION indicates potential damage to hardware or loss of data if instructions are not followed.
-  **WARNING:** A WARNING indicates a potential for property damage, personal injury, or death.

Copyright © 2021 Dell Inc. or its subsidiaries. All rights reserved. Dell, EMC, and other trademarks are trademarks of Dell Inc. or its subsidiaries. Other trademarks may be trademarks of their respective owners.

2021 – 09

Rev. A01

Contents

Safety instructions	5
About your monitor	6
Package contents	6
Product features	8
Identifying parts and controls	9
Front view	9
Back view	10
Bottom view	11
Monitor specifications	12
Resolution specifications	13
Preset display modes	14
Electrical specifications	15
Physical characteristics	16
Environmental characteristics	17
Pin assignments	18
Plug-and-Play	20
LCD monitor quality and pixel policy	20
Ergonomics	21
Handling and moving your display	23
Maintenance guidelines	24
Cleaning your monitor	24



- Setting up the monitor 25**
 - Connecting the stand 25
 - Using the tilt 28
 - Connecting your monitor 29
 - Organizing your cables 30
 - Securing your monitor using Kensington lock (optional). 31
 - Removing the monitor stand 32
 - Wall mounting (optional) 33
- Operating the monitor 34**
 - Power on the monitor 34
 - Using the front panel controls. 34
 - Using the OSD lock function 36
 - To unlock the button(s). 38
 - Front-panel button. 39
 - Using the On-Screen Display (OSD) menu 40
 - Accessing the menu system 40
 - OSD warning messages 52
 - Setting the maximum resolution 56
- Troubleshooting 57**
 - Self-test 57
 - Built-in diagnostics 58
 - Common problems 59
 - Product specific problems. 62
- Appendix. 63**
 - Contacting Dell. 63
 - EU product database for energy label and product information sheet 63



Safety instructions

⚠ WARNING: Use of controls, adjustments, or procedures other than those specified in this documentation may result in exposure to shock, electrical hazards, and/or mechanical hazards.

- Place the monitor on a solid surface and handle it carefully. The screen is fragile and can be damaged if dropped or hit sharply.
- Always be sure that your monitor is electrically rated to operate with the AC power available in your location.
- Keep the monitor in room temperature. Excessive cold or hot conditions can have an adverse effect on the liquid crystal of the display.
- Do not subject the monitor to severe vibration or high impact conditions. For example, do not place the monitor inside a car trunk.
- Unplug the monitor when it is going to be left unused for an extended period of time.
- To avoid electric shock, do not attempt to remove any cover or touch the inside of the monitor.

For information on safety instructions, see the Safety, Environmental, and Regulatory Information (SERI).



About your monitor

Package contents

 **NOTE: Some components may be optional and may not ship with your monitor.**

Your monitor ships with the components shown in the table below. If any component is missing, contact Dell technical support for assistance. For more information on contacting Dell, See [Contacting Dell](#).

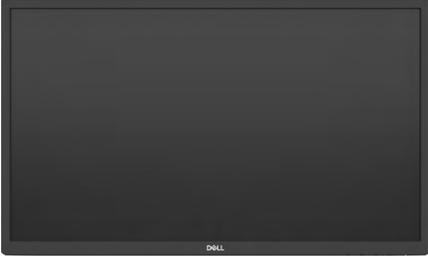
	Display
	Stand riser
	Stand base
	VESA cover
	Power cable (varies by country)

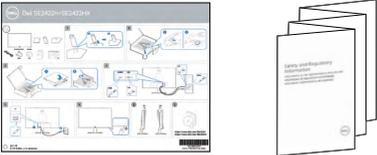

	HDMI cable
	VGA cable (SE2422HX only)
	<ul style="list-style-type: none">• Quick Setup Guide• Safety, Environmental, and Regulatory Information



Product features

The **Dell SE2422H/SE2422HX** monitor has an active matrix, Thin-Film Transistor (TFT), Liquid Crystal Display (LCD), and LED backlight. The monitor features include:

- 60.45 cm (23.8 in.) viewable area monitor (measured diagonally) 1920 x 1080 (16:9) resolution, plus full-screen support for lower resolutions.
- Color gamut of 72% NTSC (typical), CIE 1931.
- Digital connectivity with HDMI.
- Tilt adjustment capability.
- Removable pedestal stand and Video Electronics Standards Association (VESA™) 100 mm mounting holes for flexible mounting solutions.
- Plug and play capability, if supported by your computer.
- On-Screen Display (OSD) adjustments for ease of set-up and screen optimization.
- Power and OSD buttons lock.
- Security lock slot.
- Stand lock.
- ≤ 0.3 W in Standby mode.
- The monitor adopts Flicker-Free technology, which clears the eye visible flicker, brings comfort viewing experience and preventing users suffer from eye strain and fatigue.
- Supports 48 Hz to 75 Hz (HDMI) in FreeSync Mode.
- Supports AMD FreeSync™ technology
- Optimize eye comfort with a TÜV-certified flicker-free screen.

⚠ WARNING: The possible long-term effects of blue light emission from the monitor may cause damage to the eyes, including eye fatigue, digital eye strain, and so on.



Identifying parts and controls

Front view

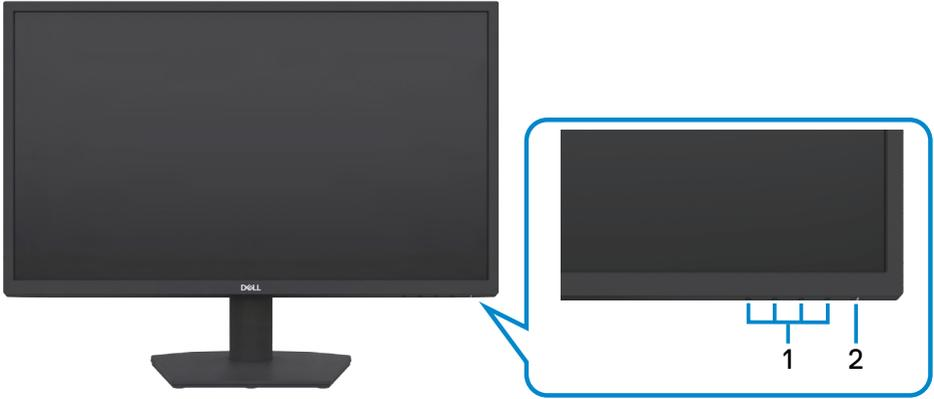

Label	Description	Use
1	Function buttons	For more information, see Operating the monitor .
2	Power LED indicator	Solid white light indicates the monitor is turned on and functioning normally. Blinking white light indicates the monitor is in Standby mode.



Back view



Label	Description	Use
1	VESA mounting holes (100 mm x 100 mm-behind the VESA cover)	Wall mount the monitor using VESA-compatible wall mount kit (100 mm x 100 mm). NOTE: Wall mount kit is not shipped with your monitor and is sold separately.
2	Regulatory label	Lists the regulatory approvals.
3	Stand release button	Releases stand from the monitor.
4	Barcode, serial number, and Service Tag label	The Service Tag is a unique alphanumeric identifier that enables Dell service technicians to identify the hardware components in your monitor and access warranty information. Refer to this label if you need to contact Dell for technical support.
5	Cable-management slot	Connect the cables by inserting them through the slot.
6	VESA cover	The two endpoints on the front of the VESA cover are aligned with the VESA mounting holes and the VESA cover is gently pressed.



Bottom view

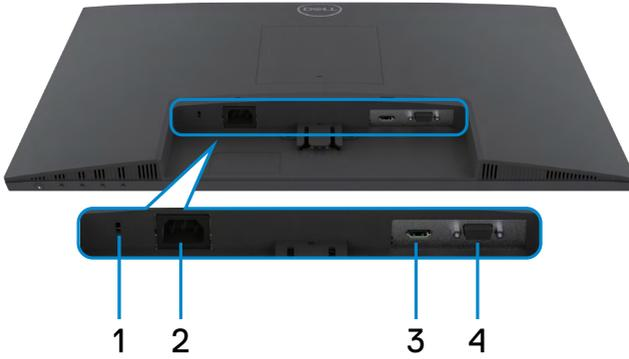

Label	Description	Use
1	Security lock slot	Secures monitor with security cable lock (sold separately).
2	Power connector	Connect the power cable (shipped with your monitor).
3	HDMI port	Connect the HDMI cable (shipped with your monitor).
4	VGA port	Connect the VGA cable (SE2422HX only)



Monitor specifications

Description	Values
Screen type	Active matrix - TFT LCD
Panel type	Vertical Alignment (VA)
Aspect ratio	16:9
Viewable image dimensions	
Diagonal	604.50 mm (23.80 in.)
Active Area	
Horizontal	527.04 mm (20.75 in.)
Vertical	296.46 mm (11.67 in.)
Area	156246.28 mm ² (242.18 in. ²)
Pixel pitch	0.2745 mm x 0.2745 mm
Pixel per inch (PPI)	92.56
Viewing angle	
Horizontal	178° (typical)
Vertical	178° (typical)
Brightness	250 cd/m ² (typical)
Contrast ratio	3000 to 1 (typical)
Display screen coating	Anti-glare with 3H hardness
Backlight	LED edgelight system
Response Time (Gray to Gray)	12 ms (Normal mode) 8 ms (Fast mode) 5 ms (Extreme mode) NOTE: In Extreme mode, slight artifacts may be encountered due to overdriving for fast speed and responsiveness. Use Normal/Fast/Extreme mode for optimal front of screen experience and game play.
Color depth	16.70 million colors
Color gamut*	72% NTSC, CIE 1931
Connectivity	· 1 x HDMI 1.4 port · 1 x VGA
Border width (edge of monitor to active area)	
Top	12.80 mm



Left/Right	12.80 mm
Bottom	16.92 mm
Adjustability	
Height adjustable stand	NA
Tilt	-5° to 21°
Cable management	Yes
Dell Display Manager (DDM) Compatibility	Easy Arrange and other key features
Security	Security lock slot (cable lock sold separately)

* At panel native only, under Custom Mode preset.

Resolution specifications

Model	SE2422H		SE2422HX	
Description	HDMI	VGA	HDMI	VGA
Horizontal scan range	30 to 83 kHz		31 to 84 kHz	31 to 80 kHz
Vertical scan range	48 to 75 Hz			
Maximum preset resolution	1920x1080 @ 75Hz(HDMI) 1920x1080 @ 60Hz(VGA)			
Video display capabilities (HDMI mode)	480p, 576p, 720p, 1080i, 1080p, FHD			



Preset display modes

Display Mode	Horizontal Frequency (kHz)	Vertical frequency (Hz)	Pixel Clock (MHz)	Sync Polarity (Horizontal/Vertical)
720 x 400	31.47	70.08	28.32	-/+
640 x 480	31.47	59.94	25.18	-/-
640 x 480	37.50	75	31.50	-/-
800 x 600	37.88	60.317	40	+/+
800 x 600	46.88	75	49.50	+/+
1024 x 768	48.36	60	65	-/-
1024 x 768	60.02	75.029	78.75	+/+
1152 x 864	67.50	75	108	+/+
1280 x 1024	64	60.02	108	+/+
1280 x 1024	80	75.02	135	+/+
1600 x 900	60	60	108	+/+
1920 x 1080	67.50	60	148.50	+/+
1920 x 1080	83.89	75	174.50	+/-



Electrical specifications

Description	Values
Video input signals	<ul style="list-style-type: none"> • HDMI 1.4 , 600mV for each differential line, 100 ohm input impedance per differential pair • Analog RGB, 0.7 Volts +/- 5%, positive polarity at 75 Ω input impedance
Input voltage/ frequency/ current	100-240 VAC / 50 or 60 Hz \pm 3 Hz / 1.5 A (maximum)
Inrush current	120 V: 30 A (max.) at 0°C (cold start) 240 V: 60 A (max.) at 0°C (cold start)
Power Consumption	0.3 W (Off Mode) ¹ 0.3 W (Standby mode) ¹ 15.7 W (On Mode) ¹ 24 W (Max) ² 15.9 W (P_{on}) ³ 49.7 kWh (TEC) ³

¹ As defined in EU 2019/2021 and EU 2019/2013.

² Max brightness and contrast setting.

³ P_{on} : Power consumption of On Mode measured with reference to Energy Star test method.

TEC: Total energy consumption in kWh measured with reference to Energy Star test method.

⚠ CAUTION: This document is informational only and reflects laboratory performance. Your product may perform differently, depending on the software, components and peripherals you ordered and shall have no obligation to update such information. Accordingly, the customer should not rely upon this information in making decisions about electrical tolerances or otherwise. No warranty as to accuracy or completeness is expressed or implied.



Physical characteristics

Description	SE2422H	SE2422HX
Connector type	<ul style="list-style-type: none"> • One HDMI 1.4 port • One VGA port 	
Signal cable type	<ul style="list-style-type: none"> • HDMI 1.8 m cable • VGA 1.8 m cable (SE2422HX only) 	
Dimensions (with stand)		
Height (extended)	420.25 mm (16.55 in.)	
Width	552.64 mm (21.76 in.)	
Depth	178.81 mm (7.04 in.)	
Dimensions (without stand)		
Height	331.61 mm (13.06 in.)	
Width	552.64 mm (21.76 in.)	
Depth	49.69 mm (1.96 in.)	
Stand dimensions		
Height (extended)	173.93 mm (6.85 in.)	
Width	240.42 mm (9.47 in.)	
Depth	178.81 mm (7.04 in.)	
Weight		
Weight with packaging	5.23 kg (11.53 lb)	5.33 kg (11.75 lb)
Weight with stand assembly and cables	3.77 kg (8.31 lb)	3.87 kg (8.53 lb)
Weight without stand assembly (For wall mount or VESA mount considerations - no cables)	3.18 kg (7.01 lb)	3.18 kg (7.01 lb)
Weight of stand assembly	0.33 kg (0.73 lb)	0.33 kg (0.73 lb)



Environmental characteristics

Description	Values
Compliant Standards	
<ul style="list-style-type: none"> · RoHS Compliant · BFR/PVC reduced monitor (excluding external cables) · Arsenic-Free glass and Mercury-Free for the panel only 	
Temperature	
Operating	0°C to 40°C (32°F to 104°F)
Non-operating	Storage: -20°C to 60°C (-4°F to 140°F)
	Shipping: -20°C to 60°C (-4°F to 140°F)
Humidity	
Operating (non-condensing)	20% to 90%
Non-operating (non-condensing)	·Storage: 5 % to 90 %
	·Shipping: 5 % to 90 %
Altitude	
Operating (maximum)	5000 m (16,404 ft)
Non-operating (maximum)	12.192 m (40,000 ft)
Thermal dissipation	81.89 BTU/hour (maximum)
	53.57 BTU/hour (on mode)



Pin assignments

VGA connector

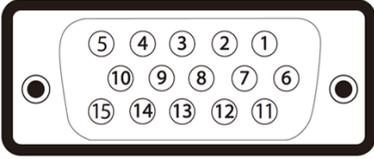

Pin number	15-pin side of the connected signal cable
1	Video-Red
2	Video-Green
3	Video-Blue
4	GND
5	Self-test
6	GND-R
7	GND-G
8	GND-B
9	Computer 5 V / 3.3 V
10	GND-sync
11	GND
12	DDC data
13	H-sync
14	V-sync
15	DDC clock



HDMI port

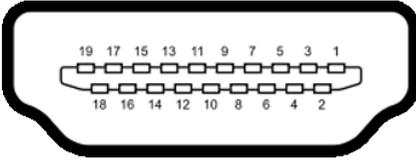

Pin number	19-pin side of the connected signal cable	Pin number	19-pin side of the connected signal cable
1	TMDS DATA 2+	11	TMDS CLOCK SHIELD
2	TMDS DATA 2 SHIELD	12	TMDS CLOCK-
3	TMDS DATA 2-	13	CEC
4	TMDS DATA 1+	14	Reserved (N.C. on device)
5	TMDS DATA 1 SHIELD	15	DDC CLOCK (SCL)
6	TMDS DATA 1-	16	DDC DATA (SDA)
7	TMDS DATA 0+	17	DDC/CEC Ground
8	TMDS DATA 0 SHIELD	18	+5 V POWER
9	TMDS DATA 0-	19	HOT PLUG DETECT
10	TMDS CLOCK+		



Plug-and-Play

You can install the monitor in any Plug-and-Play-compatible system. The monitor automatically provides the computer system with its extended display identification data (EDID) using display data channel (DDC) protocols so the computer can configure itself and optimize the monitor settings. Most monitor installations are automatic; you can select different settings if desired. For more information about changing the monitor settings, see [Operating the monitor](#).

LCD monitor quality and pixel policy

During the LCD monitor manufacturing process, it is common for one or more pixels to become fixed in an unchanging state. This is hard to notice and will not affect the display quality or usability. For more information on LCD Monitor Pixel Policy, see: <https://www.dell.com/pixelguidelines>.



Ergonomics

△ **CAUTION: Improper or prolonged usage of keyboard may result in injury.**

△ **CAUTION: Viewing the monitor screen for extended periods of time may result in eye strain.**

For comfort and efficiency, observe the following guidelines when setting up and using your computer workstation:

- Position your computer so that the monitor and keyboard are directly in front of you as you work. Special shelves are commercially available to help you correctly position your keyboard.
- To reduce the risk of eye strain and neck/arm/back/shoulder pain from using the monitor for long periods of time, we suggest you to:
 1. Set the screen about 20 to 28 in. (50-70 cm) from your eyes.
 2. Blink frequently to moisten or rewet your eyes when working with the monitor.
 3. Take regular and frequent breaks for 20 minutes every two hours.
 4. Look away from your monitor and gaze at a distant object at 20 feet away for at least 20 seconds during the breaks.
 5. Perform stretches to relieve tension in the neck/arm/back/shoulders during the breaks.
- Make sure that the monitor screen is at eye level or slightly lower when you are sitting in front of the monitor.
- Adjust the tilt of the monitor, its contrast, and brightness settings.
- Adjust the ambient lighting around you (such as overhead lights, desk lamps, and the curtains or blinds on nearby windows) to minimize reflections and glare on the monitor screen.
- Use a chair that provides good lower-back support.
- Keep your forearms horizontal with your wrists in a neutral, comfortable position while using the keyboard or mouse.
- Always leave space to rest your hands while using the keyboard or mouse.
- Let your upper arms rest naturally on both sides.
- Ensure that your feet are resting flat on the floor.
- When sitting, make sure that the weight of your legs is on your feet and not on the front portion of your seat. Adjust your chair's height or use a footrest if necessary to maintain a proper posture.
- Vary your work activities. Try to organize your work so that you do not have to sit and work for extended periods of time. Try to stand or get up and walk around at regular intervals.



- Keep the area under your desk clear of obstructions and cables or power cords that may interfere with comfortable seating or present a potential trip hazard.

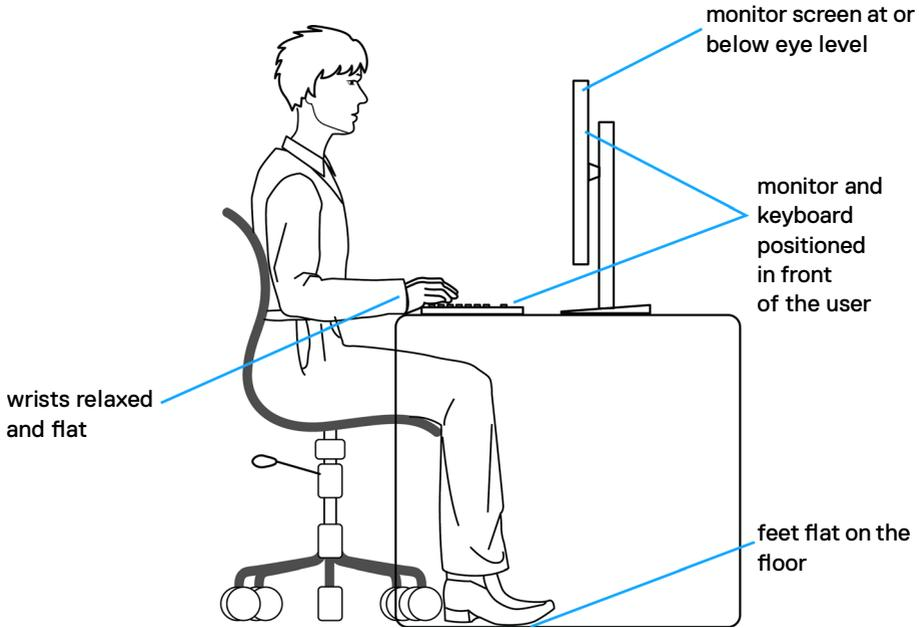

Handling and moving your display

To ensure the monitor is handled safely when lifting or moving it, follow the guidelines mentioned below:

- Before moving or lifting the monitor, turn off your computer and the monitor.
- Disconnect all cables from the monitor.
- Place the monitor in the original box with the original packing materials.
- Hold the bottom edge and the side of the monitor firmly without applying excessive pressure when lifting or moving the monitor.

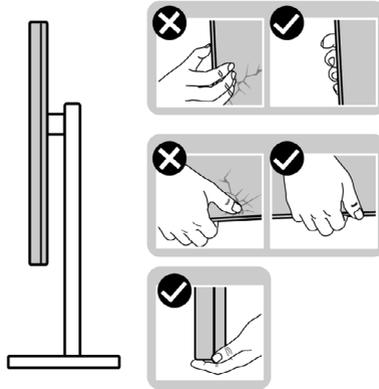

- When lifting or moving the monitor, ensure the screen is facing away from you and do not press on the display area to avoid any scratches or damage.

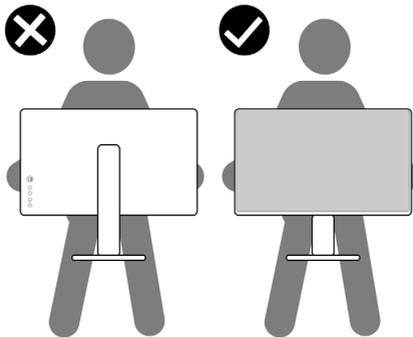

- When transporting the monitor, avoid any sudden shock or vibration to it.



- When lifting or moving the monitor, do not turn the monitor upside down while holding the stand base or stand riser. This may result in accidental damage to the monitor or cause personal injury.

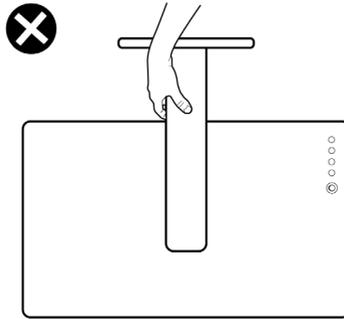

Maintenance guidelines

Cleaning your monitor

- ⚠ **WARNING:** Before cleaning the monitor, unplug the monitor power cable from the electrical outlet to avoid damage to hardware, property as well as personal injury.
- ⚠ **CAUTION:** Read and follow the [Safety instructions](#) before cleaning the monitor.

For best practices, follow these instructions in the list below while unpacking, cleaning, or handling your monitor:

- If you notice white powder when you unpack your monitor, wipe it off with a cloth.
- Handle your monitor with care as a darker-colored monitor may get scratched and show white scuff marks more than a lighter-colored monitor.
- To clean your anti-static screen, lightly dampen a soft, clean cloth with water. If possible, use a special screen-cleaning tissue or solution suitable for the anti-static coating. Do not use benzene, thinner, ammonia, abrasive cleaners, or compressed air.
- Use a lightly-dampened, soft cloth to clean the monitor. Avoid using detergent of any kind as some detergents leave a milky film on the monitor.
- To help maintain the best image quality on your monitor, use a dynamically changing screen saver and turn off your monitor when not in use.



Setting up the monitor

Connecting the stand

- ✎ **NOTE:** The stand riser and stand base are detached when the monitor is shipped from the factory.
- ✎ **NOTE:** The following instructions are applicable only for the stand that was shipped with your monitor. If you are connecting a stand that you purchased from any other source, follow the setup instructions that were included with the stand.
- ⚠ **CAUTION:** Place monitor on a flat, clean, and soft surface to avoid scratching the display panel.

To attach the monitor stand:

1. Align the tabs on the stand base with the slots on the stand riser.
2. Insert the stand riser on the stand base firmly.

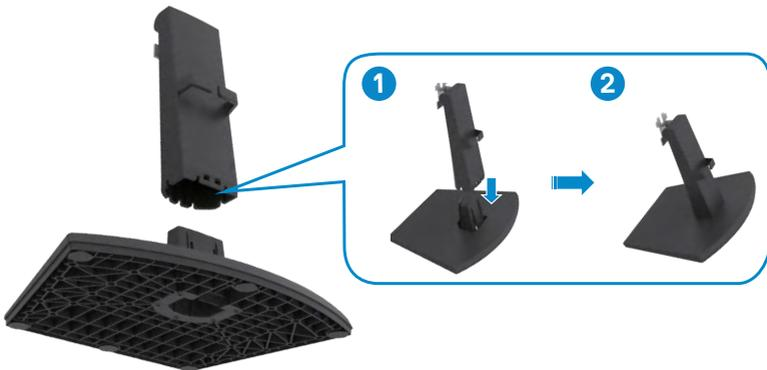

3. Align the tabs on the stand-riser bracket with the grooves at the back of the monitor.
4. Insert the stand-riser bracket into monitor groove until it snaps into place.

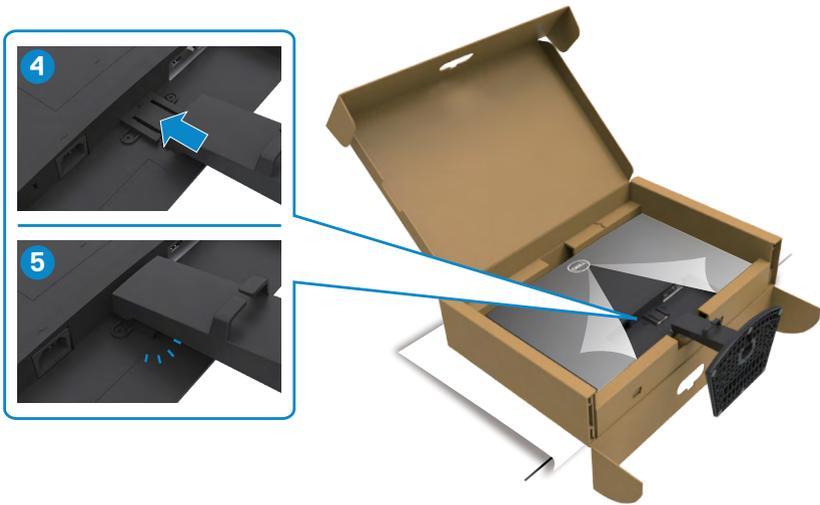

5. Open the monitor protective cover and install the VESA cover.

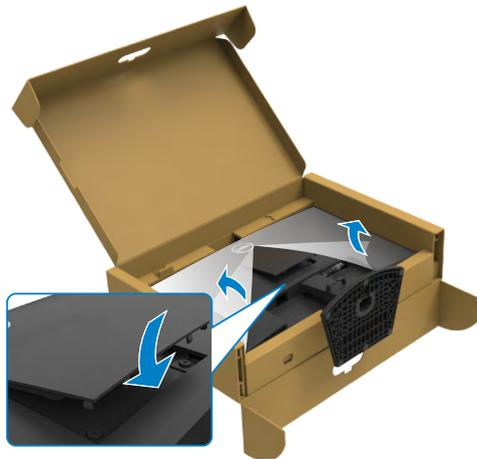

△ **CAUTION: Hold the stand riser firmly when lifting the monitor to avoid any accidental damage.**

6. Hold the stand riser and lift the monitor carefully, then place it on a clean and flat surface.



7. Lift the protective cover from the monitor.

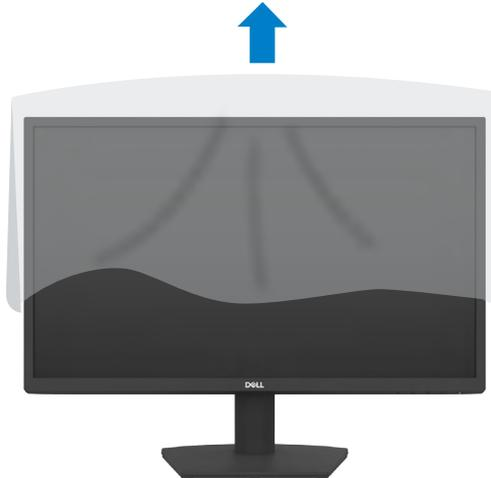

Using the tilt

NOTE: The following instructions are applicable only for the stand that was shipped with your monitor. If you are connecting a stand that you purchased from any other source, follow the set up instructions that were included with the stand.

With the stand attached to the monitor, you can tilt the monitor for the most comfortable viewing angle.

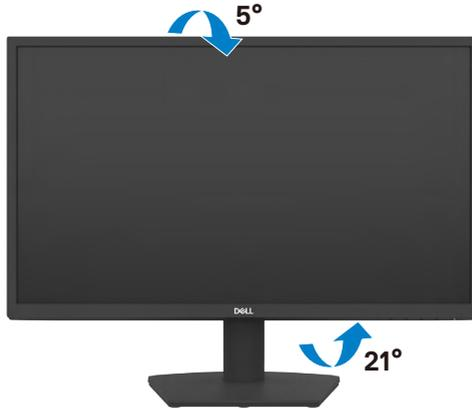

Connecting your monitor

⚠ WARNING: Before you begin any of the procedures in this section, follow the **Safety instructions**.

To connect your monitor to the computer:

1. Turn off your computer.
2. Connect the HDMI cable from your monitor to the computer.
3. Turn on your monitor.
4. Select the correct input source from the OSD Menu on your monitor and then turn on your computer.

Connecting the HDMI and power cable

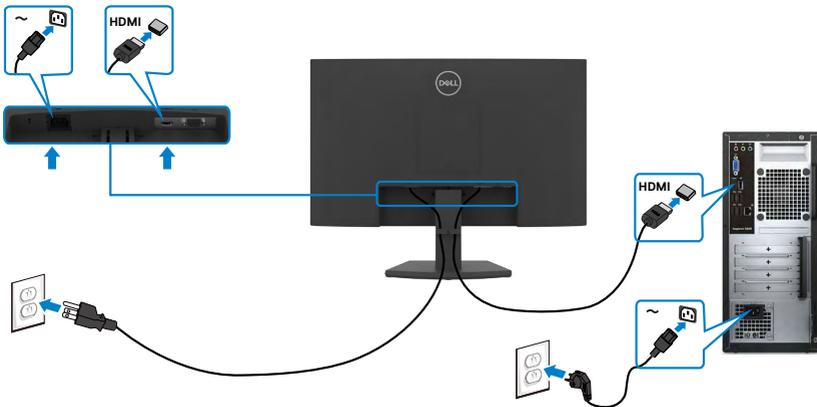

Connecting the VGA cable

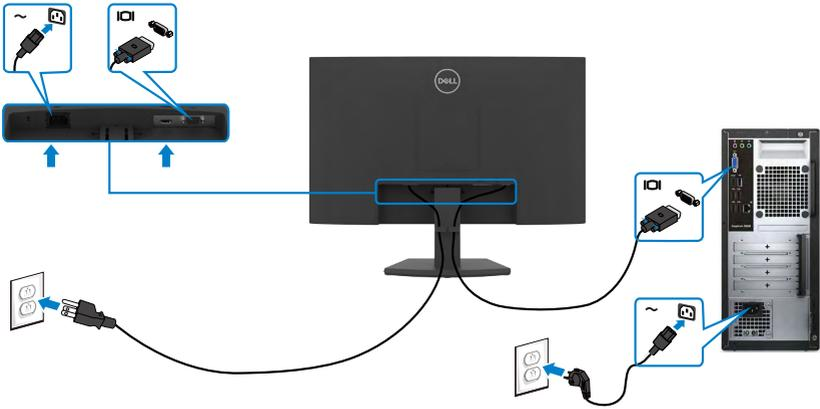

Organizing your cables



After connecting all necessary cables to your monitor and computer, (see [Connecting your monitor](#) for cable attachment) organize all cables as shown in the image.



Securing your monitor using Kensington lock (optional)

NOTE: Kensington lock is sold separately.

The security lock slot is located at the bottom of the monitor. (See [Security lock slot](#))

For more information about using the Kensington lock (sold separately), see the documentation that is shipped with the lock.

Secure your monitor to a table using the Kensington security lock.

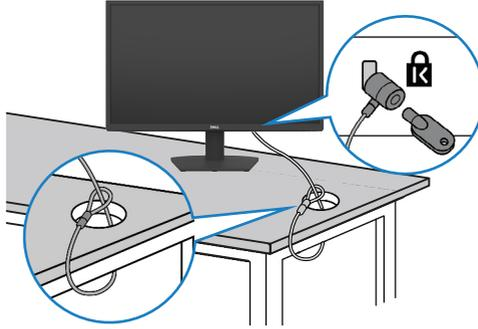

NOTE: The image is for the purpose of illustration only. Appearance of the lock may vary.



Removing the monitor stand

⚠ CAUTION: To prevent scratches on the LCD screen while removing the stand, make sure that the monitor is placed on a soft, clean and flat surface.

✍ NOTE: The following instructions are applicable only for the stand that was shipped with your monitor. If you are connecting a stand that you purchased from any other source, follow the set up instructions that were included with the stand.

To remove the stand:

1. Place a flat cushion or a sitting mat near the edge of a table and place the monitor on it with the display facing down.
2. Press the stand down to access to the stand release button.
3. Use a long screwdriver to press the release latch.
4. While pressing the release latch, slide out the stand assembly from the monitor.



To remove the VESA cover:

Press the dimple on the VESA cover to release it from the back of the display.

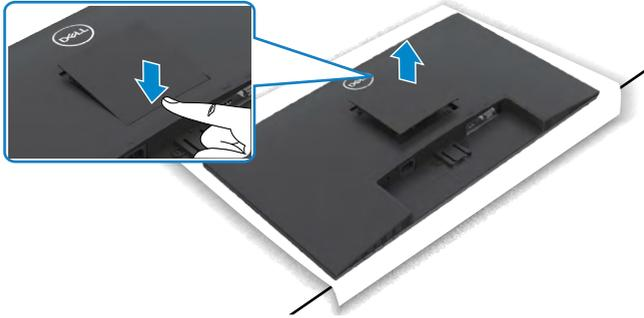

Wall mounting (optional)



NOTE: Use M4 x 10 mm screws to secure the wall-mounting kit to the monitor.

NOTE: The wall-mounting kit is sold separately.

See the documentation that is shipped with the VESA-compatible wall mounting kit.

1. Place a flat cushion or a sitting mat near the edge of a table and place the monitor on it with the display facing down.
2. Remove the [stand](#).
3. Using a Phillips crosshead screwdriver, remove the four screws that secure the back panel to the main chassis.
4. Connect the mounting bracket from the wall mounting kit to the monitor.
5. Follow the instructions that shipped with the wall-mounting kit and mount the monitor on the wall.

NOTE: For use only with UL or CSA or GS-listed wall mount bracket with minimum weight/load bearing capacity of 11.60 kg (SE2422H)/13.80 kg (SE2422HX).



Operating the monitor

Power on the monitor

Press the  button to turn on the monitor.

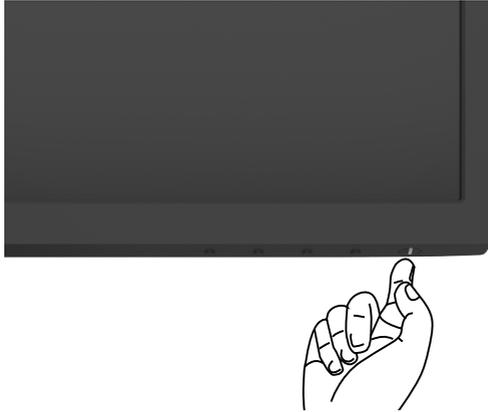

Using the front panel controls

Use the control buttons at the bottom edge of the monitor to adjust the specifications of the image being displayed. When using the control buttons, an On-Screen Display (OSD) menu appears on the screen.

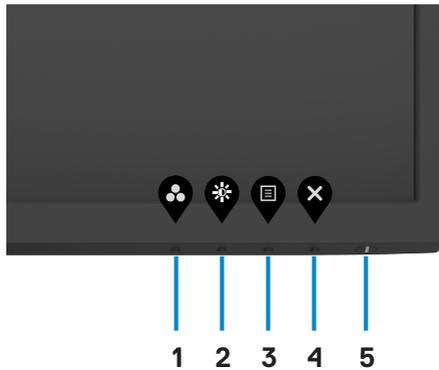

The following table describes the front panel buttons:

Front-Panel Button	Description
1  Shortcut key: Preset Modes	Use this button to choose from a list of preset color modes.
2  Shortcut key: Brightness/Contrast	Direct access to the Brightness/Contrast adjustment sliders.
3  Menu	Use this menu button to launch the on-screen display (OSD) and select the OSD menu. See Accessing the menu system .
4  Exit	Use this button to return to the main menu or exit the OSD main menu.
5  Power Button (with power-status light)	To turn the monitor on or off. Solid white light indicates the monitor is turned on and functioning normally. Blinking white light indicates the monitor is in Standby mode.



Using the OSD lock function

You can lock the front-panel control buttons to prevent access to the OSD menu and/or power button.

Use the Lock menu to lock the button(s).

1. Select one of the following options.

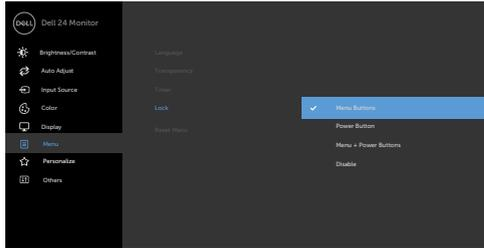

2. The following message appears.

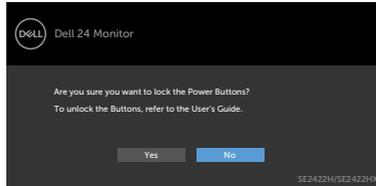

3. Select **Yes** to lock buttons. Once locked, pressing any control button will display the lock icon .



Use the front-panel control button to lock the button(s).

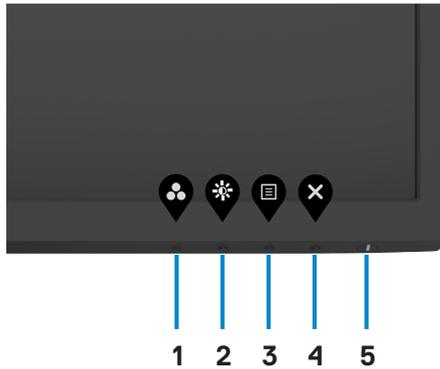

1. Press and hold [Built-in diagnostics](#) button (**button 4**) for four seconds, a menu appears on the screen.

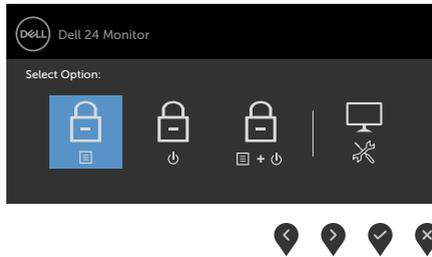

2. Select one of the following options:

Options	Description
1  Menu Buttons lock	Select this option to lock OSD menu function.
2  Power Button lock	Use this option to lock power button. This will prevent the user to turn off the monitor using the power button.
3  Menu and Power Buttons lock	Use this option to lock OSD menu and power button.



Options	Description
4 	Use this option to run the built-in diagnostics, see Built-in diagnostics .

Built-in Diagnostics

To unlock the button(s).

Press and hold [Built-in diagnostics](#) button (**button 4**) for four seconds until a menu appears on the screen. The following table describes the options to unlock the front-panel control buttons.



Options	Description
1 	Use this option to unlock OSD menu function.
Menu Buttons unlock	
2 	Use this option to unlock power button to turn off the monitor.
Power Button unlock	
3 	Use this option to unlock OSD menu and power button.
Menu and Power Buttons unlock	
4 	Use this option to run the built-in diagnostics, see Built-in diagnostics .
Built-in Diagnostics	



Front-panel button

Use the buttons on the front of the monitor to adjust the image settings.

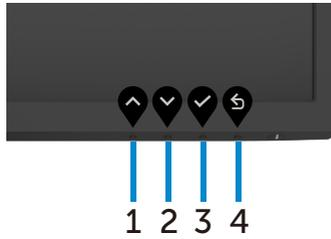

Front Panel Button	Description
1  Up	Use the Up button to increase values or move up in a menu.
2  Down	Use the Down button to decrease values or move down in a menu.
3  OK	Use the OK button to confirm your selection.
4  Back	Use the Back button to return to the previous menu.



Using the On-Screen Display (OSD) menu

Accessing the menu system

NOTE: The changes you make using the OSD menu are automatically saved when you move to another OSD menu, when you exit the OSD menu, or when the OSD menu exit automatically.

1. Press the  button to launch the OSD main menu.



2. Press the  and  buttons to move between options. As you move from one icon to another, the option name is highlighted.
3. Press the , , or  button once to activate the highlighted option.
4. Press the  and  buttons to select the desired parameter.
5. Press  to enter the slide bar and then use the  or  button, according to the indicators on the menu, to make your changes.
6. Select the  to return to previous menu or  to accept and return to previous menu.

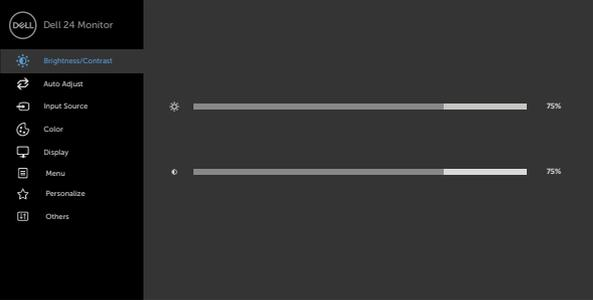

Icon	Menu and Submenus	Description
	Brightness/Contrast	Use this menu to activate Brightness/Contrast adjustment.
		
		

Brightness **Brightness** adjusts the luminance of the backlight (minimum 0; maximum 100).
 Press the  button to increase brightness.
 Press the  button to decrease brightness.

Contrast Adjust the **Brightness** first, and then adjust **Contrast** only if further adjustment is necessary.
 Press the  button to increase contrast and press the  button to decrease contrast (between 0 and 100).
NOTE: Contrast adjusts the difference between darkness and lightness on the monitor.



Icon	Menu and Submenus	Description
------	-------------------	-------------



Auto Adjust

Even though your computer recognizes your monitor on startup, the **Auto Adjustment** function optimizes the display settings for use with your particular setup.

Auto Adjustment allows the monitor to self-adjust to the incoming video signal. After using **Auto Adjustment**, you can further tune your monitor by using the **Pixel Clock** (Coarse) and **Phase** (Fine) controls under **Display** menu.

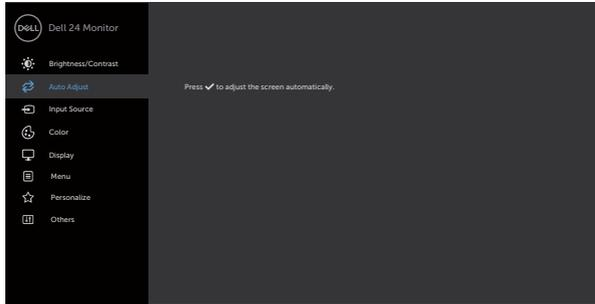

The following dialog appears on a black screen as the monitor automatically adjusts to the current input:

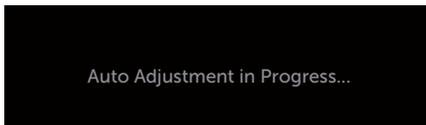

NOTE: In most cases, **Auto Adjust** produces the best image for your configuration.

NOTE: **Auto Adjust** feature option is only available when your monitor is connected using the VGA cable.



Icon	Menu and Submenus	Description
------	-------------------	-------------



Input Source

Use the **Input Source** menu to select between different video inputs that are connected to your monitor.

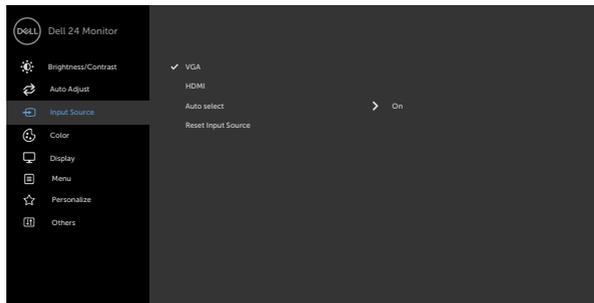

VGA

Select **VGA** input when you are using the VGA connector.

Use  to select the VGA input source.

HDMI

Select **HDMI** input when you are using the HDMI connector.

Use  to select the HDMI input source.

Auto Select

Use  to select **Auto Select**, the monitor scans for available input sources.

Reset Input Source

Resets your monitor's **Input Source** settings to the factory defaults.



Color

Use the **Color** menu to adjust the color setting mode.

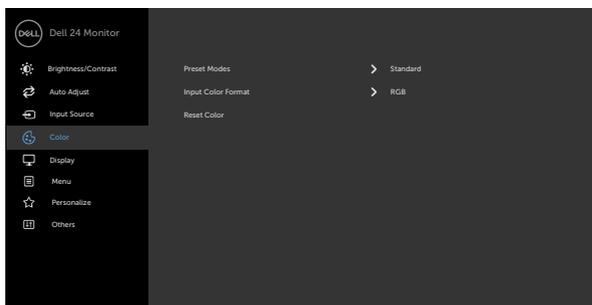

Icon	Menu and Submenus	Description
------	-------------------	-------------

Preset Modes

When you select **Preset Modes**, you can choose **Standard**, **ComfortView**, **Movie**, **FPS**, **RTS**, **RPG**, **Warm**, **Cool** or **Custom Color** from the list.

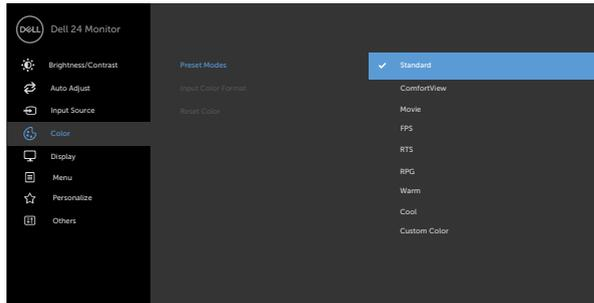

- **Standard:** Default color settings. This is the default preset mode.
- **ComfortView:** Decreases the level of blue light emitted from the screen to make viewing more comfortable for your eyes.

WARNING: The possible long-term effects of blue light emission from the monitor may cause personal injury such as digital eye strain, eye fatigue and damage to the eyes. Using monitor for extended periods of time may also cause pain in parts of body such as neck, arm, back and shoulder. For more information on maintaining proper posture, and to avoid fatigue or injury, see [Ergonomics](#).

- **Movie:** Loads color settings ideal for movies.
- **FPS:** Loads color settings ideal for First-Person Shooter games.
- **RTS:** Loads color settings ideal for Real-Time Strategy games.
- **RPG:** Loads color settings ideal for Role-Playing games.



Icon	Menu and Submenus	Description
		<ul style="list-style-type: none"> • Warm: Increases the color temperature. The screen appears warmer with a red/yellow tint. • Cool: Decreases the color temperature. The screen appears cooler with a blue tint. • Custom Color: Allows you to manually adjust the color settings. Press the  and  buttons to adjust the Red, Green, and Blue values and create your own preset color mode.
	Input Color Format	<p>Allows you to set the video input mode to:</p> <ul style="list-style-type: none"> • RGB: Select this option if your monitor is connected to a computer or a media player that supports RGB output. • YCbCr/YPbPr*: Select this option if your media player supports only YCbCr/YPbPr output.
		
		
		<p>*When VGA input is selected.</p>
	Hue	<p>Use  or  to adjust the hue from 0 to 100.</p> <p>NOTE: Hue adjustment is available only for Movie and FPS, RTS, RPG Game mode.</p>
	Saturation	<p>Use  or  to adjust the saturation from 0 to 100.</p> <p>NOTE: Saturation adjustment is available only for Movie and FPS, RTS, RPG mode.</p>
	Reset Color	<p>Resets your monitor's color settings to the factory defaults.</p>



Icon	Menu and Submenus	Description
	Display	Use the Display menu to adjust image.
		
		
Aspect Ratio	Select the image ratio between 16:9, 4:3 .	
Horizontal Position (VGA input only)	Use  or  to adjust the image left or right. Minimum is '0' (-). Maximum is '100' (+).	
Vertical Position (VGA input only)	Use  or  to adjust the image up or down. Minimum is '0' (-). Maximum is '100' (+).	
Sharpness	Makes the image look sharper or softer. Use  or  to adjust the sharpness from '0' to '100'.	
Pixel Clock (VGA input only)	The Phase and Pixel Clock adjustments allow you to adjust your monitor to your preference. Use the  or  buttons to adjust for best image quality.	
Phase (VGA input only)	If satisfactory results are not obtained using the Phase adjustment, use the Pixel Clock (coarse) adjustment and then use Phase (fine) again.	
Response Time	Allows you to set the Response Time to Normal, Fast or Extreme .	
Reset Display	Restores the display settings to factory defaults.	



Icon	Menu and Submenus	Description
	Menu	Select this option to adjust the settings of the OSD, such as the languages of the OSD, the amount of time the menu remains on screen, and so on.

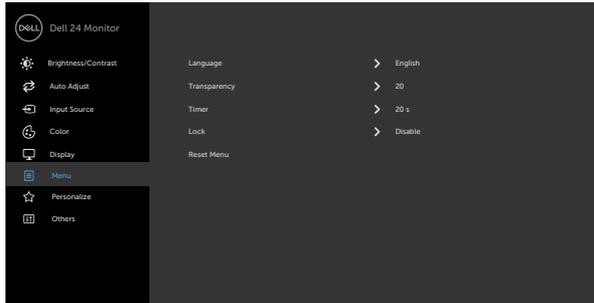

Language Set the OSD display to one of eight languages. (English, Spanish, French, German, Brazilian Portuguese, Russian, Simplified Chinese, or Japanese).

Transparency Select this option to change the menu transparency by using  and  (min. 0 / max. 100).

Timer **OSD Hold Time:** Sets the length of time the OSD remains active after you press a button. Use the  and  buttons to adjust the slider in 1-second increments, from 5 to 60 seconds.

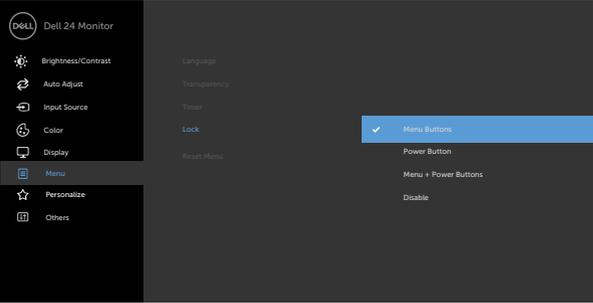

Icon	Menu and Submenus	Description
	Lock	Controls user access to adjustments. The buttons are locked.  
Reset Menu	Restore the menu settings to factory defaults.	

- **Menu Buttons:** Through OSD to lock the Menu buttons.
- **Power Button:** Through OSD to lock the Power button.
- **Menu + Power Buttons:** Through OSD to lock the all of Menu and Power buttons.
- **Disable:** Press and hold the  button on the left of the power button for 4 second.

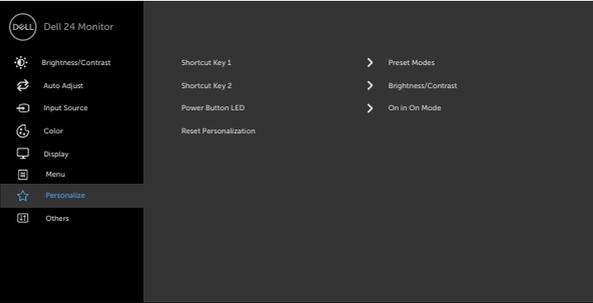

Icon	Menu and Submenus	Description
	Personalize	
Shortcut key 1	Select from Preset Modes, Brightness/Contrast, Auto Adjust, Input Source, Aspect Ratio set as shortcut key 1.	
Shortcut key 2	Select from Preset Modes, Brightness/Contrast, Auto Adjust, Input Source, Aspect Ratio set as shortcut key 2.	
Power Button LED	Allows you to set the state of the power light to save energy.	
Reset Personalization	Restores shortcut keys to factory defaults.	



Icon	Menu and Submenus	Description
	Others	Select this option to adjust the OSD settings such as the DDC/CI, LCD conditioning , and so on.
		
		

Display Info Displays the monitor's current settings.

DDC/CI **DDC/CI** (Display Data Channel/Command Interface) allows you to adjust the monitor settings using software on your computer.

Select **Off** to turn off this feature.

Enable this feature for best user experience and optimum performance of your monitor.

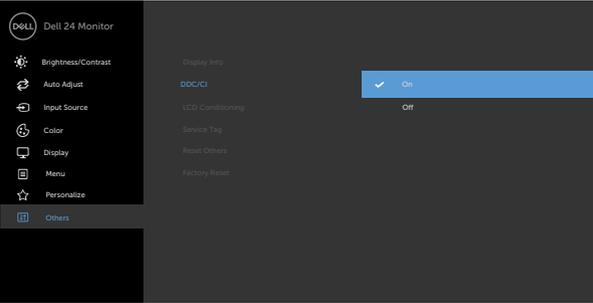

Icon	Menu and Submenus	Description
------	-------------------	-------------

LCD Conditioning

Helps reduce minor cases of image retention. Depending on the degree of image retention, the program may take some time to run. Select **On** to start the process.

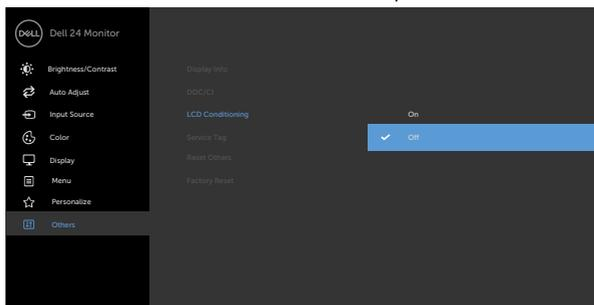

Service Tag

Displays the Service Tag. The Service Tag is a unique alphanumeric identifier that allows Dell to identify the product specifications and access warranty information.

NOTE: The Service Tag is also printed on a label located at the back of the cover.

Reset Others

Restores other settings, such as **DDC/CI**, to factory defaults.

Factory Reset

Restores all preset values to the factory default settings.

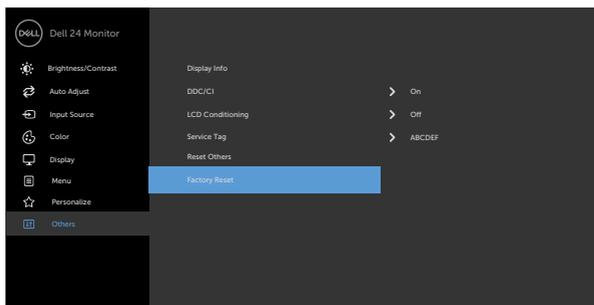

OSD warning messages

When the monitor does not support a particular resolution mode, you can see the following message:

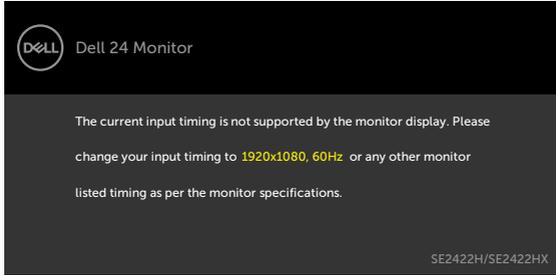

This means that the monitor cannot synchronize with the signal that it is receiving from the computer. See [Resolution specifications](#) for the horizontal and vertical frequency ranges addressable by this monitor. The recommended mode is 1920 x 1080. You can see the following message before the DDC/CI function is disabled:

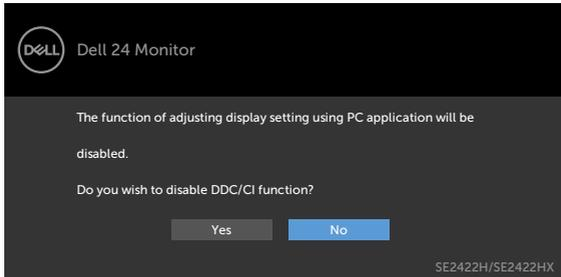

When the monitor enters the **Standby** mode, the following message appears:

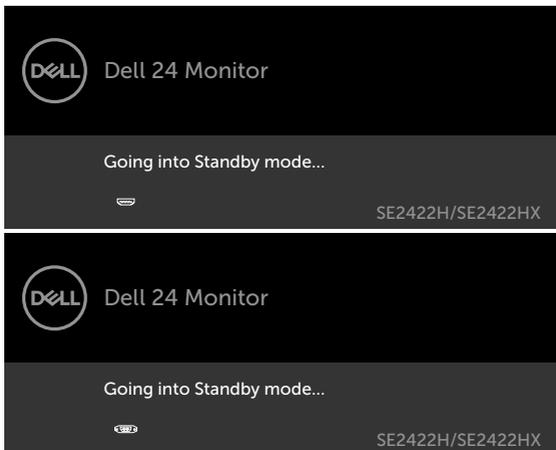

Activate the computer and wake up the monitor to gain access to the [OSD](#).
If you press any button other than the power button, the following messages will appear depending on the selected input:

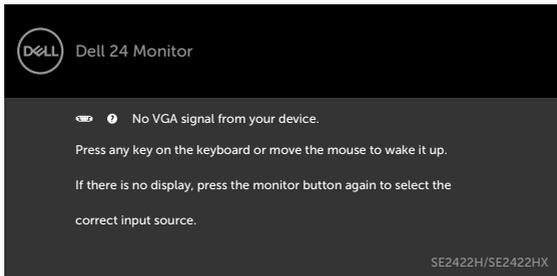
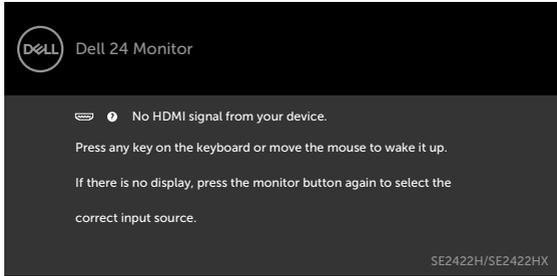

Select OSD items of **Factory Reset** in Other feature, the following message will appear:

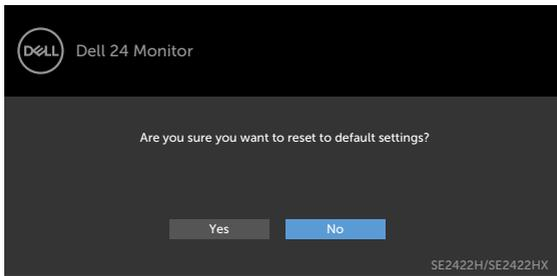

If adjust the Brightness level above the default level over 75%, the following message will appear:

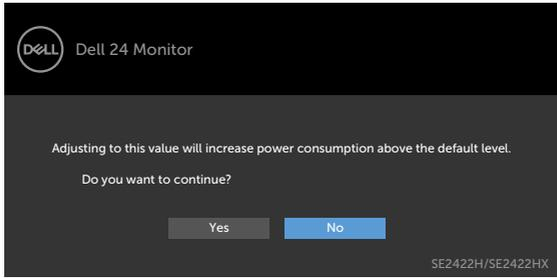

- When user selects “Yes”, the power message is displayed only once.
- When user select ‘No’, the power warning message will pop-up again.
- The power warning message will appear again only when the user does a Factory Reset from the OSD menu.



If either HDMI, VGA input is selected and the corresponding cable is not connected, a floating dialog box as shown below appears.

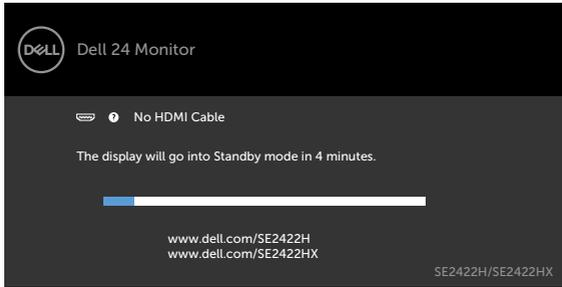

or

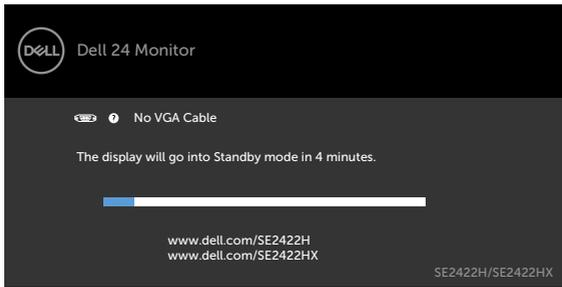

See [Troubleshooting](#) for more information.



Setting the maximum resolution

To set the maximum resolution for the monitor:

In Windows 7, Windows 8 or Windows 8.1:

1. For Windows 8 or Windows 8.1 version, select the Desktop tile to switch to classic desktop. For Skip this step if you are using Windows Vista and Windows 7.
2. Right-click on the desktop and click **Screen resolution**.
3. Click the Dropdown list of the **Screen resolution** and select **1920 x 1080**.
4. Click **OK**.

In Windows 10:

1. Right-click on the desktop and click **Display settings**.
2. Click **Advanced display settings**.
3. Click the dropdown list of **Resolution** and select **1920 x 1080**.
4. Click **Apply**.

If you do not see the **1920 x 1080** as an option, you may need to update your graphics driver. Depending on your computer, complete one of the following procedures:

If you have a Dell desktop or portable computer:

- Go to <https://www.dell.com/support> and enter your service tag, and download the latest driver for your graphics card.

If you are using a non-Dell computer (laptop or desktop):

- Go to your computer manufacturer's support website and download the latest graphic drivers.
- Go to your graphics card manufacturer's website and download the latest graphic drivers.



Troubleshooting

⚠ WARNING: Before you begin any of the procedures in this section, follow the **Safety instructions**.

Self-test

Your monitor provides a self-test feature that allows you to check whether your monitor is functioning properly. If your monitor and computer are properly connected but the monitor screen remains dark, run the monitor self-test by performing the following steps:

1. Turn off both your computer and the monitor.
2. Unplug the video cable from the back of the computer. To ensure proper Self-Test operation, remove all video cables from the back of computer.
3. Turn on the monitor.

If the monitor is working correctly and detects no input signal, depending on the connectivity, one of the following dialog appears. While in self-test mode, the power LED remains white.

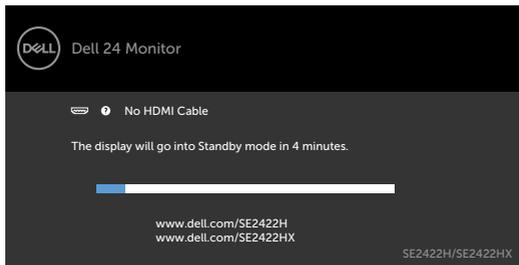

or

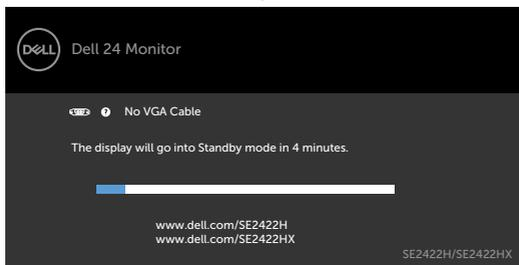

NOTE: This box also appears during normal system operation if the video cable is disconnected or damaged.

4. Turn off your monitor and reconnect the video cable; then turn on both your computer and the monitor.



If your monitor screen remains blank after performing the previous step, check your video controller and computer for any possible issues.

Built-in diagnostics

Your monitor has a built-in diagnostic tool that helps you determine if the screen abnormality you are experiencing is an inherent problem with your monitor, or with your computer and video card.

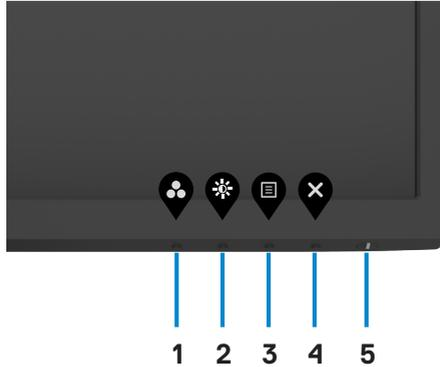

To run the built-in diagnostics:

1. Ensure that the screen is clean (no dust particles on the surface of the screen).
2. Press and hold **button 4** for four seconds and a menu appears on the screen.
3. Select the built-in diagnostics  option. A gray screen appears.
4. Carefully inspect the screen for abnormalities.
5. Press Button 1 on the front panel again. The color of the screen changes to red.
6. Inspect the display for any abnormalities.
7. Repeat steps 5 to 6 to inspect the display when it changes to green, blue, black, white, and text screens.

The test is complete when the text screen appears. To exit, press button 1 again.

If you do not detect any screen abnormalities during the built-in diagnostic tool, the monitor is functioning properly. Check the video card and computer for any possible issues.



Common problems

The following table contains general information about common monitor problems you might encounter and the possible solutions:

Common symptoms	What you experience	Possible solutions
No video/ Power LED off	No picture	<ul style="list-style-type: none">· Ensure that the video cable connecting the monitor and the computer is properly connected and secure.· Verify that the power outlet is functioning properly using any other electrical equipment.· Ensure that the power button is depressed fully.· Ensure that the correct input source is selected in the Input source menu.
No video/ Power LED on	No picture or no brightness	<ul style="list-style-type: none">· Increase brightness and contrast controls through OSD.· Perform monitor self-test feature check.· Check for bent or broken pins in the video cable connector.· Run the built-in diagnostics.· Ensure that the correct input source is selected in the Input source menu.
Poor Focus	Picture is fuzzy, blurry, or ghosting	<ul style="list-style-type: none">· Perform Auto adjust via OSD.· Adjust the Phase and Pixel Clock controls via OSD.· Eliminate video extension cables.· Reset the monitor to factory settings.· Change the video resolution to the correct aspect ratio.
Shaky/Jittery Video	Wavy picture or fine movement	<ul style="list-style-type: none">· Perform Auto adjust via OSD.· Adjust the Phase and Pixel Clock controls via OSD.· Reset the monitor to factory settings.· Check environmental factors.· Move the monitor to another location or room and check again.



Common symptoms	What you experience	Possible solutions
Missing pixels	LCD screen has spots	<ul style="list-style-type: none"> · Cycle power on-off. · Pixel that is permanently off is a natural defect that can occur in LCD technology. · For more information on Dell Monitor Quality and Pixel Policy, see, https://www.dell.com/pixelguidelines.
Stuck-on pixels	LCD screen has bright spots	<ul style="list-style-type: none"> · Cycle power On-Off. · Pixel that is permanently off is a natural defect that can occur in LCD technology. · For more information on Dell Monitor Quality and Pixel Policy, see, https://www.dell.com/pixelguidelines.
Brightness problems	Picture too dim or too bright	<ul style="list-style-type: none"> · Reset the monitor to factory settings. · Adjust brightness and contrast controls through OSD.
Geometric Distortion	Screen not centered correctly	<ul style="list-style-type: none"> · Reset the monitor to factory settings. · Auto adjust via OSD. · Adjust horizontal & vertical controls via OSD.
Horizontal/Vertical Lines	Screen has one or more lines	<ul style="list-style-type: none"> · Reset the monitor to factory settings. · Perform Auto adjust via OSD. · Adjust Phase and Pixel Clock controls via OSD. · Perform monitor self-test feature check and determine if these lines are also in self-test mode. · Check for bent or broken pins in the video cable connector. · Run the built-in diagnostics.
Synchronization Problems	Screen is scrambled or appears torn	<ul style="list-style-type: none"> · Reset the monitor to factory settings. · Perform Auto adjust via OSD. · Adjust Phase and Pixel Clock controls via OSD. · Perform monitor self-test feature check to determine if the scrambled screen appears in self-test mode. · Check for bent or broken pins in the video cable connector. · Restart the computer in safe mode.



Common symptoms	What you experience	Possible solutions
Safety related issues.	Visible signs of smoke or sparks	<ul style="list-style-type: none"> · Do not perform any troubleshooting steps. · For more information on contacting Dell, see Contact Dell immediately.
Intermittent problems	Monitor malfunctions on & off	<ul style="list-style-type: none"> · Ensure that the video cable connecting the monitor to the computer is connected properly and is secure. · Reset the monitor to factory settings. · Perform monitor self-test feature check to determine if the intermittent problem occurs in self-test mode.
Missing color	Picture missing color	<ul style="list-style-type: none"> · Perform monitor self-test. · Ensure that the video cable connecting the monitor to the computer is connected properly and is secure. · Check for bent or broken pins in the video cable connector.
Wrong color	Picture color not good	<ul style="list-style-type: none"> · Try different Preset Modes in Color settings OSD. Adjust R/G/B value in Custom Color in Color settings OSD. · Adjust R/G/B value under Custom Color in Color menu OSD. · Change the Input Color Format to RGB or YCbCr/YPbPr in the Color settings OSD. · Run the built-in diagnostics.
Image retention from a static image left on the monitor for a long period of time	Faint shadow from the static image displayed appears on the screen	<ul style="list-style-type: none"> · Set the screen to turn off after a few minutes of screen idle time. These can be adjusted in Windows Power Options or Mac Energy Saver setting. · Alternatively, use a dynamically changing screensaver.



Product specific problems

Problem	What you experience	Possible solutions
Screen image is too small	Image is centered on screen, but does not cover the entire viewing area	<ul style="list-style-type: none">• Check the Aspect ratio setting in the Display menu OSD.• Reset the monitor to factory settings.
Cannot adjust the monitor with the buttons on the front panel	OSD does not appear on the screen	<ul style="list-style-type: none">• Turn off the monitor, unplug the monitor power cable, plug it back, and then turn on the monitor.
No Input Signal when user controls are pressed	No picture, the LED light is white	<ul style="list-style-type: none">• Check the signal source. Ensure the computer is not in the power saving mode by moving the mouse or pressing any key on the keyboard.• Check whether the signal cable is plugged in properly. Connect the signal cable again, if necessary.• Reset the computer or video player.
The picture does not fill the entire screen	The picture cannot fill the height or width of the screen	<ul style="list-style-type: none">• Due to different video formats (aspect ratio) of DVDs, the monitor may display in full screen.• Run the built-in diagnostics.



Appendix

FCC Notices (U.S. only) and Other Regulatory Information

For FCC notices and other regulatory information, see the regulatory compliance website located at https://www.dell.com/regulatory_compliance.

Contacting Dell

For customers in the United States, call 800-WWW-DELL (800-999-3355).

 **NOTE:** If you do not have an active Internet connection, you can find contact information on your purchase invoice, packing slip, bill, or Dell product catalog.

Dell provides several online and telephone-based support and service options. Availability varies by country and product, and some services may not be available in your area.

To get online Monitor support content:

See <https://www.dell.com/support/monitors>.

To contact Dell for sales, technical support, or customer service issues:

- 1 Go to <https://www.dell.com/support>.
- 2 Verify your country or region in the Choose A Country/Region drop-down menu at the bottom-right corner of the page.
- 3 Click **Contact Us** next to the country dropdown.
- 4 Select the appropriate service or support link based on your need.
- 5 Choose the method of contacting Dell that is convenient for you.

EU product database for energy label and product information sheet

SE2422H: <https://eprel.ec.europa.eu/qr/494247>

SE2422HX: <https://eprel.ec.europa.eu/qr/494395>

