

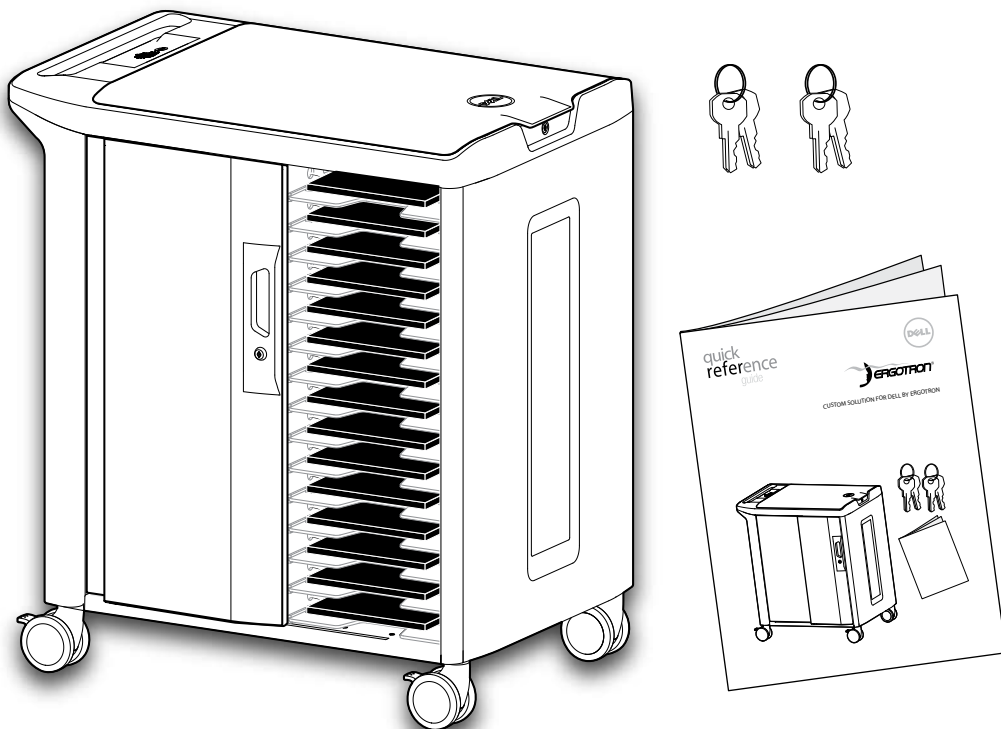

Custom Solution for Dell™ by Ergotron



Dell Unmanaged Charging Cart - 30 Devices

The Dell Unmanaged Charging Cart transports, secures and charges 30 Notebooks, Chromebooks, Ultrabooks, or tablets.

Models:
ERGITD-010



For service, visit www.ergotron.com/Dell
or www.dell.com/support

Dell Unmanaged Charging Cart - 30 Devices

Exterior Features

- 1 Sliding Device Compartment Door
- 2 Power Adapter Compartment Door
- 3 Ergonomic Handle
- 4 Auxiliary Outlets
- 5 Power Management Compartment
- 6 Cord Wrap Bay

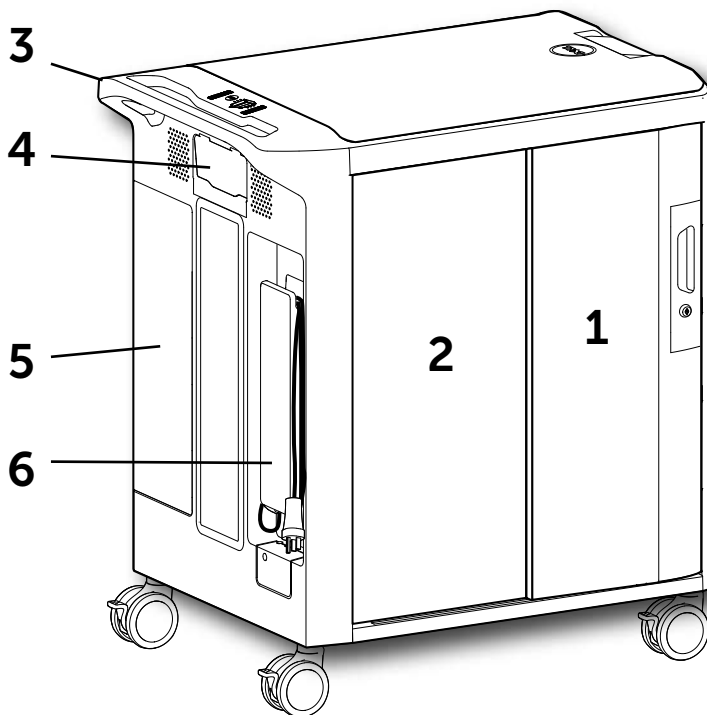

- 7 Upper Compartment
- 8 Locks
- 9 Power/ Fault Status Indicators
- 10 Casters

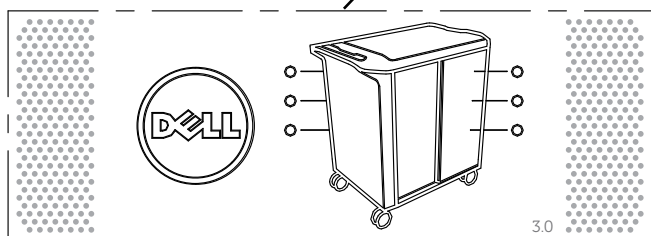
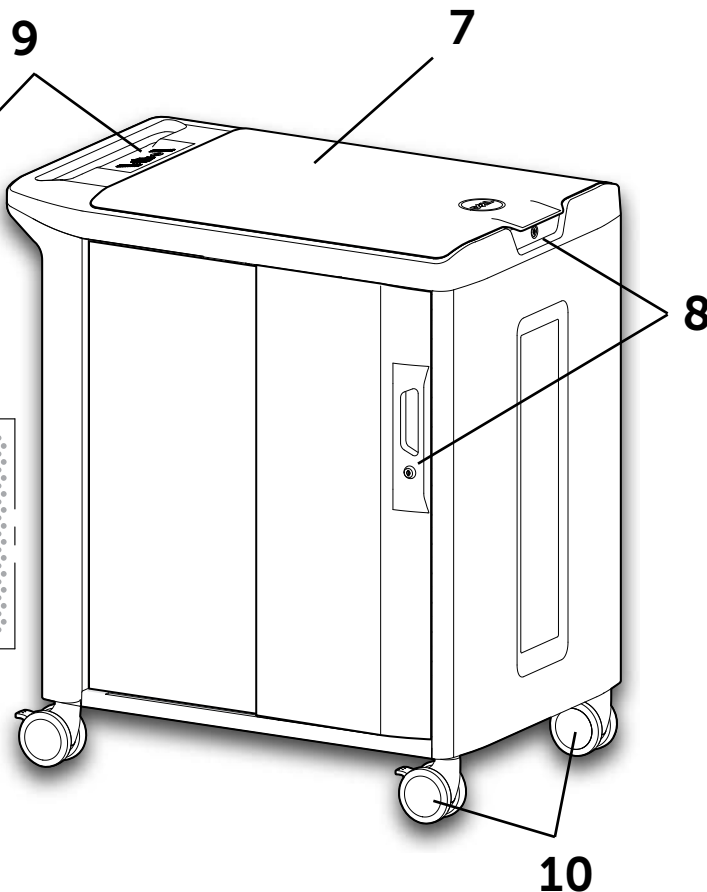

Dell Unmanaged Charging Cart - 30 Devices

Interior Features

- 1 Device Shelves
- 2 Device Outlets
- 3 Adapter Shelves

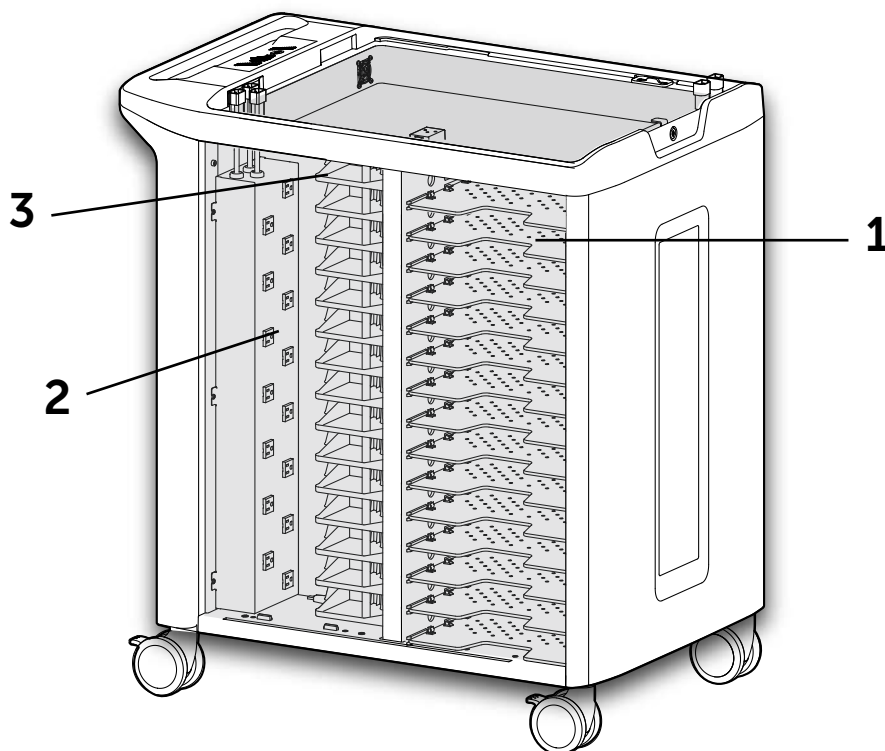

Set-Up and Go

1 Open the power adapter compartment.

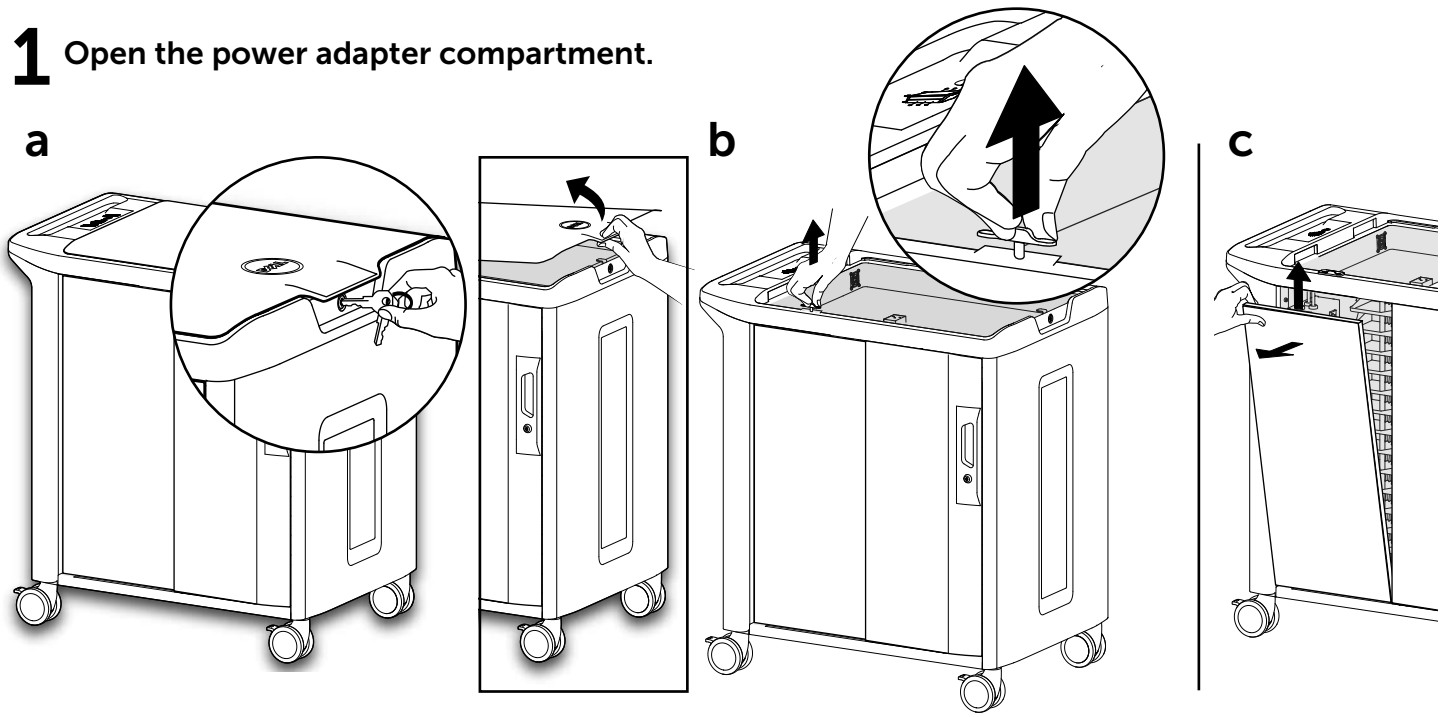

2 Place power adapters into adapter shelves.

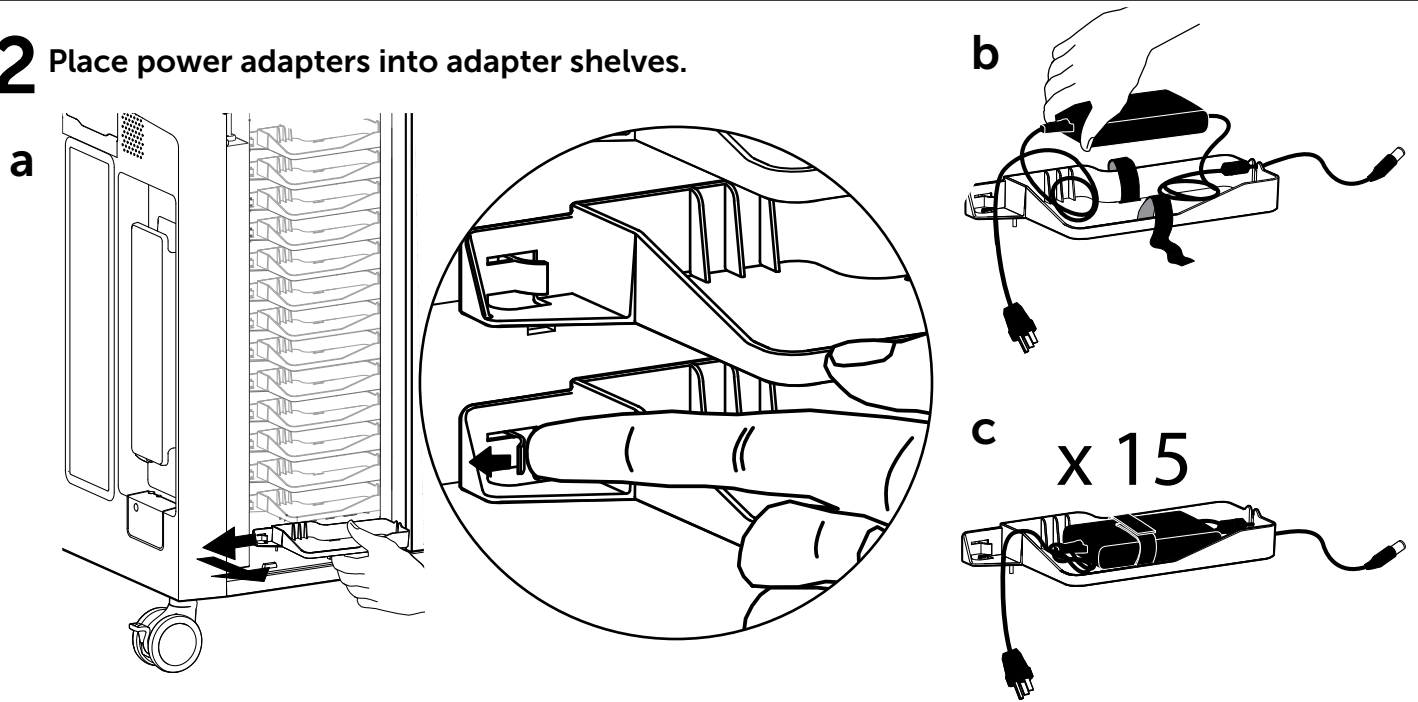

3 Route adapter connector into device compartment.

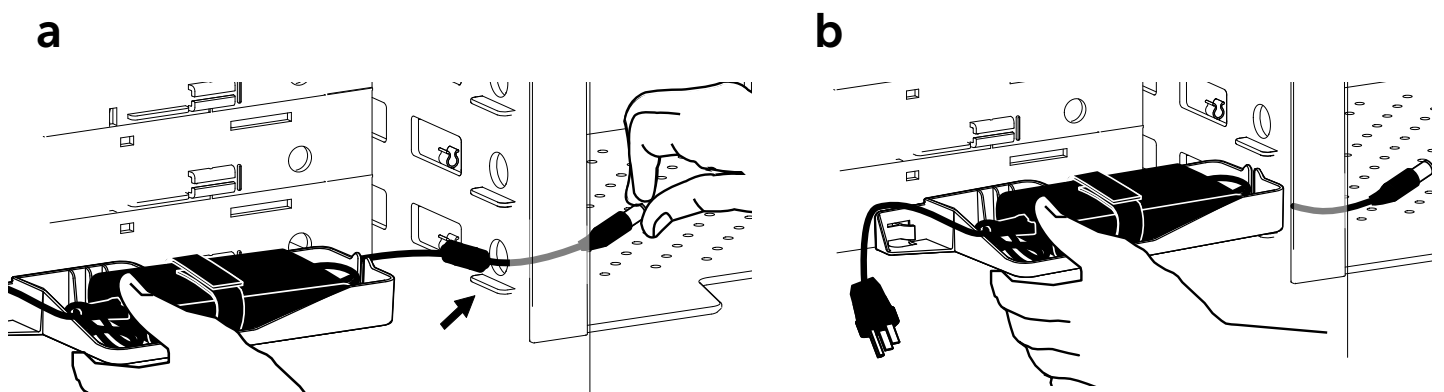

4 Plug-in adapters.

a

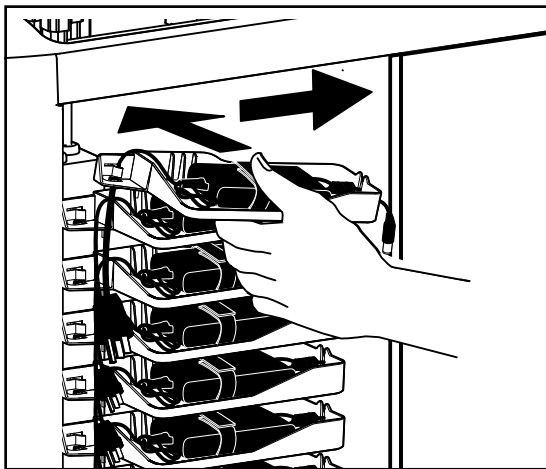

b

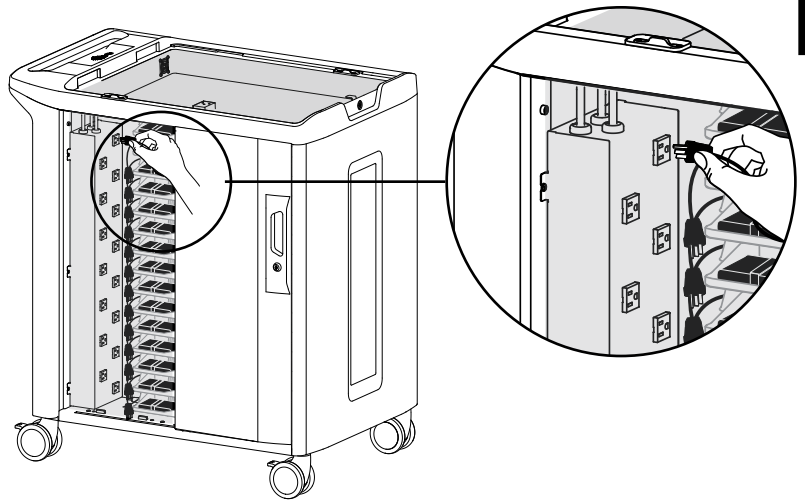

5 Insert mobile devices and connect cables.

a

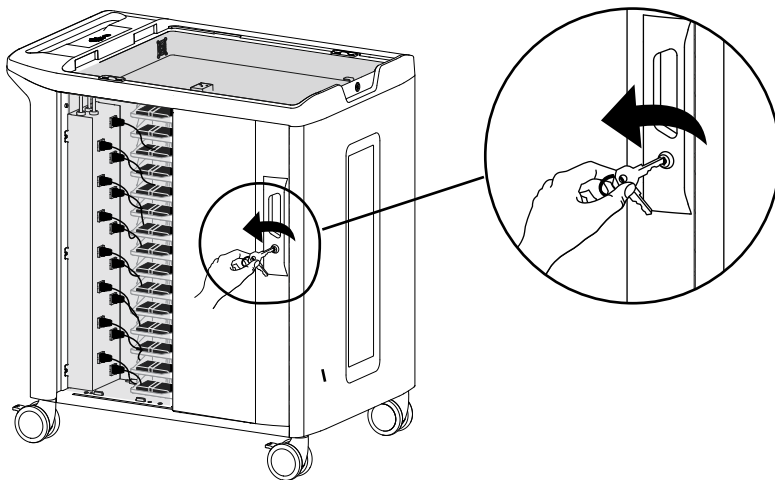

b

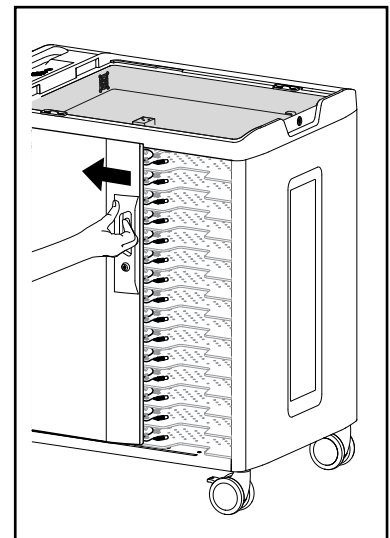

c

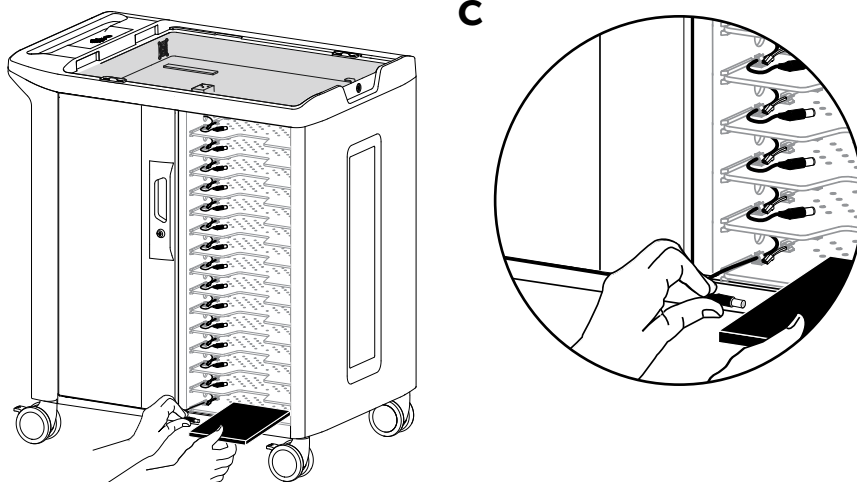

6 Verify cart operation

Connect the cart power cable to a dedicated circuit, (one that is not being shared with other mobile devices).

Verify that the white light on the Power Indicator near the cart top surface is lit.

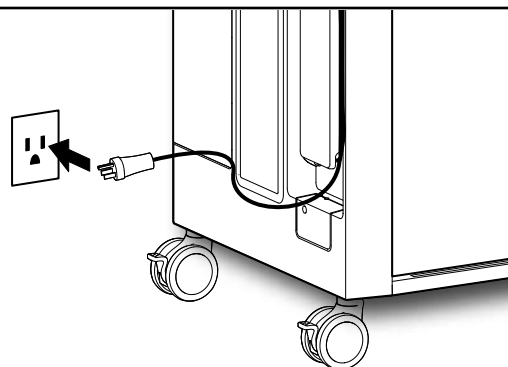

First-Time battery charge

NOTE: Before using the mobile devices for the first time or after they have spent some time in storage, ensure that the mobile devices have a full (100%) charge.

Prior to first-time use, allow the mobile devices to charge in the cart for at least 2-3 hours before removing them for use.

Monitoring mobile device power

The Power/Fault Status Indicator lights near the cart top surface communicate the following conditions:

Power/Fault Status Indicator

Signal

Meaning

Zones

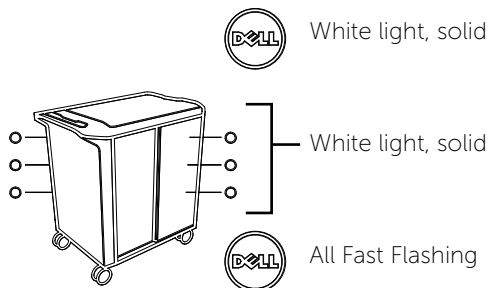

White light, solid

Power "ON"



White light, solid

Zone is charging



All Fast Flashing

Overcurrent. Reset by removing excess devices on aux outlet. Unplug and re-plug the cart.



NOTE: Charge status of individual mobile devices can be seen directly on mobile devices.

Notebook Shelf Removal

a. Release the shelf by lifting up on the tab.

b. Pull shelf out.

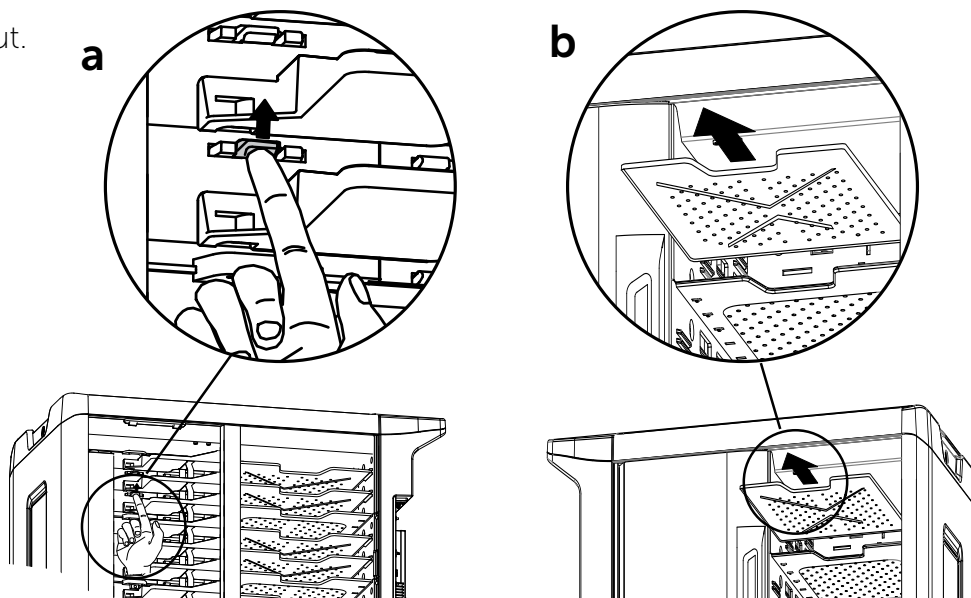



Service and Warranty

For service, visit www.ergotron.com/Dell
or www.dell.com/support

NOTE: When contacting customer service reference the serial number located above the external cable management bay.



Serial Number is required for warranty entitlement.

Made in China DP/N 00317X

 CN-00317X-ERD00-XXX-###
 Service Tag: ABC1234

 Rev A00

Power System

220-240V~, 10A MAX, 50/60 Hz

Cart Physical Dimensions

Height	1,060 mm (41.7-inches)
Length	940.6 mm (37-inches)
Width	640 mm (25.2-inches)
Weight (without Mobile Devices)	87 kg (191.8 lb)
Weight Capacity:	
Top Surface	11.3 kg (25 lb)
Shelves	2.7 kg (6 lb)
Tip Test/Angle	10 degrees

Generally compatible with most 14" display devices and some 15.6" devices. Compatible Dell 15.6" models: Dell E5540 (requires Dell Right Angle Adapter Kit, sold separately) and E6540

Environmental

Temperature range:

Operating	0° to 30°C (32° to 86°F)
Storage	-29° to 60°C (-20° to 140°F)

Relative humidity (maximum):

Operating	10%–90% (non condensing)
Storage	5%–95% (non condensing)



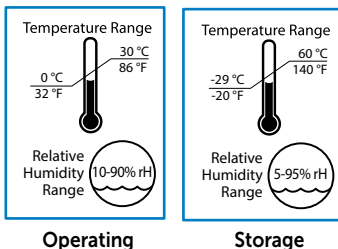

Altitude (maximum): 2000 m (6,562 ft)



Product and Safety Alerts

Hazard Symbols Review

These symbols alert users of a safety condition that demands attention. All cart users should be able to recognize and understand the significance of the following Safety Hazards if encountered on the cart or within cart documentation. Children who are not able to recognize and respond appropriately to Safety Alerts should not use the cart without adult supervision!

Symbol	Signal Word	Level of Hazard
	NOTE	A NOTE indicates important information that helps you make better use of your cart.
	CAUTION	A CAUTION indicates either potential damage to hardware or loss of data and tells you how to avoid the problem.
	WARNING	A WARNING indicates either potential for property damage, personal injury, or death.
	ELECTRICAL	An ELECTRICAL indicates an impending electrical hazard which, if not avoided, may result in personal injury, fire and/or death.

Equipment Electrical Safety

There are specific risks associated with the use of equipment having power cables. You must be aware of, and avoid these risks when the Cart is located in close proximity to children.

 **WARNING:** Failure to observe the following Electrical Safety notices can result in fire or death by electric shock.

 **Electrical:** Electrical cables can be hazardous. Misuse can result in fire or death by electrical shock.

- Double Pole / Neutral Fusing
- Inspect power cables thoroughly before each use.
- Do not use cables that are damaged.
- Insert the plug completely into the outlet.
- Grasp the plug to remove from the outlet.
- Do not unplug by pulling on the cable.
- Do not use excessive force to make connections.
- Use only Dell power adapters that come with Dell systems with this cart.
- Do not plug the cable into an extension cable.
- Do not remove, bend or modify any metal prongs or pins of cable.
- Do not drive, drag or place objects over the cable.
- Do not walk on the cable.
- Avoid overheating. Uncoil the cable and do not cover it with any material.
- Do not run cable through doorways, holes in ceilings, walls or floors.

 **Electrical: Keep the Cart away from water.**

- Do not use it when wet.
- Do not place the Cart in close proximity to flammable liquids or gases.

 **CAUTION:** Observe all the safety precautions related to the Dell Cart operation and maintenance included in this reference guide! Failure to follow the safety precautions may result in injury or damage to equipment.

 **CAUTION:** There is no on/off switch on this equipment; the only power disconnect is the AC power cable. Therefore, the socket outlet should be easily accessible and should be installed near the equipment.

 **DANGER!**
Risk of Electric Shock

DANGER! Electrical cables can be hazardous. Misuse can result in fire or death by electrical shock.





Cleaning and Maintenance

 **WARNING:** Failure to observe the following safety notices may result in serious personal injury or equipment damage.

Inspect for damage, dirt and debris on a regular basis. All paint and plastic components used in the Cart will withstand cleaning by most commonly used, diluted, non-abrasive solutions such as quaternary ammonia compounds, ammonia enzyme cleaners, bleach, or alcohol solutions. It is recommended that any cleaning solution be tested on a small, inconspicuous area to ensure it does not harm the surface of the Cart.

- Marks from permanent marker, dry-erase marker, and pens can be removed with 91% isopropyl alcohol and a soft cloth.
- Iodine stains can be removed with commonly used cleaners and a soft cloth.
- Do not use steel wool or other abrasive materials that may damage the surface finish.

 **Electrical:** To avoid risk of electric shock, do not expose electrical components to water, cleaning solutions or other potentially corrosive liquids or substances.

 **Electrical:** Do not immerse Cart or Cart components in liquid or allow liquids to flow into the Cart. Wipe all cleaners off surface immediately using a damp cloth. Dry the surface thoroughly after cleaning.

 **Electrical:** Do not use flammable cleaners on Cart surfaces.

 **CAUTION:** Adjustment, Service, Replacement - DO NOT attempt to adjust, service or replace any part of the Cart unless directed to do so through Ergotron-approved documentation (i.e. installation instructions). Only Ergotron, Inc. or an Ergotron-certified entity may adjust, service or replace Cart components. If any component on the Cart is missing or damaged, the Cart must not be used. Contact Ergotron immediately to request a replacement part.

 **CAUTION:** Casters - Check casters periodically to make sure they are clean and free of debris that would prevent smooth travel. Avoid moving Cart across uneven, dirty, or damaged surfaces.

 **CAUTION:** Customer Equipment- Make sure equipment is balanced and installed securely to Cart. Contact Ergotron for information about moving Cart components.

 **CAUTION:** Changes or Modifications not expressly approved by Ergotron could void the user's authority to operate the equipment.

Safe Use Recommendations

There are specific risks associated with the use of Cart when moving or stationary (for charging or storage). You must be aware of, and avoid these risks when the Cart is located in close proximity to children.



WARNING: Failure to observe the following Cart Use Safety notices may result in serious personal injury or equipment damage.

Only Adults should move this cart.

- Do not allow anyone to sit, stand, or climb on the Cart.
- Do not lift the Cart from the bottom.
- Do not block the fans and vent openings. To prevent overheating, leave at least 127 mm (5-inch) clearance around fans and vents.

The Cart is designed to be used indoors only.

- Do not use the Cart to transport or store equipment other than what has been noted in this guide.
- Do not use the Cart to store liquids or cleaning supplies.
- Do not place heavy objects on the Cart surface or shelf.
 - The maximum weight capacity of the top surface is 11.4 kg (25 lb).
 - The maximum weight capacity of the shelf is 22.5 kg (49.5 lb).

Moving the Cart

- Before moving the Cart:
 1. Disconnect the power cable from the wall.
 2. Make sure the cable is wrapped and secure.
 3. Close and lock the doors.
 4. Remove items from the top work surface.
 5. Unlock the casters.
- Push (do not pull) the Cart for optimum maneuverability and to prevent muscle strain.
- Do not move the Cart across rough, uneven or irregular surfaces such as gravel.

Parking the Cart

Observe these safety alerts for times when the cart is stationary:

- Do not park the Cart in areas of heavy traffic.
- Do not run cables through doorways, holes in ceilings, walls, or floors.
- Do not run cables across hallways, classrooms, or other areas where they will be walked on.
- Do not leave Cart unattended in areas where children have access.
- Keep Cart doors closed and locked whenever it is unattended or parked for charging or storage.
- Keep Cart casters locked whenever it is unattended.



Safety, Environmental, and Regulatory Information

Regulatory Notices

For additional regulatory information, see the Regulatory Compliance homepage on www.dell.com at the following location: www.dell.com/regulatory_compliance.

Waste Electrical and Electronic Equipment (WEEE) Directive

 This label indicates that this product should not be disposed of with household waste. It should be deposited at an appropriate facility to enable recovery and recycling. For information on how to recycle this product in your country, please visit: Dell.com/recycle.

Директива относно отпадъци от електрическо и електронно оборудване (OEEO)

 Този етикет означава, че този продукт не бива да се изхвърля заедно с домакинските отпадъци. Той трябва да бъде изхвърлен на подходящо място, за да се позволи възстановяването или рециклирането му. За информация относно отговорността за рециклиране на този продукт във вашата страна посетете: Dell.com/recycle.

Směrnice o odpadních elektrických a elektronických zařízeních (OEEZ)

 Tento štítek označuje, že tento produkt nesmí být likvidován s domovním odpadem. Musí být předán specializované sběrně k recyklaci a dalšímu využití. Pokud o recyklaci tohoto produktu ve vaší zemi víz adresa Dell.com/recycle.

Direktiv for bortskaffelse af elektrisk og elektronisk udstyr (WEEE)

 Denne etiket indikerer, at dette produkt ikke bør kasseres sammen med husholdningsaffald. Det bør bortskaffes ved en egnet facilitet for at muliggøre genbrug. For information om hvordan dette produkt genbruges i dit land, bedes du gå til: Dell.com/recycle.

WEEE-richtlijn, Waste Electrical and Electronic Equipment (afdenken van elektrische en elektronische apparaten)

 Dit label geeft aan dat dit product niet via huishoudelijk afval mag worden afgedankt. Het moet worden gedeponeerd bij een daarvoor geschikte voorziening zodat herstel en recycling mogelijk zijn. Raadpleeg voor meer informatie over verantwoorde recycling van dit product in uw land de website: Dell.com/recycle.

Elektriliste ja elektroniliste seadmete kasutusjärgne töötlemine (direktiiv WEEE)

 Selline silt tähistab toodet, mida ei tohi pärast kasutust olmejäätmete hulka visata. Toote toode tuleb via jäätmekäitlustevõttesse, kus seda nõuetekohaselt töödeldakse. Toote käitlemise kohta oma kodumaal leiate teavet aadressilt Dell.com/recycle.

Direktiivi sähkö- ja elektroniikkalaiteromusta (WEEE)

 Tämä tarra tarkoittaa, että tuotetta ei tule hävittää kotitalousjätteen joukossa. Se tulee toimittaa asianmukaiseen pakkaan uudelleenkäyttöä tai kierrätystä varten. Tietoja tämän tuotteen kierrättämisestä eri maissa saat seuraavasta osoitteesta: Dell.com/recycle.

Directive sur la mise au rebut des appareils électriques et électroniques (Waste Electrical and Electronic Equipment - WEEE)

 Cette étiquette indique que ce produit ne doit pas être jeté avec les déchets ménagers. Il doit être mis au rebut dans un centre de dépôt spécialisé pour un recyclage approprié. Pour obtenir davantage d'informations sur le recyclage approprié de ce produit dans votre pays, veuillez vous rendre sur le site : Dell.com/recycle.

Richtlinie für Abfall von elektrischen und elektronischen Geräten (WEEE)

 Dieses Etikett weist darauf hin, dass dieses Produkt nicht mit dem Hausmüll entsorgt werden sollte. Es sollte an einer entsprechenden Einrichtung abgegeben werden, um Wiedergewinnung und Recycling zu ermöglichen. Weitere Informationen über das Recyceln dieses Produkts erhalten Sie unter: Dell.com/recycle.

Οδηγία σχετικά με τα απόβλητα ειδών ηλεκτρικού και ηλεκτρονικού εξοπλισμού (AHHE)

 Αυτή η ετικέτα υποδεικνύει ότι το συγκεκριμένο προϊόν δεν πρέπει να απορρίπτεται μαζί με τα οικιακά απόβλητα. Θα πρέπει να αποκομίζεται σε κατάλληλο χώρο ώστε να είναι δυνατή η ανάκτηση και η ανακύκλωση. Για πληροφορίες σχετικά με την ανακύκλωση αυτού του προϊόντος στη χώρα σας, επισκεφθείτε τη διεύθυνση: Dell.com/recycle.

Waste Electrical and Electronic Equipment (WEEE), azaz az elektromos és elektronikus berendezések hulladékaira vonatkozó irányelv

 Az ilyen címkével jelölt terméket tilos háztartási hulladékként kezelni. Az ilyen hulladékot a helyreállthatóság és az újrahasznosíthatóság érdekében a megfelelő elfogadóhelyre kell szállítani. A termék saját országán belül érvényes újrahasznosításával kapcsolatos információkat a következő weboldalon talál: Dell.com/recycle.

Direttiva Rifiuti di apparecchiature elettriche ed elettroniche (RAEE)

 Questa etichetta indica che il prodotto non deve essere smaltito insieme ai rifiuti domestici. Deve essere depositato in un impianto adeguato che sia in grado di eseguire operazioni di recupero e riciclaggio. Per informazioni sulle procedure di riciclaggio di questo prodotto nel proprio Paese, visitate: Dell.com/recycle.

Direktiva par elektrisko un elektronisko iekārtu atkritumiem (EIEA)

 Šis apzīmējums norāda, ka produktu nedrīkst izmest kopā ar sadzīves atkritumiem. Tas ir jānodod atbilstošā savākšanas punktā, lai parāzi atjaunotu vai pārstrādātu. Informāciju par šī produkta pārstrādes iespējām jūs varat skatīt: Dell.com/recycle.

Direktiva dėl elektros ir elektroninės įrangos atliekų (Waste Electrical and Electronic Equipment, WEEE)

 Šis ženklas rodo, kad šio gaminio negalima išmesti kartu su buitinėmis atliekomis. Nebenaudojamą gaminį reikia atiduoti į tam skirtą punktą atnaujinti arba perdirbti. Informacijos apie tinkamą šio gaminio perdirbimą jūsų šalyje rasite interneto svetainėje: Dell.com/recycle.

Direttiva dwar Skart magħmul minn Tagħmir Elettroniku u Elettriku (Waste Electrical and Electronic Equipment - WEEE)

 Din it-tikketta tindika li dan il-prodott m'għandux jintrema mal-iskart domestiku. Għandu jintrema f'faċilità adatta fejn 'kun jista' jiġi rkuprat u nikklat. Għal aktar taġġir dwar kif għandek ttrickla dan il-prodott fil-pajjiż tiegħek, jekk jogħġbok zur: Dell.com/recycle.

Direktivet om elektrisk og elektronisk utstyr (WEEE)

 Dette merket angir at produktet ikke skal kastes sammen med husholdningsaffald. Det skal leveres til et mottak for spesialavfall for gjenvinning og resirkulering. Du finner informasjon om hvordan du resirkulerer dette produktet i ditt land her: Dell.com/recycle.

Dyrektiva dotycząca odpadów urządzeń elektrycznych i elektronicznych (WEEE)

 Etykieta ta oznacza, że tego produktu nie należy wyrzucać razem z odpadami z gospodarstwa domowego. Należy go przekazać do odpowiedniego zakładu, gdzie zostanie poddany odzyskowi i recyklingowi. Informacje o sposobie recyklingu tego produktu w poszczególnych krajach można znaleźć pod adresem: Dell.com/recycle.

Direttiva WEEE (Waste Electrical and Electronic Equipment)

 Esta etiqueta indica que esse produto não deve ser eliminado juntamente com o lixo normal. Deve ser depositado numa instalação apropriada para recolha e reciclagem. Para obter informações sobre como reciclar este produto de forma responsável no seu país, visite: Dell.com/recycle.

Direttiva privind deșeurile provenite din echipamentele electrice și electronice (WEEE)

 Această etichetă indică faptul că acest produs nu trebuie aruncat laolaltă cu gunoiera menajeră. Trebuie depozitat într-un loc special amenajat pentru a permite recuperarea și reciclarea. Pentru informații privitoare la reciclarea acestui produs în țara dvs., accesați: Dell.com/recycle.

Директива об утилизации электрического и электронного оборудования (WEEE)

 Эта маркировка означает, что данный продукт не следует утилизировать вместе с бытовым мусором. Продукт следует утилизировать на специализированном предприятии, чтобы в дальнейшем его можно было переработать. Информацию о правилах утилизации изделия в вашей стране можно получить на веб-узле Dell.com/recycle.

Smernica o odpadoch z elektrických a elektronických zariadení (WEEE)

 Tento štítek znamená, že sa výrobok nesmie likvidovať ako komunálny odpad. Musí sa odovzdať na príslušnom mieste na obnovu alebo recykláciu. Informácie o správnej recyklácii tohto produktu vo vašej krajine nájdete na stránke: Dell.com/recycle.

Direttiva o odlaganju električne in elektronske opreme (WEEE)

 Ta znak označuje, da izdelek ni primeren za odlaganje skupaj z običajnimi gospodinjimi odpadki. Odložiti ga je treba na ustreznem mestu za odlaganje in reciklazo. Za informacije o reciklazi tega izdelka v vaši državi obiščite: Dell.com/recycle.

Residuo de Aparatos Eléctricos y Electrónicos (RAEE)

 Esta etiqueta indica que la eliminación de este producto no se puede hacer junto con el deshecho doméstico. Se debe depositar en una instalación apropiada que facilite la recuperación y el reciclado. Para obtener más información sobre cómo reciclar este producto en su país, visite el sitio web: Dell.com/recycle.

Direktiv för kassering av elektrisk och elektronisk utrustning (WEEE - Waste Electrical and Electronic Equipment)

 Den här etiketten betyder att produkten inte får slängas i hushållsavfallet. Den ska lämnas in på en återvinningsstation. Information om hur produkten återvinns i ditt land finns på adressen Dell.com/recycle. Inom EU betyder den här etiketten att produkten inte får slängas i hushållsavfallet. Den ska lämnas in på en återvinningsstation. Information om hur produkten återvinns i ditt land finns på adressen Dell.com/recycle.

Atik Elektrikli ve Elektronik Ekipman (WEEE) Yönergeleri

 Bu etiket, ürünün ev elektrikli aletleri atılan ile imha edilemeyeceğini gösterir. Kurtarmak ve geri dönüştürümü sağlamak için uygun şartlarda saklanması gerekir. Bu ürünün geri dönüşümünün nasıl sağlanacağı konusunda bilgi için lütfen şu adresi ziyaret edin: Dell.com/recycle.

Safety, Environmental, and Regulatory Information

FCC Compliance Statement

This cart has been tested and found to comply with the limits for a Class A digital device, pursuant to Part 15 of the FCC rules. These limits are designed to provide reasonable protection against harmful interference when the equipment is operated in a commercial environment. This equipment generates, uses, and can radiate radio frequency energy and, if not installed and used according to the instructions, may cause harmful interference to radio communications. Operation of this equipment in a residential area is likely to cause harmful interference in which case the user will be required to correct the interference at their own expense.

Operation of this equipment is subject to the following two conditions: (1) this device may not cause harmful interference, and (2) this device must accept any interference received, including interference that may cause undesired operation.

FCC Caution: Changes or Modifications not expressly approved by Ergotron could void the user's authority to operate the equipment.

This Class A digital apparatus complies with Canadian CAN ICES-3(A)/NMB-3(A). / Cet appareil numérique de la classe A est conforme à la norme CAN ICES-3(A)/NMB-3(A) du Canada.

Registration, Evaluation, Authorization of Chemicals (REACH)

REACH is the European Union (EU) chemical substances regulatory framework. Information on substances of very high concern contained in Dell products in a concentration above 0.1% weight by weight (w/w) can be found at Dell.com/REACH.

Регламент относено регистрацията, оценката, разрешаването и ограничаването на химикали (REACH)

REACH е регулаторната рамка на Европейския съюз (ЕС) за химически вещества. Информация за вещества с много голяма важност, съдържащи се в изделия на Dell в концентрация над 0,1% обемни проценти (w/w), може да се намери на адрес: Dell.com/REACH.

Směrnice REACH (Registration, Evaluation, Authorization of Chemicals)

REACH označuje v Evropské unii (EU) regulační rámec chemických látek. Informace o nebezpečných látkách, které jsou ve výrobních společnostech Dell obsaženy v koncentraci větší než 0,1 hmotnostních procent, naleznete na adrese Dell.com/REACH.

Registration, Evaluation, Authorization of Chemicals (REACH)

REACH er forordningsstrukturen for kemiske stoffer i den Europæiske Union (EU). Oplysninger om substanser, som er af stor bekymring, og som er indeholdt i Dell-produkter i en koncentration over 0,1 vægtprocent kan findes på Dell.com/REACH.

Registration, Evaluation, Authorization of Chemicals (REACH)

REACH is het regelgevingskader van de Europese Unie (EU) op het gebied van chemische stoffen. Informatie over zeer gevaarlijke stoffen in Dell-producten in een concentratie van boven de 0,1% gewicht per gewicht (w/w) is te vinden op Dell.com/REACH.

Kemikaalide registreerimine, hindamine ja autoriseerimine (REACH)

REACH on kemikaale käsitlev Euroopa Liidu (EU) regulatiivne raamistik. Teave ohtlike ainete kohta, mis sisalduvad Dell'i toodetes kontsentratsioonis üle 0,1 massiprotsendi, on saadaval aadressil Dell.com/REACH.

Kemikaalien rekisteröinti, arviointi ja lupamenettelyt (REACH)

REACH on Euroopan unionin (EU) kemiallisten aineiden puitekehyks. Tietoja haitallisista aineista, joiden massaprosentti (w/w) Dellin tuotteissa on enimminkin kuin 0,1 prosenttia, on osoitteessa Dell.com/REACH.

Enregistrement, évaluation, autorisation des produits chimiques (REACH)

REACH est le programme de réglementation des produits chimiques dans l'Union européenne (UE). Vous trouverez des informations sur les substances très préoccupantes que contiennent les produits Dell en concentration supérieure à 0,1 % en poids par poids (p/p) sur Dell.com/REACH.

Registrierung, Beurteilung und Zulassung von Chemikalien (REACH, Registration, Evaluation, Authorization of Chemicals)

Die EU-Richtlinie REACH ist das Regelwerk der Europäischen Union für chemische Substanzen. Informationen zu bedenklichen Substanzen, die in Dell-Produkten in einer Konzentration von mehr als 0,1 Gewichtsprozent (w/w, Weight by Weight) enthalten sind, finden Sie unter Dell.com/REACH.

Οδηγία REACH (Καταχώριση, αξιολόγηση και αδειοδότηση χημικών προϊόντων)

Η οδηγία REACH είναι το κανονιστικό πλαίσιο της ΕΕ για τις χημικές ουσίες. Πληροφορίες σχετικά με ουσίες που προκαλούν πολύ μεγάλη ανησυχία και περιέχονται σε προϊόντα της Dell σε συγκέντρωση άνω του 0,1% κατά βάρος (κ.β.) μπορείτε να βρείτε στη διεύθυνση Dell.com/REACH.

A vegyi anyagok regisztrálására, értékelésére, engedélyezésére és korlátozására vonatkozó szabályozás (REACH)

A REACH az Európai Unió (EU) vegyi anyagokra vonatkozó szabályozó keretrendszer. A Dell termékekben 0,1% feletti arányban található veszélyes anyagokról a következő címen található bővebb információkat: Dell.com/REACH.

Registrazione, valutazione e autorizzazione delle sostanze chimiche (REACH)

REACH è il quadro normativo delle sostanze chimiche dell'Unione Europea (UE). Le informazioni sulle sostanze estremamente problematiche contenute nei prodotti Dell in una concentrazione superiore allo 0,1% in peso per peso (p/p) sono disponibili all'indirizzo Dell.com/REACH.

Ķīmisko vielu registrācija, vērtēšana, autorizācija (REACH)

REACH ir Eiropas Savienības (ES) ķīmisko vielu regulēšanas sistēma. Informāciju par īpaši bīstamām ķīmiskajām vielām, ko satur Dell produkti koncentrācijā virs 0,1% svaram uz svaru (w/w), var atrast vietnē Dell.com/REACH.

Cheminių medžiagų registracija, įvertinimas, autorizacija (REACH)

REACH yra Europos Sąjungos (ES) cheminių medžiagų kontrolės sistema. Informacija apie didelį susirūpinimą keliančias medžiagas, kurių koncentracija „Dell“ produktuose pagal svorį yra didesnė nei 0,1 % svorio (s/s), galima rasti adresu Dell.com/REACH.

Registrazzjoni, Evalwazzjoni, Awtorizzazzjoni ta' Kimiċi (REACH)

REACH hu l-għafas regolatorju tal-Unjoni Ewropea (UE) għal sustanzi kimiċi. Informazzjoni dwar sustanzi li jikkawżaw tħassib kbir fi prodotti ta' Dell f'koncentrazzjoni ta' iżjed minn 0,1% piz b'piz (w/w) tista' tintab f' Dell.com/REACH.

Registrering, vurdering og godkjenning av kjemikalier (REACH)

REACH er Den europeiske union (EU)'s forskriftsmessige rammeverk for kjemiske stoffer. Informasjon om farlige stoffer i Dell-produkter i en konsentrasjon over 0,1 % vektprosent (w/w) finnes på Dell.com/REACH.

Rozporządzenie REACH (ang. Registration, Evaluation, Authorization of Chemicals)

REACH jest rozporządzeniem Unii Europejskiej (UE) dotyczącym substancji chemicznych. Informacje na temat istotnych substancji obecnych w produktach Dell w stężeniu procentowym masowym powyżej 0,1% można znaleźć pod adresem Dell.com/REACH.

REACH (Registration, Evaluation, Authorization of Chemicals - Registo, avaliação e autorização de substâncias químicas)

O REACH é o sistema regulador de substâncias químicas da União Europeia (UE). As informações sobre substâncias que são motivo de grande preocupação existentes nos produtos Dell numa concentração acima de 0,1% peso por peso (p/p) podem ser encontradas em Dell.com/REACH.

Înregistrarea, evaluarea și autorizarea substanțelor chimice (REACH)

REACH este cadrul de reglementare a substanțelor chimice în Uniunea Europeană (UE). Informații privind substanțele periculoase continute în produsele Dell în concentrații mai mari de 0,1 % din greutate pot fi găsite la adresa web Dell.com/REACH.

Регламент по регистрации, оценке, разрешению и ограничению использования химических веществ (REACH)

REACH - это документ Европейского союза, регламентирующий использование химических веществ. Информация о веществах, содержащихся в продукции Dell в массовой концентрации более 0,1 % (работа с ними требует повышенной осторожности), приведена на сайте Dell.com/REACH.

Registrazioa, vyhodnotenie, autorizacia chemikalii (REACH)

REACH je regulačný rámec chemických látok Európskej únie. Informácie o látkach s veľmi vysokou nebezpečnosťou obsiahnutých v produktoch Dell v koncentrácii vyššej ako 0,1 hmotnostných % (w/w) môžete nájsť na adrese Dell.com/REACH.

Registrazioa, evalvacija, avtorizacija kemikalij (REACH)

REACH je regulativni okvir Evropske unije (EU) za kemične snovi. Informacije o izjemno problematičnih snoveh, ki so v izdelkih podjetja Dell prisotne v koncentracijah nad 0,1 % glede na maso (t/t), so na voljo na strani Dell.com/REACH.

Registro, evaluación y autorización de productos químicos (REACH)

REACH es el organismo de regulación de sustancias químicas de la Unión Europea (UE). La información sobre sustancias de alto riesgo contenidas en productos Dell en una concentración superior al 0,1% peso por peso (p/p) se puede encontrar en Dell.com/REACH.

REACH (Registration, Evaluation, Authorization of Chemicals - registrering, utvärdering, auktorisation av kemikalier)

REACH är den europeiska unionens (EU) regelverk för kemikaliska ämnen. Information om angelägna ämnen i Dell-produkter med koncentration över 0,1 % vikt per vikt (w/w) finns på Dell.com/REACH.

Kimyasal Maddeleri Kaydetme, Değerlendirme ve Onaylama (REACH)

REACH, Avrupa Birliği'nin (AB) kimyasal maddelerle ilgili mevzuatıdır. Dell ürünlerindeki bulunan, ağırlıkça (w/w) %0,1'in üzerinde yoğunluğu sahip yüksek önem arzeden maddelerle ilgili bilgi için: Dell.com/REACH sitesini ziyaret edin.



Warranty

5 years for mechanical components and functions,
3 year for electrical components and functions
and 1 year for cables. All third-party components will follow the warranty as defined by the manufacturer.

CUSTOM SOLUTION FOR DELL BY ERGOTRON

For service, visit www.ergotron.com/Dell
or www.dell.com/support

ERGOTRON®

While Ergotron, Inc. makes every effort to provide accurate and complete information on the installation and use of its products, it will not be held liable for any editorial errors or omissions (including those made in the process of translation from English to another language), or for incidental, special or consequential damages of any nature resulting from furnishing this instruction and performance of equipment in connection with this instruction. Ergotron, Inc. reserves the right to make changes in the product design and/or product documentation without notification to its users. For the most current product information, or to know if this document is available in languages other than those herein, please contact Ergotron. No part of this publication may be reproduced, stored in a retrieval system, or transmitted in any form or by any means, electronic, mechanical, photocopying, recording or otherwise without the prior written consent of Ergotron, Inc., 1181 Trapp Road, Eagan, Minnesota, 55121, USA Patents Pending and Patented U.S. & Foreign. Ergotron is a registered trademark of Ergotron, Inc.

© 2015 Ergotron, Inc. All rights reserved.