



Dell Wired Mouse With Fingerprint Reader MS819

User's Guide



Notes, Cautions, and Warnings

-  NOTE: A NOTE indicates important information that helps you make better use of your Dell wired mouse.
-  CAUTION: A CAUTION indicates potential damage to hardware or loss of data if instructions are not followed.
-  WARNING: A WARNING indicates a potential for property damage, personal injury, or death.

Copyright © 2018 Dell Inc. All rights reserved. This product is protected by U.S. and international copyright and intellectual property laws.

Dell™ and the Dell logo are trademarks of Dell Inc. in the United States and/or other jurisdictions. All other marks and names mentioned herein may be trademarks of their respective companies.

Contents

What's in the box	4
Features	5
Top View	5
Bottom View	6
Setting up your mouse	7
Troubleshooting	10
Specifications	11
General	11
Electrical	11
Physical Characteristics	11
Environmental	11
Statutory information	12
Warranty	12
Limited Warranty and Return Policies	12
For U.S. customers:	12
For European, Middle Eastern and African customers:	12
For non-U.S. customers:	12

What's in the box

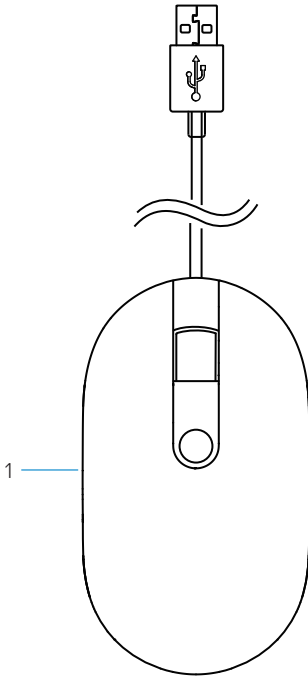

1 fingerprint mouse

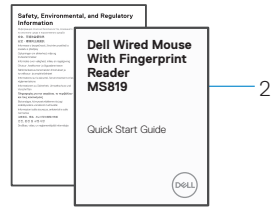

2 documents

Features

Top View

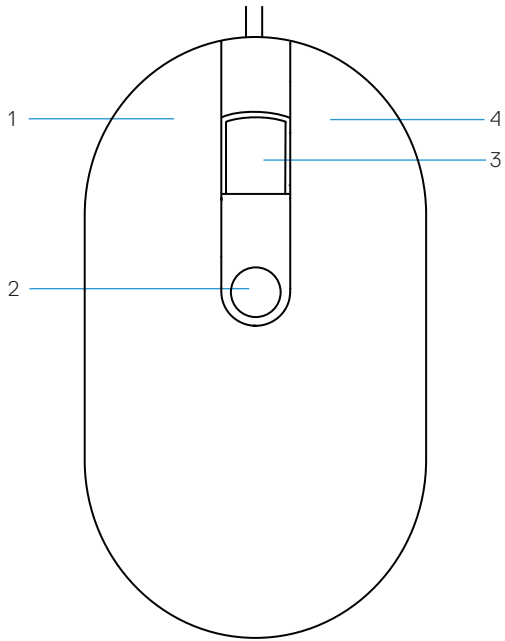

1 left button

2 fingerprint sensor

3 scroll/middle button

4 right button

Bottom View

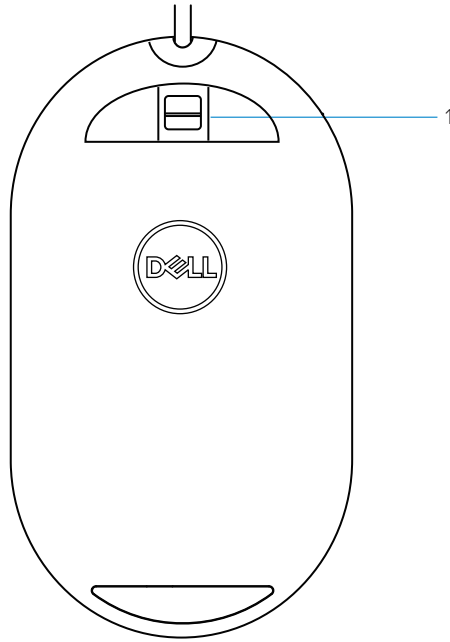

1 optical sensor

Setting up your mouse

1 Connect the mouse to your computer.

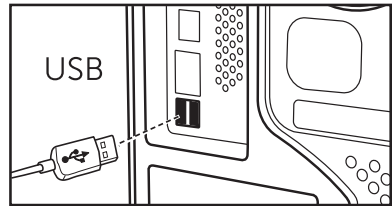
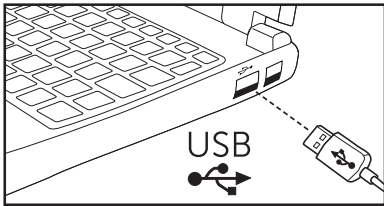

2 Install fingerprint driver through Windows Update.

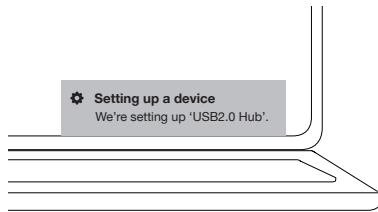

3 Setup Windows password.

[Settings] -> [Accounts] -> [Sign-in options] -> [Password]

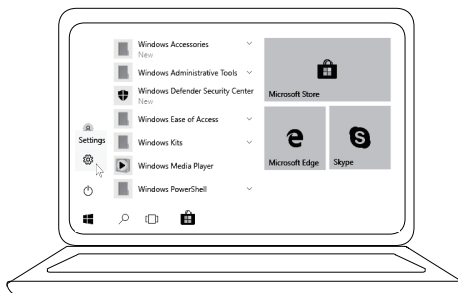

[Settings] -> [Accounts] -> [Sign-in options] -> [Password]

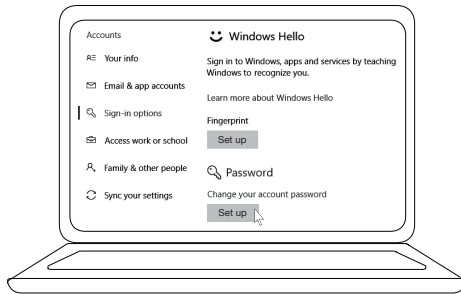

4 Setup Windows Hello process.

[Settings] -> [Accounts] -> [Sign-in options] -> [Windows Hello]

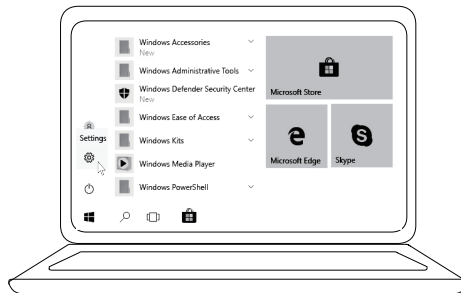

[Settings] -> [Accounts] -> [Sign-in options] -> [Windows Hello]

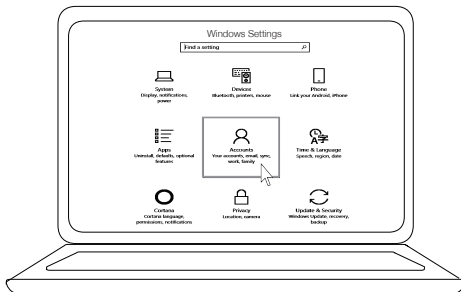

[Settings] -> [Accounts] -> [Sign-in options] -> [Windows Hello]

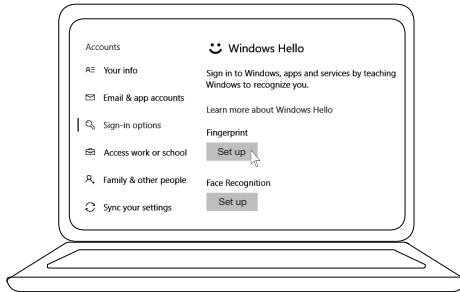

5 Continue touching until 'Windows Hello' setup is completed.

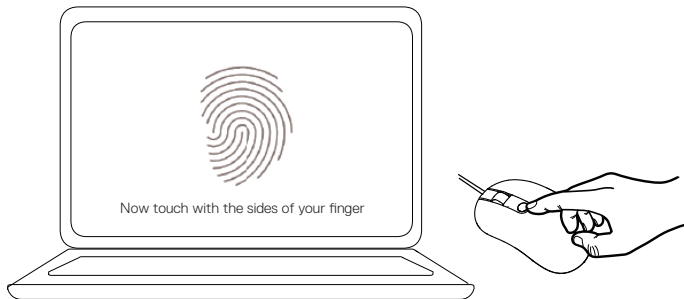

Troubleshooting

Problems

Possible solutions



Unable to use the mouse

1. Disconnect and then connect the mouse USB cable to the computer.
2. Disconnect the mouse USB cable and then reconnect to another USB port.
3. Restart the computer.

Unable to access by registered fingerprints

1. You must add a password before you setup fingerprint.
[Settings] -> [Accounts] -> [Sign-in options] -> [Password] -> [Set up]
2. Remove registered fingerprint.
[Settings] -> [Accounts] -> [Sign-in options] -> [Windows Hello] -> [Remove]
3. Register your fingerprint again.
[Settings] -> [Accounts] -> [Sign-in options] -> [Windows Hello] -> [Set up]

FIDO information

1. Enable SGX in system BIOS.
2. Download Intel Online Connect(IOC) and SGX Platform Software for Windows(PSW) from **www.dell.com/support**.
 -  If your computer is running on Windows RS3 or later, PSW installation is not required.
 -  For more FIDO information, refer to **<https://fidoalliance.org>**

Specifications

General

Model number	MS819
Connection type	Wired USB mouse with fingerprint reader
System requirement	Microsoft Windows 10
Fido payment requirement	Windows 10 and above with SGX enabled.

Electrical

Operating voltage	5 V
Operating power current (maximum)	100 mA

Physical characteristics

Weight (with USB cable)	105 g (0.2315 lb)
Dimensions:	
Length	113.6 mm (4.472 in)
Width	65.0 mm (2.559 in)
Height	36.0 mm (1.417 in)
Cable length	1800 mm (70.87 in)

Environmental

Temperature:	
Operating	0°C to 40°C (32°F to 104°F)
Storage	-40°C to 65°C (-40°F to 149°F)
Operating condition	95% maximum relative humidity; non-condensing
Storage condition	85% maximum relative humidity; non-condensing

Statutory information

Warranty

Limited Warranty and Return Policies

Dell-branded products carry a 1-year limited hardware warranty.

For U.S. customers:

This purchase and your use of this product are subject to Dell's end user agreement, which you can find at www.dell.com/terms. This document contains a binding arbitration clause.

For European, Middle Eastern and African customers:

Dell-branded products that are sold and used are subject to applicable national consumer legal rights, the terms of any retailer sale agreement that you have entered into (which will apply between you and the retailer) and Dell's end user contract terms.

Dell may also provide an additional hardware warranty – full details of the Dell end user contract and warranty terms can be found by going to www.dell.com, selecting your country from the list at the bottom of the “home” page and then clicking the “terms and conditions” link for the end user terms or the “support” link for the warranty terms.

For non-U.S. customers:

Dell-branded products that are sold and used are subject to applicable national consumer legal rights, the terms of any retailer sale agreement that you have entered into (which will apply between you and the retailer) and Dell's warranty terms. Dell may also provide an additional hardware warranty – full details of Dell's warranty terms that can be found by going to www.dell.com, selecting your country from the list at the bottom of the “home” page, and then clicking the “terms and conditions” link or the “support” link for the warranty terms.