

Dell Wireless Mouse and Keyboard KM7171

User's Guide

Regulatory model: KM717



Notes, cautions, and warnings



NOTE: A NOTE indicates important information that helps you make better use of your computer.



CAUTION: A CAUTION indicates either potential damage to hardware or loss of data and tells you how to avoid the problem



WARNING: A WARNING indicates a potential for property damage, personal injury, or death.

Copyright © 2017 Dell Inc. All rights reserved. This product is protected by U.S. and international copyright and intellectual property laws. Dell™ and the Dell logo are trademarks of Dell Inc. in the United States and/or other jurisdictions. All other marks and names mentioned herein may be trademarks of their respective companies.

2017 - 06

Rev. A01

Contents

- Notes, cautions, and warnings 2
- What’s in the box 5
- Features..... 6
 - Mouse 6
 - Top view..... 6
 - Bottom view7
 - Keyboard 8
 - Top view..... 8
- Setting up your wireless mouse..... 9
 - Installing batteries 9
 - Pairing your wireless mouse..... 12
 - Pairing with a USB device..... 12
 - Pairing with a Bluetooth device 13
- Setting up your wireless keyboard 17
 - Pairing your wireless keyboard 19
 - Pairing with a USB device..... 19
 - Pairing with a Bluetooth device 20
- Dell Universal Receiver feature for Windows 23
- Troubleshooting..... 24
- Specifications..... 28
- Statutory information 30

Warranty	30
Limited warranty and return policies	30
For U.S. customers:	30
For European, Middle Eastern and African customers:	30
For non-U.S. customers:	30

What's in the box

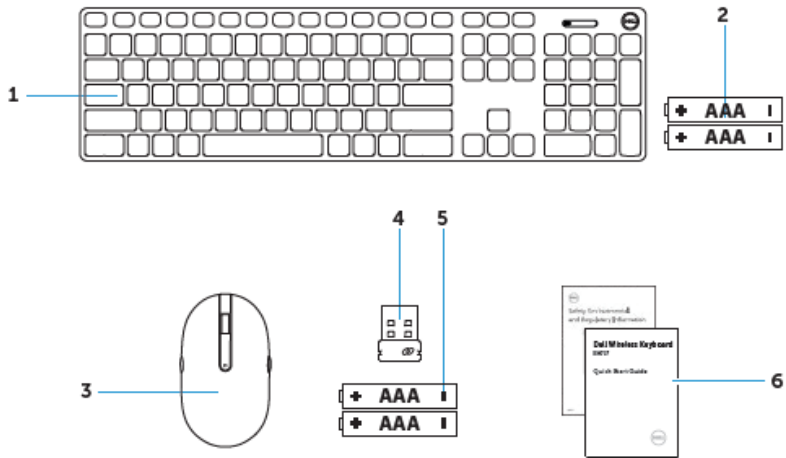

1 wireless keyboard

2 AAA-type

3 wireless mouse

4 USB receiver

5 AAA-type

6 documents

Features

Mouse

Top view

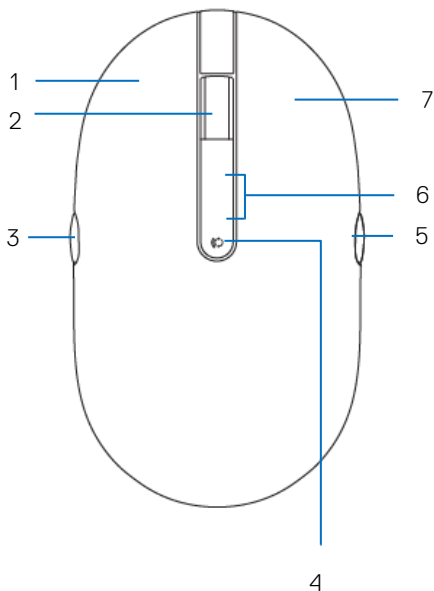

- | | | | |
|---|---------------|---|------------------------|
| 1 | left button | 2 | scroll/middle button |
| 3 | page backward | 4 | connection-mode button |
| 5 | page forward | 6 | connection-mode light |
| 7 | right button | | |

Bottom view

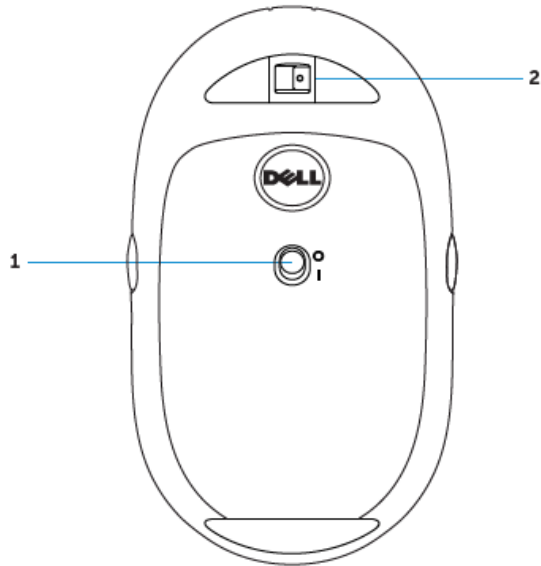

1 power switch

2 laser sensor

Keyboard

Top view

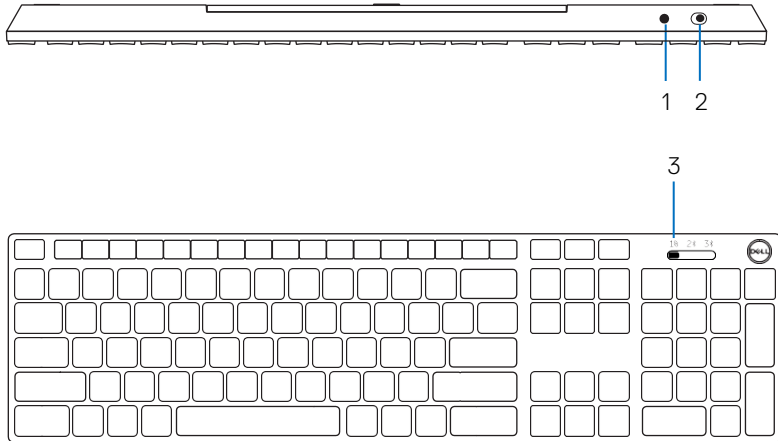

1 Bluetooth-pairing button

2 power switch

3 connection-mode switch

Setting up your wireless mouse

Installing batteries

- 1 Remove the mouse cover.

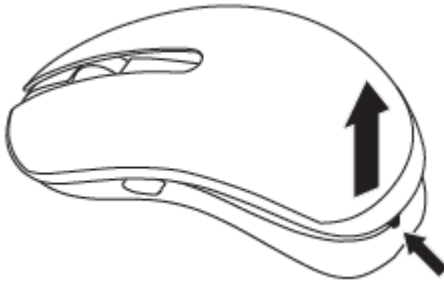

- 2 Open the battery clamp.

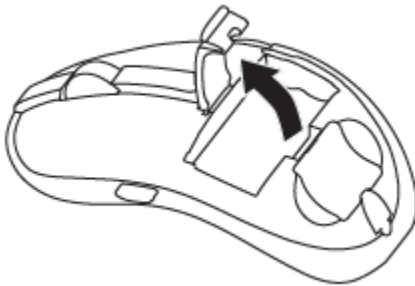

- 3 Install the AAA batteries into the battery compartment.



- 4 Close the battery clamp.

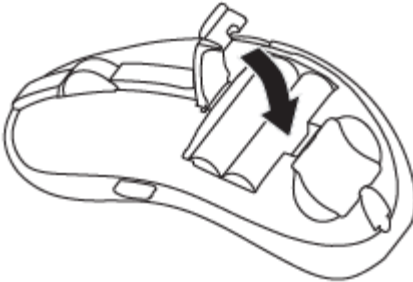

- 5 Replace the mouse cover.

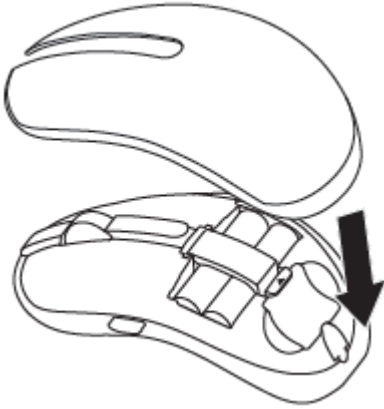

- 6 Slide the power switch to power on the mouse.



NOTE: Make sure the distance between your computer and mouse is within 10 meters.

Pairing your wireless mouse

Your Dell wireless mouse can be paired with devices using USB and Bluetooth. You can pair and switch between a laptop, desktop, and a compatible mobile device.

Pairing with a USB device



You could connect a device to your wireless mouse using the Dell Universal pairing.

- 1 Install the Dell Universal USB receiver to the USB port on your computer.

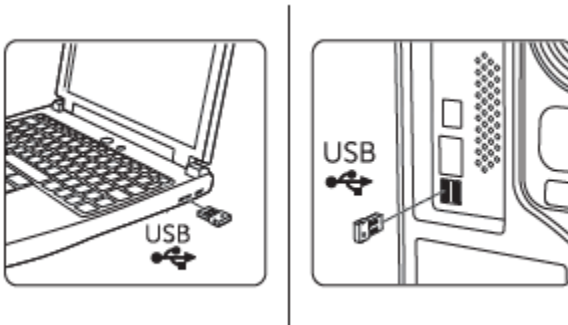

- 2 The connection-mode light on the mouse turns on to indicate the Dell Universal pairing, then turns off.

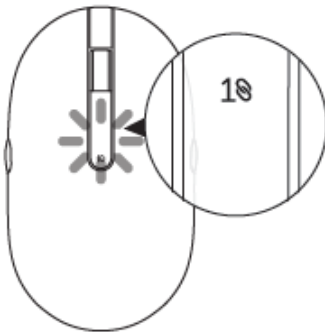

- 3 The mouse is paired with your USB device.



Pairing with a Bluetooth device

You could connect up to two devices to your wireless mouse using Bluetooth.

Pairing device two using Bluetooth



You could connect a second device to your wireless mouse using Bluetooth.

- 1 Press the connection-mode button on your mouse until the connection-mode light indicates that the second-Bluetooth connection is selected.

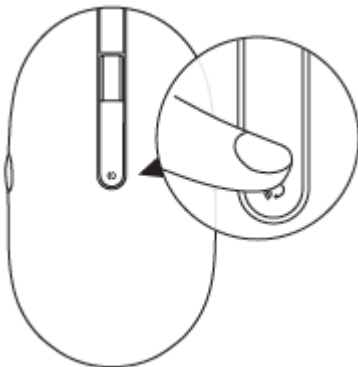

- 2 The second-Bluetooth connection light starts blinking to confirm the pairing mode is enabled.

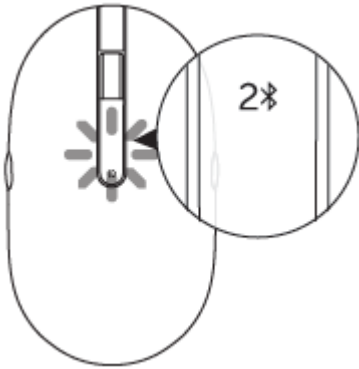

- 3 In Windows Search, type Bluetooth.
- 4 From the list that appears, click Bluetooth Settings.
- 5 Ensure that Bluetooth is enabled.
- 6 From the list of devices, click Dell WM527 → Pair.



NOTE: If Dell WM527 is not listed, ensure pairing mode is enabled on the mouse.

- 7 Confirm the pairing process on both mouse and device.
The second-Bluetooth connection light turns solid white for a few seconds to confirm the pairing and then the light turns off. After the mouse and a device are paired, they connect automatically when Bluetooth is enabled and they are within the Bluetooth range.

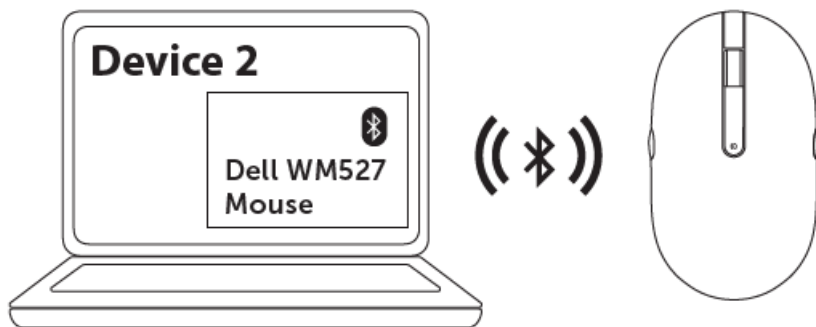

Pairing device three using Bluetooth



You could connect a third device to your wireless mouse using Bluetooth.

- 1 Press the connection-mode button on your mouse until the connection-mode light indicates that the third-Bluetooth connection is selected.

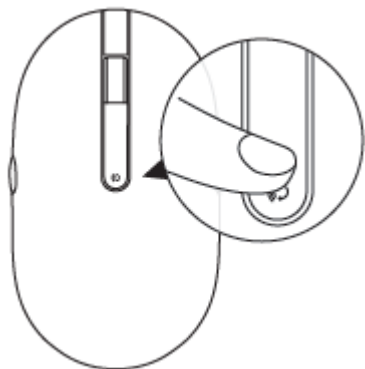

- 2 The second-Bluetooth connection light starts blinking to confirm the pairing mode is enabled.

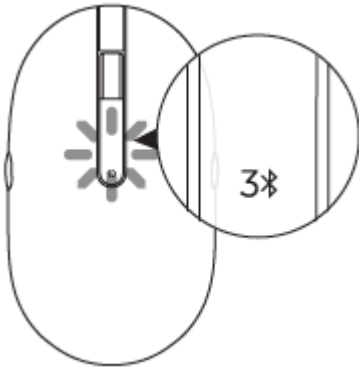

- 3 In Windows Search, type Bluetooth.
- 4 From the list that appears, click Bluetooth Settings.
- 5 Ensure that Bluetooth is enabled.
- 6 From the list of devices, click Dell WM527 → Pair.



NOTE: If Dell WM527 is not listed, ensure pairing mode is enabled on the mouse.

- 7 Confirm the pairing process on both mouse and device.
The third-Bluetooth connection light turns solid white for a few seconds to confirm the pairing and then the light turns off. After the mouse and a device are paired, they connect automatically when Bluetooth is enabled and they are within the Bluetooth range.

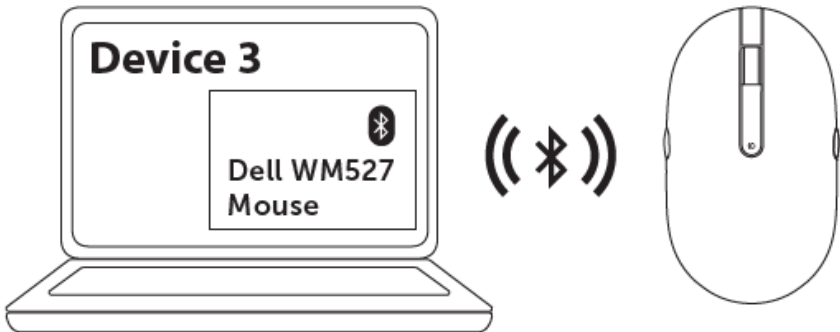

Setting up your wireless keyboard

- 1 Remove the battery cover.

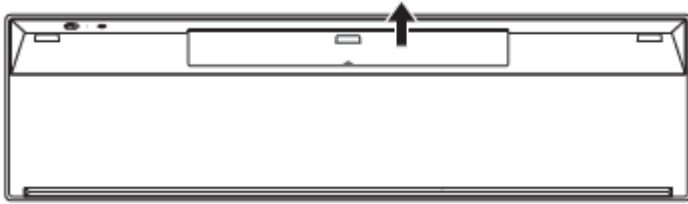

- 2 Install the AAA batteries into the battery compartment.

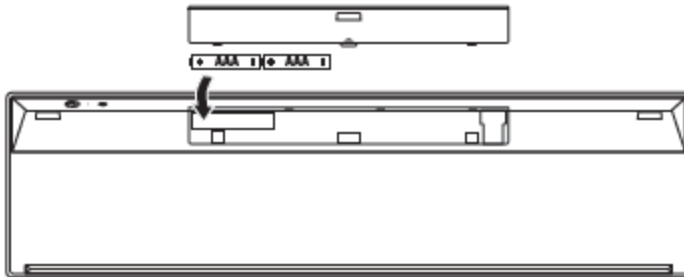

- 3 Replace the battery cover.

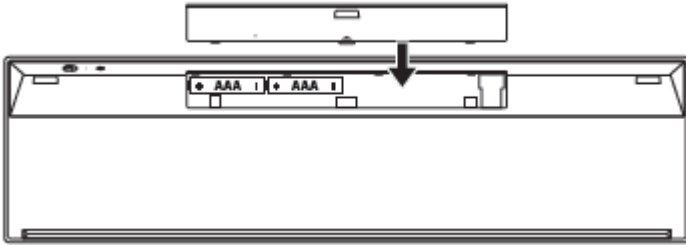

- 4 Slide the power switch to power on the keyboard.

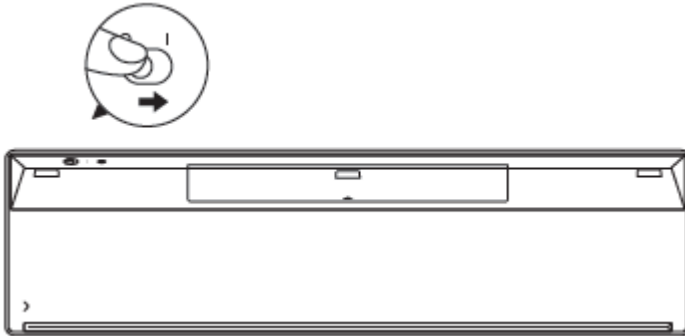

NOTE: Make sure the distance between your computer and keyboard is within 10 meters.

Pairing your wireless keyboard

Your Dell wireless keyboard can be paired with devices using USB and Bluetooth. You can pair and switch between a laptop, desktop, and a compatible mobile device.

Pairing with a USB device



You could connect a device to your wireless keyboard using the Dell Universal pairing.

- 1 Install the Dell Universal USB receiver to the USB port on your computer.

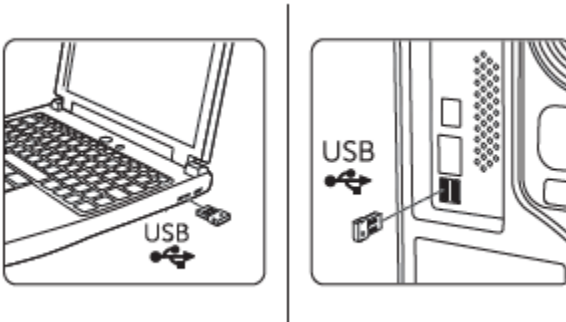

- 2 The connection-mode switch on the keyboard is set to Dell Universal Pairing by default.

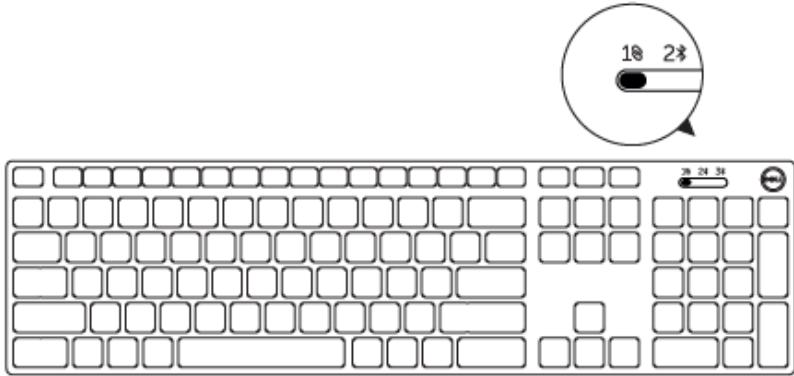

- 3 The keyboard is paired with your USB device.

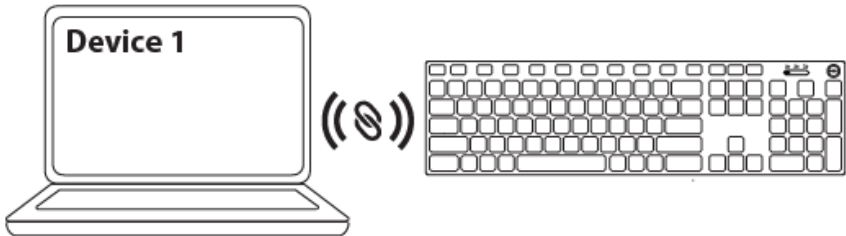

Pairing with a Bluetooth device

You could connect up to two devices to your wireless keyboard using Bluetooth.

Pairing device two using Bluetooth



You could connect a second device to your wireless keyboard using Bluetooth.

- 1 Slide the connection-mode switch on your keyboard to select the second-Bluetooth connection.

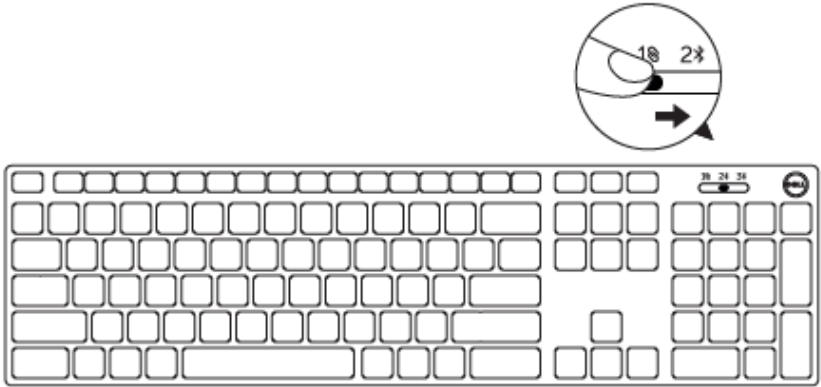

- 2 In Windows Search, type Bluetooth.
- 3 From the list that appears, click Bluetooth Settings.
- 4 Ensure that Bluetooth is enabled.
- 5 From the list of devices, click Dell WK717 → Pair.



NOTE: If Dell WK717 is not listed, press the Bluetooth-pairing button on the keyboard to ensure pairing mode is enabled.

- 6 Confirm the pairing process on both keyboard and device.
After the keyboard and a device are paired, they connect automatically when Bluetooth is enabled and they are within the Bluetooth range.

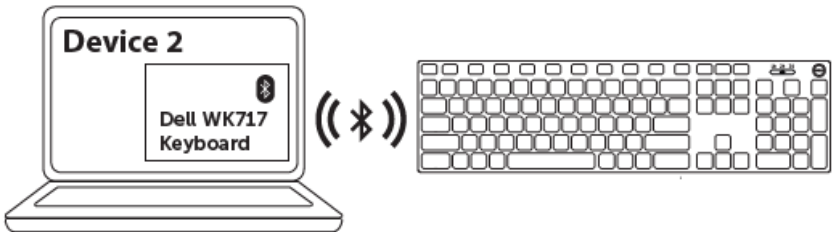



Pairing device three using Bluetooth

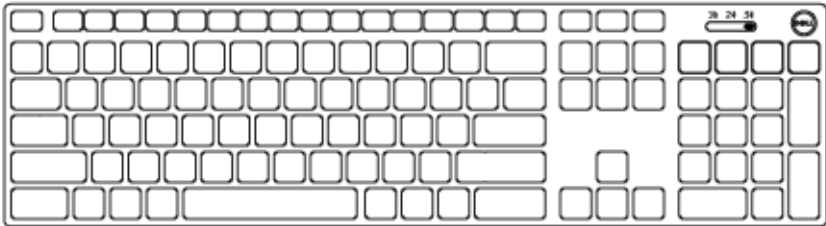

You could connect a third device to your wireless mouse using Bluetooth.

- 1 Slide the connection-mode switch on your keyboard to select the third-Bluetooth connection.



- 2 In Windows Search, type Bluetooth.
- 3 From the list that appears, click Bluetooth Settings.
- 4 Ensure that Bluetooth is enabled.
- 5 From the list of devices, click Dell WK717 → Pair.
 NOTE: If Dell WK717 is not listed, press the Bluetooth-pairing button on the keyboard to ensure pairing mode is enabled.
- 6 Confirm the pairing process on both keyboard and device.
After the keyboard and a device are paired, they connect automatically when Bluetooth is enabled and they are within the Bluetooth range.

Dell Universal Receiver feature for Windows

You can use the Dell Universal Receiver to manage the devices paired with your Dell wireless mouse and keyboard. The Dell Universal Receiver allows up to six Dell Universal compatible wireless devices to be added to the receiver.



Dell Universal Receiver Control Panel

You can add Dell Universal compatible wireless devices to the receiver using the Dell Universal Receiver Control Panel.

Installing Dell Universal Receiver Control Panel

- 1 Turn on the computer.
- 2 Go to www.dell.com/support.
- 3 In the Search bar, type **Dell Universal Receiver**.
- 4 Click **Search**.



- 5 Download the Dell Universal Receiver and save the file.
- 6 After the download is complete, open the file and follow the instructions on the screen to install the Dell Universal Receiver.

Using Dell Universal Receiver Control Panel

The receiver and mouse shipped with your system are paired at the factory. Use the Dell Universal Receiver Control Panel to view the connection status of your wireless keyboard or pair the mouse with another receiver.

Follow the instructions on the screen to add a device or to remove a pairing.

Troubleshooting

Problems	Possible causes	Possible solutions
Unable to use the mouse	The white LED indicator on top of the mouse does not light up when the mouse is powered on	<ol style="list-style-type: none">1 Check if the battery is inserted correctly.<ul style="list-style-type: none">• Battery “+” and “-” ends should follow those indicated on the battery compartment label.2 Check the battery level.<ul style="list-style-type: none">• If the mouse uses a rechargeable battery, make sure the battery is fully charged.• If the battery is exhausted, replace it with a new one.3 Turn the mouse off then on.<ul style="list-style-type: none">• Check if the battery status light is flashing amber 10 times, indicating the battery power is low. If the battery is fully depleted, the battery status light will not turn on.4 Make sure the USB dongle is directly connected to your computer.<ul style="list-style-type: none">• Avoid using the port replicators, USB hubs, etc.

Unable to pair the mouse to the computer using Bluetooth

The Bluetooth icon on the computer doesn't light up when connecting the mouse to the computer.

- 5 Change the USB port.
 - Insert the USB dongle into another USB port on your computer.
- 1 Check the battery level.
 - If the mouse uses a rechargeable battery, make sure the battery is fully charged.
 - If the battery is exhausted, replace it with a new one.
- 2 Turn the mouse off then on.
 - Check if the battery status light is flashing amber 10 times, indicating the battery power is low. If the battery is fully depleted, the battery status light will not turn on.
- 3 Restart your computer.
- 4 Check the operating system is Microsoft Windows 10/Microsoft Windows 8/Microsoft Windows 7/Chrome/Android.
- 5 Make sure the mouse is set to Bluetooth Low Energy (BLE) mode in your computer. For instructions, refer to the documentation that came with your computer.
- 6 Turn off then on the Bluetooth Low Energy (BLE) mode in your computer. For instructions, refer to the documentation that came with your computer.

Mouse pointer does not move	The mouse pointer freezes	<ol style="list-style-type: none"> 1 Check the battery level. <ul style="list-style-type: none"> • If the mouse uses a rechargeable battery, make sure the battery is fully charged. • If the battery is exhausted, replace it with a new one.
Left/right buttons doesn't work	No response when the left or right mouse button is pressed	
Wireless connection is lost	Previously paired mouse no longer works on the computer	<ol style="list-style-type: none"> 2 Turn the mouse off then on. <ul style="list-style-type: none"> • Check if the battery status light is flashing amber 10 times, indicating the battery power is low. If the battery is fully depleted, the battery status light will not turn on. 3 Restart your computer.
Unable to pair the mouse with the computer	Wireless pairing error message is received while pairing the mouse with the computer	<ol style="list-style-type: none"> 1 Check the battery level. <ul style="list-style-type: none"> • If the mouse uses a rechargeable battery, make sure the battery is fully charged. • If the battery is exhausted, replace it with a new one. 2 Turn the mouse off then on. <ul style="list-style-type: none"> • Check if the battery status light is flashing amber 10 times, indicating the battery power is low. If the battery is fully depleted, the battery status light will not turn on. 3 Restart your computer.

- 4 Make sure the USB dongle is connected directly to your computer.
 - Avoid using the port replicators, USB hubs, etc.
- 5 Change the USB port.
 - Insert the USB dongle into another USB port on your computer.

Specifications

General

Model number	KM717
Connection type	2.4 GH Wireless & Bluetooth dual mode technology
System requirement (2.4GH)	Microsoft Windows 10/ Microsoft Windows 8/ Microsoft Windows 7/ Microsoft Windows XP/ Microsoft Windows Vista/ Server 2003/ Server 2008/ Server 2012/ Linux 6.x/ Ubuntu, Neokylin, Free DOS, Chrome and Android
System requirement (Bluetooth)	Microsoft Windows 10/ Microsoft Windows 8/ Microsoft Windows 7/ Chrome and Android

Electrical

Operating voltage	1.0 V - 1.5 V
Battery required	Two AAA alkaline

Physical Characteristics

Weight (without battery)	62 g (0.1366 lb)
Dimensions:	
Length	113.3 mm (4.461 in)
Width	66.7 mm (2.626 in)
Height	36.05 mm (1.419 in)

Environmental

Temperature

Operating

-10°C to 50°C

Storage

-40°C to 65°C

Storage Humidity

95% maximum relative humidity;
non-condensing

2.4 GHz wireless

Radio transmission

Bi-directional communication
(Transceiver)

Range

Up to 10 m

Statutory information

Warranty

Limited warranty and return policies

Dell-branded products carry a 1-year limited hardware warranty. If purchased together with a Dell system, it will follow the system warranty.

For U.S. customers:

This purchase and your use of this product are subject to Dell's end user agreement, which you can find at [Dell.com/terms](https://www.dell.com/terms). This document contains a binding arbitration clause.

For European, Middle Eastern and African customers:

Dell-branded products that are sold and used are subject to applicable national consumer legal rights, the terms of any retailer sale agreement that you have entered into (which will apply between you and the retailer) and Dell's end user contract terms.

Dell may also provide an additional hardware warranty—full details of the Dell end user contract and warranty terms can be found by going to [Dell.com](https://www.dell.com), selecting your country from the list at the bottom of the “home” page and then clicking the “terms and conditions” link for the end user terms or the “support” link for the warranty terms.

For non-U.S. customers:

Dell-branded products that are sold and used are subject to applicable national consumer legal rights, the terms of any retailer sale agreement that you have entered into (which will apply between you and the retailer) and Dell's warranty terms. Dell may also provide an additional hardware warranty

—full details of Dell's warranty terms can be found by going to [Dell.com](https://www.dell.com), selecting your country from the list at the bottom of the “home” page and then clicking the “terms and conditions” link or the “support” link for the warranty terms.