

Dell™ 7609WU Projector

User's Guide

Notes, Notices, and Cautions



NOTE: A NOTE indicates important information that helps you make better use of your projector.



NOTICE: A NOTICE indicates either potential damage to hardware or loss of data and tells you how to avoid the problem.



CAUTION: A CAUTION indicates a potential for property damage, personal injury, or death.

Information in this document is subject to change without notice.

© 2008 Dell Inc. All rights reserved.

Reproduction of these materials in any manner whatsoever without the written permission of Dell Inc. is strictly forbidden.

Trademarks used in this text: *Dell* and the *DELL* logo are trademarks of Dell Inc.; *DLP*, *DLP*® logo and *DarkChip*™3 are either trademarks for Texas Instruments; Microsoft and Windows are registered trademarks or trademarks of Microsoft Corporation in the United States and/or other countries.

Other trademarks and trade names may be used in this document to refer to either the entities claiming the marks and names or their products. Dell Inc. disclaims any proprietary interest in trademarks and trade names other than its own.

Model 7609WU

April 2008 Rev. A00

Contents

1	Your Dell Projector	6
	About Your Projector	7
2	Connecting Your Projector	8
	Connecting a Computer	9
	Connecting a Computer Using a VGA Cable	9
	Connecting a Computer Using a RS232 Cable	10
	Connecting a Computer Using an Ethernet Cable	11
	Connecting a Computer Using a DisplayPort Cable	12
	Monitor Loop-Through Connection Using VGA Cables	13
	Connecting a DVD Player	14
	Connecting a DVD Player Using an S-video Cable	14
	Connecting a DVD Player Using a Composite Cable	15
	Connecting a DVD Player Using a Component (VGA to YPbPr) Cable	16
	Connecting a DVD Player Using a Component (YPbPr to YPbPr) Cable	17
	Connecting a DVD Player Using an HDMI Cable	18
	Professional Installation Options	19
	Installation for Driving Automatic Screen	19
	Connecting a Commercial RS232 Control Box	20

3	Using Your Projector	21
	Turning Your Projector On	21
	Turning Your Projector Off	21
	Adjusting the Projected Image	22
	Raising the Projector Height	22
	Lowering the Projector Height	22
	Adjusting the Projector Zoom and Focus	23
	Adjusting Projection Image Size	24
	Using the Control Panel	25
	Using the Remote Control	27
	Using the On-Screen Display	29
	Main Menu	29
	INPUT SELECT	29
	AUTO-ADJUST	30
	SET UP	31
	PICTURE (in PC Mode)	33
	PICTURE (in Video Mode)	34
	DISPLAY (in PC Mode)	35
	DISPLAY (in Video Mode)	36
	PIP SETTINGS	37
	LAMP	38
	LANGUAGE	39
	OTHERS	40
4	Troubleshooting Your Projector	44
	Changing the Lamp	48

5	Specifications	50
6	Contacting Dell™	56
7	Appendix: Glossary	57

Your Dell Projector

Before connecting your projector ensure that all the necessary components are available. Your projector ships with the components shown below. Contact Dell (See "Contacting Dell™" on page 56) if any of the components are missing.

Package Contents

Power cable

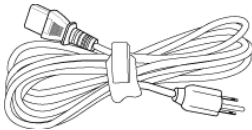

1.8m VGA cable (VGA to VGA)

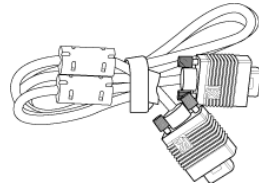

2.0m DisplayPort cable

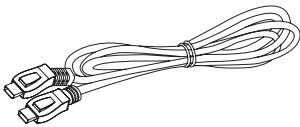

Remote control



AAA Batteries (2)

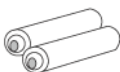

CD User's Guide & Documentation

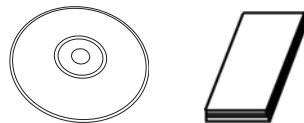

About Your Projector

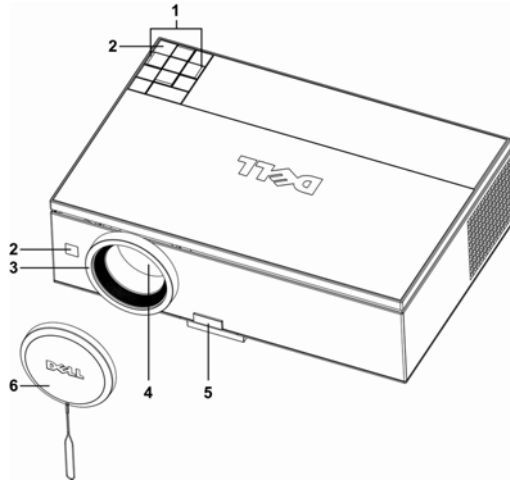

1	Control panel
2	IR receivers
3	Focus ring
4	Lens
5	Elevator button
6	Lens cap



CAUTION: Safety Instructions

- 1 Do not use the projector near appliances that generate a lot of heat.
- 2 Do not use the projector in areas where there is an excessive amount of dust. The dust may cause the system to fail and the projector will automatically shut down.
- 3 Ensure that the projector is mounted in a well-ventilated area.
- 4 Do not block the ventilation slots and openings on the projector.
- 5 Ensure that the projector operates between ambient temperatures (5°C to 35°C).



NOTE: For more information, see the safety information that shipped with your projector.

2

Connecting Your Projector

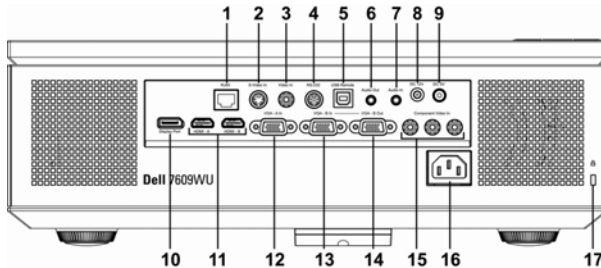

1	RJ45 network connector
2	S-video input connector
3	Composite video input connector
4	RS232 connector
5	USB remote connector
6	Audio output connector
7	Audio input connector
8	12 Volt DC relay output
9	5 Volt DC relay output
10	DisplayPort connector
11	HDMI input connectors
12	VGA-A input (D-sub) connector
13	VGA-B input (D-sub) connector
14	VGA-B output (monitor loop-through) connector
15	Component video input connectors
16	Power cable connector
17	Security cable slot



CAUTION: Before you begin any of the procedures in this section, follow the "Safety Instructions" on page 7.

Connecting a Computer

Connecting a Computer Using a VGA Cable

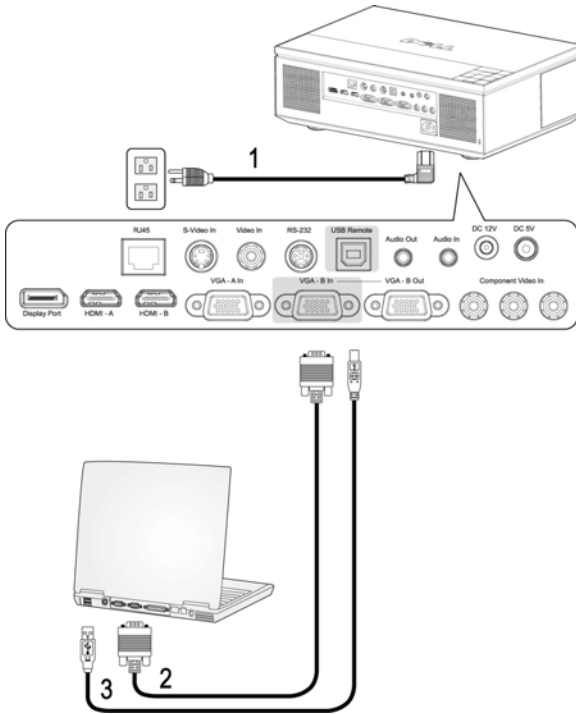

1	Power cable
2	VGA to VGA cable
3	USB to USB cable



NOTE: The USB cable is not provided by Dell. You can buy the USB cable from the Dell website



NOTE: The USB cable must be connected if you want to use the Next Page and Previous Page features on the remote control.

Connecting a Computer Using an RS232 Cable

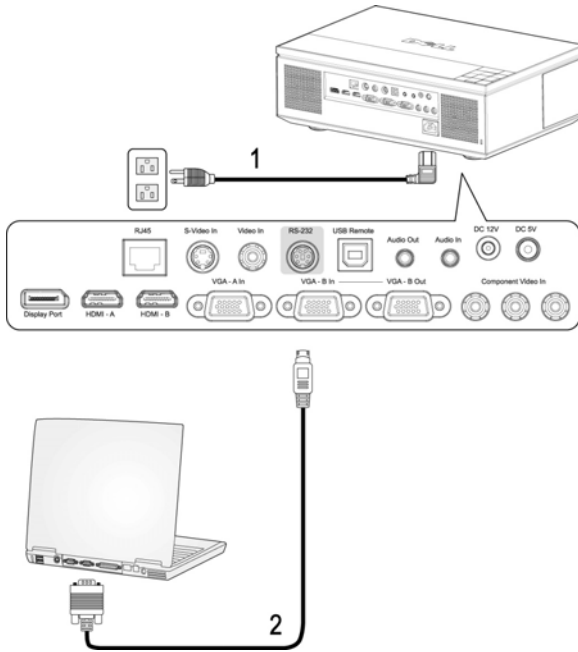

1	Power cable
2	RS232 cable

NOTE: The RS232 cable is not provided by Dell. Consult a professional installer for the cable and RS232 remote control software.

Connecting a Computer Using an Ethernet Cable

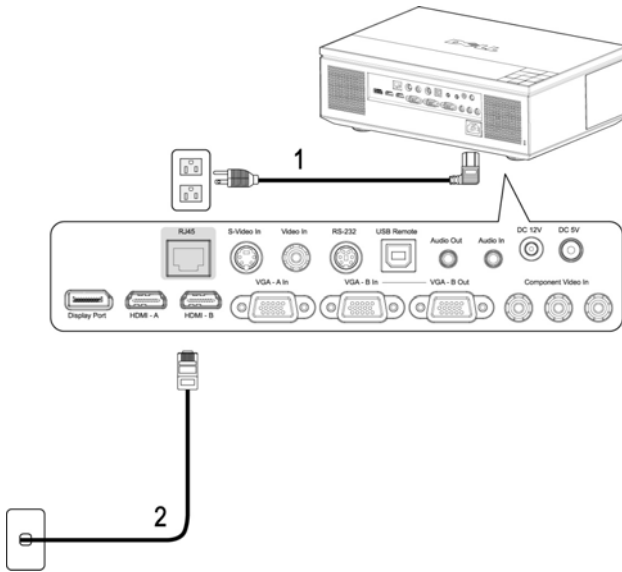

1	Power cable
2	Ethernet (RJ45) cable



NOTE: The Ethernet (RJ45) cable is not provided by Dell.

Connecting a Computer Using a DisplayPort Cable

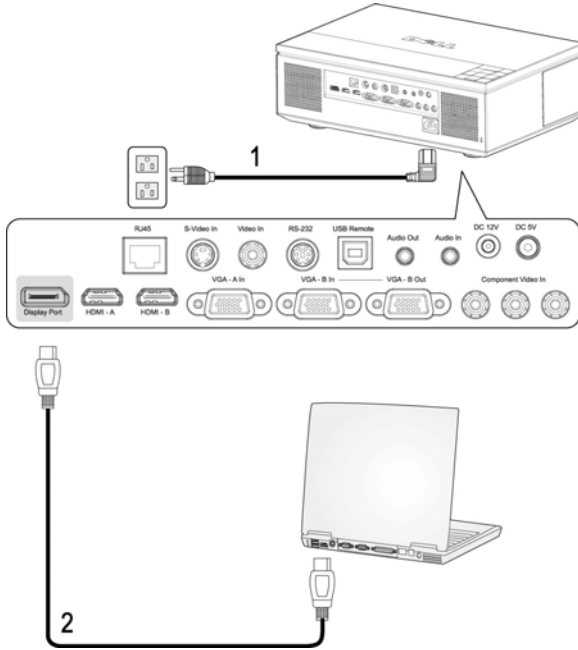

1	Power cable
2	DisplayPort cable

Monitor Loop-Through Connection Using VGA Cables

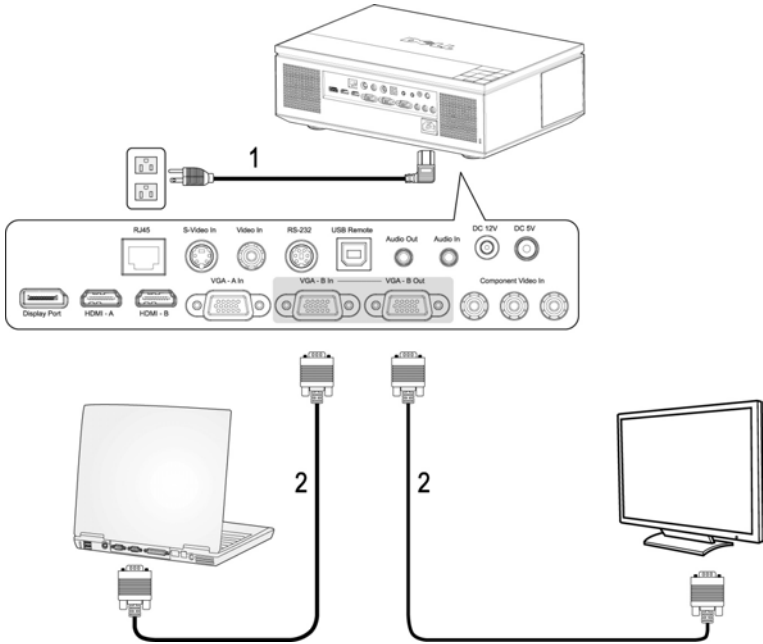

1	Power cable
2	VGA to VGA cable

Connecting a DVD Player

Connecting a DVD Player Using an S-video Cable

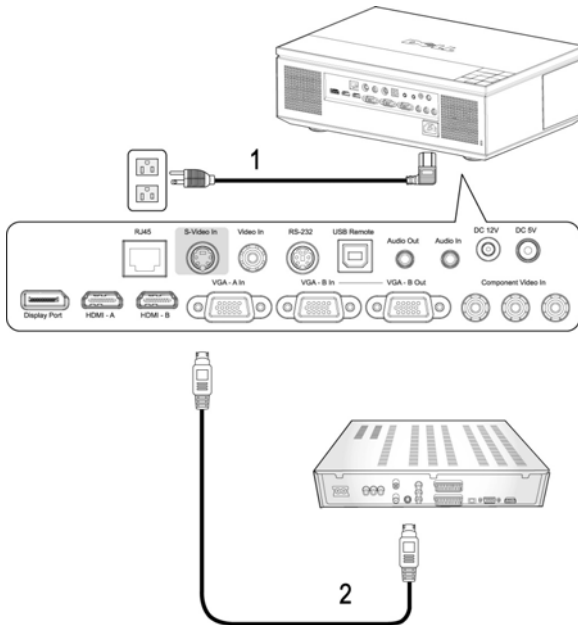

1	Power cable
2	S-video cable



NOTE: The S-video cable is not provided by Dell. You can buy the S-Video Extension (50ft/100ft) cable from the Dell website.

Connecting a DVD Player Using a Composite Cable

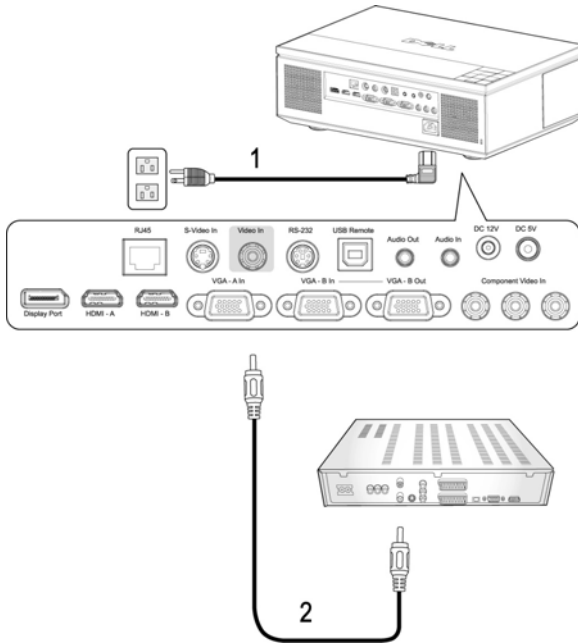

1	Power cable
2	Composite video cable



NOTE: The Composite cable is not provided by Dell. You can buy the Composite Video Extension (50ft/100ft) cable from the Dell website.

Connecting a DVD Player Using a Component (VGA to YPbPr) Cable

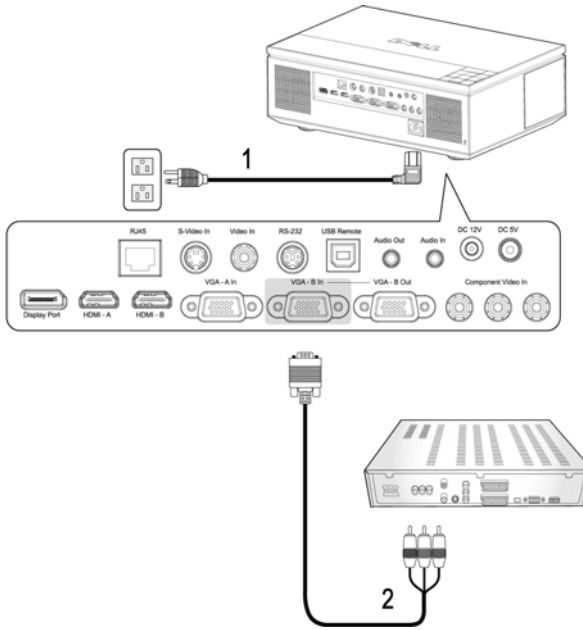

1	Power cable
2	VGA to YPbPr cable

 **NOTE:** The VGA to YPbPr cable is not provided by Dell. You can buy the VGA to YPbPr Extension (50ft/100ft) cable from the Dell website.

 **NOTE:** You can connect the component cable to either VGA-A Input or VGA-B Input.

Connecting a DVD Player Using a Component (YPbPr to YPbPr) Cable

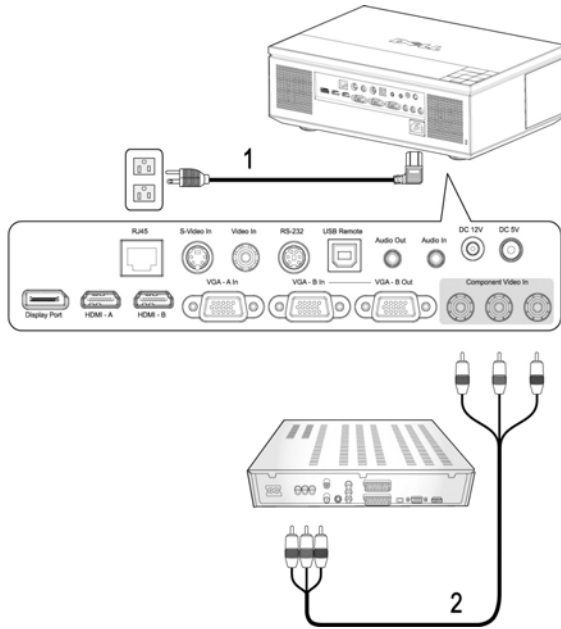

1	Power cable
2	YPbPr to YPbPr cable



NOTE: The YPbPr to YPbPr cable is not provided by Dell.

Connecting a DVD Player Using an HDMI Cable

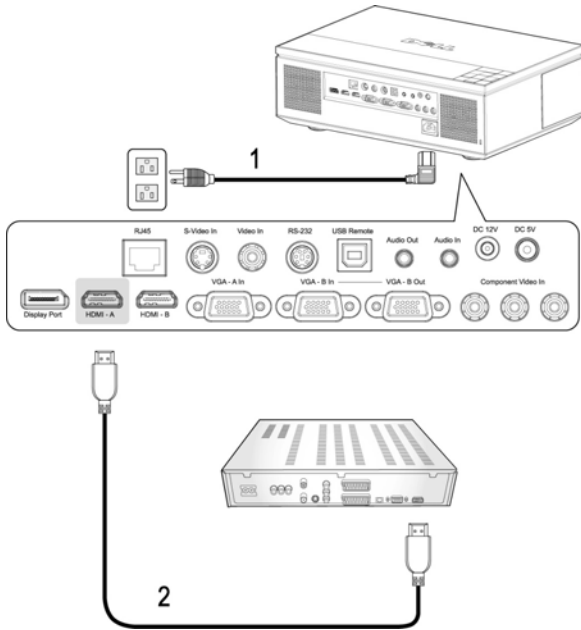

1	Power cable
2	HDMI cable



NOTE: The HDMI cable is not provided by Dell.

Professional Installation Options

Installation for Driving Automatic Screen

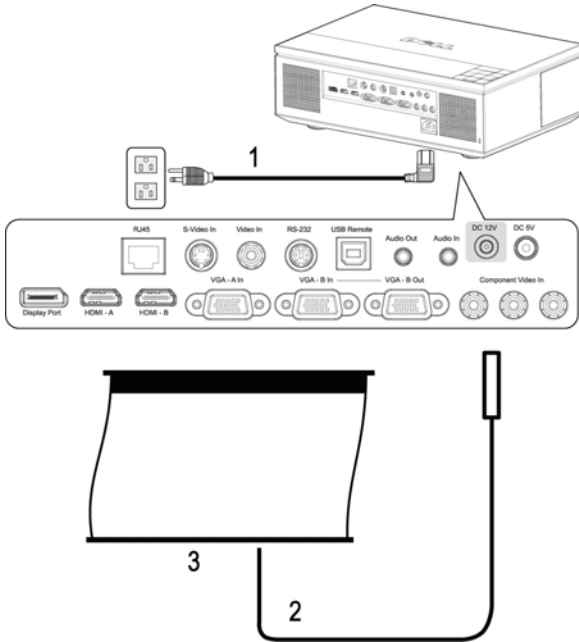

1	Power cable
2	12V DC power cable
3	Automatic screen



NOTE: The 12V DC power cable is not provided by Dell.

The 12V DC power cable has to be connected to the DC 12V jack.



NOTE: Use a 12V DC plug  with a dimension 1.7mm (ID) x 4.00mm (DD) x 9.5 mm (shaft) to connect the automatic screen with the projector.

Connecting a Commercial RS232 Control Box

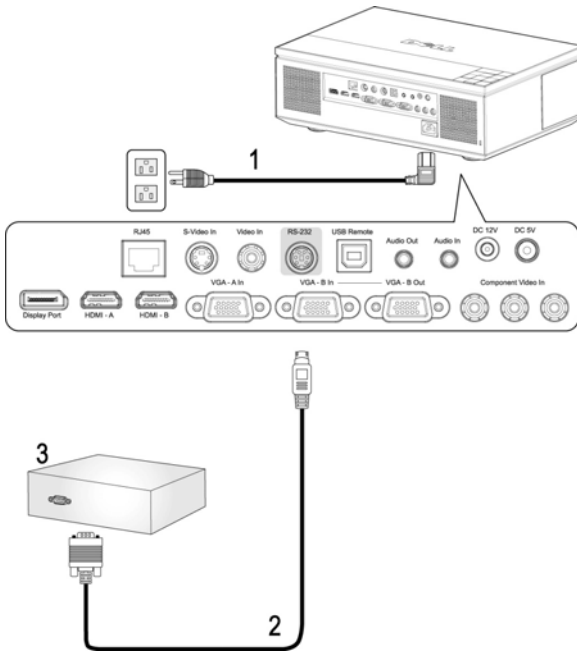

1	Power cable
2	RS232 cable
3	Commercial RS232 control box

NOTE: The RS232 cable is not provided by Dell. Consult a professional installer for the cable and RS232 remote control software.

Using Your Projector

Turning Your Projector On

 **NOTE:** Turn on the projector before you turn on the source. The **Power** button light blinks blue until it is pressed.

1 Remove the lens cap.



CAUTION: The lens cap must be removed before turning on the projector. Otherwise, the metal plate inside the lens cap will become very hot and may cause injury if touched.

2 Connect the power cable and the appropriate signal cables. For information about connecting the projector, see "Connecting Your Projector" on page 8.

3 Press the **Power** button (see "Using the Control Panel" on page 25 to locate the **Power** button).

4 Turn on your source (computer, DVD player, etc.). The projector automatically detects your source.

 **NOTE:** If you have multiple sources connected to the projector, press the **Source** button on the remote control or control panel to select the desired source.

5 The Dell Logo will continue for 30 seconds while powered on.

If the "**Searching for signal...**" message appears on the screen, ensure that the appropriate cables are securely connected.

Turning Your Projector Off



NOTICE: Unplug the cables from the projector after properly shutting down as explained in the following procedure.

1 Press the **Power** button.

2 Press the **Power** button again. The cooling fans will continue to operate for 120 seconds.

3 To quickly turn off the projector, press the **Power** button while the projector's cooling fans are still running.

 **NOTE:** Before you turn on the projector again, wait for 60 seconds to allow the internal temperature to stabilize.

4 Disconnect the power cable from the electrical outlet and the projector.

 **NOTE:** If you press the **Power** button while the projector is running, the "**Press Power Button to Turn off Projector**" message appears on the screen. To clear the message, press the **Menu** button on the control panel or ignore the message; the message disappears after 10 seconds.

Adjusting the Projected Image

Raising the Projector Height

- 1 Press the **Elevator** button.
- 2 Raise the projector to the desired display angle, and then release the button to lock the elevator foot into position.
- 3 Use the tilt adjustment wheel to fine-tune the display angle.

Lowering the Projector Height

 **CAUTION:** Support the projector properly and do not place you hand near the elevator foot when pressing the elevator button.

- 1 Press the **Elevator** button.
- 2 Lower the projector, and then release the button to lock the elevator foot into position.

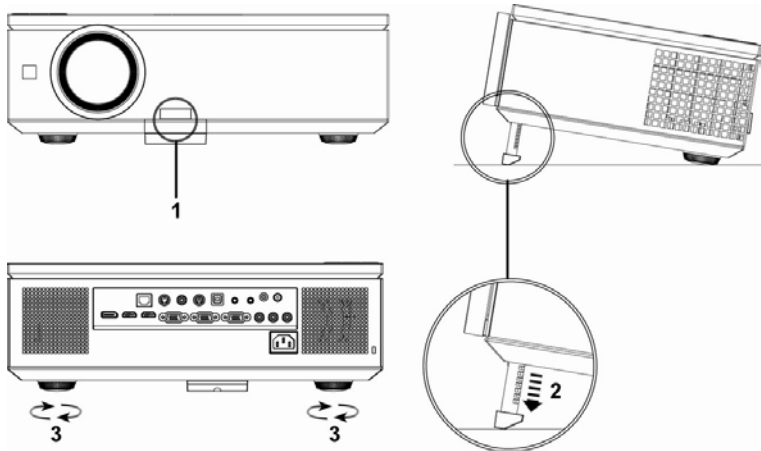

1	Elevator button
2	Elevator foot
3	Tilt adjustment wheel

Adjusting the Projector Zoom and Focus

1 Open the side door of the projector.



CAUTION: To avoid damaging the projector, ensure that the side door is fully closed and the elevator foot is fully retracted before moving the projector.

2 Unlock the lens shift lock, before you adjust the lens shift.

3 Turn the vertical/horizontal lens shift knob to shift the lens.

4 After adjusting the lens shift, lock the lens shift lock.

5 Pull the zoom ring adjustment up and down to zoom in and out.

6 Rotate the focus ring adjustment until the image is clear. The projector focuses at distances ranging between 3.28 ft to 39.37 ft (1.0m to 12.0m).

7 Close the side door of the projector.

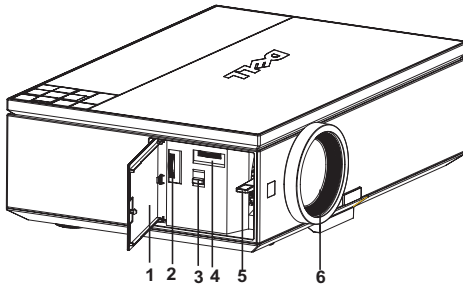

1	Side door
2	Vertical lens shift knob
3	Lens shift lock
4	Horizontal lens shift knob
5	Zoom ring
6	Focus ring

Adjusting Projection Image Size

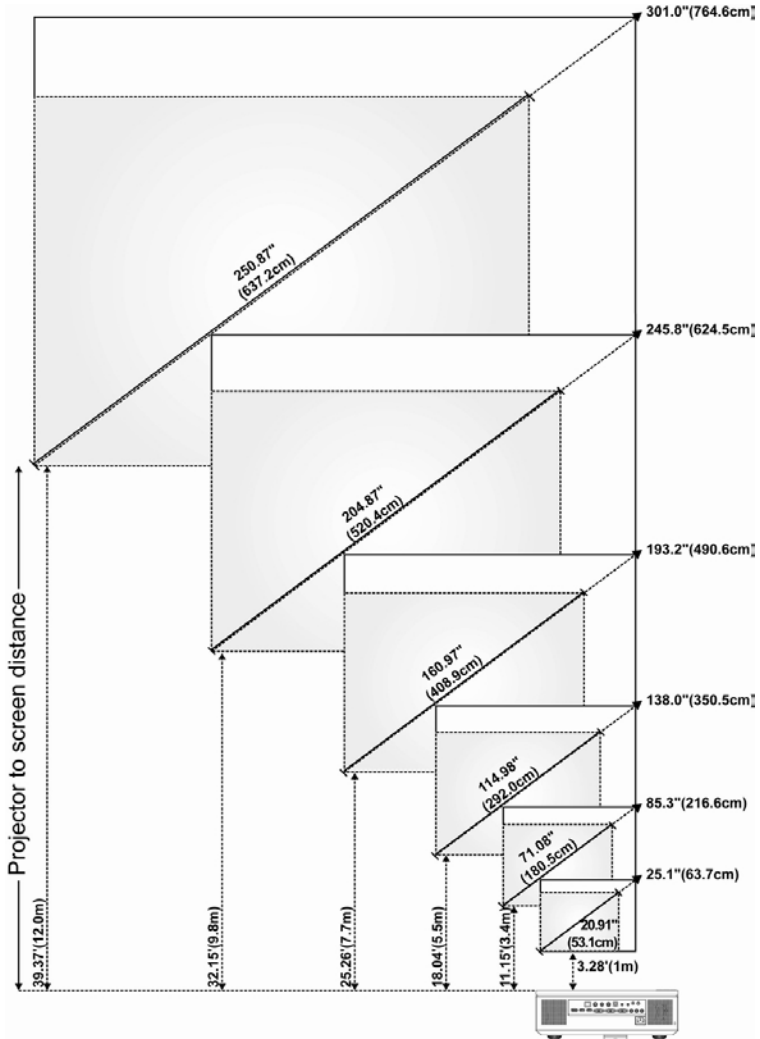





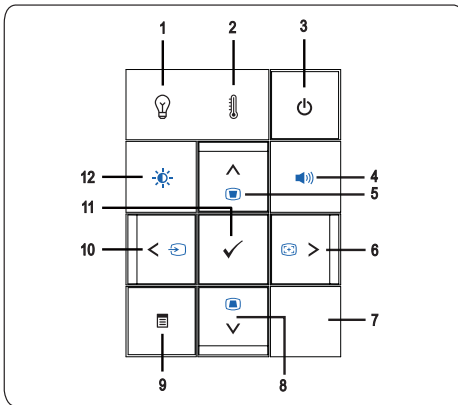













Screen (Diagonal)	Max.	25.1" (63.7cm)	85.3" (216.6cm)	138.0" (350.5cm)	193.2" (490.6cm)	245.8" (624.5cm)	301.0" (764.6cm)
	Min.	20.91" (53.1cm)	71.08" (180.5cm)	114.98" (292.0cm)	160.97" (408.9cm)	204.87" (520.4cm)	250.87" (637.2cm)
Screen Size	Max. (WxH)	21.3" X 13.3" (54.1cm X 33.7cm)	72.4" X 45.2" (183.8cm X 114.7cm)	117.0" X 73.1" (297.3cm X 185.6cm)	163.9" X 102.3" (416.2cm X 259.8cm)	208.6" X 130.2" (529.7cm X 330.7cm)	255.4" X 159.4" (648.6cm X 404.9cm)
	Min. (WxH)	17.7" X 11.1" (45.0cm X 28.12cm)	60.3" X 37.7" (153.1cm X 95.7cm)	97.5" X 60.9" (247.7cm X 154.8cm)	136.5" X 85.3" (346.7cm X 216.7cm)	173.7" X 108.6" (441.3cm X 275.8cm)	212.7" X 133.0" (540.3cm X 337.7cm)
Distance		3.28' (1.0m)	11.15' (3.4m)	18.04' (5.5m)	25.26' (7.7m)	32.15' (9.8m)	39.37' (12.0m)
* This graph is for user reference only.							

Using the Control Panel











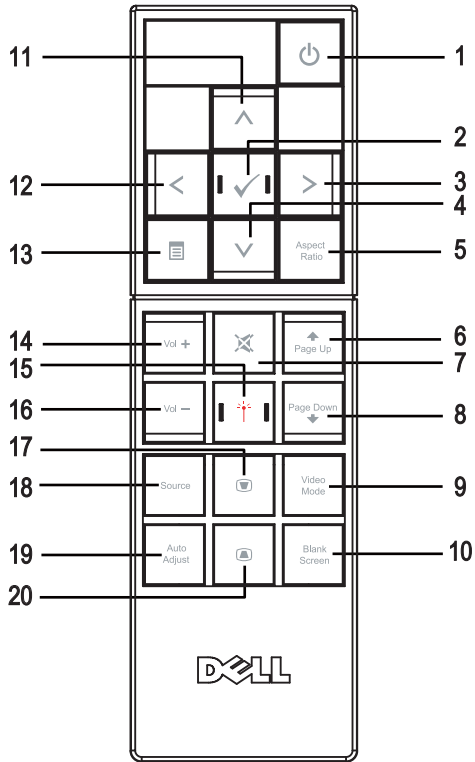



- 1 LAMP warning light  • If the LAMP light is solid amber, replace the lamp (See "LAMP" on page 38).
- If the LAMP light is blinking amber, the projector automatically shuts down indicating a system failure. If this problem persists, **contact Dell™** (See "Contacting Dell™" on page 56).



2	TEMP warning light 	<ul style="list-style-type: none"> • A solid amber TEMP light indicates that the projector, lamp, or lamp driver are overheated. The display automatically shuts down. Turn the display on again after the projector cools down. If the problem persists, contact Dell™ (See "Contacting Dell™" on page 56). • A blinking amber TEMP light indicates that a projector fan or color wheel have failed and the projector automatically shuts down. If the problem persists, contact Dell™ (See "Contacting Dell™" on page 56).
3	Power 	Allows you to turn the projector on and off. For more information, see "Turning Your Projector On" on page 21 and "Turning Your Projector Off" on page 21.
4	Volume Control 	Allows you to increase or decrease the volume.
5	Up  / Keystone adjustment 	Allows you to select options from the On Screen Display (OSD) menu. You can also use this button to adjust the image distortion caused by tilting the projector.
6	Right  / Auto Adjust 	Allows you to adjust the OSD setting. You can also synchronize the projector to the input source. Auto Adjust does not operate if the on-screen display (OSD) is displayed.
7	IR Receiver	Point the remote control towards the IR receiver and press a button.
8	Down  / Keystone adjustment 	Allows you to select options from the On Screen Display (OSD) menu. You can also use this button to adjust the image distortion caused by tilting the projector.
9	Menu 	Allows you to activate the OSD. Use     and the Menu button to navigate through the OSD.
10	Left  / Source 	Allows you to adjust the OSD setting. You can also use the  button to toggle through Digital RGB, Analog RGB, Composite, Component, and S-video sources when multiple sources are connected to the projector.

11	Enter ✓	Allows you to confirm a selected OSD option.
12	Brightness and Contrast Control 	Allows you to adjust the brightness and contrast values.

Using the Remote Control









1	Power 	Turns the projector on and off. For more information, see "Turning Your Projector On" on page 21 and "Turning Your Projector Off" on page 21. Press and hold for 10 seconds to exit the lockup state and go back to standby mode when projector is in lockup state. (eg. Lamp error, over heat etc.)
2	Enter 	Press to confirm the selection.
3	Right 	Press to adjust the OSD setting.
4	Down 	Press to select OSD items.
5	Aspect Ratio	Press to change the aspect ratio of a displayed image.
6	Page up 	Press to move to the previous page.
7	Mute 	Press to mute or un-mute the projector speaker.
8	Page down 	Press to move to the next page.
9	Video mode	The Dell 7609WU projector has preset configurations that are optimized for displaying data (PC Graphics) or videos (movies, games, etc.). Press the Video Mode button to toggle between Presentation mode , Bright mode , Movie mode , sRGB , or CUSTOM mode (for the user to set up and save preferred settings). Pressing the Video Mode button once will show the current display mode. Pressing the Video Mode button again will allow the projector to switch between display modes.
10	Blank screen	Press to hide / un-hide the image.
11	Up 	Press to select OSD items.
12	Left 	Press to adjust the OSD setting.
13	Menu 	Press to activate the OSD.
14	Volume up 	Press to increase the volume.
15	Laser	Aim the remote control at the screen, press and hold the laser button to activate the laser light.
16	Volume down 	Press to decrease the volume.

17	Keystone adjustment 	Press to adjust image distortion caused by tilting the projector. (± 30 degrees)
18	Source	Press to switch between Digital RGB, Analog RGB, Composite, S-video and Component sources.
19	Auto adjust	Press to synchronize the projector to the input source. Auto adjust does not operate if the OSD (On-Screen Display) is displayed.
20	Keystone adjustment 	Press to adjust image distortion caused by tilting the projector. (± 30 degrees)

Using the On-Screen Display

The projector has a multi-language On-Screen Display (OSD) that can be displayed with or without an input source present.

To navigate through the tabs in the **Main** menu, press the  or  buttons on your projector's control panel or remote control. To select a submenu, press the **Enter** button on your projector's control panel or remote control.

To select an option, press the  or  on your projector's control panel or remote control. When an item is selected, the color changes to dark blue. Use  or  on the control panel or remote control to adjust the settings.

To go back to the **Main** menu, go to the Back tab and press the **Enter** button on the control panel or the remote control.

To exit the OSD, go to the EXIT tab and press the **Enter** button or press the **Menu** button directly on the control panel or the remote control.

Main Menu



INPUT SELECT

The Input Select menu allows you to select your projector's input source.

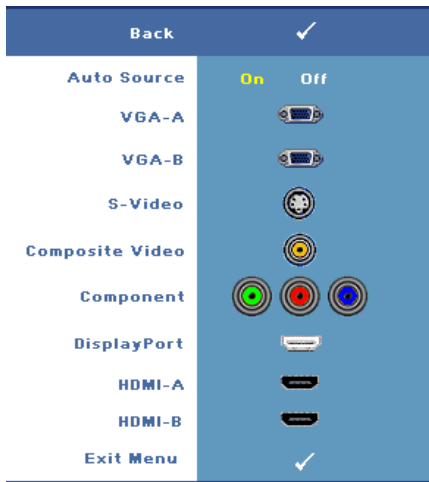

AUTO SOURCE—Select **On** (the default option) to autodetect the available input signals. If you press the **Source** button when the projector is on, it automatically finds the next available input signal. Select **Off** to lock the current input signal. If you press the **Source** button when the **Auto Source** mode is set to **Off**, you can manually select the input signal.

VGA-A—Press **Enter** to detect the VGA-A signal.

VGA-B—Press **Enter** to detect the VGA-B signal.

S-VIDEO—Press **Enter** to detect the S-Video signal.

COMPOSITE VIDEO—Press **Enter** to detect the Composite Video signal.

COMPONENT—Press **Enter** to detect the Component Video signal.

DISPLAYPORT—Press **Enter** to detect the DisplayPort signal.

HDMI-A—Press **Enter** to detect the HDMI-A signal.

HDMI-B—Press **Enter** to detect the HDMI-B signal.

AUTO-ADJUST



Auto Adjust automatically adjusts the projector's **FREQUENCY** and **TRACKING** in PC mode. While

Auto Adjustment is in progress, the following message appears on the screen, "Auto Adjustment in Progress..."

SET UP

It includes H. Keystone, V. Keystone, Auto Keystone, Projector Mode, Aspect Ratio, Network Settings, and Projector Info.

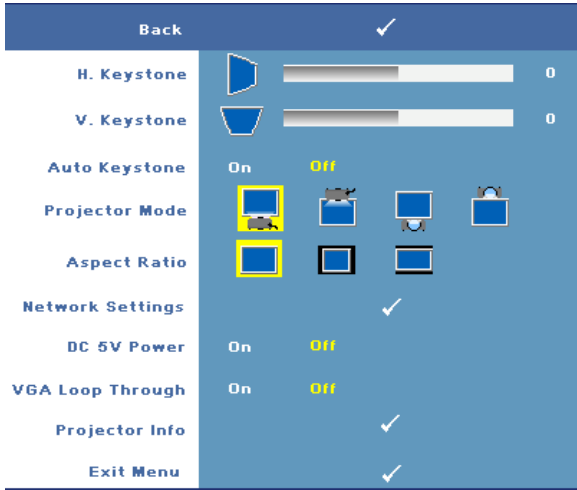





H. KEYSTONE—Adjusts the image distortion caused by horizontal shifting of the projector orientation.

V. KEYSTONE—Adjusts the image distortion caused by tilting the projector.



AUTO KEYSTONE—Select **On** to enable the auto correction for vertical image distortion caused by tilting the projector. Select **Off** to disable the auto correction.

PROJECTOR MODE—Allows you to select the projector mode, depending upon how the projector is mounted.

-  Front Projection-Desktop — This is the default option.
-  Front Projection-Ceiling Mount — The projector turns the image upside down for ceiling-mounted projection.
-  Rear Projection-Desktop — The projector reverses the image so that you can project the image from behind a translucent screen.
-  Rear Projection-Ceiling Mount — The projector reverses and turns the image upside down. You can project the image from behind a translucent screen with a ceiling-mounted projection.









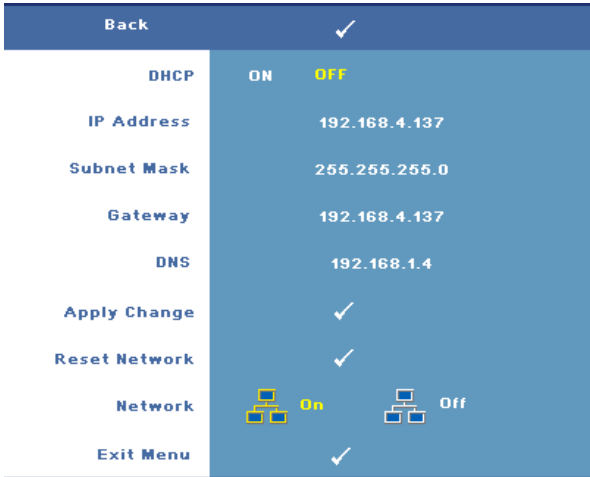



ASPECT RATIO—Allows you to set the aspect ratio.

-  Original — The input source scales to fit the screen while keeping the aspect ratio of the input source.

-  4:3 — The input source scales to fit the height of the screen and projects a 4:3 image.
-  Wide — The input source scales to fit the width of the screen to project a wide screen image.

NETWORK SETTINGS—Allows you to manage the network configuration. Press **Enter** to open the Network Settings menu.



- DHCP—Select **On** to assign an IP address to the projector from a **DHCP** server automatically. Select **Off** to assign an IP address manually.
- IP Address—Press **Enter** to set up an IP address. Press  or  to select the number position,  or  to change the number.
- Subnet Mask—Press **Enter** to set up a subnet mask number. Press  or  to select the number position,  or  to change the number.
- Gateway—Press **Enter** to set the default gateway of the network connected to the projector. Press  or  to select the number position,  or  to change the number.
- DNS—Type in the IP address of the DNS server on the network connected to the projector. 12 numeric characters are used.
- Apply Change—Press **Enter** to confirm the settings.
- Reset Network—Press **Enter** to reset to the default settings.
- Network—Select **On** to activate and **Off** to deactivate network connections.

DC 5V POWER—Select this option to turn the DC 5V power **On** or **Off**.

VGA LOOP THROUGH—Select this option to turn the VGA Loop through **On** or **Off**.

PROJECTOR INFO—Displays the projector model name, the present input source and the projector serial number (PPID#).

PICTURE (in PC Mode)

Using the **Picture** menu, you can adjust the display settings of your projector. The Picture menu provides the following options:

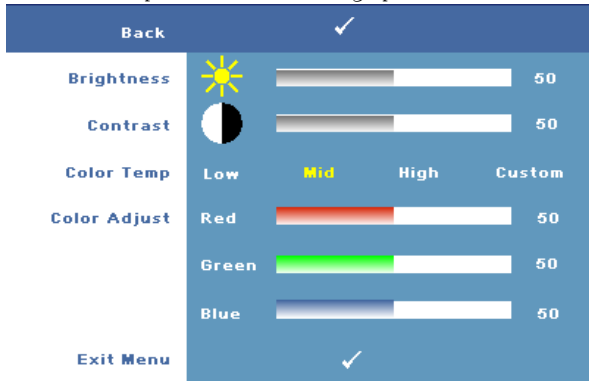

BRIGHTNESS—Use or to adjust the brightness of the image.

CONTRAST—Use or to adjust the display contrast.

COLOR TEMP—Allows you to adjust the color temperature. The screen appears cooler at higher color temperatures and warmer at lower color temperatures.

COLOR ADJUST—Allows you to manually adjust the colours red, green, and blue.

When you adjust the values in the **Color Adjust** menu, the Custom mode is activated. The values are saved in the Custom mode.

PICTURE (in Video Mode)

Using the **Picture** menu, you can adjust the display settings of your projector. The Picture menu provides the following options:



BRIGHTNESS—Use or to adjust the brightness of the image.

CONTRAST—Use or to adjust the display contrast.

COLOR TEMP—Allows you to adjust the color temperature. The screen appears cooler at higher color temperatures and warmer at lower color temperatures.

COLOR ADJUST—Allows you to manually adjust the colours red, green, and blue. When you adjust the values in the **Color Adjust** menu, the Custom mode is activated. The values are saved in the Custom mode.

SATURATION—Allows you to adjust the video source from black and white to fully saturated color. Press to decrease the amount of color in the image and to increase the amount of color in the image (Selectable for S-Video and Composite video signals only).

SHARPNESS—Allows you to adjust the image sharpness. Press to decrease the sharpness and to increase the sharpness.

TINT—Press to increase the amount of green in the image and to increase the amount of red in the image (Selectable for S-Video and Composite video signals only).

DISPLAY (in PC Mode)

Using the Display menu, you can adjust the display settings of your projector. The Display menu provides the following options:

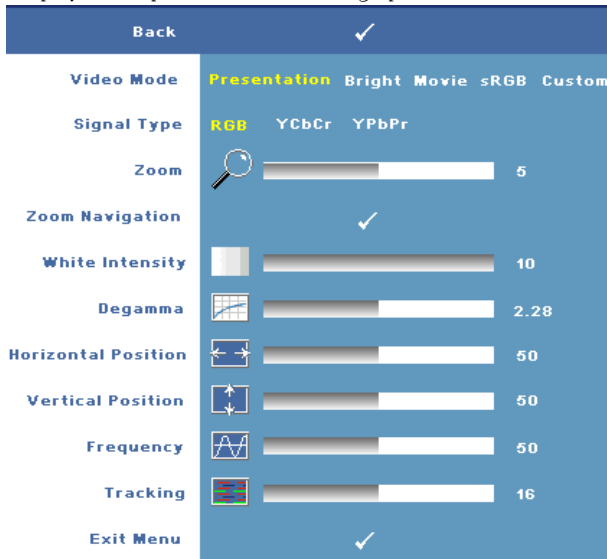

VIDEO MODE—Allows you to optimize the projector’s display mode:

Presentation, **Bright**, **Movie**, **sRGB** (provides a more accurate color representation), and **Custom** (set your preferred settings for these two options). If you adjust the settings for **White Intensity** or **Degamma**, the projector automatically switches to **Custom**.

SIGNAL TYPE—Allows you to manually select the signal type: RGB, YCbCr, or YPbPr.



ZOOM—Press $\boxed{\rightarrow}$ to digitally magnify an image up to 8 times on the projection screen and press $\boxed{\leftarrow}$ to reduce the zoomed image (for single display).

ZOOM NAVIGATION—Press $\boxed{\uparrow}$ $\boxed{\downarrow}$ $\boxed{\leftarrow}$ $\boxed{\rightarrow}$ to navigate the projection screen.

WHITE INTENSITY—Set 0 to maximize the color reproduction and 10 to maximize the brightness.

DEGAMMA—Allows you to adjust among the 4 preset values (1, 2, 3, 4) to change the color performance of the display.

HORIZONTAL POSITION—Press $\boxed{\leftarrow}$ to move the image to the left and $\boxed{\rightarrow}$ to move the image to the right.

VERTICAL POSITION—Press  to move the image down and  to move the image up.

FREQUENCY—Allows you to change the display data clock frequency to match the frequency of your computer graphics card. If you see a vertical flickering wave, use **Frequency** control to minimize the bars. This is a coarse adjustment.

TRACKING—Allows you to synchronize the phase of the display signal with the graphic card. If you experience an unstable or flickering image, use **Tracking** to correct it. This is a fine adjustment.

DISPLAY (in Video Mode)

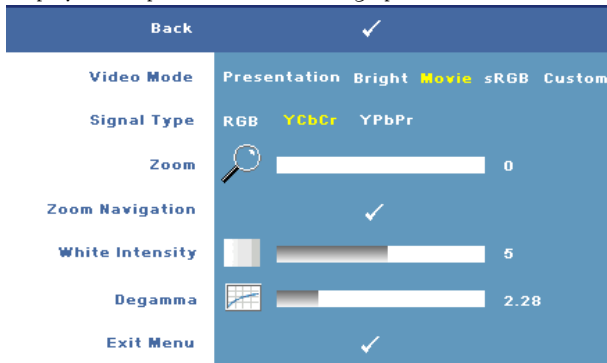

Using the **Display** menu, you can adjust the display settings of your projector. The **Display** menu provides the following options:



VIDEO MODE—Allows you to optimize the projector's display mode:

Presentation, **Bright**, **Movie**, **sRGB** (provides a more accurate color representation), and **Custom** (set your preferred settings for these two options). If you adjust the settings for **White Intensity** or **Degamma**, the projector automatically switches to **Custom**.

SIGNAL TYPE—Manually select the signal type: RGB, YCbCr, or YPbPr.

ZOOM—Press  to digitally magnify an image up to 8 times on the projection screen and press  to reduce the zoomed image (for single display).

ZOOM NAVIGATION—Press , , ,  to navigate the projection screen.



WHITE INTENSITY—Set 0 to maximize the color reproduction and 10 to maximize the brightness.

DEGAMMA—Adjust among the 4 preset values (1, 2, 3, 4) to change the color performance of the display.

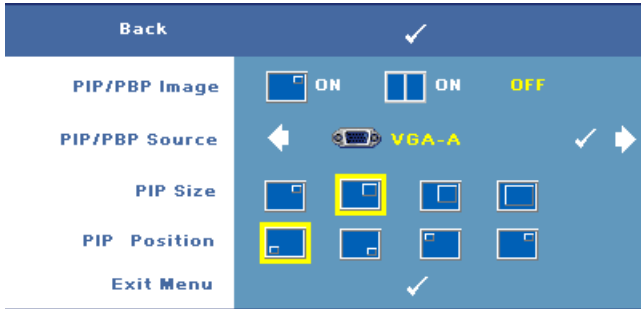
PIP SETTINGS



 **NOTE:** When swapping the foreground and background displays, the smallest screen size of foreground display will vary depending on the different combinations of signal sources for PIP.

PIP/PBP IMAGE—Select  On to enable the picture-in-picture display; select  On to enable the picture-by-picture display. Select Off to disable the function.

PIP/PBP SOURCE—The possible PIP/PBP source is available in the OSD selection depending on the current primary input source. To see the possible combination of the sources, refer to page 54.

PIP SIZE—Adjusts the image size of the PIP display.

PIP POSITION—Changes the PIP position to the four different corners of the display.

LAMP

Using the **Lamp** menu, you can adjust the display settings of your projector. The Lamp menu provides the following options:

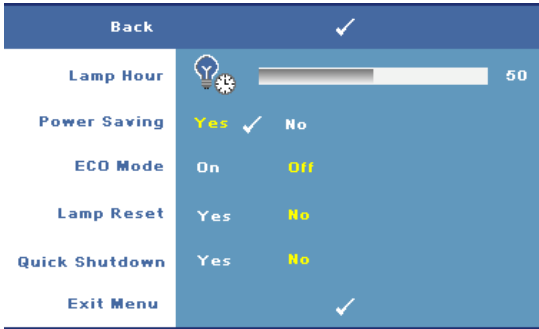

LAMP HOUR—Displays the operating hours since the last lamp timer reset.

POWER SAVING—Select **Yes** to set the Power Saving delay period. The delay period is the time that you want the projector to wait without an input signal. By default, the delay period is set to 120 minutes. However, you can set this to 5, 15, 30, 45, 60, or 120 minutes.

If an input signal is not detected during the delay period, the projector turns off the lamp and goes into power saving mode. If an input signal is detected when the projector is in power saving mode, the projector automatically turns on. If an input signal is not detected within two hours, the projector switches from Power Saving mode to Power Off mode. To turn on the projector press the Power button.

ECO MODE—Select **On** to use the lamp at a lower power level (264 Watts), which may provide longer lamp life, quieter operation, and dimmer luminance output on the screen. Select **Off** to operate at normal power level (300 Watts).

LAMP RESET—After you install a new lamp, select **Yes** to reset the lamp timer.

QUICK SHUTDOWN—Select **Yes** to turn off the projector with a single press of the Power button. This function allows the projector to quick power off with an accelerated fan speed.



NOTE: Slightly higher acoustic noise is expected during quick power off.

LANGUAGE

The Language menu allows you to set the language for the OSD.

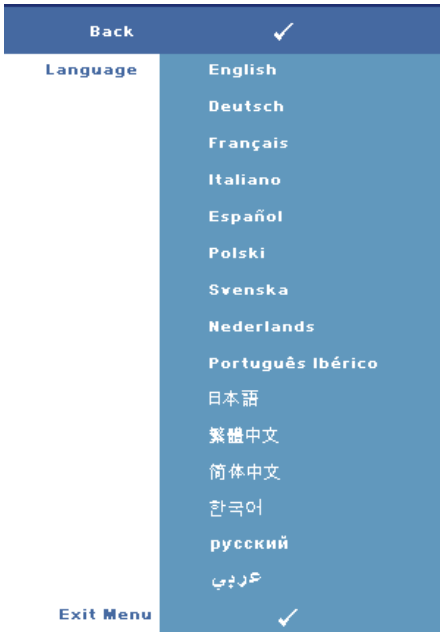



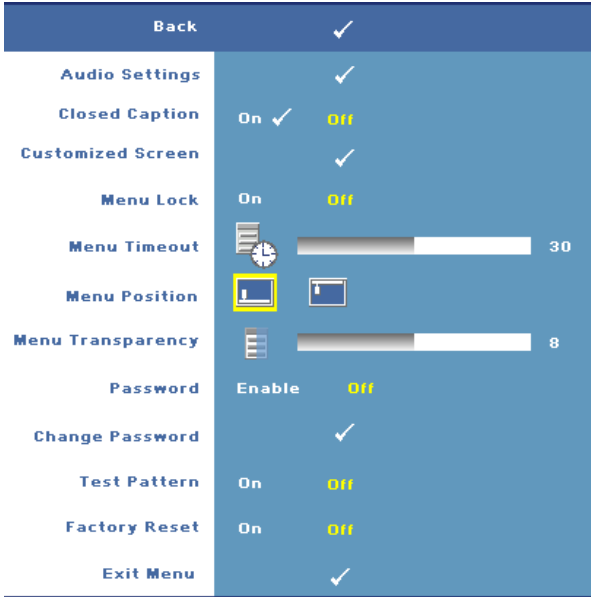



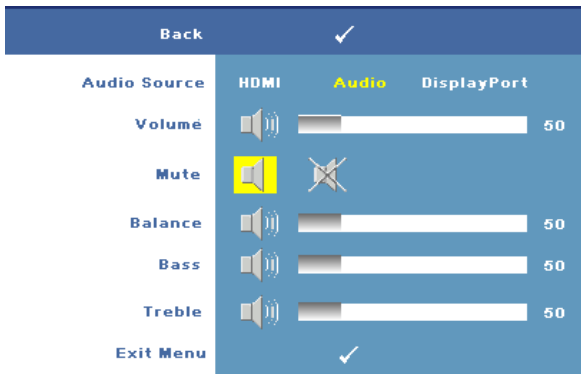

OTHERS



AUDIO SETTINGS—Press Enter to open the Audio Settings menu.



- **Audio Source**—Select either **HDMI**, **Audio (Audio In)**, or **DisplayPort** as the audio source for use.
- **Volume**—Press  to decrease the volume and  to increase the volume.
- **Mute**—Allows you to mute the sound.
- **Balance**—Use  or  to adjust the left and right speaker balance.
- **Bass**—Use  or  to adjust the bass tones.
- **Treble**—Use  or  to adjust the treble tones.

CLOSED CAPTION—Select **On** to deliver closed caption content to accommodate the hearing-impaired. Select **Off** to disable closed caption. Select a suitable caption channel from CC1 ~ CC4 and Text1 ~ Text4.



NOTE: Closed caption is only supported for input signals of S-Video and Composite Video.

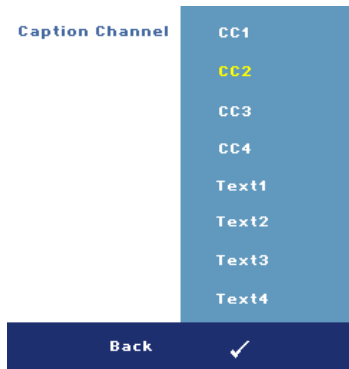

CUSTOMIZED SCREEN—Press **Enter** to pop up a **Customized Screen** menu. Input in a source then press **Enter** and select **Yes**. The projector will capture the screen image as a **My Customized logo**. This screen replaces all the original screens with the Dell logo. You can recover the default screen by selecting **Dell Logo** on the pop-up screen.

MENU LOCK—Select **On** to enable the Menu Lock and hide the OSD menu. Select **OFF** to disable the Menu Lock and display the OSD menu.



NOTE: If the OSD disappears while you disable Menu Lock, press the **Menu** button on the projector's control panel or the remote control for 15 seconds, and then disable the function.

MENU TIMEOUT—Allows you to adjust the time for an **OSD Timeout**. By default, the OSD disappears after 30 seconds of non-activity.

MENU POSITION—Allows you to select the position of the OSD menu on the screen.

MENU TRANSPARENCY—Select to change the transparency level of the OSD background.

PASSWORD—When **Password Protect** is enabled, a Password Protect screen requesting you to enter a password will be displayed when the power for the projector is first turned on. By default, this function is disabled. You can enable this feature by using the **Password** menu. This password security feature will be activated the next time you turn on the projector and you will be asked to enter the projector's password:

You can use the following steps to enable the Password Protect feature and set a password. The last step (step 3) describes how you can disable the password.

- 1 First time password input request:
 - a Go to **Others** menu, press **Enter** and then select **Password Enable** to enable the password setting.



- b Enabling the Password function will pop up a character screen. Key in a 4-digit character code (letters and/or numbers) on the screen and press the **Enter** button.

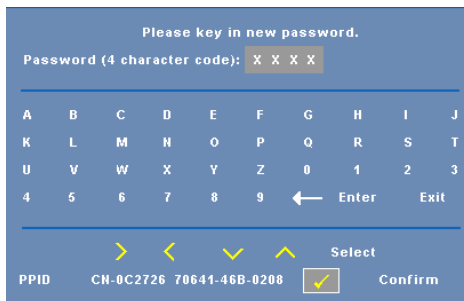

- c To confirm, enter the password again.

- d If the password verification is successful, you can resume accessing the projector's functions and its utilities.
- 2 If you have entered an incorrect password, you will be given another two chances to enter the correct password. After three invalid attempts, the projector will automatically turn off.

 **NOTE:** If you forget your password, contact Dell™ (see "Contacting Dell™" on page 56) or contact qualified service personnel.

- 3 To cancel the password function, select **Off** and enter the password to disable the function.

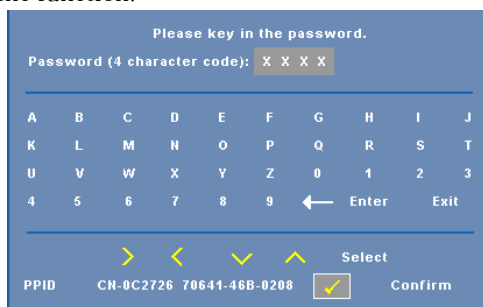

CHANGE PASSWORD—Key in the original password, then enter the new password and confirm the new password again.

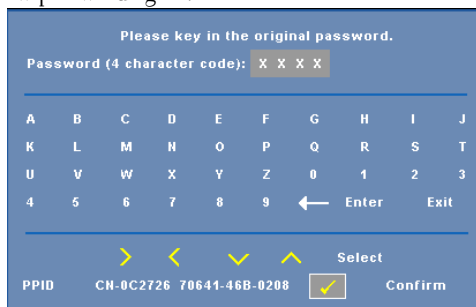







TEST PATTERN—Select **On** to activate the built-in **Test Pattern** for self-testing on focus and resolution. Select **Off** to disable the function.

FACTORY RESET—Select **On** to reset the projector to its factory default settings. Reset items include both computer sources and video source settings.

Troubleshooting Your Projector

If you experience problems with your projector, see the following troubleshooting tips. If the problem persists, contact Dell™. See "Contacting Dell™" on page 56.

Problem	Possible Solution
No image appears on the screen	<ul style="list-style-type: none">• Ensure that the lens cap is removed and the projector is turned on.• Ensure the external graphics port is enabled. If you are using a Dell™ portable computer, press   (Fn+F8). For other computers, see your respective documentation.• Ensure that all the cables are securely connected. See "Connecting Your Projector" on page 8.• Ensure that the pins of the connectors are not bent or broken.• Ensure that the lamp is securely installed (see "Changing the Lamp" on page 48).• Use Test Pattern in the Others menu. Ensure that the colors of the test pattern are correct.

Problem (continued)	Possible Solution (continued)
Partial, scrolling, or incorrectly displayed image	<ol style="list-style-type: none"> 1 Press the Auto Adjust button on the remote control or the control panel. 2 If you are using a Dell™ portable computer, set the resolution of the computer to WXGA (1280 x 800) or XGA (1024 x 768): <ol style="list-style-type: none"> a Right-click the unused portion of your Windows desktop, click Properties and then select Settings tab. b Verify that the setting is 1280 x 800 or 1024 x 768 pixels for the external monitor port. c Press   (Fn+F8). <p>If you experience difficulty in changing resolutions or your monitor freezes, restart all the equipment and the projector.</p> <p>If you are not using a Dell™ portable computer, see your documentation.</p> <p>If problem persists, upgrade your computer graphic card driver (video driver) to its latest version and test again with projector.</p>
The screen does not display your presentation	If you are using a Dell™ portable computer, press   (Fn+F8).
Image is unstable or flickering	Adjust the tracking in the OSD Display sub-menu (in PC Mode only).
Image has vertical flickering bar	Adjust the frequency in the OSD Display sub-menu (in PC Mode only).
Image color is incorrect	<ul style="list-style-type: none"> • If the display receives the wrong signal output from the graphics card, please set the signal type to RGB in the OSD Display tab. • Use Test Pattern in the Others menu. Ensure that the colors of the test pattern are correct.
Image is out of focus	<ol style="list-style-type: none"> 1 Adjust the focus ring on the projector lens. 2 Ensure that the projection screen is within the required distance from the projector (3.28 ft [1 m] to 39.37 ft [12 m]).

Problem (continued)	Possible Solution (continued)
The image is stretched when displaying a 16:9 DVD	<p>The projector automatically detects the input signal format. It will maintain the aspect ratio of the projected image according to the input signal format with an Original setting.</p> <p>If the image is still stretched, adjust the aspect ratio in the Set Up menu in the OSD.</p>
Image is reversed	Select Set Up from the OSD and adjust the projector mode.
Lamp is burned out or makes a popping sound	When the lamp reaches its end of life, it may burn out and may make a loud popping sound. If this occurs, the projector does not turn back on. To replace the lamp, see "Changing the Lamp" on page 48.
LAMP light is solid amber	If the LAMP light is solid amber, replace the lamp.
LAMP light is blinking amber	<p>If the LAMP light and the Power light are blinking amber, this means that the lamp driver has failed and the projector will automatically shut down.</p> <p>If the LAMP light is blinking amber and the Power light is solid blue, this means that the color wheel has failed and the projector will automatically shut down.</p> <p>Unplug the power cable after 3 minutes and then turn the display on again. If this problem persists, contact Dell™. (See "Contacting Dell™" on page 56)</p>
TEMP light is solid amber	The projector is overheated and the display automatically shuts down. Turn the display on again after the projector cools down. If the problem persists, contact Dell™. (See "Contacting Dell™" on page 56)
TEMP light is blinking amber	A projector fan has failed and the projector will automatically shut down. If the problem persists, contact Dell™. (See "Contacting Dell™" on page 56)

Problem (continued)	Possible Solution (continued)
The OSD does not appear on the screen	Try to press the Menu button on the panel or the remote control for 15 seconds to unlock the OSD. Check the Menu Lock "Menu Lock" on page 41.
The remote control is not operating smoothly or works only within a limited range	The battery may be low. Check if the laser beam transmitted from the remote is too dim. If so, replace the batteries with two new AAA batteries.

Changing the Lamp

The following message appears on the screen when your projector lamp is approaching its end of life and needs to be changed:

Lamp is approaching the end of its useful life in full power operation.
Replacement suggested! Visit www.dell.com/lamps

⚠ CAUTION: Before you begin any of the procedures in this section, follow the Safety Instructions as described on page 7.

To replace the lamp:

- 1 Turn off the projector and disconnect the power cable.

⚠ CAUTION: The lamp becomes very hot when in use. Do not attempt to replace the lamp until the projector has been allowed to cool down for at least 30 minutes.

- 2 Let the projector cool for at least 30 minutes.
- 3 Loosen the two screws that secure the lamp cover, and remove the cover.

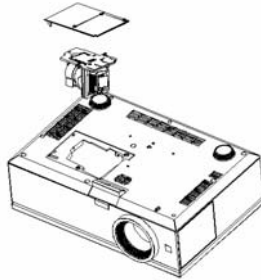

⚠ CAUTION: Do not touch the projector lamp or the lamp glass at any time. Projector lamps are very fragile and may shatter if touched.

⚠ CAUTION: If the lamp shatters, remove all the broken pieces from the projector and dispose or recycle according to state, local, or federal law. For more information see - www.dell.com/hg.

- 4 Loosen the two screws that secure the lamp.
- 5 Pull the lamp up by its metal handle.
- 6 Replace with the new lamp.
- 7 Tighten the two screws that secure the lamp.
- 8 Replace the lamp cover and tighten the two screws.

9 Reset the lamp usage time by selecting "Yes" for Lamp Reset in the OSD Lamp tab. (See "LAMP" on page 38.)



CAUTION: Lamp Disposal (for the US only)

 **LAMP(S) INSIDE THIS PRODUCT CONTAIN MERCURY AND MUST BE RECYCLED OR DISPOSED OF ACCORDING TO LOCAL, STATE OR FEDERAL LAWS. FOR MORE INFORMATION, GO TO WWW.DELL.COM/HG OR CONTACT THE ELECTRONIC INDUSTRIES ALLIANCE AT WWW.EIAE.ORG. FOR LAMP SPECIFIC DISPOSAL INFORMATION CHECK WWW.LAMPRECYCLE.ORG.**

Specifications

Light Valve	0.96" WUXGA DMD Type A, DarkChip™ 3
Brightness	3850 ANSI Lumens (Max.)
Contrast Ratio	2700:1 Typical (Full On/Full Off)
Uniformity	85% Typical (Japan Standard - JBMA)
Number of Pixels	1920x 1200 (WUXGA)
Displayable Color	Up to 1.07B colors (with Dithering)
Color Wheel Speed	2X
Projection Lens	F-Stop: F/ 2.6~2.9 Focal length, f=39.12~46.94 mm 1.2X manual Zoom Lens
Projection Screen Size	20.9-301.0 inches (diagonal)
Projection Distance	3.28~39.37 ft (1 m~12 m)
Video Compatibility	Composite Video, S-Video, NTSC (J/M/ 4.43MHz), PAL (B/D/G/H/I/M/N/ Nc/60), SECAM (B/D/G/K/K1/L), HDMI, and Component video (1080i/p, 720p, 576i/p, 480i/p) compatibility Composite video, Component video (via VGA and YPbPr RCA), S-video, and HDMI capability
Power Supply	Universal AC90-264 50/60 Hz with PFC input
Power Consumption	454 watts in full mode, 405 watts in eco mode
Audio	2 speakers, 5 watt RMS

Noise Level	35 dB(A) Full-on mode, 32 dB(A) Eco mode
Weight	13.4 lbs (6.08 kg)
Dimensions (W x D x H)	External 17.0 x 11.42 x 5.31 ± 0.04 inches (432 x 290 x 135 ± 1 mm)
Environmental	Operating temperature: 5°C - 35°C (41°F- 95°F) Humidity: 80% maximum Storage temperature: 0°C to 60°C (32°F to 140°F) Humidity: 90% maximum
Regulatory	FCC, CE, UL, cUL, Nemko-GS, ICES-003, GOST, NOM, SABS, SASO
I/O Connectors	Power: AC power input socket Computer input: two D-sub for analog/component, HDTV input signals Computer output: one 15-pin D-sub Video input: one composite video RCA, one S-video, and one set of component video RCA Audio input: one phone jack (diameter 3.5 mm) Audio output: one phone jack (diameter 3.5 mm) USB port: one USB slave for remote mouse support One mini-DIN RS232 for wired remote control from PC HDMI input: two HDMI connectors for HDMI signals (HDCP compliant). One DisplayPort connector for DisplayPort signals One RJ45 connector for networking

	DC jack 12 volt@200mA output, relay control for automatic projection screen control
	DC jack 5 volt@2.5A output, for powering external devices
Lamp	264~300-watt user-replaceable lamp, up to 2000 hours (up to 2500 hours in eco mode)

 **NOTE:** The actual operating life span of a projector lamp will vary according to operating conditions and usage patterns. Usage of a projector in stressful conditions which may include dusty environments, under high temperatures and abrupt powering-off may result in a lamp's shortened operating life span or possibly lamp failure. The lamp life specified for Dell's projectors refers to the typical time under non-stressful operating conditions for more than 50% of a sampling population to reduce to approximately 50% of the lamp's rated brightness level. It is not the measure of time a lamp will cease light output.

RS232 Pin Assignment

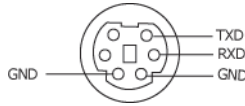

RS232 Protocol

- Communication Settings

Connection settings	Value
Baud Rate:	19200
Data Bits:	8
Parity	None
Stop Bits	1

- Command types

To pop up the OSD menu and adjust the settings.

- Control command Syntax (From PC to Projector)

[H][AC][SoP][CRC][ID][SoM][COMMAND]

- **Example:** Power ON Command (Send low byte firstly)

--> 0xBE, 0xEF, 0x10, 0x05, 0x00, 0xC6, 0xFF, 0x11, 0x11, 0x01, 0x00, 0x01

- Control Commands List

To view the latest RS232 code, go to the Dell Support site at: support.dell.com.

PIP Combination Sources

	VGA-A	VGA-B	Component	HDMI-A	HDMI-B	DisplayPort	S-Video /Composite
VGA-A	No	No	Yes	Yes	Yes	Yes	Yes
VGA-B	No	No	Yes	Yes	Yes	Yes	Yes
Component	Yes	Yes	No	Yes	Yes	Yes	Yes
HDMI-A	Yes	Yes	Yes	No	No	No	Yes
HDMI-B	Yes	Yes	Yes	No	No	No	Yes
DisplayPort	Yes	Yes	Yes	No	No	No	Yes
S-Video /Composite	Yes	Yes	Yes	Yes	Yes	Yes	No

Compatibility Modes (Analog/Digital)

Resolution	V. Frequency (Hz)	H. Frequency (KHz)
640X480	60	31.5
640X480	75	37.5
640X480	85	43.3
720X400	70.1	31.5
720X400	85	38
800X600	60.3	37.9
800X600	75	46.9
800X600	85.1	53.7
848X480	60	31
1024X768	60	48.4
1024X768	75	60
1024X768	85	68.7
1280X720	60	44.8
1280X768	60	47.8
1280X800	60	49.7
1280X1024	60	64
1280X1024	75	80
1280X1024	85	91.1
1360X768	60	47.7
1400X1050	60	65.3
1440X900	60	56
1600X1200	60	75
1680X1050	60	65.3
1920X1200-R	60	74

Contacting Dell™

For customers in the United States, call 800-WWW-DELL (800-999-3355).



NOTE: If you do not have an active Internet connection, you can find contact information on your purchase invoice, packing slip, bill, or Dell product catalog.

Dell provides several online and telephone-based support and service options. Availability varies by country and product, and some services may not be available in your area. To contact Dell for sales, technical support, or customer service issues:

- 1 Visit support.dell.com.
- 2 Verify your country or region in the **Choose A Country/Region** drop-down menu at the bottom of the page.
- 3 Click **Contact Us** on the left side of the page.
- 4 Select the appropriate service or support link based on your need.
- 5 Choose the method of contacting Dell that is convenient for you.

Appendix: Glossary

ANSI LUMENS—A standard for measuring the brightness. It is calculated by dividing a square meter image into nine equal rectangles, measuring the lux (or brightness) reading at the center of each rectangle, and averaging these nine points.

ASPECT RATIO—The most popular aspect ratio is 4:3 (4 by 3). Early television and computer video formats are in a 4:3 aspect ratio, which means that the width of the image is $\frac{4}{3}$ times the height.

Brightness—The amount of light emitting from a display or projection display or projection device. The brightness of the projector is measured by ANSI lumens.

Color Temperature—The color appearance of white light. Low color temperature implies warmer (more yellow/red) light while high color temperature implies a colder (more blue) light. The standard unit for color temperature is Kelvin (K).

Component Video—A method of delivering quality video in a format that consists of the luminance signal and two separate chrominance signals and are defined as Y'Pb'Pr' for analog component and Y'Cb'Cr' for digital component. Component video is available on DVD players.

Composite Video—A video signal that combines the luma (brightness), chroma (color), burst (color reference), and sync (horizontal and vertical synchronizing signals) into a signal waveform carried on a single wire pair. There are three kind of formats, namely, NTSC, PAL and SECAM.

Compressed Resolution—If the input images are of higher resolution than the native resolution of the projector, the resulting image will be scaled to fit the native resolution of the projector. The nature of compression in a digital device means that some image content is lost.

Contrast Ratio—Range of light and dark values in a picture, or the ratio between their maximum and minimum values. There are two methods used by the projection industry to measure the ratio:

1 *Full On/Off*—measures the ratio of the light output of an all white image (full on) and the light output of an all black (full off) image.

2 *ANSI*—measures a pattern of 16 alternating black and white rectangles. The average light output from the white rectangles is divided by the average light output of the black rectangles to determine the ANSI contrast ratio.

Full On/Off contrast is always a larger number than ANSI contrast for the same projector.

dB— decibel—A unit used to express relative difference in power or intensity, usually between two acoustic or electric signals, equal to ten times the common logarithm of the ratio of the two levels.

Diagonal Screen— A method of measuring the size of a screen or a projected image. It measures from one corner to the opposite corner. A 9FT high, 12FT wide, screen has a diagonal of 15FT. This document assumes that the diagonal dimensions are for the traditional 4:3 ratio of a computer image as per the example above.

DisplayPort— A digital display interface standard developed by the Video Electronics Standards Association (VESA). DisplayPort is designed for broad application in PCs, monitors, TV displays, projectors, and other sources of display content.

DLP®— Digital Light Processing™—Reflective display technology developed by Texas Instruments, using small manipulated mirrors. Light passing through a color filter is sent to the DLP mirrors which arrange the RGB colors into a picture projected onto the screen, also known as DMD.

DMD— digital Micro- Mirror Device— Each DMD consists of thousands of tilting, microscopic aluminum alloy mirrors mounted on a hidden yoke.

DVI-D— Digital Visual Interface-Digital connector.

Focal Length— The distance from the surface of a lens to its focal point.

Frequency— It is the rate of repetition in cycles per seconds of electrical signals. Measured in Hz (Hertz).

HDMI— High Definition Multimedia Interface— A digital interface for audio and video signals designed as a single-cable solution for home theater and consumer electronics equipment.

Hz (Hertz)— Unit of frequency.

Keystone Correction— Device that will correct an image of the distortion (usually a wide-top narrow-bottom effect) of a projected image caused by an improper projector to screen angle.

Maximum Distance— The maximum distance from a screen the projector can be to cast an image that is usable (bright enough) in a fully darkened room.

Maximum Image Size— The largest image a projector can throw in a darkened room. This is usually limited by the focal range of the optics.

Minimum Distance— The closest position at which a projector can focus an image onto a screen.

NTSC— National Television Standards Committee. North American standard for video and broadcasting, with a video format of 525 lines at 30 frames per second.

PAL— Phase Alternating Line. A European broadcast standard for video and broadcasting, with a video format of 625 lines at 25 frames per second.

Reverse Image— Feature that allows you to flip the image horizontally. When used in a normal forward projection environment, text, graphics, etc, are backwards. Reverse image is used for rear projection.

RGB— Red, Green, Blue— typically used to describe a monitor that requires separate signals for each of the three colors.

S-Video—A video transmission standard that uses a 4-pin mini-DIN connector to send video information along two signal wires called luminance (brightness, Y) and chrominance (color, C). S-Video is also referred to as Y/C.

SECAM— A French and international broadcast standard for video and broadcasting, closely related to PAL but with a different method of sending color information.

SVGA— Super Video Graphics Array,— 800 x 600 pixels count.

SXGA— Super Extended Graphics Array,—1280 x 1024 pixels count.

UXGA— Ultra Extended Graphics Array,—1600 x 1200 pixels count.

VGA— Video Graphics Array—640 x 480 pixels count.

WUXGA— Widescreen Ultra Extended Graphics Array,—1920 x 1200 pixels count.

XGA— Extended Graphics Array— 1024 x 768 pixels count.

Zoom Lens— Lens with a variable focal length that allows the operator to move the view in or out thereby making the image smaller or larger.

Zoom Lens Ratio— Is the ratio between the smallest and largest image that a lens can project from a fixed distance. For example, a 1.4:1 zoom lens ratio means that a 10 foot image without zoom would be a 14 foot image with full zoom.

Index

A

- Adjusting the Projected Image 22
 - Adjusting the Projector Height 22
 - lower the projector
 - Elevator button 22
 - Elevator foot 22
 - Tilt adjustment wheel 22
- Adjusting the Projector Zoom and Focus 23
 - Focus ring adjustment 23
 - Horizontal lens shift knob 23
 - Side door 23
 - Vertical lens shift knob 23
 - Zoom ring adjustment 23
 - Zoom tab 23

C

- Changing the Lamp 48
- Connecting the Projector
 - 12V DC power cable 19
 - Automatic screen 19
 - Commercial RS232 control box 20
 - Composite video cable 15
 - Connecting a Commercial RS232 Control Box 20
 - Connecting a Computer with a DisplayPort cable 12, 13
 - Connecting a Computer with a

- RS232 cable 10
- Connecting a Computer with a VGA Cable 9
- Connecting a Computer with an Ethernet cable 11
- Connecting with a Component (VGA to YPbPr) Cable 16
- Connecting with a Component (YPbPr to YPbPr) Cable 17
- Connecting with a Composite Cable 15
- Connecting with an HDMI Cable 18
- Connecting with an S-video Cable 14
- Ethernet (RJ45) cable 11, 12
- HDMI cable 18
- Installing a Driving Automatic Screen 19
- Optional installation 19
- Power cable 9, 10, 11, 12, 13, 14, 15, 16, 17, 18, 19, 20
- RS232 cable 10, 20
- S-video cable 14
- To Computer 9
- To DVD Player 14
- USB to USB cable 9
- VGA to VGA cable 9, 13
- VGA to YPbPr cable 16
- YPbPr to YPbPr cable 17
- Connection Ports
 - 12 Volt DC relay output 8

- 5 Volt DC relay output 8
- Audio input connector 8
- Audio output connector 8
- Component video input connector 8
- Composite video input connector 8
- DisplayPort connector 8
- DVI-D input connector 8
- HDMI input connector 8
- Power cable connector 8
- RS232 connector 8
- Security cable slot 8
- S-video input connector 8
- USB remote connector 8
- VGA-A input (D-sub) connector 8
- VGA-B input (D-sub) connector 8
- VGA-B output (monitor loop-through) connector 8

Contact Dell 26, 46

Control Panel 25

D

Dell
contacting 56

M

Main Unit 7

- Control panel 7
- Elevator button 7
- Focus ring 7
- IR receiver 7

- Lens 7
- Lens cap 7

O

On-Screen Display 29

- Auto-Adjust 30
- Display (in PC Mode) 35
- Display (in Video Mode) 36
- Input Select 29
- Lamp 38
- Language 39
- Main Menu 29
- Others 40
- Picture (in PC Mode) 33
- Picture (in Video Mode) 34
- PIP Settings 37
- Set Up 31

P

phone numbers 56

Powering On/Off the Projector

- Powering Off the Projector 21
- Powering On the Projector 21

R

Remote Control 27

- IR receiver 26

S

Specifications

- Audio 50
- Brightness 50

- Color Wheel Speed 50
- Contrast Ratio 50
- Dimensions 51
- Displayable Color 50
- Environmental 51
- I/O Connectors 51
- Lamp 52
- Light Valve 50
- Noise Level 51
- Number of Pixels 50
- PIP combination sources 54
- Power Consumption 50
- Power Supply 50
- Projection Distance 50
- Projection Lens 50
- Projection Screen Size 50
- Regulatory 51
- RS232 Protocol 53
- Uniformity 50
- Video Compatibility 50
- Weight 51

support

- contacting Dell 56

T

- telephone numbers 56

Troubleshooting 44

- Contact Dell 44