

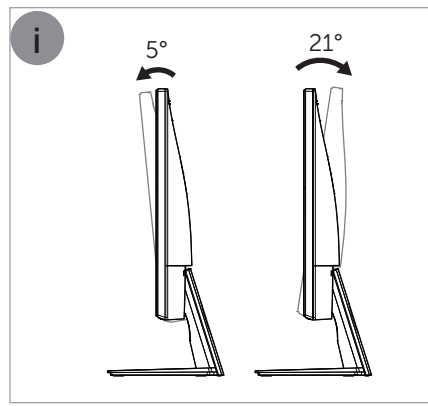

# Dell SE2717H

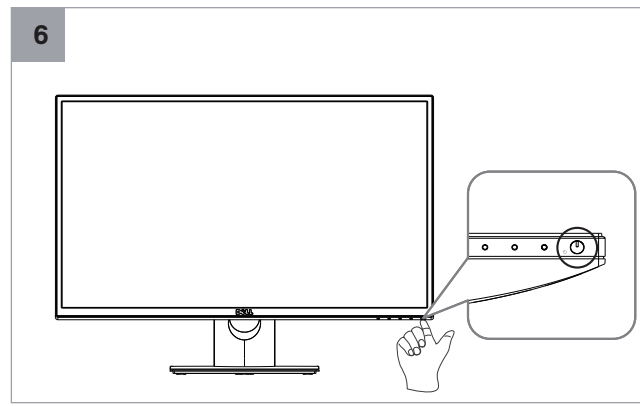
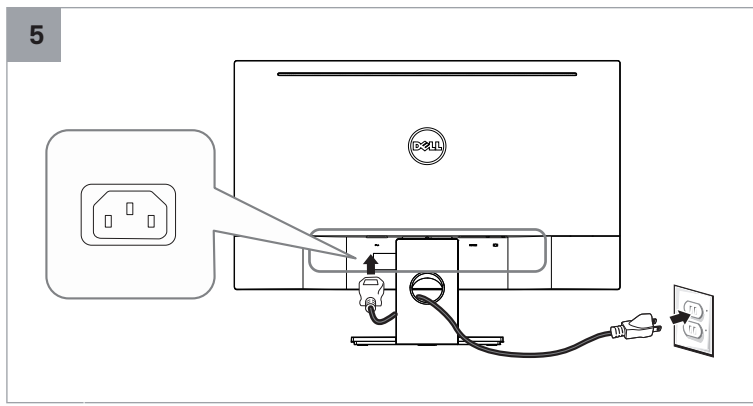
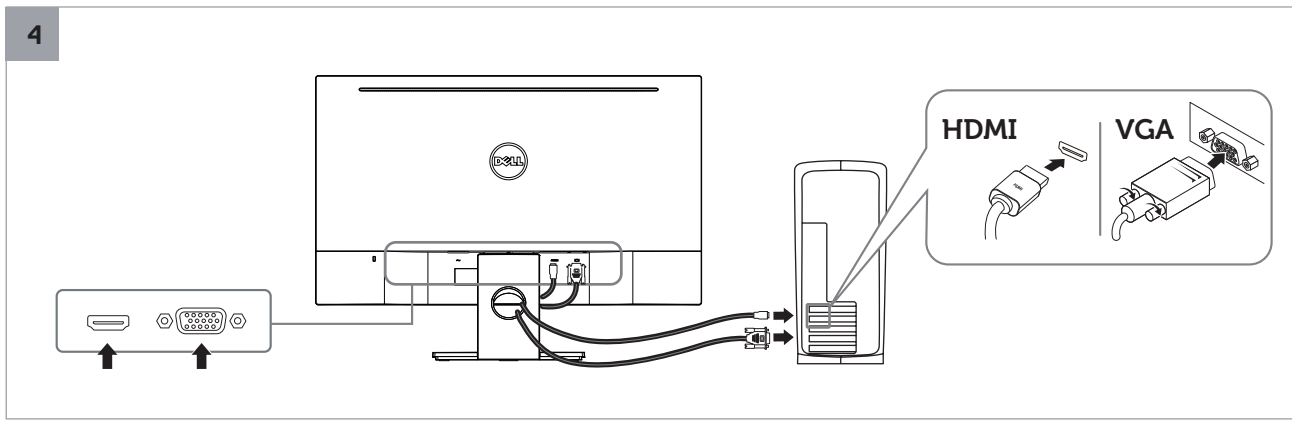
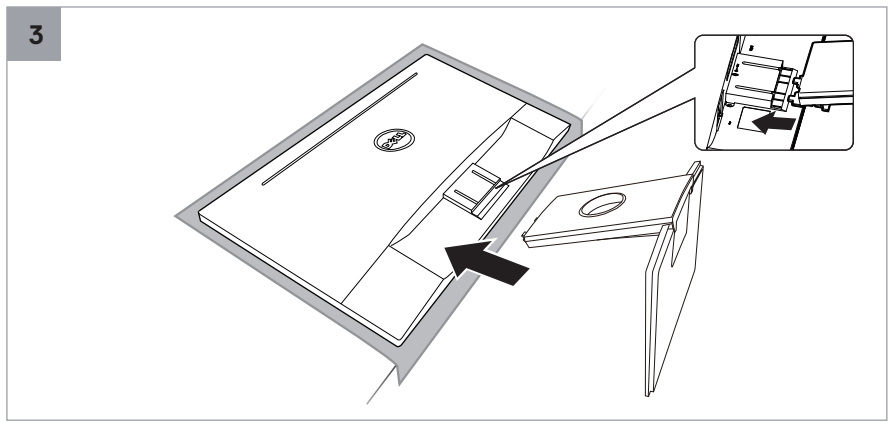
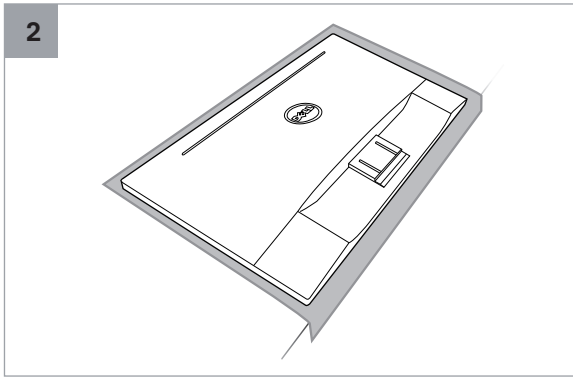
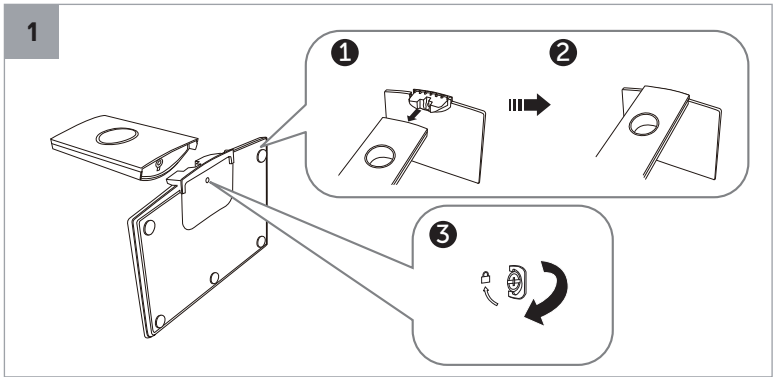
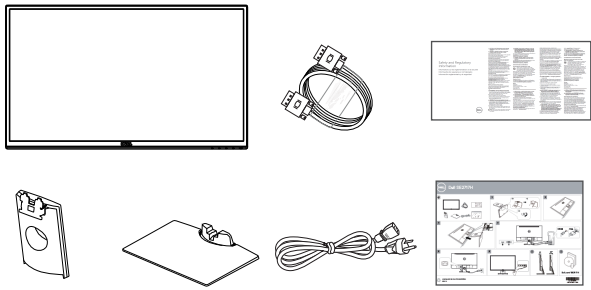

# Taiwan RoHS

## RoHS 聲明（僅針對台灣）

單元	限用物質及其化學符號					
	鉛 (Pb)	汞 (Hg)	鎘 (Cd)	六價鉻 (Cr <sup>+6</sup> )	多溴聯苯 (PBB)	多溴二苯醚 (PBDE)
機箱/檔板/支架	—	○	○	○	○	○
電路板組件	—	○	○	○	○	○
FP顯示螢幕	—	○	○	○	○	○
電線/連接器	—	○	○	○	○	○
電源設備	—	○	○	○	○	○
喇叭/麥克風	—	○	○	○	○	○
配件	—	○	○	○	○	○

備考1. “○”係指該項限用物質之百分比含量未超出百分比含量基準值。  
備考2. “—”係指該項限用物質為排除項目。