

Dell™ P2212H/P2312H Monitor

[User's Guide](#)

[Setting the display resolution to 1920 x 1080 \(maximum\)](#)

**Information in this document is subject to change without notice.
© 2011 Dell Inc. All rights reserved.**

Reproduction of these materials in any manner whatsoever without the written permission of Dell Inc. is strictly forbidden.

Trademarks used in this text: *Dell* and the *DELL* logo are trademarks of Dell Inc.; *Microsoft* and *Windows* are either trademarks or registered trademarks of Microsoft Corporation in the United States and/or other countries, *Intel* is a registered trademark of Intel Corporation in the U.S. and other countries; and *ATI* is a trademark of Advanced Micro Devices, Inc. ENERGY STAR is a registered trademark of the U.S. Environmental Protection Agency. As an ENERGY STAR partner, Dell Inc. has determined that this product meets the ENERGY STAR guidelines for energy efficiency.

Other trademarks and trade names may be used in this document to refer to either the entities claiming the marks and names or their products. Dell Inc. disclaims any proprietary interest in trademarks and trade names other than its own.

Model P2212Hb/P2312Ht

November 2011 Rev. A01

Dell™ P2212H/P2312H Monitor User's Guide

[About Your Monitor](#)



[Setting Up the Monitor](#)

[Operating the Monitor](#)

[Troubleshooting](#)

[Appendix](#)

Notes, Cautions, and Warnings

-  **NOTE:** A NOTE indicates important information that helps you make better use of your computer.
 -  **CAUTION:** A CAUTION indicates potential damage to hardware or loss of data if instructions are not followed.
 -  **WARNING:** **A WARNING indicates a potential for property damage, personal injury, or death.**
-

Information in this document is subject to change without notice.
© 2011 Dell Inc. All rights reserved.

Reproduction of these materials in any manner whatsoever without the written permission of Dell Inc. is strictly forbidden.

Trademarks used in this text: *Dell* and the *DELL* logo are trademarks of Dell Inc; *Microsoft* and *Windows* are either trademarks or registered trademarks of Microsoft Corporation in the United States and/or other countries, *Intel* is a registered trademark of Intel Corporation in the U.S. and other countries; and *ATI* is a trademark of Advanced Micro Devices, Inc. ENERGY STAR is a registered trademark of the U.S. Environmental Protection Agency. As an ENERGY STAR partner, Dell Inc. has determined that this product meets the ENERGY STAR guidelines for energy efficiency.

Other trademarks and trade names may be used in this document to refer to either the entities claiming the marks and names or their products. Dell Inc. disclaims any proprietary interest in trademarks and trade names other than its own.

Model P2212Hb/P2312Ht

November 2011 Rev. A01

Setting Up Your Monitor

Dell™ P2212H/P2312H Monitor

Setting the display resolution to 1920 x 1080 (maximum)

For maximum display performance with Microsoft® Windows® operating systems, set the display resolution to **1920 x 1080** pixels by performing the following steps:

In Windows XP:

1. Right-click on the desktop and click **Properties**.
2. Select the **Settings** tab.
3. Move the slider-bar to the right by pressing and holding the left-mouse button and adjust the screen resolution to **1920 x 1080**.
4. Click **OK**.

In Windows Vista® or Windows® 7:

1. Right-click on the desktop and click **Personalization**.
2. Click **Change Display Settings**.
3. Move the slider-bar to the right by pressing and holding the left-mouse button and adjust the screen resolution to **1920 x 1080**.
4. Click **OK**.

If you do not see **1920 x 1080** as an option, you may need to update your graphics driver. Please choose the scenario below that best describes the computer system you are using, and follow the given steps.

1: [If you have a Dell™ desktop or a Dell™ portable computer with internet access.](#)

2: [If you have a non Dell™ desktop, portable computer, or graphics card.](#)

About Your Monitor

Dell™ P2212H/P2312H Monitor User's Guide

- [Package Contents](#)
- [Product Features](#)
- [Identifying Parts and Controls](#)
- [Monitor Specifications](#)
- [Plug and Play Capability](#)
- [Universal Serial Bus \(USB\) Interface](#)
- [LCD Monitor Quality and Pixel Policy](#)
- [Maintenance Guidelines](#)

Package Contents

Your monitor ships with the components shown below. Ensure that you have received all the components and [contact Dell](#) if something is missing.

- ✍ **NOTE:** Some items may be optional and may not ship with your monitor. Some features or media may not be available in certain countries.
- ✍ **NOTE:** To set up with any other stand, please refer to the respective stand setup guide for setup instructions.
- ✍ **NOTE:** P2212H/P2312H monitor is BFR/PVC-free (Halogen-free) excluding external cables.

	<ul style="list-style-type: none">• Monitor
	<ul style="list-style-type: none">• Stand



- Power Cable

- VGA Cable (Attached to the monitor)

- DVI Cable

- USB upstream cable (enables the USB ports on the monitor)

- *Drivers and Documentation media*
- *Quick Setup Guide*
- *Product and Safety Information Guide*

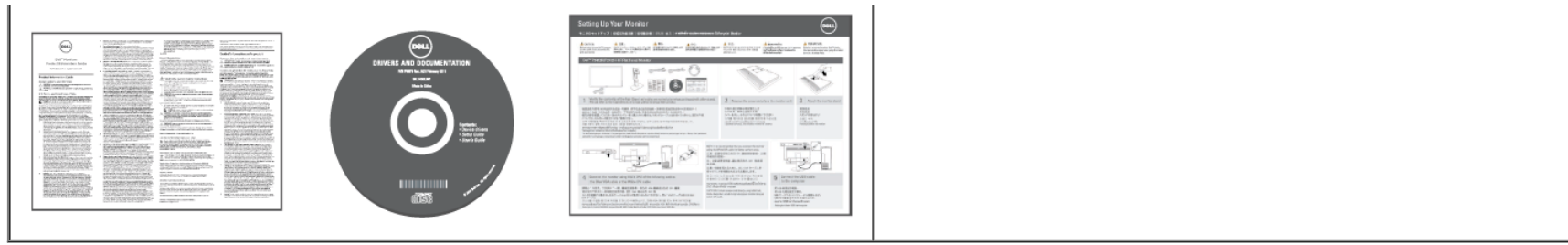

Product Features

The **Dell Professional P2212H/P2312H** flat panel display has an active matrix, Thin-Film Transistor (TFT), Liquid Crystal Display (LCD) and LED backlight. The monitor features include:

- **P2212H:** 54.68 cm (21.5-inch) viewable area display (measured diagonally). 1920 x 1080 resolution, plus full-screen support for lower resolutions.
- **P2312H:** 58.42 cm (23-inch) viewable area display (measured diagonally). 1920 x 1080 resolution, plus full-screen support for lower resolutions.
- Wide viewing angle to allow viewing from a sitting or standing position, or while moving from side-to-side.
- Tilt, swivel, vertical extension and rotate adjustment capability.
- Removable stand and Video Electronics Standards Association (VESA™) 100 mm mounting holes for flexible mounting solutions.
- Plug and play capability if supported by your system.
- On-Screen Display (OSD) adjustments for ease of set-up and screen optimization.
- Software and documentation media includes an Information File (INF), Image Color Matching File (ICM), PowerNap software application and product documentation.
- Energy Saver feature for Energy Star compliance.
- Security lock slot.
- Stand lock.
- Asset Management Capability.
- Capability to switch from wide aspect to standard aspect ratio while maintaining the image quality.
- EPEAT Gold Rating.
- P2212H/P2312H monitor is BFR/PVC-free (Halogen-free) excluding external cables.
- TCO-Certified Displays.
- PowerNap Software included (comes in the CD shipped with the monitor).
- Arsenic-Free glass and Mercury-Free for the panel only.
- High Dynamic Contrast Ratio (2,000,000: 1).
- 0.1 W standby power when in the sleep mode.
- Energy Gauge shows the energy level being consumed by the monitor in real time.

Identifying Parts and Controls

Front View



Front view

Front panel controls

Label	Description
1	Preset Modes (default, but configurable)
2	Brightness & Contrast (default, but configurable)
3	Menu
4	Exit
5	Power (with power light indicator)

Back View

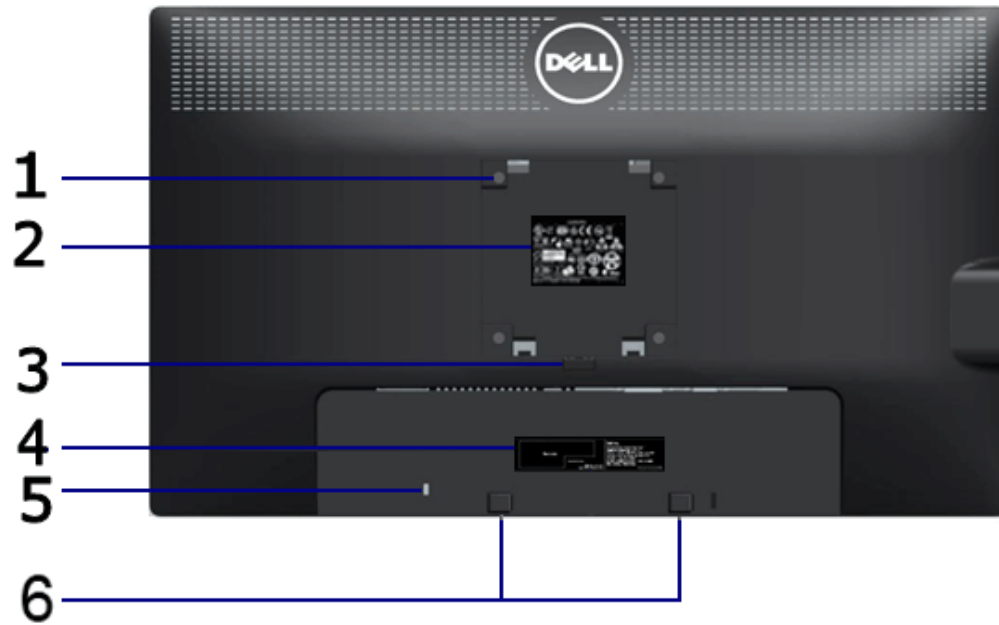

Back view



Back view with monitor stand

Label	Description	Use
1	VESA mounting holes (100 mm x 100 mm - behind attached VESA Plate)	Wall mount monitor using VESA-compatible wall mount kit (100 mm x 100 mm).
2	Regulatory label	Lists the regulatory approvals.
3	Stand release button	Release stand from monitor.
4	Barcode serial number label	Refer to this label if you need to contact Dell for technical support.
5	Security lock slot	Secures monitor with security cable lock.
6	Dell Soundbar mounting brackets	Attaches the optional Dell Soundbar.
7	USB downstream ports	Connect your USB devices.
8	Cable management slot	Use to organize cables by placing them through the slot.

Side View

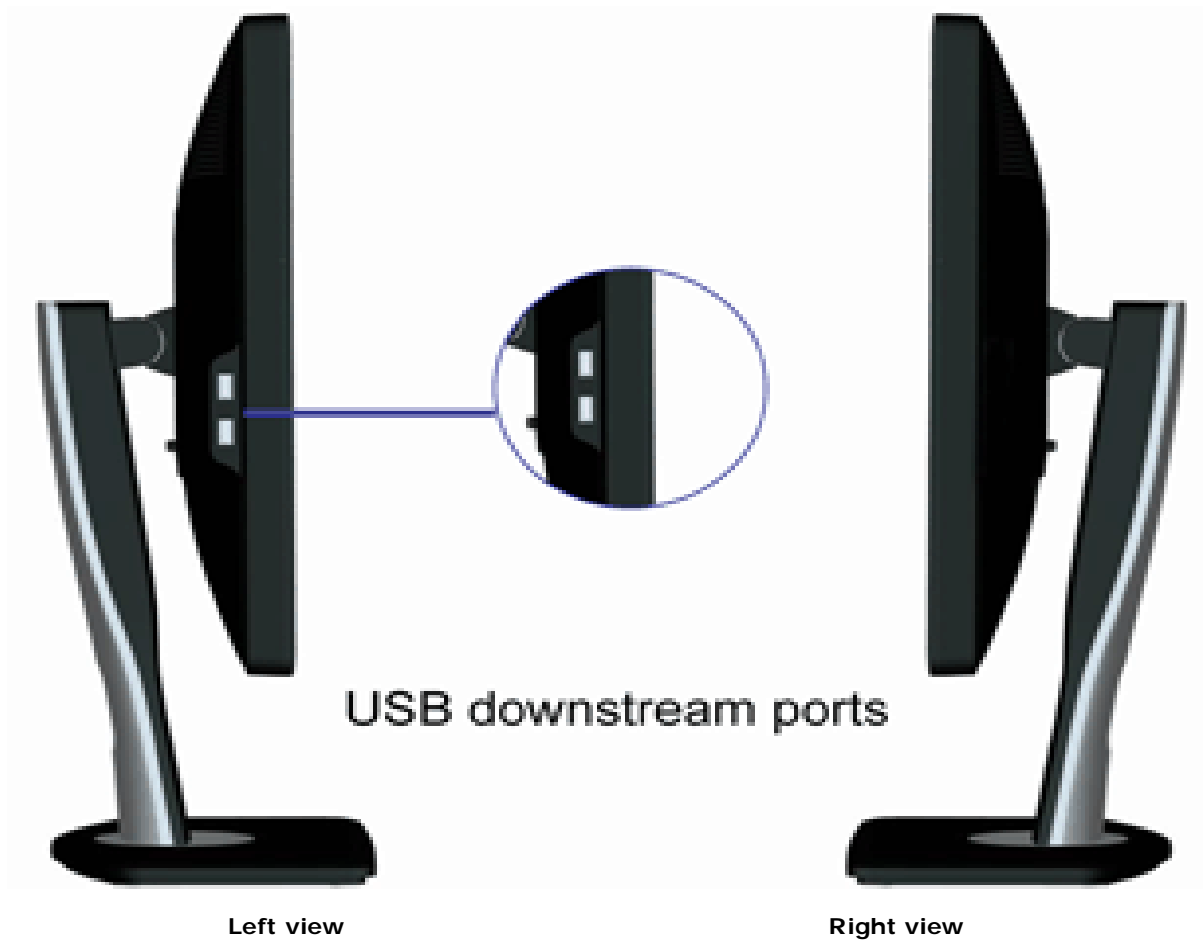

Bottom View

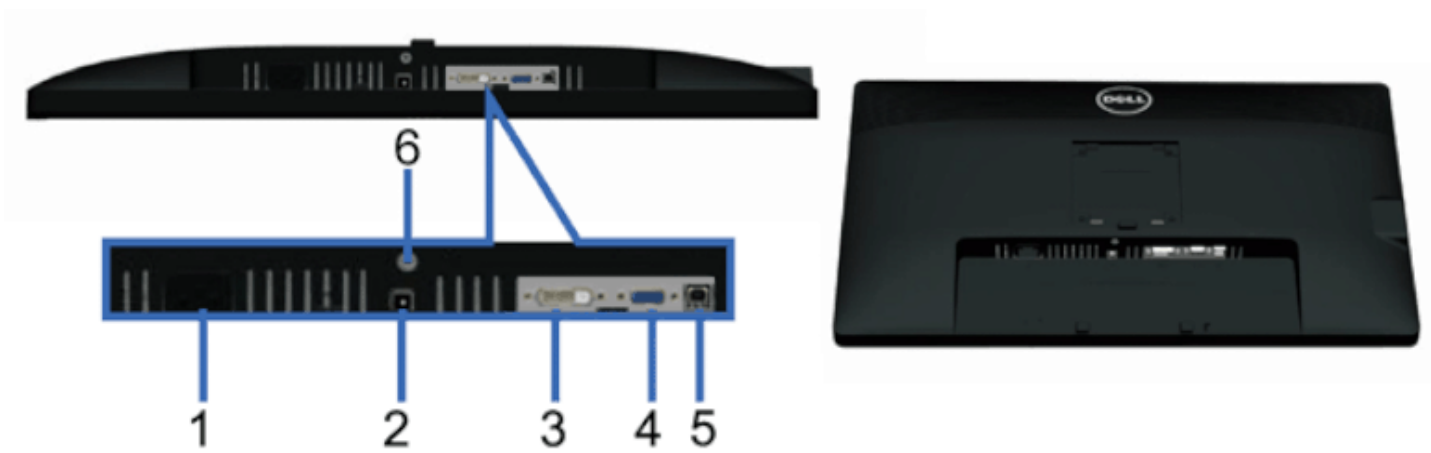

Bottom view

Bottom view with monitor stand

Label	Description	Use
1	AC power cord connector	Connect the power cable.
2	DC power connector for Dell Soundbar	Connect the power cord for the soundbar (optional).
3	DVI connector	Connect your computer DVI cable.
4	VGA connector	Connect your computer VGA cable.
5	USB upstream port	Connect the USB cable that came with your monitor to the monitor and the computer. Once this cable is connected, you can use the USB connectors on the side of the monitor.
6	Stand lock feature	To lock the stand to the monitor using M3 x 6 mm screw (screw is not provided).

Monitor Specifications

Flat Panel Specifications

Model	P2212H	P2312H
Screen type	Active matrix - TFT LCD	Active matrix - TFT LCD
Panel type	TN	TN
Screen dimensions	546.8 mm (21.5-inches diagonal viewable image size)	584.2 mm (23-inches diagonal viewable image size)
Preset display area	476.64 (H) X 268.11 (V) mm	509.76 (H) X 286.74 (V) mm
Horizontal	476.64 mm (18.77 inches)	509.76 mm (20.07 inches)
Vertical	268.11 mm (10.56 inches)	286.74 mm (11.29 inches)

Pixel pitch	0.248 mm	0.265 mm
Viewing angle	160° (vertical) typical 170° (horizontal) typical	160° (vertical) typical 170° (horizontal) typical
Luminance output	250 cd/m ² (typical)	250 cd/m ² (typical)
Contrast ratio	1000 to 1 (typical) 2M to 1 (typical Dynamic Contrast On)	1000 to 1 (typical) 2M to 1 (typical Dynamic Contrast On)
Faceplate coating	Antiglare with hard-coating 3H	Antiglare with hard-coating 3H
Backlight	LED edgelight system	LED edgelight system
Response time	5 ms black to white (typical)	5 ms black to white (typical)
Color depth	16.7 million colors	16.7 million colors
Color gamut	82%*	84%*

*[P2212H] color gamut (typical) is based on CIE1976 (82%) and CIE1931 (72%) test standards.

*[P2312H] color gamut (typical) is based on CIE1976 (84%) and CIE1931 (72%) test standards.

Resolution Specifications

Model	P2212H/P2312H
Horizontal scan range	30 kHz to 83 kHz (automatic)
Vertical scan range	56 Hz to 76 Hz (automatic)
Maximum preset resolution	1920 x 1080 at 60 Hz

Supported Video Modes

Model	P2212H/P2312H
Video display capabilities (DVI playback)	480p, 480i, 576p, 720p, 1080p, 576i, 1080i

Preset Display Modes

P2212H/P2312H

Display Mode	Horizontal Frequency (kHz)	Vertical Frequency (Hz)	Pixel Clock (MHz)	Sync Polarity (Horizontal/Vertical)

VESA, 720 x 400	31.5	70.0	28.3	-/+
VESA, 640 x 480	31.5	60.0	25.2	-/-
VESA, 640 x 480	37.5	75.0	31.5	-/-
VESA, 800 x 600	37.9	60.0	40.0	+/+
VESA, 800 x 600	46.9	75.0	49.5	+/+
VESA, 1024 x 768	48.4	60.0	65.0	-/-
VESA, 1024 x 768	60.0	75.0	78.8	+/+
VESA, 1152 x 864	67.5	75.0	108.0	+/+
VESA, 1280 x 1024	64.0	60.0	108.0	+/+
VESA, 1280 x 1024	80.0	75.0	135.0	+/+
VESA, 1920 x 1080	67.5	60.0	148.5	+/+

Electrical Specifications

Model	P2212H and P2312H
Video input signals	<ul style="list-style-type: none"> Analog RGB, 0.7 Volts +/- 5%, positive polarity at 75 ohm input impedance Digital DVI-D TMDS, 600 mV for each differential line, positive polarity at 50 ohm input impedance
Synchronization input signals	Separate horizontal and vertical synchronizations, polarity-free TTL level, SOG (Composite SYNC on green)
AC input voltage/frequency/current	<ul style="list-style-type: none"> P2212H - 100 VAC to 240 VAC / 50 Hz or 60 Hz \pm 3 Hz / 1.2 A (typical) P2312H - 100 VAC to 240 VAC / 50 Hz or 60 Hz \pm 3 Hz / 1.5 A (typical)
Inrush current	<ul style="list-style-type: none"> 120 V : 30 A (Max) 240 V : 60 A (Max)

Physical Characteristics

Model	P2212H	P2312H
Connector type	15-pin D-subminiature, blue connector; DVI-D, white connector	15-pin D-subminiature, blue connector; DVI-D, white connector
Signal cable type	<ul style="list-style-type: none"> Digital: detachable, DVI-D, solid pins, shipped detached from the monitor Analog: attachable, D-Sub, 15 pins, shipped attached to the monitor 	<ul style="list-style-type: none"> Digital: detachable, DVI-D, solid pins, shipped detached from the monitor Analog: attachable, D-Sub, 15 pins, shipped attached to the monitor

Dimensions (with stand)		
Height (extended)	484.5 mm (19.07 inches)	493.9 mm (19.44 inches)
Height (compressed)	355.6 mm (14.00 inches)	365.0 mm (14.37 inches)
Width	513.0 mm (20.20 inches)	546.4 mm (21.51 inches)
Depth	183.3 mm (7.22 inches)	185.4 mm (7.3 inches)
Dimensions (without stand)		
Height	304.5 mm (11.99 inches)	323.3 mm (12.73 inches)
Width	513.0 mm (20.20 inches)	546.4 mm (21.51 inches)
Depth	59.5 mm (2.34 inches)	59.5 mm (2.34 inches)
Stand dimensions		
Height (extended)	401.2 mm (15.80 inches)	401.2 mm (15.80 inches)
Height (compressed)	358.1 mm (14.10 inches)	358.1 mm (14.10 inches)
Width	265.8 mm (10.46 inches)	279.8 mm (11.02 inches)
Depth	183.3 mm (7.22 inches)	185.4 mm (7.30 inches)
Weight		
Weight with packaging	7.45 kg (16.42 lbs)	7.24 kg (15.96 lbs)
Weight with stand assembly and cables	5.88 kg (12.96 lbs)	5.70 kg (12.57 lbs)
Weight without stand assembly (For wall mount or VESA mount considerations - no cables)	3.29 kg (7.24 lbs)	3.44 kg (7.58 lbs)
Weight of stand assembly	2.02 kg (4.45 lbs)	1.76 kg (3.87 lbs)
Front frame gloss	<ul style="list-style-type: none"> • Black Frame - 5.0 gloss unit (max.) • Silver Frame - 20.0 gloss unit (max.) 	<ul style="list-style-type: none"> • Black Frame - 5.0 gloss unit (max.) • Silver Frame - 20.0 gloss unit (max.)

Environmental Characteristics

Model	P2212H and P2312H
Temperature	

Operating	0 °C to 40 °C
Non-operating	<ul style="list-style-type: none"> Storage: -20 °C to 60 °C (-4 °F to 140 °F) Shipping: -20 °C to 60 °C (-4 °F to 140 °F)
Humidity	
Operating	10% to 80% (non-condensing)
Non-operating	<ul style="list-style-type: none"> Storage: 5% to 90% (non-condensing) Shipping: 5% to 90% (non-condensing)
Altitude	
Operating	3,048 m (10,000 ft) max
Non-operating	10,688 m (35,000 ft) max
Thermal dissipation	<p>P2212H:</p> <ul style="list-style-type: none"> 153.55 BTU/hour (maximum) 71.65 BTU/hour (typical) <p>P2312H</p> <ul style="list-style-type: none"> 170.61 BTU/hour (maximum) 85.30 BTU/hour (typical)

Power Management Modes

If you have VESA's DPM™ compliance display card or software installed in your PC, the monitor can automatically reduce its power consumption when not in use. This is referred to as *Power Save Mode**. If the computer detects input from the keyboard, mouse, or other input devices, the monitor automatically resumes functioning. The following table shows the power consumption and signaling of this automatic power saving feature:

P2212H

VESA Modes	Horizontal Sync	Vertical Sync	Video	Power Indicator	Power Consumption
Normal operation	Active	Active	Active	Blue	50 W (maximum) ** 21 W (typical)
Active-off mode	Inactive	Inactive	Blanked	Amber	Less than 0.1 W
Switch off	-	-	-	Off	Less than 0.1 W

P2312H

VESA Modes	Horizontal Sync	Vertical Sync	Video	Power Indicator	Power Consumption
Normal operation	Active	Active	Active	Blue	50 W (maximum) ** 25 W (typical)
Active-off mode	Inactive	Inactive	Blanked	Amber	Less than 0.1 W
Switch off	-	-	-	Off	Less than 0.1 W

The OSD functions only in the normal operation mode. When any button is pressed in the Active-off mode, one of the following messages will be displayed:

Dell P2212H/ P2312H

There is no signal coming from your computer. Press any key on the keyboard or move the mouse to wake it up. If there is no display, press the monitor button now to select the correct input source on the On-Screen-Display menu.



Activate the computer and the monitor to gain access to the OSD.



NOTE: This monitor is **ENERGY STAR**[®]-compliant.

- * Zero power consumption in OFF mode can only be achieved by disconnecting the main cable from the monitor.
- ** Maximum power consumption with max luminance, Dell Soundbar, and USB active.

Pin Assignments

VGA Connector

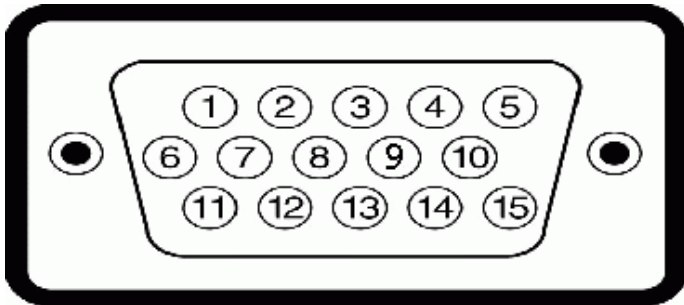

Pin Number	15-pin Side of the Connected Signal Cable
1	Video-Red
2	Video-Green
3	Video-Blue

4	GND
5	Self-test
6	GND-R
7	GND-G
8	GND-B
9	Computer 5 V/3.3 V
10	GND-sync
11	GND
12	DDC data
13	H-sync
14	V-sync
15	DDC clock

DVI Connector

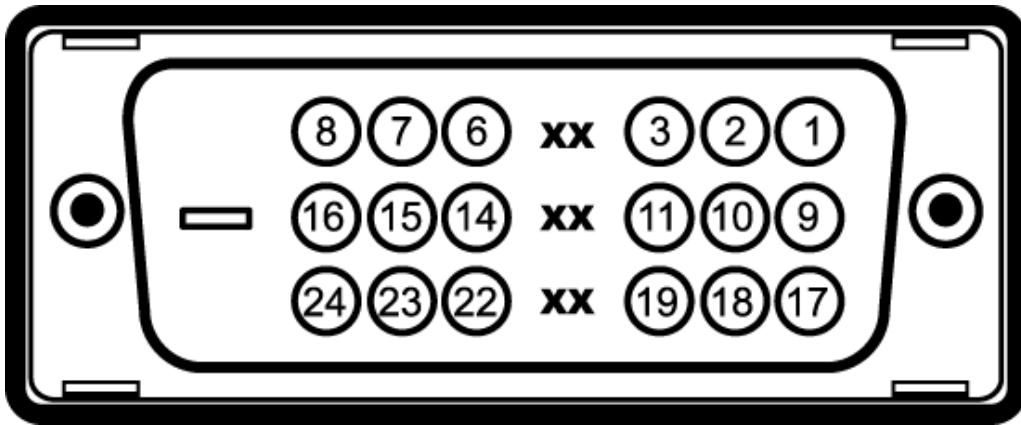

Pin Number	24-pin Side of the Connected Signal Cable
1	TMDS RX2-
2	TMDS RX2+
3	TMDS Ground
4	Floating
5	Floating
6	DDC Clock
7	DDC Data

8	Floating
9	TMDS RX1 -
10	TMDS RX1 +
11	TMDS Ground
12	Floating
13	Floating
14	+5 V/+3.3 V power
15	Self test
16	Hot Plug Detect
17	TMDS RX0 -
18	TMDS RX0 +
19	TMDS Ground
20	Floating
21	Floating
22	TMDS Ground
23	TMDS Clock +
24	TMDS Clock -

Plug and Play Capability

You can install the monitor in any Plug and Play-compatible system. The monitor automatically provides the computer system with its Extended Display Identification Data (EDID) using Display Data Channel (DDC) protocols so the system can configure itself and optimize the monitor settings. Most monitor installations are automatic; you can select different settings if desired. For more information about changing the monitor settings, see [Operating the Monitor](#).

Universal Serial Bus (USB) Interface

This section gives you information about the USB ports that are available on the left side of your monitor.

 **NOTE:** This monitor supports High-Speed Certified USB 2.0 interface.

Transfer Speed	Data Rate	Power Consumption
High speed	480 Mbps	2.5 W (Max, each port)
Full speed	12 Mbps	2.5 W (Max, each port)
Low speed	1.5 Mbps	2.5 W (Max, each port)

USB Upstream Connector

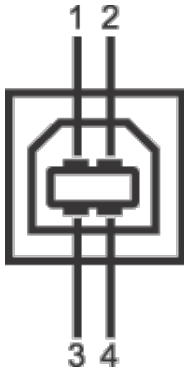

Pin Number	4-pin Side of the Connector
1	DMU
2	VCC
3	DPU
4	GND

USB Downstream Connector

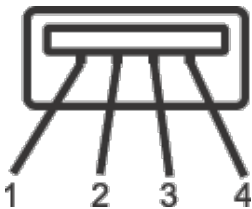

Pin Number	4-Pin Side of the Signal Cable
1	VCC
2	DMD
3	DPD
4	GND

USB Ports

- 1 upstream - back
- 2 downstream - 2 on the left side

 **NOTE:** USB 2.0 functionality requires a USB 2.0-capable computer.

NOTE: The monitor's USB interface works only when the monitor is On or in the power save mode. If you turn Off the monitor and then turn it On, the attached peripherals may



take a few seconds to resume normal functionality.

LCD Monitor Quality and Pixel Policy

During the LCD Monitor manufacturing process, it is not uncommon for one or more pixels to become fixed in an unchanging state which are hard to see and do not affect the display quality or usability. For more information on Dell Monitor Quality and Pixel Policy, see Dell Support site at: support.dell.com.

Maintenance Guidelines

Cleaning Your Monitor



CAUTION: Read and follow the [safety instructions](#) before cleaning the monitor.



WARNING: Before cleaning the monitor, unplug the monitor power cable from the electrical outlet.

For best practices, follow the instructions in the list below while unpacking, cleaning, or handling your monitor:

- To clean your anti-static screen, lightly dampen a soft, clean cloth with water. If possible, use a special screen-cleaning tissue or solution suitable for the anti-static coating. Do not use benzene, thinner, ammonia, abrasive cleaners, or compressed air.
 - Use a lightly-dampened, warm cloth to clean the monitor. Avoid using detergent of any kind as some detergents leave a milky film on the monitor.
 - If you notice white powder when you unpack your monitor, wipe it off with a cloth.
 - Handle your monitor with care as a darker-colored monitor may get scratched and show white scuff marks more than a lighter-colored monitor.
 - To help maintain the best image quality on your monitor, use a dynamically changing screen saver and turn off your monitor when not in use.
-

[Back to Contents Page](#)

Setting Up the Monitor

Dell™ P2212H/P2312H Monitor User's Guide

- [Attaching the Stand](#)
- [Connecting the Monitor](#)
- [Organizing Your Cables](#)
- [Attaching the Soundbar \(Optional\)](#)
- [Removing the Stand](#)
- [Wall Mounting \(Optional\)](#)

Attaching the Stand

 **NOTE:** The stand is detached when the monitor is shipped from the factory.

 **NOTE:** This is applicable for a monitor with a stand. When any other stand is bought, please refer to the respective stand setup guide for the set up instructions.



To attach the monitor stand:

1. Remove the cover and place the monitor on it.
2. Fit the two tabs on the upper part of the stand to the groove on the back of the monitor.
3. Press the stand till it snaps into place.

Connecting Your Monitor

 **WARNING:** Before you begin any of the procedures in this section, follow the [Safety Instructions](#).

To connect your monitor to the computer:

1. Turn off your computer and disconnect the power cable.
Connect the blue (VGA) cable from your monitor to the computer.

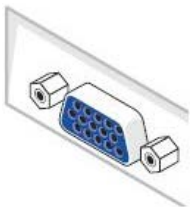

 **NOTE:** If your computer supports a white DVI connector, connect the white DVI cable to the monitor and the white DVI connector to your computer.

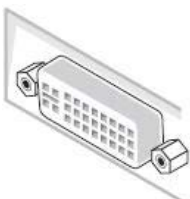

 **NOTE:** Do not connect the blue VGA or the white DVI cable to the computer at the same time.

2. Connect either the white (digital DVI-D) or the blue (analog VGA) display connector cable to the corresponding video port on the back of your computer. Do not connect both cables on the same computer. Use both the cables only when they are connected to two different computers with appropriate video systems.

Connecting the white DVI cable

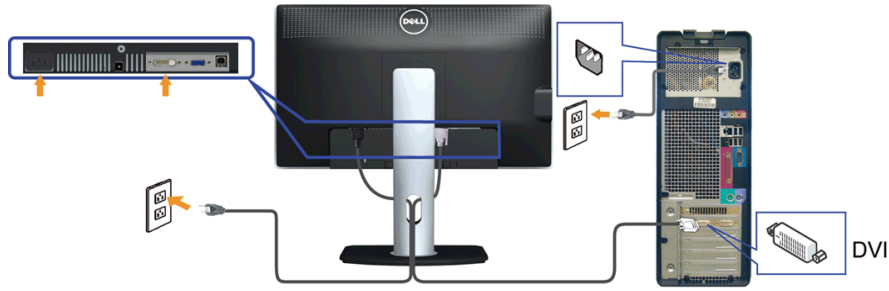

Connecting the blue VGA cable

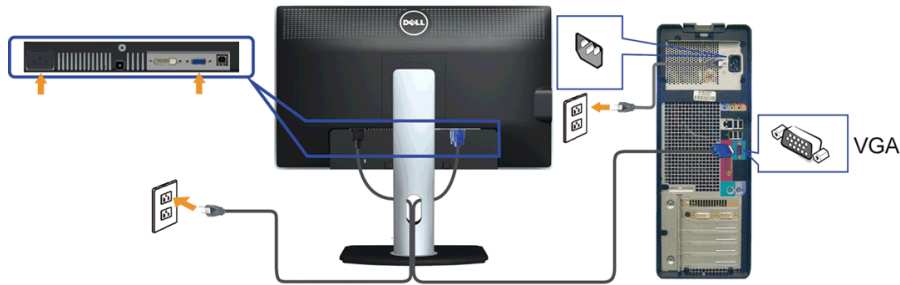

CAUTION: The graphics are used for the purpose of illustration only. Appearance of the computer may vary.

Connecting the USB cable

After you have completed connecting the DVI/VGA cable, follow the procedures below to connect the USB cable to the computer and complete your monitor setup:

1. Connect the upstream USB port (cable supplied) to an appropriate USB port on your computer. (See [bottom](#) view for details.)
2. Connect the USB peripherals to the downstream USB ports (side or bottom) on the monitor. (See [side](#) or [bottom](#) view for details.)
3. Plug the power cables for your computer and monitor into a nearby outlet.
4. Turn on the monitor and the computer.
If your monitor displays an image, installation is complete. If it does not display an image, see [Solving Problems](#).
5. Use the cable slot on the monitor stand to organize the cables.

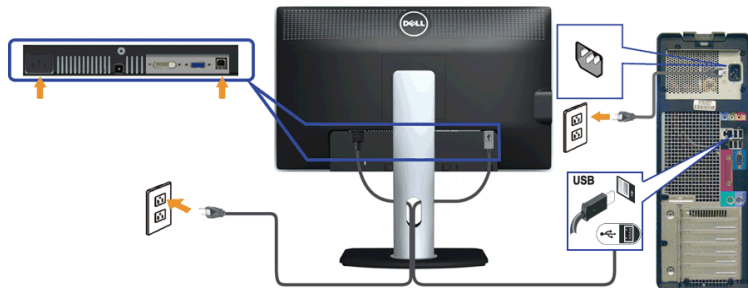

Organizing Your Cables



After attaching all necessary cables to your monitor and computer, (See [Connecting Your Monitor](#) for cable attachment.) organize all cables as shown above.

Attaching the Soundbar (Optional)

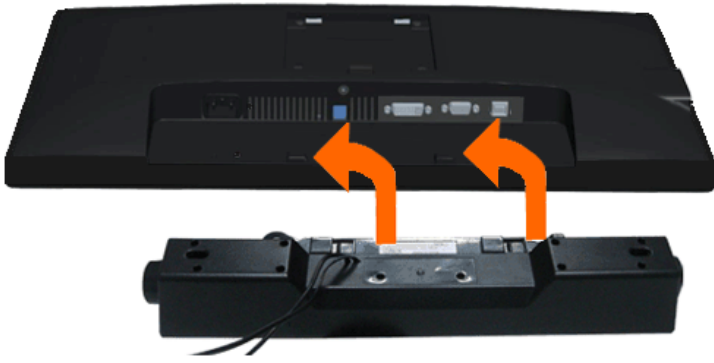

CAUTION: Do not use with any device other than the Dell Soundbar.

NOTE: The Soundbar power connector (+12 V DC output) is for the optional Dell Soundbar only.

To attach the Soundbar:

1. At the back of the monitor, attach the Soundbar by aligning the two slots with the two tabs along the bottom of the monitor.
2. Slide the Soundbar to the left until it snaps into place.
3. Connect the Soundbar with the DC power connector.
4. Insert the mini stereo plug from the back of the Soundbar into the computer's audio output jack.

Removing the Stand

NOTE: To prevent scratches on the LCD screen while removing the stand, ensure that the monitor is placed on a soft, clean surface.

NOTE: This is applicable for a monitor with a stand. When any other stand is bought, please refer to the respective stand setup guide for the set-up instructions.



To remove the stand:

1. Place the monitor on a flat surface.
2. Press and hold the stand release button.
3. Lift the stand up and away from the monitor.

Wall Mounting (Optional)

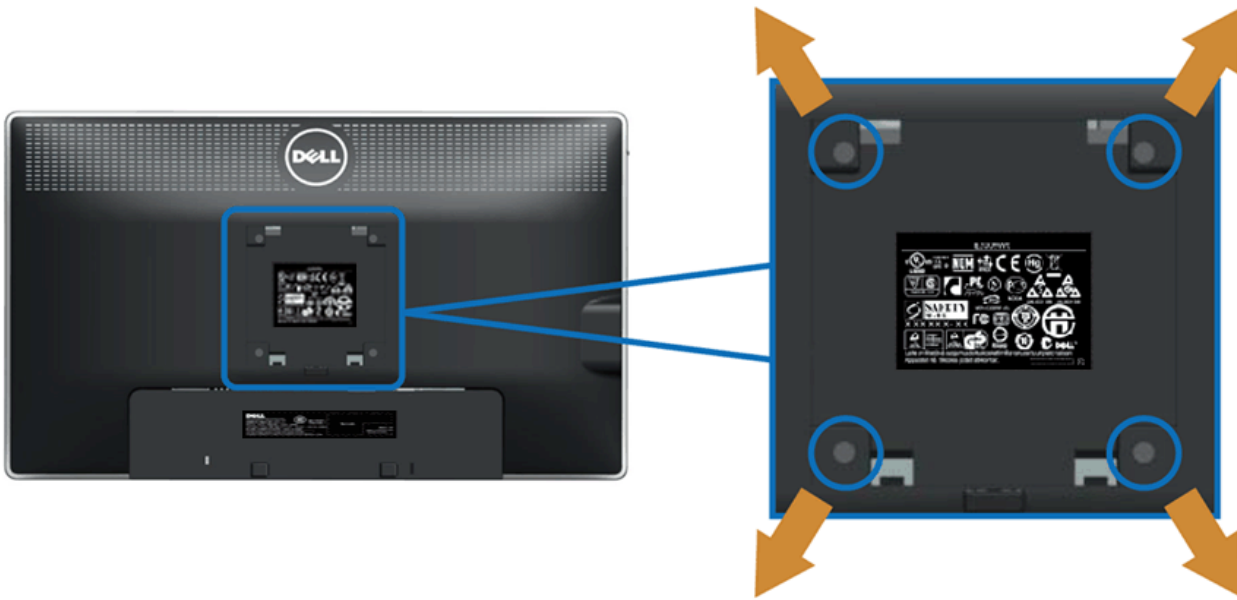

(Screw dimension: M4 x 10 mm).

Refer to the instructions that come with the VESA-compatible wall mounting kit.

1. Place the monitor panel on a soft cloth or cushion on a stable, flat table.
2. Remove the stand.
3. Use a Philips crosshead screwdriver to remove the four screws securing the plastic cover.
4. Attach the mounting bracket from the wall mounting kit to the monitor.
5. Mount the monitor on the wall by following the instructions that comes with the wall mounting kit.

 **NOTE:** For use only with UL-listed wall mount bracket with minimum weight/load bearing capacity of 5.88 kg.

[Back to Contents Page](#)

Operating the Monitor

Dell™ P2212H/P2312H Monitor User's Guide

- [Using the Front Panel](#)
 - [Using the On-Screen Display \(OSD\) Menu](#)
 - [PowerNap Software](#)
 - [Setting the Maximum Resolution](#)
 - [Using the Dell Soundbar \(Optional\)](#)
 - [Using the Tilt, Swivel, and Vertical Extension](#)
 - [Rotating the Monitor](#)
 - [Adjusting the Rotation Display Settings of Your System](#)
-



Using the Front Panel

Use the control buttons on the front of the monitor to adjust the characteristics of the image being displayed. As you use these buttons to adjust the controls, an OSD shows the numeric values of the characteristics as they change.



The following table describes the front panel buttons:

Front Panel Button	Description
--------------------	-------------

1	 <p>Shortcut key/ Preset Modes</p>	Use this button to choose from a list of preset color modes.
2	 <p>Shortcut key / Brightness/Contrast</p>	Use this button to directly access the "Brightness/Contrast" menu.
3	 <p>Menu</p>	Use the MENU button to launch the On-Screen Display (OSD) and select the OSD Menu. See Accessing the Menu System .
4	 <p>Exit</p>	Use this button to go back to the main menu or exit the OSD main menu.
5	 <p>Power (with power light indicator)</p>	<p>Use the Power button to turn the monitor On and Off.</p> <p>The blue LED indicates the monitor is On and fully functional. An amber LED indicates the power save mode.</p>

Using the On-Screen Display (OSD) Menu

Accessing the Menu System

 **NOTE:** If you change the settings and then either proceed to another menu or exit the OSD menu, the monitor automatically saves those changes. The changes are also saved if you change the settings and then wait for the OSD menu to disappear.

1. Press the  button to launch the OSD menu and display the main menu.

Main Menu for analog (VGA) input

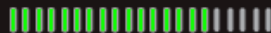
Dell P2212H/ P2312H Energy Use 

Brightness/Contrast

- Auto Adjust
- Input Source
- Color Settings
- Display Settings
- Other Settings
- Personalize

Brightness 75

Contrast 75

Resolution: 1920 x 1080 @ 60Hz Maximum Resolution: 1920 x 1080 @ 60Hz







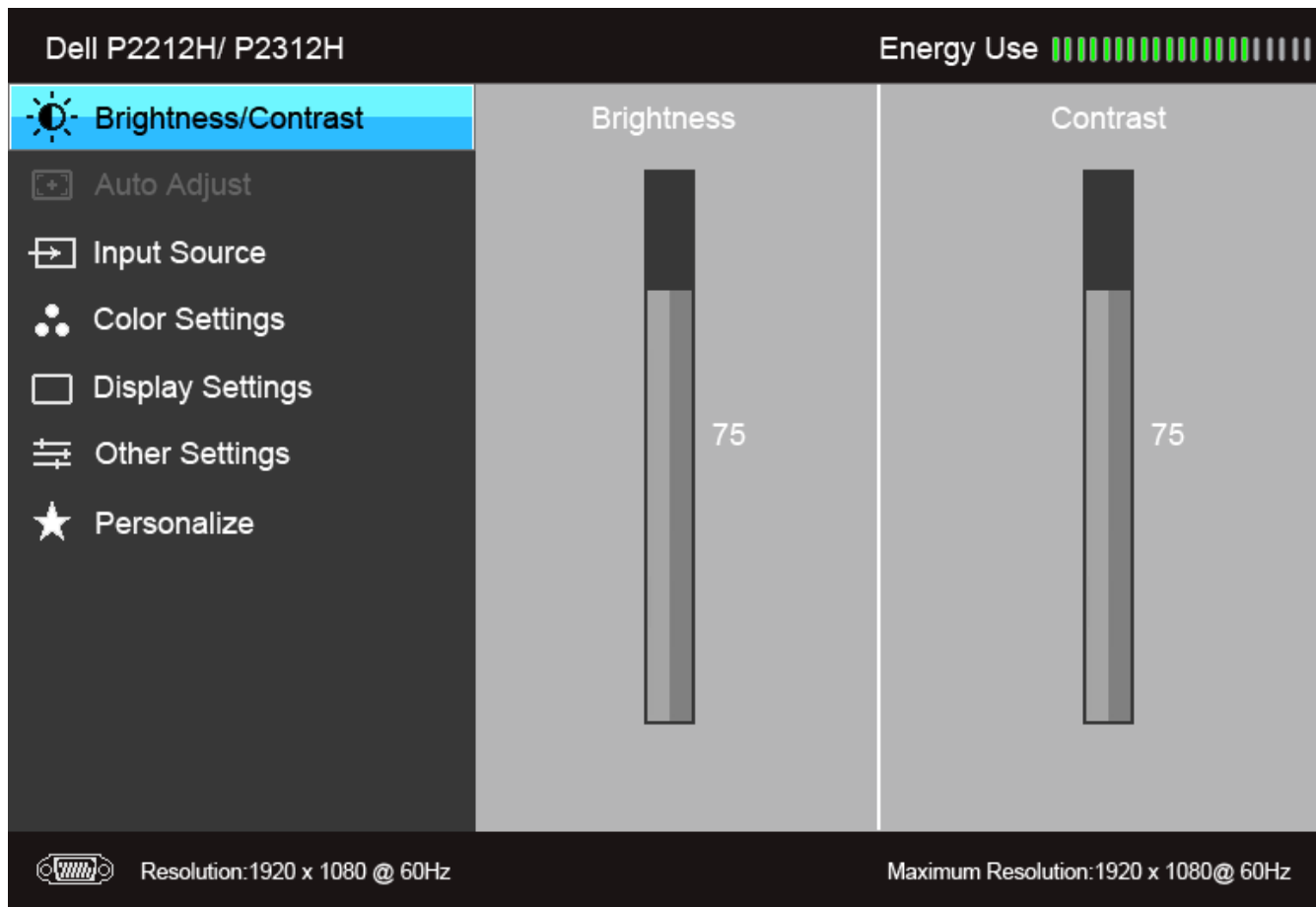





or

Main Menu for digital (DVI) input





NOTE: Auto Adjust is only available when you use the analog (VGA) connector.

2. Press the  and  buttons to move between the setting options. As you move from one icon to another, the option name is highlighted. See the following table for a complete list of all the options available for the monitor.
3. Press the  button once to activate the highlighted option.
4. Press  and  button to select the desired parameter.
5. Press  to enter the slide bar and then use the  and  buttons, according to the indicators on the menu, to make your changes.
6. Select the  button to return to the main menu.

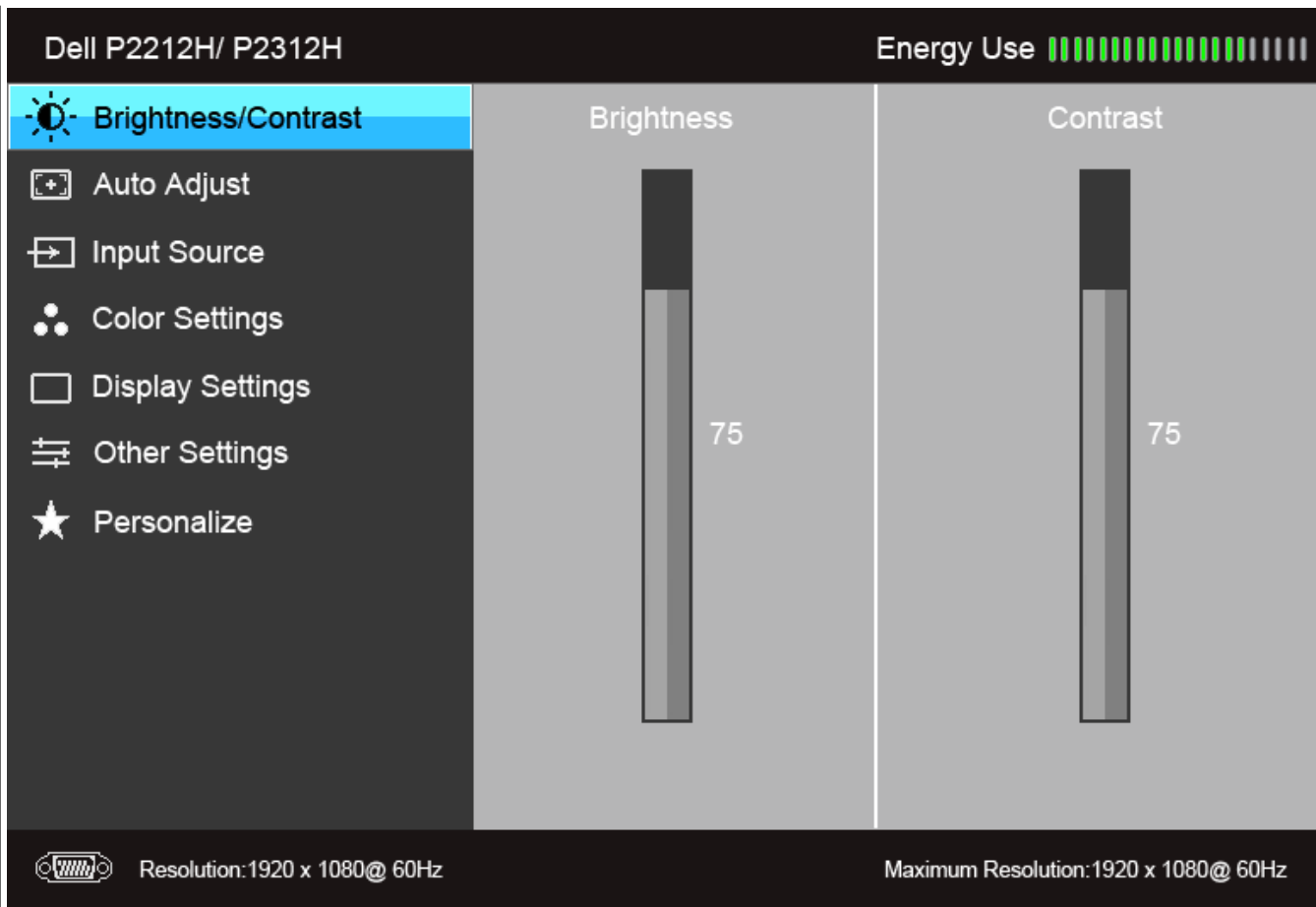

Icon	Menu and Submenus	Description
	Brightness/Contrast	Use this menu to activate Brightness/Contrast adjustment.



Brightness

Brightness adjusts the luminance of the backlight.
 Press the  button to increase the brightness and press the  button to decrease the brightness (min 0 / max 100).
NOTE: Manual adjustment of Brightness is disabled when Energy Smart or Dynamic Contrast is switched On.

Contrast

Adjust the Brightness first, and then adjust the Contrast only if further adjustment is necessary.
 Press the  button to increase the contrast and press the  button to decrease the contrast (min 0 / max 100).
 The Contrast function adjusts the degree of difference between darkness and lightness on the monitor screen.



Auto Adjust

Even though your computer recognizes your monitor on startup, the **Auto Adjustment** function optimizes the display settings for use with your particular setup.

Auto Adjustment allows the monitor to self-adjust to the incoming video signal. After using Auto Adjustment, you can further tune your monitor by using the Pixel Clock (Coarse) and Phase (Fine) controls under Display Settings.

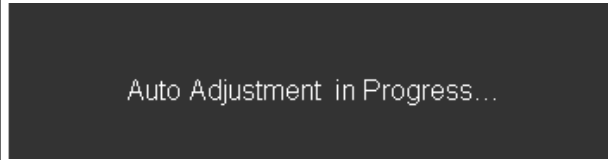

NOTE: In most cases, Auto Adjust produces the best image for your configuration.

NOTE: **Auto Adjust** option is only available when you are using the analog (VGA) connector.



Input Source

Use the **Input Source** menu to select between the different video signals that may be connected to your monitor.

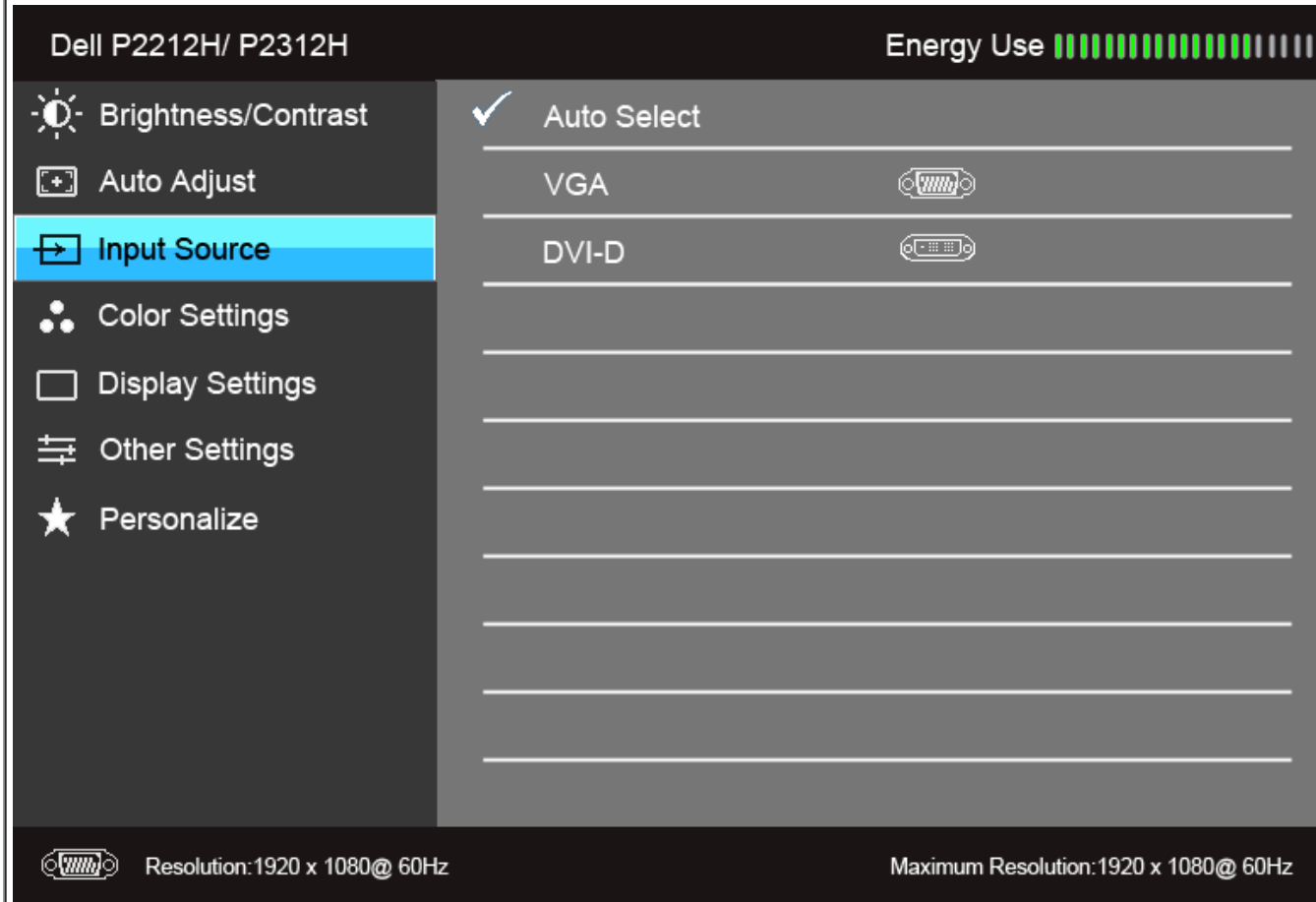

Auto Select

Press **→** to select **Auto Select**, the monitor auto detects either the VGA input or the DVI-D input.

VGA

Select the **VGA** input when you are using the analog (VGA) connector. Press **→** to select the VGA input source.

DVI-D

Select the **DVI-D** input when you are using the Digital (DVI) connector. Press **→** to select the DVI input source.





Color Settings

Use **Color Settings** to adjust the color setting mode and color temperature.
There are different color setting sub-menus for the VGA/DVI-D and Video input.

Dell P2212H/ P2312H Energy Use

- Brightness/Contrast
- Auto Adjust
- Input Source
- Color Settings**
- Display Settings
- Other Settings
- Personalize

Input Color Format ▶ RGB

Preset Modes ▶ Standard

Reset Color Settings

Resolution: 1920 x 1080 @ 60Hz Maximum Resolution: 1920 x 1080 @ 60Hz

Input Color Format

Allows you to set the video input mode to:

RGB: Select this option if your monitor is connected to a computer or DVD player using the VGA and DVI cable.

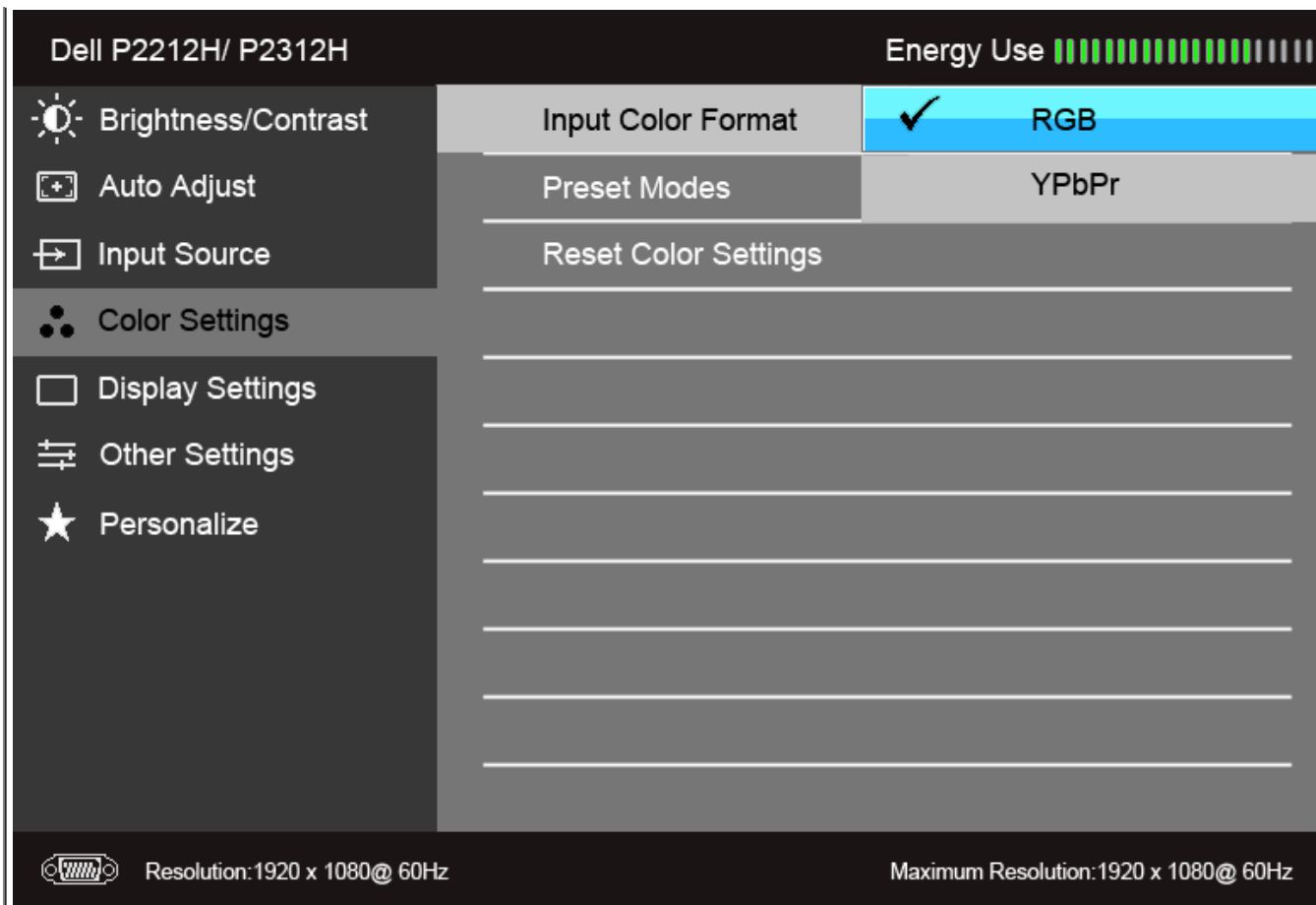

YPbPr: Select this option if your monitor is connected to a DVD player by YPbPr, or to VGA, or YPbPr to DVI cable; or if the DVD color output setting is not RGB.



Preset Modes



When you select **Preset Modes**, you can choose **Standard**, **Multimedia**, **Movie**, **Game**, **Text**, **Warm**, **Cool** or **Custom Color** from the list.

- **Standard**: Loads the monitor's default color settings. This is the default preset mode.
- **Multimedia**: Loads color settings ideal for multimedia applications.
- **Movie**: Loads color settings ideal for movies.
- **Game**: Loads color settings ideal for most gaming applications.
- **Text**: Loads brightness and sharpness settings ideal for viewing texts.
- **Warm**: Increase the color temperature. The screen appears warmer with a red/yellow tint.
- **Cool**: Decreases the color temperature. The screen appears cooler with a blue tint.

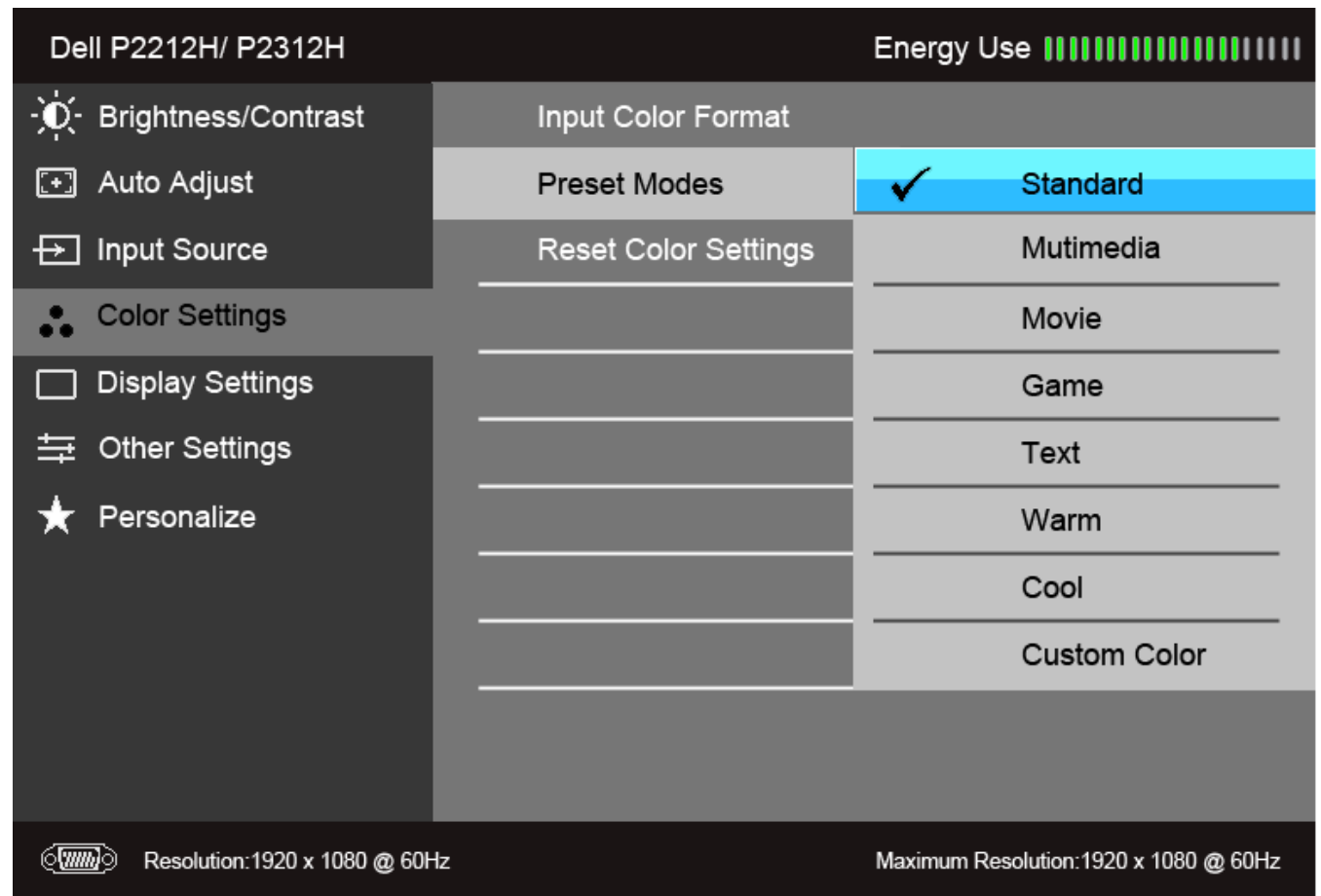
- **Custom Color**: Allows you to manually adjust the color settings. Press the  and  buttons to adjust the three colors (R, G, B) values and create your own preset color mode.



Hue



This feature can shift the color of the video image to green or purple. This is used to adjust the desired flesh tone color. Use  or  to adjust the hue from '0' to '100'.

Press  to increase the green shade of the video image.

Press  to increase the purple shade of the video image.

NOTE: Hue adjustment is available only when you select Movie or Game preset mode.

Saturation

This feature can adjust the color saturation of the video image. Use  or  to adjust the saturation from '0' to '100'.

Press  to increase the monochrome appearance of the video image.

Press  to increase the colorful appearance of the video image.

NOTE: Saturation adjustment is available only when you select Movie or Game preset mode.

Reset Color Settings

Reset your monitor color settings to the factory settings.



Display Settings

Use the Display Settings to adjust image.

Dell P2212H/ P2312H Energy Use

- Brightness/Contrast
- Auto Adjust
- Input Source
- Color Settings
- Display Settings**
- Other Settings
- Personalize

Aspect Ratio ▶ Wide 16:9

Horizontal Position ▶ 50

Vertical Position ▶ 50

Sharpness ▶ 50

Pixel Clock ▶ 50

Phase ▶ 50





Dynamic Contrast



Reset Display Settings

Resolution: 1920 x 1080 @ 60Hz Maximum Resolution: 1920 x 1080 @ 60Hz

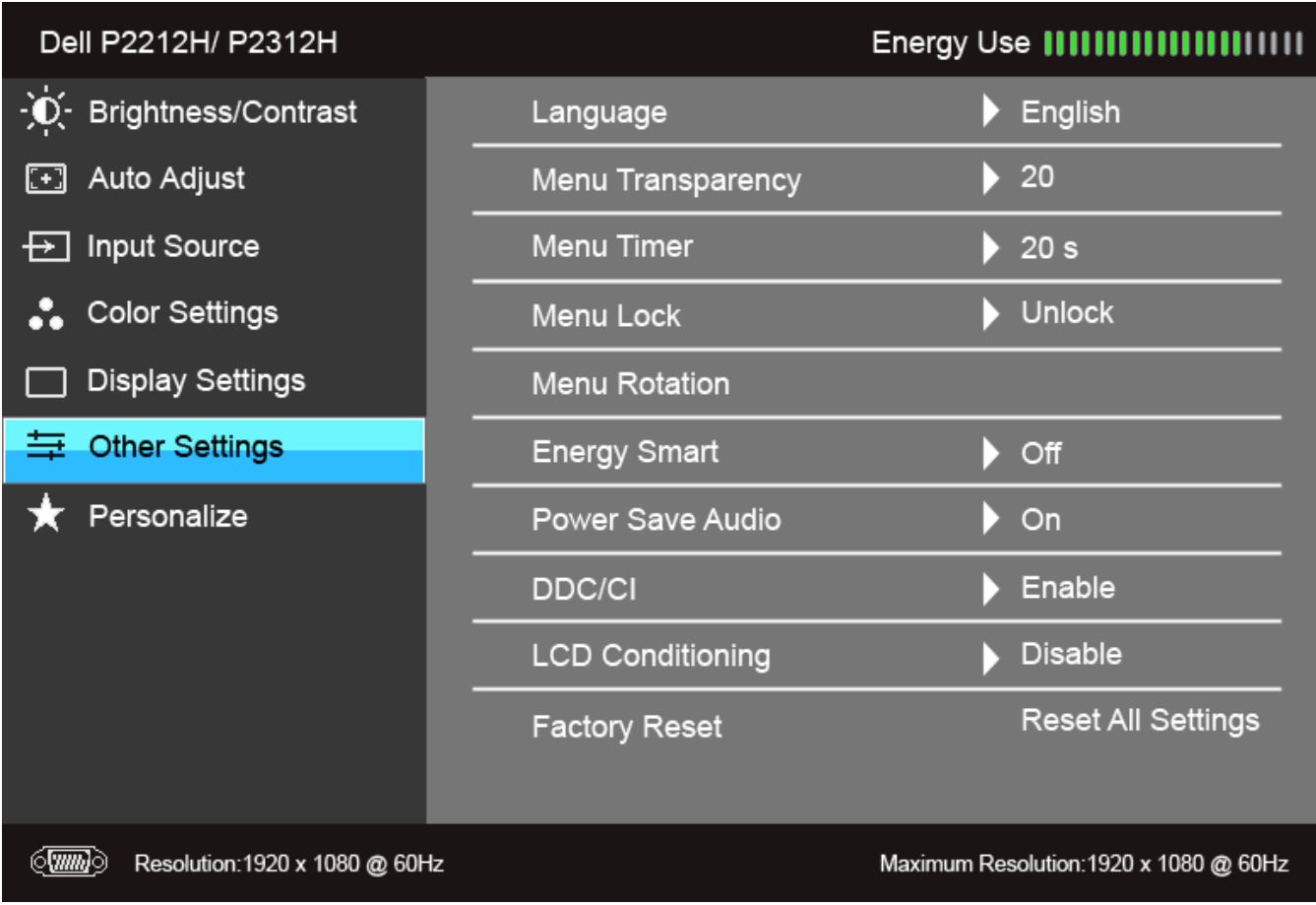

Aspect Ratio	Adjust the image ratio to Wide 16:9, 5:4 or 4:3.
Horizontal Position	Use or to adjust the image left or right. Minimum is '0' (-). Maximum is '100' (+).
Vertical Position	Use or to adjust the image up or down. Minimum is '0' (-). Maximum is '100' (+). NOTE: Horizontal Position and Vertical Position adjustments are only available for "VGA" input.
Sharpness	This feature can make the image look sharper or softer. Use or to adjust the sharpness from '0' to '100'.
Pixel Clock	The Phase and Pixel Clock adjustments allow you to adjust your monitor to your preference. Use or to adjust for best image quality.

Phase	<p>If satisfactory results are not obtained using the Phase adjustment, use the Pixel Clock (coarse) adjustment and then use Phase (fine), again.</p> <p>NOTE: Pixel Clock and Phase adjustments are only available for "VGA" input.</p>
Dynamic Contrast	<p>Dynamic Contrast adjusts the contrast ratio to 2M to 1. Press the  button to select the Dynamic Contrast "On" or "Off" .</p> <p>Note: Dynamic Contrast provides higher contrast if you select Game or Movie preset mode.</p>
Reset Display Settings	<p>Select this option to restore default display settings.</p>
	<p>Other Settings</p> <p>Select this option to adjust the settings of the OSD, such as, the languages of the OSD, the amount of time the menu remains on screen, and so on.</p> 
Language	<p>Language options set the OSD display to one of the eight languages (English, Espanol, Francais, Deutsch, Brazilian Portuguese, Russian, Simplified Chinese or Japanese).</p>
Menu Transparency	<p>Select this option to change the menu transparency by pressing the  and  buttons (Minimum: 0 ~ Maximum: 100).</p>
Menu Timer	<p>OSD Hold Time: sets the length of time the OSD will remain active after the last time you pressed a button.</p>

Use  or  to adjust the slider in 1 second increments, from 5 to 60 seconds.

Menu Lock	Controls user access to adjustments. When Lock is selected, no user adjustments are allowed. All buttons are locked. NOTE: Lock function – Either soft lock (through the OSD menu) or hard lock (press and hold the button above the power button for 10 seconds) Unlock function– Only hard unlock (press and hold the button above the power button for 10 seconds)
Menu Rotation	Rotates the OSD by 90 degrees counter-clockwise. You can adjust the menu according to your Display Rotation .
Energy Smart	To turn on or off dynamic dimming. The dynamic dimming feature automatically reduces the screen's brightness level when the displayed image contains a high proportion of bright areas.
Power Save Audio	To turn on or off Audio Power during Power Save mode.

DDC/CI

DDC/CI (Display Data Channel/Command Interface) allows your monitor parameters (brightness, color balance, and etc.) to be adjustable via the software on your computer. You can disable this feature by selecting "Disable".
Enable this feature for best user experience and optimum performance of your monitor.

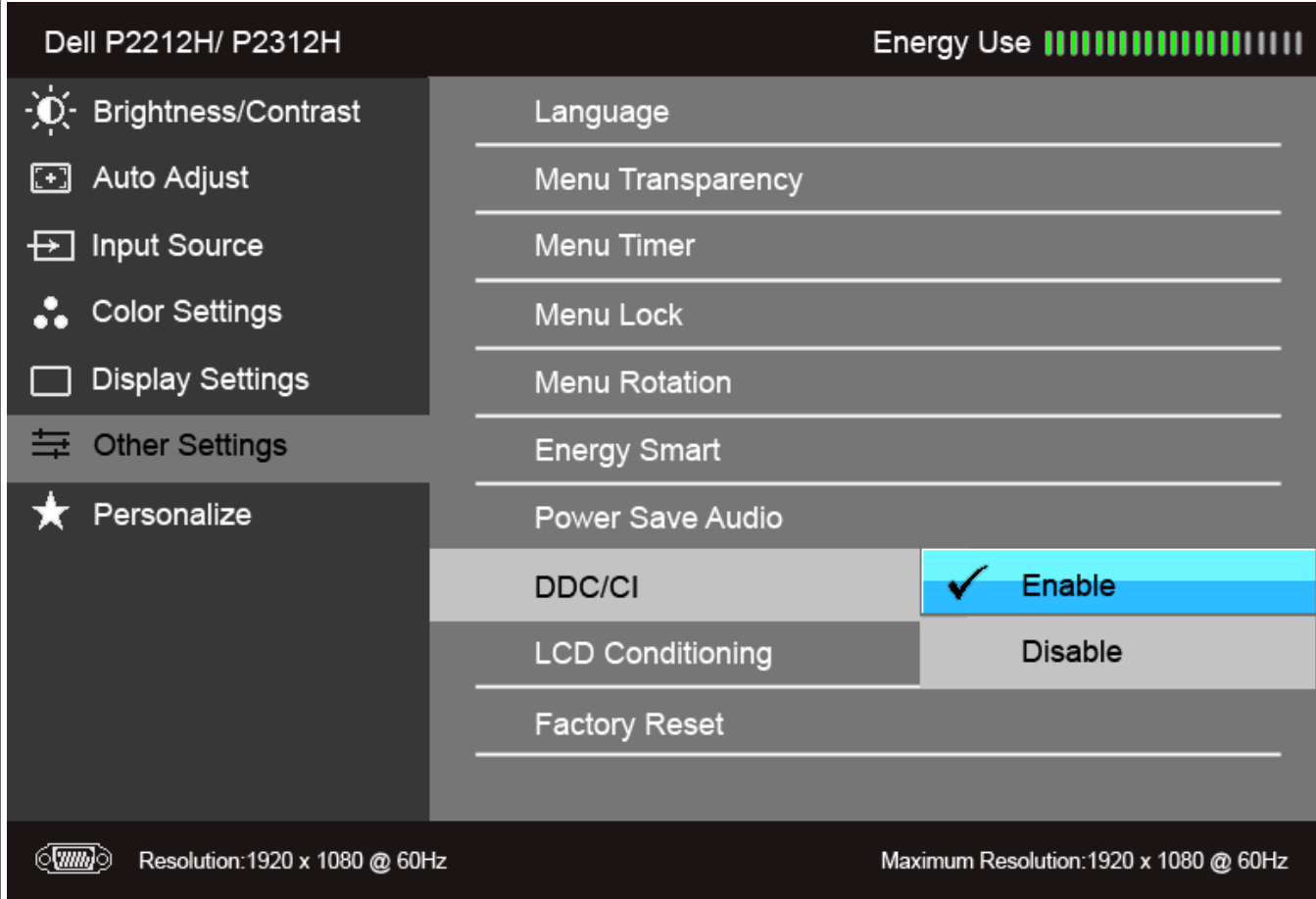

The screenshot shows the Dell OSD menu for a P2212H/P2312H monitor. The 'DDC/CI' option is highlighted in blue and set to 'Enable'. Other visible options include Brightness/Contrast, Auto Adjust, Input Source, Color Settings, Display Settings, Other Settings, Personalize, Language, Menu Transparency, Menu Timer, Menu Lock, Menu Rotation, Energy Smart, Power Save Audio, LCD Conditioning (set to Disable), and Factory Reset. The Energy Use indicator is shown at the top right, and the resolution is 1920 x 1080 @ 60Hz.

LCD Conditioning	Helps reduce minor cases of image retention. Depending on the degree of image retention, the program may take some time to run. You can enable this feature by selecting "Enable".
-------------------------	--

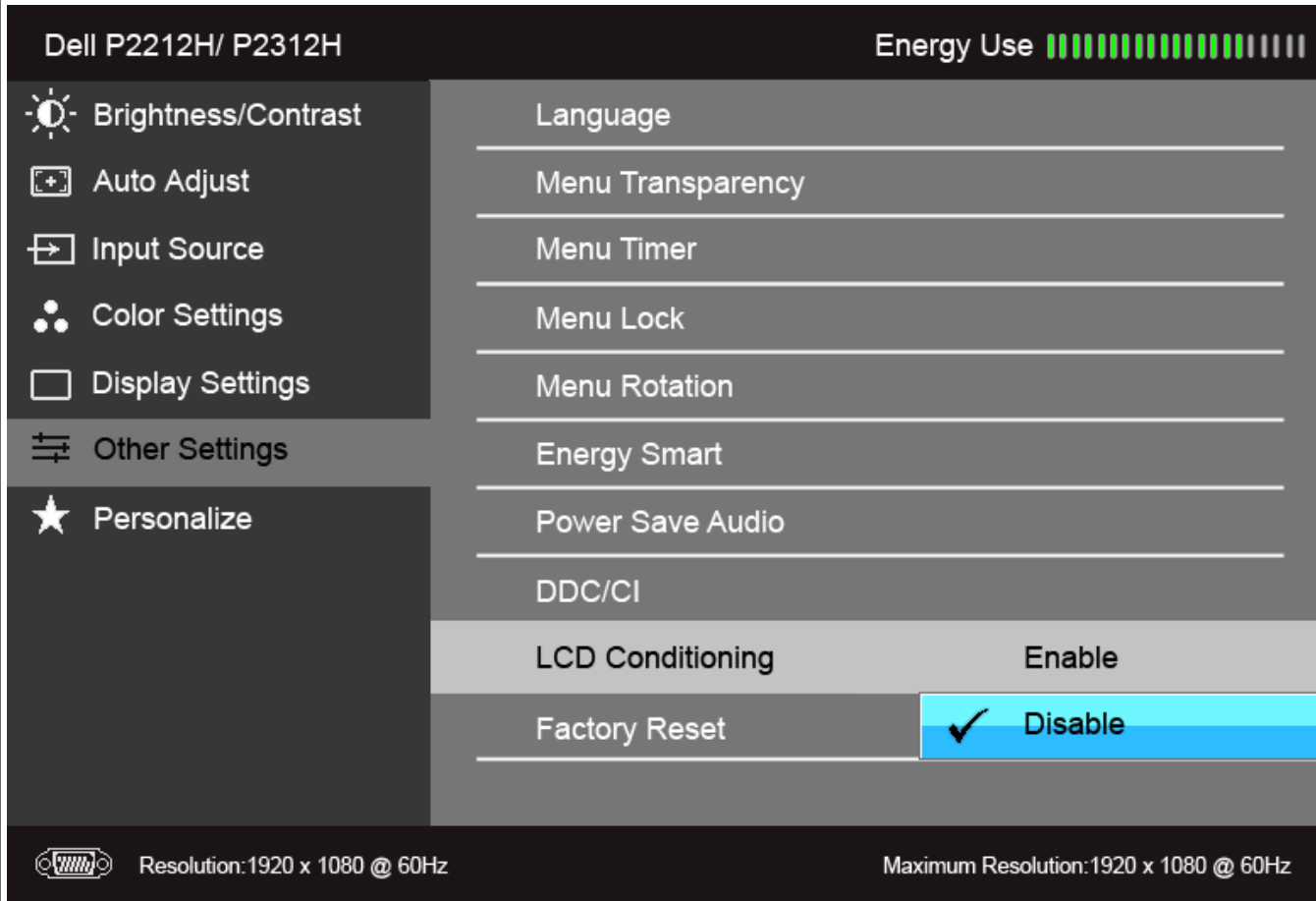

Factory Reset

Reset all OSD settings to the factory preset values.



Personalize

Users can choose a feature from "Preset Modes", "Brightness/Contrast", "Auto Adjust", "Input Source", "Aspect Ratio" or "Menu Rotation" and set it as a shortcut key.

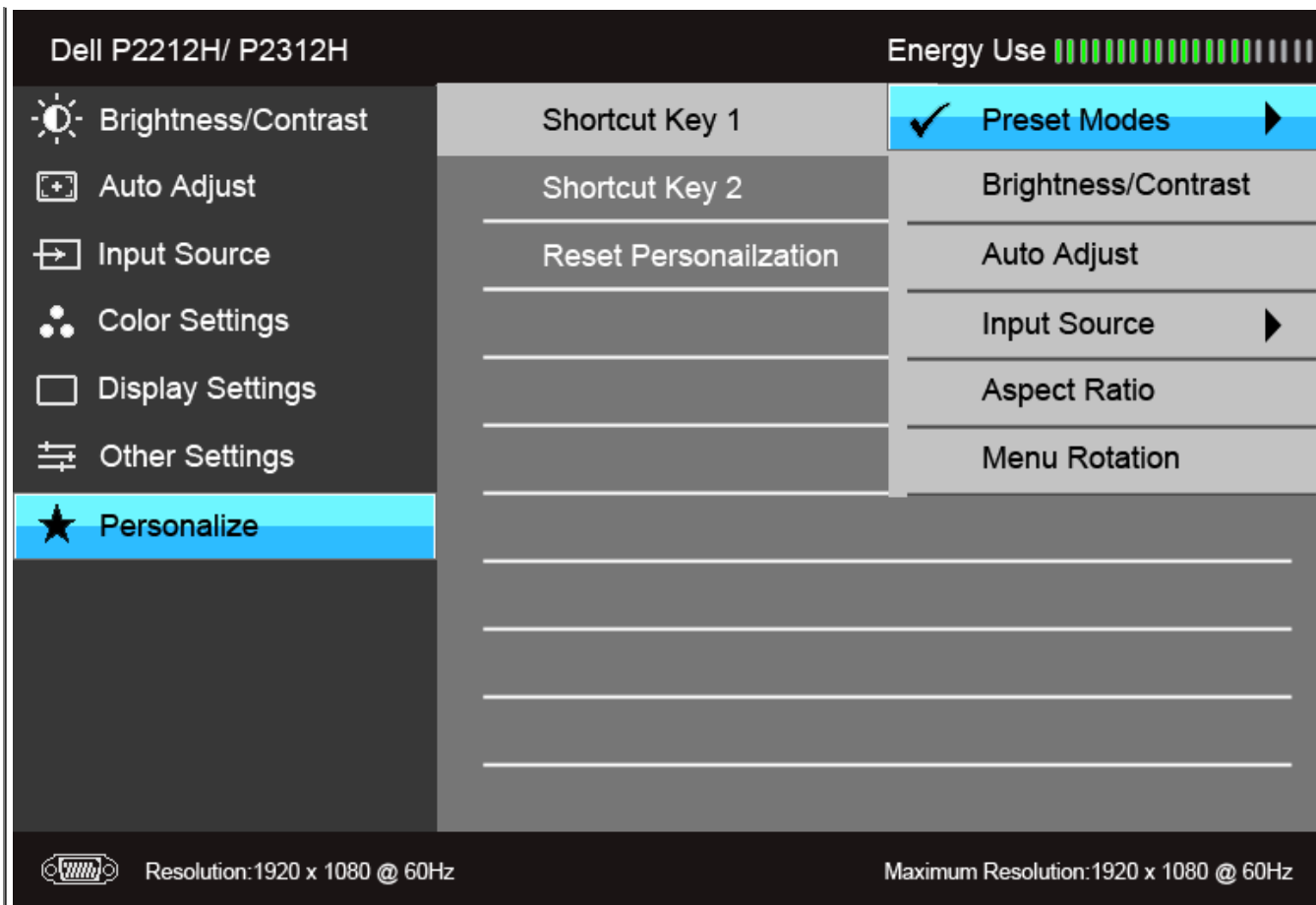

NOTE: This monitor has a built-in feature to automatically calibrate the brightness to compensate for LED aging.

OSD Warning Messages

When the Energy Smart or Dynamic Contrast feature is enabled (in these preset modes: Game or Movie), the manual brightness adjustment is disabled.

Dell P2212H/ P2312H

To allow manual adjustment of brightness, the Energy Smart /
Dynamic Contrast will be switched off.

Do you want to continue?

No

Yes

When the monitor does not support a particular resolution mode, you will see the following message:

Dell P2212H/ P2312H

The current input timing is not supported by the monitor display. Please
change your input timing to **1920x1080@60Hz** or any other monitor
listed timing as per the monitor specifications.



This means that the monitor cannot synchronize with the signal that it is receiving from the computer. See [Monitor Specifications](#) for the Horizontal and Vertical frequency ranges addressable by this monitor. Recommended mode is 1920 x 1080.

You will see the following message before the DDC/CI function is disabled:

Dell P2212H/ P2312H

The function of adjusting display setting using PC application will be disabled.

Do you wish to disable DDC/CI function?

No

Yes

When the monitor enters the Power Save mode, the following message appears:

Dell P2212H/ P2312H

Entering Power Save Mode.



Activate the computer and wake up the monitor to gain access to the [OSD](#).

If you press any button other than the power button, one of the following messages will appear depending on the selected input:

VGA/DVI -D input

Dell P2212H/ P2312H

There is no signal coming from your computer. Press any key on the keyboard or move the mouse to wake it up. If there is no display, press the monitor button now to select the correct input source on the On-Screen-Display menu.



If either VGA or DVI-D input is selected and both VGA and DVI-D cables are not connected, a floating dialog box as shown below appears.

Dell P2212H/ P2312H



No VGA Cable

The display will go into Power Save Mode in 5 minutes



or

Dell P2212H/ P2312H



No DVI-D Cable

The display will go into Power Save Mode in 5 minutes



See [Solving Problems](#) for more information.

PowerNap Software

The PowerNap software comes in the CD that shipped with the monitor you have just purchased.

This software provides Power Saving mode for your monitor. The Power Saving mode lets users set the monitor to "Screen Dim" or "Sleep" when your PC enters the screen saver mode.

1. Screen Dim - the monitor dims to a minimum brightness level when the PC is in the screen saver mode.
2. Sleep - the monitor enters the sleep mode when the PC is in the screen saver mode.

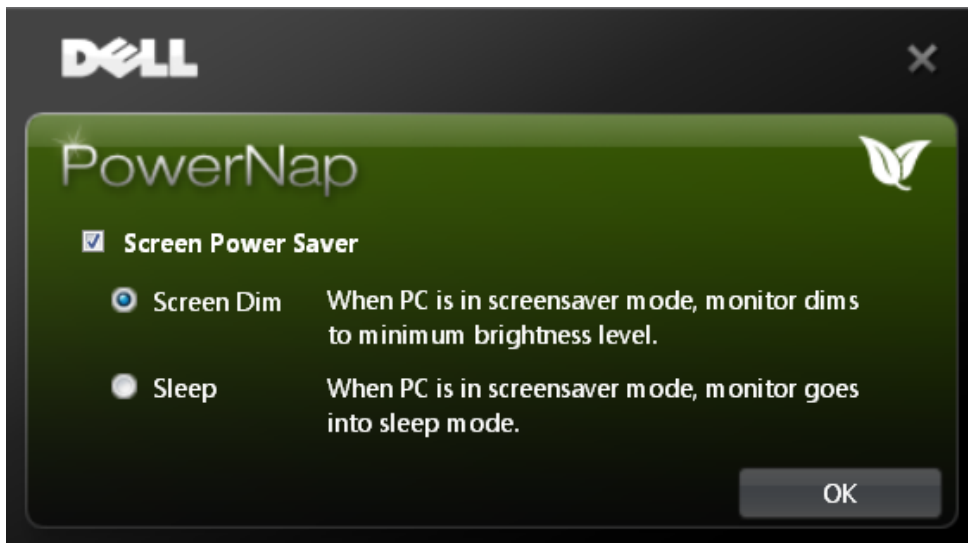

The PowerNap software provides an option to check if there is a new update. Please check periodically if there is a new update for your software.

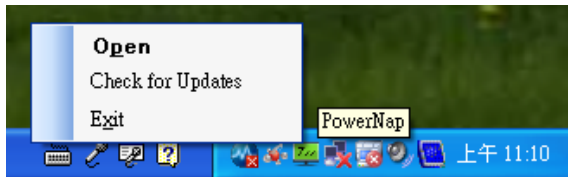

NOTES: After installation, one desktop shortcut and one shortcut under "Start" for PowerNap are created.
OS support: Windows XP (32-bits and 64-bits), Vista (32-bits and 64-bits), Windows 7 (32-bits and 64-bits).
Video interface support: VGA and DVI only.

The latest version of the PowerNap Software can be downloaded from Dell's website.

Steps to download the software:

1. Go to <http://www.support.dell.com>.
2. Select "Monitor Drivers" under the "Drivers and downloads" tab.
3. Select your Monitor Model - PowerNap Application.
4. Download and install the application.

Enhanced Menu Rotation Software

Enhanced Menu Rotation is embedded within the PowerNap software, allowing you to pivot the monitor screen from the OSD menu. The selection of either "Landscape" or "Portrait" will trigger the monitor screen accordingly.

The following picture shows a screenshot of Enhanced Menu Rotation (Triggering the Enhanced Menu Rotation function through the OSD menu):

Dell P2212H/ P2312H Energy Use 

Brightness/Contrast	Language	English
Auto Adjust	Menu Transparency	20
Input Source	Menu Timer	20 s
Color Settings	Menu Lock	Unlock
Display Settings	Menu Rotation	
Other Settings	Energy Smart	Off
★ Personalize	Power Save Audio	
	DDC/CI	Enable
	LCD Conditioning	Disable
	Factory Reset	Reset All Settings

Resolution: 1920 x 1080 @ 60Hz Maximum Resolution: 1920 x 1080 @ 60Hz

NOTES:
 OS support: Windows XP (32-bits and 64-bits), Vista (32-bits and 64-bits), Windows 7 (32-bits and 64-bits).
 Video interface support: VGA and DVI only.
 If you do not see the screen rotation, you may need to update your graphics driver or install PowerNap application.

- If you have a Dell desktop or portable computer:
 - Go to support.dell.com, enter your service tag, and download the latest driver for your graphics card.
- If you are using a non-Dell computer (portable or desktop):
 - Go to the support site for your computer and download the latest graphic drivers.
 - Go to your graphics card website and download the latest graphic drivers.
- For instructions about how to download the PowerNap software, see [PowerNap Software](#).

Setting the Maximum Resolution

To set the maximum resolution for the monitor:

Windows XP:

1. Right-click on the desktop and select **Properties**.
2. Select the **Settings** tab.
3. Set the screen resolution to **1920 x 1080**.
4. Click **OK**.

Windows Vista® or Windows® 7:

1. Right-click on the desktop and select **Personalization**.
2. Click **Change Display Settings**.
3. Move the slider-bar to the right by pressing and holding the left mouse button and adjust the screen resolution to **1920 x 1080**.
4. Click **OK**.

If you do not see 1920 x 1080 as an option, you may need to update your graphics driver. Depending on your computer, complete one of the following procedures:

If you have a Dell desktop or portable computer:

- Go to **support.dell.com**, enter your service tag, and download the latest driver for your graphics card.

If you are using a non-Dell computer (portable or desktop):

- Go to the support site for your computer and download the latest graphic drivers.
- Go to your graphics card website and download the latest graphic drivers.

Using the Dell Soundbar (Optional)

The Dell Soundbar is a stereo two channel system adaptable to mount on Dell Flat Panel Displays. The Soundbar has a rotary volume and On/Off control to adjust the overall system level, a blue LED for power indication, and two audio headset jacks.

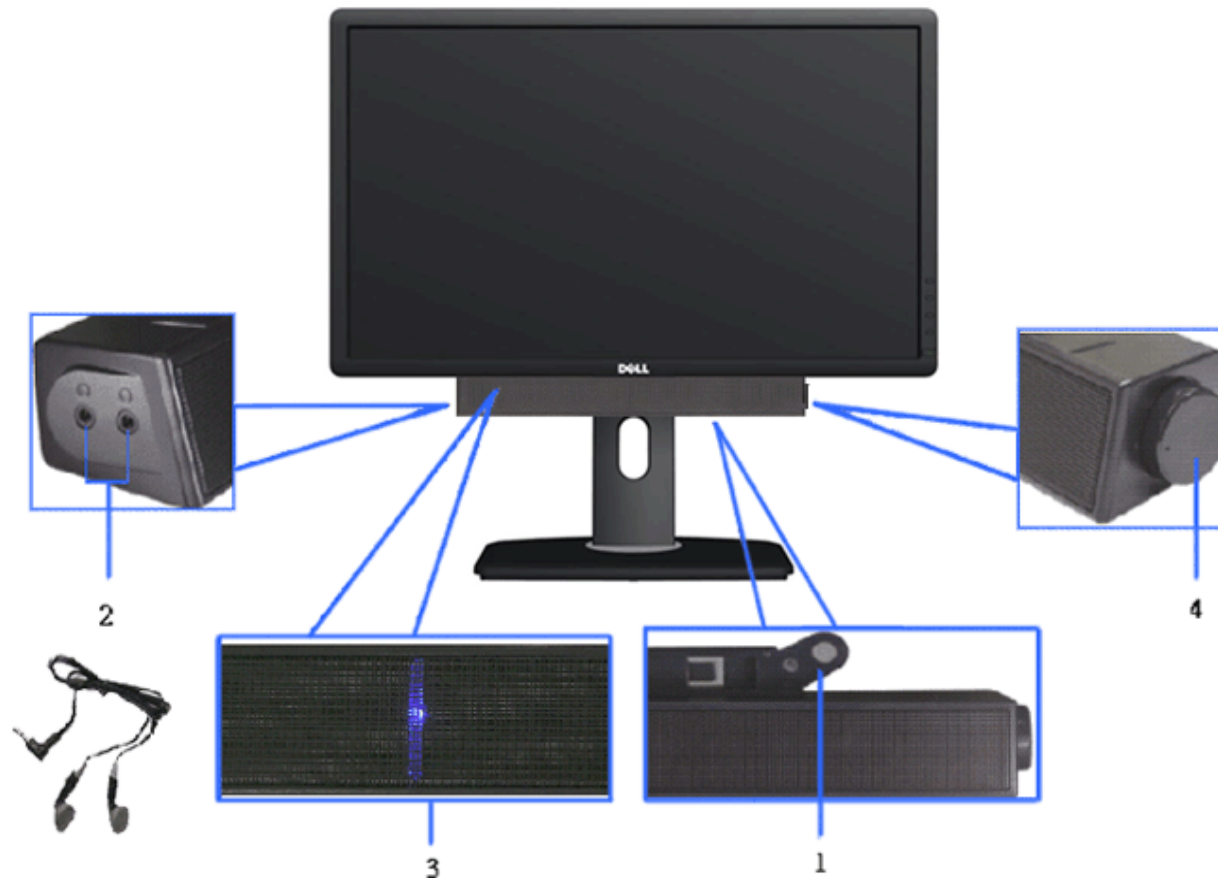

1. Attach mechanism
 2. Headphone jacks
 3. Power indicator
 4. Power/Volume control
-

Using the Tilt, Swivel, and Vertical Extension

 **NOTE:** This is applicable for a monitor with a stand. When any other stand is bought, please refer to the respective stand setup guide for set up instructions.

Tilt, Swivel

With the stand attached to the monitor, you can tilt and swivel the monitor for the most comfortable viewing angle.

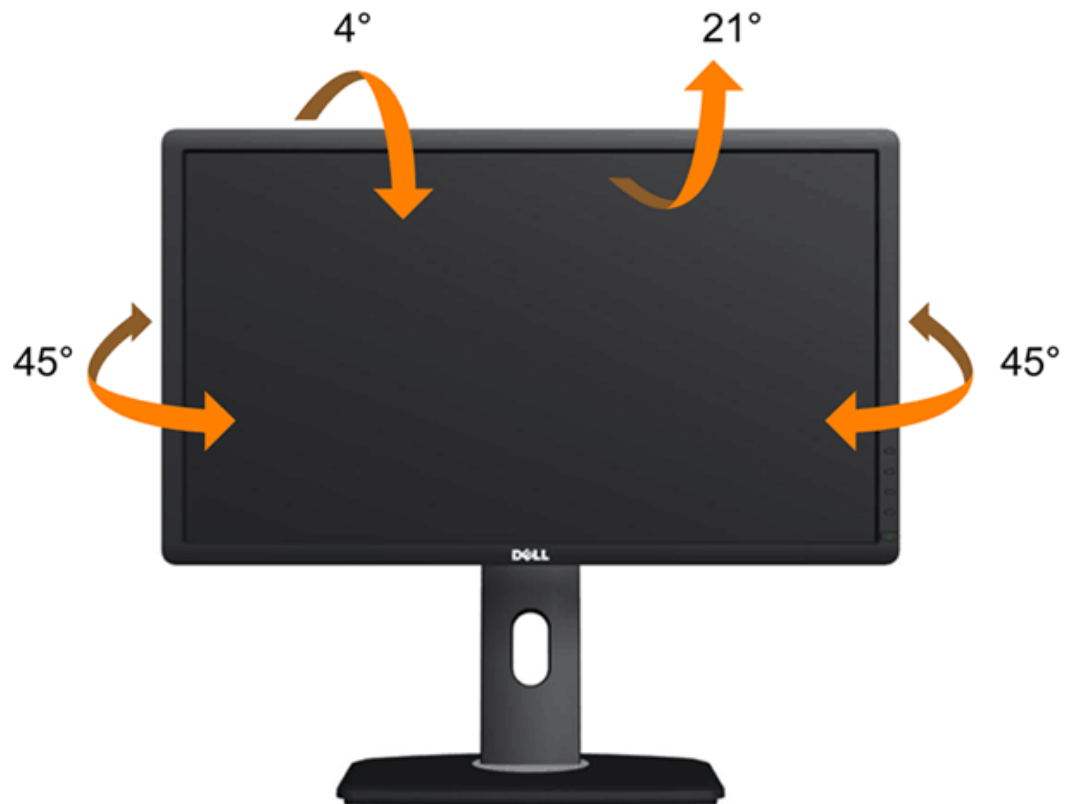

 **NOTE:** The stand is detached when the monitor is shipped from the factory.

Vertical Extension

 **NOTE:** The stand extends vertically up to 130 mm. The figure below illustrates how to extend the stand vertically.



Rotating the Monitor

Before you rotate the monitor, your monitor should be fully vertically extended ([Vertical Extension](#)) and fully tilted ([Tilt](#)) up to avoid hitting the bottom edge of the monitor.

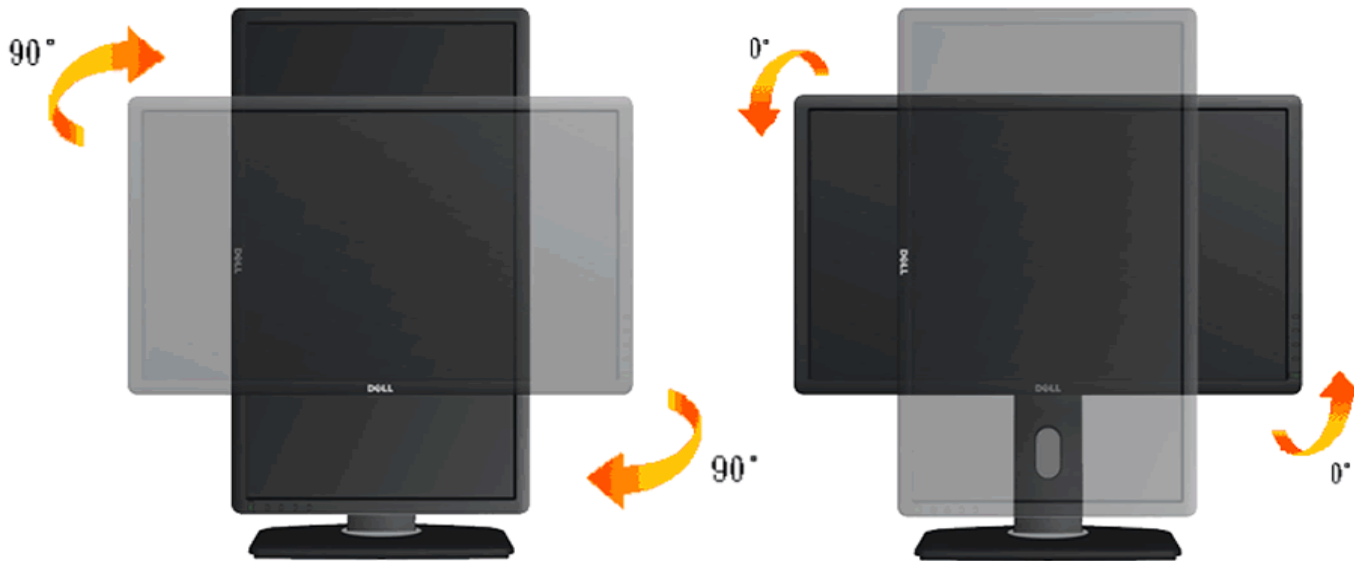
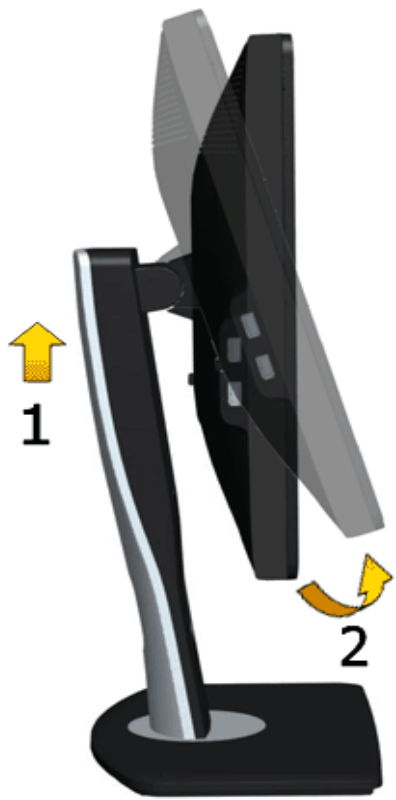

 **NOTE:** To use the Display Rotation function (Landscape versus Portrait view) with your Dell computer, you require an updated graphics driver that is not included with this monitor. To download the graphics driver, go to support.dell.com and see the **Download** section for **Video Drivers** for latest driver updates.

 **NOTE:** When in the *Portrait View Mode*, you may experience performance degradation in graphic-intensive applications (3D Gaming and etc.).

Adjusting the Rotation Display Settings of Your System

After you have rotated your monitor, you need to complete the procedure below to adjust the Rotation Display Settings of your System.

 **NOTE:** If you are using the monitor with a non-Dell computer, you need to go the graphics driver website or your computer manufacturer website for information on rotating the 'contents' on your display.

To adjust the Rotation Display Settings:

1. Right-click on the desktop and click **Properties**.
2. Select the **Settings** tab and click **Advanced**.
3. If you have an ATI graphics card, select the **Rotation** tab and set the preferred rotation.
If you have an nVidia graphics card, click the **nVidia** tab, in the left-hand column select **NVRotate**, and then select the preferred rotation.
If you have an Intel® graphics card, select the **Intel** graphics tab, click **Graphic Properties**, select the **Rotation** tab, and then set the preferred rotation.

 **NOTE:** If you do not see the rotation option or it is not working correctly, go to support.dell.com and download the latest driver for your graphics card.

[Back to Contents Page](#)

Troubleshooting

Dell™ P2212H/P2312H Monitor User's Guide

- [Self-Test](#)
- [Built-in Diagnostics](#)
- [Common Problems](#)
- [Product Specific Problems](#)
- [Universal Serial Bus \(USB\) Specific Problems](#)
- [Dell™ Soundbar Problems](#)

 **WARNING:** Before you begin any of the procedures in this section, follow the [Safety Instructions](#).

Self-Test

Your monitor provides a self-test feature that allows you to check whether your monitor is functioning properly. If your monitor and computer are properly connected but the monitor screen remains dark, run the monitor self-test by performing the following steps:

1. Turn off both your computer and the monitor.
2. Unplug the video cable from the back of the computer. To ensure proper Self-Test operation, remove all Digital (white connector) and the Analog (blue connector) cables from the back of computer.
3. Turn on the monitor.

The floating dialog box should appear on-screen (against a black background), if the monitor cannot sense a video signal and is working correctly. While in self-test mode, the power LED remains green. Also, depending upon the selected input, one of the dialogs shown below will continuously scroll through the screen.

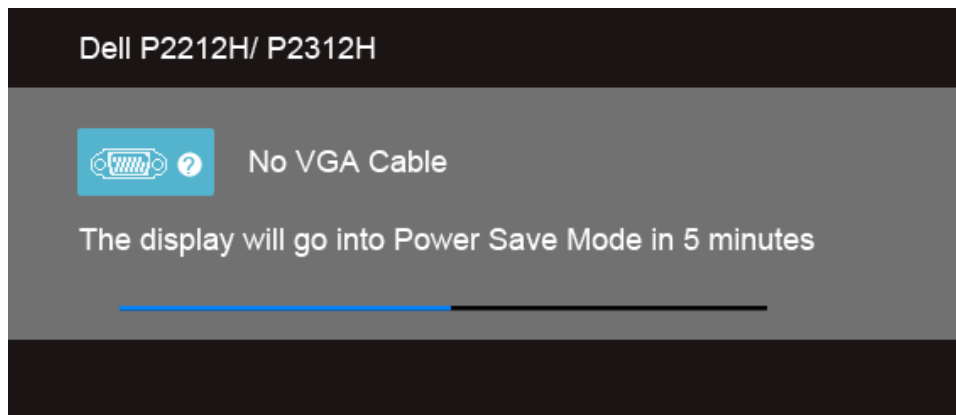

or

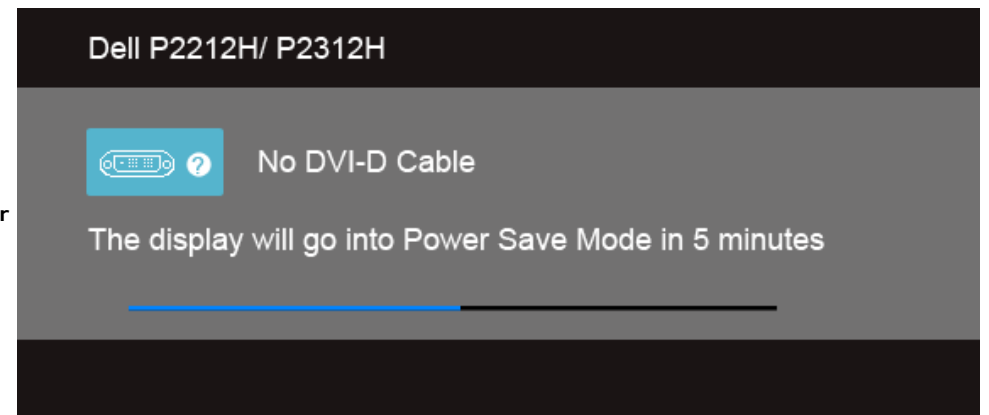

4. This box also appears during normal system operation, if the video cable becomes disconnected or damaged.
5. Turn off your monitor and reconnect the video cable; then turn on both your computer and the monitor.

If your monitor screen remains blank after you use the previous procedure, check your video controller and computer, because your monitor is functioning properly.

Built-in Diagnostics

Your monitor has a built-in diagnostic tool that helps you determine if the screen abnormality you are experiencing is an inherent problem with your monitor, or with your computer and video card.

NOTE: You can run the built-in diagnostics only when the video cable is unplugged and the monitor is in *self-test mode*.



To run the built-in diagnostics:

1. Ensure that the screen is clean (no dust particles on the surface of the screen).
2. Unplug the video cable(s) from the back of the computer or monitor. The monitor then goes into the self-test mode.
3. Press and hold **Button 1** and **Button 4** on the front panel simultaneously for 2 seconds. A gray screen appears.
4. Carefully inspect the screen for abnormalities.
5. Press **Button 4** on the front panel again. The color of the screen changes to red.
6. Inspect the display for any abnormalities.
7. Repeat steps 5 and 6 to inspect the display in green, blue, black and white screens.

The test is complete when the white screen appears. To exit, press **Button 4** again.

If you do not detect any screen abnormalities upon using the built-in diagnostic tool, the monitor is functioning properly. Check the video card and computer.

Common Problems

The following table contains general information about common monitor problems you might encounter and the possible solutions:

Common Symptoms	What You Experience	Possible Solutions
No Video/Power LED off	No picture	<ul style="list-style-type: none">• Ensure that the video cable connecting the monitor and the computer is properly connected and secure.• Verify that the power outlet is functioning properly using any other electrical equipment.• Ensure that the power button is depressed fully.• Ensure that the correct input source is selected via the Input Source Select button.
No Video/Power LED on	No picture or no brightness	<ul style="list-style-type: none">• Increase brightness & contrast controls via OSD.• Perform monitor self-test feature check.• Check for bent or broken pins in the video cable connector.• Run the built-in diagnostics.• Ensure that the correct input source is selected via the Input Source Select button.
Poor Focus	Picture is fuzzy, blurry, or ghosting	<ul style="list-style-type: none">• Perform Auto Adjust via OSD.

		<ul style="list-style-type: none"> Adjust the Phase and Pixel Clock controls via OSD. Eliminate video extension cables. Reset the monitor to Factory Settings. Change the video resolution to the correct aspect ratio (16:9).
Shaky/Jittery Video	Wavy picture or fine movement	<ul style="list-style-type: none"> Perform Auto Adjust via OSD. Adjust the Phase and Pixel Clock controls via OSD. Reset the monitor to Factory Settings. Check environmental factors. Relocate the monitor and test in another room.
Missing Pixels	LCD screen has spots	<ul style="list-style-type: none"> Cycle power on-off. Pixel that is permanently off is a natural defect that can occur in LCD technology. For more information on Dell Monitor Quality and Pixel Policy, see Dell Support site at: support.dell.com.
Stuck-on Pixels	LCD screen has bright spots	<ul style="list-style-type: none"> Cycle power on-off. Pixel that is permanently off is a natural defect that can occur in LCD technology. For more information on Dell Monitor Quality and Pixel Policy, see Dell Support site at: support.dell.com.
Brightness Problems	Picture too dim or too bright	<ul style="list-style-type: none"> Reset the monitor to Factory Settings. Auto Adjust via OSD. Adjust brightness & contrast controls via OSD.
Geometric Distortion	Screen not centered correctly	<ul style="list-style-type: none"> Reset the monitor to Factory Settings. Auto Adjust via OSD. Adjust horizontal & vertical controls via OSD. <p>NOTE: When using DVI-D input, the positioning adjustments are not available.</p>
Horizontal/Vertical Lines	Screen has one or more lines	<ul style="list-style-type: none"> Reset the monitor to Factory Settings. Perform Auto Adjust via OSD. Adjust Phase and Pixel Clock controls via OSD. Perform monitor self-test feature check and determine if these lines are also in self-test mode. Check for bent or broken pins in the video cable connector. Run the built-in diagnostics. <p>NOTE: When using DVI-D input, the Pixel Clock and Phase adjustments are not available.</p>
Synchronization Problems	Screen is scrambled or appears torn	<ul style="list-style-type: none"> Reset the monitor to Factory Settings. Perform Auto Adjust via OSD. Adjust Phase and Pixel Clock controls via OSD. Perform monitor self-test feature check to determine if the scrambled screen appears in self-test mode. Check for bent or broken pins in the video cable connector. Restart the computer in the <i>safe mode</i>.
Safety Related Issues	Visible signs of smoke or sparks	<ul style="list-style-type: none"> Do not perform any troubleshooting steps. Contact Dell immediately.
Intermittent Problems	Monitor malfunctions on & off	<ul style="list-style-type: none"> Ensure that the video cable connecting the monitor to the computer is connected properly and is secure. Reset the monitor to Factory Settings. Perform monitor self-test feature check to determine if the intermittent problem occurs in self-test mode.
Missing Color	Picture missing color	<ul style="list-style-type: none"> Perform monitor self-test feature check. Ensure that the video cable connecting the monitor to the computer is connected properly and is secure. Check for bent or broken pins in the video cable connector.
Wrong Color	Picture color not good	<ul style="list-style-type: none"> Change the Color Setting Mode in the Color Settings OSD to Graphics or Video depending on the application. Try different Color Preset Settings in Color Settings OSD. Adjust R/G/B value in Color Settings OSD if the Color Management is turned off. Change the Input Color Format to PC RGB or YPbPr in the Advance Setting OSD. Run the built-in diagnostics.
Image retention from a static image left on the monitor for a long period of time	Faint shadow from the static image displayed appears on the screen	<ul style="list-style-type: none"> Use the Power Management feature to turn off the monitor at all times when not in use (for more information, see Power Management Modes). Alternatively, use a dynamically changing screensaver.

Product Specific Problems

Specific Symptoms	What You Experience	Possible Solutions
Screen image is too small	Image is centered on screen, but does not fill entire viewing area	<ul style="list-style-type: none"> • Check the Scaling Ratio setting in the Image Setting OSD. • Reset the monitor to Factory Settings.
Cannot adjust the monitor with the buttons on the front panel	OSD does not appear on the screen	<ul style="list-style-type: none"> • Turn off the monitor, unplug the power cord, plug it back, and then turn on the monitor. • Check whether the OSD menu is locked. If yes, press and hold the button above the Power button for 10 seconds to unlock (for more information, see Menu Lock).
No Input Signal when user controls are pressed	No picture, the LED light is blue.	<ul style="list-style-type: none"> • Check the signal source. Ensure the Computer is not in the power saving mode by moving the mouse or pressing any key on the keyboard. • Check whether the signal cable is plugged in properly. Re-plug the signal cable if necessary. • Reset the computer or video player.
The picture does not fill the entire screen.	The picture cannot fill the height or width of the screen	<ul style="list-style-type: none"> • Due to different video formats (aspect ratio) of DVDs, the monitor may display in full screen. • Run the built-in diagnostics.

 **NOTE:** When choosing DVI-D mode, the **Auto Adjust** function will not be available.

Universal Serial Bus (USB) Specific Problems

Specific Symptoms	What You Experience	Possible Solutions
USB interface is not working	USB peripherals are not working	<ul style="list-style-type: none"> • Check that your monitor is turned ON. • Reconnect the upstream cable to your computer. • Reconnect the USB peripherals (downstream connector). • Switch off and then turn on the monitor again. • Reboot the computer. • Some USB devices like external portable HDD require higher electric current; connect the device directly to the computer system.
High Speed USB 2.0 interface is slow.	High Speed USB 2.0 peripherals working slowly or not working at all	<ul style="list-style-type: none"> • Check that your computer is USB 2.0-capable. • Some computers have both USB 2.0 and USB 1.1 ports. Ensure that the correct USB port is used. • Reconnect the upstream cable to your computer. • Reconnect the USB peripherals (downstream connector). • Reboot the computer.

Dell™ Soundbar Problems

Common Symptoms	What You Experience	Possible Solutions
No Sound	No power to Soundbar - the power indicator is off	<ul style="list-style-type: none"> • Turn the Power/Volume knob on the Soundbar clockwise to the middle position; check if the power indicator (Blue LED) on the front of the Soundbar is illuminated. • Confirm that the power cable from the Soundbar is plugged into the adapter.
No Sound	Soundbar has power - power indicator is on	<ul style="list-style-type: none"> • Plug the audio line-in cable into the computer's audio out jack. • Set all Windows volume controls to their maximum. • Play some audio content on the computer (i.e. audio CD, or MP3). • Turn the Power/Volume knob on the Soundbar clockwise to a higher volume setting. • Clean and reseal the audio line-in plug. • Test the Soundbar using another audio source (i.e. portable CD player).
Distorted Sound	Computer's sound card is used as the	<ul style="list-style-type: none"> • Clear any obstructions between the Soundbar and the user.

	audio source	<ul style="list-style-type: none"> • Confirm that the audio line-in plug is completely inserted into the jack of the sound card. • Set all Windows volume controls to their midpoints. • Decrease the volume of the audio application. • Turn the Power/Volume knob on the Soundbar counter-clockwise to a lower volume setting. • Clean and reseal the audio line-in plug. • Troubleshoot the computer's sound card. • Test the Soundbar using another audio source (i.e. portable CD player).
Distorted Sound	Other audio source is used	<ul style="list-style-type: none"> • Clear any obstructions between the Soundbar and the user. • Confirm that the audio line-in plug is completely inserted into the jack of the audio source. • Decrease the volume of the audio source. • Turn the Power/Volume knob on the Soundbar counter-clockwise to a lower volume setting. • Clean and reseal the audio line-in plug.
Unbalanced Sound Output	Sound from only one side of Soundbar	<ul style="list-style-type: none"> • Clear any obstructions between the Soundbar and the user. • Confirm that the audio line-in plug is completely inserted into the jack of the sound card or audio source. • Set all Windows audio balance controls (L-R) to their midpoints. • Clean and reseal the audio line-in plug. • Troubleshoot the computer's sound card. • Test the Soundbar using another audio source (i.e. portable CD player).
Low Volume	Volume is too low	<ul style="list-style-type: none"> • Clear any obstructions between the Soundbar and the user. • Turn the Power/Volume knob on the Soundbar clockwise to the maximum volume setting. • Set all Windows volume controls to their maximum. • Increase the volume of the audio application. • Test the Soundbar using another audio source (i.e. portable CD player).

[Back to Contents Page](#)

Appendix

Dell™ P2212H/P2312H Monitor User's Guide

- [Safety Instructions](#)
 - [FCC Notice \(U.S. Only\) and Other Regulatory Information](#)
 - [Contacting Dell](#)
-

WARNING: Safety Instructions

 **WARNING:** Use of controls, adjustments, or procedures other than those specified in this documentation may result in exposure to shock, electrical hazards, and/or mechanical hazards.

For information on safety instructions, see the *Product Information Guide*.

FCC Notices (U.S. Only) and Other Regulatory Information

For FCC notices and other regulatory information, see the regulatory compliance website located at www.dell.com/regulatory_compliance.

Contacting Dell

For customers in the United States, call 800-WWW-DELL (800-999-3355).

 **NOTE:** If you do not have an active Internet connection, you can find contact information on your purchase invoice, packing slip, bill, or Dell product catalog.

Dell provides several online and telephone-based support and service options. Availability varies by country and product, and some services may not be available in your area. To contact Dell for sales, technical support, or customer service issues:

1. Visit support.dell.com.
 2. Verify your country or region in the **Choose A Country/Region** drop-down menu at the bottom of the page.
 3. Click **Contact Us** on the left side of the page.
 4. Select the appropriate service or support link based on your need.
 5. Choose the method of contacting Dell that is convenient for you.
-

[Back to Contents Page](#)

Setting Up Your Monitor

Dell™ P2212H/P2312H Monitor

If you have a Dell™ desktop or a Dell™ portable computer with internet access

1. Go to <http://support.dell.com>, enter your service tag, and download the latest driver for your graphics card.
2. After installing the drivers for your Graphics Adapter, attempt to set the resolution to **1920 x 1080** again.

 **NOTE:** If you are unable to set the resolution to 1920 x 1080, please contact Dell™ to inquire about a Graphics Adapter that supports these resolutions.

[Back to Contents Page](#)

Setting Up Your Monitor

Dell™ P2212H/P2312H Monitor

If you have a non Dell™ desktop, portable computer, or graphics card

In Windows XP:

1. Right-click on the desktop and click **Properties**.
2. Select the **Settings** tab.
3. Select **Advanced**.
4. Identify your graphics controller supplier from the description at the top of the window (e.g. NVIDIA, ATI, Intel etc.).
5. Refer to the graphic card provider website for updated driver (for example, <http://www.ATI.com> OR <http://www.NVIDIA.com>).
6. After installing the drivers for your Graphics Adapter, attempt to set the resolution to **1920 x 1080** again.

In Windows Vista® or Windows® 7:

1. Right-click on the desktop and click **Personalization**.
2. Click **Change Display Settings**.
3. Click **Advanced Settings**.
4. Identify your graphics controller supplier from the description at the top of the window (e.g. NVIDIA, ATI, Intel etc.).
5. Refer to the graphic card provider website for updated driver (for example, <http://www.ATI.com> OR <http://www.NVIDIA.com>).
6. After installing the drivers for your Graphics Adapter, attempt to set the resolution to **1920 x 1080** again.

 **NOTE:** If you are unable to set the resolution to 1920 x 1080, please contact the manufacturer of your computer or consider purchasing a graphics adapter that will support the video resolution of 1920 x 1080.
