

# Dell™ XPS™ 710 Owner's Manual

[Setting Up and Using Your Computer](#)

[Optimizing Performance](#)

[Solving Problems](#)

[Advanced Troubleshooting](#)

[Removing and Installing Parts](#)



[Appendix](#)

[Glossary](#)

Model DCDO

---

## Notes, Notices, and Cautions

-  **NOTE:** A NOTE indicates important information that helps you make better use of your computer.
-  **NOTICE:** A NOTICE indicates either potential damage to hardware or loss of data and tells you how to avoid the problem.
-  **CAUTION:** A CAUTION indicates a potential for property damage, personal injury, or death.

## Abbreviations and Acronyms

For a complete list of abbreviations and acronyms, see the [Glossary](#).

If you purchased a Dell™ n Series computer, any references in this document to Microsoft® Windows® operating systems are not applicable.

---

Information in this document is subject to change without notice.  
© 2006 Dell Inc. All rights reserved.

Reproduction in any manner whatsoever without the written permission of Dell Inc. is strictly forbidden.

Trademarks used in this text: *Dell*, the *DELL* logo, *Dell XPS*, *Inspiron*, *Dell Precision*, *Dimension*, *OptiPlex*, *Latitude*, *PowerEdge*, *PowerVault*, *PowerApp*, and *Dell OpenManage* are trademarks of Dell Inc.; *Intel*, *Pentium*, and *Celeron* are registered trademarks of Intel Corporation; *Microsoft* and *Windows* are registered trademarks of Microsoft Corporation.

Other trademarks and trade names may be used in this document to refer to either the entities claiming the marks and names or their products. Dell Inc. disclaims any proprietary interest in trademarks and trade names other than its own.

October 2006 P/N XM141 Rev. A00

## Appendix

### Dell™ XPS™ 710 Owner's Manual

- [Specifications](#)
- [System Setup](#)
- [Clearing Forgotten Passwords](#)
- [Clearing CMOS Settings](#)
- [Cleaning Your Computer](#)
- [Dell Hardware Warranty Support Policy \(U.S. Only\)](#)
- [FCC Notices \(U.S. Only\)](#)
- [Contacting Dell](#)

## Specifications

Processor	
Processor type	Intel® Core™ 2 Duo (dual-core processor) Intel® Core™ 2 Extreme (quad-core processor)
Cache	at least 1 MB

Memory	
Type	533-, and 667-MHz DDR2 unbuffered SDRAM
Memory connectors	four
Memory capacities	512 MB, 1 GB, or 2 GB non-ECC
Minimum memory	1 GB
Maximum memory	8 GB  <b>NOTE:</b> See <a href="#">Addressing Memory Configurations</a> to verify the amount of memory available to the operating system.
BIOS address	F0000h

Computer Information	
Chipset	NVIDIA nForce 590 SLI MCP
Northbridge	C19
Southbridge	MCP55
DMA channels	five
Interrupt levels	24
BIOS chip (NVRAM)	4 Mb
NIC	integrated network interface capable of 10/100/1000 communication
System clock	1066-MHz data rate

Video	
Type	PCI Express

Audio	
Type	HDA 7.1 channel

Expansion Bus	
---------------	--

Bus type	PCI 32-bit PCI Express x1 and x16
Bus speed	PCI: 33 MHz
Bus throughput	PCI Express:  x1 slot bidirectional speed — 2.5 Gbps  x16 slot bidirectional speed — 40 Gbps
PCI	
connector	three
connector size	124 pins
connector data width (maximum)	32 bits
PCI Express	
	<b>NOTE:</b> If a graphics card is installed in each of the PCI Express x16 card slots in the dual-graphics configuration, the PCI Express x1 card slot is not accessible for use.
connector	one x1
connector size	36 pins
connector data width (maximum)	1 PCI Express lane
PCI Express	
connector	one x8
connector size	98 pins
connector data width (maximum)	4 PCI Express lanes
PCI Express	
connector	two x16
connector size	164 pins
connector data width (maximum)	16 PCI Express lanes

<b>Drives</b>	
Available devices	Serial ATA drive, floppy drive, memory devices, DVD drive, DVD-RW drive, CD-RW/DVD combo drive, and media card reader
Externally accessible:	two 3.5-inch drive bays four 5.25-inch drive bays
Internally accessible:	four 3.5-inch drive bays for hard drives

<b>Connectors</b>	
External connectors:	
IEEE 1394	front and back-panel 6-pin serial connectors
Network adapter	RJ45 connector
PS/2 (keyboard and mouse)	two 6-pin mini-DIN
Serial	9-pin connector
USB	two front-panel, six back-panel, and two internal USB 2.0-compliant connectors
System board connectors:	
IDE drive	one 40-pin connector
Serial ATA	six 7-pin connectors
Floppy drive	34-pin connector
Fan	four 5-pin connectors
PCI	three 124-pin connectors
PCI Express x1	36-pin connector
PCI Express x8	98-pin connector
PCI Express x16	two 164-pin connectors

<b>Controls and Lights</b>	
Power control	push button
Power light	green light — Blinking green in sleep state; solid

	green for power-on state.  amber light — Blinking amber indicates a problem with an installed device; solid amber indicates an internal power problem (see <a href="#">Power Problems</a> ).
Hard-drive access light	green
Network activity light (front panel)	solid green indicates network connection
Link integrity light (on integrated network adapter)	green light — A good connection exists between a 10-Mbps network and the computer.  orange light — A good connection exists between a 100-Mbps network and the computer.  yellow light — A good connection exists between a 1-GB (1000-Mbps) network and the computer.  off (no light) — The computer is not detecting a physical connection to the network.
Activity light (on integrated network adapter)	yellow blinking light when there is activity on the network; if there is not any network activity, the light will be off
Diagnostic lights	four lights on the front panel (see <a href="#">Diagnostic Lights</a> )
Standby power light	AUXPWR on the system board
front panel LEDs	eight multi-colored LEDs provide illumination for the front of the computer  <b>NOTE:</b> The color of the front panel LEDs can be adjusted in system setup (see <a href="#">System Setup</a> ).
back panel LEDs	two multi-colored lights provide illumination for the I/O panel on the back of the computer  <b>NOTE:</b> The color of the back panel LEDs can be adjusted in system setup (see <a href="#">System Setup</a> ).

<b>Power</b>	
DC power supply:	<b>CAUTION:</b> To reduce the risk of fire, electric shock, or injury, do not overload an electrical outlet, power strip, or convenience receptacle. The total ampere rating of all products plugged into an electrical outlet, power strip, or other receptacle should not exceed 80 percent of the branch circuit rating.
Wattage	750 W or 1 KW
Heat dissipation	750 W: 2559 BTU/hr or 1 KW: 3412 BTU/hr  <b>NOTE:</b> Heat dissipation is calculated based upon the power supply wattage rating.
Voltage (see the safety instructions located in the <i>Product Information Guide</i> )	auto-sensing power supply—90 V to 265 V at 50/60 Hz
Backup battery	3-V CR2032 lithium coin cell

<b>Physical</b>	
Height	
Without stand	55.5 cm (21.9 inches)
With stand	57.2 cm (22.5 inches)
Width	
Without stand	21.9 cm (8.6 inches)
With stand	35.6 cm (14.0 inches)
Depth	59.4 cm (23.4 inches)
Weight	
Typical configuration	21.7 kg (47.8 lb)
Maximum configuration	25.6 kg (56.4 lb)

Environmental	
Temperature:	
Operating	10° to 35°C (50° to 95°F)
Storage	-40° to 65°C (-40° to 149°F)
Relative humidity	20% to 80% (noncondensing)
Maximum vibration:	
Operating	0.25 G at 3 to 200 Hz at 0.5 octave/min
Storage	0.5 G at 3 to 200 Hz at 1 octave/min
Maximum shock:	
Operating	bottom half-sine pulse with a change in velocity of 20 inches/sec (50.8 cm/sec)
Storage	27-G faired square wave with a velocity change of 200 inches/sec (508 cm/sec)
Altitude:	
Operating	-15.2 to 3048 m (-50 to 10,000 ft)
Storage	-15.2 to 10,668 m (-50 to 35,000 ft)

## System Setup

### Overview

Use system setup as follows:

- 1 To change the system configuration information after you add, change, or remove any hardware in your computer
- 1 To set or change a user-selectable option such as the user password
- 1 To read the current amount of memory or set the type of hard drive installed

Before you use system setup, it is recommended that you write down the system setup screen information for future reference.

 **NOTICE:** Do not change the settings in system setup unless you are an expert computer user. Certain changes can cause your computer to work incorrectly.

### Entering System Setup

1. Turn on (or restart) your computer.
2. When the DELL logo appears, press <F2> immediately.

 **NOTE:** Keyboard failure may result when a key on the keyboard is held down for extended periods of time. To avoid possible keyboard failure, press and release <F2> in even intervals until the system setup screen appears.

If you wait too long and the operating system logo appears, continue to wait until you see the Microsoft® Windows® desktop, then shut down your computer and try again.

### System Setup Screens

The system setup screen displays current or changeable configuration information for your computer. Information on the screen is divided into three areas: the options list, the active options field, and key functions.

**Options List** — This field appears on the left side of the system setup window. The field is a scrollable list containing features that define the configuration of your computer, including installed hardware, power conservation, and security features.

Scroll up and down the list with the up- and down-arrow keys. As an option is highlighted, the **Options Field** displays more information about that option and the option's current and available settings.

**Options Field** — This field appears on the right side of the system setup window and contains information about each option listed in the **Options List**. In this field you can view information about your computer and make changes to your current settings.

Press the left- and right-arrow keys to highlight an option. Press <Enter> to make that selection active and return to the **Options List**.

**NOTE:** Not all settings listed in the Options Field are changeable.

	<p><b>Key Functions</b> — This field appears below the <b>Options Field</b> and lists keys and their functions within the active system setup field.</p>

## System Setup Options

 **NOTE:** Depending on your computer and installed devices, the items listed in this section may not appear, or may not appear exactly as listed.

<b>System</b>	
Processor Info	Identifies the processor type, clock speed, bus speed, L2 cache, ID, and whether the processor is multiple core capable, supports Hyper-Threading and supports 64-bit technology.
Memory Info	Identifies the memory type, speed, and channel mode (dual or single) by DIMM slot location.
PCI Info	Indicates the expansion card type by slot location.
Date/Time	Displays current date and time settings.
Boot Sequence	<p>The computer attempts to boot from the sequence of devices specified in this list.</p> <p><b>NOTE:</b> If you insert a boot device and restart the computer, this option appears in the system setup menu. To boot from a USB memory device, for example, select the USB device and move it so that it becomes the first device in the boot sequence.</p>

<b>Drives</b>	
Diskette Drive (Internal default)	<p>Enables and disables the floppy drive attached to the DSKT connector on the system board and sets read permissions for the drive.</p> <ul style="list-style-type: none"> <li>1 <b>Off</b> — All floppy drives are disabled.</li> <li>1 <b>USB</b> — USB floppy drives are enabled.</li> <li>1 <b>Internal</b> — The integrated floppy drive is enabled.</li> <li>1 <b>Read Only</b> — The integrated floppy drive is enabled with read-only access.</li> </ul> <p><b>NOTE:</b> Operating systems with USB support will recognize USB floppy drives regardless of this setting.</p>
SATA Drives 0 through 5 (On default)	<p>Enables or disables drives attached to the SATA connectors on the system board.</p> <ul style="list-style-type: none"> <li>1 <b>Off</b> — A device attached to the interface is not usable.</li> <li>1 <b>On</b> — A device attached to the interface is usable.</li> <li>1 <b>RAID On</b> - A device attached to the interface is configured for RAID (see <a href="#">About Your RAID Configuration</a>).</li> </ul>
PATA Drives 0 through 1 (On default)	<p>Enables or disables drives attached to the ATA connectors on the system board, and lists the controller details.</p> <ul style="list-style-type: none"> <li>1 <b>Off</b> — A device attached to the interface is not usable.</li> <li>1 <b>On</b> — A device attached to the interface is usable.</li> </ul>

SMART Reporting  (Off default)	Determines whether hard-drive errors for internal drives are reported during system startup.  <ul style="list-style-type: none"> <li>  Off — Errors are not reported.</li> <li>  On — Errors are reported.</li> </ul>
--------------------------------------	-----------------------------------------------------------------------------------------------------------------------------------------------------------------------------------------------------------------------------

<b>Onboard Devices</b>	
Integrated NIC  (On default)	Enables or disables the integrated network interface controller (NIC).  <ul style="list-style-type: none"> <li>  Off — The integrated NIC is disabled.</li> <li>  On — The integrated NIC is enabled.</li> <li>  On w/PXE — The integrated NIC is on (with PXE enabled).</li> </ul> <p><b>NOTE:</b> PXE is required only if you are booting to an operating system located on another computer. If a boot routine is not available from the remote system, the computer attempts to boot from the next device listed in the boot sequence.</p>
Integrated Audio  (On default)	Enables or disables the onboard audio controller.  <ul style="list-style-type: none"> <li>  Off — Integrated audio is disabled.</li> <li>  On — Integrated audio is enabled.</li> </ul>
USB Controller  (On default)	Enables or disables the internal USB controller.  <ul style="list-style-type: none"> <li>  Off — The USB controller is disabled.</li> <li>  On — The USB controller is enabled.</li> <li>  No Boot — The USB controller is enabled; however, the BIOS will not recognize USB storage devices.</li> </ul> <p><b>NOTE:</b> Operating systems with USB support will recognize USB storage devices regardless of the <b>No Boot</b> setting.</p>
1394 Controller  (On default)	Enables or disables the integrated IEEE 1394 controller.  <ul style="list-style-type: none"> <li>  Off — The 1394 controller is disabled.</li> <li>  On — The 1394 controller is enabled.</li> </ul>
Serial Port #1  (Auto default)	Disables or selects the address for the integrated serial port and determines how the serial port operates.  <ul style="list-style-type: none"> <li>  Off — The serial port is disabled.</li> <li>  Auto — The BIOS selects between COM1 and COM3; if both resources are in use the port is disabled.</li> <li>  COM1 — The port is configured at 3F8h with IRQ 4.</li> <li>  COM3 — The port is configured at 3E8h with IRQ 4.</li> </ul>
PS/2 Mouse Port  (On default)	Enables or disables the onboard PS/2-compatible mouse controller.  <ul style="list-style-type: none"> <li>  Off — The PS/2 legacy mouse port is disabled.</li> <li>  On — The PS/2 legacy mouse port is enabled.</li> </ul>
LED color	Adjusts the color of the front and back LEDs (see <a href="#">Front and Back View of the Computer</a> ).

<b>Performance</b>	
Multiple CPU Core  (On default)	Specifies whether the processor has more than one core enabled.  <ul style="list-style-type: none"> <li>  Off — Multiple CPU core technology is disabled.</li> <li>  On — Multiple CPU core technology is enabled.</li> </ul> <p><b>NOTE:</b> The performance of some applications may improve with an additional core enabled.</p>

<p>CPU Clock Speed</p>	<p>Provides limited capability to adjust the CPU clock speed so that the CPU operates at a different frequency than that designated in the manufacturer's design specifications.</p> <p><b>NOTE:</b> To enable overclocking, you first need to enable the option in BIOS and then download an application like NVIDIA® nTune™ version 5.0 or higher.</p> <p><b>NOTE:</b> Pressing &lt;Alt&gt;&lt;F&gt; returns your system to the factory defaults including RAID settings.</p>
<p>HDD Acoustic Mode</p> <p>(Bypass default)</p>	<p>Determines the acoustic mode at which the hard drive operates.</p> <ul style="list-style-type: none"> <li>1 <b>Bypass</b> — Do nothing (needed for older drives).</li> <li>1 <b>Quiet</b> — The hard drive operates at its most quiet setting.</li> <li>1 <b>Suggested</b> — Allow the hard drive manufacturer to select the mode.</li> <li>1 <b>Performance</b> — The hard drive operates at its maximum speed.</li> </ul> <p><b>NOTE:</b> Switching to performance mode may cause an increase in noise produced by the drive, but does not affect the drive's performance.</p> <p><b>NOTE:</b> Changing the acoustics setting does not alter your hard drive image.</p>

<p><b>Security</b></p>	
<p>Admin Password</p> <p>(Not Set default)</p>	<p>Used to prohibit an unauthorized user from changing any configuration settings in the system setup.</p>
<p>System Password</p> <p>(Not Set default)</p>	<p>Used to prohibit an unauthorized user from booting to the operating system.</p>
<p>Password Changes</p> <p>(Unlocked default)</p>	<p>This option locks the system password field with the administrator (admin) password.</p> <p><b>NOTE:</b> When the system password field is locked, you can no longer disable password security by pressing &lt;Ctrl&gt;&lt;Enter&gt; when the computer starts.</p>
<p>Execute Disable</p> <p>(On default)</p>	<p>Enables or disables Execute Disable Memory Protection technology.</p> <ul style="list-style-type: none"> <li>1 <b>Off</b> — Execute Disable Memory Protection technology is disabled.</li> <li>1 <b>On</b> — Execute Disable Memory Protection technology is enabled.</li> </ul>

<p><b>Power Management</b></p>	
<p>AC Recovery</p> <p>(Off default)</p>	<p>Specifies how the computer will behave when AC power is restored after an AC power loss.</p> <ul style="list-style-type: none"> <li>1 <b>Off</b> — The system stays off after AC power is restored.</li> <li>1 <b>On</b> — The system powers on after AC power is restored.</li> <li>1 <b>Last</b> — The system returns to the previous state after AC power is restored.</li> </ul>
<p>Auto Power On</p> <p>(Off default)</p>	<p>Disables or selects when to automatically turn on the computer.</p> <ul style="list-style-type: none"> <li>1 <b>Off</b> — Do not use the <b>Auto Power Time</b>.</li> <li>1 <b>Everyday</b> — Turn the computer on every day at the time set in <b>Auto Power Time</b>.</li> <li>1 <b>Weekdays</b> — Turn the computer on Monday through Friday at the time set in <b>Auto Power</b></li> </ul>



	<p><b>Time.</b></p> <p><b>NOTE:</b> This feature does not work if you turn off your computer using a power strip or surge protector.</p>
Auto Power Time	<p>Specifies the time to automatically turn on the computer.</p> <p>Change the time to automatically turn on the computer by pressing the up- or down-arrow key to increase or decrease the numbers, or type the numbers in the appropriate time field.</p> <p><b>NOTE:</b> This feature does not work if you turn off your computer using a power strip or surge protector.</p>
Suspend Mode  (S3 default)	<p>Specifies the power management suspend mode.</p> <ul style="list-style-type: none"> <li>  <b>S1</b> — The computer resumes more quickly from sleep mode.</li> <li>  <b>S3</b> — The computer conserves more power when not in use (system memory remains active).</li> </ul>

<b>Maintenance</b>	
Service Tag	Displays the system service tag.
Load Defaults	<p>This setting restores the computer's factory-installed default settings.</p> <ul style="list-style-type: none"> <li>  <b>Cancel</b> — Do not restore factory-installed default settings.</li> <li>  <b>Continue</b> — Restore factory-installed default settings.</li> </ul>
Event Log	<p>Displays the system event log.</p> <ul style="list-style-type: none"> <li>  <b>Mark all entries</b> — Mark all event log entries as read (R).</li> <li>  <b>Clear log</b> — Clear all event log entries.</li> </ul> <p><b>NOTE:</b> Once an event log entry is marked as read (R) that entry cannot be marked as unread (U).</p>

<b>POST Behavior</b>	
Fastboot  (On default)	<p>Enables or disables the option to speed up the boot process by skipping some compatibility tests.</p> <ul style="list-style-type: none"> <li>  <b>Off</b> — Do not skip any steps in the boot process.</li> <li>  <b>On</b> — Boot quickly.</li> </ul>
Numlock Key  (On default)	<p>Enables or disables the numerical and mathematical features of the rightmost bank of keys on the keyboard.</p> <ul style="list-style-type: none"> <li>  <b>Off</b> — Right keypad keys function as arrows.</li> <li>  <b>On</b> — Right keypad keys function as numbers.</li> </ul>
POST Hotkeys  (Setup & Boot Menu default)	<p>Specifies the function keys to display on the screen when the computer starts.</p> <ul style="list-style-type: none"> <li>  <b>Setup &amp; Boot Menu</b> — Display both messages (F2=Setup and F12=Boot Menu).</li> <li>  <b>Setup</b> — Display the setup message only (F2=Setup).</li> <li>  <b>Boot Menu</b> — Display the <b>Quickboot</b> message only (F12=Boot Menu).</li> <li>  <b>None</b> — Neither message is displayed.</li> </ul>
Keyboard Errors  (Report default)	<p>Enables or disables keyboard error reporting when the computer starts.</p> <ul style="list-style-type: none"> <li>  <b>Report</b> — Display any keyboard errors.</li> <li>  <b>Do not report</b> — Do not display any keyboard errors.</li> </ul>

---

## Boot Sequence

This feature allows you to change the boot sequence for the bootable devices installed on your computer.

### Option Settings

1. **Diskette Drive** — The computer attempts to boot from the floppy drive. If the floppy disk in the drive is not bootable, if no floppy disk is in the drive, or if there is no floppy drive installed in the computer, the computer attempts to boot from the next bootable device in the boot sequence.
1. **Hard Drive** — The computer attempts to boot from the primary hard drive. If no operating system is on the drive, the computer attempts to boot from the next bootable device in the boot sequence.
1. **CD Drive** — The computer attempts to boot from the CD drive. If no CD is in the drive, or if the CD has no operating system, the computer attempts to boot from the next bootable device in the boot sequence.
1. **USB Flash Device** — Insert the memory device into a USB port and restart the computer. When **F12 = Boot Menu** appears in the upper-right corner of the screen, press <F12>. The BIOS detects the device and adds the USB flash option to the boot menu.

 **NOTE:** To boot to a USB device, the device must be bootable. To make sure that your device is bootable, check the device documentation.

 **NOTE:** An error message is generated only after the computer attempts to boot from every device in the boot sequence and no operating system is found.

### Changing Boot Sequence for the Current Boot

You can use this feature, for example, to tell the computer to boot from the CD drive so that you can run the Dell Diagnostics on the *Dell ResourceCD*, but you want the computer to boot from the hard drive when the diagnostic tests are complete. You can also use this feature to restart your computer to a USB device such as a floppy drive, memory key, or CD-RW drive.

 **NOTE:** If you are booting to a USB floppy drive, you must first set the floppy drive to **OFF** in system setup (see [System Setup](#)).

1. If you are booting to a USB device, connect the USB device to a USB connector (see [Back View](#)).
2. Turn on (or restart) your computer.
3. When the DELL logo appears, press <F12> immediately.

 **NOTE:** Keyboard failure may result when a key on the keyboard is held down for extended periods of time. To avoid possible keyboard failure, press and release <F12> in even intervals until the **Boot Device Menu** appears.

If you wait too long and the operating system logo appears, continue to wait until you see the Microsoft Windows desktop, then shut down your computer and try again.

4. At the **Boot Device Menu**, use the up- and down-arrow keys or press the appropriate number on the keyboard to highlight the device that is to be used for the current boot only, and then press <Enter>.

For example, if you are booting to a USB memory key, highlight **USB Flash Device** and press <Enter>.

 **NOTE:** To boot to a USB device, the device must be bootable. To make sure that your device is bootable, check the device documentation.

### Changing Boot Sequence for Future Boots

1. Enter system setup (see [Entering System Setup](#)).
2. Use the arrow keys to highlight the **Boot Sequence** menu option and press <Enter> to access the menu.

 **NOTE:** Write down your current boot sequence in case you want to restore it.

3. Press the up- and down-arrow keys to move through the list of devices.
4. Press the spacebar to enable or disable a device (enabled devices have a checkmark).
5. Press plus (+) or minus (-) to move a selected device up or down the list.

---

## Clearing Forgotten Passwords

**CAUTION:** Before you begin any of the procedures in this section, follow the safety instructions in the *Product Information Guide*.

**NOTICE:** This process erases both the system and setup passwords

1. Follow the procedures in [Before You Begin](#).
2. Remove the computer cover (see [Removing the Computer Cover](#)).

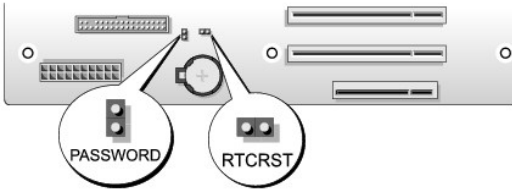

3. Locate the 2-pin password jumper (PASSWORD) on the system board (see [System Board Components](#)), then remove the jumper plug and set the plug aside.
4. Close the computer cover.
5. Connect your keyboard and mouse, then connect your computer and monitor to electrical outlets and turn them on.
6. After the Microsoft® Windows® desktop appears on your computer, turn the computer off:
  - a. Click **Start**, then click **Turn Off Computer**.
  - b. In the **Turn off computer** window, click **Turn off**.

The computer performs a shutdown of the operating system, and then turns off.

**NOTE:** Ensure that the computer is off and not in a power management mode. If you cannot shut down the computer using the operating system, press and hold the power button for 4 seconds.

7. Disconnect the keyboard and mouse, then disconnect the computer and monitor from their electrical outlets.
  8. Press the power button on the computer to ground the system board.
  9. Open the computer cover (see [Removing the Computer Cover](#)).
- NOTICE:** The password jumper plug must be reinstalled on the password jumper pins in order to enable the password feature.
10. Locate the 2-pin password jumper on the system board (see [System Board Components](#)), and then reinstall the jumper plug to enable the password feature.
  11. Replace the computer cover (see [Replacing the Computer Cover](#)).

**NOTICE:** To connect a network cable, first plug the cable into the network wall jack and then plug it into the computer.

12. Connect your computer and devices to electrical outlets, and then turn them on.

**NOTE:** In system setup (see [Entering System Setup](#)), both system and administrator password options appear as **Not Set**. The password feature is enabled but a password is not assigned.

---

## Clearing CMOS Settings

**CAUTION:** Before you begin any of the procedures in this section, follow the safety instructions in the *Product Information Guide*.

**NOTE:** This procedure does not clear or reset system and setup passwords.

1. Follow the procedures in [Before You Begin](#).
2. Remove the computer cover (see [Removing the Computer Cover](#)).

3. Locate the password (PASSWORD) and CMOS (RTCRST) jumpers on the system board (see [System Board Components](#)).
  4. Remove the password jumper plug, then place the plug on the CMOS jumper pins and wait approximately 5 seconds.
- 🔔 **NOTICE:** The password jumper plug must be reinstalled on the password jumper pins in order to enable the password feature.
5. Remove the jumper plug from the CMOS jumper pins, and then reinstall the plug on the password jumper pins to enable the password feature.
  6. Close the computer cover (see [Replacing the Computer Cover](#)).
- 🔔 **NOTICE:** To connect a network cable, first plug the cable into the network wall jack and then plug it into the computer.
7. Connect your computer and devices to electrical outlets, and then turn them on.
- 

## Cleaning Your Computer

⚠ **CAUTION:** Before you begin any of the procedures in this section, follow the safety instructions in the *Product Information Guide*.

### Computer, Keyboard, and Monitor

⚠ **CAUTION:** Before you clean your computer, disconnect the computer from the electrical outlet. Clean your computer with a soft cloth dampened with water. Do not use liquid or aerosol cleaners, which may contain flammable substances.

1. Use a vacuum cleaner with a brush attachment to gently remove dust from the slots and holes on your computer and from between the keys on the keyboard.

🔔 **NOTICE:** Do not wipe the display screen with any soap or alcohol solution. Doing so may damage the antiglare coating.

1. To clean your monitor screen, lightly dampen a soft, clean cloth with water. If possible, use a special screen-cleaning tissue or solution suitable for the monitor's antistatic coating.
1. Wipe the keyboard, computer, and plastic part of the monitor with a soft cleaning cloth moistened with water.

Do not soak the cloth or let water drip inside your computer or keyboard.

### Mouse

If your screen cursor skips or moves abnormally, clean the mouse. To clean a non-optical mouse:

1. Turn the retainer ring on the underside of your mouse counterclockwise, and then remove the ball.
2. Wipe the ball with a clean, lint-free cloth.
3. Blow carefully into the ball cage to dislodge dust and lint.
4. If the rollers inside the ball cage are dirty, clean the rollers with a cotton swab moistened lightly with isopropyl alcohol.
5. Recenter the rollers in their channels if they are misaligned. Ensure that fluff from the swab is not left on the rollers.
6. Replace the ball and retainer ring, and turn the retainer ring clockwise until it clicks into place.

### Floppy Drive

🔔 **NOTICE:** Do not attempt to clean drive heads with a swab. The heads may become misaligned and prevent the drive from operating.

Clean your floppy drive using a commercially available cleaning kit. These kits contain pretreated floppy disks to remove contaminants that accumulate during normal operation.

### CDs and DVDs

 **NOTICE:** Always use compressed air to clean the lens in the CD/DVD drive, and follow the instructions that come with the compressed air. Never touch the lens in the drive.

If you notice problems, such as skipping, with the playback quality of your CDs or DVDs, try cleaning the discs.

1. Hold the disc by its outer edge. You can also touch the inside edge of the center hole.

 **NOTICE:** To prevent damaging the surface, do not wipe in a circular motion around the disc.

2. With a soft, lint-free cloth, gently wipe the bottom of the disc (the unlabeled side) in a straight line from the center to the outer edge of the disc.

For stubborn dirt, try using water or a diluted solution of water and mild soap. You can also purchase commercial products that clean discs and provide some protection from dust, fingerprints, and scratches. Cleaning products for CDs are safe to use on DVDs.

---

## Dell Hardware Warranty Support Policy (U.S. Only)

Technician-assisted support requires the cooperation and participation of the customer in the troubleshooting process and provides for restoration of the operating system, software programs, and hardware drivers to the original default configuration as shipped from Dell, as well as the verification of appropriate functionality of the computer and all Dell-installed hardware. In addition to this technician-assisted support, online support is available at [support.dell.com](http://support.dell.com). Additional support options may be available for purchase.

Dell provides limited support for the computer and any "Dell-installed" software and peripherals<sup>1</sup>. Support for third-party software and peripherals is provided by the original manufacturer, including those purchased and/or installed through Dell Software and Peripherals, Readyware, and Custom Factory Integration<sup>2</sup>.

<sup>1</sup> Repair services are provided pursuant to the terms and conditions of your limited warranty and any optional support service contract purchased with the computer.

<sup>2</sup> All Dell-standard components included in a Custom Factory Integration (CFI) project are covered by the standard Dell limited warranty for your computer. However, Dell also extends a parts replacement program to cover all nonstandard, third-party hardware components integrated through CFI for the duration of the computer's service contract.

## Definition of "Dell-Installed" Software and Peripherals

Dell-installed software includes the operating system and some of the software programs that are installed on the computer during the manufacturing process (Microsoft® Office, Norton Antivirus, and so on).

Dell-installed peripherals include any internal expansion cards, or Dell-branded module bay or PC Card accessories. In addition, any Dell-branded monitors, keyboards, mice, speakers, microphones for telephonic modems, docking stations/port replicators, networking products, and all associated cabling are included.

## Definition of "Third-Party" Software and Peripherals

Third-party software and peripherals include any peripheral, accessory, or software program sold by Dell not under the Dell brand (printers, scanners, cameras, games, and so on). Support for all third-party software and peripherals is provided by the original manufacturer of the product.

---

## FCC Notices (U.S. Only)

Most Dell computer systems are classified by the Federal Communications Commission (FCC) as Class B digital devices. To determine which classification applies to your computer system, examine all FCC registration labels located on the bottom, side, or back panel of your computer, on card-mounting brackets, and on the cards themselves. If any one of the labels carries a Class A rating, your entire system is considered to be a Class A digital device. If all labels carry an FCC Class B rating as distinguished by either an FCC ID number or the FCC logo, (FCC), your system is considered to be a Class B digital device.

Once you have determined your system's FCC classification, read the appropriate FCC notice. Note that FCC regulations provide that changes or modifications not expressly approved by Dell could void your authority to operate this equipment.

This device complies with Part 15 of the FCC Rules. Operation is subject to the following two conditions:

1. This device may not cause harmful interference.
2. This device must accept any interference received, including interference that may cause undesired operation.

## Class A

This equipment has been tested and found to comply with the limits for a Class A digital device pursuant to Part 15 of the FCC Rules. These limits are designed to provide reasonable protection against harmful interference when the equipment is operated in a commercial environment. This equipment generates, uses, and can radiate radio frequency energy and, if not installed and used in accordance with the manufacturer's instruction manual, may cause harmful interference with radio communications. Operation of this equipment in a residential area is likely to cause harmful interference, in which case you will be required to correct the interference at your own expense.

## Class B

This equipment has been tested and found to comply with the limits for a Class B digital device pursuant to Part 15 of the FCC Rules. These limits are designed to provide reasonable protection against harmful interference in a residential installation. This equipment generates, uses, and can radiate radio frequency energy and, if not installed and used in accordance with the manufacturer's instruction manual, may cause interference with radio communications. However, there is no guarantee that interference will not occur in a particular installation. If this equipment does cause harmful interference to radio or television reception, which can be determined by turning the equipment off and on, you are encouraged to try to correct the interference by one or more of the following measures:

- 1 Reorient or relocate the receiving antenna.
- 1 Increase the separation between the equipment and the receiver.
- 1 Connect the equipment into an outlet on a circuit different from that to which the receiver is connected.
- 1 Consult the dealer or an experienced radio/television technician for help.

## FCC Identification Information

The following information is provided on the device or devices covered in this document in compliance with FCC regulations:

- 1 Product name: Dell™ XPS™ 710
- 1 Model number: DCDO

Company name:

Dell Inc.  
One Dell Way  
Round Rock, Texas 78682 USA  
512-338-4400

## Contacting Dell

To contact Dell electronically, you can access the following websites:

- 1 [www.dell.com](http://www.dell.com)
- 1 [support.dell.com](http://support.dell.com) (support)

For specific web addresses for your country, find the appropriate country section in the table below.

 **NOTE:** Toll-free numbers are for use within the country for which they are listed.

 **NOTE:** In certain countries, support specific to Dell™ XPS™ computers is available at a separate telephone number listed for participating countries. If you do not see a telephone number listed that is specific for XPS computers, you may contact Dell through the support number listed and your call will be routed appropriately.

When you need to contact Dell, use the electronic addresses, telephone numbers, and codes provided in the following table. If you need assistance in determining which codes to use, contact a local or an international operator.

 **NOTE:** The contact information provided was deemed correct at the time that this document went to print and is subject to change.

Country (City) International Access Code Country Code City Code	Department Name or Service Area, Website and E-Mail Address	Area Codes, Local Numbers, and Toll-Free Numbers
Anguilla	Website: <a href="http://www.dell.com.ai">www.dell.com.ai</a>	
	E-mail: <a href="mailto:la-techsupport@dell.com">la-techsupport@dell.com</a>	
	General Support	toll-free: 800-335-0031
Antigua and Barbuda	Website: <a href="http://www.dell.com.ag">www.dell.com.ag</a>	
	E-mail: <a href="mailto:la-techsupport@dell.com">la-techsupport@dell.com</a>	
	General Support	1-800-805-5924
Aomen	Technical Support (Dell™ Dimension™, Dell Inspiron™, Dell OptiPlex™, Dell Latitude™, and Dell Precision™)	0800-105
	Technical Support (servers and storage)	0800-105
Argentina (Buenos Aires)  International Access Code: 00	Website: <a href="http://www.dell.com.ar">www.dell.com.ar</a>	
	E-mail: <a href="mailto:la-techsupport@dell.com">la-techsupport@dell.com</a>	
	E-mail for desktop and portable computers: <a href="mailto:la-techsupport@dell.com">la-techsupport@dell.com</a>	
	E-mail for servers and EMC® storage products: <a href="mailto:la_enterprise@dell.com">la_enterprise@dell.com</a>	

Country Code: <b>54</b> City Code: <b>11</b>	Customer Care	toll-free: 0-800-444-0730
	Technical Support	toll-free: 0-800-444-0733
	Technical Support Services	toll-free: 0-800-444-0724
	Sales	0-810-444-3355
<b>Aruba</b>	Website: <a href="http://www.dell.com.aw">www.dell.com.aw</a>	
	E-mail: <a href="mailto:la-techsupport@dell.com">la-techsupport@dell.com</a>	
	General Support	toll-free: 800-1578
<b>Australia (Sydney)</b> International Access Code: <b>0011</b> Country Code: <b>61</b> City Code: <b>2</b>	Website: <a href="http://support.ap.dell.com">support.ap.dell.com</a>	
	E-mail: <a href="mailto:support.ap.dell.com/contactus">support.ap.dell.com/contactus</a>	
	Technical Support (XPS)	toll-free: 1300 790 877
	General Support	13DELL-133355
<b>Austria (Vienna)</b> International Access Code: <b>900</b> Country Code: <b>43</b> City Code: <b>1</b>	Website: <a href="http://support.euro.dell.com">support.euro.dell.com</a>	
	E-mail: <a href="mailto:tech_support_central_europe@dell.com">tech_support_central_europe@dell.com</a>	
	Home/Small Business Sales	0820 240 530 00
	Home/Small Business Fax	0820 240 530 49
	Home/Small Business Customer Care	0820 240 530 14
	Preferred Accounts/Corporate Customer Care	0820 240 530 16
	Support for XPS	0820 240 530 81
	Home/Small Business Support for all other Dell computers	0820 240 530 17
	Preferred Accounts/Corporate Support	0820 240 530 17
	Switchboard	0820 240 530 00
<b>Bahamas</b>	Website: <a href="http://www.dell.com.bs">www.dell.com.bs</a>	
	E-mail: <a href="mailto:la-techsupport@dell.com">la-techsupport@dell.com</a>	
	General Support	toll-free: 1-866-874-3038
<b>Barbados</b>	Website: <a href="http://www.dell.com/bb">www.dell.com/bb</a>	
	E-mail: <a href="mailto:la-techsupport@dell.com">la-techsupport@dell.com</a>	
	General Support	1-800-534-3142
<b>Belgium (Brussels)</b> International Access Code: <b>00</b> Country Code: <b>32</b> City Code: <b>2</b>	Website: <a href="http://support.euro.dell.com">support.euro.dell.com</a>	
	Tech Support for XPS	02 481 92 96
	Tech Support for all other Dell computers	02 481 92 88
	Tech Support Fax	02 481 92 95
	Customer Care	02 713 15 65
	Corporate Sales	02 481 91 00
	Fax	02 481 92 99
	Switchboard	02 481 91 00
<b>Bermuda</b>	Website: <a href="http://www.dell.com/bm">www.dell.com/bm</a>	
	E-mail: <a href="mailto:la-techsupport@dell.com">la-techsupport@dell.com</a>	
	General Support	1-877-890-0751
<b>Bolivia</b>	Website: <a href="http://www.dell.com/bo">www.dell.com/bo</a>	
	E-mail: <a href="mailto:la-techsupport@dell.com">la-techsupport@dell.com</a>	
	General Support	toll-free: 800-10-0238
<b>Brazil</b> International Access Code: <b>00</b> Country Code: <b>55</b> City Code: <b>51</b>	Website: <a href="http://www.dell.com/br">www.dell.com/br</a>	
	E-mail: <a href="mailto:BR-TechSupport@dell.com">BR-TechSupport@dell.com</a>	
	Customer Care and Tech Support	0800 90 3355
	Technical Support Fax	51 2104 5470
	Customer Care Fax	51 2104 5480
	Sales	0800 722 3498
<b>British Virgin Islands</b>	General Support	toll-free: 1-866-278-6820
<b>Brunei</b> Country Code: <b>673</b>	Technical Support (Penang, Malaysia)	604 633 4966
	Customer Care (Penang, Malaysia)	604 633 4888
	Transaction Sales (Penang, Malaysia)	604 633 4955
	Online Order Status: <a href="http://www.dell.ca/ostatus">www.dell.ca/ostatus</a>	
	Website: <a href="http://support.ca.dell.com">support.ca.dell.com</a>	
	AutoTech (automated Hardware and Warranty Support)	toll-free: 1-800-247-9362
	Customer Service (Home/Home Office)	toll-free: 1-800-847-4096
	Customer Service (small/med./large business, government)	toll-free: 1-800-387-5757

Canada (North York, Ontario) International Access Code: 011	Customer Service (printers, projectors, televisions, handhelds, digital jukebox, and wireless)	toll-free: 1-800-847-4096
	Hardware Warranty Phone Support (XPS)	toll-free: 1-866-398-8977
	Hardware Warranty Phone Support (Home/Home Office)	toll-free: 1-800-847-4096
	Hardware Warranty Phone Support (small/med./large business, government)	toll-free: 1-800-387-5757
	Hardware Warranty Phone Support (printers, projectors, televisions, handhelds, digital jukebox, and wireless)	1-877-335-5767
	Sales (Home Sales/Small Business)	toll-free: 1-800-387-5752
	Sales (med./large bus., government)	toll-free: 1-800-387-5755
	Spare Parts Sales & Extended Service Sales	1 866 440 3355
Cayman Islands	E-mail: la-techsupport@dell.com	
	General Support	1-877-262-5415
Chile (Santiago) Country Code: 56 City Code: 2	Website: <a href="http://www.dell.com/cl">www.dell.com/cl</a>	
	E-mail: la-techsupport@dell.com	
	Sales and Customer Support	toll-free: 1230-020-4823
China (Xiamen) Country Code: 86 City Code: 592	Technical Support website: <a href="http://support.dell.com.cn">support.dell.com.cn</a>	
	Technical Support E-mail: support.dell.com.cn/email	
	Customer Care E-mail: customer_cn@dell.com	
	Technical Support Fax	592 818 1350
	Technical Support (XPS)	toll-free: 800 858 0540
	Technical Support (Dimension and Inspiron)	toll-free: 800 858 2969
	Technical Support (OptiPlex, Latitude, and Dell Precision)	toll-free: 800 858 0950
	Technical Support (servers and storage)	toll-free: 800 858 0960
	Technical Support (projectors, PDAs, switches, routers, and so on)	toll-free: 800 858 2920
	Technical Support (printers)	toll-free: 800 858 2311
	Customer Care	toll-free: 800 858 2060
	Customer Care Fax	592 818 1308
	Home and Small Business	toll-free: 800 858 2222
	Preferred Accounts Division	toll-free: 800 858 2557
	Large Corporate Accounts GCP	toll-free: 800 858 2055
	Large Corporate Accounts Key Accounts	toll-free: 800 858 2628
	Large Corporate Accounts North	toll-free: 800 858 2999
	Large Corporate Accounts North Government and Education	toll-free: 800 858 2955
	Large Corporate Accounts East	toll-free: 800 858 2020
	Large Corporate Accounts East Government and Education	toll-free: 800 858 2669
Large Corporate Accounts Queue Team	toll-free: 800 858 2572	
Large Corporate Accounts South	toll-free: 800 858 2355	
Large Corporate Accounts West	toll-free: 800 858 2811	
Large Corporate Accounts Spare Parts	toll-free: 800 858 2621	
Colombia	Website: <a href="http://www.dell.com/cl">www.dell.com/cl</a>	
	E-mail: la-techsupport@dell.com	
	General Support	01-800-915-4755
Costa Rica	Website: <a href="http://www.dell.com/cr">www.dell.com/cr</a>	
	E-mail: la-techsupport@dell.com	
	General Support	0800-012-0231
Czech Republic (Prague) International Access Code: 00 Country Code: 420	Website: <a href="http://support.euro.dell.com">support.euro.dell.com</a>	
	E-mail: czech_dell@dell.com	
	Technical Support	22537 2727
	Customer Care	22537 2707
	Fax	22537 2714
	Technical Fax	22537 2728
Switchboard	22537 2711	
Denmark (Copenhagen) International Access Code: 00	Website: <a href="http://support.euro.dell.com">support.euro.dell.com</a>	
	Technical Support for XPS	7010 0074
	Technical Support for all other Dell computers	7023 0182
	Customer Care (Relational)	7023 0184
	Home/Small Business Customer Care	3287 5505
Switchboard (Relational)	3287 1200	



Country Code: 45	Switchboard Fax (Relational)	3287 1201
	Switchboard (Home/Small Business)	3287 5000
	Switchboard Fax (Home/Small Business)	3287 5001
Dominica	Website: <a href="http://www.dell.com/dm">www.dell.com/dm</a>	
	E-mail: <a href="mailto:la-techsupport@dell.com">la-techsupport@dell.com</a>	
	General Support	toll-free: 1-866-278-6821
Dominican Republic	Website: <a href="http://www.dell.com/do">www.dell.com/do</a>	
	E-mail: <a href="mailto:la-techsupport@dell.com">la-techsupport@dell.com</a>	
	General Support	1-800-156-1588
Ecuador	Website: <a href="http://www.dell.com/ec">www.dell.com/ec</a>	
	E-mail: <a href="mailto:la-techsupport@dell.com">la-techsupport@dell.com</a>	
	General Support (calling from Quito)	toll-free: 999-119-877-655-3355
	General Support (calling from Guayaquil)	toll-free: 1800-999-119-877-655-3355
El Salvador	Website: <a href="http://www.dell.com/ec">www.dell.com/ec</a>	
	E-mail: <a href="mailto:la-techsupport@dell.com">la-techsupport@dell.com</a>	
	General Support	800-6132
Finland (Helsinki) International Access Code: 990 Country Code: 358 City Code: 9	Website: <a href="http://support.euro.dell.com">support.euro.dell.com</a>	
	E-mail: <a href="mailto:fi_support@dell.com">fi_support@dell.com</a>	
	Technical Support	0207 533 555
	Customer Care	0207 533 538
	Switchboard	0207 533 533
	Sales under 500 employees	0207 533 540
	Fax	0207 533 530
	Sales over 500 employees	0207 533 533
	Fax	0207 533 530
France (Paris) (Montpellier) International Access Code: 00 Country Code: 33 City Codes: (1) (4)	Website: <a href="http://support.euro.dell.com">support.euro.dell.com</a>	
	<b>Home and Small Business</b>	
	Technical Support for XPS	0825 387 129
	Technical Support for all other Dell computers	0825 387 270
	Customer Care	0825 823 833
	Switchboard	0825 004 700
	Switchboard (calls from outside of France)	04 99 75 40 00
	Sales	0825 004 700
	Fax	0825 004 701
	Fax (calls from outside of France)	04 99 75 40 01
	<b>Corporate</b>	
	Technical Support	0825 004 719
	Customer Care	0825 338 339
	Switchboard	01 55 94 71 00
	Sales	01 55 94 71 00
	Fax	01 55 94 71 01
Germany (Frankfurt) International Access Code: 00 Country Code: 49 City Code: 69	Website: <a href="http://support.euro.dell.com">support.euro.dell.com</a>	
	E-mail: <a href="mailto:tech_support_central_europe@dell.com">tech_support_central_europe@dell.com</a>	
	Technical Support for XPS	069 9792 7222
	Technical Support for all other Dell computers	069 9792-7200
	Home/Small Business Customer Care	0180-5-224400
	Global Segment Customer Care	069 9792-7320
	Preferred Accounts Customer Care	069 9792-7320
	Large Accounts Customer Care	069 9792-7320
	Public Accounts Customer Care	069 9792-7320
Switchboard	069 9792-7000	
Greece International Access Code: 00 Country Code: 30	Website: <a href="http://support.euro.dell.com">support.euro.dell.com</a>	
	Technical Support	00800-44 14 95 18
	Gold Service Technical Support	00800-44 14 00 83
	Switchboard	2108129810
	Gold Service Switchboard	2108129811
	Sales	2108129800
Fax	2108129812	

<b>Grenada</b>	E-mail: la-techsupport@dell.com	
	General Support	toll-free: 1-866-540-3355
<b>Guatemala</b>	E-mail: la-techsupport@dell.com	
	General Support	1-800-999-0136
<b>Guyana</b>	E-mail: la-techsupport@dell.com	
	General Support	toll-free: 1-877-270-4609
<b>Hong Kong</b>  International Access Code: <b>001</b>  Country Code: <b>852</b>	Website: support.ap.dell.com	
	Technical Support E-mail: support.dell.com.cn/email	
	Technical Support (XPS)	00852-3416 6923
	Technical Support (Dimension and Inspiron)	00852-2969 3188
	Technical Support (OptiPlex, Latitude, and Dell Precision)	00852-2969 3191
	Technical Support (servers and storage)	00852-2969 3196
	Technical Support (projectors, PDAs, switches, routers, and so on)	00852-3416 0906
	Customer Care	00852-3416 0910
	Large Corporate Accounts	00852-3416 0907
	Global Customer Programs	00852-3416 0908
Medium Business Division	00852-3416 0912	
Home and Small Business Division	00852-2969 3105	
<b>India</b>	Website: support.ap.dell.com	
	E-mail: india_support_desktop@dell.com india_support_notebook@dell.com india_support_Server@dell.com	
	Technical Support (XPS computers)	0802 506 8033 or toll-free: 1800 425 2066
	Technical Support (portables, desktops, servers, and storage)	1600338045 and 1600448046
	Sales (Large Corporate Accounts)	1600 33 8044
	Sales (Home and Small Business)	1600 33 8046
<b>Ireland (Cherrywood)</b>  International Access Code: <b>00</b>  Country Code: <b>353</b>  City Code: <b>1</b>	Website: <b>support.euro.dell.com</b>	
	E-mail: dell_direct_support@dell.com	
	<b>Sales</b>	
	Ireland Sales	01 204 4444
	Dell Outlet	1850 200 778
	Online Ordering HelpDesk	1850 200 778
	<b>Customer Care</b>	
	Home User Customer Care	01 204 4014
	Small Business Customer Care	01 204 4014
	Corporate Customer Care	1850 200 982
	<b>Technical Support</b>	
	Technical Support for XPS computers only	1850 200 722
	Technical Support for all other Dell computers	1850 543 543
	<b>General</b>	
	Fax/Sales Fax	01 204 0103
Switchboard	01 204 4444	
U.K. Customer Care (dial within U.K. only)	0870 906 0010	
Corporate Customer Care (dial within U.K. only)	0870 907 4499	
U.K. Sales (dial within U.K. only)	0870 907 4000	
<b>Italy (Milan)</b>  International Access Code: <b>00</b>  Country Code: <b>39</b>  City Code: <b>02</b>	Website: <b>support.euro.dell.com</b>	
	<b>Home and Small Business</b>	
	Technical Support	02 577 826 90
	Customer Care	02 696 821 14
	Fax	02 696 821 13
	Switchboard	02 696 821 12
	<b>Corporate</b>	
	Technical Support	02 577 826 90
	Customer Care	02 577 825 55
Fax	02 575 035 30	
Switchboard	02 577 821	

<b>Jamaica</b>	E-mail: la-techsupport@dell.com	
	General Support (dial from within Jamaica only)	1-800-440-9205
<b>Japan (Kawasaki)</b> International Access Code: <b>001</b> Country Code: <b>81</b> City Code: <b>44</b>	Website: <b>support.jp.dell.com</b>	
	Technical Support (XPS)	toll-free: 0120-937-786
	Technical Support outside of Japan (XPS)	044-520-1235
	XPS Customer Care (if ordered items are missing or have been damaged during shipment)	044-556-4240
	Technical Support (Dimension and Inspiron)	toll-free: 0120-198-226
	Technical Support outside of Japan (Dimension and Inspiron)	81-44-520-1435
	Technical Support (Dell Precision, OptiPlex, and Latitude)	toll-free: 0120-198-433
	Technical Support outside of Japan (Dell Precision, OptiPlex, and Latitude)	81-44-556-3894
	Technical Support (Dell PowerApp™, Dell PowerEdge™, Dell PowerConnect™, and Dell PowerVault™)	toll-free: 0120-198-498
	Technical Support outside of Japan (PowerApp, PowerEdge, PowerConnect, and PowerVault)	81-44-556-4162
	Technical Support (projectors, PDAs, printers, routers)	toll-free: 0120-981-690
	Technical Support outside of Japan (projectors, PDAs, printers, routers)	81-44-556-3468
	Faxbox Service	044-556-3490
	24-Hour Automated Order Status Service	044-556-3801
	Customer Care	044-556-4240
	Business Sales Division (up to 400 employees)	044-556-1465
	Preferred Accounts Division Sales (over 400 employees)	044-556-3433
	Public Sales (government agencies, educational institutions, and medical institutions)	044-556-5963
	Global Segment Japan	044-556-3469
	Individual User	044-556-1760
Switchboard	044-556-4300	
<b>Korea (Seoul)</b> International Access Code: <b>001</b> Country Code: <b>82</b> City Code: <b>2</b>	E-mail: krsupport@dell.com	
	Support	toll-free: 080-200-3800
	Technical Support (XPS)	toll-free: 080-999-0283
	Support (Dimension, PDA, Electronics, and Accessories)	toll-free: 080-200-3801
	Sales	toll-free: 080-200-3600
	Fax	2194-6202
<b>Latin America</b>	Switchboard	2194-6000
	Customer Technical Support (Austin, Texas, U.S.A.)	512 728-4093
	Customer Service (Austin, Texas, U.S.A.)	512 728-3619
	Fax (Technical Support and Customer Service) (Austin, Texas, U.S.A.)	512 728-3883
	Sales (Austin, Texas, U.S.A.)	512 728-4397
	SalesFax (Austin, Texas, U.S.A.)	512 728-4600 or 512 728-3772
<b>Luxembourg</b> International Access Code: <b>00</b> Country Code: <b>352</b>	Website: <b>support.euro.dell.com</b>	
	Support	342 08 08 075
	Home/Small Business Sales	+32 (0)2 713 15 96
	Corporate Sales	26 25 77 81
	Customer Care	+32 (0)2 481 91 19
<b>Macao</b> Country Code: <b>853</b>	Fax	26 25 77 82
	Technical Support	toll-free: 0800 105
	Customer Service (Xiamen, China)	34 160 910
<b>Malaysia (Penang)</b> International Access Code: <b>00</b> Country Code: <b>60</b> City Code: <b>4</b>	Transaction Sales (Xiamen, China)	29 693 115
	Website: <b>support.ap.dell.com</b>	
	Technical Support (XPS)	toll-free: 1800 885 784
	Technical Support (Dell Precision, OptiPlex, and Latitude)	toll-free: 1 800 880 193
	Technical Support (Dimension, Inspiron, and Electronics and Accessories)	toll-free: 1 800 881 306
	Technical Support (PowerApp, PowerEdge, PowerConnect, and PowerVault)	toll-free: 1800 881 386
	Customer Care	toll-free: 1800 881 306 (option 6)
	Transaction Sales	toll-free: 1 800 888 202
	Corporate Sales	toll-free: 1 800 888 213
	E-mail: la-techsupport@dell.com	
	Customer Technical Support	001-877-384-8979 or 001-877-269-3383

<b>Mexico</b> International Access Code: <b>00</b> Country Code: <b>52</b>	Sales	50-81-8800 or 01-800-888-3355
	Customer Service	001-877-384-8979 or 001-877-269-3383
	Main	50-81-8800 or 01-800-888-3355
<b>Montserrat</b>	E-mail: la-techsupport@dell.com General Support	toll-free: 1-866-278-6822
<b>Netherlands Antilles</b>	E-mail: la-techsupport@dell.com General Support	001-800-882-1519
<b>Netherlands (Amsterdam)</b> International Access Code: <b>00</b> Country Code: <b>31</b> City Code: <b>20</b>	Website: <b>support.euro.dell.com</b>	
	Technical Support for XPS	020 674 45 94
	Technical Support for all other Dell computers	020 674 45 00
	Technical Support Fax	020 674 47 66
	Home/Small Business Customer Care	020 674 42 00
	Relational Customer Care	020 674 4325
	Home/Small Business Sales	020 674 55 00
	Relational Sales	020 674 50 00
	Home/Small Business Sales Fax	020 674 47 75
	Relational Sales Fax	020 674 47 50
Switchboard	020 674 50 00	
Switchboard Fax	020 674 47 50	
<b>New Zealand</b> International Access Code: <b>00</b> Country Code: <b>64</b>	Website: <b>support.ap.dell.com</b>	
	E-mail: support.ap.dell.com/contactus Technical Support (XPS)	toll-free: 0800 335 540
	General Support	0800 441 567
<b>Nicaragua</b>	E-mail: la-techsupport@dell.com General Support	001-800-220-1377
<b>Norway (Lysaker)</b> International Access Code: <b>00</b> Country Code: <b>47</b>	Website: <b>support.euro.dell.com</b>	
	Technical Support for XPS	815 35 043
	Technical Support for all other Dell products	671 16882
	Relational Customer Care	671 17575
	Home/Small Business Customer Care	23162298
	Switchboard	671 16800
Fax Switchboard	671 16865	
<b>Panama</b>	E-mail: la-techsupport@dell.com General Support	011-800-507-1264
<b>Peru</b>	E-mail: la-techsupport@dell.com General Support	0800-50-669
<b>Poland (Warsaw)</b> International Access Code: <b>011</b> Country Code: <b>48</b> City Code: <b>22</b>	Website: <b>support.euro.dell.com</b>	
	E-mail: pl_support_tech@dell.com	
	Customer Service Phone	57 95 700
	Customer Care	57 95 999
	Sales	57 95 999
	Customer Service Fax	57 95 806
	Reception Desk Fax	57 95 998
Switchboard	57 95 999	
<b>Portugal</b> International Access Code: <b>00</b> Country Code: <b>351</b>	Website: <b>support.euro.dell.com</b>	
	Technical Support	707200149
	Customer Care	800 300 413
	Sales	800 300 410 or 800 300 411 or 800 300 412 or 21 422 07 10
Fax	21 424 01 12	
<b>Puerto Rico</b>	E-mail: la-techsupport@dell.com General Support	1-877-537-3355
<b>St. Kitts and Nevis</b>	Website: <b>www.dell.com/kn</b>	
	E-mail: la-techsupport@dell.com General Support	toll-free: 1-866-540-3355

St. Lucia	Website: <a href="http://www.dell.com/lc">www.dell.com/lc</a>	
	E-mail: <a href="mailto:la-techsupport@dell.com">la-techsupport@dell.com</a>	
	General Support	toll-free: 1-866-464-4352
St. Vincent and the Grenadines	Website: <a href="http://www.dell.com/vc">www.dell.com/vc</a>	
	E-mail: <a href="mailto:la-techsupport@dell.com">la-techsupport@dell.com</a>	
	General Support	toll-free: 1-866-464-4353
Singapore (Singapore) International Access Code: 005 Country Code: 65	<b>NOTE:</b> The phone numbers in this section should be called from within Singapore or Malaysia only.	
	Website: <a href="http://support.ap.dell.com">support.ap.dell.com</a>	
	Technical Support (XPS)	toll-free: 1800 394 7464
	Technical Support (Dimension, Inspiron, and Electronics and Accessories)	toll-free: 1 800 394 7430
	Technical Support (OptiPlex, Latitude, and Dell Precision)	toll-free: 1 800 394 7488
	Technical Support (PowerApp, PowerEdge, PowerConnect, and PowerVault)	toll-free: 1 800 394 7478
	Customer Care	toll-free: 1 800 394 7430 (option 6)
	Transaction Sales	toll-free: 1 800 394 7412
Slovakia (Prague) International Access Code: 00 Country Code: 421	Corporate Sales	toll-free: 1 800 394 7419
	Website: <a href="http://support.euro.dell.com">support.euro.dell.com</a>	
	E-mail: <a href="mailto:czech_dell@dell.com">czech_dell@dell.com</a>	
	Technical Support	02 5441 5727
	Customer Care	420 22537 2707
	Fax	02 5441 8328
South Africa (Johannesburg) International Access Code: 09/091 Country Code: 27 City Code: 11	Tech Fax	02 5441 8328
	Switchboard (Sales)	02 5441 7585
	Website: <a href="http://support.euro.dell.com">support.euro.dell.com</a>	
	E-mail: <a href="mailto:dell_za_support@dell.com">dell_za_support@dell.com</a>	
	Gold Queue	011 709 7713
	Technical Support	011 709 7710
	Customer Care	011 709 7707
Southeast Asian and Pacific Countries	Sales	011 709 7700
	Fax	011 706 0495
	Switchboard	011 709 7700
	Technical Support, Customer Service, and Sales (Penang, Malaysia)	604 633 4810
	Website: <a href="http://support.euro.dell.com">support.euro.dell.com</a>	
	<b>Home and Small Business</b>	
	Technical Support	902 100 130
Spain (Madrid) International Access Code: 00 Country Code: 34 City Code: 91	Customer Care	902 118 540
	Sales	902 118 541
	Switchboard	902 118 541
	Fax	902 118 539
	<b>Corporate</b>	
	Technical Support	902 100 130
	Customer Care	902 115 236
	Switchboard	91 722 92 00
	Fax	91 722 95 83
	Sweden (Upplands Vasby) International Access Code: 00 Country Code: 46 City Code: 8	Website: <a href="http://support.euro.dell.com">support.euro.dell.com</a>
Technical Support for XPS		0771 340 340
Technical Support for all other Dell products		08 590 05 199
Relational Customer Care		08 590 05 642
Home/Small Business Customer Care		08 587 70 527
Employee Purchase Program (EPP) Support		020 140 14 44
Technical Support Fax		08 590 05 594
Switzerland (Geneva) International Access Code: 00	Sales	08 590 05 185
	Website: <a href="http://support.euro.dell.com">support.euro.dell.com</a>	
	E-mail: <a href="mailto:Tech_support_central_Europe@dell.com">Tech_support_central_Europe@dell.com</a>	
	Technical Support for XPS	0848 33 88 57
Technical Support (Home and Small Business) for all other Dell products	0844 811 411	
	Technical Support (Corporate)	0844 822 844

Country Code: <b>41</b> City Code: <b>22</b>	Customer Care (Home and Small Business)	0848 802 202
	Customer Care (Corporate)	0848 821 721
	Fax	022 799 01 90
	Switchboard	022 799 01 01
Taiwan International Access Code: <b>002</b> Country Code: <b>886</b>	Website: <b>support.ap.dell.com</b>	
	E-mail: support.dell.com.cn/email	
	Technical Support (XPS)	toll-free: 0080 186 3085
	Technical Support (OptiPlex, Latitude, Inspiron, Dimension, and Electronics and Accessories)	toll-free: 0080 186 1011
	Technical Support (servers and storage)	toll-free: 0080 160 1256
	Customer Care	toll-free: 0080 160 1250 (option 5)
	Transaction Sales	toll-free: 0080 165 1228
Thailand International Access Code: <b>001</b> Country Code: <b>66</b>	Corporate Sales	toll-free: 0080 165 1227
	Website: <b>support.ap.dell.com</b>	
	Technical Support (OptiPlex, Latitude, and Dell Precision)	toll-free: 1800 0060 07
	Technical Support (PowerApp, PowerEdge, PowerConnect, and PowerVault)	toll-free: 1800 0600 09
	Customer Care	toll-free: 1800 006 007 (option 7)
Trinidad/Tobago Country Code: <b>66</b>	Corporate Sales	toll-free: 1800 006 009
	Transaction Sales	toll-free: 1800 006 006
	Website: <b>www.dell.com/tt</b>	
Turks and Caicos Islands Country Code: <b>66</b>	E-mail: la-techsupport@dell.com	
	General Support	toll-free: 1-888-799-5908
	Website: <b>www.dell.com/tc</b>	
U.K. (Bracknell) International Access Code: <b>00</b> Country Code: <b>44</b> City Code: <b>1344</b>	E-mail: dell_direct_support@dell.com	
	Customer Care website: <b>support.euro.dell.com/uk/en/ECare/form/home.asp</b>	
	<b>Sales</b>	
	Home and Small Business Sales	0870 907 4000
	Corporate/Public Sector Sales	01344 860 456
	<b>Customer Care</b>	
	Home and Small Business Customer Care	0870 906 0010
	Corporate Customer Care	01344 373 185
	Preferred Accounts (500-5000 employees)	0870 906 0010
	Global Accounts Customer Care	01344 373 186
	Central Government Customer Care	01344 373 193
	Local Government & Education Customer Care	01344 373 199
	Health Customer Care	01344 373 194
	<b>Technical Support</b>	
	Technical Support for XPS computers only	0870 366 4180
	Technical Support (Corporate/Preferred Accounts/PCA [1000+ employees])	0870 908 0500
	Technical Support for all other products	0870 353 0800
<b>General</b>		
Home and Small Business Fax	0870 907 4006	
Uruguay Country Code: <b>598</b>	Website: <b>www.dell.com/uy</b>	
	E-mail: la-techsupport@dell.com	
	General Support	toll-free: 000-413-598-2521
Country Code: <b>1</b>	Automated Order-Status Service	toll-free: 1-800-433-9014
	AutoTech (portable and desktop computers)	toll-free: 1-800-247-9362
	Hardware and Warranty Support (Dell TV, Printers, and Projectors) for Relationship customers	toll-free: 1-877-459-7298
	Americas Consumer XPS Support	toll-free: 1-800-232-8544
	<b>Consumer (Home and Home Office) Support for all other Dell products</b>	toll-free: 1-800-624-9896
	Customer Service	toll-free: 1-800-624-9897
	Employee Purchase Program (EPP) Customers	toll-free: 1-800-695-8133
	Financial Services website: <b>www.dellfinancialservices.com</b>	

<b>U.S.A. (Austin, Texas)</b>  International Access Code: <b>011</b>  Country Code: <b>1</b>	Financial Services (lease/loans)	toll-free: 1-877-577-3355	
	Financial Services (Dell Preferred Accounts [DPA])	toll-free: 1-800-283-2210	
	<b>Business</b>		
	Customer Service and Support	toll-free: 1-800-456-3355	
	Employee Purchase Program (EPP) Customers	toll-free: 1-800-695-8133	
	Support for printers, projectors, PDAs, and MP3 players	toll-free: 1-877-459-7298	
	<b>Public (government, education, and healthcare)</b>		
	Customer Service and Support	toll-free: 1-800-456-3355	
	Employee Purchase Program (EPP) Customers	toll-free: 1-800-695-8133	
	Dell Sales	toll-free: 1-800-289-3355 or toll-free: 1-800-879-3355	
	Dell Outlet Store (Dell refurbished computers)	toll-free: 1-888-798-7561	
	Software and Peripherals Sales	toll-free: 1-800-671-3355	
	Spare Parts Sales	toll-free: 1-800-357-3355	
	Extended Service and Warranty Sales	toll-free: 1-800-247-4618	
	Fax	toll-free: 1-800-727-8320	
	Dell Services for the Deaf, Hard-of-Hearing, or Speech-Impaired	toll-free: 1-877-DELLTTY (1-877-335-5889)	
	<b>U.S. Virgin Islands</b>	E-mail: la-techsupport@dell.com	
		General Support	toll-free: 1-877-702-4360
	<b>Venezuela</b>	Website: <a href="http://www.dell.com/ve">www.dell.com/ve</a>	
		E-mail: la-techsupport@dell.com	
	General Support	0800-100-4752	

[Back to Contents Page](#)



**Dell™ XPS™ 710 Owner's Manual**

● [Finding Information](#)

## Finding Information

 **NOTE:** Some features or media may be optional and may not ship with your computer. Some features or media may not be available in certain countries.

 **NOTE:** Additional information may ship with your computer.

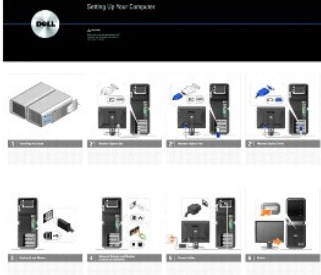
What Are You Looking For?	Find It Here
<ul style="list-style-type: none"> <li>1 A diagnostic program for my computer</li> <li>1 Drivers for my computer</li> <li>1 My device documentation</li> <li>1 Desktop System Software (DSS)</li> </ul>	<p><b>Drivers and Utilities CD (ResourceCD)</b></p> <p>Documentation and drivers are already installed on your computer. You can use the <i>Drivers and Utilities</i> CD to reinstall drivers (see <a href="#">Reinstalling Drivers</a>), access your documentation or run the Dell Diagnostics (see <a href="#">Dell Diagnostics</a>).</p>  <p>Readme files may also be included on your CD to provide last-minute updates about technical changes to your computer or advanced technical reference material for technicians and experienced users.</p> <p><b>NOTE:</b> Drivers and documentation updates can be found at <a href="http://support.dell.com">support.dell.com</a>.</p>
<ul style="list-style-type: none"> <li>1 Warranty information</li> <li>1 Terms and Conditions (U.S. only)</li> <li>1 Safety instructions</li> <li>1 Regulatory information</li> <li>1 Ergonomics information</li> <li>1 End User License Agreement</li> </ul>	<p><b>Dell™ Product Information Guide</b></p> 
<ul style="list-style-type: none"> <li>1 How to set up my computer</li> </ul>	<p><b>Setup Diagram</b></p> 
<ul style="list-style-type: none"> <li>1 Service Tag and Express Service Code</li> <li>1 Microsoft® Windows® Product Key Label</li> </ul>	<p><b>Service Tag and Microsoft Windows Product Key</b></p> <p>These labels are located on your computer.</p>





Use the Service Tag to identify your computer when you use [support.dell.com](http://support.dell.com) or contact support.

- 1 Enter the Express Service Code to direct your call when contacting support.

- 1 Solutions — Troubleshooting hints and tips, articles from technicians, online courses, and frequently asked questions
- 1 Community — Online discussion with other Dell customers
- 1 Upgrades — Upgrade information for components, such as the memory, hard drive, and operating system
- 1 Customer Care — Contact information, service call and order status, and warranty and repair information
- 1 Service and Support — Service call status, support history, service contract, and online discussions with support
- 1 Reference — Computer documentation, details on my computer configuration, product specifications, and white papers
- 1 Downloads — Certified drivers, patches, and software updates
- 1 Desktop System Software (DSS)— If you reinstall the operating system on your computer, you should also reinstall the DSS utility. DSS automatically detects your computer and operating system and installs the updates appropriate for your configuration, providing critical updates for your operating system and support for Dell™ 3.5-inch USB floppy drives, Intel® Pentium® M processors, optical drives, and USB devices. DSS is necessary for correct operation of your Dell computer.

#### Dell Support Website — [support.dell.com](http://support.dell.com)

**NOTE:** Select your region or business segment to view the appropriate support site.

To download Desktop System Software:

1. Go to [support.dell.com](http://support.dell.com), select your business segment, and then enter your Service Tag or product model.
2. Select **Drivers & Downloads**, and then click **Go**.
3. Select your operating system and language, and then search for the keyword *Desktop System Software*.

**NOTE:** The [support.dell.com](http://support.dell.com) user interface may vary depending on your selections.

- 1 How to use Windows XP
- 1 How to work with programs and files
- 1 How to personalize my desktop

#### Windows Help and Support Center

1. Click **Start**→ **Help and Support**.
2. Type a word or phrase that describes your problem, and then click the arrow icon.
3. Click the topic that describes your problem.
4. Follow the instructions on the screen.

- 1 How to reinstall my operating system

#### Operating System CD

The operating system is already installed on your computer. To reinstall your operating system, use the *Operating System* CD (see [Reinstalling Microsoft® Windows® XP](#)).

After you reinstall the operating system, use the *Drivers and Utilities* CD to reinstall drivers for the devices that came with your computer.



[The operating system product key label is located on your computer.](#)

**NOTE:** The color of your *Operating System* CD varies according to the operating system you ordered.

---

[Back to Contents Page](#)

## Glossary

### Dell™ XPS™ 710 Owner's Manual

Terms in this Glossary are provided for informational purposes only and may or may not describe features included with your particular computer.

---

#### A

**AC** — alternating current — The form of electricity that powers your computer when you plug the AC adapter power cable in to an electrical outlet.

**ACPI** — advanced configuration and power interface — A power management specification that enables Microsoft® Windows® operating systems to put a computer in standby or hibernate mode to conserve the amount of electrical power allocated to each device attached to the computer.

**AGP** — accelerated graphics port — A dedicated graphics port that allows system memory to be used for video-related tasks. AGP delivers a smooth, true-color video image because of the faster interface between the video circuitry and the computer memory.

**ALS** — ambient light sensor.

**antivirus software** — A program designed to identify, quarantine, and/or delete viruses from your computer.

**APR** — advanced port replicator — A docking device that allows you to conveniently use an external monitor, keyboard, mouse, and other devices with your portable computer.

**ASF** — alert standards format — A standard to define a mechanism for reporting hardware and software alerts to a management console. ASF is designed to be platform- and operating system-independent.

---

#### B

**backup** — A copy of a program or data file on a floppy, CD, DVD, or hard drive. As a precaution, back up the data files from your hard drive regularly.

**battery** — A rechargeable internal power source used to operate portable computers when not connected to an AC adapter and an electrical outlet.

**battery life span** — The length of time (years) during which a portable computer battery is able to be depleted and recharged.

**battery operating time** — The length of time (minutes or hours) that a portable computer battery powers the computer.

**BIOS** — basic input/output system — A program (or utility) that serves as an interface between the computer hardware and the operating system. Unless you understand what effect these settings have on the computer, do not change them. Also referred to as *system setup*.

**bit** — The smallest unit of data interpreted by your computer.

**Bluetooth® wireless technology** — A wireless technology standard for short-range (9 m [29 feet]) networking devices that allows for enabled devices to automatically recognize each other.

**boot sequence** — Specifies the order of the devices from which the computer attempts to boot.

**bootable CD** — A CD that you can use to start your computer. In case your hard drive is damaged or your computer has a virus, ensure that you always have a bootable CD or floppy disk available. Your *Drivers and Utilities* or *ResourceCD* is a bootable CD.

**bootable disk** — A disk that you can use to start your computer. In case your hard drive is damaged or your computer has a virus, ensure that you always have a bootable CD or floppy disk available.

**bps** — bits per second — The standard unit for measuring data transmission speed.

**BTU** — British thermal unit — A measurement of heat output.

**bus** — A communication pathway between the components in your computer.

**bus speed** — The speed, given in MHz, that indicates how fast a bus can transfer information.

**byte** — The basic data unit used by your computer. A byte is usually equal to 8 bits.

---

#### C

**C** — Celsius — A temperature measurement scale where 0° is the freezing point and 100° is the boiling point of water.

**cache** — A special high-speed storage mechanism which can be either a reserved section of main memory or an independent high-speed storage device. The cache enhances the efficiency of many processor operations.

**L1 cache** — Primary cache stored inside the processor.

**L2 cache** — Secondary cache which can either be external to the processor or incorporated into the processor architecture.

**carnet** — An international customs document that facilitates temporary imports into foreign countries. Also known as a *merchandise passport*.

**CD** — compact disc — An optical form of storage media, typically used for audio and software programs.

**CD drive** — A drive that uses optical technology to read data from CDs.

**CD player** — The software used to play music CDs. The CD player displays a window with buttons that you use to play a CD.

**CD-R** — CD recordable — A recordable version of a CD. Data can be recorded only once onto a CD-R. Once recorded, the data cannot be erased or written over.

**CD-RW** — CD rewritable — A rewritable version of a CD. Data can be written to a CD-RW disc, and then erased and written over (rewritten).

**CD-RW drive** — A drive that can read CDs and write to CD-RW (rewritable CDs) and CD-R (recordable CDs) discs. You can write to CD-RW discs multiple times, but you can write to CD-R discs only once.

**CD-RW/DVD drive** — A drive, sometimes referred to as a combo drive, that can read CDs and DVDs and write to CD-RW (rewritable CDs) and CD-R (recordable CDs) discs. You can write to CD-RW discs multiple times, but you can write to CD-R discs only once.

**clock speed** — The speed, given in MHz, that indicates how fast computer components that are connected to the system bus operate.

**COA** — Certificate of Authenticity — The Windows alpha-numeric code located on a sticker on your computer. Also referred to as the *Product Key* or *Product ID*.

**Control Panel** — A Windows utility that allows you to modify operating system and hardware settings, such as display settings.

**controller** — A chip that controls the transfer of data between the processor and memory or between the processor and devices.

**CRIMM** — continuity rambus in-line memory module — A special module that has no memory chips and is used to fill unused RIMM slots.

**cursor** — The marker on a display or screen that shows where the next keyboard, touch pad, or mouse action will occur. It often is a blinking solid line, an underline character, or a small arrow.

---

## D

**DDR SDRAM** — double-data-rate SDRAM — A type of SDRAM that doubles the data burst cycle, improving system performance.

**DDR2 SDRAM** — double-data-rate 2 SDRAM — A type of DDR SDRAM that uses a 4-bit prefetch and other architectural changes to boost memory speed to over 400 MHz.

**device** — Hardware such as a disk drive, printer, or keyboard that is installed in or connected to your computer.

**device driver** — See *driver*.

**DIN connector** — A round, six-pin connector that conforms to DIN (Deutsche Industrie-Norm) standards; it is typically used to connect PS/2 keyboard or mouse cable connectors.

**disk striping** — A technique for spreading data over multiple disk drives. Disk striping can speed up operations that retrieve data from disk storage. Computers that use disk striping generally allow the user to select the data unit size or stripe width.

**DMA** — direct memory access — A channel that allows certain types of data transfer between RAM and a device to bypass the processor.

**docking device** — See *APR*.

**DMTF** — Distributed Management Task Force — A consortium of hardware and software companies who develop management standards for distributed desktop, network, enterprise, and Internet environments.

**domain** — A group of computers, programs, and devices on a network that are administered as a unit with common rules and procedures for use by a specific group of users. A user logs on to the domain to gain access to the resources.

**DRAM** — dynamic random-access memory — Memory that stores information in integrated circuits containing capacitors.

**driver** — Software that allows the operating system to control a device such as a printer. Many devices do not work properly if the correct driver is not installed in the computer.

**DSL** — Digital Subscriber Line — A technology that provides a constant, high-speed Internet connection through an analog telephone line.

**dual display mode** — A display setting that allows you to use a second monitor as an extension of your display. Also referred to as *extended display mode*.

**DVD** — digital versatile disc — A high-capacity disc usually used to store movies. DVD drives read most CD media as well.

**DVD drive** — A drive that uses optical technology to read data from DVDs and CDs.

**DVD player** — The software used to watch DVD movies. The DVD player displays a window with buttons that you use to watch a movie.

**DVD-R** — DVD recordable — A recordable version of a DVD. Data can be recorded only once onto a DVD-R. Once recorded, the data cannot be erased or written over.

**DVD+RW** — DVD rewritable — A rewritable version of a DVD. Data can be written to a DVD+RW disc, and then erased and written over (rewritten). (DVD+RW technology is different from DVD-RW technology.)

**DVD+RW drive** — drive that can read DVDs and most CD media and write to DVD+RW (rewritable DVDs) discs.

**DVI** — digital video interface — A standard for digital transmission between a computer and a digital video display.

---

## E

- ECC** — error checking and correction — A type of memory that includes special circuitry for testing the accuracy of data as it passes in and out of memory.
- ECP** — extended capabilities port — A parallel connector design that provides improved bidirectional data transmission. Similar to EPP, ECP uses direct memory access to transfer data and often improves performance.
- EIDE** — enhanced integrated device electronics — An improved version of the IDE interface for hard drives and CD drives.
- EMI** — electromagnetic interference — Electrical interference caused by electromagnetic radiation.
- ENERGY STAR®** — Environmental Protection Agency requirements that decrease the overall consumption of electricity.
- EPP** — enhanced parallel port — A parallel connector design that provides bidirectional data transmission.
- ESD** — electrostatic discharge — A rapid discharge of static electricity. ESD can damage integrated circuits found in computer and communications equipment.
- expansion card** — A circuit board that installs in an expansion slot on the system board in some computers, expanding the capabilities of the computer. Examples include video, modem, and sound cards.
- expansion slot** — A connector on the system board (in some computers) where you insert an expansion card, connecting it to the system bus.
- ExpressCard** — A removable I/O card adhering to the PCMCIA standard. Modems and network adapters are common types of ExpressCards. ExpressCards support both the PCI Express and USB 2.0 standard.
- Express Service Code** — A numeric code located on a sticker on your Dell™ computer. Use the Express Service Code when contacting Dell for assistance. Express Service Code service may not be available in some countries.
- extended display mode** — A display setting that allows you to use a second monitor as an extension of your display. Also referred to as *dual display mode*.
- extended PC Card** — A PC Card that extends beyond the edge of the PC Card slot when installed.
- 

## F

- Fahrenheit** — A temperature measurement scale where 32° is the freezing point and 212° is the boiling point of water.
- FCC** — Federal Communications Commission — A U.S. agency responsible for enforcing communications-related regulations that state how much radiation computers and other electronic equipment can emit.
- floppy** — An electromagnetic form of storage media. Also known as a floppy diskette or a floppy disk.
- floppy drive** — A disk drive that can read and write to floppy disks.
- folder** — A term used to describe space on a disk or drive where files are organized and grouped. Files in a folder can be viewed and ordered in various ways, such as alphabetically, by date, and by size.
- format** — The process that prepares a drive or disk for file storage. When a drive or disk is formatted, the existing information on it is lost.
- FSB** — front side bus — The data path and physical interface between the processor and RAM.
- FTP** — file transfer protocol — A standard Internet protocol used to exchange files between computers connected to the Internet.
- 

## G

- G** — gravity — A measurement of weight and force.
- GB** — gigabyte — A measurement of data storage that equals 1024 MB (1,073,741,824 bytes). When used to refer to hard drive storage, the term is often rounded to 1,000,000,000 bytes.
- GHz** — gigahertz — A measurement of frequency that equals one thousand million Hz, or one thousand MHz. The speeds for computer processors, buses, and interfaces are often measured in GHz.
- graphics mode** — A video mode that can be defined as x horizontal pixels by y vertical pixels by z colors. Graphics modes can display an unlimited variety of shapes and fonts.
- GUI** — graphical user interface — Software that interacts with the user by means of menus, windows, and icons. Most programs that operate on the Windows operating systems are GUIs.
- 

## H

- hard drive** — A drive that reads and writes data on a hard disk. The terms hard drive and hard disk are often used interchangeably.
- heat sink** — A metal plate on some processors that helps dissipate heat.

**help file** — A file that contains descriptive or instructional information about a product. Some help files are associated with a particular program, such as *Help* in Microsoft Word. Other help files function as stand-alone reference sources. Help files typically have a filename extension of **.hlp** or **.chm**.

**hibernate mode** — A power management mode that saves everything in memory to a reserved space on the hard drive and then turns off the computer. When you restart the computer, the memory information that was saved to the hard drive is automatically restored.

**HTML** — hypertext markup language — A set of codes inserted into an Internet web page intended for display on an Internet browser.

**HTTP** — hypertext transfer protocol — A protocol for exchanging files between computers connected to the Internet.

**Hz** — hertz — A unit of frequency measurement that equals 1 cycle per second. Computers and electronic devices are often measured in kilohertz (kHz), megahertz (MHz), gigahertz (GHz), or terahertz (THz).

---

## I

**IC** — integrated circuit — A semiconductor wafer, or chip, on which thousands or millions of tiny electronic components are fabricated for use in computer, audio, and video equipment.

**IDE** — integrated device electronics — An interface for mass storage devices in which the controller is integrated into the hard drive or CD drive.

**IEEE 1394** — Institute of Electrical and Electronics Engineers, Inc. — A high-performance serial bus used to connect IEEE 1394-compatible devices, such as digital cameras and DVD players, to the computer.

**infrared sensor** — A port that allows you to transfer data between the computer and infrared-compatible devices without using a cable connection.

**integrated** — Usually refers to components that are physically located on the computer's system board. Also referred to as *built-in*.

**I/O** — input/output — An operation or device that enters and extracts data from your computer. Keyboards and printers are I/O devices.

**I/O address** — An address in RAM that is associated with a specific device (such as a serial connector, parallel connector, or expansion slot) and allows the processor to communicate with that device.

**IrDA** — Infrared Data Association — The organization that creates international standards for infrared communications.

**IRQ** — interrupt request — An electronic pathway assigned to a specific device so that the device can communicate with the processor. Each device connection must be assigned an IRQ. Although two devices can share the same IRQ assignment, you cannot operate both devices simultaneously.

**ISP** — Internet service provider — A company that allows you to access its host server to connect directly to the Internet, send and receive e-mail, and access websites. The ISP typically provides you with a software package, user name, and access phone numbers for a fee.

---

## K

**Kb** — kilobit — A unit of data that equals 1024 bits. A measurement of the capacity of memory integrated circuits.

**KB** — kilobyte — A unit of data that equals 1024 bytes but is often referred to as 1000 bytes.

**key combination** — A command requiring you to press multiple keys at the same time.

**kHz** — kilohertz — A measurement of frequency that equals 1000 Hz.

---

## L

**LAN** — local area network — A computer network covering a small area. A LAN usually is confined to a building or a few nearby buildings. A LAN can be connected to another LAN over any distance through telephone lines and radio waves to form a wide area network (WAN).

**LCD** — liquid crystal display — The technology used by portable computer and flat-panel displays.

**LED** — light-emitting diode — An electronic component that emits light to indicate the status of the computer.

**local bus** — A data bus that provides a fast throughput for devices to the processor.

**LPT** — line print terminal — The designation for a parallel connection to a printer or other parallel device.

---

## M

**Mb** — megabit — A measurement of memory chip capacity that equals 1024 Kb.

**Mbps** — megabits per second — One million bits per second. This measurement is typically used for transmission speeds for networks and modems.

**MB** — megabyte — A measurement of data storage that equals 1,048,576 bytes. 1 MB equals 1024 KB. When used to refer to hard drive storage, the term is often rounded to 1,000,000 bytes.

**MB/sec** — megabytes per second — One million bytes per second. This measurement is typically used for data transfer ratings.

**memory** — A temporary data storage area inside your computer. Because the data in memory is not permanent, it is recommended that you frequently save your files while you are working on them, and always save your files before you shut down the computer. Your computer can contain several different forms of memory, such as RAM, ROM, and video memory. Frequently, the word memory is used as a synonym for RAM.

**memory address** — A specific location where data is temporarily stored in RAM.

**memory mapping** — The process by which the computer assigns memory addresses to physical locations at start-up. Devices and software can then identify information that the processor can access.

**memory module** — A small circuit board containing memory chips, which connects to the system board.

**MHz** — megahertz — A measure of frequency that equals 1 million cycles per second. The speeds for computer processors, buses, and interfaces are often measured in MHz.

**modem** — A device that allows your computer to communicate with other computers over analog telephone lines. Three types of modems include: external, PC Card, and internal. You typically use your modem to connect to the Internet and exchange e-mail.

**module bay** — A bay that supports devices such as optical drives, a second battery, or a Dell TravelLite™ module.

**monitor** — The high-resolution TV-like device that displays computer output.

**mouse** — A pointing device that controls the movement of the cursor on your screen. Typically you roll the mouse over a hard, flat surface to move the pointer or cursor on your screen.

**ms** — millisecond — A measure of time that equals one thousandth of a second. Access times of storage devices are often measured in ms.

---

## N

**network adapter** — A chip that provides network capabilities. A computer may include a network adapter on its system board, or it may contain a PC Card with an adapter on it. A network adapter is also referred to as a *NIC* (network interface controller).

**NIC** — See *network adapter*.

**notification area** — The section of the Windows taskbar that contains icons for providing quick access to programs and computer functions, such as the clock, volume control, and print status. Also referred to as *system tray*.

**ns** — nanosecond — A measure of time that equals one billionth of a second.

**NVRAM** — nonvolatile random access memory — A type of memory that stores data when the computer is turned off or loses its external power source. NVRAM is used for maintaining computer configuration information such as date, time, and other system setup options that you can set.

---

## O

**optical drive** — A drive that uses optical technology to read or write data from CDs, DVDs, or DVD+RWs. Example of optical drives include CD drives, DVD drives, CD-RW drives, and CD-RW/DVD combo drives.

---

## P

**parallel connector** — An I/O port often used to connect a parallel printer to your computer. Also referred to as an *LPT port*.

**partition** — A physical storage area on a hard drive that is assigned to one or more logical storage areas known as logical drives. Each partition can contain multiple logical drives.

**PC Card** — A removable I/O card adhering to the PCMCIA standard. Modems and network adapters are common types of PC Cards.

**PCI** — peripheral component interconnect — PCI is a local bus that supports 32-and 64-bit data paths, providing a high-speed data path between the processor and devices such as video, drives, and networks.

**PCI Express** — A modification to the PCI interface that boosts the data transfer rate between the processor and the devices attached to it. PCI Express can transfer data at speeds from 250 MB/sec to 4 GB/sec. If the PCI Express chip set and the device are capable of different speeds, they will operate at the slower speed.

**PCMCIA** — Personal Computer Memory Card International Association — The organization that establishes standards for PC Cards.

**PIN** — personal identification number — A sequence of numerals and/or letters used to restrict unauthorized access to computer networks and other secure systems.

**PIO** — programmed input/output — A method of transferring data between two devices through the processor as part of the data path.

**pixel** — A single point on a display screen. Pixels are arranged in rows and columns to create an image. A video resolution, such as 800 x 600, is expressed as the number of pixels across by the number of pixels up and down.

**Plug-and-Play** — The ability of the computer to automatically configure devices. Plug and Play provides automatic installation, configuration, and compatibility with existing hardware if the BIOS, operating system, and all devices are Plug and Play compliant.

**POST** — power-on self-test — Diagnostics programs, loaded automatically by the BIOS, that perform basic tests on the major computer components, such as memory, hard drives, and video. If no problems are detected during POST, the computer continues the start-up.

**processor** — A computer chip that interprets and executes program instructions. Sometimes the processor is referred to as the CPU (central processing unit).

**program** — Any software that processes data for you, including spreadsheet, word processor, database, and game packages. Programs require an operating system to run.

**PS/2** — personal system/2 — A type of connector for attaching a PS/2-compatible keyboard, mouse, or keypad.

**PXE** — pre-boot execution environment — A WfM (Wired for Management) standard that allows networked computers that do not have an operating system to be configured and started remotely.

---

## R

**RAID** — redundant array of independent disks — A method of providing data redundancy. Some common implementations of RAID include RAID 0, RAID 1, RAID 5, RAID 10, and RAID 50.

**RAM** — random-access memory — The primary temporary storage area for program instructions and data. Any information stored in RAM is lost when you shut down your computer.

**readme file** — A text file included with a software package or hardware product. Typically, readme files provide installation information and describe new product enhancements or corrections that have not yet been documented.

**read-only** — Data and/or files you can view but cannot edit or delete. A file can have read-only status if:

- o It resides on a physically write-protected floppy disk, CD, or DVD.
- o It is located on a network in a directory and the system administrator has assigned rights only to specific individuals.

**refresh rate** — The frequency, measured in Hz, at which your screen's horizontal lines are recharged (sometimes also referred to as its *vertical frequency*). The higher the refresh rate, the less video flicker can be seen by the human eye.

**resolution** — The sharpness and clarity of an image produced by a printer or displayed on a monitor. The higher the resolution, the sharper the image.

**RFI** — radio frequency interference — Interference that is generated at typical radio frequencies, in the range of 10 kHz to 100,000 MHz. Radio frequencies are at the lower end of the electromagnetic frequency spectrum and are more likely to have interference than the higher frequency radiations, such as infrared and light.

**ROM** — read-only memory — Memory that stores data and programs that cannot be deleted or written to by the computer. ROM, unlike RAM, retains its contents after you shut down your computer. Some programs essential to the operation of your computer reside in ROM.

**RPM** — revolutions per minute — The number of rotations that occur per minute. Hard drive speed is often measured in rpm.

**RTC** — real time clock — Battery-powered clock on the system board that keeps the date and time after you shut down the computer.

**RTCST** — real-time clock reset — A jumper on the system board of some computers that can often be used for troubleshooting problems.

---

## S

**ScanDisk** — A Microsoft utility that checks files, folders, and the hard disk's surface for errors. ScanDisk often runs when you restart the computer after it has stopped responding.

**SDRAM** — synchronous dynamic random-access memory — A type of DRAM that is synchronized with the optimal clock speed of the processor.

**serial connector** — An I/O port often used to connect devices such as a handheld digital device or digital camera to your computer.

**Service Tag** — A bar code label on your computer that identifies your computer when you access Dell Support at [support.dell.com](http://support.dell.com) or when you call Dell for customer service or technical support.

**setup program** — A program that is used to install and configure hardware and software. The **setup.exe** or **install.exe** program comes with most Windows software packages. *Setup program* differs from *system setup*.

**shortcut** — An icon that provides quick access to frequently used programs, files, folders, and drives. When you place a shortcut on your Windows desktop and double-click the icon, you can open its corresponding folder or file without having to find it first. Shortcut icons do not change the location of files. If you delete a shortcut, the original file is not affected. Also, you can rename a shortcut icon.

**shutdown** — The process of closing windows and exiting programs, exiting the operating system, and turning off your computer. You can lose data if you turn off your computer before completing a shutdown.

**smart card** — A card that is embedded with a processor and a memory chip. Smart cards can be used to authenticate a user on computers equipped for smart cards.

**software** — Anything that can be stored electronically, such as computer files or programs.

**S/PDIF** — Sony/Philips Digital Interface — An audio transfer file format that allows the transfer of audio from one file to another without converting it to and from an analog format, which could degrade the quality of the file.

**standby mode** — A power management mode that shuts down all unnecessary computer operations to save energy.

**Strike Zone™** — Reinforced area of the platform base that protects the hard drive by acting as a dampening device when a computer experiences resonating shock or is dropped (whether the computer is on or off).

**surge protectors** — Prevent voltage spikes, such as those that may occur during an electrical storm, from entering the computer through the electrical outlet. Surge protectors do not protect against lightning strikes or against brownouts, which occur when the voltage drops more than 20 percent below the normal AC-line voltage level.



Network connections cannot be protected by surge protectors. Always disconnect the network cable from the network connector during electrical storms.

**SIM** — Subscriber Identity Module. A SIM card contains a microchip that encrypts voice and data transmissions. SIM cards can be used in phones or portable computers.

**SVGA** — super-video graphics array — A video standard for video cards and controllers. Typical SVGA resolutions are 800 x 600 and 1024 x 768.

The number of colors and resolution that a program displays depends on the capabilities of the monitor, the video controller and its drivers, and the amount of video memory installed in the computer.

**S-video TV-out** — A connector used to attach a TV or digital audio device to the computer.

**SXGA** — super-extended graphics array — A video standard for video cards and controllers that supports resolutions up to 1280 x 1024.

**SXGA+** — super-extended graphics array plus — A video standard for video cards and controllers that supports resolutions up to 1400 x 1050.

**system board** — The main circuit board in your computer. Also known as the *motherboard*.

**system setup** — A utility that serves as an interface between the computer hardware and the operating system. System setup allows you to configure user-selectable options in the BIOS, such as date and time or system password. Unless you understand what effect the settings have on the computer, do not change the settings for this program.

**system tray** — See *notification area*.

---

## T

**TAPI** — telephony application programming interface — Enables Windows programs to operate with a wide variety of telephony devices, including voice, data, fax, and video.

**text editor** — A program used to create and edit files that contain only text; for example, Windows Notepad uses a text editor. Text editors do not usually provide word wrap or formatting functionality (the option to underline, change fonts, and so on).

**travel module** — A plastic device designed to fit inside the module bay of a portable computer to reduce the weight of the computer.

---

## U

**UMA** — unified memory allocation — System memory dynamically allocated to video.

**UPS** — uninterruptible power supply — A backup power source used when the electrical power fails or drops to an unacceptable voltage level. A UPS keeps a computer running for a limited amount of time when there is no electrical power. UPS systems typically provide surge suppression and may also provide voltage regulation. Small UPS systems provide battery power for a few minutes to enable you to shut down your computer.

**USB** — universal serial bus — A hardware interface for a low-speed device such as a USB-compatible keyboard, mouse, joystick, scanner, set of speakers, printer, broadband devices (DSL and cable modems), imaging devices, or storage devices. Devices are plugged directly in to a 4-pin socket on your computer or in to a multi-port hub that plugs in to your computer. USB devices can be connected and disconnected while the computer is turned on, and they can also be daisy-chained together.

**UTP** — unshielded twisted pair — Describes a type of cable used in most telephone networks and some computer networks. Pairs of unshielded wires are twisted to protect against electromagnetic interference, rather than relying on a metal sheath around each pair of wires to protect against interference.

**UXGA** — ultra extended graphics array — A video standard for video cards and controllers that supports resolutions up to 1600 x 1200.

---

## V

**video controller** — The circuitry on a video card or on the system board (in computers with an integrated video controller) that provides the video capabilities—in combination with the monitor—for your computer.

**video memory** — Memory that consists of memory chips dedicated to video functions. Video memory is usually faster than system memory. The amount of video memory installed primarily influences the number of colors that a program can display.

**video mode** — A mode that describes how text and graphics are displayed on a monitor. Graphics-based software, such as Windows operating systems, displays in video modes that can be defined as *x* horizontal pixels by *y* vertical pixels by *z* colors. Character-based software, such as text editors, displays in video modes that can be defined as *x* columns by *y* rows of characters.

**video resolution** — See *resolution*.

**virus** — A program that is designed to inconvenience you or to destroy data stored on your computer. A virus program moves from one computer to another through an infected disk, software downloaded from the Internet, or e-mail attachments. When an infected program starts, its embedded virus also starts.

A common type of virus is a boot virus, which is stored in the boot sectors of a floppy disk. If the floppy disk is left in the drive when the computer is shut down and then turned on, the computer is infected when it reads the boot sectors of the floppy disk expecting to find the operating system. If the computer is infected, the boot virus may replicate itself onto all the floppy disks that are read or written in that computer until the virus is eradicated.

**V** — volt — The measurement of electric potential or electromotive force. One V appears across a resistance of 1 ohm when a current of 1 ampere flows through that resistance.

---

## W

**W** — watt — The measurement of electrical power. One W is 1 ampere of current flowing at 1 volt.

**WHr** — watt-hour — A unit of measure commonly used to indicate the approximate capacity of a battery. For example, a 66-WHr battery can supply 66 W of power for 1 hour or 33 W for 2 hours.

**wallpaper** — The background pattern or picture on the Windows desktop. Change your wallpaper through the Windows Control Panel. You can also scan in your favorite picture and make it wallpaper.

**WLAN** — wireless local area network. A series of interconnected computers that communicate with each other over the air waves using access points or wireless routers to provide Internet access.

**write-protected** — Files or media that cannot be changed. Use write-protection when you want to protect data from being changed or destroyed. To write-protect a 3.5-inch floppy disk, slide its write-protect tab to the open position.

**WWAN** — wireless wide area network. A wireless high-speed data network using cellular technology and covering a much larger geographic area than WLAN.

**WXGA** — wide-aspect extended graphics array — A video standard for video cards and controllers that supports resolutions up to 1280 x 800."

---

## X

**XGA** — extended graphics array — A video standard for video cards and controllers that supports resolutions up to 1024 x 768.

---

## Z

**ZIF** — zero insertion force — A type of socket or connector that allows a computer chip to be installed or removed with no stress applied to either the chip or its socket.

**Zip** — A popular data compression format. Files that have been compressed with the Zip format are called Zip files and usually have a filename extension of **.zip**. A special kind of zipped file is a self-extracting file, which has a filename extension of **.exe**. You can unzip a self-extracting file by double-clicking it.

**Zip drive** — A high-capacity floppy drive developed by Iomega Corporation that uses 3.5-inch removable disks called Zip disks. Zip disks are slightly larger than regular floppy disks, about twice as thick, and hold up to 100 MB of data.

---

[Back to Contents Page](#)

[Back to Contents Page](#)

## Removing and Installing Parts

Dell™ XPS™ 710 Owner's Manual

- [Before You Begin](#)
- [Removing the Computer Cover](#)
- [Memory](#)
- [Cards](#)
- [Drives](#)
- [Hard Drive](#)
- [Drive Panel](#)
- [Floppy Drive](#)
- [Media Card Reader](#)
- [CD/DVD Drive](#)
- [Processor Airflow Shroud](#)
- [Processor](#)
- [Battery](#)
- [Removing the Computer Stand](#)
- [Replacing the Computer Cover](#)

---

### Before You Begin

This chapter provides procedures for removing and installing the components in your computer. Unless otherwise noted, each procedure assumes that a component can be replaced by performing the removal procedure in reverse order.









### Recommended Tools

The procedures in this document may require one or more of the following tools:

- 1 Small flat-blade screwdriver
- 1 Phillips screwdriver
- 1 Flash BIOS update (see the Dell support website at [support.dell.com](http://support.dell.com))

### Preparing to Work Inside Your Computer

Use the following safety guidelines to help protect your computer from potential damage and to help ensure your own personal safety.

-  **CAUTION:** Before you begin any of the procedures in this section, follow the safety instructions in the *Product Information Guide*.
  -  **CAUTION:** To reduce the risk of fire, electric shock, or injury, do not overload an electrical outlet, power strip, or convenience receptacle. The total ampere rating of all products plugged into an electrical outlet, power strip, or other receptacle should not exceed 80 percent of the branch circuit rating.
  -  **CAUTION:** Your computer is heavy and can be difficult to maneuver. Seek assistance before attempting to lift, move, or tilt the computer and always lift correctly to avoid injury; avoid bending over while lifting.
  -  **NOTICE:** Only a certified service technician should perform repairs on your computer. Damage due to servicing that is not authorized by Dell is not covered by your warranty.
  -  **NOTICE:** To avoid electrostatic discharge and damage to internal components, ground yourself by using a wrist grounding strap or by periodically touching an unpainted metal surface on the computer chassis.
  -  **NOTICE:** Handle components and cards with care. Do not touch the components or contacts on a card. Instead, hold a card by its edges or by its metal mounting bracket. Hold a component such as a microprocessor by its edges, not by its pins.
  -  **NOTICE:** When disconnecting a cable, pull on the cable's connector or its strain-relief loop, not on the cable itself. Some cables have connectors with locking tabs; before disconnecting this type of cable, press inward on the locking tabs to release the connector. When connecting or disconnecting a cable, ensure that the connectors are correctly oriented and aligned to avoid damage to the connector and/or the connector's pins.
1. Ensure that the work surface is level and protected to prevent either the surface or the computer from being scratched.
  -  **NOTICE:** To avoid losing data, save any work in progress and exit all open programs before turning off your computer.
  2. Turn off the computer and all attached devices:
    - a. Click **Start**, then click **Turn Off Computer**.
    - b. In the **Turn off computer** window, click **Turn off**.

The computer performs a shutdown of the operating system, and then turns off.
-  **NOTE:** Ensure that the computer is off and not in a power management mode. If you cannot shut down the computer using the operating system, press and hold the power button for 4 seconds.

3. Disconnect the computer and all attached devices from their electrical outlets.

🔗 **NOTICE:** When disconnecting a network cable, first unplug the cable from your computer and then unplug it from the network port or device.

4. Disconnect all external cables from the computer.

5. Carefully, lift the rear of the computer and rotate the stabilizing feet into the closed position.

6. With the help of an assistant, carefully lay the computer down on a flat surface with the computer cover facing up.

---

## Removing the Computer Cover

⚠️ **CAUTION:** Before you begin any of the procedures in this section, follow the safety instructions in the *Product Information Guide*.

⚠️ **CAUTION:** To guard against electrical shock, always unplug your computer from the electrical outlet before removing the cover.

🔗 **NOTICE:** To avoid electrostatic discharge and damage to internal components, ground yourself by using a wrist grounding strap or by periodically touching an unpainted metal surface on the computer chassis.

1. Follow the procedures in [Before You Begin](#).

2. Pull back on the cover release latch.

🔗 **NOTICE:** Ensure that sufficient space exists to support the removed cover—at least 30 cm (1 ft) of desk top space.

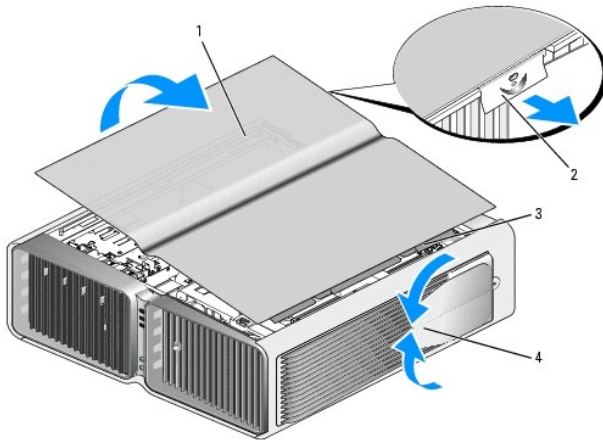

1	computer cover	2	cover release latch	3	cover hinge tabs
4	stabilizing feet (closed)				

3. With the cover release latch pulled back, grip the sides of the cover, then pivot the top of the cover up and away from the computer.

4. Slide the cover forward and up to remove it from the hinge slots, then set it aside in a secure and protected location.

## Inside View of Your Computer

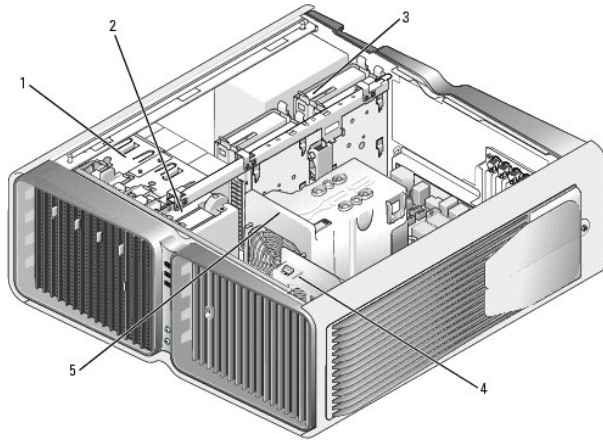

1	CD/DVD drive bays (4)	2	floppy drive/media card reader	3	hard drive bays (4)
4	card fan	5	front fan		

### System Board Components

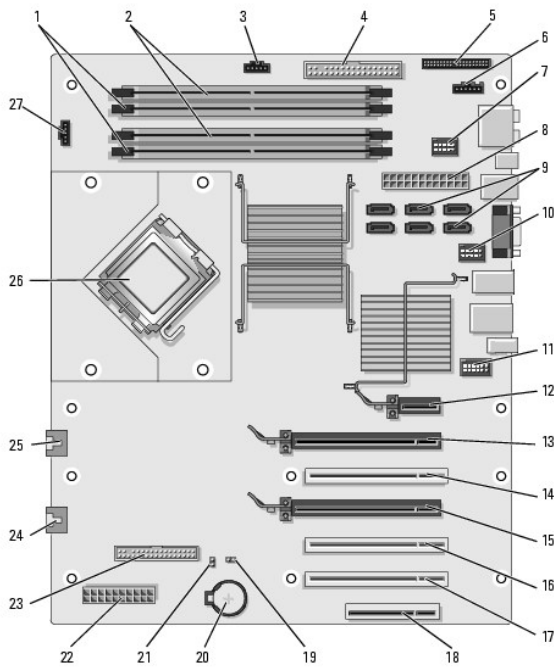

1	<i>white</i> memory module connectors (DIMM_1-2) support memory modules or memory module risers	2	<i>black</i> memory module connectors (DIMM_3-4) support memory modules only when no memory riser cards are installed; otherwise these must be left empty	3	hard drive fan connector (FAN_HDD)
4	IDE drive connector (IDE)	5	front I/O panel connector (FRONTPANEL)	6	back LED connector
7	FlexBay connector (INT_USB)	8	main power connector (POWER1)	9	SATA connectors (SATA0-5)
10	front USB connector (FRNT_USB)	11	front panel 1394 connector (FP1394)	12	PCI-Express x1 card slot (SLOT1)

				<b>NOTE:</b> This slot is not available in the dual-graphics configuration	
13	PCI-Express x16 card slot (SLOT2)	14	PCI card slot (SLOT3)  <b>NOTE:</b> This slot is not available in the dual-graphics configuration	15	PCI-Express x16 card slot (SLOT4)
16	PCI card slot (SLOT5)	17	PCI card slot (SLOT6)	18	PCI-Express x8 card slot (SLOT7)
19	RTC reset jumper (RTCST)	20	battery socket (BATTERY)	21	password jumper (PASSWORD)
22	power connector (POWER2)	23	floppy drive (DSKT)	24	card cage fan connector (FAN_CAGE)
25	processor fan connector (FAN2_CPU)  <b>NOTICE:</b> The FAN2_CPU connector is not currently used on this system and is reserved for future use. Do not attach the primary CPU fan to the FAN2_CPU connector.	26	primary processor (CPU)	27	processor fan connector (FAN1_CPU)

## Memory

You can increase your computer memory by installing memory modules on the system board.

Your computer supports DDR2 memory. For additional information on the type of memory supported by your computer, see [Memory](#).

### DDR2 Memory Overview

- 1 DDR2 memory modules should be installed in *pairs of matched memory size and speed*. If the DDR2 memory modules are not installed in matched pairs, the computer will continue to operate, but with a slight reduction in performance. See the label on the upper-right or upper-left corner of the module to determine the module's capacity.



**NOTE:** Always install DDR2 memory modules in the order indicated on the system board.

The recommended memory configurations are:

- o A pair of matched memory modules installed in DIMM connectors 1 and 2

or

- o A pair of matched memory modules installed in DIMM connectors 1 and 2 and another matched pair installed in DIMM connectors 3 and 4

**NOTICE:** Do not install ECC memory modules.

- 1 If you install mixed pairs of PC2-4300 (DDR2 533-MHz) and PC2-5300 (DDR2 667-MHz) memory, the modules function at the speed of the slowest module installed.
- 1 Be sure to install a single memory module in DIMM connector 1, the connector closest to the processor, before you install modules in any other connector.

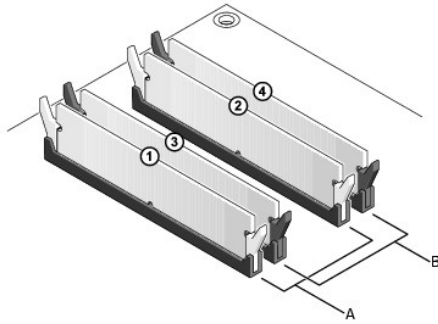

A matched pair of modules in DIMM connectors 1 and 2 (white securing clips)	B matched pair of memory modules in DIMM connectors 3 and 4 (black securing clips)
-----------------------------------------------------------------------------	------------------------------------------------------------------------------------

➡ **NOTICE:** If you remove your original memory modules from the computer during a memory upgrade, keep them separate from any new modules that you may have, even if you purchased the new modules from Dell. If possible, do not pair an original memory module with a new memory module. Otherwise, your computer may not start properly. You should install your original memory modules in pairs either in DIMM connectors 1 and 2 or DIMM connectors 3 and 4.

🔧 **NOTE:** Memory purchased from Dell is covered under your computer warranty.

## Addressing Memory Configurations

If you are using a 32-bit operating system such as Microsoft® Windows® XP, your computer will support a maximum of 4 GB of memory. If you are using a 64-bit operating system, your computer will support a maximum of 8 GB (2-GB DIMMs in each of the four slots) of memory.

## Installing Memory

⚠ **CAUTION:** Before you begin any of the procedures in this section, follow the safety instructions in the *Product Information Guide*.

➡ **NOTICE:** To avoid electrostatic discharge and damage to internal components, ground yourself by using a wrist grounding strap or by periodically touching an unpainted metal surface on the computer chassis.

1. Follow the procedures in [Before You Begin](#).
2. Remove the computer cover (see [Removing the Computer Cover](#)).
3. Press out the securing clip at each end of the memory module connector.

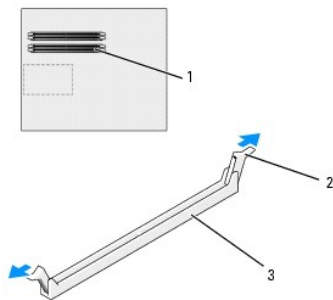

1 memory connector closest to processor	2 securing clips (2)	3 memory connector
-----------------------------------------	----------------------	--------------------

4. Align the notch on the bottom of the module with the crossbar in the connector.

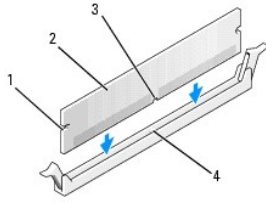

1	cutouts (2)	2	memory module	3	notch
4	crossbar				

➡ **NOTICE:** To avoid damage to the memory module, press the module straight down into the connector while you apply equal force to each end of the module.

5. Insert the module into the connector until the module snaps into position.

If you insert the module correctly, the securing clips snap into the cutouts at each end of the module.

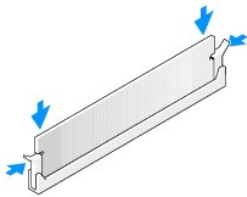

6. Replace the computer cover (see [Replacing the Computer Cover](#)).

➡ **NOTICE:** To connect a network cable, first plug the cable into the network port or device and then plug it into the computer.

7. Connect your computer and devices to electrical outlets, and turn them on.
8. When the message appears stating that memory size has changed, press <F1> to continue.
9. Log on to your computer.
10. Right-click the **My Computer** icon on your Windows desktop and click **Properties**.
11. Click the **General** tab.
12. To verify that the memory is installed correctly, check the amount of memory (RAM) listed.

## Removing Memory

⚠ **CAUTION:** Before you begin any of the procedures in this section, follow the safety instructions in the *Product Information Guide*.

➡ **NOTICE:** To avoid electrostatic discharge and damage to internal components, ground yourself by using a wrist grounding strap or by periodically touching an unpainted metal surface on the computer chassis.

1. Follow the procedures in [Before You Begin](#).
2. Press out the securing clip at each end of the memory module connector.
3. Grasp the module and pull up.

If the module is difficult to remove, gently ease the module back and forth to remove it from the connector.

---

## Cards

⚠ **CAUTION:** Before you begin any of the procedures in this section, follow the safety instructions in the *Product Information Guide*.



Your Dell™ computer provides the following slots for PCI and PCI Express cards:

- 1 Three PCI card slots
- 1 Two PCI Express x16 card slots (can be used in a dual-graphics configuration)
- 1 One PCI Express x8 card slot
- 1 One PCI Express x1 card slot

**NOTE:** If a graphics card is installed in each of the PCI Express x16 card slots in the dual-graphics configuration, the PCI Express x1 and one PCI card slot are not accessible for use.

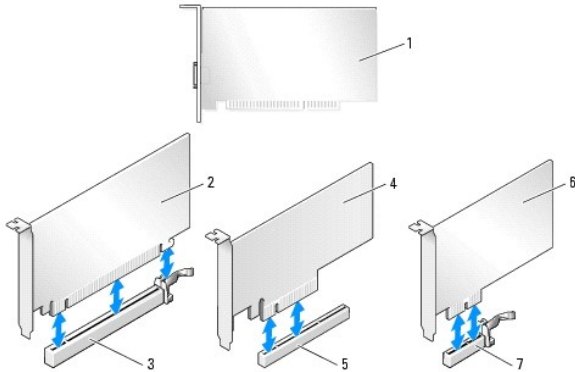

1	PCI card	2	PCI Express x16 card	3	PCI Express x16 card slot
4	PCI Express x8 card	5	PCI Express x8 card slot	6	PCI Express x1 card
7	PCI Express x1 card slot				

## Removing PCI and PCI Express Cards

- NOTE:** To avoid electrostatic discharge and damage to internal components, ground yourself by using a wrist grounding strap or by periodically touching an unpainted metal surface on the computer chassis.
- NOTE:** If your computer came with a PCI graphics card installed, removal of the card is not necessary when installing additional graphics cards; however, the card is required for troubleshooting purposes. If you remove the card, store it in a safe and secure location.
- NOTE:** If you have the optional dual graphics card configuration, see [Removing a PCI Express Graphics Card from a Dual Configuration](#) to remove or replace a graphics card.

1. Follow the procedures in [Before You Begin](#).
2. Remove the computer cover (see [Removing the Computer Cover](#)).
3. Disconnect any cables connected to the card.
4. Press down the tab on the top of the card retainer at the appropriate card slot and pivot the card retainer back through the chassis wall.
5. If present, press the tab on the card retention device that lays over the installed cards and lift it to gain full access to the card.

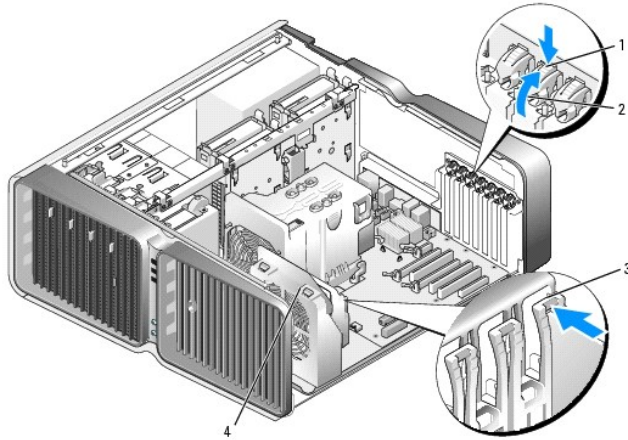

1	release tab	2	card retainer	3	alignment guide
4	fan bracket				

- Press the release tab (if present) on the system board connector as you grasp the card by its top corners, and then ease the card out of the connector.

**NOTE:** If the card is full-length, press the release tab on the end of the alignment guides on the fan bracket.

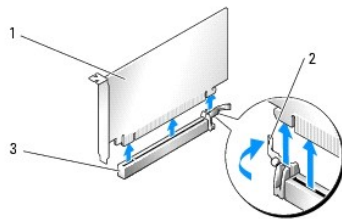

1	PCI Express x16 card	2	securing tab	3	PCI Express x16 card slot
---	----------------------	---	--------------	---	---------------------------

- Install a filler bracket in the empty card-slot opening. If you are replacing the card, see [Installing PCI and PCI Express Cards](#).

**NOTE:** Installing filler brackets over empty card-slot openings is necessary to maintain FCC certification of the computer. The brackets also keep dust and dirt out of your computer.

**NOTICE:** Before rotating the card retainer back into place, ensure that the tops of all cards and filler brackets are flush with the alignment bar and the notch in the top of each card or filler bracket fits around the alignment guide.

**NOTICE:** Do not route card cables over or behind the cards. Cables routed over the cards can prevent the computer cover from closing properly or cause damage to the equipment.

- Rotate the card retainer back into its original position; push its tip so that its tab clicks into place.

**NOTICE:** To connect a network cable, first plug the cable into the network port or device and then plug the cable into the computer.

- If present, lower the card retention device that lays over the installed cards and snap it into place.

- Replace the computer cover (see [Replacing the Computer Cover](#)), reconnect the computer and devices to electrical outlets, and then turn them on.

- Uninstall the driver for the card that you removed.

**NOTE:** If you removed a sound card or a network adapter, see [Network Adapter and Sound Card Settings](#).

## Installing PCI and PCI Express Cards

**NOTICE:** To avoid electrostatic discharge and damage to internal components, ground yourself by using a wrist grounding strap or by periodically touching an unpainted metal surface on the computer chassis.

**NOTICE:** If your computer came with a PCI graphics card installed, removal of the card is not necessary when installing additional graphics cards; however, the card is required for troubleshooting purposes. If you remove the card, store it in a safe and secure location.

**NOTICE:** If you have or are upgrading to the optional dual-graphics configuration, see [Installing a PCI Express Graphics Card in a Dual Configuration](#) to install a graphics card.

1. Follow the procedures in [Before You Begin](#).
2. Remove the computer cover (see [Removing the Computer Cover](#)).
3. If present, press the tab on the card retention device that lays over the installed cards and rotate it upwards to gain full access to the card.
4. Press down the tab on the top of the card retainer at the appropriate card slot and pivot the card retainer back through the chassis wall.

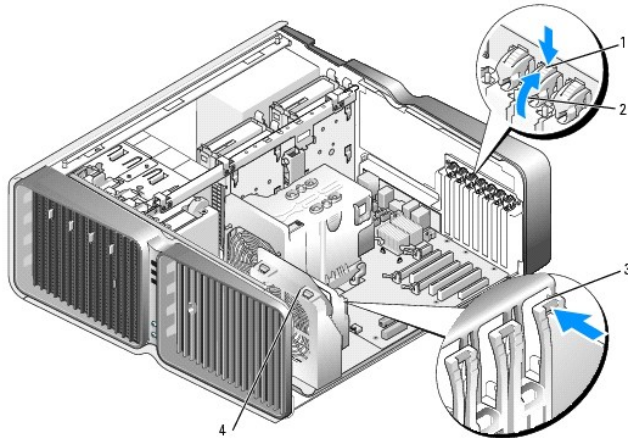

1	release tab	2	card retainer	3	alignment guide
4	fan bracket				

5. Remove the filler bracket or existing card (see [Removing PCI and PCI Express Cards](#)) to create a card-slot opening.
6. Prepare the card for installation.

See the documentation that came with the card for information on configuring the card, making internal connections, or otherwise customizing it for your computer.

7. Position the card so that it is aligned with the slot and the securing tab (if present) is aligned with the securing slot.

**NOTE:** If the card is full-length, insert the card guide into the alignment slot on the fan bracket.

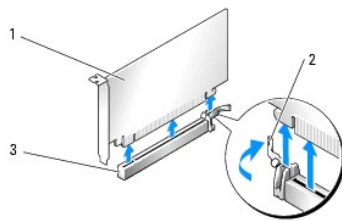

1	PCI Express x16 card	2	securing tab	3	PCI Express x16 card slot
---	----------------------	---	--------------	---	---------------------------

**NOTICE:** Ensure that you release the securing tab to seat the card. If the card is not installed correctly, you may damage the system board.

8. Gently pull the securing tab (if present) and place the card in the connector. Press down firmly and ensure that the card is fully seated in the slot.

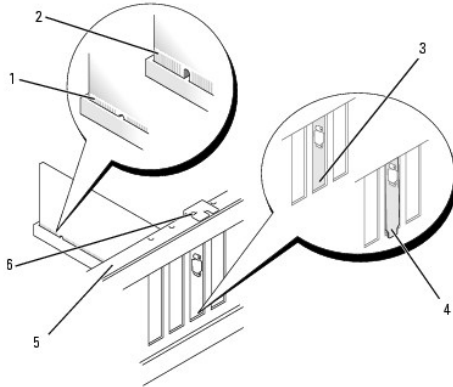

1	card connector (seated)	2	card connector (not seated)	3	bracket properly aligned within slot
4	bracket improperly aligned outside of slot	5	alignment bar	6	alignment guide

➡ **NOTICE:** Do not route card cables over or behind the cards. Cables routed over the cards can prevent the computer cover from closing properly or cause damage to the equipment.

➡ **NOTICE:** An incorrectly attached graphics power cable may result in degraded graphics performance.

9. Connect any cables that should be attached to the card.

See the documentation for the card for information about the card's cable connections.

➡ **NOTICE:** Before rotating the card retainer back into place, ensure that the tops of all cards and filler brackets are flush with the alignment bar and the notch in the top of each card or filler bracket fits around the alignment guide.

10. Rotate the card retainer back into its original position; push its tip so that its tab clicks into place.

11. If present, lower the card retention device that lays over the installed cards and snap it into place.

➡ **NOTICE:** To connect a network cable, first plug the cable into the network port or device and then plug the cable into the computer.

12. Replace the computer cover (see [Replacing the Computer Cover](#)), reconnect the computer and devices to electrical outlets, and then turn them on.

13. Install any drivers required for the card as described in the card documentation.

📌 **NOTE:** If you installed a sound card or a network adapter, see [Network Adapter and Sound Card Settings](#).

## Removing a PCI Express Graphics Card from a Dual Configuration

📌 **NOTE:** This section regards dual configurations of PCI Express x16 graphics cards only. For removal of any other type of PCI or PCI Express cards, see [Removing PCI and PCI Express Cards](#).

1. Follow the procedures in [Before You Begin](#).

2. Remove the computer cover (see [Removing the Computer Cover](#)).

3. If present, press the tab on the card retention device that lays over the installed cards and rotate it upwards to gain full access to the card.

4. Gently securing both graphics cards with one hand, remove the graphics card bridge (if present) with your other hand by pulling it up and away from the computer. Set it aside.

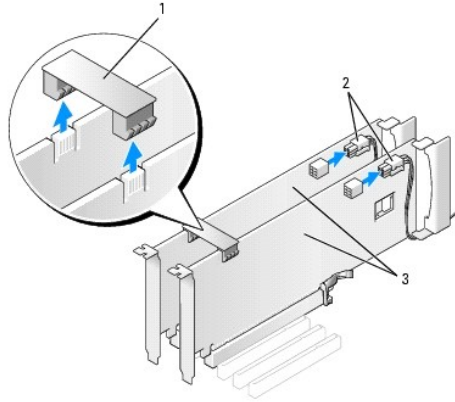

1	graphics card bridge	2	power connectors (2)	3	dual-PCI Express graphics cards
---	----------------------	---	----------------------	---	---------------------------------

- Disconnect any cables connected to the card.
- Press down the tab on the top of the card retainer at the appropriate card slot and pivot the card retainer back through the chassis wall.

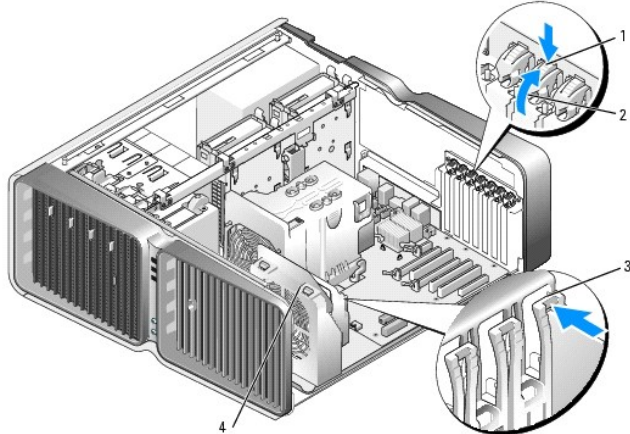

1	release tab	2	card retainer	3	alignment guide
4	fan bracket				

- Press the release tab (if present) on the system board connector as you grasp the card by its top corners, and then ease the card out of the connector.
- NOTE:** If the card is full-length, press the release tab on the end of the alignment guides on the fan bracket.

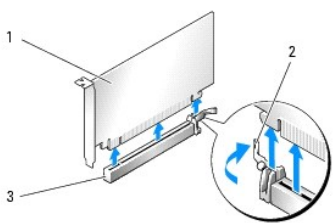

1	PCI Express x16 card	2	securing tab	3	PCI Express x16 card slot
---	----------------------	---	--------------	---	---------------------------

- Install a filler bracket in the empty card-slot opening. If you are replacing the card, see [Installing a PCI Express Graphics Card in a Dual Configuration](#).
- NOTE:** Installing filler brackets over empty card-slot openings is necessary to maintain FCC certification of the computer. The brackets also keep dust and dirt out of your computer.
- NOTE:** The graphics card bridge (not present in all dual-graphics configurations) is not necessary in a single graphics card configuration.

- ➡ **NOTICE:** Before rotating the card retainer back into place, ensure that the tops of all cards and filler brackets are flush with the alignment bar and the notch in the top of each card or filler bracket fits around the alignment guide.
  - ➡ **NOTICE:** Do not route card cables over or behind the cards. Cables routed over the cards can prevent the computer cover from closing properly or cause damage to the equipment.
9. Rotate the card retainer back into its original position; push its tip so that its tab clicks into place.
  - ➡ **NOTICE:** To connect a network cable, first plug the cable into the network port or device and then plug the cable into the computer.
  10. If present, lower the card retention device that lays over the installed cards and snap it into place.
  11. Replace the computer cover (see [Replacing the Computer Cover](#)), reconnect the computer and devices to electrical outlets, and then turn them on.

## Installing a PCI Express Graphics Card in a Dual Configuration

**NOTE:** To upgrade to or downgrade from a dual-graphics configuration, you will need additional parts that can be ordered from Dell (see [Contacting Dell](#)).

This section pertains to dual PCI Express graphics card configurations only. For installation of other types of PCI or PCI Express cards, see [Installing PCI and PCI Express Cards](#).

The PCI Express x1 card slot is not available for use if a graphics card is installed in each of the PCI Express x16 card slots in a dual graphics card configuration. If you are upgrading from a single graphics card to a dual-graphics card configuration, you will need to remove any card installed in the PCI Express x1 card slot (see [System Board Components](#) to locate the PCI Express x1 card slot). To remove a PCI Express card, see [Removing PCI and PCI Express Cards](#).

➡ **NOTICE:** For information about upgrading your system to use NVIDIA SLI (Scalable Link Interface) dual-graphics technology, see the Dell website at [support.dell.com](http://support.dell.com).

To learn more about NVIDIA SLI (Scalable Link Interface) dual-graphics technology, see [Understanding Dual Graphics Technology](#).

1. Follow the procedures in [Before You Begin](#).
2. Remove the computer cover (see [Removing the Computer Cover](#)).
3. If present, press the tab on the card retention device that lays over the installed cards and rotate it upwards to gain full access to the card.
4. Press down the tab on the top of the card retainer at the appropriate card slot and pivot the card retainer back through the chassis wall.

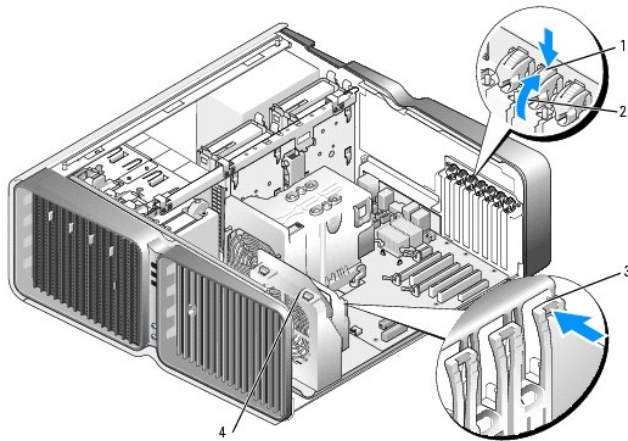

1	release tab	2	card retainer	3	alignment guide
4	fan bracket				

5. Remove the filler bracket or existing graphics card (see [Removing a PCI Express Graphics Card from a Dual Configuration](#)) to create a card-slot opening.

**NOTE:** If you are upgrading to a dual graphics card configuration and have a card installed in the PCI Express x1 card slot, remove the card (see [Removing PCI and PCI Express Cards](#)).

6. Prepare the card for installation.

See the documentation that came with the card for information on configuring the card, making internal connections, or otherwise customizing it for your computer.

7. Position the card so that it is aligned with the slot and the securing tab (if present) is aligned with the securing slot.

 **NOTE:** If the card is full-length, insert the card guide into the alignment slot on the fan bracket.

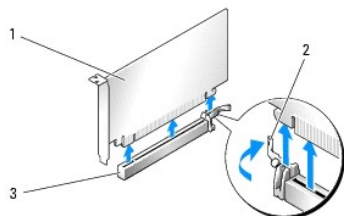

1	PCI Express x16 card	2	securing tab	3	PCI Express x16 card slot
---	----------------------	---	--------------	---	---------------------------

 **NOTE:** Ensure that you release the securing tab to seat the card. If the card is not installed correctly, you may damage the system board.

8. Gently pull the securing tab (if present) and place the card in the connector. Press down firmly and ensure that the card is fully seated in the slot.

 **NOTE:** Do not route card cables over or behind the cards. Cables routed over the cards can prevent the computer cover from closing properly or cause damage to the equipment.

 **NOTE:** An incorrectly attached graphics power cable may result in degraded graphics performance.

9. Connect any cables that should be attached to the card.

See the documentation for the card for information about the card's cable connections.

 **NOTE:** Before rotating the card retainer back into place, ensure that the tops of all cards and filler brackets are flush with the alignment bar and the notch in the top of each card or filler bracket fits around the alignment guide.

10. Rotate the card retainer back into its original position; push its tip so that its tab clicks into place.

11. Attach the graphics card bridge (if required for your dual-graphics configuration), pressing firmly so that it completely covers the connector tabs.

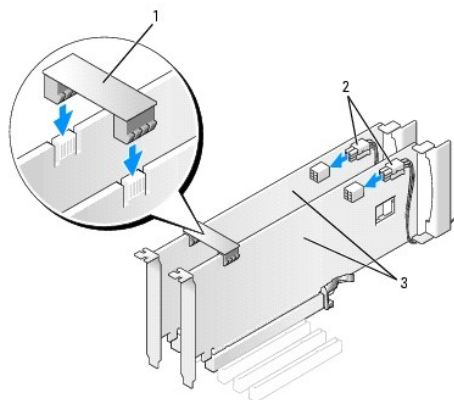

1	graphics card bridge (not present on some dual graphics card configurations)	2	power connectors (2)	3	dual-PCI Express graphics cards
---	------------------------------------------------------------------------------	---	----------------------	---	---------------------------------

 **NOTE:** To connect a network cable, first plug the cable into the network port or device and then plug the cable into the computer.

12. If present, lower the card retention device that lays over the installed cards and snap it into place.

13. Replace the computer cover (see [Replacing the Computer Cover](#)), reconnect the computer and devices to electrical outlets, and then turn them on.

## Network Adapter and Sound Card Settings

If you installed a sound card:

1. Enter system setup (see [Entering System Setup](#)), select **Integrated Audio Controller**, and then change the setting to **Off**.
2. Connect external audio devices to the sound card connectors. Do not connect external audio devices to the microphone, speaker/headphone, or line-in connectors on the back panel.

If you removed a sound card:

1. Enter system setup (see [Entering System Setup](#)), select **Integrated Audio Controller**, and then change the setting to **On**.
2. Connect external audio devices to the audio connectors on the back panel of the computer.

If you installed an add-in network adapter and want to disable the integrated network adapter:

1. Enter system setup (see [Entering System Setup](#)), select **Integrated NIC Controller**, and then change the setting to **Off**.
2. Connect the network cable to the add-in network adapter connectors. Do not connect the network cable to the integrated connector on the back panel.

If you removed an add-in network connector:

1. Enter system setup (see [Entering System Setup](#)), select **Integrated NIC Controller**, and then change the setting to **On**.
2. Connect the network cable to the integrated connector on the back panel of the computer.

---

## Drives

Your computer supports:

- 1 Six SATA devices (hard drives or optical drives)
- 1 Two IDE devices (two hard drives or two optical drives)
- 1 One floppy drive
- 1 One Media Card Reader

 **NOTICE:** When removing and replacing drives, be sure to leave the drive data and power cables connected to the system board.

 **NOTE:** The 5.25-inch Media Card Reader/floppy drive carrier is not interchangeable with the hard drive carrier.

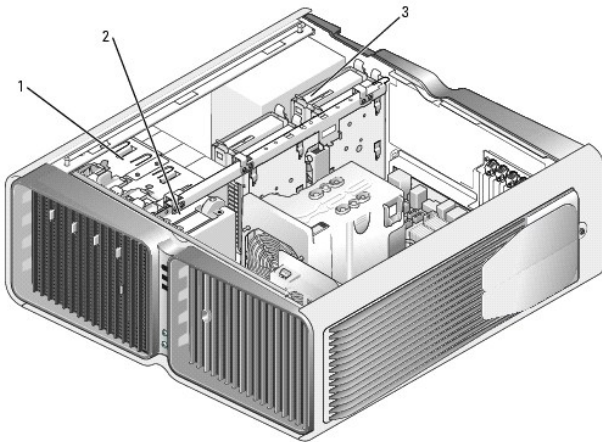

1	CD/DVD drive bays (4)	2	floppy drive/media card reader	3	hard-drive bays (4)
---	-----------------------	---	--------------------------------	---	---------------------

## About Serial ATA Drives

Your computer supports up to four serial ATA hard drives and two serial ATA optical drives. Serial ATA drives provide the following benefits by transferring data using serial technology and flexible cables that are thinner and longer than IDE cables:



- 1 Improved cable routing facilitates more efficient airflow inside the chassis.
- 1 Compact cable connectors save space on the system board and on the hard drive, allowing for more efficient utilization of space inside the chassis.

## General Drive Installation Guidelines

SATA hard drives should be connected to connectors labeled "HDD" on the system board. Non-hard drive SATA devices should be attached to the connectors labeled SATA, with the exception of a 5th SATA hard drive installed in a 5.25-inch drive bay, which must be connected to the SATA0 connector. IDE CD/DVD drives should be connected to the connectors labeled "IDE."

When connecting a SATA cable, hold the cable by the connector at each end and press firmly into the connector. When disconnecting a SATA cable, hold the cable by the connector at each end and pull until the connector detaches.

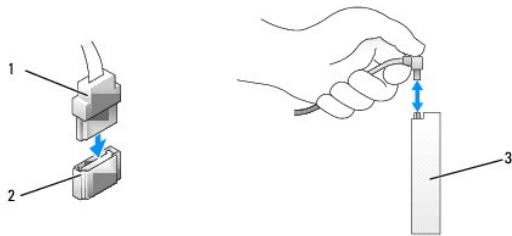

1	SATA data cable	2	SATA data connector (on the system board)	3	SATA drive
---	-----------------	---	-------------------------------------------	---	------------

When you connect two IDE devices to a single IDE data cable and configure the devices for the cable select setting, the device attached to the last connector on the data cable is primary or the boot device, and the device attached to the middle connector on the data cable is the secondary device. See the drive documentation in your upgrade kit for information on configuring devices for the cable select setting.

To connect an IDE data cable, align the tab on one connector with the notch on the other. When disconnecting an IDE data cable, grasp the colored pull-tab and pull until the connector detaches.

---

## Hard Drive

### Removing a Hard Drive

**⚠ CAUTION:** Before you begin any of the procedures in this section, follow the safety instructions in the *Product Information Guide*.

**⚠ CAUTION:** To guard against electrical shock, always unplug your computer from the electrical outlet before removing the cover.

**👉 NOTICE:** If you are replacing a hard drive that contains data that you want to keep, back up your files before you begin this procedure.

1. Follow the procedures in [Before You Begin](#).
2. Remove the computer cover (see [Removing the Computer Cover](#)).
3. Disconnect the power cable and the data cable from the hard drive.

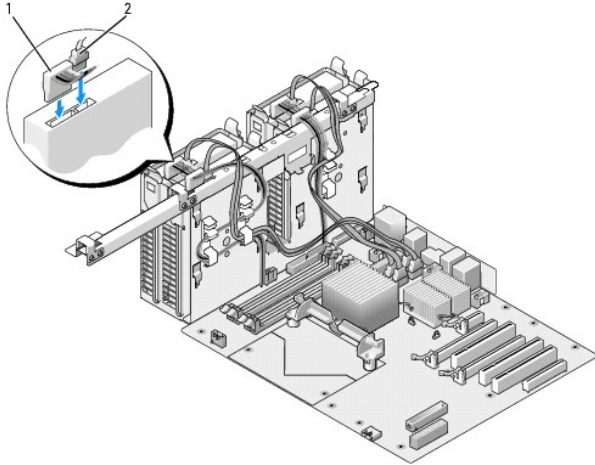

1	power cable	2	data cable
---	-------------	---	------------

- Press the blue tabs on each side of the hard-drive bracket toward each other and slide the drive up and out of the hard-drive bay.

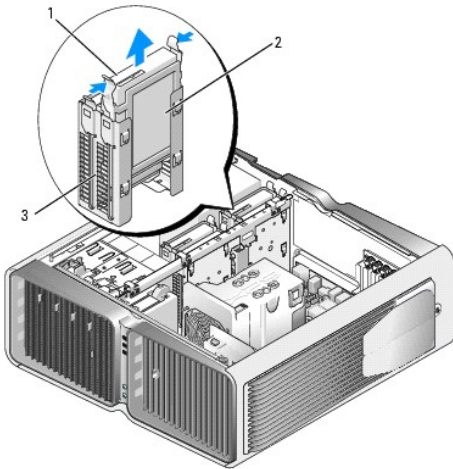

1	blue tabs (2)	2	hard drive	3	hard drive bay
---	---------------	---	------------	---	----------------

- Ensure that all connectors are properly cabled and firmly seated.
  - Replace the computer cover (see [Replacing the Computer Cover](#)).
- NOTICE:** To connect a network cable, first plug the cable into the network port or device and then plug it into the computer.
- Connect the computer and devices to electrical outlets, and turn them on.

## Installing a Hard Drive

**CAUTION:** Before you begin any of the procedures in this section, follow the safety instructions in the *Product Information Guide*.

- Follow the procedures in [Before You Begin](#).
- Remove the computer cover (see [Removing the Computer Cover](#)).
- Remove the existing hard drive, if applicable (see [Removing a Hard Drive](#)).

 **NOTE:** If a hard-drive bracket is installed inside of the hard-drive bay, remove the bracket before you install the new hard drive.

4. Prepare the new hard drive for installation and check the documentation for the hard drive to verify that the drive is configured for your computer.

 **NOTE:** If hard drive you are installing does not have the hard drive bracket attached, use your original hard drive bracket; snap the bracket onto the new drive.

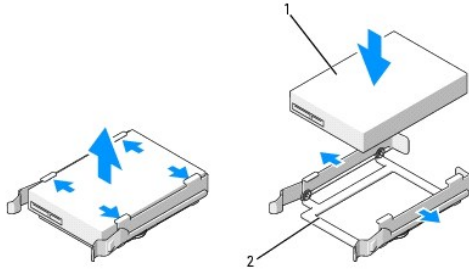

1	hard drive	2	hard drive bracket
---	------------	---	--------------------

5. Verify that the hard-drive bay is empty and unobstructed.

6. Slide the hard drive into the hard-drive bay until it clicks securely into place.

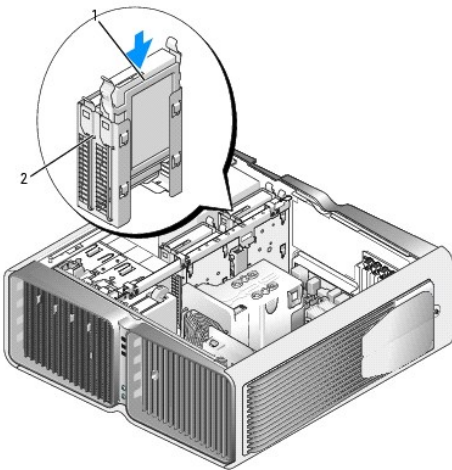

1	hard drive	2	hard drive bay
---	------------	---	----------------

 **NOTICE:** Ensure that all connectors are properly cabled and firmly seated.

7. Connect the power cable to the hard drive.

8. Connect the hard drive data cable to the hard drive.

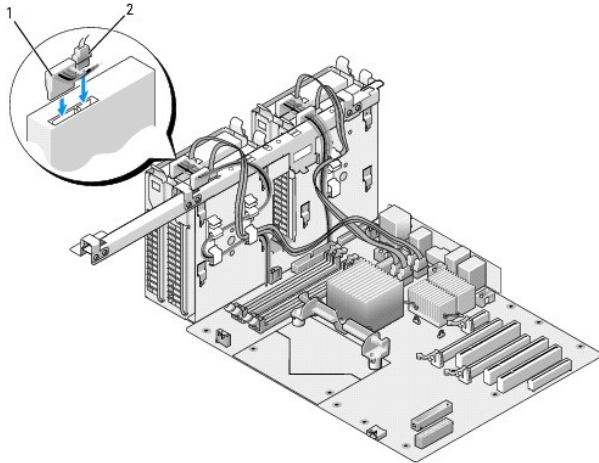

1	power cable	2	data cable
---	-------------	---	------------

9. Replace the computer cover (see [Replacing the Computer Cover](#)).

🔗 **NOTICE:** To connect a network cable, first plug the cable into the network port or device and then plug it into the computer.

10. Connect the computer and devices to electrical outlets, and turn them on.

See the documentation that came with the drive for instructions on installing any software required for drive operation.

## Drive Panel

⚠️ **CAUTION:** Before you begin any of the procedures in this section, follow the safety instructions in the *Product Information Guide*.

### Removing the Drive Panel

1. Follow the procedures in [Before You Begin](#).
2. Remove the computer cover (see [Removing the Computer Cover](#)).
3. Grasp the drive release latch and slide it towards the base of the computer until the drive panel snaps open.

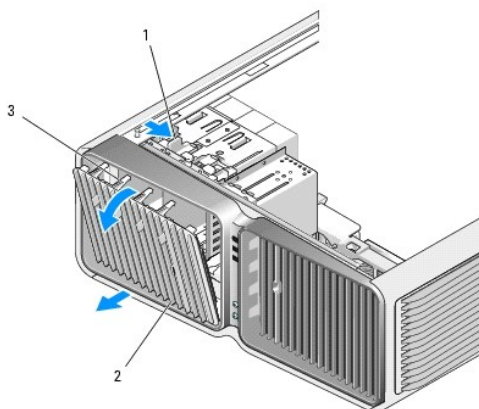

1	drive release latch	2	drive panel	3	drive panel tabs
---	---------------------	---	-------------	---	------------------

4. Pivot the drive panel outward and lift it from its side hinges.

5. Set the drive panel aside in a secure location.

## Replacing the Drive Panel

1. Follow the procedures in [Before You Begin](#).
2. Remove the computer cover (see [Removing the Computer Cover](#)).
3. Align the drive panel tabs with the side-door hinges.

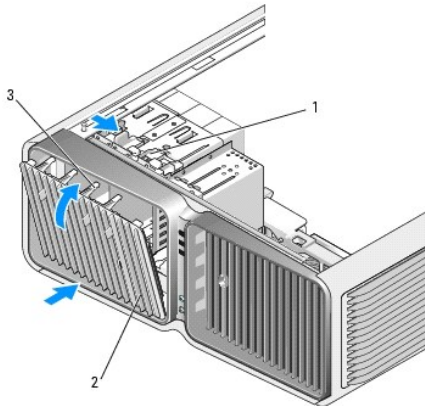

1	drive release latch	2	drive panel	3	drive panel tabs
---	---------------------	---	-------------	---	------------------

4. Rotate the drive panel toward the computer until it snaps into place on the drive panel.
5. Replace the computer cover (see [Replacing the Computer Cover](#)).

See the documentation that came with the drive for instructions on installing any software required for drive operation.

---

## Floppy Drive

**⚠ CAUTION:** Before you begin any of the procedures in this section, follow the safety instructions in the *Product Information Guide*.

### Removing a Floppy Drive

1. Follow the procedures in "[Before You Begin](#)."
2. Remove the computer cover (see [Removing the Computer Cover](#)).
3. Remove the drive panel (see [Removing the Drive Panel](#)).
4. Disconnect the power and data cables from the back of the floppy drive.

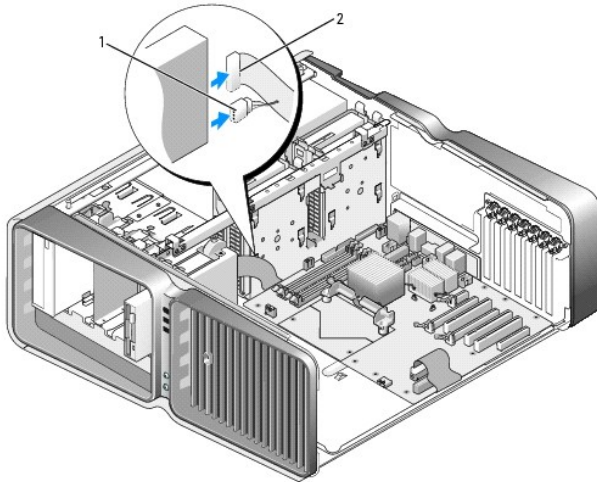

1	power cable	2	floppy drive data cable
---	-------------	---	-------------------------

- Slide the drive release latch towards the base of the computer to release the shoulder screw, and then slide the drive out of the drive bay.

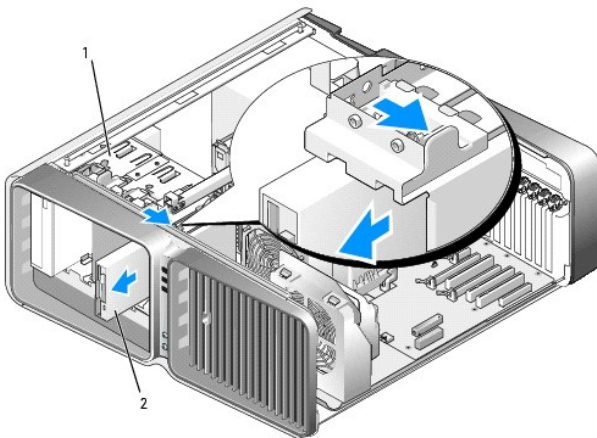

1	drive release latch	2	floppy drive
---	---------------------	---	--------------

- Replace the drive panel (see [Replacing the Drive Panel](#)).
- Replace the computer cover (see [Replacing the Computer Cover](#)).

**NOTICE:** To connect a network cable, first plug the cable into the network port or device and then plug it into the computer.

- Connect the computer and devices to electrical outlets, and turn them on.

## Installing a Floppy Drive

- Follow the procedures in [Before You Begin](#).
- Remove the computer cover (see [Removing the Computer Cover](#)).
- Remove the drive panel (see [Removing the Drive Panel](#)).
- Remove the existing floppy drive, if applicable (see [Removing a Floppy Drive](#)).

- If no screws are attached to the new floppy drive, check the inside of the drive panel for shoulder screws. If screws are present, attach the screws to the new drive.

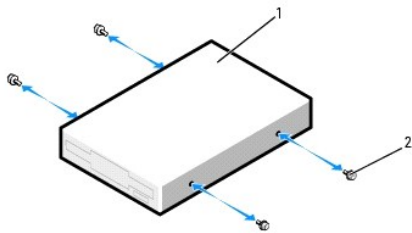

1	floppy drive	2	shoulder screws (4)
---	--------------	---	---------------------

Slide the floppy drive into the drive bay until it clicks into place.

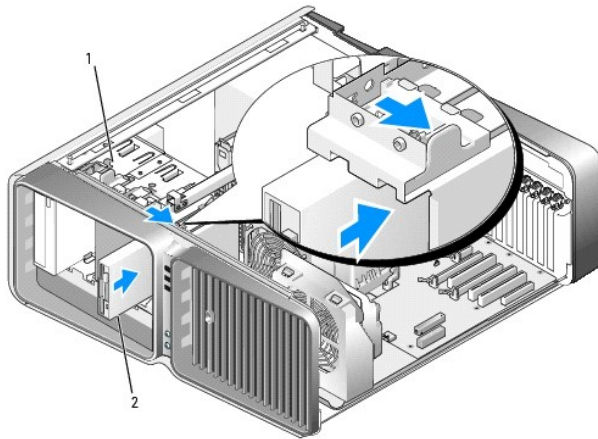

1	drive release latch	2	floppy drive
---	---------------------	---	--------------

- Connect the power and data cables to the back of the floppy drive.
  - Check all cable connections and fold cables out of the way to avoid blocking airflow between the fan and cooling vents.
  - Replace the drive panel (see [Replacing the Drive Panel](#)).
  - Replace the computer cover (see [Replacing the Computer Cover](#)).
- 🔔 **NOTICE:** To connect a network cable, first plug the cable in to the network port or device and then plug it in to the computer.
- Connect your computer and devices to their electrical outlets, and turn them on.  
See the documentation that came with the drive for instructions on installing any software required for drive operation.
  - Enter system setup (see [Entering System Setup](#)), and select the appropriate **Diskette Drive** option.

---

## Media Card Reader

⚠️ **CAUTION:** Before you begin any of the procedures in this section, follow the safety instructions in the *Product Information Guide*.

### Removing a Media Card Reader

- Follow the procedures in [Before You Begin](#).

2. Remove the computer cover (see [Removing the Computer Cover](#)).
3. Remove the drive panel (see [Removing the Drive Panel](#)).
4. Disconnect the power and data cables from the back of the Media Card Reader.

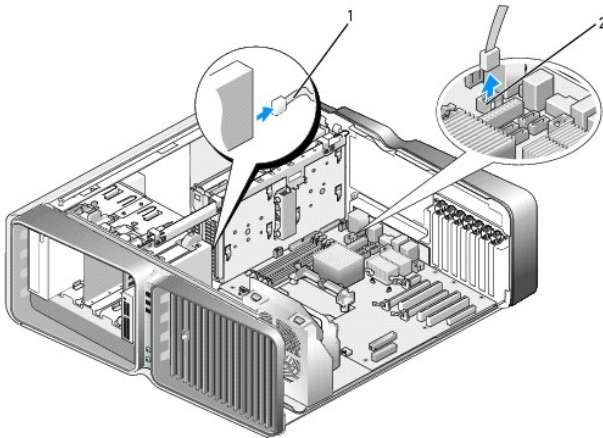

1	media card reader power cable	2	system board connector
---	-------------------------------	---	------------------------

5. Slide the drive release latch towards the base of the computer to release the shoulder screw, and then slide the media card reader out of the drive bay.

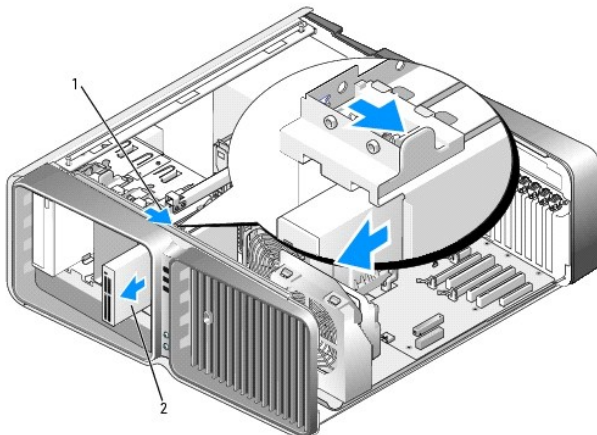

1	drive release latch	2	media card reader
---	---------------------	---	-------------------

6. Replace the drive panel (see [Replacing the Drive Panel](#)).
7. Replace the computer cover (see [Replacing the Computer Cover](#)).

**NOTICE:** To connect a network cable, first plug the cable into the network port or device and then plug it into the computer.

8. Connect the computer and devices to electrical outlets, and turn them on.

## Installing a Media Card Reader

1. Follow the procedures in [Before You Begin](#).
2. Remove the computer cover (see [Removing the Computer Cover](#)).



3. Remove the drive panel (see [Removing the Drive Panel](#)).
4. Remove the existing media card reader, if applicable (see [Removing a Media Card Reader](#)).
5. If no screws are attached to the Media Card Reader, check the inside of the drive panel for shoulder screws. If screws are present, attach the screws to the new card reader.

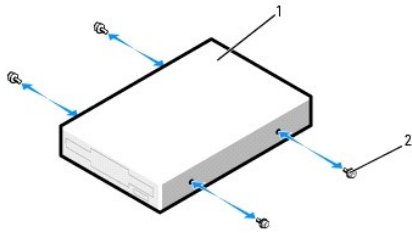

1	media card reader	2	shoulder screws (4)
---	-------------------	---	---------------------

6. Slide the Media Card Reader into the drive bay until it clicks into place.

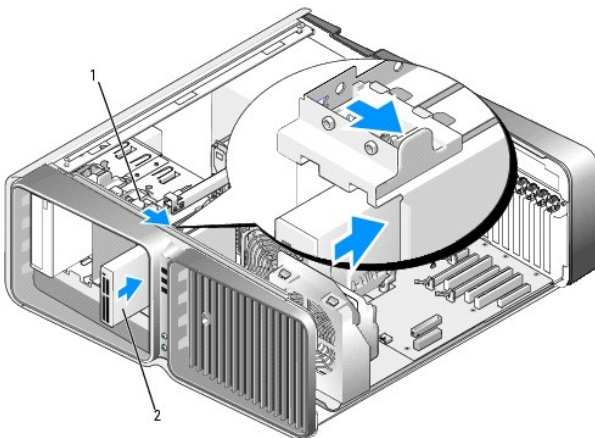

1	drive release latch	2	media card reader
---	---------------------	---	-------------------

7. Attach the power and data cables to the back of the Media Card Reader.
  8. Check all cable connections and fold cables out of the way to avoid blocking airflow between the fan and cooling vents.
  9. Replace the drive panel (see [Replacing the Drive Panel](#)).
  10. Replace the computer cover (see [Replacing the Computer Cover](#)).
- NOTICE:** To connect a network cable, first plug the cable in to the network port or device and then plug it in to the computer.
11. Connect your computer and devices to their electrical outlets, and turn them on.  
See the documentation that came with the drive for instructions on installing any software required for drive operation.
  12. Enter system setup (see [Entering System Setup](#)) and select the appropriate **USB for FlexBay** option.

---

## CD/DVD Drive

**CAUTION:** Before you begin any of the procedures in this section, follow the safety instructions in the *Product Information Guide*.

## Removing a CD/DVD Drive

1. Follow the procedures in [Before You Begin](#).
2. Remove the computer cover (see [Removing the Computer Cover](#)).
3. Remove the drive panel (see [Removing the Drive Panel](#)).
4. Disconnect the power and data cables from the back of the drive.

 **NOTE:** If you are uninstalling your only CD/DVD drive and will not replace it at this time, disconnect the data cable from the system board and set it aside.

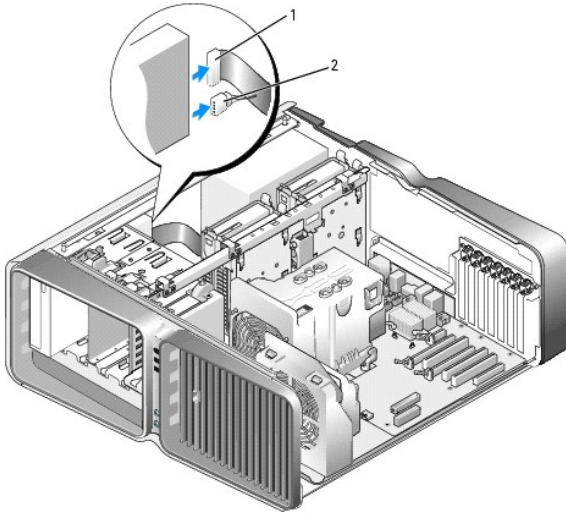

1	data cable	2	power cable
---	------------	---	-------------

5. Slide the drive release latch towards the base of the computer to release the shoulder screw, and then slide the CD/DVD drive out of the drive bay.

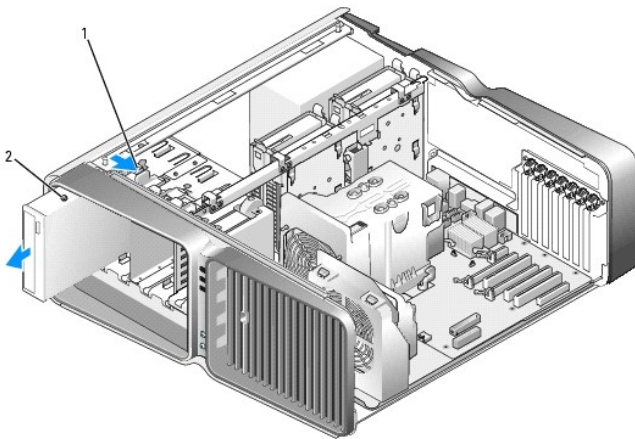

1	drive release latch	2	CD/DVD drive
---	---------------------	---	--------------

6. Replace the drive panel (see [Replacing the Drive Panel](#)).
7. Replace the computer cover (see [Replacing the Computer Cover](#)).

 **NOTICE:** To connect a network cable, first plug the cable into the network port or device and then plug it into the computer.

8. Connect the computer and devices to electrical outlets, and turn them on.

## Installing a CD/DVD Drive

1. Follow the procedures in [Before You Begin](#).
2. Remove the computer cover (see [Removing the Computer Cover](#)).
3. Remove the drive panel (see [Removing the Drive Panel](#)).
4. Remove the existing CD/DVD drive, if applicable (see [Removing a CD/DVD Drive](#)).
5. Prepare the CD/DVD drive for installation and check the documentation that accompanied the drive to verify that the drive is configured for your computer.

 **NOTE:** If you are installing an IDE drive, configure the drive for the cable select setting.

6. If no screws are attached to the drive, check the inside of the drive panel for screws and, if screws are present, attach the screws to the new drive.

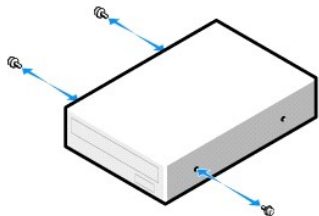

1	CD/DVD drive	2	shoulder screws (3)
---	--------------	---	---------------------

7. Gently slide the drive into the drive bay until you hear a click or feel the drive securely installed.

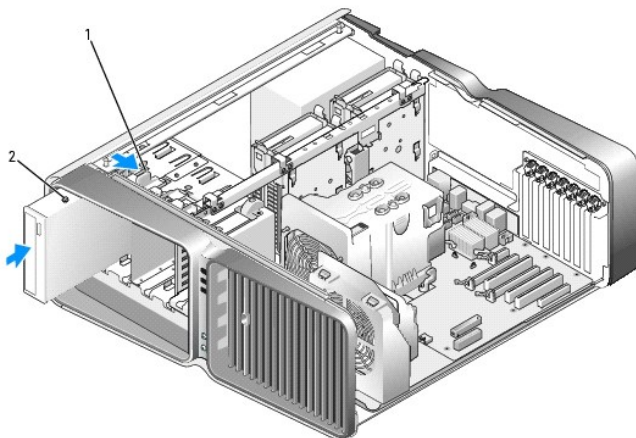

1	drive release latch	2	CD/DVD drive
---	---------------------	---	--------------

8. Attach the power and data cables to the CD/DVD drive.

To locate the system board connector, see [System Board Components](#).

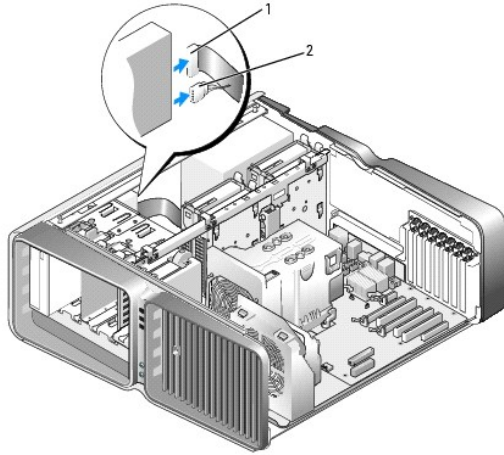

1	power cable	2	data cable
---	-------------	---	------------

9. Check all cable connections and fold cables out of the way to avoid blocking airflow between the fan and cooling vents.
  10. Replace the drive panel (see [Replacing the Drive Panel](#)).
  11. Replace the computer cover (see [Replacing the Computer Cover](#)).
  - 🔑 **NOTICE:** To connect a network cable, first plug the cable in to the network port or device and then plug it in to the computer.
  12. Connect your computer and devices to their electrical outlets, and turn them on.  
See the documentation that came with the drive for instructions on installing any software required for drive operation.
  13. Enter system setup (see [Entering System Setup](#)) and select the appropriate **Drive** option.
- 

## Processor Airflow Shroud

⚠️ **CAUTION:** Before you perform this procedure, follow the safety instructions located in the *Product Information Guide*.

### Removing the Processor Airflow Shroud

1. Follow the procedures in [Before You Begin](#).
2. Remove the computer cover (see [Removing the Computer Cover](#)).

⚠️ **CAUTION:** The processor heat sink can get very hot during normal operation. Be sure that the heat sink has had sufficient time to cool before you touch it.

3. Loosen the two captive screws on the processor airflow shroud, and then rotate the shroud back, away from the fan.

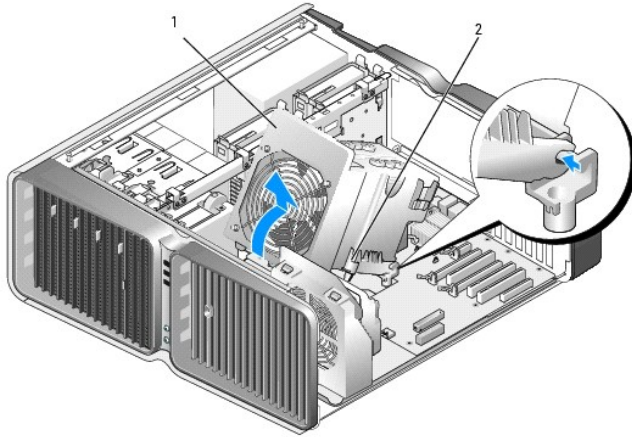

1	processor airflow shroud	2	captive screws (2)
---	--------------------------	---	--------------------

➡ **NOTICE:** The processor heat sink is attached to the processor airflow shroud. When you remove the airflow shroud, lay it upside down or on its side to avoid damaging the heatsink thermal interface.

4. Lift the processor airflow shroud out of the computer, and then set it aside.

## Installing the Processor Airflow Shroud

1. Follow the procedures in [Before You Begin](#).
2. Remove the computer cover (see [Removing the Computer Cover](#)).
3. Align the hinge slots on the processor airflow shroud with the hinge guides on the system board.
4. Gently rotate the processor airflow shroud towards the fan, and then tighten the two captive screws.
5. Close the computer cover (see [Replacing the Computer Cover](#)).

➡ **NOTICE:** To connect a network cable, first plug the cable into the network port or device and then plug it into the computer.

6. Connect your computer and devices to electrical outlets, and turn them on.

---

## Processor

⚠ **CAUTION:** Before you begin any of the procedures in this section, follow the safety instructions in the *Product Information Guide*.

➡ **NOTICE:** Do not perform the following steps unless you are familiar with hardware removal and replacement. Performing these steps incorrectly could damage your system board. For technical service, see [Dell Hardware Warranty Support Policy \(U.S. Only\)](#).

## Removing the Processor

1. Follow the procedures in [Before You Begin](#).
2. Remove the computer cover (see [Removing the Computer Cover](#)).
3. Disconnect the power cables from the POWER1 and POWER2 connectors (see [System Board Components](#)) on the system board.
4. Remove the airflow shroud (see [Removing the Processor Airflow Shroud](#)).
5. Push down and out on the socket release lever.

- Lift the socket release lever and open the processor cover.

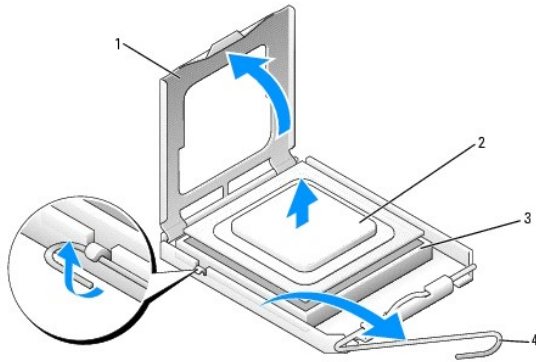

1	processor cover	2	processor	3	socket
4	socket release lever				

- Remove the processor from the socket.

Leave the release lever extended in the release position so that the socket is ready for the new processor.

## Installing the Processor

- NOTICE:** Ground yourself by touching an unpainted metal surface on the back of the computer.

- Unpack the new processor.

- NOTICE:** You must position the processor correctly in the socket to avoid permanent damage to the processor and the computer when you turn on the computer.

- If the release lever on the socket is not fully extended, move it to that position.
- Align the pin-1 corner of the processor and socket.

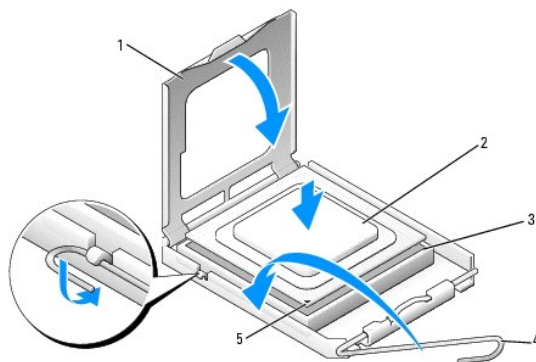

1	processor cover	2	processor	3	socket
4	socket release lever	5	socket pin-1 indicator		

- NOTICE:** Socket pins are delicate. To avoid damage, ensure that the processor is aligned properly with the socket, and do not use excessive force when you install the processor. Be careful not to touch or bend the pins on the system board.

- Set the processor lightly in the socket and ensure that the processor is level in the socket. When the processor is positioned correctly, press it with minimal pressure to seat it.
- When the processor is fully seated in the socket, close the processor cover.

- Pivot the socket release lever back toward the socket and snap it into place to secure the processor.
- Replace the processor airflow shroud (see [Installing the Processor Airflow Shroud](#)).
- Reconnect the power cables to the POWER1 and POWER2 connectors (see [System Board Components](#)) on the system board.
- Close the computer cover (see [Replacing the Computer Cover](#)).

➡ **NOTICE:** To connect a network cable, first plug the cable into the network port or device and then plug it into the computer.

- Connect your computer and devices to electrical outlets, and turn them on.
- 

## Battery

⚠ **CAUTION:** Before you begin any of the procedures in this section, follow the safety instructions in the *Product Information Guide*.

### Replacing the Battery

A coin-cell battery maintains computer configuration, date, and time information. The battery can last several years.

If you have to repeatedly reset time and date information after turning on the computer, replace the battery.

⚠ **CAUTION:** A new battery can explode if it is incorrectly installed. Replace the battery only with the same or equivalent type recommended by the manufacturer. Discard used batteries according to the manufacturer's instructions.

To replace the battery:

- Record all the screens in system setup (see [System Setup](#)) so that you can restore the correct settings after the new battery has been installed.
- Follow the procedures in [Before You Begin](#).
- Open the computer cover (see [Removing the Computer Cover](#)).
- Locate the battery socket (see [System Board Components](#)).

➡ **NOTICE:** If you pry the battery out of its socket with a blunt object, be careful not to touch the system board with the object. Ensure that the object is inserted between the battery and the socket before you attempt to pry out the battery. Otherwise, you may damage the system board by prying off the socket or by breaking circuit traces on the system board.



- Remove the battery by prying it out of its socket with your fingers.
- Insert the new battery (CR2032) into the socket with the side labeled "+" facing up, and press the battery into place.
- Replace the computer cover (see [Replacing the Computer Cover](#)).

➡ **NOTICE:** To connect a network cable, first plug the cable into the network port or device and then plug it into the computer.

8. Connect your computer and devices to electrical outlets, and turn them on.
9. Enter system setup (see [System Setup](#)) and restore the settings you recorded in [step 1](#).
10. Properly dispose of the old battery. See the *Product Information Guide* for battery disposal information.

---

## Removing the Computer Stand

- CAUTION:** Before you begin any of the procedures in this section, follow the safety instructions in the *Product Information Guide*.
- CAUTION:** Your computer is heavy and can be difficult to maneuver. Seek assistance before attempting to lift, move, or tilt the computer and always lift correctly to avoid injury; avoid bending over while lifting.
- CAUTION:** The computer stand should be installed at all times to ensure maximum system stability. Failure to install the stand could result in the computer tipping over, potentially resulting in bodily injury or damage to the computer.

1. Follow the procedures in [Before You Begin](#).
2. Loosen the captive screw securing the stand to the base of the computer.
3. Gently slide the stand back, towards the rear of the computer, then pull the stand away from the computer to remove it.

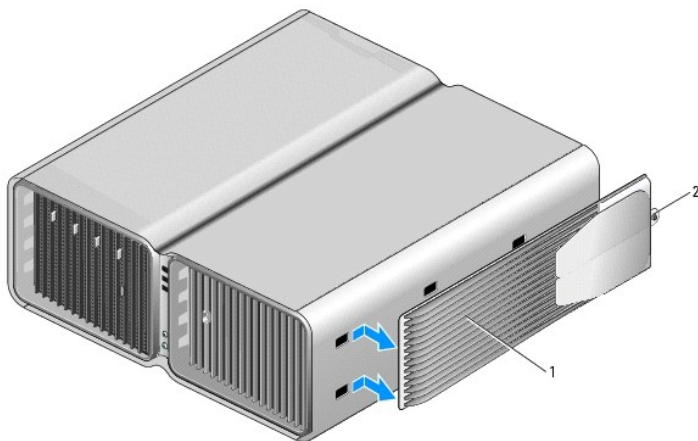

1	computer stand	2	captive screw
---	----------------	---	---------------

---

## Replacing the Computer Cover

- CAUTION:** Before you begin any of the procedures in this section, follow the safety instructions in the *Product Information Guide*.
- CAUTION:** Your computer is heavy and can be difficult to maneuver. Seek assistance before attempting to lift, move, or tilt the computer and always lift correctly to avoid injury; avoid bending over while lifting.
- CAUTION:** The computer stand should be installed at all times to ensure maximum system stability. Failure to install the stand could result in the computer tipping over, potentially resulting in bodily injury or damage to the computer.
- NOTICE:** To avoid electrostatic discharge and damage to internal components, ground yourself by using a wrist grounding strap or by periodically touching an unpainted metal surface on the computer chassis.

1. Ensure that all cables are connected, and fold cables out of the way.
2. Ensure that no tools or extra parts are left inside the computer.
3. Pivot the cover down and into position.



4. Press down on the cover until it clicks into place.

 **NOTE:** The computer cover should easily snap into place; however, if necessary, pull back on the cover release latch until the cover is completely closed, then slide the release latch forward to secure the cover.

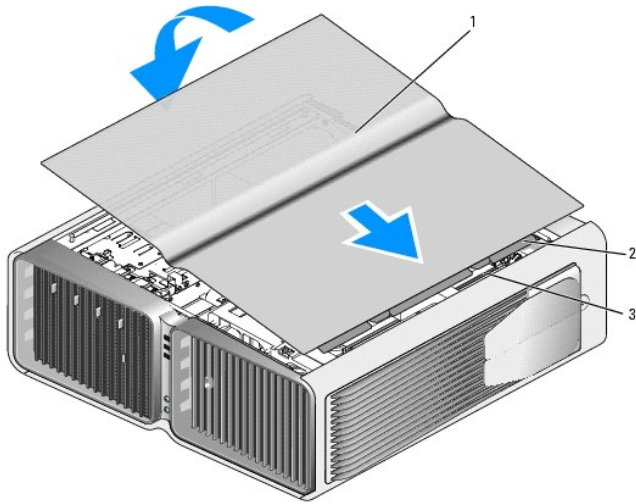

1	computer cover	2	cover hinge tabs	3	hinge slots
---	----------------	---	------------------	---	-------------

5. Carefully, lift the rear of the computer and slide the stabilizing feet outward into the open position.

6. With the help of an assistant, carefully set the computer upright.

 **NOTICE:** To connect a network cable, first plug the cable into the network port or device and then plug it into the computer.

7. Connect your computer and devices to electrical outlets, and turn them on.

---

[Back to Contents Page](#)

[Back to Contents Page](#)

## Optimizing Performance

Dell™ XPS™ 710 Owner's Manual

- [Understanding PCI Express Cards](#)
  - [Understanding Dual Graphics Technology](#)
  - [Understanding CPU Over-Clocking](#)
- 

### Understanding PCI Express Cards

PCI Express is the next generation technology for graphics cards and PCI cards. The PCI Express x16 slot is used in place of the AGP graphics card slot. The dimensions of PCI Express card slots are different from those of the PCI card slots, and the cards are not interchangeable (you cannot install a PCI card in a PCI Express card slot, or a PCI Express card in a PCI card slot).

Some benefits of PCI Express technology include:

- 1 Greater available bandwidth — PCI Express bus bandwidth is 250 MB/s in each direction per lane simultaneously, while PCI bus bandwidth is 133 MB/s in one direction at a time.
  - 1 Prioritization of service — Multiple PCI cards installed in a computer all share a common bus, but each PCI Express card operates on its own channel. Activities such as video conferencing and web camera functions can be automatically prioritized through the device software to reduce latency.
- 

### Understanding Dual Graphics Technology

With dual-graphics technology, an optional second PCI Express graphics card will significantly increase graphics performance on your computer. Benefits of this technology can be seen in the improved portrayal of the 3-D graphics used in gaming and design applications.

Each graphics card includes at least one GPU (graphics processing unit). In dual graphics card configurations, multiple GPUs dynamically share their workload to provide the best possible performance. For a given application, the software selects the optimum rendering (processing) mode.

For more information, see the documentation that came with your graphics card.

---

### Understanding CPU Over-Clocking

- **NOTICE:** Dell does not recommend operating the CPU at a frequency that is greater than the manufacturer's design specifications. Operating the CPU in this manner may cause your system to shut down unexpectedly, may result in a loss of data, and may reduce the operational life of the processor. If the system shuts down unexpectedly or is unstable, select a lower CPU operating frequency.

Your Dell computer provides the limited capability to adjust the operating frequency, or clock speed, of the processor.

Altering the CPU operating frequency (commonly referred to as *over-clocking*) enables you to increase the speed of the processor to a frequency that is faster than the processor manufacturer's design specifications, and possibly enhance the overall performance of your system.

Dell does not guarantee that your computer will function or remain stable during the use of any extended operating frequencies. If your computer shuts down unexpectedly or is unstable, select a lower operating frequency for the CPU.

You can make limited adjustments to the CPU operating frequency in system setup. For more information on accessing system setup, see [System Setup](#).

---

[Back to Contents Page](#)

## Setting Up and Using Your Computer

### Dell™ XPS™ 710 Owner's Manual

- [Front and Back View of the Computer](#)
- [Attaching the Computer Stand](#)
- [Connecting Monitors](#)
- [About Your RAID Configuration](#)
- [Playing CDs and DVDs](#)
- [Copying CDs and DVDs](#)
- [Using a Media Card Reader \(Optional\)](#)
- [Network Setup Wizard](#)
- [Transferring Information to a New Computer](#)
- [Power Management](#)

## Front and Back View of the Computer

### Front View

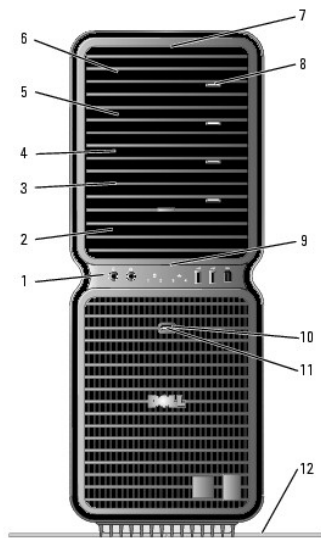

1	front I/O connectors	Plug USB and other devices into the appropriate connectors (see <a href="#">Front I/O Connectors</a> ).
2	3.5-inch drive bays (2)	Can hold an optional Media Card Reader or floppy drive.
3-6	5.25-inch drive bays (4)	Can hold a CD/DVD drive, or a SATA hard drive in a 5.25-inch drive bay carrier.  <b>NOTE:</b> The hard-drive carrier is only for use in the 5.25-inch drive bays. The floppy-drive/Media Card Reader and hard-drive carriers are not interchangeable.
7	front panel LEDs (4)	Multi-colored lights provide illumination for the front of the computer.  <b>NOTE:</b> The color of the front panel LEDs can be adjusted in system setup (see <a href="#">System Setup</a> ).
8	CD/DVD drive tray eject button (4)	Use to eject the drive tray of a CD/DVD drive.  <b>NOTE:</b> The CD/DVD drive tray eject button is not a handle. The self-opening doors open automatically when the eject button is pressed and the drive tray is ejected.
9	front panel LEDs (4)	Multi-colored lights provide illumination for the front of the computer.  <b>NOTE:</b> The color of the front panel LEDs can be adjusted in system setup (see <a href="#">System Setup</a> ).

10	power button	<p>Press to turn on the computer.</p> <p><b>NOTICE:</b> To avoid losing data, do not use the power button to turn off the computer. Instead, perform an operating system shutdown.</p> <p><b>NOTE:</b> The power button can also be used to wake the system or to place it into a power-saving state (see <a href="#">Power Management</a>).</p>
11	power light	<p>The power light illuminates and blinks or remains solid to indicate different states:</p> <ul style="list-style-type: none"> <li>○ No light — The computer is turned off.</li> <li>○ Steady green — The computer is in a normal operating state.</li> <li>○ Blinking green — The computer is in a power-saving state.</li> <li>○ Steady amber — There may be a problem with an installed device (see <a href="#">Solving Problems</a>).</li> <li>○ Blinking amber — An internal power problem may exist (see <a href="#">Power Problems</a>).</li> </ul>
12	computer stand	<p>Attach the computer stand to provide stability to the system.</p> <p><b>CAUTION:</b> The computer stand should be installed at all times to ensure maximum system stability. Failure to install the stand could result in the computer tipping over, potentially resulting in bodily injury or damage to the computer.</p>

## Front I/O Connectors

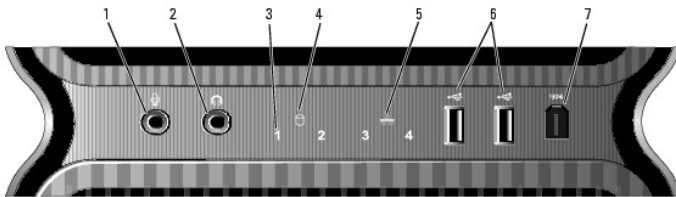

1	microphone connector	Use the microphone connector to attach a personal computer microphone for voice or musical input into a sound or telephony program.
2	headphone connector	Use the headphone connector to attach headphones.
3	diagnostic lights (4)	Use the sequence of these diagnostics lights to help troubleshoot a problem with your computer (see <a href="#">Diagnostic Lights</a> ).
4	hard-drive activity light	The hard drive light is on when the computer reads data from or writes data to the hard drive. The light may also be on when a device such as your CD player is operating.
5	network link light	The network link light is on when a good connection exists between a network and the computer.
6	USB 2.0 connectors (2)	Use the front USB connectors for devices that you connect occasionally, such as flash memory keys, cameras, or bootable USB devices. For more information on bootable USB devices see <a href="#">Boot Sequence</a> .  It is recommended that you use the back USB connectors for devices that typically remain connected, such as printers and keyboards.
7	IEEE 1394 connector	Use the IEEE 1394 connector for high-speed data devices such as digital video cameras and external storage devices.

## Back View

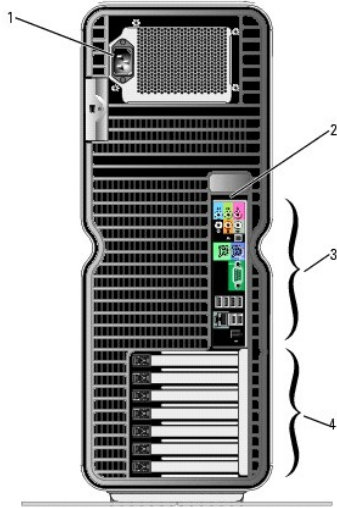

1	power connector	Insert the power cable. The appearance of this connector may differ from what is pictured.
2	back panel LEDs (2)	Multi-colored lights provide illumination for the I/O panel on the back of the computer.  <b>NOTE:</b> The color of the back panel LEDs can be adjusted in system setup (see <a href="#">System Setup</a> ).
3	back I/O connectors	Plug serial, USB, and other devices into the appropriate connectors (see <a href="#">Back I/O Connectors</a> ).
4	card slots	Access connectors for any installed PCI or PCI Express cards.  <b>NOTE:</b> Some connector slots support full-length cards.

### Back I/O Connectors

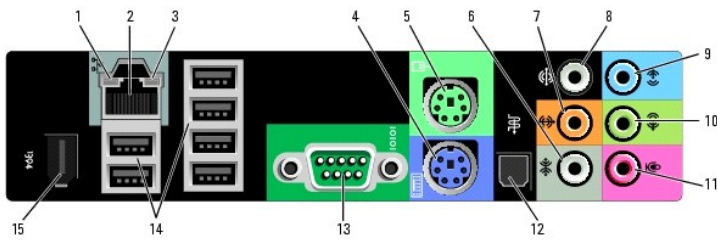



1	link integrity light	<ul style="list-style-type: none"> <li>1 Green — A good connection exists between a 10-Mbps network and the computer.</li> <li>1 Orange — A good connection exists between a 100-Mbps network and the computer.</li> <li>1 Yellow — A good connection exists between a 1000-Mbps (1-Gbps) network and the computer.</li> <li>1 Off — The computer is not detecting a physical connection to the network.</li> </ul>
2	network adapter connector	<p><b>NOTICE:</b> Do not plug a telephone cable into the network adapter connector.</p> <p>Use the network adapter connector to attach your computer to a network or broadband device. Connect one end of a network cable to either a network jack or your network or broadband device, and then connect the other end of the network cable to the network adapter connector on your computer. A click indicates that the network cable has been securely attached.</p> <p>On computers with an additional network connector card, use the connectors on the card and on the back of the computer when setting up multiple network connections (such as a separate intra-</p>

		and extranet).  <b>NOTE:</b> It is recommended that you use Category 5 wiring and connectors for your network. If you must use Category 3 wiring, force the network speed to 10 Mbps to ensure reliable operation.
3	network activity light	Flashes a yellow light when the computer is transmitting or receiving network data. A high volume of network traffic may make this light appear to be in a steady "on" state.
4	keyboard connector	Plug a standard PS/2 keyboard into the purple keyboard connector. Turn off the computer and any attached devices before you connect a keyboard to the computer. If you have a USB keyboard, plug it into a USB connector.
5	mouse connector	Plug a standard PS/2 mouse into the green mouse connector. Turn off the computer and any attached devices before you connect a mouse to the computer. If you have a USB mouse, plug it into a USB connector.
6	side surround sound connector	Use the (silver) side surround connector to attach additional speakers.
7	center subwoofer/LFE connector	Use the (orange) subwoofer connector to attach a single subwoofer.  <b>NOTE:</b> The LFE (Low Frequency Effects) Audio channel, found in digital surround sound audio schemes, carries only low frequency information of 80 Hz and below. The LFE channel drives a subwoofer to provide extremely low bass extension. Systems not using subwoofers can shunt the LFE information to the main speakers in the surround sound setup.
8	surround sound connector	Use the (black) surround sound connector to attach multichannel-capable speakers.
9	line-in connector	Use the (blue) line-in connector to attach a record/playback device such as a cassette player, CD player, or VCR.  On computers with a sound card, use the connector on the card.
10	line-out/headphone connector	Use the (green) line-out connector to attach headphones and speakers with integrated amplifiers.  On computers with a sound card, use the connector on the card.
11	microphone connector	Use the (pink) microphone connector to attach a personal computer microphone for voice or musical input into a sound or telephony program.
12	S/PDIF connector	Use the S/PDIF connector to transmit digital audio without going through an analog audio conversion process.
13	serial connector	Connect a serial device, such as a handheld device, to the serial port. If necessary, the address for this port can be modified through system setup (see <a href="#">System Setup</a> ).
14	USB 2.0 connectors (6)	Use the back USB connectors for devices that typically remain connected, such as printers and keyboards.  <b>NOTE:</b> It is recommended that you use the front USB connectors for devices that you connect occasionally, such as flash memory keys, cameras, or bootable USB devices.
15	IEEE 1394 connector	Use the IEEE 1394 connector for high-speed data devices such as digital video cameras and external storage devices.

## Attaching the Computer Stand

 **CAUTION:** Before you begin any of the procedures in this section, follow the safety instructions in the *Product Information Guide*.

 **CAUTION:** Your computer is heavy and can be difficult to maneuver. Seek assistance before attempting to lift, move, or tilt the computer and always lift correctly to avoid injury; avoid bending over while lifting.

 **CAUTION:** The computer stand should be installed at all times to ensure maximum system stability. Failure to install the stand could result in the computer tipping over, potentially resulting in bodily injury or damage to the computer.

1. Follow the procedures in [Before You Begin](#).
2. Remove the thumb screw that is installed on the base of the computer.

 **NOTE:** If the thumb screw is not already installed in the stand, it has been packaged separately.

3. Insert the six alignment tabs into the corresponding slots on the base of the computer, then slide the stand forward until all six tabs catch in the slots.

4. Ensure that the screw hole on the stand is aligned with the screw hole on the base of the computer.
5. Insert the captive screw into the screwhole, then tighten the screw to secure the stand to the base of the computer.



1	captive screw	2	stabilizing feet (closed)	3	computer stand
4	slots (6)				

6. With the help of an assistant, carefully set the computer upright.
7. Carefully, lift the rear of the computer and slide the stabilizing feet outward into the open position.

## Connecting Monitors

- CAUTION:** Before you perform any of the procedures in this section, follow the safety instructions in the *Product Information Guide*.
- CAUTION:** To reduce the risk of fire, electric shock, or injury, do not overload an electrical outlet, power strip, or convenience receptacle. The total ampere rating of all products plugged into an electrical outlet, power strip, or other receptacle should not exceed 80 percent of the branch circuit rating.
- NOTE:** Depending on the options selected when you purchased your computer, your video card may have two DVI ports, or one DVI and one VGA port.

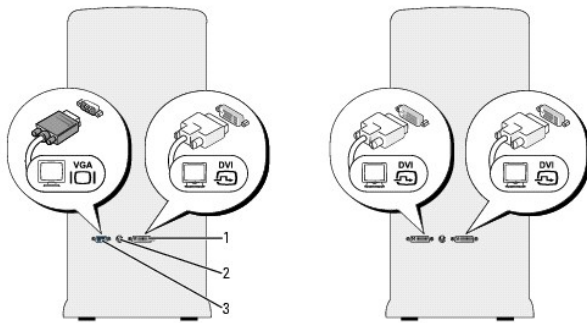

1	DVI (white) connector	2	TV-OUT connector	3	VGA (blue) connector
---	-----------------------	---	------------------	---	----------------------

## Connecting a Monitor (Without an Adapter)

- CAUTION:** Before you perform any of the procedures in this section, follow the safety instructions in the *Product Information Guide*.
- NOTE:** If your monitor has a VGA connector and your computer does not have a VGA port, follow the instructions in [Connecting a Monitor \(With an Adapter\)](#).

1. Turn off the computer and all attached devices:
  - a. Click **Start**, then click **Turn Off Computer**.
  - b. In the **Turn off computer** window, click **Turn off**.

The computer performs a shutdown of the operating system, and then turns off.

 **NOTE:** Ensure that the computer is off and not in a power management mode. If you cannot shut down the computer using the operating system, press and hold the power button for 4 seconds.

2. Disconnect the computer and all attached devices from their electrical outlets.
3. Connect the DVI or VGA connector of your monitor to the appropriate connector on the back of the computer:
 

To connect a monitor with a DVI connector, use the (white) DVI port on your computer.

To connect a monitor with a VGA connector, use the (blue) VGA port on your computer.

## Connecting a Monitor (With an Adapter)

 **CAUTION:** Before you perform any of the procedures in this section, follow the safety instructions in the *Product Information Guide*.

 **NOTE:** In order to connect a monitor with a VGA connector to the DVI port on the back of your computer, a DVI-to-VGA adapter is required.

1. Turn off the computer and all attached devices:
  - a. Click **Start**, then click **Turn Off Computer**.
  - b. In the **Turn off computer** window, click **Turn off**.

The computer performs a shutdown of the operating system, and then turns off.
2. Disconnect the computer and all attached devices from their electrical outlets.
3. Connect the DVI-to-VGA adapter to the VGA connector on your monitor, and then connect the other end of the adapter to the (white) DVI port on the back of the computer.

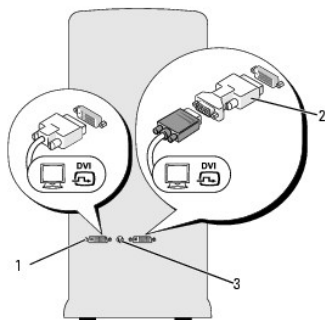

1	DVI (white) connector	2	DVI-to-VGA adapter (optional)	3	TV-OUT connector
---	-----------------------	---	-------------------------------	---	------------------

## Connecting a Monitor in a Dual Graphics Card Configuration

 **CAUTION:** Before you perform any of the procedures in this section, follow the safety instructions in the *Product Information Guide*.

Dual graphics card configurations with multi-GPU technology enabled support only a single monitor. The monitor must be connected to the primary graphics card in order to function.

 **NOTE:** If your primary graphics card is equipped with two DVI ports and you are using a monitor with a VGA connector, a DVI-to-VGA adapter is required to connect the monitor (see [Connecting a Monitor \(With an Adapter\)](#)).



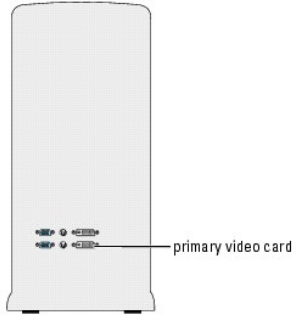

1. Turn off the computer and all attached devices:
  - a. Click **Start**, then click **Turn Off Computer**.
  - b. In the **Turn off computer** window, click **Turn off**.

The computer performs a shutdown of the operating system, and then turns off.

 **NOTE:** Ensure that the computer is off and not in a power management mode. If you cannot shut down the computer using the operating system, press and hold the power button for 4 seconds.

2. Disconnect the computer and all attached devices from their electrical outlets.
3. Connect the DVI or VGA connector of your monitor to the appropriate connector on the computer's primary graphics card:

To connect a monitor with a DVI connector, use the (white) DVI port on the primary graphics card.

To connect a monitor with a VGA connector, use the (blue) VGA port on the primary graphics card.

## Connecting Two or More Monitors

 **CAUTION:** Before you perform any of the procedures in this section, follow the safety instructions in the *Product Information Guide*.

 **NOTE:** In order to connect and use two or more monitors in a dual graphics card configuration, multi-GPU technology must be disabled. To disable multi-GPU, see [Changing the Display Settings to Support Two or More Monitors](#).

 **NOTE:** Depending on the options selected when you purchased your computer, your video card may have two DVI ports, or one DVI and one VGA port.

1. Turn off the computer and all attached devices:
  - a. Click **Start**, then click **Turn Off Computer**.
  - b. In the **Turn off computer** window, click **Turn off**.

The computer performs a shutdown of the operating system, and then turns off.

 **NOTE:** Ensure that the computer is off and not in a power management mode. If you cannot shut down the computer using the operating system, press and hold the power button for 4 seconds.

2. Disconnect the computer and all attached devices from their electrical outlets.
3. Connect two or more monitors to the appropriate DVI or VGA ports on the back of the computer.

 **NOTE:** In order to connect a monitor with a VGA connector to the DVI port on the back of your computer, a DVI-to-VGA adapter is required.

To connect two or more monitors directly to the DVI or VGA ports on your computer, see [Connecting a Monitor \(Without an Adapter\)](#).

To connect the VGA connectors of one or more monitors to the DVI port(s) on your computer, see [Connecting a Monitor \(With an Adapter\)](#).

4. Change the display settings to support multiple monitors (see [Changing the Display Settings to Support Two or More Monitors](#)).

## Connecting a TV

 **CAUTION:** Before you perform any of the procedures in this section, follow the safety instructions in the *Product Information Guide*.

 **NOTE:** If you are connecting a TV to your computer, you may connect only one monitor (VGA or DVI) in addition to the TV.

 **NOTE:** See the documentation that came with your TV to ensure that you properly configure and connect the TV.

To connect a TV to your computer, an S-video cable is required. If you do not have an S-video cable, you may purchase one at most consumer electronics stores. An S-video cable is not included with your computer.

1. Turn off the computer and all attached devices:
  - a. Click **Start**, then click **Turn Off Computer**.
  - b. In the **Turn off computer** window, click **Turn off**.

The computer performs a shutdown of the operating system, and then turns off.

 **NOTE:** Ensure that the computer is off and not in a power management mode. If you cannot shut down the computer using the operating system, press and hold the power button for 4 seconds.

2. Disconnect the computer and all attached devices from their electrical outlets.
3. Connect one end of the S-video cable to the TV-OUT connector on the back of the computer.
4. Connect the other end of the S-video cable to the S-video input connector on your TV.
5. Connect one monitor, as needed, with a DVI or VGA connector as described in [Connecting Monitors](#).

## Changing the Display Settings to Support Two or More Monitors

 **NOTE:** Dual graphics card configurations with multi-GPU technology enabled support only a single monitor. In order to connect and use two or more monitors in a dual graphics card configuration with multi-GPU technology, multi-GPU must be disabled.

1. With your monitors connected and turned on, turn on the computer.

The Microsoft® Windows® desktop displays on the primary monitor.

2. Disable multi-GPU technology in the display settings (applies only to dual graphics card configurations with multi-GPU technology enabled):

For information on disabling multi-GPU technology, see the documentation that came with your graphics card.

3. Enable clone mode or extended desktop mode in the display settings.

    | In clone mode, all monitors display the same image.

    | In extended desktop mode, you can drag objects from one screen to the other, increasing the amount of viewable work space.

For more information on changing the display settings for your graphics card, see the device user's guide in the Help and Support Center (click **Start**, click **Help and Support**, click **User and system guides**, click **Device guides**, and then click the guide for your graphics card).

---

## About Your RAID Configuration

 **NOTE:** In order to use the migrating option to convert a RAID configuration without losing data, your hard drive must initially be set up as a single drive RAID 0 array before the operating system is loaded onto the drive (see [Using the Nvidia MediaShield ROM Utility](#) for instructions).

This section provides an overview of the RAID configuration you may have selected when you purchased your computer. There are several RAID configurations available in the computer industry for different types of uses. Your Dell XPS computer supports RAID level 0 and RAID level 1. A RAID level 0 configuration is recommended for high-performance programs while RAID level 1 is recommended for users that desire a high level of data integrity.

 **NOTE:** RAID levels do not represent a hierarchy. A RAID level 1 configuration is not inherently better or worse than a RAID level 0 configuration.

The drives in a RAID configuration should be the same size in order to ensure that the larger drive does not contain unallocated (and therefore unusable) space.

## RAID Level 0 Configuration

 **NOTE:** Because a RAID level 0 configuration provides no data redundancy, a failure of one drive results in the loss of all data. To protect your data when using a RAID level 0 configuration, perform regular backups.

RAID level 0 uses a storage technique known as data striping to provide a high data access rate. Data striping is a method of writing consecutive segments, or stripes, of data sequentially across the physical drive(s) to create a large virtual drive. Data striping allows one of the drives to read data while the other drive is searching for and reading the next block.

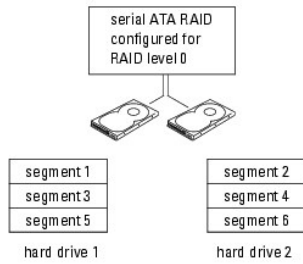

Another advantage of a RAID level 0 configuration is that it utilizes the full storage capacities of the drives. For example, two 120-GB hard drives combine to provide 240 GB of hard drive space on which to store data.

**NOTE:** In a RAID level 0 configuration, the size of the configuration is equal to the size of the smallest drive multiplied by the number of drives in the configuration.

## RAID Level 1 Configuration

RAID level 1 uses a data-redundancy storage technique known as mirroring to enhance data integrity. When data is written to the primary drive, the data is also duplicated, or mirrored, on the second drive in the configuration. A RAID level 1 configuration sacrifices high data-access rates for its data redundancy advantages.

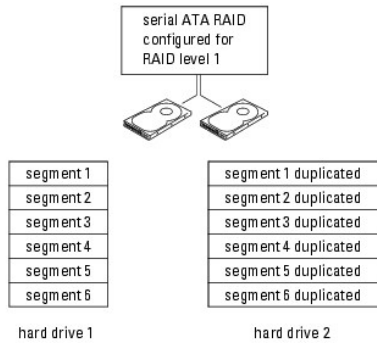

If a drive failure occurs, subsequent read and write operations are directed to the surviving drive. A replacement drive can then be rebuilt using the data from the surviving drive.

**NOTE:** In a RAID level 1 configuration, the size of the configuration is equal to the size of the smallest drive in the configuration.

## Configuring Your Hard Drives for RAID

Your computer can be configured for RAID, even if you did not select a RAID configuration when the computer was purchased. For an explanation of RAID levels and their requirements, see [About Your RAID Configuration](#). For information on how to install a hard drive, see [Installing a Hard Drive](#).

You can use one of two methods to configure RAID hard drive volumes. The first method uses the Nvidia MediaShield ROM utility and is performed *before* you install the operating system onto the hard drive. The second method uses Nvidia MediaShield and is performed *after* you have installed the operating system and Nvidia RAID drivers.

Both methods require that you set your computer to RAID-enabled mode before you begin.

### Setting Your Computer to RAID-Enabled Mode

1. Enter system setup (see [Entering System Setup](#)).
2. Press the up- and down-arrow keys to highlight **Drives**, then press <Enter>.
3. Press the up- and down-arrow keys to highlight the applicable SATA drive, then press <Enter>.
4. Press the left- and right-arrow keys to highlight **RAID On**, and then press <Enter>. Repeat the process, as needed, for each SATA hard drive.

**NOTE:** For more information about RAID options, see [System Setup Options](#).

5. Press <Esc>, press the left- and right-arrow keys to highlight **Save/Exit**, and then press <Enter> to exit system setup and resume the boot process.

## Using the Nvidia MediaShield ROM Utility

 **NOTICE:** The following procedure will result in the loss of all data on your hard drive(s). Back up any data you want to keep before continuing.

 **NOTE:** Do not use the following procedure to migrate an existing RAID configuration (see [Converting From One RAID Configuration to Another RAID Configuration](#)).

Hard drives of any size may be used to create a RAID configuration. Ideally, however, the drives should be of equal size to avoid unallocated or unused space. For an explanation of RAID levels and their requirements, see [About Your RAID Configuration](#). For information on how to install a hard drive, see [Installing a Hard Drive](#).

1. Enable RAID for each applicable hard drive on your computer (see [Setting Your Computer to RAID- Enabled Mode](#)).
2. Restart the computer.
3. Press <Ctrl><N> when prompted to enter the RAID BIOS.

 **NOTE:** If the operating system logo appears, continue to wait until you see the Microsoft Windows desktop, then shut down your computer and try again.

The **Define a New Array** window appears.

4. Press <Tab> to navigate to the **RAID Mode** field.

To create a RAID 0 configuration, use the arrow keys to select **Striping**.

To create a RAID 1 configuration, use the arrow keys to select **Mirroring**.

5. Press <Tab> to navigate to the **Free Disks** field.

6. Use the up- and down-arrow keys to select a hard drive to include in the RAID array and then use the right-arrow key to move the selected drive from the **Free Disks** field to the **Array Disks** field. Repeat for each disk you want to include in the RAID array.

 **NOTE:** Your computer supports a maximum of two drives per RAID 1 array and four drives per RAID 0 array.

7. After assigning the hard drives to an array, press <F9>.

The **Clear disk data** prompt appears.

 **NOTICE:** You will lose all data on the selected drives in the next step.

8. Press <Y> to clear all data from the selected drives.

The **Array List** window appears.

9. To review the details of the array that you set up, use the arrow keys to highlight the array in the **Array Detail** window and press <Enter>.

The **Array Detail** window appears.

 **NOTE:** To delete an array, use the arrow keys to select the array and press <D>.

10. Press <Enter> to return to the previous screen.

11. Press <Ctrl><X> to exit the RAID BIOS.

## Using Nvidia MediaShield

Nvidia MediaShield allows you to create, view, and manage RAID configurations.

 **NOTE:** Use Nvidia MediaShield to create a RAID configuration only when you are adding one or more new hard drives to an existing (non-RAID) single-drive computer, and you want to configure the new drive(s) into a RAID array.

Hard drives of any size may be used to create a RAID configuration using Nvidia MediaShield. Ideally, however, the drives should be of equal size to avoid unallocated or unused space. For an explanation of RAID levels and their requirements, see [About Your RAID Configuration](#).

## Creating a RAID Array

 **NOTICE:** The following procedure will result in the loss of all data on your hard drive(s). Back up any data you want to keep before continuing.

 **NOTE:** Do not use the following procedure to migrate an existing RAID configuration (see [Converting From One RAID Configuration to Another RAID Configuration](#)).

1. Enable RAID on your hard drives (see [Setting Your Computer to RAID-Enabled Mode](#)).

2. After rebooting your computer, launch Nvidia MediaShield.

3. Click **Create** under **System Tasks**.

The **NVIDIA Create Array Wizard** appears and lists the disks that are available for configuration.

4. Click **Next**.

5. Click **Custom**, then click **Next**.

6. Use the drop-down box to select **Striping** (RAID 0) or **Mirroring** (RAID 1).

7. Click **Next**.

The **Free Disk Selection** window appears.

 **NOTE:** Only RAID-enabled hard drives are listed as free disks.

8. Click to select the drives that will make up the RAID configuration, click **Next**, and then click **Next** again.

 **NOTE:** Your computer supports a maximum of two drives per RAID 1 array and four per RAID 0 array.

The **Clearing System Data** window appears.

 **NOTICE:** The **Clear System Data** option deletes all data on the selected drive.

9. Click **Next**.

10. Click **Finish** to create the RAID configuration.

The MediaShield RAID management utility window appears and lists the array along with any other installed hard drives.

## Deleting a RAID Array

 **NOTE:** While this procedure deletes the RAID 1 volume, it also splits the RAID 1 volume into two non-RAID hard drives with a partition, and leaves any existing data files intact. Deleting a RAID 0 volume, however, destroys all data on the volume.

 **NOTE:** If your computer currently boots to RAID and you delete the RAID volume, your computer will become unbootable.

1. Launch Nvidia MediaShield.

2. Click to select the array you want to delete.

3. Click **Delete Array** in the **System Tasks** pane.

The **NVIDIA Delete Array Wizard** appears.

4. Click **Next**.

A confirmation screen appears with the name and size of the array that you have marked for deletion.

5. Click **Finish** to delete the RAID configuration.

The MediaShield RAID management utility window appears and lists any remaining arrays along with any other installed hard drives.

## Converting From One RAID Configuration to Another RAID Configuration

 **NOTICE:** In order to use the migrating option to convert a RAID configuration without losing data, your hard drive must initially be set up as a single drive RAID 0 array before the operating system is loaded onto the drive (see [Using the Nvidia MediaShield ROM Utility](#) for instructions).

Nvidia MediaShield utilizes a one-step process known as migrating to change the current state of a disk or array without losing any data. If needed, additional hard drives can be added to an existing array, including a single-drive RAID 0 configuration for conversion to a two-drive RAID 0 configuration; however, the capacity of the resulting array must be equal to or greater than the size of the original configuration.

RAID 1 to RAID 1 conversions cannot be performed using the migrating process:

 **NOTICE:** Additional hard drives to be used in the (migrated) array must be no smaller than any of the drives in the current configuration.

 **NOTE:** Ensure that all drives to be used in the RAID configuration are RAID-enabled (see [Setting Your Computer to RAID-Enabled Mode](#).)

1. Launch Nvidia MediaShield.
2. Click to select the array you want to convert.
3. Click **Convert Array** in the **System Tasks** pane.

The **NVIDIA Convert Array Wizard** appears.

4. Click **Next**.
5. Under **RAID Mode Selection**, select **Mirroring** or **Striping** from the drop-down menu.
6. Click **Next**.

 **NOTICE:** You will lose all data on the selected drives in the next step.

7. Under **Free Disk Selection**, select the hard drive(s) you want to include in the (migrated) array by clicking the checkbox beside it.
8. Click **Finish**.

The MediaShield RAID management utility window appears and displays the status of the upgrade/migration process along with any other installed hard drives.

 **NOTE:** The time it takes to convert an array depends on several factors, such as the speed of the CPU, the type and size of the hard drive being used, the operating system, etc.

## Rebuilding a RAID Configuration

If one of the hard drives in a RAID array fails, you can rebuild the array by restoring the data to a replacement drive.

 **NOTE:** Rebuilding an array can only be performed on RAID 1 and configurations.

1. Launch Nvidia MediaShield.
2. Click to select your RAID configuration (**Mirroring**) in the management utility window.
3. Select **Rebuild Array** in the **System Tasks** pane.

The **NVIDIA Rebuild Array Wizard** appears.

4. Click **Next**.
5. Select the hard drive you want to rebuild by clicking the checkbox beside it.
6. Click **Next**.
7. Click **Finish**.

The MediaShield RAID management utility window appears and displays the status of the rebuild process.

 **NOTE:** You can use your computer while the computer is rebuilding the array.

 **NOTE:** You can use any available (RAID-enabled) free disk to rebuild an array.

---

## Playing CDs and DVDs

➔ **NOTICE:** Do not press down on the CD or DVD tray when you open or close it. Keep the tray closed when you are not using the drive.

➔ **NOTICE:** Do not move or tilt the computer when you are playing CDs or DVDs.

1. Press the eject button on the front of the computer (see [Front View](#)) to open the drive tray.
2. Place the disc, label side up, in the center of the drive tray.











3. Press the eject button or gently push on the tray to close it.











To format CDs for storing data, to create music CDs, or to copy CDs, see the CD software that came with your computer.

 **NOTE:** Ensure that you observe all copyright laws when you create CDs or DVDs.

A CD player includes the following basic controls:

	Play
	Move backward within the current track
	Pause
	Move forward within the current track
	Stop
	Go to the previous track
	Eject
	Go to the next track

A DVD player includes the following basic controls:

	Stop
	Restart the current chapter
	Play
	Fast forward
	Pause
	Fast reverse
	Advance a single frame while in pause mode
	Go to the next title or chapter
	Continuously play the current title or chapter
	Go to the previous title or chapter
	Eject

For more information on playing CDs or DVDs, click **Help** on the CD or DVD player (if available).

## Adjusting the Volume

 **NOTE:** When the speakers are muted, you do not hear the CD or DVD playing.

1. Click **Start**, point to **All Programs**→**Accessories**→**Entertainment**, and then click **Volume Control**.
2. In the **Master Volume** control window, click and drag the bar in the **Master Volume** column and slide it up or down to increase or decrease the volume.

For more information on volume control options, click **Help** in the **Volume Control** window.

#### Adjusting the Picture

If an error message notifies you that the current resolution and color depth are using too much memory and preventing DVD playback, adjust the display properties.

1. Click **Start**, then click **Control Panel**.
2. Under **Pick a category**, click **Appearance and Themes**.
3. Under **Pick a task...**, click **Change the screen resolution**.
4. In the **Display Properties** window, click and drag the bar in **Screen resolution** to change the setting to **800 by 600 pixels**.
5. Under **Color quality**, click the drop-down menu, and then click **Medium (16 bit)**.
6. Click **OK**.

---

## Copying CDs and DVDs

 **NOTE:** Ensure that you observe all copyright laws when creating CDs or DVDs.

This section applies only to computers that have a CD-RW, DVD+/-RW, or CD-RW/DVD (combo) drive.

 **NOTE:** The types of CD or DVD drives offered by Dell may vary by country.

The following instructions explain how to make an exact copy of a CD or DVD using Roxio Creator Plus - Dell Edition. You can also use Roxio Creator Plus for other purposes, such as creating music CDs from audio files stored on your computer or backing up important data. For help, open Roxio Creator Plus, and then click the question mark icon in the upper-right corner of the window.

### How to Copy a CD or DVD

 **NOTE:** CD-RW/DVD combo drives cannot write to DVD media. If you have a CD-RW/DVD combo drive and you experience recording problems, check for available software patches on the Sonic support website at [www.sonic.com](http://www.sonic.com).

The DVD-writable drives installed in Dell computers can write to and read DVD+/-R, DVD+/-RW and DVD+R DL (dual layer) media, but cannot write to and may not read DVD-RAM or DVD-R DL media.

 **NOTE:** Most commercial DVDs have copyright protection and cannot be copied using Roxio Creator Plus.

1. Click **Start**, point to **All Programs**→**Roxio**→**Creator Projects**, and then click **RecordNow Copy**.
2. Under the **Copy** tab, click **Disc Copy**.
3. To copy the CD or DVD:
  1. *If you have one CD/DVD drive*, ensure that the settings are correct, and then click **Disc Copy**. The computer reads your source CD or DVD and copies the data to a temporary folder on your computer hard drive.

When prompted, insert a blank CD or DVD into the drive and click **OK**.
  1. *If you have two CD/DVD drives*, select the drive into which you have inserted your source CD or DVD, and then click **Disc Copy**. The computer copies the data from the source CD or DVD to the blank CD or DVD.

Once you have finished copying the source CD or DVD, the CD or DVD that you have created automatically ejects.

### Using Blank CDs and DVDs

CD-RW drives can write to CD recording media only (including high-speed CD-RW media) while DVD-writable drives can write to both CD and DVD recording media.



Use blank CD-Rs to record music or permanently store data files. After the maximum storage capacity of a CD-R is reached, you cannot write to that CD-R again (see the Sonic documentation for more information). Use blank CD-RWs if you plan to erase, rewrite, or update information on the CD later.

Blank DVD+/-Rs can be used to permanently store large amounts of data. After you create a DVD+/-R disc, you may not be able to write to that disc again if the disc is *finalized* or *closed* during the final stage of the disc creation process. Use blank DVD+/-RWs if you plan to erase, rewrite, or update information on the disc later.

#### CD-Writable Drives

Media Type	Read	Write	Rewritable
CD-R	Yes	Yes	No
CD-RW	Yes	Yes	Yes

#### DVD-Writable Drives

Media Type	Read	Write	Rewritable
CD-R	Yes	Yes	No
CD-RW	Yes	Yes	Yes
DVD+R	Yes	Yes	No
DVD-R	Yes	Yes	No
DVD+RW	Yes	Yes	Yes
DVD-RW	Yes	Yes	Yes
DVD+R DL	Yes	Yes	No
DVD-R DL	Maybe	No	No
DVD-RAM	Maybe	No	No

## Helpful Tips

- 1 Use Microsoft® Windows® Explorer to drag and drop files to a CD-R or CD-RW only after you start Roxio Creator Plus and open a Creator project.
- 1 Use CD-Rs to burn music CDs that you want to play in regular stereos. CD-RWs may not play in many home or car stereos.
- 1 You cannot create audio DVDs with Roxio Creator Plus.
- 1 Music MP3 files can be played only on MP3 players or on computers that have MP3 software installed.
- 1 Commercially available DVD players used in home theater systems may not support all available DVD formats. For a list of formats supported by your DVD player, see the documentation provided with your DVD player or contact the manufacturer.
- 1 Do not burn a blank CD-R or CD-RW to its maximum capacity; for example, do not copy a 650-MB file to a blank 650-MB CD. The CD-RW drive needs 1–2 MB of blank space to finalize the recording.
- 1 Use a blank CD-RW to practice CD recording until you are familiar with CD recording techniques. If you make a mistake, you can erase the data on the CD-RW and try again. You can also use blank CD-RWs to test music file projects before you record the project permanently to a blank CD-R.
- 1 See the Sonic website at [www.sonic.com](http://www.sonic.com) for additional information.

---

## Using a Media Card Reader (Optional)

 **CAUTION:** Before you perform any of the procedures in this section, follow the safety instructions in the *Product Information Guide*.

Use the media card reader to transfer data directly to your computer.

The media card reader supports the following memory types:

- 1 xD-Picture card
- 1 SmartMedia card (SMC)
- 1 CompactFlash card Type I and II (CF I/II)
- 1 MicroDrive card
- 1 SecureDigital card (SD)
- 1 MiniSD card
- 1 MultiMediaCard (MMC)
- 1 Reduced-size MultiMediaCard (RS-MMC)
- 1 Memory Stick (MS/MS Pro/MS Duo/MS Pro Duo)

For information on installing a media card reader, see [Installing a Media Card Reader](#).

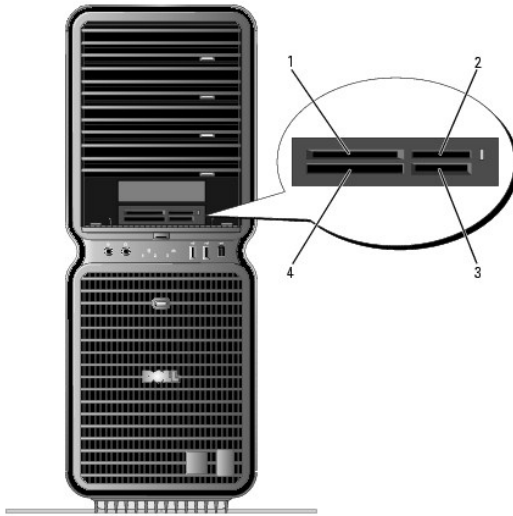

1	xD-Picture card and SmartMedia Card (SMC)	2	Memory Stick (MS/MS Pro/MS Duo/MS Pro Duo)	3	Secure Digital card (SD/miniSD)/MultiMedia-Card (MMC/RS-MMC)
4	CompactFlash card Type I and II (CF I/II) and MicroDrive card				

1. Inspect the media card to determine the proper orientation for insertion.
2. Slide the media card into the appropriate slot of the media card reader until it is completely seated in the connector.  
If you encounter resistance, remove the card, check for proper orientation, and then try again.

## Network Setup Wizard

The Microsoft® Windows® XP operating system provides a Network Setup Wizard to guide you through the process of sharing files, printers, or an Internet connection between computers in a home or small office.

1. Click **Start**, point to **All Programs**→ **Accessories**→ **Communications**, and then click **Network Setup Wizard**.
2. On the welcome screen, click **Next**.
3. Click **Checklist for creating a network**.

 **NOTE:** Selecting the connection method **This computer connects directly to the Internet** enables the integrated firewall provided with Windows XP SP1.

4. Complete the checklist and required preparations.

Return to the Network Setup Wizard and follow the instructions on the screen.

## Transferring Information to a New Computer

The Microsoft® Windows® XP operating system provides a Files and Settings Transfer wizard to move data from one computer to a new computer. You can move data such as:

- 1 E-mail
- 1 Toolbar settings
- 1 Window sizes
- 1 Internet bookmarks

The data can be transferred over a network or serial connection, or you can store it on a removable medium, such as a writable CD/DVD or floppy disk.

To prepare the new computer for the file transfer:

1. Click **Start**, point to **All Programs**→ **Accessories**→ **System Tools**, and then click **Files and Settings Transfer Wizard**.

The **Files and Settings Transfer Wizard** welcome screen appears.

2. Click **Next**.
3. On the **Which computer is this?** screen, click **New Computer**, and then click **Next**.
4. On the **Do you have a Windows XP CD?** screen, click **I will use the wizard from the Windows XP CD**, and then click **Next**.
5. When the **Now go to your old computer** screen appears, go to the source (old) computer that contains the data to be transferred. *Do not click Next at this time.*

To copy data from the source computer:

1. On the source computer, insert the Windows XP *Operating System* CD.
2. On the **Welcome to Microsoft Windows XP** screen, click **Perform additional tasks**.
3. Under **What do you want to do?**, click **Transfer files and settings**.
4. On the **Files and Settings Transfer Wizard** welcome screen, click **Next**.
5. On the **Which computer is this?** screen, click **Old Computer**, and then click **Next**.
6. On the **Select a transfer method** screen, click the transfer method of your preference.
7. On the **What do you want to transfer?** screen, select the items you want to transfer, then click **Next**.

After the information has been copied, the **Completing the Collection Phase** screen appears.

8. Click **Finish**.

To transfer data to the new computer:

1. On the **Now go to your old computer** screen on the new computer, click **Next**.
2. On the **Where are the files and settings?** screen, select the method you chose for transferring your files and settings, and then click **Next**.

The wizard reads the collected files and settings and applies them to your new computer.

When all of the settings and files have been applied, the **Finished** screen appears.

3. Click **Finished** and restart the computer.

---

## Power Management

### Overview

The Microsoft® Windows® XP power management features can reduce the amount of electricity your computer uses when it is on and you are not using it. You can reduce power to just the monitor or the hard drive, or you can use standby mode or hibernate mode to reduce power to the entire computer. When the computer exits from a power conservation mode, it returns to the operating state it was in prior to entering the mode.

 **NOTE:** Windows XP Professional includes security and networking features not available in Windows XP Home Edition. When a Windows XP Professional computer is connected to a network, different options related to security and networking appear in certain windows.

 **NOTE:** The procedures to activate the standby and hibernate modes may vary according to your operating system.

### Standby Mode

Standby mode conserves power by turning off the display and the hard drive after a designated period of time, known as a time-out. When the computer exits from standby mode, it computer returns to the operating state it was in prior to entering standby mode.

 **NOTE:** If your computer loses power while in standby mode, it may lose data.

To set standby mode to automatically activate after a defined period of inactivity:

1. Click **Start**, then click **Control Panel**.
2. Under **Pick a category**, click **Performance and Maintenance**.
3. Under **or pick a Control Panel icon**, click **Power Options**.

To immediately activate standby mode without a period of inactivity, click **Start**, click **Turn Off Computer**, and then click **Stand by**.

To exit from standby mode, press a key on the keyboard or move the mouse.

## Hibernate Mode

Hibernate mode conserves power by copying system data to a reserved area on the hard drive, and then completely turning off the computer. When the computer exits from hibernate mode, the desktop is restored to the state it was in prior to entering hibernate mode.

To activate hibernate mode:

1. Click **Start**, then click **Control Panel**.
2. Under **Pick a category**, click **Performance and Maintenance**.
3. Under **or pick a Control Panel icon**, click **Power Options**.
4. Define your hibernate settings on the [Power Schemes tab](#), [Advanced tab](#), and [Hibernate tab](#).

To exit from hibernate mode, press the power button. The computer may take a short time to exit from hibernate mode. Because the keyboard and mouse do not function in hibernate mode, pressing a key on the keyboard or moving the mouse does not bring the computer out of hibernation.

Because hibernate mode requires a special file on your hard drive with enough disk space to store the contents of the computer memory, Dell creates an appropriately sized hibernate mode file before shipping the computer to you. If the computer's hard drive becomes corrupted, Windows XP recreates the hibernate file automatically.

## Power Options Properties

Define your standby mode settings, hibernate mode settings, and other power settings in the **Power Options Properties** window. To access the **Power Options Properties** window:

1. Click **Start**, then click **Control Panel**.
2. Under **Pick a category**, click **Performance and Maintenance**.
3. Under **or pick a Control Panel icon**, click **Power Options**.
4. [Define your power settings on the Power Schemes tab](#), [Advanced tab](#), and [Hibernate tab](#).

## Power Schemes Tab

Each standard power setting is called a scheme. If you want to select one of the standard Windows schemes installed on your computer, choose a scheme from the **Power schemes** drop-down menu. The settings for each scheme appear in the fields below the scheme name. Each scheme has different settings for starting standby mode, hibernate mode, turning off the monitor, and turning off the hard drive.

 **NOTICE:** If you set the hard drive to time-out before the monitor does, your computer may appear to be locked up. To recover, press any key on the keyboard or click the mouse. To avoid this problem, always set the monitor to time-out before the hard drive.

The **Power schemes** drop-down menu displays the following schemes:

- 1 **Always On** (default) — If you want to use your computer with no power conservation.
- 1 **Home/Office Desk** — If you want your home or office computer to run with little power conservation.
- 1 **Portable/Laptop** — If your computer is a portable computer that you use for traveling.
- 1 **Presentation** — If you want your computer to run without interruption (using no power conservation).
- 1 **Minimal Power Management** — If you want your computer to run with minimal power conservation.
- 1 **Max Battery** — If your computer is a portable computer and you run your computer from batteries for extended periods of time.

If you want to change the default settings for a scheme, click the drop-down menu in the **Turn off monitor**, **Turn off hard disks**, **System stand by**, or **System hibernates** field, and then select a time-out from the displayed list. Changing the time-out for a scheme field permanently changes the default settings for that scheme, unless you click **Save As** and enter a new name for the changed scheme.

## Advanced Tab

The **Advanced** tab allows you to:

- 1 Place the power options icon  in the Windows taskbar for quick access.
- 1 Set the computer to prompt you for your Windows password before the computer exits from standby mode or hibernate mode.
- 1 Program the power button to activate standby mode, activate hibernate mode, or turn off the computer.

To program these functions, click an option from the corresponding drop-down menu and click **OK**.

## Hibernate Tab

The **Hibernate** tab allows you to enable hibernate mode. If you want to use the hibernate settings as defined on the **Power Schemes** tab, click the **Enable hibernate support** check box on the **Hibernate** tab.

For more information on power management options:

1. Click **Start**, then click **Help and Support**.
2. In the **Help and Support** window, click **Performance and maintenance**.
3. In the **Performance and maintenance** window, click **Conserving power on your computer**.

---

[Back to Contents Page](#)

[Back to Contents Page](#)

## Solving Problems

Dell™ XPS™ 710 Owner's Manual

- [Troubleshooting Tips](#)
- [Battery Problems](#)
- [Drive Problems](#)
- [E-Mail, Modem, and Internet Problems](#)
- [Error Messages](#)
- [IEEE 1394 Device Problems](#)
- [Keyboard Problems](#)
- [Lockups and Software Problems](#)
- [Memory Problems](#)
- [Mouse Problems](#)
- [Network Problems](#)
- [Power Problems](#)
- [Printer Problems](#)
- [Scanner Problems](#)
- [Sound and Speaker Problems](#)
- [Video and Monitor Problems](#)

---

### Troubleshooting Tips

Follow these tips when you troubleshoot your computer:

- 1 If you added or removed a part before the problem started, review the installation procedures and ensure that the part is correctly installed.
- 1 If a peripheral device does not work, ensure that the device is properly connected.
- 1 If an error message appears on the screen, write down the exact message. This message may help support personnel diagnose and fix the problem(s).

If an error message occurs in a program, see the program's documentation.

---

### Battery Problems

 **CAUTION:** There is a danger of a new battery exploding if it is incorrectly installed. Replace the battery only with the same or equivalent type recommended by the manufacturer. Discard used batteries according to the manufacturer's instructions.

 **CAUTION:** Before you begin any of the procedures in this section, follow the safety instructions in the *Product Information Guide*.

**Replace the battery** — If you have to repeatedly reset time and date information after turning on the computer, or if an incorrect time or date displays during start-up, replace the battery (see [Replacing the Battery](#)). If the battery still does not work properly, contact Dell (see [Contacting Dell](#)).

---

### Drive Problems

 **CAUTION:** Before you begin any of the procedures in this section, follow the safety instructions in the *Product Information Guide*.

**Ensure that Microsoft® Windows® Recognizes the drive** — Click **Start**, then click **My Computer**. If the floppy, CD, or DVD drive is not listed, perform a full scan with your antivirus software to check for and remove viruses. Viruses can sometimes prevent Windows from recognizing the drive.

**Test the drive** —

- 1 Insert another floppy disk, CD, or DVD to eliminate the possibility that the original drive is defective.
- 1 Insert a bootable floppy disk and restart the computer.

**Clean the drive or disk** —

See [Cleaning Your Computer](#).

**Check the cable connections**

Run the Hardware Troubleshooter — See [Resolving Software and Hardware Incompatibilities](#).

Run the Dell Diagnostics —

See [Dell Diagnostics](#).

## CD and DVD drive problems

 **NOTE:** High-speed CD or DVD drive vibration is normal and may cause noise, which does not indicate a defect in the drive or the CD or DVD.

 **NOTE:** Because of different regions worldwide and different disc formats, not all DVD titles work in all DVD drives.

Adjust the Windows volume control —

1. Click the speaker icon in the lower-right corner of your screen.
1. Ensure that the volume is turned up by clicking the slider and dragging it up.
1. Ensure that the sound is not muted by clicking any boxes that are checked.

Check the speakers and subwoofer — See [Sound and Speaker Problems](#).

## Problems writing to a CD/DVD-RW drive

**Close other programs** — The CD/DVD-RW drive must receive a steady stream of data during the writing process. If the stream is interrupted, an error occurs. Try closing all programs before you write to the CD/DVD-RW.

**Turn off standby mode in Windows before writing to a CD/DVD-RW disc** — See [Standby Mode](#) or search for the keyword *standby* in Windows Help and Support Center (click **Start**, then click **Help and Support**) for information on power management modes.

## Hard drive problems

Run Check Disk —

1. Click **Start**, then click **My Computer**.
2. Right-click **Local Disk C:**.
3. Click **Properties**.
4. Click the **Tools** tab.
5. Under **Error-checking**, click **Check Now**.
6. Click **Scan for and attempt recovery of bad sectors**.
7. Click **Start**.

---

## E-Mail, Modem, and Internet Problems

 **CAUTION:** Before you begin any of the procedures in this section, follow the safety instructions in the *Product Information Guide*.

 **NOTE:** Connect the modem to an analog telephone jack only. The modem does not operate while it is connected to a digital telephone network.

 **NOTE:** Do not plug a telephone cable into the network adapter connector (see [Back I/O Connectors](#)).

**Check the Microsoft Outlook® Express security settings** — If you cannot open your e-mail attachments:

1. In Outlook Express, click **Tools**, click **Options**, and then click **Security**.
2. Click **Do not allow attachments** to remove the checkmark, as needed.

**Check the telephone line connection —**

**Check the telephone jack —**

**Connect the modem directly to the telephone wall jack —**

**Use a different telephone line —**

1. Verify that the telephone line is connected to the jack on the modem (the jack has either a green label or a connector-shaped icon next to it).
1. Ensure that you hear a click when you insert the telephone line connector into the modem.
1. Disconnect the telephone line from the modem and connect it to a telephone, then listen for a dial tone.
1. If you have other telephone devices sharing the line, such as an answering machine, fax machine, surge protector, or line splitter, bypass them and use the telephone to connect the modem directly to the telephone wall jack. If you are using a line that is 3 m (10 ft) or more in length, try a shorter one.

**Run the Modem Helper diagnostics —** Click **Start**, point to **All Programs**, and then click **Modem Helper**. Follow the instructions on the screen to identify and resolve modem problems. Modem Helper diagnostics are not available on all computers.

**Verify that the modem is communicating with Windows —**

1. Click **Start**, then click **Control Panel**.
2. Click **Printers and Other Hardware**.
3. Click **Phone and Modem Options**.
4. Click the **Modems** tab.
5. Click the COM port for your modem.
6. Click **Properties**, click the **Diagnostics** tab, and then click **Query Modem** to verify that the modem is communicating with Windows.

If all commands receive a response, the modem is operating properly.

**Ensure that you are connected to the Internet —** Ensure that you have subscribed to an Internet provider. With the Outlook Express e-mail program open, click **File**. If **Work Offline** has a checkmark next to it, click the checkmark to remove it and connect to the Internet. For help, contact your Internet service provider.

## Error Messages

 **CAUTION:** Before you begin any of the procedures in this section, follow the safety instructions in the *Product Information Guide*.

**A filename cannot contain any of the following characters: \ / : \* ? " < > | —** Do not use these characters in filenames.

**A required .DLL file was not found —** The program that you are trying to open is missing an essential file. To remove and then reinstall the program:

1. Click **Start**, click **Control Panel**, and then click **Add or Remove Programs**.
2. Under **Currently installed programs**, select the program you want to remove.
3. Click **Change** or **Remove**.
4. See the program documentation for installation instructions.

**drive letter : \ is not accessible. The device is not ready —** The drive cannot read the disk. Insert a disk into the drive and try again.

**Insert bootable media —** Insert a bootable floppy disk or CD.

**Non-system disk error —** Remove the floppy disk from the floppy drive and restart your computer.

**Not enough memory or resources. Close some programs and try again —** Close all windows and open the program that you want to use. In some cases, you may have to restart your computer to restore computer resources. If so, run the program that you want to use first.

**Operating system not found —** Contact Dell (see [Contacting Dell](#)).



 **NOTE:** If the error message is not listed, see the documentation for the operating system or the program that was running when the message appeared.

---

## IEEE 1394 Device Problems

 **CAUTION:** Before you begin any of the procedures in this section, follow the safety instructions in the *Product Information Guide*.

Ensure that the cable for the IEEE 1394 device is properly inserted into the device and into the connector on the computer

If you have problems with a Dell IEEE 1394 device —

Contact Dell (see [Contacting Dell](#)).

If you have problems with an IEEE 1394 device not provided by Dell — Contact the IEEE 1394 device manufacturer.

---

## Keyboard Problems

 **CAUTION:** Before you begin any of the procedures in this section, follow the safety instructions in the *Product Information Guide*.

Check the keyboard cable —

- 1 Ensure that the keyboard cable is firmly connected to the computer.
- 1 Shut down the computer (see [Preparing to Work Inside Your Computer](#)), reconnect the keyboard cable as shown on the setup diagram for your computer, and then restart the computer.
- 1 Ensure that the cable is not damaged or frayed and check cable connectors for bent or broken pins. Straighten any bent pins.
- 1 Remove any keyboard extension cables and connect the keyboard directly to the computer.

Test the keyboard — Connect a properly working keyboard to the computer, then try using the keyboard.

Run the Hardware Troubleshooter —

See [Resolving Software and Hardware Incompatibilities](#).

---

## Lockups and Software Problems

 **CAUTION:** Before you begin any of the procedures in this section, follow the safety instructions in the *Product Information Guide*.

### The computer does not start up

Check the diagnostic lights — See [Diagnostic Lights](#).

Ensure that the power cable is firmly connected to the computer and to the electrical outlet

---

### The computer stops responding

 **NOTICE:** You may lose data if you are unable to perform an operating system shutdown.

---

**Turn the computer off** – If you are unable to get a response by pressing a key on your keyboard or moving your mouse, press and hold the power button for at least 8 to 10 seconds, until the computer turns off, and then restart your computer.

## A program stops responding

### End the program –

1. Press <Ctrl><Shift><Esc> simultaneously to access the Windows Task Manager.
2. Click the **Applications** tab.
3. Click to select the program that is no longer responding.
4. Click **End Task**.

## A program crashes repeatedly

 **NOTE:** Most software includes installation instructions in its documentation or on a floppy disk or CD.

**Check the software documentation** – If necessary, uninstall and then reinstall the program.

## A program is designed for an earlier Windows operating system

### Run the Program Compatibility Wizard –

The Program Compatibility Wizard configures a program so that it runs in an environment similar to non-Windows XP operating system environments.

1. Click **Start**, point to **All Programs**→ **Accessories**, and then click **Program Compatibility Wizard**.
2. In the welcome screen, click **Next**.
3. Follow the instructions on the screen.

## A solid blue screen appears

**Turn the computer off** – If you are unable to get a response by pressing a key on your keyboard or moving your mouse, press and hold the power button for at least 8 to 10 seconds, until the computer turns off, and then restart your computer.

## Other software problems

### Check the software documentation or contact the software manufacturer for troubleshooting information –

1. Ensure that the program is compatible with the operating system installed on your computer.
1. Ensure that your computer meets the minimum hardware requirements needed to run the software. See the software documentation for information.
1. Ensure that the program is installed and configured properly.
1. Verify that the device drivers do not conflict with the program.
1. If necessary, uninstall and then reinstall the program.

**Back up your files immediately**

Use a virus-scanning program to check the hard drive, floppy disks, or CDs

Save and close any open files or programs and shut down your computer through the Start menu

---

## Memory Problems

 **CAUTION:** Before you begin any of the procedures in this section, follow the safety instructions in the *Product Information Guide*.

### If you receive an insufficient memory message —

- 1 Save and close any open files and exit any open programs you are not using to see if that resolves the problem.
- 1 See the software documentation for minimum memory requirements. If necessary, install additional memory (see [Installing Memory](#)).
- 1 Reseat the memory modules (see [Memory](#)) to ensure that your computer is successfully communicating with the memory.
- 1 Run the Dell Diagnostics (see [Dell Diagnostics](#)).

### If you experience other memory problems —

- 1 Reseat the memory modules (see [Memory](#)) to ensure that your computer is successfully communicating with the memory.
- 1 Ensure that you are following the memory installation guidelines (see [Installing Memory](#)).
- 1 Ensure that the memory you are using is supported by your computer. For more information about the type of memory supported by your computer, see [Memory](#).
- 1 Run the Dell Diagnostics (see [Dell Diagnostics](#)).

---

## Mouse Problems

 **CAUTION:** Before you begin any of the procedures in this section, follow the safety instructions in the *Product Information Guide*.

### Check the mouse cable —

- 1 Ensure that the cable is not damaged or frayed and check cable connectors for bent or broken pins. Straighten any bent pins.
- 1 Remove any mouse extension cables, and connect the mouse directly to the computer.
- 1 Verify that the mouse cable is connected as shown on the setup diagram for your computer.

### Restart the computer —

1. Simultaneously press <Ctrl><Esc> to display the **Start** menu.
2. Press <u>, press the up- and down-arrow keys to highlight **Shut down** or **Turn Off**, and then press <Enter>.
3. After the computer turns off, reconnect the mouse cable as shown on the setup diagram.
4. Turn on the computer.

**Test the mouse —** Connect a properly working mouse to the computer, then try using the mouse.

### Check the mouse settings —

1. Click **Start**, click **Control Panel**, and then click **Printers and Other Hardware**.
2. Click **Mouse**.
3. Adjusting the settings, as needed.

**Reinstall the mouse driver —** See [Reinstalling Drivers](#).

**Run the Hardware Troubleshooter —** See [Resolving Software and Hardware Incompatibilities](#).

---

## Network Problems

 **CAUTION:** Before you begin any of the procedures in this section, follow the safety instructions in the *Product Information Guide*.

**Check the network cable connector** — Ensure that the network cable is firmly inserted into the network connector on the back of the computer and the network jack.

**Check the network lights on the back of the computer** — If the link integrity light is off (see see [Controls and Lights](#)), no network communication is occurring. Replace the network cable.

**Restart the computer and log on to the network again**

**Check your network settings** — Contact your network administrator or the person who set up your network to verify that your network settings are correct and that the network is functioning.

**Run the Hardware Troubleshooter** — See [Resolving Software and Hardware Incompatibilities](#).

---

## Power Problems

 **CAUTION:** Before you begin any of the procedures in this section, follow the safety instructions in the *Product Information Guide*.

**If the power light is green and the computer is not responding** — See [Diagnostic Lights](#).

**If the power light is blinking green** — The computer is in standby mode. Press a key on the keyboard, move the mouse, or press the power button to resume normal operation.

**If the power light is off** — The computer is either turned off or is not receiving power.

- 1 Reseat the power cable in the power connector on the back of the computer and the electrical outlet.
- 1 Bypass power strips, power extension cables, and other power protection devices to verify that the computer turns on properly.
- 1 Ensure that any power strips being used are plugged into an electrical outlet and are turned on.
- 1 Ensure that the electrical outlet is working by testing it with another device, such as a lamp.
- 1 Ensure that the main power cable and front panel cable are securely connected to the system board (see [System Board Components](#)).

**If the power light is blinking amber** — The computer is receiving electrical power, but an internal power problem may exist.

- 1 Ensure that the voltage selection switch is set to match the AC power at your location (if applicable).
- 1 Ensure that all components and cables are properly installed and securely connected to the system board (see [System Board Components](#)).

**If the power light is steady amber** — A device may be malfunctioning or incorrectly installed.

- 1 Ensure that the processor power cable is securely connected to the system board power connector (POWER2) (see [System Board Components](#)).
- 1 Remove and then reinstall all memory modules (see [Memory](#)).
- 1 Remove and then reinstall any expansion cards, including graphics cards (see [Removing PCI and PCI Express Cards](#)).

**Eliminate interference** — Some possible causes of interference are:

- 1 Power, keyboard, and mouse extension cables
- 1 Too many devices connected to the same power strip
- 1 Multiple power strips connected to the same electrical outlet

---

## Printer Problems

 **CAUTION:** Before you begin any of the procedures in this section, follow the safety instructions in the *Product Information Guide*.

 **NOTE:** If you need technical assistance for your printer, contact the printer's manufacturer.

<p><b>Check the printer documentation</b> — See the printer documentation for setup and troubleshooting information.</p>
<p><b>Ensure that the printer is turned on</b></p>
<p><b>Check the printer cable connections</b> —</p> <ol style="list-style-type: none"><li>1. See the printer documentation for cable connection information.</li><li>1. Ensure that the printer cables are securely connected to the printer and the computer.</li></ol>
<p><b>Test the electrical outlet</b> — Ensure that the electrical outlet is working by testing it with another device, such as a lamp.</p>
<p><b>Verify that the printer is recognized by Windows</b> —</p> <ol style="list-style-type: none"><li>1. Click <b>Start</b>, click <b>Control Panel</b>, and then click <b>Printers and Other Hardware</b>.</li><li>2. Click <b>View installed printers or fax printers</b>.</li></ol> <p>If the printer is listed, right-click the printer icon.</p> <ol style="list-style-type: none"><li>3. Click <b>Properties</b>, then click the <b>Ports</b> tab. For a parallel printer, ensure that <b>Print to the following port(s)</b>: is set to <b>LPT1 (Printer Port)</b>. For a USB printer, ensure that <b>Print to the following port(s)</b>: is set to <b>USB</b>.</li></ol>
<p><b>Reinstall the printer driver</b> — See the printer documentation for information on reinstalling the printer driver.</p>

---

## Scanner Problems

 **CAUTION:** Before you begin any of the procedures in this section, follow the safety instructions in the *Product Information Guide*.

 **NOTE:** If you need technical assistance for your scanner, contact the scanner's manufacturer.

<p><b>Check the scanner documentation</b> — See the scanner documentation for setup and troubleshooting information.</p>
<p><b>Unlock the scanner</b> — Ensure that your scanner is unlocked (if the scanner has a locking tab or button).</p>
<p><b>Restart the computer and try the scanner again</b></p>
<p><b>Check the cable connections</b> —</p> <ol style="list-style-type: none"><li>1. See the scanner documentation for information on cable connections.</li><li>1. Ensure that the scanner cables are securely connected to the scanner and the computer.</li></ol>
<p><b>Verify that the scanner is recognized by Microsoft Windows</b> —</p> <ol style="list-style-type: none"><li>1. Click <b>Start</b>, click <b>Control Panel</b>, and then click <b>Printers and Other Hardware</b>.</li><li>2. Click <b>Scanners and Cameras</b>.</li></ol> <p>If your scanner is listed, Windows recognizes the scanner.</p>
<p><b>Reinstall the scanner driver</b> — See the scanner documentation for instructions.</p>

---

## Sound and Speaker Problems

 **CAUTION:** Before you begin any of the procedures in this section, follow the safety instructions in the *Product Information Guide*.

### No sound from speakers

 **NOTE:** The volume control in MP3 and other media players may override the Windows volume setting. Always check to ensure that the volume on the media player(s) has not been turned down or off.

<p><b>Check the speaker cable connections</b> — Ensure that the speakers are connected as shown on the setup diagram supplied with the speakers. If you purchased a sound card, ensure that the speakers are connected to the card.</p>
<p><b>Ensure that the subwoofer and the speakers are turned on</b> — See the setup diagram supplied with the speakers. If your speakers have volume controls, adjust the volume, bass, or treble to eliminate distortion.</p>
<p><b>Adjust the Windows volume control</b> — Click or double-click the speaker icon in the lower-right corner of your screen. Ensure that the volume is turned up and that the sound is not muted.</p>
<p><b>Disconnect headphones from the headphone connector</b> — Sound from the speakers is automatically disabled when headphones are connected to the computer's front-panel headphone connector.</p>
<p><b>Test the electrical outlet</b> — Ensure that the electrical outlet is working by testing it with another device, such as a lamp.</p>
<p><b>Eliminate possible interference</b> — Turn off nearby fans, fluorescent lights, or halogen lamps to check for interference.</p>
<p><b>Run the speaker diagnostics</b></p>
<p><b>Reinstall the sound driver</b> — See <a href="#">Drivers</a>.</p>
<p><b>Run the Hardware Troubleshooter</b> — See <a href="#">Resolving Software and Hardware Incompatibilities</a>.</p>

### No sound from headphones

<p><b>Check the headphone cable connection</b> — Ensure that the headphone cable is securely inserted into the headphone connector (see <a href="#">Front and Back View of the Computer</a>).</p>
<p><b>Adjust the Windows volume control</b> — Click or double-click the speaker icon in the lower-right corner of your screen. Ensure that the volume is turned up and that the sound is not muted.</p>

---

## Video and Monitor Problems

 **CAUTION:** Before you begin any of the procedures in this section, follow the safety instructions in the *Product Information Guide*.

 **NOTICE:** If your computer came with a PCI graphics card installed, removal of the card is not necessary when installing additional graphics cards; however, the card is required for troubleshooting purposes. If you remove the card, store it in a safe and secure location.

### The screen is blank

 **NOTE:** For troubleshooting procedures, see the monitor's documentation.

--

**Check the monitor cable connection —**

- | Ensure that the monitor cable is connected to the correct graphics card (for dual graphics card configurations).
- | If you are using the optional DVI-to-VGA adapter, ensure that the adapter is correctly attached to the graphics card and monitor.
- | Ensure that the monitor cable is connected as shown on the setup diagram for your computer.
- | Remove any video extension cables and connect the monitor directly to the computer.
- | Swap the computer and monitor power cables to determine if the monitor's power cable is defective.
- | Check the connectors for bent or broken pins (it is normal for monitor cable connectors to have missing pins.)

**Check the monitor power light —**

- | If the power light is lit or blinking, the monitor has power.
- | If the power light is off, firmly press the button to ensure that the monitor is turned on.
- | If the power light is blinking, press a key on the keyboard or move the mouse to resume normal operation.

**Test the electrical outlet —** Ensure that the electrical outlet is working by testing it with another device, such as a lamp.

**Check the diagnostic lights —** See [Diagnostic Lights](#).

## The screen is difficult to read

**Check the monitor settings —** See the monitor documentation for instructions on adjusting the contrast and brightness, demagnetizing (degaussing) the monitor, and running the monitor self-test.

**Move the subwoofer away from the monitor —** If your speaker system includes a subwoofer, ensure that the subwoofer is positioned at least 60 cm (2 ft) away from the monitor.

**Move the monitor away from external power sources —** Fans, fluorescent lights, halogen lamps, and other electrical devices can cause the screen image to appear *shaky*. Turn off nearby devices to check for interference.

**Rotate the monitor to eliminate sunlight glare and possible interference**

**Adjust the Windows display settings —**

1. Click **Start**, click **Control Panel**, and then click **Appearance and Themes**.
2. Click **Display**, then click the **Settings** tab.
3. Adjust **Screen resolution** and **Color quality settings**, as needed.

## The image quality is poor

**Check the graphics card power cable connection —** Ensure that the power cable for the graphics card(s) is correctly attached to the card.

**Check the monitor settings —** See the monitor documentation for instructions on adjusting the contrast and brightness, demagnetizing (degaussing) the monitor, and running the monitor self-test.

[Back to Contents Page](#)

## Dell™ XPS™ 710 Owner's Manual



**NOTE:** A NOTE indicates important information that helps you make better use of your computer.



**NOTICE:** A NOTICE indicates either potential damage to hardware or loss of data and tells you how to avoid the problem.



**CAUTION:** A CAUTION indicates a potential for property damage, personal injury, or death.

For a complete list of abbreviations and acronyms, see the [Glossary](#).

If you purchased a Dell™ n Series computer, any references in this document to Microsoft® Windows® operating systems are not applicable.

Information in this document is subject to change without notice.

© 2006 Dell Inc. All rights reserved.

Reproduction in any manner whatsoever without the written permission of Dell Inc. is strictly forbidden.

Trademarks used in this text: *Dell*, the *DELL* logo, *Dell XPS*, *Inspiron*, *Dell Precision*, *Dimension*, *OptiPlex*, *Latitude*, *PowerEdge*, *PowerVault*, *PowerApp*, and *Dell OpenManage* are trademarks of Dell Inc.; *Intel*, *Pentium*, and *Celeron* are registered trademarks of Intel Corporation; *Microsoft* and *Windows* are registered trademarks of Microsoft Corporation.

Other trademarks and trade names may be used in this document to refer to either the entities claiming the marks and names or their products. Dell Inc. disclaims any proprietary interest in trademarks and trade names other than its own.

October 2006 P/N XM141 Rev. A00

---

[Back to Contents Page](#)



## Advanced Troubleshooting

### Dell™ XPS™ 710 Owner's Manual

- [Diagnostic Lights](#)
- [Dell Diagnostics](#)
- [Drivers](#)
- [Using Microsoft® Windows® XP System Restore](#)
- [Resolving Software and Hardware Incompatibilities](#)
- [Reinstalling Microsoft® Windows® XP](#)

## Diagnostic Lights

**CAUTION:** Before you begin any of the procedures in this section, follow the safety instructions in the *Product Information Guide*.

To help troubleshoot a problem, your computer has four lights labeled 1, 2, 3, and 4 on the front panel (see [Front View](#)). When the computer starts normally, the lights flash before turning off. If the computer malfunctions, the sequence of the lights help to identify the problem.

**NOTE:** After the computer completes POST, all four lights turn off before booting to the operating system.

Light Pattern	Problem Description	Suggested Resolution
①②③④	The computer is in a normal <i>off</i> condition or a possible pre-BIOS failure has occurred.  The diagnostic lights are not lit after the system successfully boots to the operating system.	<ul style="list-style-type: none"> <li>1 Plug the computer into a working electrical outlet (see <a href="#">Power Problems</a>).</li> <li>1 If the problem persists, contact Dell (see <a href="#">Contacting Dell</a>).</li> </ul>
①②③④	A possible processor failure has occurred.	<ul style="list-style-type: none"> <li>1 Reseat the processor (see <a href="#">Processor</a>).</li> <li>1 If the problem persists, contact Dell (see <a href="#">Contacting Dell</a>).</li> </ul>
①②③④	Memory modules are detected, but a memory failure has occurred.	<ul style="list-style-type: none"> <li>1 If two or more memory modules are installed, remove the modules (see <a href="#">Removing Memory</a>), then reinstall one module (see <a href="#">Installing Memory</a>) and restart the computer. If the computer starts normally, continue to install additional memory modules (one at a time) until you have identified a faulty module or reinstalled all modules without error.</li> <li>1 If available, install working memory of the same type into your computer (see <a href="#">Installing Memory</a>).</li> <li>1 If the problem persists, contact Dell (see <a href="#">Contacting Dell</a>).</li> </ul>
①②③④	A possible graphics card failure has occurred.	<ul style="list-style-type: none"> <li>1 Reseat any installed graphics cards (see <a href="#">Cards</a>).</li> <li>1 If available, install a working graphics card into your computer.</li> <li>1 If the problem persists, contact Dell (see <a href="#">Contacting Dell</a>).</li> </ul>
①②③④	A possible floppy drive or hard drive failure has occurred.	Reseat all power and data cables.
①②③④	A possible USB failure has occurred.	Reinstall all USB devices and check all cable connections.
①②③④	No memory modules are detected.	<ul style="list-style-type: none"> <li>1 If two or more memory modules are installed, remove the modules (see <a href="#">Removing Memory</a>), then reinstall one module (see <a href="#">Installing Memory</a>) and restart the computer. If the computer starts normally, continue to install additional memory modules (one at a time) until you have identified a faulty module or reinstalled all modules without error.</li> <li>1 If available, install working memory of the same type into your computer (see <a href="#">Installing Memory</a>).</li> <li>1 If the problem persists, contact Dell (see <a href="#">Contacting Dell</a>).</li> </ul>
①②③④	Memory modules are detected, but a memory configuration or compatibility error has occurred.	<ul style="list-style-type: none"> <li>1 Ensure that no special requirements for memory module/connector placement exist (see <a href="#">Memory</a>).</li> <li>1 Ensure that the memory you are using is supported by your computer (see <a href="#">Memory</a>).</li> <li>1 If the problem persists, contact Dell (see <a href="#">Contacting Dell</a>).</li> </ul>
①②③④	A possible expansion card failure has occurred.	<ul style="list-style-type: none"> <li>1. Determine if a conflict exists by removing an expansion card (not a graphics card) and restarting the computer (see <a href="#">Removing PCI and PCI Express Cards</a>).</li> <li>2. If the problem persists, reinstall the card you removed, then remove a different card and restart the computer.</li> <li>3. Repeat this process for each expansion card installed. If the computer starts normally, troubleshoot the last card removed from the computer for resource conflicts (see <a href="#">Resolving Software and Hardware Incompatibilities</a>).</li> <li>4. If the problem persists, contact Dell (see <a href="#">Contacting Dell</a>).</li> </ul>



Another failure has occurred.

- 1 Ensure that all hard drive and CD/DVD drive cables are properly connected to the system board (see [System Board Components](#)).
- 1 If there is an error message on the screen identifying a problem with a device (such as the floppy drive or hard drive), check the device to make sure it is functioning properly.
- 1 If the operating system is attempting to boot from a device (such as the floppy drive or CD/DVD drive); check system setup (see [System Setup](#)) to ensure the boot sequence is correct for the devices installed on your computer.
- 1 If the problem persists, contact Dell (see [Contacting Dell](#)).

## Dell Diagnostics

 **CAUTION:** Before you begin any of the procedures in this section, follow the safety instructions in the *Product Information Guide*.

### When to Use the Dell Diagnostics

If you experience a problem with your computer, perform the checks in [Solving Problems](#) and run the Dell Diagnostics before you contact Dell for technical assistance.

 **NOTE:** The Dell Diagnostics only operate on Dell computers.

Run Dell Diagnostics from your hard drive or from the *Drivers and Utilities CD (ResourceCD)*.

### Starting the Dell Diagnostics From Your Hard Drive

1. Turn on (or restart) your computer.
2. When the DELL logo appears, press <F12> immediately.

 **NOTE:** Keyboard failure may result when a key is held down for extended periods of time. To avoid possible keyboard failure, press and release <F12> in even intervals to open the **Boot Device Menu**.

 **NOTE:** If at any time a message appears stating that no diagnostics utility partition has been found, run the Dell Diagnostics from your *Drivers and Utilities CD* (see [Starting the Dell Diagnostics From the Drivers and Utilities CD](#)).

If you wait too long and the operating system logo appears, continue to wait until you see the Microsoft® Windows® desktop, then shut down your computer and try again.

3. At the **Boot Device Menu**, use the up- and down-arrow keys or press the appropriate number on the keyboard to highlight **Boot to Utility Partition**, and then press <Enter>.

 **NOTE:** The Quickboot feature changes the boot sequence for the current boot only. Upon restart, the computer boots according to the boot sequence specified in system setup.

4. At the Dell Diagnostics **Main Menu**, left-click with the mouse, or press <Tab> and then <Enter>, to select the test you want to run (see [Dell Diagnostics Main Menu](#)).

 **NOTE:** Write down any error codes and problem descriptions exactly as they appear and follow the instructions on the screen.

5. After all tests have completed, close the test window to return to the Dell Diagnostics **Main Menu**.
6. Close the **Main Menu** window to exit the Dell Diagnostics and restart the computer.

### Starting the Dell Diagnostics From the Drivers and Utilities CD

1. Turn on your computer.
2. Press the eject button on the front of the optical drive to open the drive tray.
3. Place the *Drivers and Utilities CD* in the center of the drive tray, then press the eject button or gently push on the tray to close it.
4. Restart the computer.
5. When the DELL logo appears, press <F12> immediately.

 **NOTE:** Keyboard failure may result when a key on the keyboard is held down for extended periods of time. To avoid possible keyboard failure, press and release <F12> in even intervals until the **Boot Device Menu** appears.

If you wait too long and the Windows logo appears, continue to wait until you see the Windows desktop, then shut down your computer and try again.

- At the **Boot Device Menu**, use the up- and down-arrow keys or press the appropriate number on the keyboard to highlight **Onboard or USB CD-ROM**, and then press <Enter>.

 **NOTE:** The Quickboot feature changes the boot sequence for the current boot only. Upon restart, the computer boots according to the boot sequence specified in system setup.

- At the **CD-ROM Startup Menu**, use the up- and down-arrow keys or press the appropriate number on the keyboard to highlight **Boot from CD-ROM**, and then press <Enter>.

If you wait too long and the Windows logo appears, continue to wait until you see the Windows desktop, then shut down your computer and try again.

- Press <1> to select the Dell Diagnostics.

- At the **Dell Diagnostics Menu** press <1> to select the Dell Diagnostics for ResourceCD (graphical user interface).

- At the Dell Diagnostics **Main Menu**, left-click with the mouse, or press <Tab> and then <Enter>, to select the test you want to run (see [Dell Diagnostics Main Menu](#)).

 **NOTE:** Write down any error codes and problem descriptions exactly as they appear and follow the instructions on the screen.

- After all tests have completed, close the test window to return to the Dell Diagnostics **Main Menu**.

- Remove the *Drivers and Utilities* CD, then close the **Main Menu** window to exit the Dell Diagnostics and restart the computer.

## Dell Diagnostics Main Menu

The following tests can be run from the Dell Diagnostics **Main Menu**:

Option	Function
Express Test	Performs a quick test of system devices. The test typically takes 10 to 20 minutes and requires no interaction on your part. Run <b>Express Test</b> first to increase the possibility of tracing the problem quickly.
Extended Test	Performs a thorough check of system devices. The test typically takes an hour or more and periodically requires your input to answer specific questions.
Custom Test	Tests a specific device in the system and can be used to customize the tests you want to run.
Symptom Tree	Lists a number of common symptoms and allows you to select a test based on the symptom of the problem you are having.

For any problem encountered during a test, a message appears with an error code and a description of the problem. Write down the error code and problem description exactly as it appears and follow the instructions on the screen. If you cannot resolve the problem, contact Dell (see [Contacting Dell](#)).

 **NOTE:** The Service Tag for your computer is located at the top of each test screen. When contacting Dell support, have your Service Tag ready.

The following tabs provide additional information for tests run from the **Custom Test** or **Symptom Tree** option:

Tab	Function
Results	Displays the results of the test and any error conditions encountered.
Errors	Displays error conditions encountered, error codes, and the problem description.
Help	Describes the test and any requirements for running the test.
Configuration (Custom Test only)	Displays the hardware configuration for the selected device.  The Dell Diagnostics obtains configuration information for all devices from system setup, memory, and various internal tests, and it displays the information in the device list in the left pane of the screen.  <b>NOTE:</b> The device list may not display the names of all the components installed on your computer or all devices attached to your computer.
Parameters (Custom Test only)	Allows you to customize the test, if applicable, by changing the test settings.

## Drivers

### What Is a Driver?

A driver is a program that controls a device such as a printer, mouse, or keyboard. All devices require a driver program.

A driver acts as a translator between the device and any programs that use the device. Each device has a set of specialized commands that only driver for that device recognizes.

Required drivers are already installed on your computer—no further installation or configuration is needed.

 **NOTICE:** The *Drivers and Utilities* CD may contain drivers for operating systems that are not on your computer. Ensure that you are installing software appropriate for your operating system.

Many drivers, such as the keyboard driver, come with your Microsoft® Windows® operating system. You may need to install drivers if you:

1. Upgrade your operating system.
1. Reinstall your operating system.
1. Connect or install a new device.

### Identifying Drivers

If you experience a problem with any device, identify whether the driver is the source of your problem and, if necessary, update the driver.

#### Windows XP

1. Click **Start**, then click **Control Panel**.
2. Under **Pick a Category**, click **Performance and Maintenance**.
3. Click **System**.
4. In the **System Properties** window, click the **Hardware** tab.
5. Click **Device Manager**.
6. Scroll down the list of devices and check for an exclamation point (a circle with a **!**) next to the device name.

If an exclamation point appears next to the device name, you may need to reinstall the driver or install a new driver (see [Drivers](#)).

### Reinstalling Drivers

 **NOTICE:** The Dell Support website at [support.dell.com](http://support.dell.com) and your *Drivers and Utilities* CD provide approved drivers for your Dell computer. If you install drivers obtained from other sources, your computer may not function properly.

#### Using Windows XP Device Driver Rollback

If a problem occurs on your computer after you install or update a driver, use Windows XP Device Driver Rollback to replace the driver with the previously installed version.

1. Click **Start**, then click **Control Panel**.
2. Under **Pick a Category**, click **Performance and Maintenance**.
3. Click **System**.
4. In the **System Properties** window, click the **Hardware** tab.
5. Click **Device Manager**.
6. Right-click the device for which the new driver was installed, then click **Properties**.

7. Click the **Driver** tab.
8. Click **Roll Back Driver**.

If Device Driver Rollback does not resolve the problem, reinstall the driver from the *Drivers and Utilities CD*.

## Using the Drivers and Utilities CD

If a problem occurs on your computer after you install or update a driver and Windows XP Device Driver Rollback does not resolve the problem, reinstall the driver from the *Drivers and Utilities CD*.

1. With the Windows desktop displayed, insert the *Drivers and Utilities CD*.  
If this is your first time to use the *Drivers and Utilities CD*, proceed to [step 2](#). If not, go to [step 4](#).
2. When the **ResourceCD Installation** window appears, click **OK**, and then follow the instructions on the screen.
3. When the **InstallShield Wizard Completed** window appears, click **Finish**.

The **ResourceCD** window appears.

4. Under **Welcome Dell System Owner**, click **Next**.

5. Click **Drivers**.

The drivers that are used by your computer are automatically displayed in the **Drivers** window.

 **NOTE:** The ResourceCD displays drivers only for the hardware that came installed in your computer. If you installed additional hardware, and applicable drivers are not displayed, exit the ResourceCD program and see the documentation that came with the hardware.

6. Click the driver that you want to reinstall.

 **NOTE:** If a driver for a particular device is not listed, then a driver for that device is already included with the operating system.

7. Click **Extract**, and then follow the instructions on the screen.

If reinstalling the driver from the *Drivers and Utilities CD* does not resolve the problem, use System Restore to return the computer to the operating state before the problem occurred (see [Using Microsoft® Windows® XP System Restore](#)).

## Manually Reinstalling Drivers

After extracting driver files from the *Drivers and Utilities CD* to your hard drive you may be required to update the driver manually.

Drivers can be manually updated for any hardware device installed in your computer.

1. Click **Start**, then click **Control Panel**.
2. Under **Pick a Category**, click **Performance and Maintenance**.
3. Click **System**.
4. In the **System Properties** window, click the **Hardware** tab.
5. Click **Device Manager**.
6. Double-click the type of device for which you are installing the driver.
7. Right-click the device for which the driver is being reinstalled, then click **Properties**.
8. Click the **Driver** tab.
9. Click **Update Driver**.
10. Click **Install from a list or specific location (Advanced)**, then click **Next**.
11. Click to check **Include this location in the search**, then click **Browse** and navigate to where the driver files are located on your hard drive.

12. When the name of the appropriate driver appears, click **Next**.

13. Click **Finish** and restart your computer.

---

## Using Microsoft® Windows® XP System Restore

Microsoft Windows XP System Restore allows you to return your computer to an earlier operating state (without affecting data files). Using System Restore can be helpful if changes to the system hardware, software, or settings have left the computer in an undesirable operating state. For information on using System Restore, see the Windows Help and Support Center (click **Start**, then click **Help and Support**).

 **NOTICE:** System Restore does not monitor your data files or recover them. Make regular backups of your data files.

### Creating a Restore Point

1. Click **Start**, point to **All Programs**→**Accessories**→**System Tools**, and then click **System Restore**.
2. Ensure that **Create a restore point** is selected, then click **Next**.
3. In the **Restore point description** field, enter a name for the restore point, then click **Create**.

### Restoring the Computer to an Earlier Operating State

 **NOTICE:** Before you restore the computer to an earlier operating state, save and close all open files and exit any open programs. Do not alter, open, or delete any files or programs until the system restoration process is complete.

 **NOTE:** If a problem occurs after you install a device driver, first try to resolve the problem by using Windows XP Device Driver Rollback (see [Using Windows XP Device Driver Rollback](#)), or reinstall the driver with the Drivers and Utilities CD (see [Using the Drivers and Utilities CD](#)).

1. Click **Start**, point to **All Programs**→**Accessories**→**System Tools**, and then click **System Restore**.
2. Ensure that **Restore my computer to an earlier time** is selected, then click **Next**.
3. Under **Select a Restore Point**, click the calendar date and restore point to which you want to restore your computer, and then click **Next**.

 **NOTE:** Calendar dates with available restore points appear in bold. If a calendar date has only one restore point available, that restore point is automatically selected.

4. Under **Confirm Restore Point Selection**, click **Next**.

The System Restore process collects necessary data, then restarts the computer.

5. Under **Restoration Complete** (after the computer has restarted), click **OK**.

 **NOTE:** After your computer has been restored to an earlier operating state, you can repeat the restoration process and use a different restore point, or you can undo the restoration and return the computer to its original operating state.

### Undoing the Last System Restore

 **NOTICE:** Before you undo the most recent system restore, save and close all open files and exit any open programs. Do not alter, open, or delete any files or programs until the system restoration process is complete.

1. Click **Start**, point to **All Programs**→**Accessories**→**System Tools**, and then click **System Restore**.
2. Ensure that **Undo my last restoration** is selected, then click **Next**.
3. Under **Confirm Restoration Undo**, click **Next**.

The System Restore process collects necessary data, then restarts the computer.

4. Under **Undo Complete** (after the computer has restarted), click **OK**.

### Enabling or Disabling System Restore

If you reinstall Windows XP with less than 200 MB of free hard-disk space available, System Restore is automatically disabled. To determine if System Restore is enabled:

1. Click **Start**, then click **Control Panel**.
2. Under **Pick a Category**, click **Performance and Maintenance**.
3. Click **System**.
4. In the **System Properties** window, click the **System Restore** tab.
5. Ensure that **Turn off System Restore** is unchecked.

 **NOTE:** To disable System Restore, check **Turn off System Restore**.

---

## Resolving Software and Hardware Incompatibilities

If a device is not detected during the operating system setup or is detected, but incorrectly configured, you can use the Hardware Troubleshooter to resolve the incompatibility.

1. Click **Start**, then click **Help and Support**.
  2. Type `hardware troubleshooter` in the **Search** field and click the arrow to start the search.
  3. Click **Hardware Troubleshooter** in the **Search Results** list.
  4. In the **Hardware Troubleshooter** list, click **I need to resolve a hardware conflict on my computer**, and click **Next**.
- 

## Reinstalling Microsoft® Windows® XP

 **NOTICE:** You must use Windows XP Service Pack 1 (SP1) or later when you reinstall Windows XP.

 **NOTICE:** In order to use the migrating option to convert a RAID configuration without losing data, your hard drive must initially be set up as a single drive RAID 0 array before the operating system is loaded onto the drive (see [Using the Nvidia MediaShield ROM Utility](#) for instructions).

### Before You Begin

If you are considering reinstalling the Windows XP operating system to correct a problem with a newly installed driver, first try using Windows XP Device Driver Rollback (see [Using Windows XP Device Driver Rollback](#)). If Device Driver Rollback does not resolve the problem, then use System Restore (see [Using Microsoft® Windows® XP System Restore](#)) to return your operating system to the operating state it was in before you installed the new device driver.

 **NOTICE:** Before performing the installation, back up all data files on your primary hard drive. For conventional hard drive configurations, the primary hard drive is the first drive detected by the computer.

To reinstall Windows XP, you need the following items:

1. Dell *Operating System* CD
1. Dell *Drivers and Utilities* CD

 **NOTE:** The *Drivers and Utilities* CD contains drivers that were installed during assembly of the computer. Use the CD to load any required drivers.

## Reinstalling Windows XP

To reinstall Windows XP, perform all the steps in the following sections in the order in which they are listed.

The reinstallation process can take 1 to 2 hours to complete. After you reinstall the operating system, you must also reinstall the device drivers, virus protection program, and other software.

 **NOTICE:** The *Operating System* CD provides options for reinstalling Windows XP. The options can overwrite files and possibly affect programs installed on your hard drive. Therefore, do not reinstall Windows XP unless a Dell technical support representative instructs you to do so.

 **NOTICE:** To prevent conflicts with Windows XP, disable any virus protection software installed on your computer before you reinstall Windows XP. See the documentation that came with the software for instructions.

### Booting From the Operating System CD

1. Save and close any open files and exit any open programs.

2. Insert the *Operating System* CD. Click **Exit** if **Install Windows XP** message appears.
3. Restart the computer.
4. When the **DELL** logo appears, press <F12> immediately.

 **NOTE:** Keyboard failure may result when a key on the keyboard is held down for extended periods of time. To avoid possible keyboard failure, press and release <F12> in even intervals until the **Boot Device Menu** appears.

If the operating system logo appears, wait until you see the Windows desktop, and then shut down the computer and try again.

5. At the **Boot Device Menu**, use the up- and down-arrow keys or press the appropriate number on the keyboard to highlight **Onboard or USB CD-ROM**, and then press <Enter>.
6. When the *Press any key to boot from CD* message appears, press any key.

## Windows XP Setup

1. When the **Windows XP Setup** screen appears, press <Enter> to select **To set up Windows now**.
2. Read the information on the **Microsoft Windows Licensing Agreement** screen, and press <F8> to accept the license agreement.
3. If your computer already has Windows XP installed and you want to recover your current Windows XP data, type *r* to select the repair option, and remove the CD.
4. If you want to install a new copy of Windows XP, press <Esc> to select that option.
5. Press <Enter> to select the highlighted partition (recommended), and follow the instructions on the screen.

The **Windows XP Setup** screen appears, and the operating system begins to copy files and install the devices. The computer automatically restarts multiple times.

 **NOTE:** The time required to complete the setup depends on the size of the hard drive and the speed of your computer.

 **NOTICE:** Do not press any key when the following message appears: *Press any key to boot from the CD*.

6. When the **Regional and Language Options** screen appears, select the settings for your location and click **Next**.
7. Enter your name and organization (optional) in the **Personalize Your Software** screen, and click **Next**.
8. *If you are reinstalling Windows XP Home Edition*, at the **What's your computer's name** window, enter a name for your computer (or accept the name provided) and click **Next**.

*If you are reinstalling Windows XP Professional*, at the **Computer Name and Administrator Password** window, enter a name for your computer (or accept the one provided) and a password, and click **Next**.

9. If the **Modem Dialing Information** screen appears, enter the requested information and click **Next**.
10. Enter the date, time, and time zone in the **Date and Time Settings** window, and click **Next**.
11. If the **Networking Settings** screen appears, click **Typical** and click **Next**.
12. If you are reinstalling Windows XP Professional and you are prompted to provide further information regarding your network configuration, enter your selections. If you are unsure of your settings, accept the default selections.

Windows XP installs the operating system components and configures the computer. The computer automatically restarts.

 **NOTICE:** Do not press any key when the following message appears: *Press any key to boot from the CD*.

13. When the **Welcome to Microsoft** screen appears, click **Next**.
14. When the *How will this computer connect to the Internet?* message appears, click **Skip**.
15. When the **Ready to register with Microsoft?** screen appears, select **No, not at this time** and click **Next**.
16. When the **Who will use this computer?** screen appears, you can enter up to five users.



17. Click **Next**.
18. Click **Finish** to complete the setup, and remove the CD.
19. Reinstall the appropriate drivers with the *Drivers and Utilities* CD (see [Reinstalling Drivers](#)).
20. Reinstall your virus protection software.
21. Reinstall your programs.

 **NOTE:** To reinstall and activate your Microsoft Office or Microsoft Works Suite programs, you need the Product Key number located on the back of the Microsoft Office or Microsoft Works Suite CD sleeve.

---

[Back to Contents Page](#)