

Dell™ XPS™ 630i Owner's Manual

Model DCDR01

Notes, Notices, and Cautions



NOTE: A NOTE indicates important information that helps you make better use of your computer.



NOTICE: A NOTICE indicates either potential damage to hardware or loss of data and tells you how to avoid the problem.



CAUTION: A CAUTION indicates a potential for property damage, personal injury, or death.

Information in this document is subject to change without notice.

© 2007–2008 Dell Inc. All rights reserved.

Reproduction in any manner whatsoever without the written permission of Dell Inc. is strictly forbidden.

Trademarks used in this text: *Dell*, the *DELL* logo, *XPS*, and *YOURS IS HERE* are trademarks of Dell Inc.; *Bluetooth* is a registered trademark owned by Bluetooth SIG, Inc. and is used by Dell under license; *Intel* is a registered trademark and *Core* is a trademark of Intel Corporation; *Microsoft*, *Windows*, *Windows Vista*, and *Windows Vista* start button logo are either trademarks or registered trademarks of Microsoft Corporation in the United States and/or other countries; *Blu-ray Disc* is a trademark of the Blu-ray Disc Association; *Nvidia* is a registered trademark of Nvidia Corporation in the United States and/or other countries.

Other trademarks and trade names may be used in this document to refer to either the entities claiming the marks and names or their products. Dell Inc. disclaims any proprietary interest in trademarks and trade names other than its own.

Model DCDR01

April 2008

P/N PP521

Rev. A01

Contents

	Finding Information	11
1	About Your Computer.	17
	Front View of the Computer	17
	Back View of the Computer	19
	Front-Panel Connectors	20
	Back-Panel Connectors	21
2	Setting Up Your Computer	25
	Installing Your Computer in an Enclosure.	25
	Connecting to the Internet.	27
	Setting Up Your Internet Connection.	28
	Transferring Information to a New Computer	29
	Microsoft® Windows® XP	30
	Windows Vista	33
	Setting Up a Printer	33
	Printer Cable	34
	Connecting a USB Printer	34

Connecting Two Monitors	35
Connecting Two Monitors With VGA Connectors	35
Connecting One Monitor With a VGA Connector and One Monitor With a DVI Connector	36
Connecting a TV.	37
Changing the Display Settings	37
Power Protection Devices	37
Surge Protectors	37
Line Conditioners	38
Uninterruptible Power Supplies	38
Power Management	38
Power Management Options in Windows XP	38
Power Management Options in Windows Vista	42
3 Using Multimedia	43
Playing CDs or DVDs	43
Copying CDs and DVDs	45
How to Copy a CD or DVD.	45
Using Blank CDs and DVDs.	46
Helpful Tips	47
Adjusting the Picture	47
Connecting Your Computer to a TV or Audio Device	48
S-Video and Standard Audio	50
S-Video and S/PDIF Digital Audio.	51
Composite Video and Standard Audio	53
Composite Video and S/PDIF Digital Audio.	55

Component Video and Standard Audio	57
Component Video and S/PDIF Digital Audio	59
Setting Up the Cyberlink (CL) Headphones	62
Enabling the Display Settings for a TV	63
Using a Media Card Reader (Optional)	64
Instructions for Setting Up a Device With Bluetooth Wireless Technology	66
4 About RAID Configurations	67
RAID Level 0 Configuration	67
RAID Level 1 Configuration	68
Configuring Your Hard Drives for RAID	69
Setting Your Computer to RAID-Enabled Mode	69
Using the Nvidia MediaShield ROM Utility	70
Using Nvidia MediaShield	71
Creating a RAID Array	71
Deleting a RAID Array	72
Converting From One RAID Configuration to Another RAID Configuration	73
Rebuilding a RAID Configuration	74
5 Cleaning Your Computer	75
Computer, Keyboard, and Monitor	75
Mouse (Non-Optical)	75
Floppy Drive	76
CDs and DVDs	76

6	System Setup	77
	Overview	77
	Entering System Setup	77
	System Setup Screens	77
	System Setup Options	79
	Boot Sequence	82
	Option Settings	82
	Changing Boot Sequence for the Current Boot	82
	Changing Boot Sequence for Future Boots	83
7	Clearing Passwords and CMOS Settings	85
	Clearing Passwords	85
	Clearing CMOS Settings	87
	Flashing the BIOS	88
8	Troubleshooting Tools	89
	Power Lights	89
	Beep Codes	90
	System Messages	93
	Hardware Troubleshooter	95

Dell Diagnostics	95
When to Use the Dell Diagnostics	95
Starting the Dell Diagnostics From Your Hard Drive	96
Starting the Dell Diagnostics From the Drivers and Utilities Media	97
Dell Diagnostics Main Menu	98
9 Troubleshooting	101
Battery Problems	101
Drive Problems	102
Error Messages.	103
IEEE 1394 Device Problems.	104
Keyboard Problems.	105
Lockups and Software Problems.	106
Memory Problems	108
Mouse Problems	108
Network Problems	109
Power Problems	110
Printer Problems	110
Scanner Problems	111
Sound and Speaker Problems	112
Video and Monitor Problems	113
Overclocking Problems.	115
Power Lights	115
10 Reinstalling Software	117
Drivers	117
What Is a Driver?.	117
Identifying Drivers	117
Reinstalling Drivers and Utilities	118
Using the Drivers and Utilities Media	119

Troubleshooting Software and Hardware Problems in the Microsoft® Windows® XP and Windows Vista® Operating Systems	121
Restoring Your Operating System	122
Using Microsoft Windows System Restore.	122
Using Dell™ PC Restore and Dell Factory Image Restore.	124
Using the Operating System Media.	127
11 Specifications	129
12 Getting Help	135
Obtaining Assistance	135
Technical Support and Customer Service	136
DellConnect.	136
Online Services	136
AutoTech Service.	137
Automated Order-Status Service.	137
Problems With Your Order.	137
Product Information	138
Returning Items for Warranty Repair or Credit	138
Before You Call.	139
Contacting Dell.	141

A Appendix	143
FCC Notice (U.S. Only)	143
FCC Class B	143
Macrovision	144
Glossary	145
Index	163

Finding Information

 **NOTE:** Some features or media may be optional and may not ship with your computer. Some features or media may not be available in certain countries.

 **NOTE:** Additional information may ship with your computer.

What Are You Looking For?	Find It Here
<ul style="list-style-type: none">• A diagnostic program for my computer• Drivers for my computer• Desktop System Software (DSS)	<p>Drivers and Utilities Media</p> <p>NOTE: The <i>Drivers and Utilities</i> media may be optional and may not ship with your computer.</p> <p>Documentation and drivers are already installed on your computer. You can use the media to reinstall drivers (see "Reinstalling Drivers and Utilities" on page 118). To run the Dell Diagnostics, see "Dell Diagnostics" on page 95.</p> <p>Readme files may be included on your media to provide last-minute updates about technical changes to your computer or advanced technical-reference material for technicians or experienced users.</p>



NOTE: Drivers and documentation updates can be found at support.dell.com.

What Are You Looking For?

- Warranty information
- Terms and Conditions (U.S. only)
- Safety instructions
- Regulatory information
- Ergonomics information
- End User License Agreement

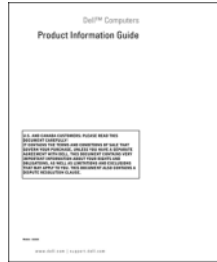
Find It Here**Dell™ Product Information Guide**

-
- How to set up my computer

Setup Diagram

What Are You Looking For?

- Service Tag and Express Service Code
- Microsoft Windows License Label

Find It Here**Service Tag and Microsoft® Windows® License**

NOTE: Your computer's Service Tag and Microsoft® Windows® License labels are located on your computer.

Your computer's Service Tag contains both a Service Tag number and an Express Service Code.

- Use the Service Tag to identify your computer when you use support.dell.com or contact support.
- Enter the Express Service Code to direct your call when contacting support.



- Use the product key on the License Label if you need to reinstall your operating system.

NOTE: As an increased security measure, the newly designed Microsoft Windows license label incorporates a missing portion or "hole" to discourage removal of the label.

What Are You Looking For?**Find It Here**

- Solutions — Troubleshooting hints and tips, articles from technicians, and online courses, frequently asked questions
- Community — Online discussion with other Dell customers
- Upgrades — Upgrade information for components, such as memory, the hard drive, and the operating system
- Customer Care — Contact information, service call and order status, warranty, and repair information
- Service and support — Service call status and support history, service contract, online discussions with technical support
- Dell Technical Update Service — Proactive e-mail notification of software and hardware updates for your computer
- Reference — Computer documentation, details on my computer configuration, product specifications, and white papers
- Downloads — Certified drivers, patches, and software updates
- Desktop System Software (DSS)— If you reinstall the operating system for your computer, you should also reinstall the DSS utility. DSS provides critical updates for your operating system and support for processors, optical drives, USB devices, and so on. DSS is necessary for correct operation of your Dell computer. The software automatically detects your computer and operating system and installs the updates appropriate for your configuration.

Dell Support Website — support.dell.com

NOTE: Select your region or business segment to view the appropriate support site.

To download Desktop System Software:

- 1** Go to support.dell.com and click **Drivers and Downloads**.
- 2** Click **Select Model**.
- 3** Select your product model and click **Confirm**, or enter a service tag and click **Go**.
- 4** Click **System Utilities**.
- 5** Click **Desktop System Software** under **Dell - Utility**, and click **Download Now**.
- 6** Click **Run** to run the driver, or **Save** to save the driver to your computer.

NOTE: The support.dell.com user interface may vary depending on your selections.

What Are You Looking For?

- How to find information about my computer and its components
- How to connect to the Internet
- How to add user accounts for different people
- How to transfer files and settings from another computer

- How to use Microsoft Windows XP or Windows Vista®
- How to work with programs and files
- How to personalize my desktop

Find It Here

Windows Welcome Center

The Windows Welcome Center automatically appears when you use the computer for the first time. You can choose to have it appear every time you start your Tablet-PC by placing a check in the **Run at startup** checkbox. Another method of accessing the Welcome Center is to click the Windows Vista Start button ™, and then click **Welcome Center**.

Windows Help and Support

Microsoft Windows XP:

- 1** Click the **Start** button and click **Help and Support**.
- 2** Either select one of the topics listed, or type a word or phrase that describes your problem into the **Search** box, click the arrow icon, and then click the topic that describes your problem.
- 3** Follow the instructions on the screen.

Windows Vista:

- 1** Click the Windows Vista Start button , and then click **Help and Support**.
- 2** In *Search Help*, type a word or phrase that describes your problem, and then press <Enter> or click the magnifying glass.
- 3** Click the topic that describes your problem.
- 4** Follow the instructions on the screen.

What Are You Looking For?

- How to reinstall my operating system

Find It Here**Operating System Media**

The operating system is already installed on your computer. To reinstall your operating system, use the *Operating System* media. See "Restoring Your Operating System" on page 122 in your *User's Guide* or *Owner's Manual*.



After you reinstall your operating system, use the *Drivers and Utilities* media to reinstall drivers for the devices that came with your computer.

Your operating system product key label is located on your computer.



NOTE: The color of your CD varies based on the operating system you ordered.

About Your Computer

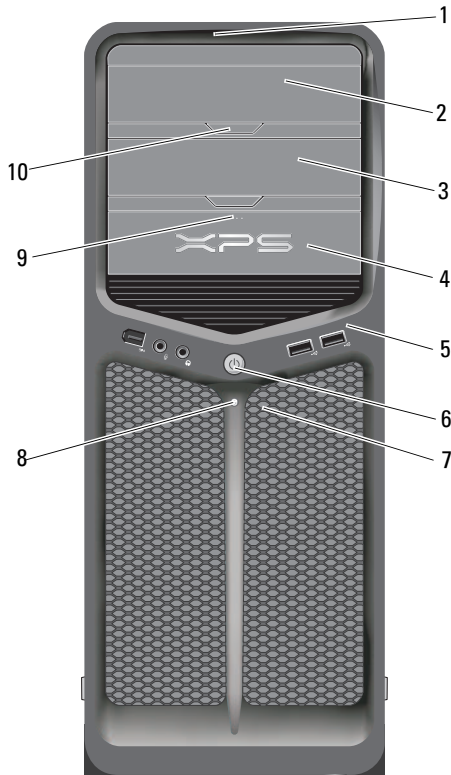
Front View of the Computer



-
- | | | |
|---|----------------------|--|
| 1 | front-panel LEDs (3) | Multi-colored lights provide illumination for the front of the computer. |
| 2 | optical-drive panel | This panel covers the optical drive. Use the optical drive to play a CD/DVD. |
-

3	optional optical-drive bay	Supports an optical drive.
4	FlexBay drive	Supports a floppy drive, a Media Card Reader, or an additional hard drive.
5	front I/O connectors	Plug USB and other devices into the appropriate connectors (see "Front-Panel Connectors" on page 20).
6	power button	<p>Press to turn on the computer.</p> <p> NOTICE: To avoid losing data, do not use the power button to turn off the computer. Instead, perform an operating system shutdown.</p> <p> NOTICE: If your operating system has ACPI enabled, when you press the power button the computer will perform an operating system shutdown.</p> <p>NOTE: The power button can also be used to wake the system or to place it into a power-saving state (see "Power Management" on page 38 for more information).</p>
7	front-panel LEDs (4)	Multi-colored lights provide illumination for the front of the computer.
8	power light	<p>The power light illuminates or remains solid to indicate different states:</p> <ul style="list-style-type: none"> • No light — The computer is turned off. • White light— The computer is in a normal operating state. • Blinking white light— The computer is in a power-saving state. <p>To exit from a power-saving state, press the power button or use the keyboard or mouse if it is configured as a wake device in the Windows Device Manager. For more information about sleep states and exiting from a power-saving state, see "Power Management" on page 38.</p>
9	FlexBay drive eject button	Press here to open or close the floppy/media card reader panel.
10	optical drive panel eject button (2)	Press here to open/close the optical drive.

Back View of the Computer

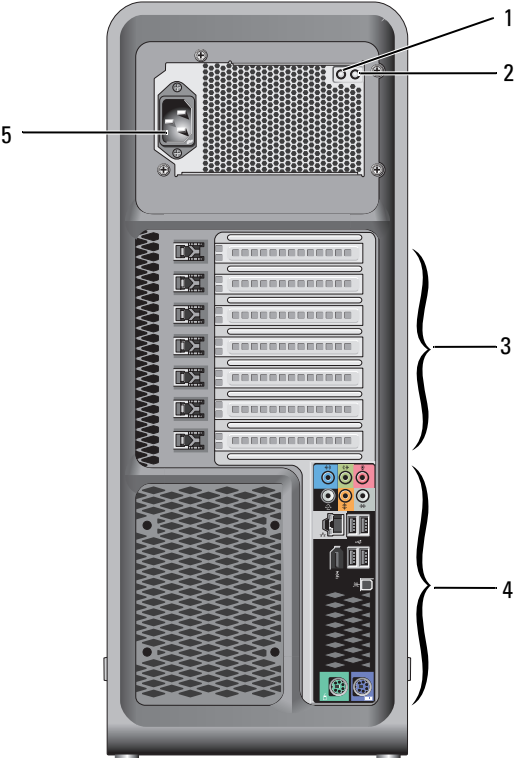

1	power supply test switch	Used to test the power supply.
2	power supply diagnostic LED	Indicates power availability for power supply. <ul style="list-style-type: none"> • Green light — Indicates power availability for power supply. • No light — Indicates no power available for the power supply or the power supply is not working. For more information, see "Power Lights" on page 89.
3	card slots	Access connectors for any installed PCI or PCI Express cards. NOTE: Some connector slots support full-length cards.
4	back I/O connectors	Plug USB and other devices into the appropriate connectors (see "Back-Panel Connectors" on page 21).
5	power connector	Insert the power cable. The appearance of this connector may differ from what is pictured.

Front-Panel Connectors

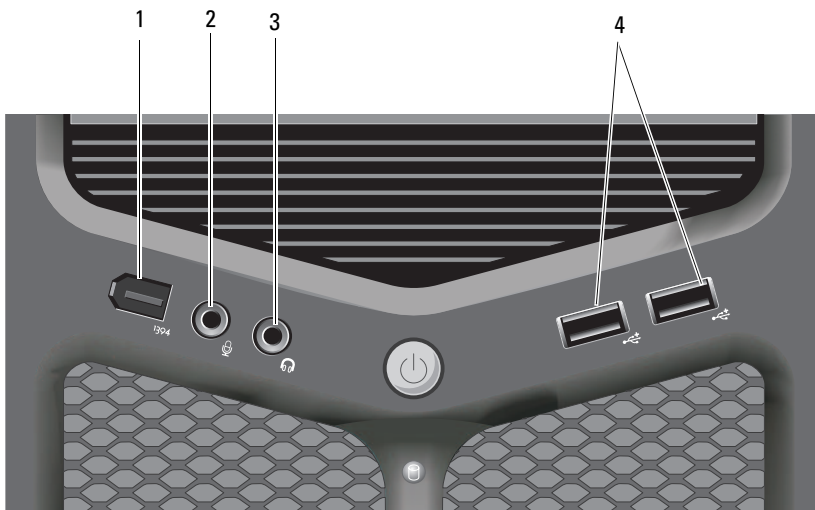

1	IEEE 1394 connector	Use the optional IEEE 1394 connector for high-speed data devices such as digital video cameras and external storage devices.
2	microphone connector	Use the microphone connector to attach a personal computer microphone for voice or musical input into a sound or telephony program.
3	headphone connector	Use the headphone connector to attach headphones or external speakers.
4	USB 2.0 connectors (2)	Use the front USB connectors for devices that you connect occasionally, such as flash memory keys or cameras, or for bootable USB devices (see "System Setup" on page 77 for more information on booting to a USB device).

NOTE: It is recommended that you use the back USB connectors for devices that typically remain connected, such as printers and keyboards.

Back-Panel Connectors

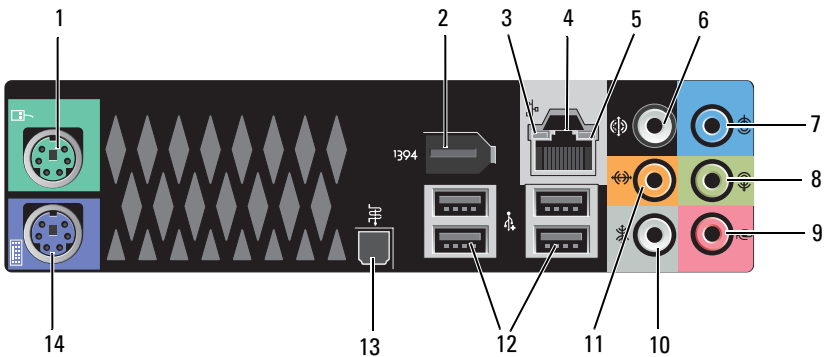

1	mouse connector	Plug a standard PS/2 mouse into the green mouse connector. Turn off the computer and any attached devices before you connect a mouse to the computer. If you have a USB mouse, plug it into a USB connector.
2	IEEE 1394 connector	Use the IEEE 1394 connector for high-speed data devices such as digital video cameras and external storage devices.
3	network activity light	The network activity light is on (flashing) when the computer is transmitting or receiving network data. A high volume of network traffic may make this light appear to be in a steady <i>on</i> state.
4	network adapter connector	To attach your computer to a network or broadband device, connect one end of a network cable to either a network jack or your network or broadband device. Connect the other end of the network cable to the network adapter connector on your computer. A click indicates that the network cable has been securely attached.  NOTICE: Do not plug a telephone cable into the network connector.
		On computers with an additional network connector card, use the connectors on the card and on the back of the computer when setting up multiple network connections (such as a separate intra- and extranet). It is recommended that you use Category 5 wiring and connectors for your network. If you must use Category 3 wiring, force the network speed to 10 Mbps to ensure reliable operation.
5	link integrity light	<ul style="list-style-type: none"> • Green — A good connection exists between a 10-Mbps network and the computer. • Orange — A good connection exists between a 100-Mbps network and the computer. • Yellow — A good connection exists between a 1000-Mbps (or 1-Gbps) network and the computer. • Off — The computer is not detecting a physical connection to the network.
6	surround sound connector	Use the (black) surround sound connector to attach multichannel-capable speakers.

7	line-in connector	Use the (blue) line-in connector to attach a record/playback device such as a cassette player, CD player, or VCR. On computers with a sound card, use the connector on the card.
8	line-out/headphone connector	Use the (green) line-out connector to attach headphones and speakers with integrated amplifiers. On computers with a sound card, use the connector on the card.
9	microphone connector	Use the (pink) microphone connector to attach a personal computer microphone for voice or musical input into a sound or telephony program.
10	side surround sound connector	Use the (silver) side surround connector to attach additional speakers.
11	center subwoofer/LFE connector	Use the (orange) subwoofer connector to attach a single subwoofer. NOTE: The LFE (Low Frequency Effects) Audio channel, found in digital surround sound audio schemes, carries only low frequency information of 80 Hz and below. The LFE channel drives a subwoofer to provide extremely low bass extension. Systems not using subwoofers can shunt the LFE information to the main speakers in the surround sound setup.
12	USB 2.0 connectors (4)	Use the back USB connectors for devices that typically remain connected, such as printers and keyboards. NOTE: It is recommended that you use the front USB connectors for devices that you connect occasionally, such as flash memory keys or cameras, or for bootable USB devices.
13	optical S/PDIF connector	Use the optical S/PDIF connector to transmit digital audio without going through an analog audio conversion process.
14	keyboard connector	Plug a standard PS/2 keyboard into the purple keyboard connector. Turn off the computer and any attached devices before you connect a keyboard to the computer. If you have a USB keyboard, plug it into a USB connector.

Setting Up Your Computer

Installing Your Computer in an Enclosure

Installing your computer in an enclosure can restrict the airflow and impact your computer's performance, possibly causing it to overheat. Follow the guidelines below when installing your computer in an enclosure:

- ➡ **NOTICE:** The operating temperature specifications indicated in this manual reflects the maximum ambient operating temperature. The room ambient temperature needs to be a consideration when installing your computer in an enclosure. For example, if the ambient room temperature is at 25°C (77°F), depending on your computer's specifications, you only have 5° to 10°C (9° to 18°F) temperature margin before you reach your computer's maximum operating temperature. For details about your computer's specifications, see "Specifications" on page 129.
- Leave a 10.2 cm (4 inches) minimum clearance on all vented sides of the computer to permit the airflow required for proper ventilation.
- If your enclosure has doors, they need to be of a type that allows at least 30 percent airflow through the enclosure (front and back).

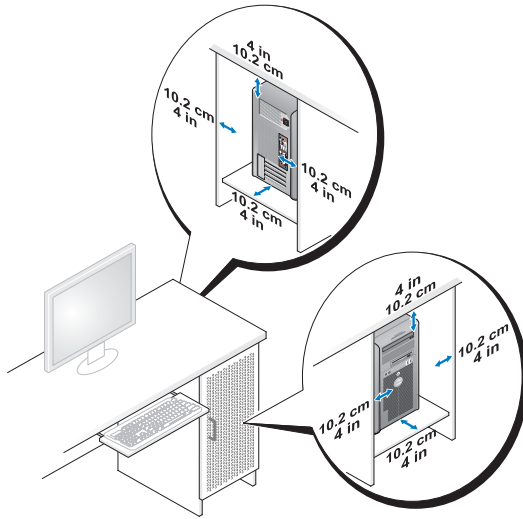

- If your computer is installed in a corner on a desk or under a desk, leave at least 5.1 cm (2 in) clearance from the back of the computer to the wall to permit the airflow required for proper ventilation.

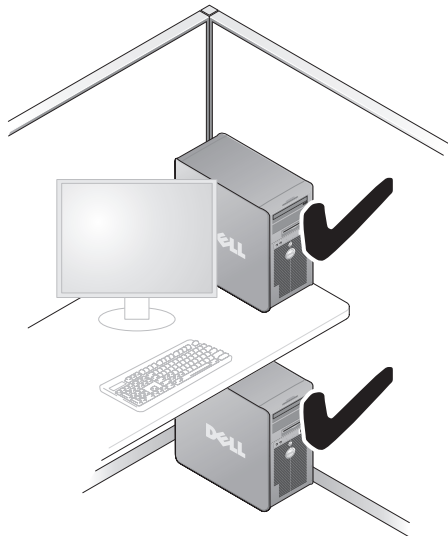

- ➔ **NOTICE:** Do not install your computer in an enclosure that does not allow airflow. Restricting the airflow impacts your computer's performance, possibly causing it to overheat.

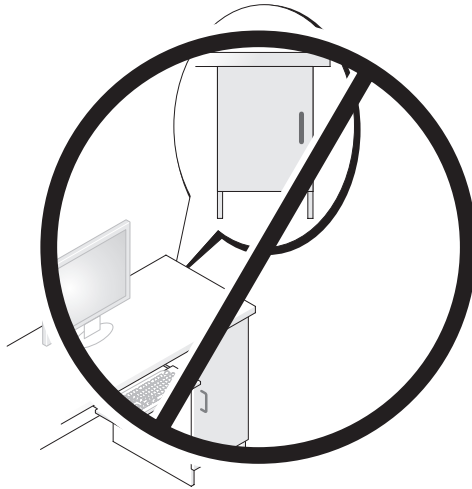

Connecting to the Internet

 **NOTE:** ISPs and ISP offerings vary by country.

To connect to the Internet, you need a modem or network connection and an Internet service provider (ISP). Your ISP will offer one or more of the following Internet connection options:

- DSL connections that provide high-speed Internet access through your existing telephone line or cellular telephone service. With a DSL connection, you can access the Internet and use your telephone on the same line simultaneously.
- Cable modem connections that provide high-speed Internet access through your local cable TV line.
- Satellite modem connections that provide high-speed Internet access through a satellite television system.

- Dial-up connections that provide Internet access through a telephone line. Dial-up connections are considerably slower than DSL and cable (or satellite) modem connections.
- Wireless LAN connections that provide Internet access using Bluetooth® wireless technology.

If you are using a dial-up connection, connect a telephone line to the modem connector on your computer and to the telephone wall jack before you set up your Internet connection. If you are using a DSL or cable/satellite modem connection, contact your ISP or cellular telephone service for setup instructions.

Setting Up Your Internet Connection

To set up an Internet connection with a provided ISP desktop shortcut:

- 1 Save and close any open files, and exit any open programs.
- 2 Double-click the ISP icon on the Microsoft® Windows® desktop.
- 3 Follow the instructions on the screen to complete the setup.

If you do not have an ISP icon on your desktop or if you want to set up an Internet connection with a different ISP, perform the steps in the following section that corresponds to the operating system your computer is using.



NOTE: If you are having problems connecting to the Internet, see "Error Messages" on page 103. If you cannot connect to the Internet but have successfully connected in the past, the ISP might have a service outage. Contact your ISP to check the service status, or try connecting again later.

Windows XP

- 1 Save and close any open files, and exit any open programs.
- 2 Click **Start** → **Internet Explorer**.
The **New Connection Wizard** appears.
- 3 Click **Connect to the Internet**.
- 4 In the next window, click the appropriate option:
 - If you do not have an ISP and want to select one, click **Choose from a list of Internet service providers (ISPs)**.
 - If you have already obtained setup information from your ISP but you did not receive a setup CD, click **Set up my connection manually**.
 - If you have a CD, click **Use the CD I got from an ISP**.

- 5 Click **Next**.

If you selected **Set up my connection manually**, continue to step 6. Otherwise, follow the instructions on the screen to complete the setup.



NOTE: If you do not know which type of connection to select, contact your ISP.

- 6 Click the appropriate option under **How do you want to connect to the Internet?**, and then click **Next**.
- 7 Use the setup information provided by your ISP to complete the setup.

Windows Vista®



NOTE: Have your ISP information ready. If you do not have an ISP, the **Connect to the Internet** wizard can help you get one.

- 1 Save and close any open files, and exit any open programs.
- 2 Click the Windows Vista Start button , and click **Control Panel**
- 3 Under **Network and Internet**, click **Connect to the Internet**.
The **Connect to the Internet** window appears.
- 4 Click either **Broadband (PPPoE)** or **Dial-up**, depending on how you want to connect:
 - Choose **Broadband** if you will use a DSL, satellite modem, cable TV modem, or Bluetooth wireless technology connection.
 - Chose **Dial-up** if you will use a dial-up modem or ISDN.



NOTE: If you do not know which type of connection to select, click **Help me choose** or contact your ISP.

- 5 Follow the instructions on the screen and use the setup information provided by your ISP to complete the setup.

Transferring Information to a New Computer

You can use your operating system "wizards" to help you transfer files and other data from one computer to another—for example, from an *old* computer to a *new* computer. For instructions, see the following section that corresponds to the operating system that your computer is running.

Microsoft® Windows® XP

The Microsoft Windows XP operating system provides the **Files and Settings Transfer Wizard** to move data from a source computer to a new computer.

You can transfer data, such as:

- E-mail messages
- Toolbar settings
- Window sizes
- Internet bookmarks

You can transfer the data to the new computer over a network or serial connection, or you can store it on removable media, such as a writable CD, for transfer to the new computer.



NOTE: You can transfer information from an old computer to a new computer by directly connecting a serial cable to the input/output (I/O) ports of the two computers. To transfer data over a serial connection, you must access the Network Connections utility from the Control Panel and perform additional configuration steps, such as setting up an advanced connection and designating the host computer and the guest computer.

For instructions on setting up a direct cable connection between two computers, see Microsoft Knowledge Base Article #305621, titled *How to Set Up a Direct Cable Connection Between Two Computers in Windows XP*. This information may not be available in certain countries.

For transferring information to a new computer, you must run the Files and Settings Transfer Wizard. You can use the optional *Operating System* media for this process or you can create a wizard disk with the Files and Settings Transfer Wizard.

Running the Files and Settings Transfer Wizard With the Operating System Media



NOTE: This procedure requires the *Operating System* media.

To prepare a new computer for the file transfer:

- 1 Open the Files and Settings Transfer Wizard: click **Start**→ **All Programs**→ **Accessories**→ **System Tools**→ **Files and Settings Transfer Wizard**.
- 2 When the **Files and Settings Transfer Wizard** welcome screen appears, click **Next**.

- 3 On the **Which computer is this?** screen, click **New Computer**→**Next**.
- 4 On the **Do you have a Windows XP CD?** screen, click **I will use the wizard from the Windows XP CD**→**Next**.
- 5 When the **Now go to your old computer** screen appears, go to your old or source computer. Do *not* click **Next** at this time.

To copy data from the old computer:

- 1 On the old computer, insert the *Windows XP Operating System* media.
- 2 On the **Welcome to Microsoft Windows XP** screen, click **Perform additional tasks**.
- 3 Under **What do you want to do?**, click **Transfer files and settings**→**Next**.
- 4 On the **Which computer is this?** screen, click **Old Computer**→**Next**.
- 5 On the **Select a transfer method** screen, click the transfer method you prefer.
- 6 On the **What do you want to transfer?** screen, select the items you want to transfer and click **Next**.

After the information has been copied, the **Completing the Collection Phase** screen appears.

- 7 Click **Finish**.

To transfer data to the new computer:

- 1 On the **Now go to your old computer** screen on the new computer, click **Next**.
- 2 On the **Where are the files and settings?** screen, select the method you chose for transferring your settings and files and click **Next**.

The wizard reads the collected files and settings and applies them to your new computer.

When all of the settings and files have been applied, the **Finished** screen appears.

- 3 Click **Finished** and restart the new computer.

Running the Files and Settings Transfer Wizard Without the Operating System Media

To run the Files and Settings Transfer Wizard without the *Operating System* media, you must create a wizard disk that will allow you to create a backup image file to removable media.

To create a wizard disk, use your new computer with Windows XP and perform the following steps:

- 1 Open the Files and Settings Transfer Wizard: click **Start**→ **All Programs**→ **Accessories**→ **System Tools**→ **Files and Settings Transfer Wizard**.
- 2 When the **Files and Settings Transfer Wizard** welcome screen appears, click **Next**.
- 3 On the **Which computer is this?** screen, click **New Computer**→ **Next**.
- 4 On the **Do you have a Windows XP CD?** screen, click **I want to create a Wizard Disk in the following drive**→ **Next**.
- 5 Insert the removable media, such as a writable CD, and click **OK**.
- 6 When the disk creation completes and the **Now go to your old computer** message appears, *do not* click **Next**.
- 7 Go to the old computer.

To copy data from the old computer:

- 1 On the old computer, insert the wizard disk.
- 2 Click **Start**→ **Run**.
- 3 In the **Open** field on the **Run** window, browse to the path for **fastwiz** (on the appropriate removable media) and click **OK**.
- 4 On the **Files and Settings Transfer Wizard** welcome screen, click **Next**.
- 5 On the **Which computer is this?** screen, click **Old Computer**→ **Next**.
- 6 On the **Select a transfer method** screen, click the transfer method you prefer.
- 7 On the **What do you want to transfer?** screen, select the items you want to transfer and click **Next**.

After the information has been copied, the **Completing the Collection Phase** screen appears.

- 8 Click **Finish**.

To transfer data to the new computer:

- 1 On the **Now go to your old computer** screen on the new computer, click **Next**.
- 2 On the **Where are the files and settings?** screen, select the method you chose for transferring your settings and files and click **Next**. Follow the instructions on the screen.

The wizard reads the collected files and settings and applies them to your new computer.

When all of the settings and files have been applied, the **Finished** screen appears.

- 3 Click **Finished** and restart the new computer.



NOTE: For more information about this procedure, search support.dell.com for document #154781 (*What Are The Different Methods To Transfer Files From My Old Computer To My New Dell™ Computer Using the Microsoft® Windows® XP Operating System?*).



NOTE: Access to the Dell™ Knowledge Base document may not be available in certain countries.

Windows Vista

- 1 Click the Windows Vista Start button , and then click **Transfer files and settings**→ **Start Windows Easy Transfer**.
- 2 In the **User Account Control** dialog box, click **Continue**.
- 3 Click **Start a new transfer** or **Continue a transfer in progress**.

Follow the instructions provided on the screen by the Windows Easy Transfer wizard.

Setting Up a Printer



NOTICE: Complete the operating system setup before you connect a printer to the computer.

See the documentation that came with the printer for setup information, including how to:

- Obtain and install updated drivers.
- Connect the printer to the computer.
- Load paper and install the toner or ink cartridge.

For technical assistance, refer to the printer owner's manual or contact the printer manufacturer.

Printer Cable

Your printer connects to your computer with either a USB cable or a parallel cable. Your printer may not come with a printer cable, so if you purchase a cable separately, ensure that it is compatible with your printer and computer. If you purchased a printer cable at the same time you purchased your computer, the cable may arrive in the computer's shipping box.

Connecting a USB Printer

 **NOTE:** You can connect USB devices while the computer is turned on.

- 1 Complete the operating system setup if you have not already done so.
- 2 Attach the USB printer cable to the USB connectors on the computer and the printer. The USB connectors fit only one way.

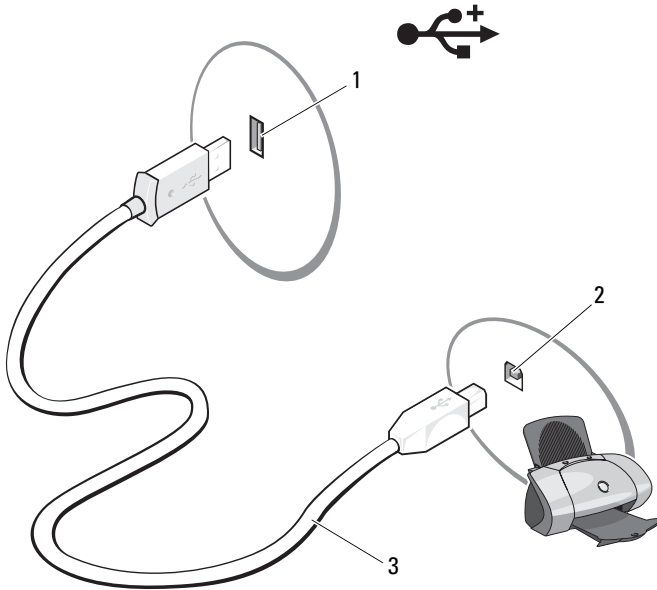

- 1 USB connector on computer
- 2 USB connector on printer
- 3 USB printer cable

- 3 Turn on the printer and then turn on the computer.
- 4 Depending on your computer's operating system, a printer wizard may be available to help you install the printer driver:

*If your computer is running the Microsoft® Windows® XP operating system and the **Add New Hardware Wizard** window appears, click **Cancel**.*

*If your computer is running the Windows Vista® operating system, click the Windows Vista Start button , and click **Network**→ **Add a printer** to start the Add Printer Wizard.*

- 5 Install the printer driver if necessary. See "Reinstalling Drivers and Utilities" on page 118 and the documentation that came with your printer.

Connecting Two Monitors

 **CAUTION:** Before you begin any of the procedures in this section, follow the safety instructions in the *Product Information Guide*.

If you purchased a graphics card that supports dual monitors, follow these instructions to connect and enable your monitors. The instructions tell you how to connect either two monitors (each with a VGA connector), one monitor with a VGA connector and one monitor with a DVI connector, or a TV.

 **NOTICE:** If you are connecting two monitors that have VGA connectors, you must have the optional DVI adapter to connect the cable. If you are connecting two flat-panel monitors, at least one of them must have a VGA connector. If you are connecting a TV, you may connect only one monitor (VGA or DVI) in addition to the TV.

Connecting Two Monitors With VGA Connectors

- 1 Shutdown your system.

 **NOTE:** If your computer has integrated video, do not connect either monitor to the integrated video connector. If the integrated video connector is covered by a cap, do not remove the cap to connect the monitor or the monitor will not function.

- 2 Connect one of the monitors to the VGA (blue) connector on the back of the computer.
- 3 Connect the other monitor to the optional DVI adapter and connect the DVI adapter to the DVI (white) connector on the back of the computer.
- 4 Restart your system.

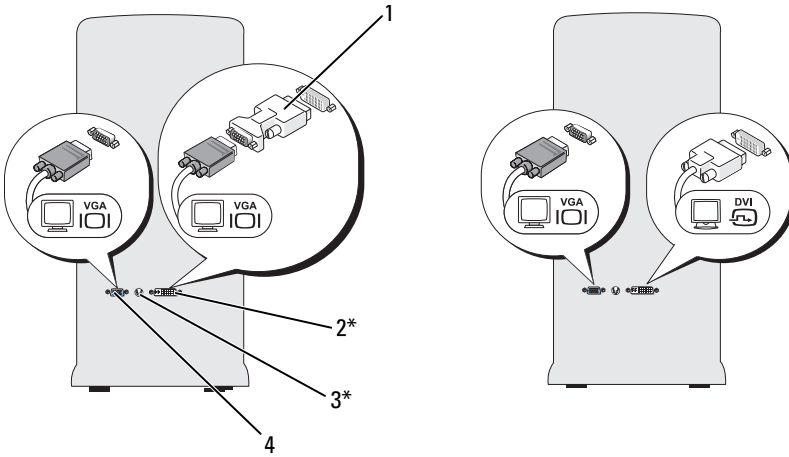

*May not be present on your computer

- | | |
|------------------------|-------------------------|
| 1 optional DVI adapter | 2 DVI (white) connector |
| 3 TV-OUT connector | 4 VGA (blue) connector |

Connecting One Monitor With a VGA Connector and One Monitor With a DVI Connector

- 1 Shutdown your system.
- 2 Connect the VGA connector on the monitor to the VGA (blue) connector on the back of the computer.
- 3 Connect the DVI connector on the other monitor to the DVI (white) connector on the back of the computer.
- 4 Restart your system.

Connecting a TV



NOTE: You must purchase an S-video cable, available at most consumer electronics stores, to connect a TV to your computer. It is not included with your computer.

- 1 Shutdown your system.
- 2 Connect one end of the S-video cable to the optional TV-OUT connector on the back of the computer.
- 3 Connect the other end of the S-video cable to the S-video input connector on your TV.
- 4 Connect the VGA or DVI monitor.
- 5 Restart your system.

Changing the Display Settings

- 1 After you connect the monitor(s) or TV, turn on the computer. The Microsoft® Windows® desktop displays on the primary monitor.
- 2 Enable extended desktop mode in the display settings. In extended desktop mode, you can drag objects from one screen to the other, effectively doubling the amount of viewable work space.

Power Protection Devices

Several devices are available to protect against power fluctuations and failures:

- Surge protectors
- Line conditioners
- Uninterruptible power supplies (UPS)

Surge Protectors

Surge protectors and power strips equipped with surge protection help prevent damage to your computer from voltage spikes that can occur during electrical storms or after power interruptions. Some surge protector manufacturers include warranty coverage for certain types of damage. Carefully read the device warranty when choosing a surge protector. A device with a higher joule rating offers more protection. Compare joule ratings to determine the relative effectiveness of different devices.

- ➔ **NOTICE:** Most surge protectors do not protect against power fluctuations or power interruptions caused by nearby lightning strikes. When lightning occurs in your area, disconnect the telephone line from the telephone wall jack and disconnect your computer from the electrical outlet.

Many surge protectors have a telephone jack for modem protection. See the surge protector documentation for modem connection instructions.

- ➔ **NOTICE:** Not all surge protectors offer network adapter protection. Disconnect the network cable from the network wall jack during electrical storms.

Line Conditioners

- ➔ **NOTICE:** Line conditioners do not protect against power interruptions.

Line conditioners are designed to maintain AC voltage at a fairly constant level.

Uninterruptible Power Supplies

- ➔ **NOTICE:** Loss of power while data is being saved to the hard drive may result in data loss or file damage.

- 📌 **NOTE:** To ensure maximum battery operating time, connect only your computer to a UPS. Connect other devices, such as a printer, to a separate power strip that provides surge protection.

A UPS protects against power fluctuations and interruptions. UPS devices contain a battery that provides temporary power to connected devices when AC power is interrupted. The battery charges while AC power is available. See the UPS manufacturer documentation for information on battery operating time and to ensure that the device is approved by Underwriters Laboratories (UL).

Power Management

Power Management Options in Windows XP

The Microsoft Windows XP power management features can reduce the amount of electricity your computer uses when it is on and you are not using it. You can reduce power to just the monitor or the hard drive, or you can use standby mode or hibernate mode to reduce power to the entire computer. When the computer exits from a power conservation mode, it returns to the operating state it was in prior to entering the mode.

 **NOTE:** Windows XP Professional includes security and networking features not available in Windows XP Home Edition. When a Windows XP Professional computer is connected to a network, different options related to security and networking appear in certain windows.

 **NOTE:** The procedures to activate the standby and hibernate modes may vary according to your operating system.

Standby Mode

Standby mode conserves power by turning off the display and the hard drive after a designated period of time, known as a time-out. When the computer exits from standby mode, it returns to the operating state it was in prior to entering standby mode.

 **NOTICE:** If your computer loses power while in standby mode, it may lose data.

To set standby mode to automatically activate after a defined period of inactivity:

- 1 Click **Start**→ **Control Panel**→ **Pick a category**→ **Performance and Maintenance**.
- 2 Under or pick a **Control Panel** icon, click **Power Options**.

To immediately activate standby mode without a period of inactivity, click **Start**→ **Turn Off Computer**→ **Stand by**.

To exit from standby mode, press a key on the keyboard or move the mouse.

Hibernate Mode

Hibernate mode conserves power by copying system data to a reserved area on the hard drive, and then completely turning off the computer. When the computer exits from hibernate mode, the desktop is restored to the state it was in prior to entering hibernate mode.

To activate hibernate mode:

- 1 Click **Start**→ **Control Panel**→ **Pick a category**→ **Performance and Maintenance**.
- 2 Under or pick a **Control Panel** icon, click **Power Options**.
- 3 Define your hibernate settings on the **Power Schemes** tab, **Advanced** tab, and **Hibernate** tab.

To exit from hibernate mode, press the power button. The computer may take a short time to exit from hibernate mode. Because the keyboard and mouse do not function in hibernate mode, pressing a key on the keyboard or moving the mouse does not bring the computer out of hibernation.

Because hibernate mode requires a special file on your hard drive with enough disk space to store the contents of the computer memory, Dell creates an appropriately sized hibernate mode file before shipping the computer to you. If the computer's hard drive becomes corrupted, Windows XP recreates the hibernate file automatically.

Power Options Properties

Define your standby mode settings, hibernate mode settings, and other power settings in the **Power Options Properties** window. To access the **Power Options Properties** window:

- 1 Click **Start** → **Control Panel** → **Pick a category** → **Performance and Maintenance**.
- 2 Under or pick a **Control Panel** icon, click **Power Options**.
- 3 Define your power settings on the **Power Schemes** tab, **Advanced** tab, and **Hibernate** tab.

Power Schemes Tab

Each standard power setting is called a scheme. If you want to select one of the standard Windows schemes installed on your computer, choose a scheme from the **Power schemes** drop-down menu. The settings for each scheme appear in the fields below the scheme name. Each scheme has different settings for starting standby mode, hibernate mode, turning off the monitor, and turning off the hard drive.



NOTICE: If you set the hard drive to time-out before the monitor does, your computer may appear to be locked up. To recover, press any key on the keyboard or click the mouse. To avoid this problem, always set the monitor to time-out before the hard drive.

The **Power schemes** drop-down menu displays the following schemes:

- **Always On** (default) — If you want to use your computer with no power conservation.
- **Home/Office Desk** — If you want your home or office computer to run with little power conservation.

- **Portable/Laptop** — If your computer is a portable computer that you use for traveling.
- **Presentation** — If you want your computer to run without interruption (using no power conservation).
- **Minimal Power Management** — If you want your computer to run with minimal power conservation.
- **Max Battery** — If your computer is a portable computer and you run your computer from batteries for an extended period of time.

If you want to change the default settings for a scheme, click the drop-down menu in the **Turn off monitor**, **Turn off hard disks**, **System stand by**, or **System hibernates** field, and then select a time-out from the displayed list. Changing the time-out for a scheme field permanently changes the default settings for that scheme, unless you click **Save As** and enter a new name for the changed scheme.

Advanced Tab

The **Advanced** tab allows you to:

- Place the power options icon  in the Windows taskbar for quick access.
- Set the computer to prompt you for your Windows password before the computer exits from standby mode or hibernate mode.
- Program the power button to activate standby mode, activate hibernate mode, or turn off the computer.

To program these functions, click an option from the corresponding drop-down menu and click **OK**.

Hibernate Tab

The **Hibernate** tab allows you to enable hibernate mode. If you want to use the hibernate settings as defined on the **Power Schemes** tab, click the **Enable hibernate support** check box on the **Hibernate** tab.

For more information on power management options:

- 1 Click **Start**→ **Help and Support**→ **Performance and maintenance**.
- 2 In the **Performance and maintenance** window, click **Conserving power on your computer**.

Power Management Options in Windows Vista

The Microsoft Vista power management features can reduce the amount of electricity your computer uses when it is on and you are not using it. You can reduce power to just the monitor or the hard drive, or you can use sleep mode or hibernate mode to reduce power to the entire computer. When the computer exits from a power conservation mode, it returns to the operating state it was in prior to entering the mode.

Sleep Mode

Sleep mode conserves power by turning off the display and the hard drive after a predetermined period of inactivity (a time-out). When the computer exits sleep mode, it returns to the same operating state it was in before entering sleep mode.

To enter sleep mode in Windows Vista, click **Start** , click the arrow in the lower-right corner of the Start menu, and then click **Sleep**.

To exit sleep mode, press a key on the keyboard or move the mouse.

Hibernate Mode

Hibernate mode conserves power by copying system data to a reserved area on the hard drive and then completely turning off the computer. When the computer exits hibernate mode, it returns to the same operating state it was in before entering hibernate mode.

To manually enter hibernate mode in Windows Vista, click **Start** , click the arrow in the lower-right corner of the Start menu, and then click **Hibernate**.

Configuring Power Management Settings

You can use the Windows Power Options Properties to configure the power management settings on your computer.

To access Power Options Properties, click **Start**  → **Control Panel** → **System and Maintenance** → **Power Options**.

Using Multimedia

Playing CDs or DVDs



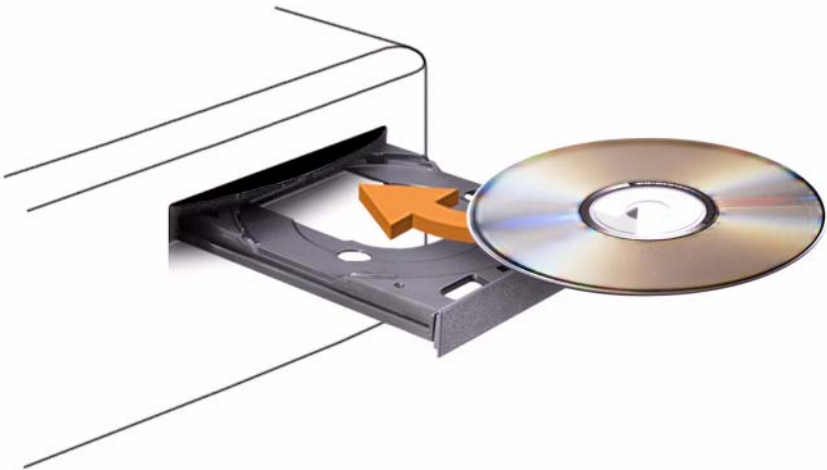





- ➔ **NOTICE:** Do not press down on the CD/DVD tray when you open or close it. Keep the tray closed when you are not using the drive.
- ➔ **NOTICE:** Do not move the computer while playing CDs or DVDs.
 - 1 Press the eject button on the front of the drive.
 - 2 Place the disc, label side up, in the center of the tray.
 - 3 Press the eject button or gently push in the tray.













To format CDs for storing data, to create music CDs, or to copy CDs, see the CD software that came with your computer.

 **NOTE:** Ensure that you follow all copyright laws when you create CDs.

A CD player includes the following basic buttons:

	Play.
	Move backward within the current track.
	Pause.
	Move forward within the current track.
	Stop.
	Go to the previous track.
	Eject.
	Go to the next track.

A DVD player includes the following basic buttons:

	Stop.
	Restart the current chapter.
	Play.
	Fast forward.
	Pause.
	Fast reverse.
	Advance a single frame while in pause mode.
	Go to the next title or chapter.
	Continuously play the current title or chapter.
	Go to the previous title or chapter.
	Eject.

For more information on playing CDs or DVDs, click **Help** on the CD or DVD player (if available).

Copying CDs and DVDs

 **NOTE:** Ensure that you observe all copyright laws when creating CDs or DVDs.

This section applies only to computers that have a CD-RW, DVD+/-RW, or CD-RW/DVD (combo) drive.

 **NOTE:** The types of CD or DVD drives offered by Dell may vary by country.

The following instructions explain how to make an exact copy of a CD or DVD using Roxio Creator Plus - Dell Edition. You can also use Roxio Creator Plus for other purposes, such as creating music CDs from audio files stored on your computer or backing up important data. For help, open Roxio Creator Plus, and then click the question mark icon in the upper-right corner of the window.

How to Copy a CD or DVD

 **NOTE:** CD-RW/DVD combo drives cannot write to DVD media. If you have a CD-RW/DVD combo drive and you experience recording problems, check for available software patches on the Sonic Support website at sonic.com.

The DVD-writable drives installed in Dell™ computers can write to and read DVD+/-R, DVD+/-RW and DVD+R DL (dual layer) media, but cannot write to and may not read DVD-RAM or DVD-R DL media.

 **NOTE:** Most commercial DVDs have copyright protection and cannot be copied using Roxio Creator Plus.

- 1 Open Roxio Creator Plus.
- 2 Under the **Copy** tab, click **Disc Copy**.
- 3 To copy the CD or DVD:
 - *If you have one CD/DVD drive*, ensure that the settings are correct, and then click **Disc Copy**. The computer reads your source CD or DVD and copies the data to a temporary folder on your computer hard drive. When prompted, insert a blank CD or DVD into the drive and click **OK**.
 - *If you have two CD/DVD drives*, select the drive into which you have inserted your source CD or DVD, and then click **Disc Copy**. The computer copies the data from the source CD or DVD to the blank CD or DVD.

Once you have finished copying the source CD or DVD, the CD or DVD that you have created automatically ejects.

Using Blank CDs and DVDs

CD-RW drives can write to CD recording media only (including high-speed CD-RW media) while DVD-writable drives can write to both CD and DVD recording media.

Use blank CD-Rs to record music or permanently store data files. After the maximum storage capacity of a CD-R is reached, you cannot write to that CD-R again (see the Sonic documentation for more information). Use blank CD-RWs if you plan to erase, rewrite, or update information on the CD later.

Blank DVD+/-Rs can be used to permanently store large amounts of data. After you create a DVD+/-R disc, you may not be able to write to that disc again if the disc is *finalized* or *closed* during the final stage of the disc creation process. Use blank DVD+/-RWs if you plan to erase, rewrite, or update information on the disc later.

CD-Writable Drives

Media Type	Read	Write	Rewritable
CD-R	Yes	Yes	No
CD-RW	Yes	Yes	Yes

DVD-Writable Drives

Media Type	Read	Write	Rewritable
CD-R	Yes	Yes	No
CD-RW	Yes	Yes	Yes
DVD+R	Yes	Yes	No
DVD-R	Yes	Yes	No
DVD+RW	Yes	Yes	Yes
DVD-RW	Yes	Yes	Yes
DVD+R DL	Yes	Yes	No
DVD-R DL	Maybe	No	No
DVD-RAM	Maybe	No	No

Helpful Tips

- Use Microsoft® Windows® Explorer to drag and drop files to a CD-R or CD-RW only after you start Roxio Creator Plus and open a Creator project.
- Use CD-Rs to burn music CDs that you want to play in regular stereos. CD-RWs may not play in many home or car stereos.
- You cannot create audio DVDs with Roxio Creator Plus.
- Music MP3 files can be played only on MP3 players or on computers that have MP3 software installed.
- Commercially available DVD players used in home theater systems may not support all available DVD formats. For a list of formats supported by your DVD player, see the documentation provided with your DVD player or contact the manufacturer.
- Do not burn a blank CD-R or CD-RW to its maximum capacity; for example, do not copy a 650-MB file to a blank 650-MB CD. The CD-RW drive needs 1–2 MB of blank space to finalize the recording.
- Use a blank CD-RW to practice CD recording until you are familiar with CD recording techniques. If you make a mistake, you can erase the data on the CD-RW and try again. You can also use blank CD-RWs to test music file projects before you record the project permanently to a blank CD-R.
- See the Sonic website at sonic.com for additional information.

Adjusting the Picture

If an error message notifies you that the current resolution and color depth are using too much memory and preventing DVD playback, adjust the display properties.

Microsoft Windows XP

- 1** Click **Start**→ **Control Panel**→ **Appearance and Themes**.
- 2** Under **Pick a task...**, click **Change the screen resolution**.
- 3** Under **Screen resolution**, click and drag the bar to reduce the resolution setting.
- 4** In the drop-down menu under **Color quality**, click **Medium (16 bit)** and click **OK**.

Windows Vista® Operating System

- 1 Click the Windows Vista Start button , click **Control Panel**, and then click **Appearance and Personalization**.
- 2 Under **Personalization**, click **Adjust Screen Resolution**.
The **Display Properties** window appears.
- 3 Under **Resolution**: click and drag the bar reduce the resolution setting.
- 4 In the drop-down menu under **Colors**:, click **Medium (16 bit)**.
- 5 Click **OK**.

Connecting Your Computer to a TV or Audio Device

 **NOTE:** Video and audio cables for connecting your computer to a TV or other audio device may not be included with your computer. Cables and TV/digital audio adapter cables are available for purchase from Dell.

Your computer has an S-video TV-out connector (optional) that, together with a standard S-video cable, a composite video adapter cable, or a component video adapter cable (available from Dell), enable you to connect the computer to a TV.

Your TV has either an S-video input connector, a composite video-input connector, or a component video-input connector. Depending on what type of connector is available on your TV, you can use a commercially available S-video cable, composite video cable, or component video cable to connect your computer to your TV.

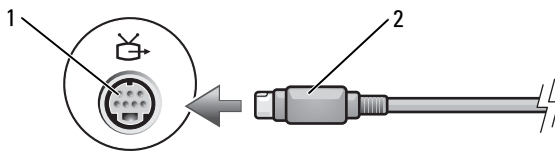

1 S-video TV-out connector 2 S-video connector

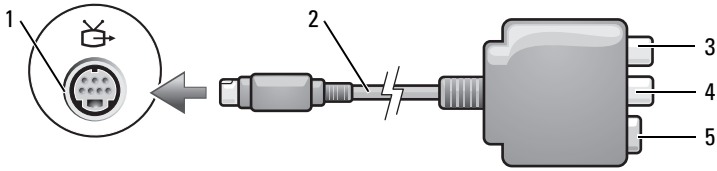

- | | |
|----------------------------------|------------------------------------|
| 1 S-video TV-out connector | 2 composite video adapter |
| 3 S/PDIF digital audio connector | 4 composite video-output connector |
| 5 S-video connector | |

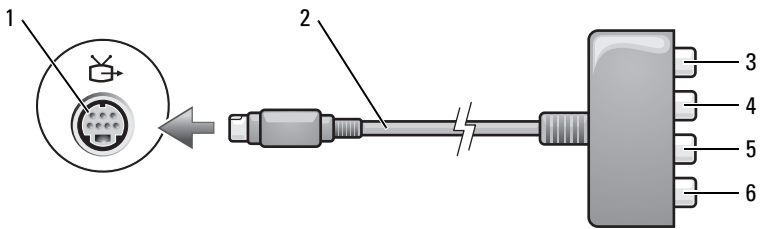

- | | |
|--|--|
| 1 S-video TV-out connector | 2 component video adapter |
| 3 S/PDIF digital audio connector | 4 Pr (red) component video-output connector |
| 5 Pb (blue) component video-output connector | 6 Y (green) component video-output connector |

If you want to connect your computer to a TV or audio device, it is recommended that you connect video and audio cables to your computer in one of the following combinations.

- S-video and standard audio
- Composite video and standard audio
- Component-out video and standard audio



NOTE: See the diagrams at the beginning of each subsection to help you determine which method of connection you should use.

When you finish connecting the video and audio cables between your computer and your TV, you must enable your computer to work with the TV. See "Enabling the Display Settings for a TV" on page 63 to ensure that the computer recognizes and works properly with the TV. Additionally, if you are using S/PDIF digital audio, see "Enabling S/PDIF Digital Audio" on page 62.

S-Video and Standard Audio

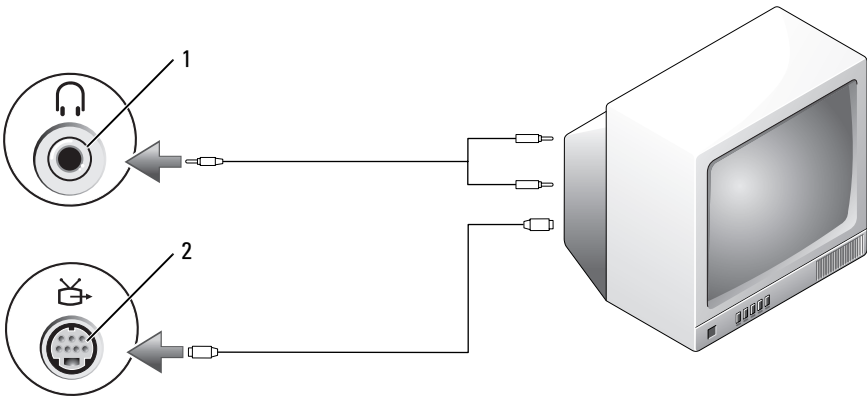

1 audio connector

2 S-video TV-out connector

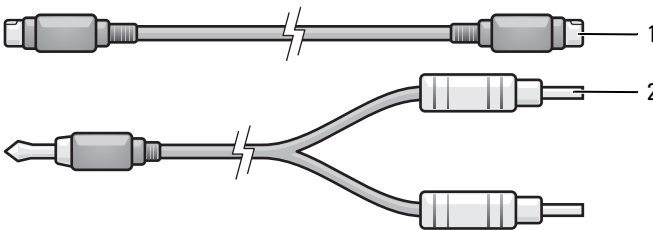

1 standard S-video cable

2 standard audio cable

- 1 Turn off the computer and the TV and/or audio device that you want to connect.



NOTE: If your TV or audio device supports S-video but not S/PDIF digital audio, you can connect an S-video cable directly to the S-video TV-out connector on the computer (without the TV/digital audio adapter cable).

- 2 Plug one end of the S-video cable into the S-video output connector on the computer.
- 3 Plug the other end of the S-video cable into the S-video input connector on your TV.
- 4 Plug the single-connector end of the audio cable into the headphone connector on your computer.
- 5 Plug the two RCA connectors on the other end of the audio cable into the audio input connectors on your TV or other audio device.
- 6 Turn on the TV and any audio device that you connected (if applicable), and then turn on the computer.
- 7 See "Enabling the Display Settings for a TV" on page 63 to ensure that the computer recognizes and works properly with the TV.

S-Video and S/PDIF Digital Audio

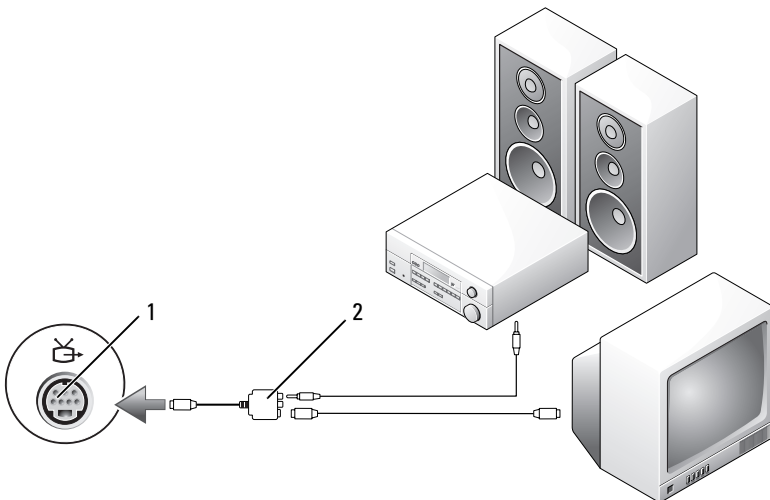

- 1 S-video TV-out connector 2 composite video adapter

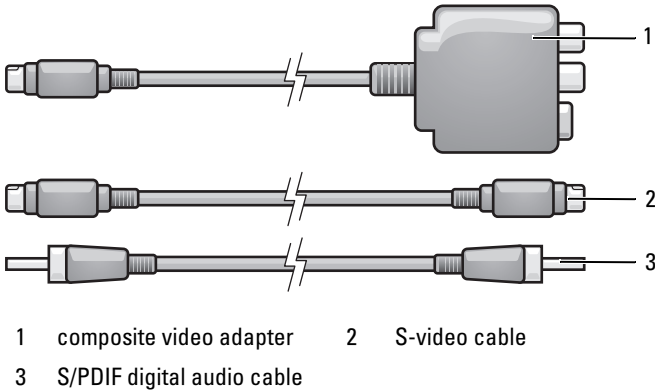

- 1 Turn off the computer and the TV and/or the audio device that you want to connect.
- 2 Connect the composite video adapter to the S-video TV-out connector on your computer.
- 3 Plug one end of the S-video cable into the S-video output connector on the composite video adapter.

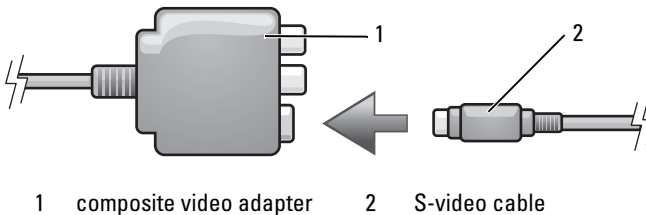

- 4 Plug the other end of the S-video cable into the S-video input connector on the TV.
- 5 Plug one end of the S/PDIF digital audio cable into the digital audio connector on the composite video adapter cable.

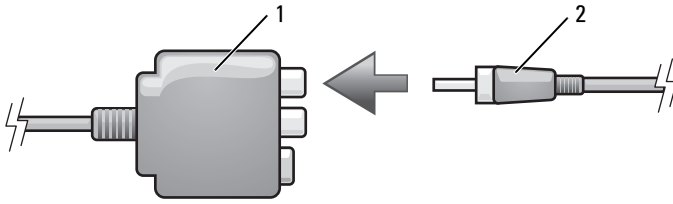

1 composite video adapter 2 S/PDIF digital audio cable

- 6 Plug the other end of the S/PDIF digital audio cable into the audio input connector on your TV or audio device.
- 7 Turn on the TV, turn on any audio device that you connected (if applicable), and then turn on the computer.
- 8 See "Enabling the Display Settings for a TV" on page 63 to ensure that the computer recognizes and works properly with the TV.

Composite Video and Standard Audio

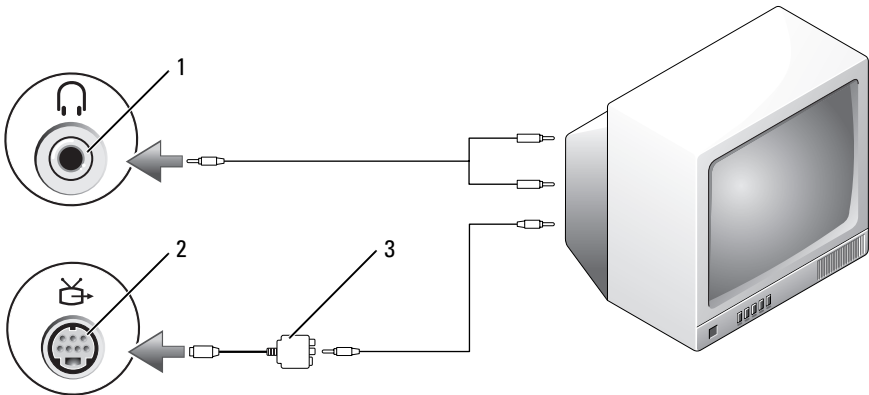

1 audio input connector 2 S-video TV-out connector
3 composite video adapter

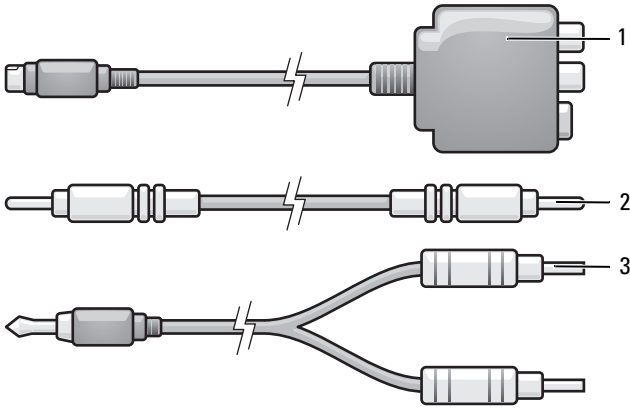

- 1 composite video adapter
- 2 composite video cable
- 3 standard audio cable

- 1 Turn off the computer and the TV and/or audio device that you want to connect.
- 2 Connect the composite video adapter to the S-video TV-out connector on your computer.
- 3 Plug one end of the composite video cable into the composite video-output connector on the composite video adapter.

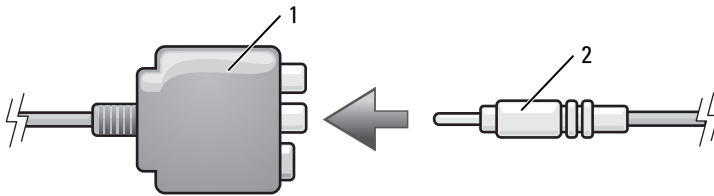

- 1 composite video adapter
- 2 composite video cable

- 4 Plug the other end of the composite video cable into the composite video-input connector on the TV.

- 5 Plug the single-connector end of the audio cable into the headphone connector on the computer.
- 6 Plug the two RCA connectors on the other end of the audio cable in to the audio input connectors on your TV or other audio device.
- 7 Turn on the TV, turn on any audio device that you connected (if applicable), and then turn on the computer.
- 8 See "Enabling the Display Settings for a TV" on page 63 to ensure that the computer recognizes and works properly with the TV.

Composite Video and S/PDIF Digital Audio

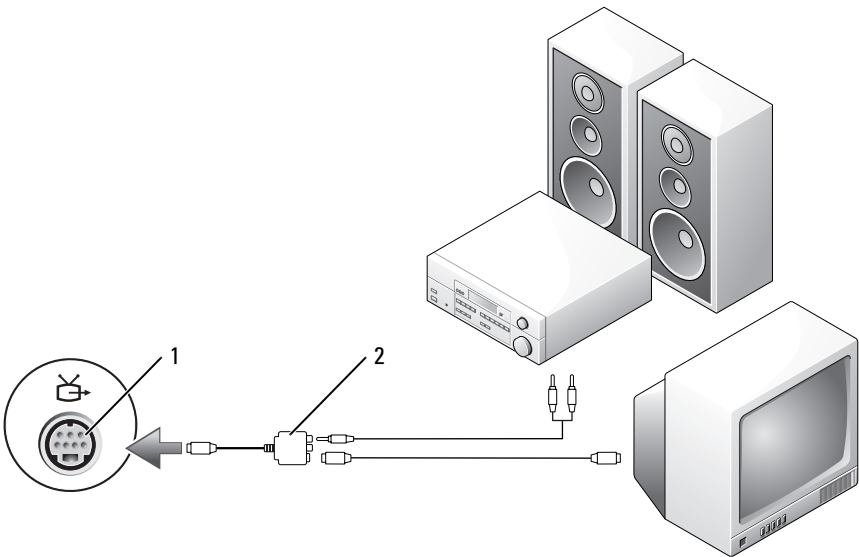

1 S-video TV-out connector 2 composite video adapter

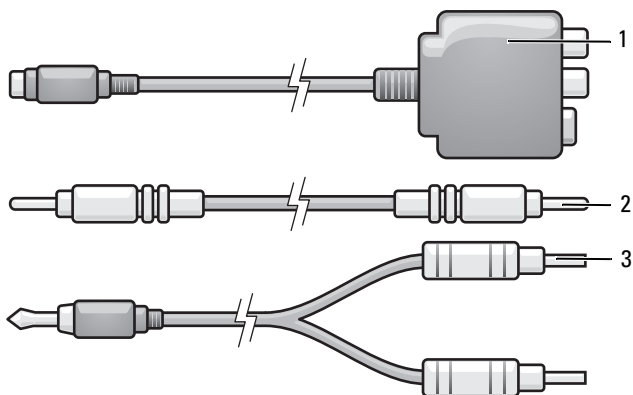

- 1 composite video adapter
- 2 composite video cable
- 3 standard audio cable

- 1 Turn off the computer and the TV and/or audio device that you want to connect.
- 2 Connect the composite video adapter to the S-video TV-out connector on the computer.
- 3 Plug one end of the composite video cable into the composite video-input connector on the composite video adapter.

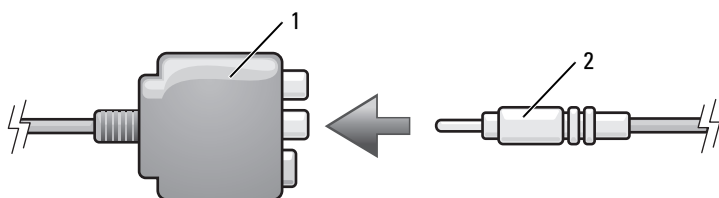

- 1 composite video adapter
- 2 composite video cable

- 4 Plug the other end of the composite video cable into the composite video-input connector on the TV.
- 5 Plug one end of the S/PDIF digital audio cable in to the S/PDIF audio connector on the composite video adapter.

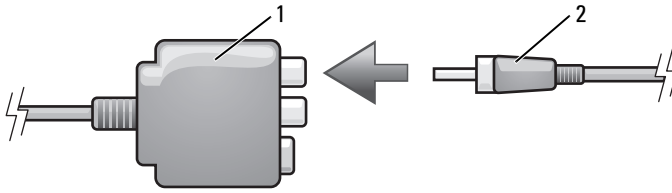

1 composite video adapter 2 S/PDIF digital audio cable

- 6 Plug the other end of the digital audio cable into the S/PDIF input connector on your TV or other audio device.
- 7 Turn on the TV, turn on any audio device that you connected (if applicable), and then turn on the computer.
- 8 See "Enabling the Display Settings for a TV" on page 63 to ensure that the computer recognizes and works properly with the TV.

Component Video and Standard Audio

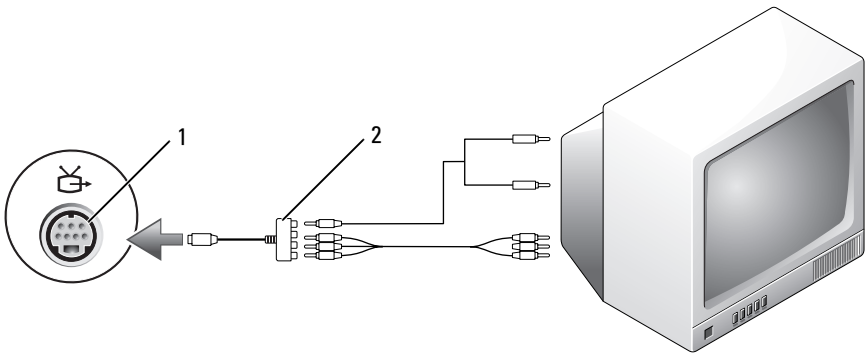

1 S-video TV-out connector 2 component video adapter

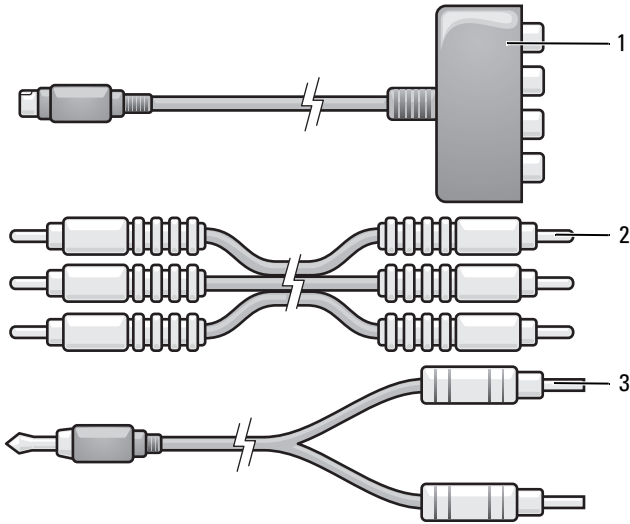

- 1 component video adapter 2 component video cable
 3 standard audio cable

- 1 Turn off the computer and the TV and/or audio device that you want to connect.
- 2 Connect the component video adapter to the S-video TV-out connector on your computer.
- 3 Plug all three ends of the component video cable into the component video-output connectors on the component video adapter. Make sure that the red, green, and blue colors of the cable match the corresponding adapter ports.

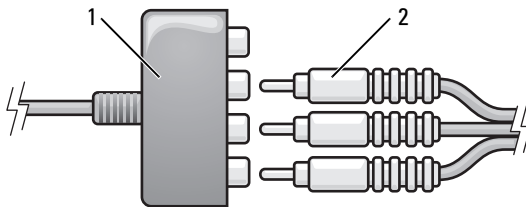

- 1 component video adapter 2 component video cable

- 4 Plug all three connectors from the other end of the component video cable into the component video-input connectors on the TV. Make sure that the red, green, and blue colors of the cable match the colors of the TV input connectors.
- 5 Plug the single-connector end of the audio cable into the headphone connector on the computer.
- 6 Plug the two RCA connectors on the other end of the audio cable into the audio input connectors on your TV or audio device.
- 7 Turn on the TV, turn on any audio device that you connected (if applicable), and then turn on the computer.
- 8 See "Enabling the Display Settings for a TV" on page 63 to ensure that the computer recognizes and works properly with the TV.

Component Video and S/PDIF Digital Audio

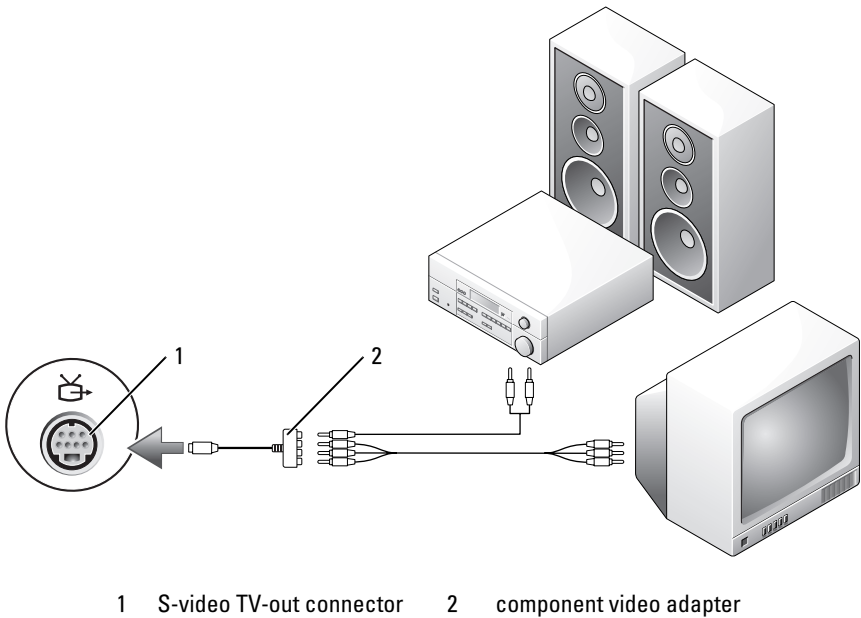

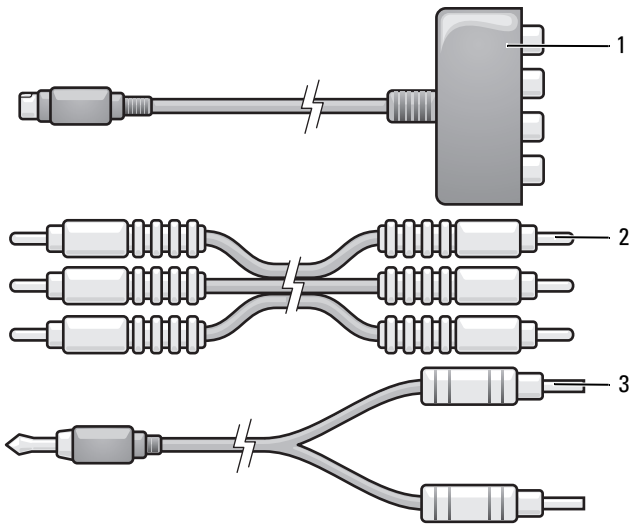

- 1 component video adapter 2 component video cable
3 standard audio cable

- 1 Turn off the computer and the TV and/or audio device that you want to connect.
- 2 Connect the component video adapter to the S-video TV-out connector on the computer.
- 3 Plug all three ends of the component video cable into the component video-output connectors on the component video adapter. Make sure that the red, green, and blue colors of the cable match the corresponding adapter ports.

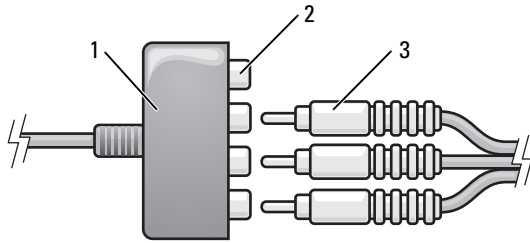

- 1 component video adapter 2 component video-output connectors
3 component video cable

- 4 Plug all three connectors from the other end of the component video cable into the component video-input connectors on the TV. Make sure that the red, green, and blue colors of the cable match the colors of the TV input connectors.
- 5 Plug one end of the S/PDIF digital audio cable into the S/PDIF audio connector on the component video adapter.

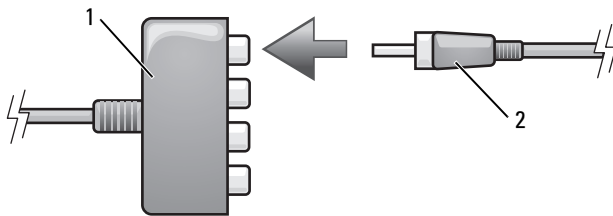

- 1 component video adapter 2 S/PDIF digital audio cable

- 6 Plug the other end of the digital audio cable into the S/PDIF input connector on your TV or other audio device.
- 7 Turn on the TV, turn on any audio device that you connected (if applicable), and then turn on the computer.
- 8 See "Enabling the Display Settings for a TV" on page 63 to ensure that the computer recognizes and works properly with the TV.

Enabling S/PDIF Digital Audio

If your computer has a DVD drive, you can enable digital audio for DVD playback.

- 1 Launch the **Cyberlink PowerDVD** application.
- 2 Insert a DVD into the DVD drive.
If the DVD begins playing, click the stop button.
- 3 Click the **Settings** option.
- 4 Click the **DVD** option.
- 5 Click the **DVD Audio Setting** icon.
- 6 Click the arrows beside the **Speaker Configuration** setting to scroll through the options, and select the **SPDIF** option.
- 7 Click the **Back** button once, and then click the **Back** button again to return to the main menu screen.

Enabling S/PDIF in the Windows Audio Driver

- 1 Double-click the speaker icon in the Windows notification area.
- 2 Click the **Options** menu and then click **Advanced Controls**.
- 3 Click **Advanced**.
- 4 Click **S/PDIF Interface**.
- 5 Click **Close**.
- 6 Click **OK**.

Setting Up the Cyberlink (CL) Headphones



NOTE: The CL headphone feature is available only if your computer has a DVD drive.

If your computer has a DVD drive, you can enable digital audio for DVD playback.

- 1 Launch the **Cyberlink PowerDVD** program.
- 2 Insert a DVD into the DVD drive.
If the DVD begins playing, click the stop button.
- 3 Click the **Settings** option.

- 4 Click the **DVD** option.
- 5 Click the **DVD Audio Setting** icon.
- 6 Click the arrows beside the **Speaker Configuration** setting to scroll through the options, and select the **Headphones** option.
- 7 Click the arrows beside the **Audio listening mode** setting to scroll through the options, and select the **CL Headphone** option.
- 8 Click the arrows beside the **Dynamic range compression** option to select the most suitable option.
- 9 Click the **Back** button once, and then click the **Back** button again to return to the main menu screen.

Enabling the Display Settings for a TV



NOTE: To ensure that the display options appear correctly, connect the TV to the computer before you enable the display settings.

Microsoft Windows XP

- 1 Click the **Start** button, point to **Settings**, and then click **Control Panel**.
- 2 Double-click **Display** and click the **Settings** tab.
- 3 Click **Advanced**.
- 4 Click the tab for your video card.



NOTE: To determine the type of video card installed in your computer, see the Windows Help and Support Center. To access the Help and Support Center, click **Start**→**Help and Support**. Under **Pick a Task**, click **Use Tools to view your computer information and diagnose problems**. Then, under **My Computer Information**, select **Hardware**.

- 5 In the display devices section, select the appropriate option for using either a single display or multiple displays, ensuring that the display settings are correct for your selection.

Windows Vista

- 1 Click the Windows Vista Start button , click **Control Panel**, and then click **Appearance and Personalization**.
- 2 Under **Personalization**, click **Adjust Screen Resolution**.
The **Display Properties** window appears.
- 3 Click **Advanced**.

- 4 Click the tab for your video card.



NOTE: To determine the type of video card installed in your computer, see the Windows Help and Support Center. To access the Help and Support Center in Windows Vista, click the Windows Vista Start button  → **Help and Support**. Under **Pick a Task**, click **Use Tools** to view your computer information and diagnose problems. Then, under **My Computer Information**, select **Hardware**.

- 5 In the display devices section, select the appropriate option for using either a single display or multiple displays, ensuring that the display settings are correct for your selection.

Using a Media Card Reader (Optional)



CAUTION: Before you perform any of the procedures in this section, follow the safety instructions in the *Product Information Guide*.

Use the media card reader to transfer data directly to your computer. The media card reader can also be used to pair Bluetooth® devices with the computer.

The media card reader supports the following memory types:

- xD-Picture card
- SmartMedia card (SMC)
- CompactFlash card Type I and II (CF I/II)
- MicroDrive card
- SecureDigital card (SD)
- MiniSD card
- MultiMediaCard (MMC)
- Reduced-size MultiMediaCard (RS-MMC)
- Memory Stick (MS/MS Pro/MS Duo/MS Pro Duo)

For information on installing a media card reader, see "Installing a Media Card Reader" in the *Service Manual* on the Dell Support website at support.dell.com.

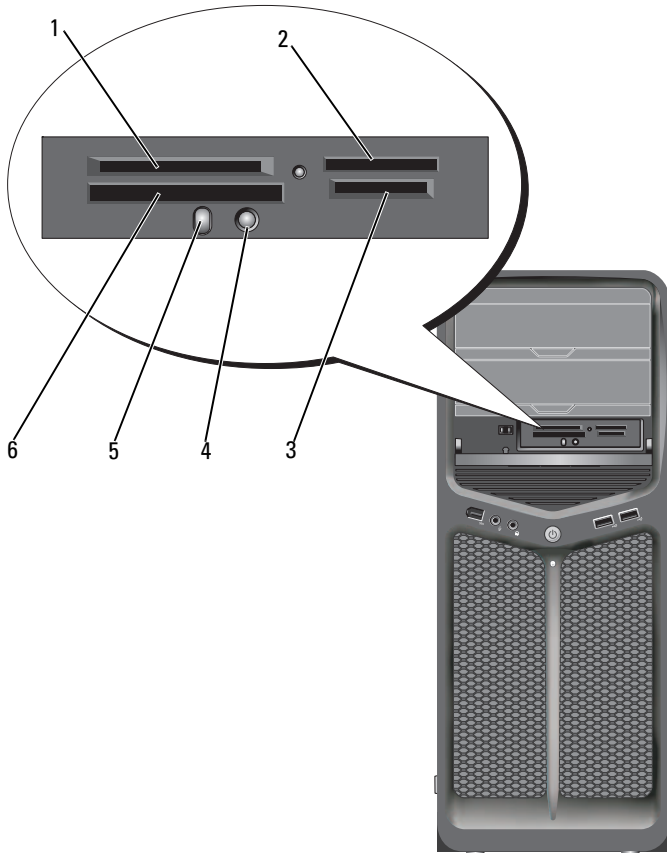

- | | | |
|--|--|--|
| <p>1 xD-Picture card and SmartMedia Card (SMC)</p> <p>4 Bluetooth pairing button</p> | <p>2 Memory Stick (MS/MS Pro/MS Duo/MS Pro Duo)</p> <p>5 Bluetooth LED</p> | <p>3 Secure Digital card (SD/miniSD)/MultiMedia-Card (MMC/RS-MMC)</p> <p>6 CompactFlash card Type I and II (CF I/II) and MicroDrive card</p> |
|--|--|--|

- 1 Inspect the media card to determine the proper orientation for insertion.
- 2 Slide the media card into the appropriate slot of the media card reader until it is completely seated in the connector.
- 3 If you encounter resistance, remove the card, check for proper orientation, and then try again.

Instructions for Setting Up a Device With Bluetooth Wireless Technology

- 1 Turn on the device.
- 2 Press the connect button on the device.
The Bluetooth LED on the device blinks, indicating that the device is active and can be detected by the computer.
- 3 Press the connect button on the front of the media card reader.
- 4 The Bluetooth LED on the device stops blinking and stays on for a few moments indicating that the connection between the device and the computer has been established. The LED then turns off.

About RAID Configurations

 **NOTICE:** In order to use the migrating option to convert a RAID configuration without losing data, your hard drive must initially be set up as a single drive RAID 0 array before the operating system is loaded onto the drive (see "Using the Nvidia MediaShield ROM Utility" on page 70 for instructions).

This section provides an overview of the RAID configuration you may have selected when you purchased your computer. There are several RAID configurations available in the computer industry for different types of uses. Your computer supports RAID level 0 and RAID level 1. A RAID level 0 configuration is recommended for high-performance programs, while RAID level 1 is recommended for users that desire a high level of data integrity.

 **NOTE:** RAID levels do not represent a hierarchy. A RAID level 1 configuration is not inherently better or worse than a RAID level 0 configuration.

The drives in a RAID configuration should be the same size in order to ensure that the larger drive does not contain unallocated (and therefore unusable) space. RAID level 0 and RAID level 1 require a minimum of two drives.

RAID Level 0 Configuration

 **NOTICE:** Because a RAID level 0 configuration provides no data redundancy, a failure of one drive results in the loss of all data. To protect your data when using a RAID level 0 configuration, perform regular backups.

RAID level 0 uses a storage technique known as data striping to provide a high data access rate. Data striping is a method of writing consecutive segments, or stripes, of data sequentially across the physical drive(s) to create a large virtual drive. Data striping allows one of the drives to read data while the other drive is searching for and reading the next block.

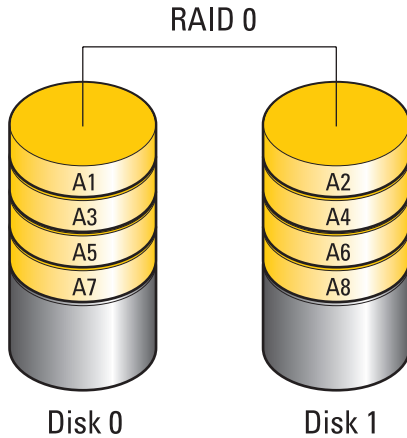

Another advantage of a RAID level 0 configuration is that it utilizes the full storage capacities of the drives. For example, two 120-GB hard drives combine to provide 240 GB of hard drive space on which to store data.

 **NOTE:** In a RAID level 0 configuration, the size of the configuration is equal to the size of the smallest drive multiplied by the number of drives in the configuration.

RAID Level 1 Configuration

RAID level 1 uses a data-redundancy storage technique known as mirroring to enhance data integrity. When data is written to the primary drive, the data is also duplicated, or mirrored, on the second drive in the configuration. A RAID level 1 configuration sacrifices high data-access rates for its data redundancy advantages.

If a drive failure occurs, subsequent read and write operations are directed to the surviving drive. A replacement drive can then be rebuilt using the data from the surviving drive.

 **NOTE:** In a RAID level 1 configuration, the size of the configuration is equal to the size of the smallest drive in the configuration.

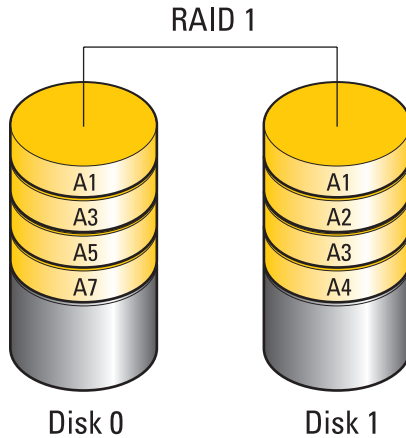

Configuring Your Hard Drives for RAID

Your computer can be configured for RAID, even if you did not select a RAID configuration when the computer was purchased. For an explanation of RAID levels and their requirements, see "About RAID Configurations" on page 67. For information on how to install a hard drive, see "Installing a Hard Drive" in the *Service Manual* on the Dell Support website at support.dell.com.

You can use one of two methods to configure RAID hard drive volumes. The first method uses the Nvidia MediaShield ROM utility and is performed *before* you install the operating system onto the hard drive. The second method uses Nvidia MediaShield and is performed *after* you have installed the operating system and Nvidia RAID drivers.

Both methods require that you set your computer to RAID-enabled mode before you begin.

Setting Your Computer to RAID-Enabled Mode

- 1 Enter system setup (see "Entering System Setup" on page 77).
- 2 Press the up- and down-arrow keys to highlight Drives, then press <Enter>.

- 3 Press the up- and down-arrow keys to highlight the applicable SATA drive, then press <Enter>.
- 4 Press the left- and right-arrow keys to highlight **RAID On**, and then press <Enter>. Repeat the process, as needed, for each SATA hard drive.
 **NOTE:** For more information about RAID options, see "System Setup Options" on page 79.
- 5 Press <Esc>, press the left- and right-arrow keys to highlight **Save/Exit**, and then press <Enter> to exit system setup and resume the boot process.

Using the Nvidia MediaShield ROM Utility

 **NOTICE:** The following procedure will result in the loss of all data on your hard drive(s). Back up any data you want to keep before continuing.

 **NOTE:** Do not use the following procedure to migrate an existing RAID configuration (see "Converting From One RAID Configuration to Another RAID Configuration" on page 73).

Hard drives of any size may be used to create a RAID configuration. Ideally, however, the drives should be of equal size to avoid unallocated or unused space. For an explanation of RAID levels and their requirements, see "About RAID Configurations" on page 67. For information on how to install a hard drive, see "Installing a Hard Drive" in the *Service Manual* on the Dell Support website at support.dell.com.

- 1 Enable RAID for each applicable hard drive on your computer (see "Setting Your Computer to RAID-Enabled Mode" on page 69).
- 2 Restart the computer.
- 3 Press <Ctrl><N> when prompted to enter the RAID BIOS.

 **NOTE:** If the operating system logo appears, continue to wait until you see the Microsoft Windows desktop, then shut down your computer and try again.

The **Define a New Array** window appears.

- 4 Press <Tab> to navigate to the **RAID Mode** field.
To create a RAID 0 configuration, use the arrow keys to select **Striping**.
To create a RAID 1 configuration, use the arrow keys to select **Mirroring**.
- 5 Press <Tab> to navigate to the **Free Disks** field.

- 6 Use the up- and down-arrow keys to select a hard drive to include in the RAID array and then use the right-arrow key to move the selected drive from the **Free Disks** field to the **Array Disks** field. Repeat for each disk you want to include in the RAID array.

 **NOTE:** Your computer supports a maximum of two drives per RAID 1 array and four drives per RAID 0 array.

- 7 After assigning the hard drives to an array, press <F9>.

The **Clear disk data** prompt appears.

 **NOTICE:** You will lose all data on the selected drives in the next step.

- 8 Press <Y> to clear all data from the selected drives.

The **Array List** window appears.

- 9 To review the details of the array that you set up, use the arrow keys to highlight the array in the **Array Detail** window and press <Enter>.

The **Array Detail** window appears.

 **NOTE:** To delete an array, use the arrow keys to select the array and press <D>.

- 10 Press <Enter> to return to the previous screen.

- 11 Press <Ctrl><X> to exit the RAID BIOS.

Using Nvidia MediaShield

Nvidia MediaShield allows you to create, view, and manage RAID configurations.

 **NOTE:** Use Nvidia MediaShield to create a RAID configuration only when you are adding one or more new hard drives to an existing (non-RAID) single-drive computer, and you want to configure the new drive(s) into a RAID array.

Hard drives of any size may be used to create a RAID configuration using Nvidia MediaShield. Ideally, however, the drives should be of equal size to avoid unallocated or unused space. For an explanation of RAID levels and their requirements, see "About RAID Configurations" on page 67.

Creating a RAID Array

 **NOTICE:** The following procedure will result in the loss of all data on your hard drive(s). Back up any data you want to keep before continuing.

 **NOTE:** Do not use the following procedure to migrate an existing RAID configuration (see "Converting From One RAID Configuration to Another RAID Configuration" on page 73).

1 Enable RAID on your hard drives (see "Setting Your Computer to RAID-Enabled Mode" on page 69).

2 After rebooting your computer, launch Nvidia MediaShield.

3 Click **Create** under **System Tasks**.

The **NVIDIA Create Array Wizard** appears and lists the disks that are available for configuration.

4 Click **Next**.

5 Click **Custom**, then click **Next**.

6 Use the drop-down box to select **Striping** (RAID 0) or **Mirroring** (RAID 1).

7 Click **Next**.

The **Free Disk Selection** window appears.

 **NOTE:** Only RAID-enabled hard drives are listed as free disks.

8 Click to select the drives that will make up the RAID configuration, click **Next**, and then click **Next** again.

 **NOTE:** Your computer supports a maximum of two drives per RAID 1 array and four per RAID 0 array.

The **Clearing System Data** window appears.

 **NOTICE:** The **Clear System Data** option deletes all data on the selected drive.

9 Click **Next**.

10 Click **Finish** to create the RAID configuration.

The MediaShield RAID management utility window appears and lists the array along with any other installed hard drives.

Deleting a RAID Array

 **NOTE:** While this procedure deletes the RAID 1 volume, it also splits the RAID 1 volume into two non-RAID hard drives with a partition, and leaves any existing data files intact. Deleting a RAID 0 volume, however, destroys all data on the volume.

 **NOTE:** If your computer currently boots to RAID and you delete the RAID volume, your computer will become unbootable.

1 Launch Nvidia MediaShield.

2 Click to select the array you want to delete.

- 3 Click **Delete Array** in the **System Tasks** pane.

The **NVIDIA Delete Array Wizard** appears.

- 4 Click **Next**.

A confirmation screen appears with the name and size of the array that you have marked for deletion.

- 5 Click **Finish** to delete the RAID configuration.

The MediaShield RAID management utility window appears and lists any remaining arrays along with any other installed hard drives.

Converting From One RAID Configuration to Another RAID Configuration



NOTICE: In order to use the migrating option to convert a RAID configuration without losing data, your hard drive must initially be set up as a single drive RAID 0 array before the operating system is loaded onto the drive (see "Using the Nvidia MediaShield ROM Utility" on page 70 for instructions).

Nvidia MediaShield utilizes a one-step process known as migrating to change the current state of a disk or array without losing any data. If needed, additional hard drives can be added to an existing array, including a single-drive RAID 0 configuration for conversion to a two-drive RAID 0 configuration; however, the capacity of the resulting array must be equal to or greater than the size of the original configuration.

RAID 0 to RAID 1 conversions cannot be performed using the migrating process.



NOTICE: Additional hard drives to be used in the (migrated) array must be no smaller than any of the drives in the current configuration.



NOTE: Ensure that all drives to be used in the RAID configuration are RAID-enabled (see "Setting Your Computer to RAID-Enabled Mode" on page 69).

- 1 Launch Nvidia MediaShield.
- 2 Click to select the array you want to convert.
- 3 Click **Convert Array** in the **System Tasks** pane.
The **NVIDIA Convert Array Wizard** appears.
- 4 Click **Next**.

- 5 Under **RAID Mode Selection**, select **Mirroring** or **Striping** from the drop-down menu.
- 6 Click **Next**.
-  **NOTICE:** You will lose all data on the selected drives in the next step.
- 7 Under **Free Disk Selection**, select the hard drive(s) you want to include in the (migrated) array by clicking the checkbox beside it.
- 8 Click **Finish**.

The MediaShield RAID management utility window appears and displays the status of the upgrade/migration process along with any other installed hard drives.

 **NOTE:** The time it takes to convert an array depends on several factors, such as the speed of the CPU, the type and size of the hard drive being used, the operating system, etc.

Rebuilding a RAID Configuration

If one of the hard drives in a RAID array fails, you can rebuild the array by restoring the data to a replacement drive.

-  **NOTE:** Rebuilding an array can only be performed on RAID 1 configuration.
- 1 Launch Nvidia MediaShield.
 - 2 Click to select your RAID configuration (**Mirroring**) in the management utility window.
 - 3 Select **Rebuild Array** in the **System Tasks** pane.
The **NVIDIA Rebuild Array Wizard** appears.
 - 4 Click **Next**.
 - 5 Select the hard drive you want to rebuild by clicking the checkbox beside it.
 - 6 Click **Next**.
 - 7 Click **Finish**.

The MediaShield RAID management utility window appears and displays the status of the rebuild process.

 **NOTE:** You can use your computer while the computer is rebuilding the array.

 **NOTE:** You can use any available (RAID-enabled) free disk to rebuild an array.

Cleaning Your Computer

 **CAUTION:** Before you begin any of the procedures in this section, follow the safety instructions in the *Product Information Guide*.

Computer, Keyboard, and Monitor

 **CAUTION:** Before you clean your computer, disconnect the computer from the electrical outlet. Clean your computer with a soft cloth dampened with water. Do not use liquid or aerosol cleaners, which may contain flammable substances.

- Use a vacuum cleaner with a brush attachment or a can of compressed air to remove dust from the slots and holes on your computer and from between the keys on the keyboard.

 **NOTICE:** Do not wipe the display screen with a soap or alcohol solution. Doing so may damage the antiglare coating.

- To clean your monitor screen, lightly dampen a soft, clean cloth with water. If possible, use a screen-cleaning tissue or solution suitable for the monitor's antistatic coating.

 **NOTICE:** Do not soak the cloth or let water drip inside your computer or keyboard.

- Wipe the keyboard, computer, and plastic part of the monitor with a soft cleaning cloth moistened with water.

Mouse (Non-Optical)

- 1 Turn the retainer ring on the underside of your mouse counterclockwise, and then remove the ball.
- 2 Wipe the ball with a clean, lint-free cloth.
- 3 Blow carefully into the ball cage to dislodge dust and lint.
- 4 Clean the rollers inside the ball cage with a cotton swab moistened lightly with isopropyl alcohol.

- 5 Recenter the rollers in their channels, as needed. Ensure that fluff from the swab is not left on the rollers.
- 6 Replace the ball and retainer ring, and then turn the retainer ring clockwise until it clicks into place.

Floppy Drive

- ➔ **NOTICE:** Do not attempt to clean drive heads with a swab. You might accidentally misalign the heads which prevents the drive from operating.

Clean your floppy drive using a commercially available cleaning kit. These kits contain pretreated floppy disks to remove contaminants that accumulate during normal operation.

CDs and DVDs

- ➔ **NOTICE:** Always use compressed air to clean the lens in the CD/DVD drive, and follow the instructions that come with the compressed-air product. Never touch the lens in the drive.

If you notice problems, such as skipping, with the playback quality of your CDs or DVDs, try cleaning the discs.

- 1 Hold the disc by its outer edge. You can also touch the inside edge of the center hole.

- ➔ **NOTICE:** To avoid damaging the surface, do not wipe in a circular motion around the disc.

- 2 With a soft, lint-free cloth, gently wipe the bottom of the disc (the unlabeled side) in a straight line from the center to the outer edge of the disc.

For stubborn dirt, try using water or a diluted solution of water and mild soap. You can also purchase commercial products that clean discs and provide some protection from dust, fingerprints, and scratches. Cleaning products for CDs are also safe to use on DVDs.

System Setup

Overview

Use System Setup:

- To change the system configuration information after you add, change, or remove any hardware in your computer.
- To set or change a user-selectable option such as the user password.
- To read the current amount of memory or set the type of hard drive installed.

Before you use System Setup, it is recommended that you write down the system setup screen information for future reference.



NOTICE: Do not change the settings in system setup unless you are an expert computer user. Certain changes can cause your computer to work incorrectly.

Entering System Setup

- 1 Turn on (or restart) your computer.
- 2 When the DELL logo appears, press <F2> immediately.



NOTE: Keyboard failure may result when a key on the keyboard is held down for extended periods of time. To avoid possible keyboard failure, press and release <F2> in even intervals until the system setup screen appears.

If you wait too long and the operating system logo appears, continue to wait until you see the Microsoft® Windows® desktop, then shut down your computer and try again.

System Setup Screens

The System Setup screen displays current or changeable configuration information for your computer. Information on the screen is divided into five areas: the menu field, the options list, the active options field, the help field, and key functions.

<p>Menu — Appears on top of the System Setup window. This field provides a menu to access to the System Setup options. Press <<> and < >> keys to navigate. As a Menu option is highlighted, the Options List, lists the options that define the hardware installed on you computer.</p>		
<p>Options List — Appears on the left side of the System Setup window. The field lists features that define the configuration of your computer, including installed hardware, power conservation, and security features.</p> <p>Scroll up and down the list with the up- and down-arrow keys. As an option is highlighted, the Options Field displays the option's current and available settings.</p>	<p>Options Field — Appears on the right side of Options List and contains information about each option listed in the Options List. In this field you can view information about your computer and make changes to your current settings.</p> <p>Press <Enter> to make changes to your current settings. Press <ESC> to return to the Options List.</p> <p>NOTE: Not all settings listed in the Options Field are changeable.</p>	<p>Help — Appears on the right side of the System Setup window and contains help information about the option selected in Options List.</p>
<p>Key Functions — Appears below the Options Field and lists keys and their functions within the active system setup field.</p>		

System Setup Options



NOTE: Depending on your computer and installed devices, the items listed in this section may not appear, or may not appear exactly as listed.

Main	
System Info	Displays the system model name.
BIOS Info	Display the BIOS revision.
Service Tag	Displays the system service tag.
Express Service Code	Displays the express service code.
Asset Tag	Displays the asset tag.
Date	Displays the system date.
Time	Displays the system time.
Memory Installed	Displays the total memory size.
Memory Available	Displays the memory available in the system.
Memory Speed	Displays the memory speed.
Memory Channel Mode	Displays the memory channel modes. <ul style="list-style-type: none">• Single• Dual
Memory Technology	Displays the type of memory used in the system.
Processor Type	Displays the type of processor.
Processor Speed	Displays the speed of the processor.
Processor L2 cache	Displays the processor L2 cache size.

Advanced

CPU Feature	Allows you to enable or disable the CPU features that enhance the performance of the system.
Integrated Peripherals	Allows you to enable or disable the integrated devices and ports on your system.
IDE/SATA Configuration	Enables or disables a user to define or change any values related to IDE or SATA devices such as hard drives, optical drives, and so on connected to the computer.
Overclock Configuration	This option enables you to set the system clock mode.
Overvoltage configuration	This option enables you to configure the voltage of the CPU core, FSB, memory voltage, and chipset voltage.

Security

Supervisor Password Is	Specifies whether a supervisor password has been assigned.
User Password Is	Specifies whether a user password has been assigned.
Set Supervisor Password	Allows you to set a supervisor password.
Set User Password	Allows you to set a user password. You cannot use the user password to enter the BIOS setup, during POST.

Power	
ACPI Suspend Type	Specifies the ACPI suspend type. The default is S3.
AC Recovery	Specifies the behaviour of the system after recovering from a power loss. <ul style="list-style-type: none"> • On — The computer turns on after it recovers from a power failure. • Off — The computer remains powered off. • Last — The computer returns the power state it was in before the power failure.
Remote Wake Up	This option turns on the computer when a user tries to access the computer through the LAN.
Wake-Up By Ring	This option turns on the computer when an incoming call is detected on the modem.
Auto Power On	Enables you to set an alarm to turn on the computer automatically.
Boot	
Removable Device Priority	Sets the boot priority among the attached removable devices.
Hard Disk Boot Priority	Sets the hard drive boot priority. The items displayed are dynamically updated according to the hard drives detected.
1st Boot Device through 3rd Boot Device	Sets the boot device sequence. Only the bootable devices that are connected to the computer are listed as options.
Boot Other Device	This option enables you to boot from other devices such as a memory key.
Exit	
Exit Options	Provides options to Exit Saving Changes , Exit Discarding Changes , Load Setup Default , and Discard Changes .

Boot Sequence

This feature allows you to change the boot sequence for the bootable devices installed on your computer.

Option Settings

- **Diskette Drive** — The computer attempts to boot from the floppy drive. If the floppy disk in the drive is not bootable, if no floppy disk is in the drive, or if there is no floppy drive installed in the computer, the computer attempts to boot from the next bootable device in the boot sequence.
- **Hard Drive** — The computer attempts to boot from the primary hard drive. If no operating system is on the drive, the computer attempts to boot from the next bootable device in the boot sequence.
- **CD Drive** — The computer attempts to boot from the CD drive. If no CD is in the drive, or if the CD has no operating system, the computer attempts to boot from the next bootable device in the boot sequence.
- **USB Flash Device** — Insert the memory device into a USB port and restart the computer. When **F12 = Boot Menu** appears in the upper-right corner of the screen, press <F12>. The BIOS detects the device and adds the USB flash option to the boot menu.



NOTE: To boot to a USB device, the device must be bootable. To ensure that your device is bootable, check the device documentation.



NOTE: An error message is generated only after the computer attempts to boot from every device in the boot sequence and no operating system is found.

Changing Boot Sequence for the Current Boot

You can use this feature, for example, to tell the computer to boot from the CD drive so that you can run the Dell Diagnostics on the *Driver and Utilities* media, but you want the computer to boot from the hard drive when the diagnostic tests are complete. You can also use this feature to restart your computer to a USB device such as a floppy drive, memory key, or CD-RW drive.



NOTE: If you are booting to a USB floppy drive, you must first set the floppy drive to **OFF** in system setup (see "System Setup" on page 77).

- 1 If you are booting to a USB device, connect the USB device to a USB connector (see "Back View of the Computer" on page 19).
- 2 Turn on (or restart) your computer.

- 3 When the DELL logo appears, press <F12> immediately.

 **NOTE:** Keyboard failure may result when a key on the keyboard is held down for an extended period of time. To avoid possible keyboard failure, press and release <F12> in even intervals until the **Boot Device Menu** appears.

If you wait too long and the operating system logo appears, continue to wait until you see the Microsoft Windows desktop, then shut down your computer and try again.

- 4 At the **Boot Device Menu**, use the up- and down-arrow keys or press the appropriate number on the keyboard to highlight the device that is to be used for the current boot only, and then press <Enter>.

For example, if you are booting to a USB memory key, highlight **USB Flash Device** and press <Enter>.

 **NOTE:** To boot to a USB device, the device must be bootable. To ensure that your device is bootable, check the device documentation.

Changing Boot Sequence for Future Boots

- 1 Enter system setup (see "Entering System Setup" on page 77).
- 2 Use the arrow keys to highlight the **Boot Sequence** menu option and press <Enter> to access the menu.

 **NOTE:** Write down your current boot sequence in case you want to restore it.

- 3 Press the up- and down-arrow keys to move through the list of devices.
- 4 Press the spacebar to enable or disable a device.
- 5 Press plus (+) or minus (-) to move a selected device up or down the list.

Clearing Passwords and CMOS Settings



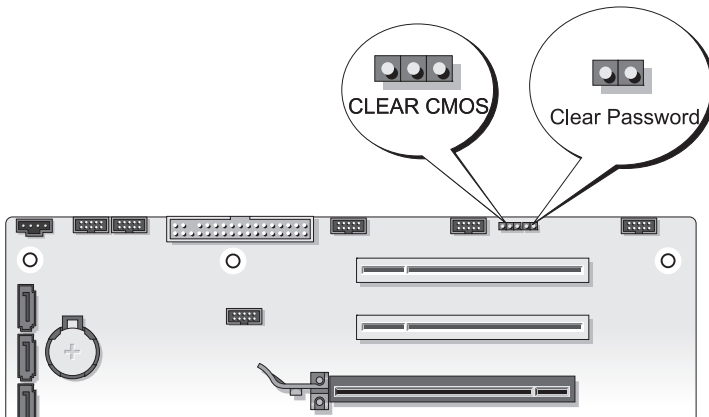

Clearing Passwords

⚠ CAUTION: Before you begin any of the procedures in this section, follow the safety instructions located in the *Product Information Guide*.

- 1 Follow the procedures in "Before You Begin" in the *Service Manual* on the Dell Support website at support.dell.com.
- 2 Remove the computer cover (see "Removing the Computer Cover" in the *Service Manual* on the Dell Support website at support.dell.com).
- 3 Locate the 2-pin password connector on the system board.



- 4 Remove the 2-pin jumper plug from the pins and set the jumper plug aside.

- 5 Replace the computer cover (see "Replacing the Computer Cover" in the *Service Manual* on the Dell Support website at support.dell.com).
- 6 Connect your keyboard and mouse, then connect your computer and monitor to electrical outlets and turn them on.
- 7 After the Microsoft® Windows® desktop appears on your computer, turn off the computer.
 -  **NOTE:** Ensure that the computer is off and not in a power management mode. If you cannot shut down the computer using the operating system, press and hold the power button for 4 seconds.
- 8 Disconnect the keyboard and mouse, then disconnect the computer and monitor from their electrical outlets.
- 9 Press the power button on the computer to ground the system board.
- 10 Remove the computer cover.
- 11 Replace the 2-pin jumper plug onto the pins of the password connector on the system board.
 -  **NOTE:** The password jumper plug must be reinstalled on the password jumper pins in order to enable the password feature.
- 12 Replace the computer cover.
-  **NOTICE:** To connect a network cable, first plug the cable into the network wall jack and then plug it into the computer.
- 13 Connect your computer and devices to electrical outlets, and then turn them on.
 -  **NOTE:** In System Setup (see "System Setup" on page 77), both system and administrator password options appear as **Not Set**. The password feature is enabled, but a password is not assigned.

Clearing CMOS Settings



CAUTION: Before you begin any of the procedures in this section, follow the safety instructions located in the *Product Information Guide*.

- 1 Follow the procedures in "Before You Begin" in the *Service Manual* on the Dell Support website at support.dell.com.



NOTE: The computer must be disconnected from the electrical outlet to clear the CMOS setting.

- 2 Remove the computer cover (see "Removing the Computer Cover" in the *Service Manual* on the Dell Support website at support.dell.com).
- 3 Locate the 3-pin CMOS jumper on the system board (see "System Board Components" in the *Service Manual* on the Dell Support website at support.dell.com).
- 4 Move the 3-pin jumper plug from pins 3 and 2 to pins 1 and 2.
- 5 Wait five seconds for the CMOS to clear.
- 6 Move the 2-pin jumper plug back to pins 3 and 2.
- 7 Replace the computer cover (see "Replacing the Computer Cover" in the *Service Manual* on the Dell Support website at support.dell.com).



NOTICE: To connect a network cable, first plug the cable into the network port or device and then plug it into the computer.

- 8 Connect your computer and devices to electrical outlets, and turn them on.

Flashing the BIOS

The BIOS may require flashing when an update is available or when replacing the system board.

- 1 Turn on the computer.
- 2 Locate the BIOS update file for your computer at the Dell Support website at support.dell.com.
- 3 Click **Download Now** to download the file.
- 4 If the **Export Compliance Disclaimer** window appears, click **Yes, I Accept this Agreement**.

The **File Download** window appears.

- 5 Click **Save this program to disk**, and then click **OK**.

The **Save In** window appears.

- 6 Click the down arrow to view the **Save In** menu, select **Desktop**, and then click **Save**.

The file downloads to your desktop.

- 7 Click **Close** when the **Download Complete** window appears.

The file icon appears on your desktop and is titled the same as the downloaded BIOS update file.

- 8 Double-click the file icon on the desktop and follow the on-screen instructions.

Troubleshooting Tools

Power Lights

 **CAUTION:** Before you begin any of the procedures in this section, follow the safety instructions in the *Product Information Guide*.

The power button light located on the front of the computer indicates different states of the computer:

- If the power light is white and the computer is not responding, see "Beep Codes" on page 90.
- If the power light is blinking white, the computer is in standby mode. Press a key on the keyboard, move the mouse, or press the power button to resume normal operation.
- If the power light is off, the computer is either turned off or is not receiving power.
 - Reseat the power cable into both the power connector on the back of the computer and the electrical outlet.
 - If the computer is plugged into a power strip, ensure that the power strip is plugged into an electrical outlet and that the power strip is turned on.
 - Bypass power protection devices, power strips, and power extension cables to verify that the computer turns on properly.
 - Ensure that the electrical outlet is working by testing it with another device, such as a lamp.
 - Ensure that the main power cable and front panel cable are securely connected to the system board (see "System Board Components" in the *Service Manual* on the Dell Support website at support.dell.com).
- Eliminate interference. Some possible causes of interference are:
 - Power, keyboard, and mouse extension cables
 - Too many devices on a power strip
 - Multiple power strips connected to the same electrical outlet

The power supply diagnostic LED located on the back of the computer indicates different states of the power supply. To test the power supply, press the power supply test switch.

- If the power supply diagnostic LED is green, power is available for the power supply.
- If the power supply diagnostic LED is off:
 - The power supply is not receiving power — Ensure that the main power cable is connected to the system.
 - The power supply is not working — This issue occurs either due to a bad power supply or a device attached to the power supply.

To resolve the issue, contact Dell (See "Contacting Dell" on page 141).

Beep Codes

Your computer may emit a series of beeps during start up. The series of beeps is called a beep code and can be used to help identify a problem with your computer.

If your computer emits a series of beeps during start-up:

- 1 Write down the beep code.
- 2 Run the Dell Diagnostics to identify the cause (see "Dell Diagnostics" on page 95).

Code (repetitive short beeps)	Description	Suggested Remedy
1	BIOS checksum failure. Possible motherboard failure.	Contact Dell (see "Contacting Dell" on page 141).
2	No memory modules are detected.	<ul style="list-style-type: none"> • If two or more memory modules are installed, remove the modules (see "Removing Memory" in the <i>Service Manual</i> on the Dell Support website at support.dell.com), then reinstall one module (see "Installing Memory" in the <i>Service Manual</i> on the Dell Support website at support.dell.com) and restart the computer. If the computer starts normally, continue to install additional memory modules (one at a time) until you have identified a faulty module or reinstalled all modules without error. • If available, install working memory of the same type into your computer (see "Memory" in the <i>Service Manual</i> on the Dell Support website at support.dell.com). • If the problem persists, contact Dell (see "Contacting Dell" on page 141).

Code (repetitive short beeps)	Description	Suggested Remedy
3	Chipset error.	Contact Dell (see "Contacting Dell" on page 141).
	Time-of-day clock test failure.	<ul style="list-style-type: none"> • Replace the battery (see "Replacing the Battery" in the <i>Service Manual</i> on the Dell Support website at support.dell.com). • If the problem persists, contact Dell (see "Contacting Dell" on page 141).
	Gate A20 failure. Possible motherboard failure.	Contact Dell (see "Contacting Dell" on page 141).
	Super I/O chip failure. Possible motherboard failure.	Contact Dell (see "Contacting Dell" on page 141).
	Keyboard controller test failure. Possible keyboard failure.	<ul style="list-style-type: none"> • Ensure that the cables are connected properly. • If the problem persists, contact Dell (see "Contacting Dell" on page 141).
4	RAM Read/Write failure.	<ul style="list-style-type: none"> • Ensure that no special requirements for memory module/connector placement exist (see "Memory" in the <i>Service Manual</i> on the Dell Support website at support.dell.com). • Ensure that the memory you are using is supported by your computer (see "Memory" in the <i>Service Manual</i> on the Dell Support website at support.dell.com). • If the problem persists, contact Dell (see "Contacting Dell" on page 141).

Code (repetitive short beeps)	Description	Suggested Remedy
5	RTC power failure. Possible CMOS battery failure.	<ul style="list-style-type: none"> • Replace the battery (see "Replacing the Battery" in the <i>Service Manual</i> on the Dell Support website at support.dell.com). • If the problem persists, contact Dell (see "Contacting Dell" on page 141).
6	Video BIOS test failure.	Contact Dell (see "Contacting Dell" on page 141).
7	CPU cache test failure.	Contact Dell (see "Contacting Dell" on page 141).

System Messages



NOTE: If the message you received is not listed in the table, see the documentation for either the operating system or the program that was running when the message appeared.

ALERT! PREVIOUS ATTEMPTS AT BOOTING THIS SYSTEM HAVE FAILED AT CHECKPOINT [NNNN]. FOR HELP IN RESOLVING THIS PROBLEM, PLEASE NOTE THIS CHECKPOINT AND CONTACT DELL TECHNICAL SUPPORT — The computer failed to complete the boot routine three consecutive times for the same error (see "Contacting Dell" on page 141 for assistance).

CMOS CHECKSUM ERROR — Possible motherboard failure or RTC battery low. Replace the battery (see "Replacing the Battery" in the *Service Manual* on the Dell Support website at support.dell.com or see "Contacting Dell" on page 141 for assistance).

CPU FAN FAILURE — CPU fan failure. Replace the CPU fan (see "Removing the Processor Heatsink" in the *Service Manual* on the Dell Support website at support.dell.com).

DISKETTE DRIVE0 SEEK FAILURE — A cable may be loose, or the computer configuration information may not match the hardware configuration. Check cable connections (see "Contacting Dell" on page 141 for assistance).

DISKETTE SUBSYSTEM RESET FAILURE — Possible floppy disk controller failure.

DISKETTE READ FAILURE — The floppy disk may be defective or a cable may be loose. Replace the floppy disk/check for a loose cable connection.

HARD-DISK READ FAILURE — Possible hard-disk failure during hard-disk boot test (see "Contacting Dell" on page 141 for assistance).

HARD-DISK DRIVE FAILURE — Possible hard-disk failure during Power-on Self test (POST). Replace the hard-disk (see "Contacting Dell" on page 141 for assistance).

KEYBOARD FAILURE — Keyboard failure or keyboard cable loose (see "Keyboard Problems" on page 105).

NO BOOT DEVICE AVAILABLE — The system cannot detect a bootable device or partition.

- If the floppy drive is your boot device, ensure that the cables are connected and that a bootable floppy disk is in the drive.
- If the hard drive is your boot device, ensure that the cables are connected and that the drive is installed properly and partitioned as a boot device.
- Enter System Setup and ensure that the boot sequence information is correct (see "Entering System Setup" on page 77).

NO TIMER TICK INTERRUPT — A chip on the system board might be malfunctioning or motherboard failure (see "Contacting Dell" on page 141 for assistance).

NON-SYSTEM DISK OR DISK ERROR — Replace the floppy disk with one that has a bootable operating system or remove the floppy disk from drive A and restart the computer.

NOT A BOOT DISKETTE — Insert a bootable floppy disk and restart your computer.

USB OVER CURRENT ERROR — Replace the USB device.

NOTICE - HARD DRIVE SELF MONITORING SYSTEM HAS REPORTED THAT A PARAMETER HAS EXCEEDED ITS NORMAL OPERATING RANGE. DELL RECOMMENDS THAT YOU BACK UP YOUR DATA REGULARLY. A PARAMETER OUT OF RANGE MAY OR MAY NOT INDICATE A POTENTIAL HARD DRIVE PROBLEM. —

S.M.A.R.T. error indicating a possible HDD failure. This feature can be enabled or disabled in the BIOS setup.

Hardware Troubleshooter

If a device is either not detected during the operating system setup or is detected, but incorrectly configured, you can use the Hardware Troubleshooter to resolve the incompatibility.

Windows XP:

- 1 Click Start→ Help and Support.
- 2 Type `hardware troubleshooter` in the search field and press <Enter> to start the search.
- 3 In the **Fix a Problem** section, click **Hardware Troubleshooter**.
- 4 In the **Hardware Troubleshooter** list, select the option that best describes the problem and click **Next** to follow the remaining troubleshooting steps.

Windows Vista:

- 1 Click the Windows Vista start button ™, and click **Help and Support**.
- 2 Type `hardware troubleshooter` in the search field and press <Enter> to start the search.
- 3 In the search results, select the option that best describes the problem and follow the remaining troubleshooting steps.

Dell Diagnostics



CAUTION: Before you begin any of the procedures in this section, follow the safety instructions in the *Product Information Guide*.

When to Use the Dell Diagnostics

If you experience a problem with your computer, perform the checks in Lockups and Software Problems (see "Lockups and Software Problems" on page 106) and run the Dell Diagnostics before you contact Dell for technical assistance.

It is recommended that you print these procedures before you begin.



NOTICE: The Dell Diagnostics works only on Dell™ computers.



NOTE: The *Drivers and Utilities* media is optional and may not ship with your computer.

See "System Setup" on page 77 to review your computer's configuration information, and ensure that the device that you want to test displays in the system setup program and is active.

Start the Dell Diagnostics from your hard drive or from the *Drivers and Utilities* media.

Starting the Dell Diagnostics From Your Hard Drive

The Dell Diagnostics is located on a hidden diagnostic utility partition on your hard drive.

Desktop Computers



NOTE: If your computer cannot display a screen image, see "Contacting Dell" on page 141.

- 1 Ensure that the computer is connected to an electrical outlet that is known to be working properly.
- 2 Turn on (or restart) your computer.
- 3 When the DELL™ logo appears, press <F12> immediately. Select Diagnostics from the boot menu and press <Enter>.



NOTE: If you wait too long and the operating system logo appears, continue to wait until you see the Microsoft® Windows® desktop; then, shut down your computer and try again.



NOTE: If you see a message stating that no diagnostics utility partition has been found, run the Dell Diagnostics from the *Drivers and Utilities* media.

- 4 Press any key to start the Dell Diagnostics from the diagnostics utility partition on your hard drive.

Starting the Dell Diagnostics From the Drivers and Utilities Media

1 Insert the *Drivers and Utilities* media.

2 Shut down and restart the computer.

When the DELL logo appears, press <F12> immediately.



NOTE: If you wait too long and the operating system logo appears, continue to wait until you see the Microsoft® Windows® desktop; then, shut down your computer and try again.



NOTE: The next steps change the boot sequence for one time only. On the next start-up, the computer boots according to the devices specified in the system setup program.

3 When the boot device list appears, highlight **CD/DVD/CD-RW** and press <Enter>.

4 Select the **Boot from CD-ROM** option from the menu that appears and press <Enter>.

5 Type **1** to start the CD menu and press <Enter> to proceed.

6 Select **Run the 32 Bit Dell Diagnostics** from the numbered list. If multiple versions are listed, select the version appropriate for your computer.

7 When the Dell Diagnostics **Main Menu** appears, select the test you want to run.

Dell Diagnostics Main Menu

- 1 After the Dell Diagnostics loads and the **Main Menu** screen appears, click the button for the option you want.



NOTE: It is recommended that you select **Test System** to run a complete test on your computer.

Option	Function
Test Memory	Run the stand-alone memory test
Test System	Run System Diagnostics
Exit	Exit the Diagnostics

- 2 After you have selected the **Test System** option from the main menu, the following menu appears:



NOTE: It is recommended that you select **Extended Test** from the menu below to run a more thorough check of devices in the computer.

Option	Function
Express Test	Performs a quick test of devices in the system. This typically can take 10 to 20 minutes.
Extended Test	Performs a thorough check of devices in the system. This typically can take an hour or more.
Custom Test	Use to test a specific device or customize the tests to be run.
Symptom Tree	This option allows you to select tests based on a symptom of the problem you are having. This option lists the most common symptoms.

- 3 If a problem is encountered during a test, a message appears with an error code and a description of the problem. Write down the error code and problem description and see "Contacting Dell" on page 141.



NOTE: The Service Tag for your computer is located at the top of each test screen. If you contact Dell, technical support will ask for your Service Tag.

- 4 If you run a test from the **Custom Test** or **Symptom Tree** option, click the applicable tab described in the following table for more information.

Tab	Function
Results	Displays the results of the test and any error conditions encountered.
Errors	Displays error conditions encountered, error codes, and the problem description.
Help	Describes the test and may indicate requirements for running the test.
Configuration	Displays your hardware configuration for the selected device. The Dell Diagnostics obtains configuration information for all devices from system setup, memory, and various internal tests, and it displays the information in the device list in the left pane of the screen. The device list may not display the names of all the components installed on your computer or all devices attached to your computer.
Parameters	Allows you to customize the test by changing the test settings.

- 5 When the tests are complete, close the test screen to return to the **Main Menu** screen. To exit the Dell Diagnostics and restart the computer, close the **Main Menu** screen.
- 6 Remove the Dell *Drivers and Utilities* media (if applicable).

Troubleshooting

Follow these tips when troubleshooting your computer:

- If you added or removed a part before the problem started, review the installation procedures and ensure that the part is correctly installed.
- If a peripheral device does not work, ensure that the device is properly connected.
- If an error message appears on the screen, write down the exact message. This message may help support personnel diagnose and fix the problem(s).
- If an error message occurs in a program, see the program's documentation.



NOTE: The procedures in this document were written for the Microsoft® Windows® default view, so they may not apply if you set your Dell™ computer to the Windows Classic view.

Battery Problems



CAUTION: There is a danger of a new battery exploding if it is incorrectly installed. Replace the battery only with the same or equivalent type recommended by the manufacturer. Discard used batteries according to the manufacturer's instructions.



CAUTION: Before you begin any of the procedures in this section, follow the safety instructions in the *Product Information Guide*.

REPLACE THE BATTERY — If you have to repeatedly reset time and date information after turning on the computer, or if an incorrect time or date displays during start-up, replace the battery (see "Replacing the Battery" in the *Service Manual* on the Dell Support website at support.dell.com). If the battery still does not work properly, contact Dell (see "Contacting Dell" on page 141).

Drive Problems

 **CAUTION:** Before you begin any of the procedures in this section, follow the safety instructions in the *Product Information Guide*.

ENSURE THAT MICROSOFT WINDOWS RECOGNIZES THE DRIVE —

Windows XP:

- Click **Start** and click **My Computer**.

Windows Vista®:

- Click the Windows Vista Start button  and click **Computer**.

If the drive is not listed, perform a full scan with your antivirus software to check for and remove viruses. Viruses can sometimes prevent Windows from recognizing the drive.

TEST THE DRIVE —

- Insert another disc to eliminate the possibility that the original drive is defective.
- Insert a bootable floppy disk and restart the computer.

CLEAN THE DRIVE OR DISK — See "Cleaning Your Computer" on page 75.

CHECK THE CABLE CONNECTIONS

RUN THE HARDWARE TROUBLESHOOTER — See "Troubleshooting Software and Hardware Problems in the Microsoft® Windows® XP and Windows Vista® Operating Systems" on page 121.

RUN THE DELL DIAGNOSTICS — See "Dell Diagnostics" on page 95.

Optical drive problems

 **NOTE:** High-speed optical drive vibration is normal and may cause noise, which does not indicate a defect in the drive or the media.

 **NOTE:** Because of different regions worldwide and different disc formats, not all DVD titles work in all DVD drives.

ADJUST THE WINDOWS VOLUME CONTROL —

- Click the speaker icon in the lower-right corner of your screen.
- Ensure that the volume is turned up by clicking the slidebar and dragging it up.
- Ensure that the sound is not muted by clicking any boxes that are checked.

CHECK THE SPEAKERS AND SUBWOOFER — See "Sound and Speaker Problems" on page 112.

Problems writing to an optical drive

CLOSE OTHER PROGRAMS — The optical drive must receive a steady stream of data during the writing process. If the stream is interrupted, an error occurs. Try closing all programs before you write to the optical.

TURN OFF STANDBY MODE IN WINDOWS BEFORE WRITING TO A DISC — See "Power Management" on page 38.

Hard drive problems

RUN CHECK DISK —

Windows XP:

- 1 Click Start and click My Computer.
- 2 Right-click Local Disk C:.
- 3 Click Properties→Tools→Check Now.
- 4 Click Scan for and attempt recovery of bad sectors and click Start.

Windows Vista:

- 1 Click Start  and click Computer.
- 2 Right-click Local Disk C:.
- 3 Click Properties→Tools→Check Now.

The User Account Control window may appear. If you are an administrator on the computer, click **Continue**; otherwise, contact your administrator to continue the desired action.

- 4 Follow the instructions on the screen.

Error Messages



CAUTION: Before you begin any of the procedures in this section, follow the safety instructions in the *Product Information Guide*.

If the error message is not listed, see the documentation for the operating system or the program that was running when the message appeared.

A FILENAME CANNOT CONTAIN ANY OF THE FOLLOWING CHARACTERS: \ / : * ? " < > | — Do not use these characters in filenames.

A REQUIRED .DLL FILE WAS NOT FOUND — The program that you are trying to open is missing an essential file. To remove and then reinstall the program:

Windows XP:

- 1 Click **Start** → **Control Panel** → **Add or Remove Programs** → **Programs and Features**.
- 2 Select the program you want to remove.
- 3 Click **Uninstall**.
- 4 See the program documentation for installation instructions.

Windows Vista:

- 1 Click **Start**  → **Control Panel** → **Programs** → **Programs and Features**.
- 2 Select the program you want to remove.
- 3 Click **Uninstall**.
- 4 See the program documentation for installation instructions.

drive letter : \ IS NOT ACCESSIBLE. THE DEVICE IS NOT READY — The drive cannot read the disk. Insert a disk into the drive and try again.

INSERT BOOTABLE MEDIA — Insert a bootable floppy disk, CD, or DVD.

NON-SYSTEM DISK ERROR — Remove the floppy disk from the floppy drive and restart your computer.

NOT ENOUGH MEMORY OR RESOURCES. CLOSE SOME PROGRAMS AND TRY AGAIN — Close all windows and open the program that you want to use. In some cases, you may have to restart your computer to restore computer resources. If so, run the program that you want to use first.

OPERATING SYSTEM NOT FOUND — Contact Dell (see "Contacting Dell" on page 141).

IEEE 1394 Device Problems



CAUTION: Before you begin any of the procedures in this section, follow the safety instructions in the *Product Information Guide*.



NOTE: Your computer supports only IEEE 1394a standard.

ENSURE THAT THE CABLE FOR THE IEEE 1394 DEVICE IS PROPERLY INSERTED INTO THE DEVICE AND INTO THE CONNECTOR ON THE COMPUTER

ENSURE THAT THE IEEE 1394 DEVICE IS ENABLED IN SYSTEM SETUP — See "System Setup Options" on page 79.

ENSURE THAT THE IEEE 1394 DEVICE IS RECOGNIZED BY WINDOWS —

Windows XP:

- 1 Click **Start** and click **Control Panel**.
- 2 Under **Pick a Category**, click **Performance and Maintenance** → **System** → **System Properties** → **Hardware** → **Device Manager**.

Windows Vista:

- 1 Click **Start**  → **Control Panel** → **Hardware and Sound**.
- 2 Click **Device Manager**.

If your IEEE 1394 device is listed, Windows recognizes the device.

IF YOU HAVE PROBLEMS WITH A DELL IEEE 1394 DEVICE — Contact Dell (see "Contacting Dell" on page 141).

IF YOU HAVE PROBLEMS WITH AN IEEE 1394 DEVICE NOT PROVIDED BY DELL — Contact the IEEE 1394 device manufacturer.

Keyboard Problems



CAUTION: Before you begin any of the procedures in this section, follow the safety instructions in the *Product Information Guide*.

CHECK THE KEYBOARD CABLE —

- Ensure that the keyboard cable is firmly connected to the computer.
- Shut down the computer (see "Preparing to Work Inside Your Computer" in the *Service Manual* on the Dell Support website at support.dell.com), reconnect the keyboard cable as shown on the setup diagram for your computer, and then restart the computer.
- Ensure that the cable is not damaged or frayed and check cable connectors for bent or broken pins. Straighten any bent pins.
- Remove any keyboard extension cables and connect the keyboard directly to the computer.

TEST THE KEYBOARD — Connect a properly working keyboard to the computer, then try using the keyboard.

RUN THE HARDWARE TROUBLESHOOTER — See "Troubleshooting Software and Hardware Problems in the Microsoft® Windows® XP and Windows Vista® Operating Systems" on page 121.

Lockups and Software Problems



CAUTION: Before you begin any of the procedures in this section, follow the safety instructions in the *Product Information Guide*.

The computer does not start up

ENSURE THAT THE POWER CABLE IS FIRMLY CONNECTED TO THE COMPUTER AND TO THE ELECTRICAL OUTLET

The computer stops responding



NOTICE: You may lose data if you are unable to perform an operating system shutdown.

TURN THE COMPUTER OFF — If you are unable to get a response by pressing a key on your keyboard or moving your mouse, press and hold the power button for at least 8 to 10 seconds (until the computer turns off), and then restart your computer.

A program stops responding

END THE PROGRAM —

- 1 Press <Ctrl><Shift><Esc> simultaneously to access the Task Manager.
- 2 Click the **Applications** tab.
- 3 Click to select the program that is no longer responding.
- 4 Click **End Task**.

A program crashes repeatedly



NOTE: Most software includes installation instructions in its documentation or on a floppy disk, CD, or DVD.

CHECK THE SOFTWARE DOCUMENTATION — If necessary, uninstall and then reinstall the program.

A program is designed for an earlier Windows operating system

RUN THE PROGRAM COMPATIBILITY WIZARD —

Windows XP:

The Program Compatibility Wizard configures a program so that it runs in an environment similar to non-XP operating system environments.

- 1 Click **Start**→ **All Programs**→ **Accessories**→ **Program Compatibility Wizard**→ **Next**.
- 2 Follow the instructions on the screen.

Windows Vista:

The Program Compatibility Wizard configures a program so that it runs in an environment similar to non-Windows Vista operating system environments.

- 1 Click **Start**  → **Control Panel** → **Programs** → **Use an older program with this version of Windows**.
- 2 In the welcome screen, click **Next**.
- 3 Follow the instructions on the screen.

A solid blue screen appears

TURN THE COMPUTER OFF — If you are unable to get a response by pressing a key on your keyboard or moving your mouse, press and hold the power button for at least 8 to 10 seconds (until the computer turns off), and then restart your computer.

Other software problems

CHECK THE SOFTWARE DOCUMENTATION OR CONTACT THE SOFTWARE MANUFACTURER FOR TROUBLESHOOTING INFORMATION —

- Ensure that the program is compatible with the operating system installed on your computer.
- Ensure that your computer meets the minimum hardware requirements needed to run the software. See the software documentation for information.
- Ensure that the program is installed and configured properly.
- Verify that the device drivers do not conflict with the program.
- If necessary, uninstall and then reinstall the program.

BACK UP YOUR FILES IMMEDIATELY

USE A VIRUS-SCANNING PROGRAM TO CHECK THE HARD DRIVE, FLOPPY DISKS, CDS, OR DVDs

SAVE AND CLOSE ANY OPEN FILES OR PROGRAMS AND SHUT DOWN YOUR COMPUTER THROUGH THE START MENU

Memory Problems

 **CAUTION:** Before you begin any of the procedures in this section, follow the safety instructions in the *Product Information Guide*.

IF YOU RECEIVE AN INSUFFICIENT MEMORY MESSAGE —

- Save and close any open files and exit any open programs you are not using to see if that resolves the problem.
- See the software documentation for minimum memory requirements. If necessary, install additional memory (see "Installing Memory" in the *Service Manual* on the Dell Support website at support.dell.com).
- Reseat the memory modules (see "Memory" in the *Service Manual* on the Dell Support website at support.dell.com) to ensure that your computer is successfully communicating with the memory.
- Run the Dell Diagnostics (see "Dell Diagnostics" on page 95).

IF YOU EXPERIENCE OTHER MEMORY PROBLEMS —

- Reseat the memory modules (see Memory in the *Service Manual* on the Dell Support website at support.dell.com) to ensure that your computer is successfully communicating with the memory.
- Ensure that you are following the memory installation guidelines (see Installing Memory in the *Service Manual* on the Dell Support website at support.dell.com).
- Ensure that the memory you are using is supported by your computer. For more information about the type of memory supported by your computer, see Memory in the *Service Manual* on the Dell Support website at support.dell.com on page 161.
- Run the Dell Diagnostics (see "Dell Diagnostics" on page 95).

Mouse Problems

 **CAUTION:** Before you begin any of the procedures in this section, follow the safety instructions in the *Product Information Guide*.

CHECK THE MOUSE CABLE —

- Ensure that the cable is not damaged or frayed and check cable connectors for bent or broken pins. Straighten any bent pins.
- Remove any mouse extension cables, and connect the mouse directly to the computer.
- Verify that the mouse cable is connected as shown on the setup diagram for your computer.

RESTART THE COMPUTER —

- 1 Simultaneously press <Ctrl><Esc> to display the **Start** menu.
- 2 Press <u>, press the up- and down-arrow keys to highlight **Shut down** or **Turn Off**, and then press <Enter>.
- 3 After the computer turns off, reconnect the mouse cable as shown on the setup diagram.
- 4 Turn on the computer.

TEST THE MOUSE — Connect a properly working mouse to the computer, then try using the mouse.

CHECK THE MOUSE SETTINGS —

Windows XP

- 1 Click **Start**→ **Control Panel**→ **Mouse**.
- 2 Adjust the settings as needed.

Windows Vista:

- 1 Click **Start**  → **Control Panel**→ **Hardware and Sound**→ **Mouse**.
- 2 Adjust the settings as needed.

REINSTALL THE MOUSE DRIVER — See "Drivers" on page 117.

RUN THE HARDWARE TROUBLESHOOTER — See "Troubleshooting Software and Hardware Problems in the Microsoft® Windows® XP and Windows Vista® Operating Systems" on page 121.

Network Problems



CAUTION: Before you begin any of the procedures in this section, follow the safety instructions in the *Product Information Guide*.

CHECK THE NETWORK CABLE CONNECTOR — Ensure that the network cable is firmly inserted into the network connector on the back of the computer and the network jack.

CHECK THE NETWORK LIGHTS ON THE BACK OF THE COMPUTER — If the link integrity light is off (see "Controls and Lights" on page 132), no network communication is occurring. Replace the network cable.

RESTART THE COMPUTER AND LOG ON TO THE NETWORK AGAIN

CHECK YOUR NETWORK SETTINGS — Contact your network administrator or the person who set up your network to verify that your network settings are correct and that the network is functioning.

RUN THE HARDWARE TROUBLESHOOTER — See "Troubleshooting Software and Hardware Problems in the Microsoft® Windows® XP and Windows Vista® Operating Systems" on page 121.

Power Problems

 **CAUTION:** Before you begin any of the procedures in this section, follow the safety instructions in the *Product Information Guide*.

IF THE POWER LIGHT IS WHITE AND THE COMPUTER IS NOT RESPONDING — See "Beep Codes" on page 90.

IF THE POWER LIGHT IS STEADY AMBER — The computer is in standby mode. Press a key on the keyboard, move the mouse, or press the power button to resume normal operation.

IF THE POWER LIGHT IS OFF — The computer is either turned off or is not receiving power.

- Reseat the power cable in the power connector on the back of the computer and the electrical outlet.
- Bypass power strips, power extension cables, and other power protection devices to verify that the computer turns on properly.
- Ensure that any power strips being used are plugged into an electrical outlet and are turned on.
- Ensure that the electrical outlet is working by testing it with another device, such as a lamp.
- Ensure that the main power cable and front panel cable are securely connected to the system board (see "System Board Components" in the *Service Manual* on the Dell Support website at support.dell.com).

ELIMINATE INTERFERENCE — Some possible causes of interference are:

- Power, keyboard, and mouse extension cables
- Too many devices connected to the same power strip
- Multiple power strips connected to the same electrical outlet

Printer Problems

 **CAUTION:** Before you begin any of the procedures in this section, follow the safety instructions in the *Product Information Guide*.

 **NOTE:** If you need technical assistance for your printer, contact the printer's manufacturer.

CHECK THE PRINTER DOCUMENTATION — See the printer documentation for setup and troubleshooting information.

ENSURE THAT THE PRINTER IS TURNED ON

CHECK THE PRINTER CABLE CONNECTIONS —

- See the printer documentation for cable connection information.
- Ensure that the printer cables are securely connected to the printer and the computer.

TEST THE ELECTRICAL OUTLET — Ensure that the electrical outlet is working by testing it with another device, such as a lamp.

VERIFY THAT THE PRINTER IS RECOGNIZED BY WINDOWS —

Windows XP:

- 1 Click **Start**→ **Control Panel**→ **Printers and Other Hardware**→ **View installed printers or fax printers**.
- 2 If the printer is listed, right-click the printer icon.
- 3 Click **Properties**→ **Ports**. For a parallel printer, ensure that the **Print to the following port(s)**: setting is **LPT1 (Printer Port)**. For a USB printer, ensure that the **Print to the following port(s)**: setting is **USB**.

Windows Vista:

- 1 Click **Start**  → **Control Panel**→ **Hardware and Sound**→ **Printer**.
- 2 If the printer is listed, right-click the printer icon.
- 3 Click **Properties and click Ports**.
- 4 Adjust the settings, as needed.

REINSTALL THE PRINTER DRIVER — See the printer documentation for information on reinstalling the printer driver.

Scanner Problems



CAUTION: Before you begin any of the procedures in this section, follow the safety instructions in the *Product Information Guide*.



NOTE: If you need technical assistance for your scanner, contact the scanner's manufacturer.

CHECK THE SCANNER DOCUMENTATION — See the scanner documentation for setup and troubleshooting information.

UNLOCK THE SCANNER — Ensure that your scanner is unlocked (if the scanner has a locking tab or button).

RESTART THE COMPUTER AND TRY THE SCANNER AGAIN

CHECK THE CABLE CONNECTIONS —

- See the scanner documentation for information on cable connections.
- Ensure that the scanner cables are securely connected to the scanner and the computer.

VERIFY THAT THE SCANNER IS RECOGNIZED BY MICROSOFT WINDOWS —

Windows XP:

- 1 Click **Start** → **Control Panel** → **Printers and Other Hardware** → **Scanners and Cameras**.
- 2 If your scanner is listed, Windows recognizes the scanner.

Windows Vista:

- 1 Click **Start**  → **Control Panel** → **Hardware and Sound** → **Scanners and Cameras**.
- 2 If the scanner is listed, Windows recognizes the scanner.

REINSTALL THE SCANNER DRIVER — See the scanner documentation for instructions.

Sound and Speaker Problems



CAUTION: Before you begin any of the procedures in this section, follow the safety instructions in the *Product Information Guide*.

No sound from speakers



NOTE: The volume control in MP3 and other media players may override the Windows volume setting. Always check to ensure that the volume on the media player(s) has not been turned down or off.

CHECK THE SPEAKER CABLE CONNECTIONS — Ensure that the speakers are connected as shown on the setup diagram supplied with the speakers. If you purchased a sound card, ensure that the speakers are connected to the card.

ENSURE THAT THE SUBWOOFER AND THE SPEAKERS ARE TURNED ON — See the setup diagram supplied with the speakers. If your speakers have volume controls, adjust the volume, bass, or treble to eliminate distortion.

ADJUST THE WINDOWS VOLUME CONTROL — Click or double-click the speaker icon in the lower-right corner of your screen. Ensure that the volume is turned up and that the sound is not muted.

DISCONNECT HEADPHONES FROM THE HEADPHONE CONNECTOR — Sound from the speakers is automatically disabled when headphones are connected to the computer's front-panel headphone connector.

TEST THE ELECTRICAL OUTLET — Ensure that the electrical outlet is working by testing it with another device, such as a lamp.

ELIMINATE POSSIBLE INTERFERENCE — Turn off nearby fans, fluorescent lights, or halogen lamps to check for interference.

RUN THE SPEAKER DIAGNOSTICS

REINSTALL THE SOUND DRIVER — See "Drivers" on page 117.

RUN THE HARDWARE TROUBLESHOOTER — See "Troubleshooting Software and Hardware Problems in the Microsoft® Windows® XP and Windows Vista® Operating Systems" on page 121.

No sound from headphones

CHECK THE HEADPHONE CABLE CONNECTION — Ensure that the headphone cable is securely inserted into the headphone connector (see "Front View of the Computer" on page 17 and "Back View of the Computer" on page 19).

ADJUST THE WINDOWS VOLUME CONTROL — Click or double-click the speaker icon in the lower-right corner of your screen. Ensure that the volume is turned up and that the sound is not muted.

Video and Monitor Problems



CAUTION: Before you begin any of the procedures in this section, follow the safety instructions in the *Product Information Guide*.



NOTICE: If your computer came with a PCI graphics card installed, removal of the card is not necessary when installing additional graphics cards; however, the card is required for troubleshooting purposes. If you remove the card, store it in a safe and secure location. For information about your graphics card, go to support.dell.com.

The screen is blank



NOTE: For troubleshooting procedures, see the monitor's documentation.

The screen is difficult to read

CHECK THE MONITOR CABLE CONNECTION —

- Ensure that the monitor cable is connected to the correct graphics card (for dual graphics card configurations).
- If you are using the optional DVI-to-VGA adapter, ensure that the adapter is correctly attached to the graphics card and monitor.
- Ensure that the monitor cable is connected as shown on the setup diagram for your computer.
- Remove any video extension cables and connect the monitor directly to the computer.

- Swap the computer and monitor power cables to determine if the monitor's power cable is defective.
- Check the connectors for bent or broken pins (it is normal for monitor cable connectors to have missing pins).

CHECK THE MONITOR POWER LIGHT —

- If the power light is lit or blinking, the monitor has power.
- If the power light is off, firmly press the button to ensure that the monitor is turned on.
- If the power light is blinking, press a key on the keyboard or move the mouse to resume normal operation.

TEST THE ELECTRICAL OUTLET — Ensure that the electrical outlet is working by testing it with another device, such as a lamp.

CHECK THE BEEP CODES — See "Beep Codes" on page 90.

CHECK THE MONITOR SETTINGS — See the monitor documentation for instructions on adjusting the contrast and brightness, demagnetizing (degaussing) the monitor, and running the monitor self-test.

MOVE THE SUBWOOFER AWAY FROM THE MONITOR — If your speaker system includes a subwoofer, ensure that the subwoofer is positioned at least 60 centimeters (2 feet) away from the monitor.

MOVE THE MONITOR AWAY FROM EXTERNAL POWER SOURCES — Fans, fluorescent lights, halogen lamps, and other electrical devices can cause the screen image to appear *shaky*. Turn off nearby devices to check for interference.

ROTATE THE MONITOR TO ELIMINATE SUNLIGHT GLARE AND POSSIBLE INTERFERENCE

ADJUST THE WINDOWS DISPLAY SETTINGS —

Windows XP:

- 1 Click **Start** → **Control Panel** → **Appearance and Themes**.
- 2 Click the area you want to change or click the **Display** icon.
- 3 Try different settings for **Color quality** and **Screen resolution**.

Windows Vista:

- 1 Click **Start**  → **Control Panel** → **Hardware and Sound** → **Personalization** → **Display Settings**.
- 2 Adjust **Resolution** and **Colors** settings, as needed.

3D image quality is poor

CHECK THE GRAPHICS CARD POWER CABLE CONNECTION — Ensure that the power cable for the graphics card(s) is correctly attached to the card.

CHECK THE MONITOR SETTINGS — See the monitor documentation for instructions on adjusting the contrast and brightness, demagnetizing (degaussing) the monitor, and running the monitor self-test.

Only part of the display is readable

CONNECT AN EXTERNAL MONITOR —

- 1 Shut down your computer and connect an external monitor to the computer.
- 2 Turn on the computer and the monitor and adjust the monitor brightness and contrast controls.

If the external monitor works, the computer display or video controller may be defective. Contact Dell (see "Contacting Dell" on page 141).

Overclocking Problems

Overclocking may result in system instability. After three unsuccessful boot attempts, the system automatically resets the overclock settings in the system setup program to the BIOS defaults.

To correct the issue manually, you must change the overclock setting in the system setup program (see "Entering System Setup" on page 77) or reset CMOS defaults (see "Clearing CMOS Settings" on page 87).

Power Lights



CAUTION: Before you begin any of the procedures in this section, follow the safety instructions in the *Product Information Guide*.

The power button light located on the front of the computer illuminates and blinks or remains solid to indicate different states:

- If the power light is steady white and the computer is not responding, see "Beep Codes" on page 90.
- If the power light is blinking white, the computer is in standby mode. Press a key on the keyboard, move the mouse, or press the power button to resume normal operation.

- If the power light is off, the computer is either turned off or is not receiving power.
 - Reseat the power cable into both the power connector on the back of the computer and the electrical outlet.
 - If the computer is plugged into a power strip, ensure that the power strip is plugged into an electrical outlet and that the power strip is turned on.
 - Bypass power protection devices, power strips, and power extension cables to verify that the computer turns on properly.
 - Ensure that the electrical outlet is working by testing it with another device, such as a lamp.
 - Ensure that the main power cable and front panel cable are securely connected to the system board (see "System Board Components" in the *Service Manual* on the Dell Support website at support.dell.com).
- Eliminate interference. Some possible causes of interference are:
 - Power, keyboard, and mouse extension cables
 - Too many devices on a power strip
 - Multiple power strips connected to the same electrical outlet

The power supply diagnostic LED located on the back of the computer indicates different states of the power supply. To test the power supply, press the power supply test switch.

- If the power supply diagnostic LED is green, power is available for the power supply.
- If the power supply diagnostic LED is off:
 - The power supply is not receiving power — Ensure that the main power cable is connected to the system.
 - The power supply is not working — This issue occurs either due to a bad power supply or a device attached to the power supply.

To resolve the issue, contact Dell (See "Contacting Dell" on page 141).

Reinstalling Software

Drivers

What Is a Driver?

A driver is a program that controls a device such as a printer, mouse, or keyboard. All devices require a driver program.

A driver acts like a translator between the device and any other programs that use the device. Each device has its own set of specialized commands that only its driver recognizes.

Dell ships your computer to you with required drivers already installed—no further installation or configuration is needed.

 **NOTICE:** The *Drivers and Utilities* media may contain drivers for operating systems that are not on your computer. Ensure that you are installing software appropriate for your operating system.

Many drivers, such as the keyboard driver, come with your Microsoft Windows operating system. You may need to install drivers if you:

- Upgrade your operating system.
- Reinstall your operating system.
- Connect or install a new device.

Identifying Drivers

If you experience a problem with any device, identify whether the driver is the source of your problem and, if necessary, update the driver.

Microsoft® Windows® XP

- 1 Click Start→ Control Panel.
- 2 Under Pick a Category, click Performance and Maintenance, and click System.
- 3 In the System Properties window, click the Hardware tab, and click Device Manager.

Windows Vista®

- 1 Click the Windows Vista start button , and right-click **Computer**.
- 2 Click **Properties**→ **Device Manager**.



NOTE: The **User Account Control** window may appear. If you are an administrator on the computer, click **Continue**; otherwise, contact your administrator to continue.

Scroll down the list to see if any device has an exclamation point (a yellow circle with a [!]) on the device icon.

If an exclamation point is next to the device name, you may need to reinstall the driver or install a new driver (see "Reinstalling Drivers and Utilities" on page 118).

Reinstalling Drivers and Utilities



NOTICE: The Dell Support website at support.dell.com and your *Drivers and Utilities* media provide approved drivers for Dell™ computers. If you install drivers obtained from other sources, your computer might not work correctly.

Using Windows Device Driver Rollback

If a problem occurs on your computer after you install or update a driver, use Windows Device Driver Rollback to replace the driver with the previously installed version.

Windows XP:

- 1 Click **Start**→ **My Computer**→ **Properties**→ **Hardware**→ **Device Manager**.
- 2 Right-click the device for which the new driver was installed and click **Properties**.
- 3 Click the **Drivers** tab→ **Roll Back Driver**.

Windows Vista:

- 1 Click the Windows Vista start button , and right-click **Computer**.
- 2 Click **Properties**→ **Device Manager**.



NOTE: The **User Account Control** window may appear. If you are an administrator on the computer, click **Continue**; otherwise, contact your administrator to enter the Device Manager.

- 3 Right-click the device for which the new driver was installed and click **Properties**.
- 4 Click the **Drivers** tab→ **Roll Back Driver**.

If Device Driver Rollback does not resolve the problem, then use System Restore (see "Restoring Your Operating System" on page 122) to return your computer to the operating state that existed before you installed the new driver.

Using the Drivers and Utilities Media

- 1 With the Windows desktop displayed, insert the *Drivers and Utilities* media. If this is your first time to use the *Drivers and Utilities* media, go to step 2. If not, go to step 5.
- 2 When the *Drivers and Utilities* media installation program starts, follow the prompts on the screen.
- 3 When the **InstallShield Wizard Complete** window appears, remove the *Drivers and Utilities* media and click **Finish** to restart the computer.
- 4 When you see the Windows desktop, reinsert the *Drivers and Utilities* media.
- 5 At the **Welcome Dell System Owner** screen, click **Next**.



NOTE: The *Drivers and Utilities* media displays drivers only for hardware that came installed in your computer. If you installed additional hardware, the drivers for the new hardware might not be displayed by the *Drivers and Utilities* media. If those drivers are not displayed, exit the *Drivers and Utilities* program. For drivers information, see the documentation that came with the device.

A message stating that the media is detecting hardware in your computer appears.

The drivers that are used by your computer are automatically displayed in the **My Drivers—The Drivers and Utilities media has identified these components in your system** window.

- 6 Click the driver that you want to reinstall and follow the instructions on the screen.

If a particular driver is not listed, then that driver is not required by your operating system.



Manually Reinstalling Drivers

After extracting the driver files to your hard drive as described in the previous section:

Windows XP:

- 1 Click **Start**→**My Computer**→**Properties**→**Hardware**→**Device Manager**.
- 2 Double-click the type of device for which you are installing the driver (for example, **Audio** or **Video**).
- 3 Double-click the name of the device for which you are installing the driver.
- 4 Click the **Driver** tab→**Update Driver**.
- 5 Click **Install from a list or specific location (Advanced)**→**Next**.
- 6 Click **Browse** and browse to the location to which you previously copied the driver files.
- 7 When the name of the appropriate driver appears, click **Next**.
- 8 Click **Finish** and restart your computer.

Windows Vista:

- 1 Click the Windows Vista start button , and right-click **Computer**.
- 2 Click **Properties**→**Device Manager**.
 **NOTE:** The **User Account Control** window may appear. If you are an administrator on the computer, click **Continue**; otherwise, contact your administrator to enter the Device Manager.
- 3 Double-click the type of device for which you are installing the driver (for example, **Audio** or **Video**).
- 4 Double-click the name of the device for which you are installing the driver.
- 5 Click the **Driver** tab→**Update Driver**→**Browse my computer for driver software**.
- 6 Click **Browse** and browse to the location to which you previously copied the driver files.
- 7 When the name of the appropriate driver appears, click the name of the driver→**OK**→**Next**.
- 8 Click **Finish** and restart your computer.

Troubleshooting Software and Hardware Problems in the Microsoft® Windows® XP and Windows Vista® Operating Systems

If a device is either not detected during the operating system setup or is detected but incorrectly configured, you can use the Hardware Troubleshooter to resolve the incompatibility.

To start the Hardware Troubleshooter:

Windows XP:

- 1 Click **Start**→ **Help and Support**.
- 2 Type `hardware troubleshooter` in the search field and press <Enter> to start the search.
- 3 In the **Fix a Problem** section, click **Hardware Troubleshooter**.
- 4 In the **Hardware Troubleshooter** list, select the option that best describes the problem and click **Next** to follow the remaining troubleshooting steps.

Windows Vista:

- 1 Click the Windows Vista start button , and click **Help and Support**.
- 2 Type `hardware troubleshooter` in the search field and press <Enter> to start the search.
- 3 In the search results, select the option that best describes the problem and follow the remaining troubleshooting steps.

Restoring Your Operating System

You can restore your operating system in the following ways:

- System Restore returns your computer to an earlier operating state without affecting data files. Use System Restore as the first solution for restoring your operating system and preserving data files.
- Dell PC Restore by Symantec (available in Windows XP) and Dell Factory Image Restore (available in Windows Vista) returns your hard drive to the operating state it was in when you purchased the computer. Both permanently delete all data on the hard drive and remove any programs installed after you received the computer. Use Dell PC Restore or Dell Factory Image Restore only if System Restore did not resolve your operating system problem.
- If you received an *Operating System* disc with your computer, you can use it to restore your operating system. However, using the *Operating System* disc also deletes all data on the hard drive. Use the disc *only* if System Restore did not resolve your operating system problem.

Using Microsoft Windows System Restore

The Windows operating systems provide a System Restore option which allows you to return your computer to an earlier operating state (without affecting data files) if changes to the hardware, software, or other system settings have left the computer in an undesirable operating state. Any changes that System Restore makes to your computer are completely reversible.



NOTICE: Make regular backups of your data files. System Restore does not monitor your data files or recover them.



NOTE: The procedures in this document were written for the Windows default view, so they may not apply if you set your Dell™ computer to the Windows Classic view.

Starting System Restore

Windows XP:



NOTICE: Before you restore the computer to an earlier operating state, save and close any open files and exit any open programs. Do not alter, open, or delete any files or programs until the system restoration is complete.

- 1 Click **Start**→ **All Programs**→ **Accessories**→ **System Tools**→ **System Restore**.
- 2 Click either **Restore my computer to an earlier time** or **Create a restore point**.
- 3 Click **Next** and follow the remaining on-screen prompts.

Windows Vista:

- 1 Click **Start** .

- 2 In the Start Search box, type **System Restore** and press <Enter>.



NOTE: The **User Account Control** window may appear. If you are an administrator on the computer, click **Continue**; otherwise, contact your administrator to continue the desired action.

- 3 Click **Next** and follow the remaining prompts on the screen.

In the event that System Restore did not resolve the issue, you may undo the last system restore.

Undoing the Last System Restore



NOTICE: Before you undo the last system restore, save and close all open files and exit any open programs. Do not alter, open, or delete any files or programs until the system restoration is complete.

Windows XP:

- 1 Click **Start**→ **All Programs**→ **Accessories**→ **System Tools**→ **System Restore**.
- 2 Click **Undo my last restoration** and click **Next**.

Windows Vista:

- 1 Click **Start** .

- 2 In the Start Search box, type **System Restore** and press <Enter>.
- 3 Click **Undo my last restoration** and click **Next**.

Enabling System Restore



NOTE: Windows Vista does not disable System Restore; regardless of low disk space. Therefore, the steps below apply only to Windows XP.

If you reinstall Windows XP with less than 200 MB of free hard-disk space available, System Restore is automatically disabled.

To see if System Restore is enabled:

- 1 Click **Start**→ **Control Panel**→ **Performance and Maintenance**→ **System**.
- 2 Click the **System Restore** tab and ensure that **Turn off System Restore** is unchecked.

Using Dell™ PC Restore and Dell Factory Image Restore



NOTICE: Using Dell PC Restore or Dell Factory Image Restore permanently deletes all data on the hard drive and removes any programs or drivers installed after you received your computer. If possible, back up the data before using these options. Use PC Restore or Dell Factory Image Restore only if System Restore did not resolve your operating system problem.



NOTE: Dell PC Restore by Symantec and Dell Factory Image Restore may not be available in certain countries or on certain computers.

Use Dell PC Restore (Windows XP) or Dell Factory Image Restore (Windows Vista) only as the last method to restore your operating system. These options restore your hard drive to the operating state it was in when you purchased the computer. Any programs or files added since you received your computer—including data files—are permanently deleted from the hard drive. Data files include documents, spreadsheets, e-mail messages, digital photos, music files, and so on. If possible, back up all data before using PC Restore or Factory Image Restore.

Windows XP: Dell PC Restore

Using PC Restore:

- 1 Turn on the computer.

During the boot process, a blue bar with www.dell.com appears at the top of the screen.

- 2 Immediately upon seeing the blue bar, press <Ctrl><F11>.

If you do not press <Ctrl><F11> in time, let the computer finish starting, and then restart the computer again.



NOTICE: If you do not want to proceed with PC Restore, click **Reboot**.

- 3 Click **Restore** and click **Confirm**.

The restore process takes approximately 6 to 10 minutes to complete.

- 4 When prompted, click **Finish** to reboot the computer.



NOTE: Do not manually shut down the computer. Click **Finish** and let the computer completely reboot.

- 5 When prompted, click **Yes**.

The computer restarts. Because the computer is restored to its original operating state, the screens that appear, such as the End User License Agreement, are the same ones that appeared the first time the computer was turned on.

- 6 Click **Next**.

The **System Restore** screen appears and the computer restarts.

- 7 After the computer restarts, click **OK**.

Removing PC Restore:



NOTICE: Removing Dell PC Restore from the hard drive permanently deletes the PC Restore utility from your computer. After you have removed Dell PC Restore, you will not be able to use it to restore your computer operating system.

Dell PC Restore enables you to restore your hard drive to the operating state it was in when you purchased your computer. It is recommended that you *do not* remove PC Restore from your computer, even to gain additional hard-drive space. If you remove PC Restore from the hard drive, you cannot ever recall it, and you will never be able to use PC Restore to return your computer operating system to its original state.

- 1 Log on to the computer as a local administrator.
- 2 In Microsoft Windows Explorer, go to `c:\dell\utilities\DSR`.
- 3 Double-click the filename `DSRIRRemv2.exe`.



NOTE: If you do not log on as a local administrator, a message appears stating that you that you must log on as administrator. Click **Quit**, and then log on as a local administrator.



NOTE: If the partition for PC Restore does not exist on your computer hard drive, a message appears stating that the partition was not found. Click **Quit**; there is no partition to delete.

- 4 Click **OK** to remove the PC Restore partition on the hard drive.
- 5 Click **Yes** when a confirmation message appears.
The PC Restore partition is deleted and the newly available disk space is added to the free space allocation on the hard drive.
- 6 Right-click **Local Disk (C)** in Windows Explorer, click **Properties**, and verify that the additional disk space is available as indicated by the increased value for **Free Space**.
- 7 Click **Finish** to close the **PC Restore Removal** window and restart the computer.

Windows Vista: Dell Factory Image Restore

- 1 Turn on the computer. When the Dell logo appears, press <F8> several times to access the Vista Advanced Boot Options Window.
- 2 Select **Repair Your Computer**.
The System Recovery Options window appears.
- 3 Select a keyboard layout and click **Next**.
- 4 To access the recovery options, log on as a local user. To access the command prompt, type `administrator` in the User name field, then click **OK**.
- 5 Click **Dell Factory Image Restore**.



NOTE: Depending upon your configuration, you may need to select **Dell Factory Tools**, then **Dell Factory Image Restore**.

The Dell Factory Image Restore welcome screen appears.

6 Click **Next**.

The Confirm Data Deletion screen appears.



NOTICE: If you do not want to proceed with Factory Image Restore, click **Cancel**.

7 Click the checkbox to confirm that you want to continue reformatting the hard drive and restoring the system software to the factory condition, then click **Next**.

The restore process begins and may take five or more minutes to complete. A message appears when the operating system and factory-installed applications have been restored to factory condition.

8 Click **Finish** to reboot the system.

Using the Operating System Media

Before you Begin

If you are considering reinstalling the Windows operating system to correct a problem with a newly installed driver, first try using Windows Device Driver Rollback. See "Using Windows Device Driver Rollback" on page 118. If Device Driver Rollback does not resolve the problem, then use system restore to return your operating system to the operating state it was in before you installed the new device driver. See "Using Microsoft Windows System Restore" on page 122.



NOTICE: Before performing the installation, back up all data files on your primary hard drive. For conventional hard drive configurations, the primary hard drive is the first drive detected by the computer.

To reinstall Windows, you need the following items:

- Dell™ *Operating System* media
- Dell *Drivers and Utilities* media



NOTE: The Dell *Drivers and Utilities* media contains drivers that were installed during the assembly of the computer. Use the Dell *Drivers and Utilities* media to load any required drivers. Depending on the region from which you ordered your computer, or whether you requested the media, the Dell *Drivers and Utilities* media and *Operating System* media may not ship with your computer.

Reinstalling Windows XP or Windows Vista

The reinstallation process can take 1 to 2 hours to complete. After you reinstall the operating system, you must also reinstall the device drivers, virus protection program, and other software.

 **NOTICE:** The *Operating System* media provides options for reinstalling Windows XP. The options can overwrite files and possibly affect programs that are installed on your hard drive. Therefore, do not reinstall Windows XP unless a Dell technical support representative instructs you to do so.

- 1 Save and close any open files and exit any open programs.
- 2 Insert the *Operating System* disc.
- 3 Click **Exit** if the **Install Windows** message appears.
- 4 Restart the computer.

When the DELL logo appears, press <F12> immediately.

 **NOTE:** If you wait too long and the operating system logo appears, continue to wait until you see the Microsoft® Windows® desktop; then, shut down your computer and try again.

 **NOTE:** The next steps change the boot sequence for one time only. On the next start-up, the computer boots according to the devices specified in the system setup program.

- 5 When the boot device list appears, highlight **CD/DVD/CD-RW Drive** and press <Enter>.
- 6 Press any key to **Boot from CD-ROM**.
- 7 Follow the instructions on the screen to complete the installation.

Specifications



NOTE: Offerings may vary by region. For more information regarding the configuration of your computer, click **Start**→ **Help and Support** and select the option to view information about your computer.

Processor

Processor type	Intel® Core™ 2 Duo Intel Core 2 Quad Intel Core 2 Extreme (dual and quad-core processor)
Cache	at least 1 MB
FSB speed	1066/1333 MHz

System Information

System chipset	NVIDIA® nForce 650i SLI
Northbridge	C55
Southbridge	MCP51
BIOS chip	8 MB
NIC	integrated network interface capable of 10/100/1000 communication

Memory

Memory module connector	four user-accessible DDR2 sockets
Memory module capacities	128, 256, 512 MB, 1 GB, or 2 GB non-ECC
Memory type	800 and 667-MHz DDR2 unbuffered SDRAM; SLI memory
Minimum memory	1 GB
Maximum memory	8 GB

Expansion Bus

Bus type	PCI Express x1, x8, and x16 PCI 32-bit
PCI (SLOT5 and SLOT6)	
connector	two
connector size	124 pins
connector data width (maximum)	32 bits
bus speed	33 MHz
PCI Express (SLOT2)	
connector	one x1
connector size	36 pins
connector data width (maximum)	one PCI Express lane
Bus throughput	x1 slot bidirectional speed — 2.5 Gbps
PCI Express (SLOT3)	
connector	one x8
connector size	98 pins
connector data width (maximum)	1 PCI Express lane
PCI Express (SLOT1 and SLOT4)	
connector	two x16
connector size	164 pins
connector data width (maximum)	8 PCI Express lanes

NOTE: SLOT 1 is the primary GFX slot and SLOT 4 is the secondary GFX slot.

Ports and Connectors

External Connectors

Audio	microphone, line-in, line-out, side-surround, center/LFE, rear-surround
IEEE 1394	6-pin serial connector
Network adapter	RJ-45 port
PS/2 keyboard/mouse	6-pin mini-DIN connector
USB	4-pin USB 2.0-compliant connector
S/PDIF	Toslink optical connector

Systemboard Connectors

IDE drive	one 40-pin connector
Serial ATA	four 7-pin connectors
Floppy drive	one 34-pin connector
Fan	three 4-pin connectors
PCI	two 124-pin connectors
PCI Express x1	one 36-pin connector
PCI Express x8	one 98-pin connector
PCI Express x16	two 164-pin connector

Controls and Lights

Power control	push button
Power light	white light — Solid white for power on state blinking white light — Blinking white for power-saving state
Hard-drive access light	white
Link integrity light (on integrated network adapter)	green light — A good connection exists between a 10-Mbps network and the computer. orange light — A good connection exists between a 100-Mbps network and the computer. yellow light — A good connection exists between a 1-GB (1000-Mbps) network and the computer. off (no light) — The computer is not detecting a physical connection to the network.
Power supply diagnostic LED	green light — Indicates power availability for power supply. off (no light) — Indicates no power available for the power supply.
Activity light (on integrated network adapter)	yellow blinking light — Indicates activity on the network. off (no light) — Indicates no activity on the network.
Standby power light	AUX_PWR on the system board
Front panel LEDs	seven multi-colored LEDs provide illumination for the front of the computer NOTE: The color of the LEDs can be adjusted using Windows Nvidia ESA light affects software.
Back panel LEDs	two multi-colored lights provide illumination for the I/O panel on the back of the computer NOTE: The color of the LEDs can be adjusted using Windows Nvidia ESA light affects software.

Video	
Video type	PCI Express
Audio	
Audio type	HDA 7.1 channel
Power	
DC power supply	 CAUTION: To reduce the risk of fire, electric shock, or injury, do not overload an electrical outlet, power strip, or convenience receptacle. The total ampere rating of all products plugged into an electrical outlet, power strip, or other receptacle should not exceed 80 percent of the branch circuit rating.
Wattage	750 W
Heat dissipation	750 W; 2559.1 BTU/hr NOTE: Heat dissipation is calculated based upon the power supply rating.
Voltage (see the safety instructions located in the <i>Product Information Guide</i>)	auto-sensing power supply—90 V to 265 V at 50/60 Hz
Backup battery	3-V CR2032 lithium coin cell
Physical	
Height	488 mm
Width	195 mm
Depth	560 mm

Environmental

Temperature range:

Operating	0° to 40°C (32° to 104°F)
Storage	-40° to 65°C (-40° to 149°F)

Relative humidity (maximum):

Operating	10% to 90% (noncondensing)
Storage	5% to 95% (noncondensing)

Maximum vibration (using a random-vibration spectrum that simulates user environment):

Operating	0.9 GRMS
Storage	1.3 GRMS

Maximum shock (measured with hard drive in head-parked position and a 2-ms half-sine pulse):

Operating	122 G
Storage	163 G

Altitude (maximum):

Operating	-15.2 to 3048 m (-50 to 10,000 ft)
Storage	-15.2 to 10,668 m (-50 to 35,000 ft)

Airborne contaminant level

G2 or lower as defined by ISA-S71.04-1985

Getting Help

Obtaining Assistance

 **CAUTION:** If you need to remove the computer cover, first disconnect the computer power and modem cables from all electrical outlets.

If you experience a problem with your computer, you can complete the following steps to diagnose and troubleshoot the problem:

- 1 See "Troubleshooting" on page 101 for information and procedures that pertain to the problem your computer is experiencing.
- 2 See "Dell Diagnostics" on page 95 for procedures on how to run Dell Diagnostics.
- 3 Fill out the "Diagnostics Checklist" on page 140.
- 4 Use Dell's extensive suite of online services available at Dell Support (support.dell.com) for help with installation and troubleshooting procedures. See "Online Services" on page 136 for a more extensive list of Dell Support online.
- 5 If the preceding steps have not resolved the problem, see "Contacting Dell" on page 141.

 **NOTE:** Call Dell Support from a telephone near or at the computer so that the support staff can assist you with any necessary procedures.

 **NOTE:** Dell's Express Service Code system may not be available in all countries.

When prompted by Dell's automated telephone system, enter your Express Service Code to route the call directly to the proper support personnel. If you do not have an Express Service Code, open the **Dell Accessories** folder, double-click the **Express Service Code** icon, and follow the directions.

For instructions on using the Dell Support, see "Technical Support and Customer Service" on page 136.



NOTE: Some of the following services are not always available in all locations outside the continental U.S. Call your local Dell representative for information on availability.

Technical Support and Customer Service

Dell's support service is available to answer your questions about Dell™ hardware. Our support staff uses computer-based diagnostics to provide fast, accurate answers.

To contact Dell's support service, see "Before You Call" on page 139, and then see the contact information for your region or go to support.dell.com.

DellConnect

DellConnect is a simple online access tool that allows a Dell service and support associate to access your computer through a broadband connection, diagnose your problem and repair it all under your supervision. For more information, go to support.dell.com and click **DellConnect**.

Online Services

You can learn about Dell products and services on the following websites:

www.dell.com

www.dell.com/ap (Asian/Pacific countries only)

www.dell.com/jp (Japan only)

www.euro.dell.com (Europe only)

www.dell.com/la (Latin American and Caribbean countries)

www.dell.ca (Canada only)

You can access Dell Support through the following websites and e-mail addresses:

- Dell Support websites
support.dell.com
support.jp.dell.com (Japan only)
support.euro.dell.com (Europe only)

- Dell Support e-mail addresses
mobile_support@us.dell.com
support@us.dell.com
la-techsupport@dell.com (Latin America and Caribbean countries only)
apsupport@dell.com (Asian/Pacific countries only)
- Dell Marketing and Sales e-mail addresses
apmarketing@dell.com (Asian/Pacific countries only)
sales_canada@dell.com (Canada only)
- Anonymous file transfer protocol (FTP)
ftp.dell.com
Log in as user: anonymous, and use your e-mail address as your password.

AutoTech Service

Dell's automated support service—AutoTech—provides recorded answers to the questions most frequently asked by Dell customers about their portable and desktop computers.

When you call AutoTech, use your touch-tone telephone to select the subjects that correspond to your questions. For the telephone number to call for your region, see "Contacting Dell" on page 141.

Automated Order-Status Service

To check on the status of any Dell products that you have ordered, you can go to support.dell.com, or you can call the automated order-status service. A recording prompts you for the information needed to locate and report on your order. For the telephone number to call for your region, see "Contacting Dell" on page 141.

Problems With Your Order

If you have a problem with your order, such as missing parts, wrong parts, or incorrect billing, contact Dell for customer assistance. Have your invoice or packing slip handy when you call. For the telephone number to call for your region, see "Contacting Dell" on page 141.

Product Information

If you need information about additional products available from Dell, or if you would like to place an order, visit the Dell website at www.dell.com. For the telephone number to call for your region or to speak to a sales specialist, see "Contacting Dell" on page 141.

Returning Items for Warranty Repair or Credit

Prepare all items being returned, whether for repair or credit, as follows:

- 1 Call Dell to obtain a Return Material Authorization Number, and write it clearly and prominently on the outside of the box.

For the telephone number to call for your region, see "Contacting Dell" on page 141.

- 2 Include a copy of the invoice and a letter describing the reason for the return.
- 3 Include a copy of the Diagnostics Checklist (see "Diagnostics Checklist" on page 140), indicating the tests that you have run and any error messages reported by the Dell Diagnostics (see "Dell Diagnostics" on page 95).
- 4 Include any accessories that belong with the item(s) being returned (power cables, software floppy disks, guides, and so on) if the return is for credit.
- 5 Pack the equipment to be returned in the original (or equivalent) packing materials.

You are responsible for paying shipping expenses. You are also responsible for insuring any product returned, and you assume the risk of loss during shipment to Dell. Collect On Delivery (C.O.D.) packages are not accepted.

Returns that are missing any of the preceding requirements will be refused at Dell's receiving dock and returned to you.

Before You Call



NOTE: Have your Express Service Code ready when you call. The code helps Dell's automated-support telephone system direct your call more efficiently. You may also be asked for your Service Tag (located on the back or bottom of your computer).

Remember to fill out the Diagnostics Checklist (see "Diagnostics Checklist" on page 140). If possible, turn on your computer before you call Dell for assistance and call from a telephone at or near the computer. You may be asked to type some commands at the keyboard, relay detailed information during operations, or try other troubleshooting steps possible only at the computer itself. Ensure that the computer documentation is available.



CAUTION: Before working inside your computer, follow the safety instructions in your *Product Information Guide*.

Diagnostics Checklist

Name:

Date:

Address:

Phone number:

Service Tag (bar code on the back or bottom of the computer):

Express Service Code:

Return Material Authorization Number (if provided by Dell support technician):

Operating system and version:

Devices:

Expansion cards:

Are you connected to a network? Yes No

Network, version, and network adapter:

Programs and versions:

See your operating system documentation to determine the contents of the system's start-up files. If the computer is connected to a printer, print each file. Otherwise, record the contents of each file before calling Dell.

Error message, beep code, or diagnostic code:

Description of problem and troubleshooting procedures you performed:

Contacting Dell

For customers in the United States, call 800-WWW-DELL (800-999-3355).



NOTE: If you do not have an active Internet connection, you can find contact information on your purchase invoice, packing slip, bill, or Dell product catalog.

Dell provides several online and telephone-based support and service options. Availability varies by country and product, and some services may not be available in your area. To contact Dell for sales, technical support, or customer service issues:

- 1 Visit support.dell.com.
- 2 Verify your country or region in the **Choose A Country/Region** drop-down menu at the bottom of the page.
- 3 Click **Contact Us** on the left side of the page.
- 4 Select the appropriate service or support link based on your need.
- 5 Choose the method of contacting Dell that is convenient for you.

Appendix

FCC Notice (U.S. Only)

FCC Class B

This equipment generates, uses, and can radiate radio frequency energy and, if not installed and used in accordance with the manufacturer's instruction manual, may cause interference with radio and television reception. This equipment has been tested and found to comply with the limits for a Class B digital device pursuant to Part 15 of the FCC Rules.

This device complies with Part 15 of the FCC Rules. Operation is subject to the following two conditions:

- 1 This device may not cause harmful interference.
- 2 This device must accept any interference received, including interference that may cause undesired operation.

 **NOTICE:** The FCC regulations provide that changes or modifications not expressly approved by Dell Inc. could void your authority to operate this equipment.

These limits are designed to provide reasonable protection against harmful interference in a residential installation. However, there is no guarantee that interference will not occur in a particular installation. If this equipment does cause harmful interference with radio or television reception, which can be determined by turning the equipment off and on, you are encouraged to try to correct the interference by one or more of the following measures:

- Reorient the receiving antenna.
- Relocate the system with respect to the receiver.
- Move the system away from the receiver.
- Plug the system into a different outlet so that the system and the receiver are on different branch circuits.

If necessary, consult a representative of Dell Inc. or an experienced radio/television technician for additional suggestions.

The following information is provided on the device or devices covered in this document in compliance with the FCC regulations:

- Product name: Dell™ XPS™ 630i
- Model number: DCDR01
- Company name:
Dell Inc.
Worldwide Regulatory Compliance & Environmental Affairs
One Dell Way
Round Rock, TX 78682 USA
512-338-4400



NOTE: For further regulatory information, see your *Product Information Guide*.

Macrovision

This product incorporates copy protection technology that is protected by U.S. and foreign patents, including patent numbers 5,315,448 and 6,836,549, and other intellectual property rights. The use of Macrovision's copy protection technology in the product must be authorized by Macrovision. Reverse engineering or disassembly is prohibited.

Glossary

Terms in this Glossary are provided for informational purposes only and may or may not describe features included with your particular computer.

A

AC — alternating current — The form of electricity that powers your computer when you plug the AC adapter power cable in to an electrical outlet.

ACPI — advanced configuration and power interface — A power management specification that enables Microsoft® Windows® operating systems to put a computer in standby or hibernate mode to conserve the amount of electrical power allocated to each device attached to the computer.

AGP — accelerated graphics port — A dedicated graphics port that allows system memory to be used for video-related tasks. AGP delivers a smooth, true-color video image because of the faster interface between the video circuitry and the computer memory.

AHCI — Advanced Host Controller Interface — An interface for a SATA hard drive Host Controller which allows the storage driver to enable technologies such as Native Command Queuing (NCQ) and hot plug.

ALS — ambient light sensor — A feature that helps to control display brightness.

antivirus software — A program designed to identify, quarantine, and/or delete viruses from your computer.

ASF — alert standards format — A standard to define a mechanism for reporting hardware and software alerts to a management console. ASF is designed to be platform- and operating system-independent.

B

battery life span — The length of time (years) during which a portable computer battery is able to be depleted and recharged.

battery operating time — The length of time (minutes or hours) that a portable computer battery powers the computer.

BIOS — basic input/output system — A program (or utility) that serves as an interface between the computer hardware and the operating system. Unless you understand what effect these settings have on the computer, do not change them. Also referred to as *system setup*.

bit — The smallest unit of data interpreted by your computer.

Blu-ray Disc™ (BD)— An optical storage technology offering storage capacity of up to 50 GB, full 1080p video resolution (HDTV required), and as many as 7.1 channels of native, uncompressed surround sound.

Bluetooth® wireless technology — A wireless technology standard for short-range (9 m [29 feet]) networking devices that allows for enabled devices to automatically recognize each other.

boot sequence — Specifies the order of the devices from which the computer attempts to boot.

bootable media — A CD, DVD, or floppy disk that you can use to start your computer. In case your hard drive is damaged or your computer has a virus, ensure that you always have a bootable CD, DVD, or floppy disk available. Your *Drivers and Utilities* media is an example of bootable media.

bps — bits per second — The standard unit for measuring data transmission speed.

BTU — British thermal unit — A measurement of heat output.

bus — A communication pathway between the components in your computer.

bus speed — The speed, given in MHz, that indicates how fast a bus can transfer information.

byte — The basic data unit used by your computer. A byte is usually equal to 8 bits.

C

C — Celsius — A temperature measurement scale where 0° is the freezing point and 100° is the boiling point of water.

cache — A special high-speed storage mechanism which can be either a reserved section of main memory or an independent high-speed storage device. The cache enhances the efficiency of many processor operations.

L1 cache — Primary cache stored inside the processor.

L2 cache — Secondary cache which can either be external to the processor or incorporated into the processor architecture.

carnet — An international customs document that facilitates temporary imports into foreign countries. Also known as a *merchandise passport*.

CD-R — CD recordable — A recordable version of a CD. Data can be recorded only once onto a CD-R. Once recorded, the data cannot be erased or written over.

CD-RW — CD rewritable — A rewritable version of a CD. Data can be written to a CD-RW disc, and then erased and written over (rewritten).

CD-RW drive — A drive that can read CDs and write to CD-RW (rewritable CDs) and CD-R (recordable CDs) discs. You can write to CD-RW discs multiple times, but you can write to CD-R discs only once.

CD-RW/DVD drive — A drive, sometimes referred to as a combo drive, that can read CDs and DVDs and write to CD-RW (rewritable CDs) and CD-R (recordable CDs) discs. You can write to CD-RW discs multiple times, but you can write to CD-R discs only once.

clock speed — The speed, given in MHz, that indicates how fast computer components that are connected to the system bus operate.

CMOS — A type of electronic circuit. Computers use a small amount of battery-powered CMOS memory to hold date, time, and system setup options.

COA — Certificate of Authenticity — The Windows alpha-numeric code located on a sticker on your computer. Also referred to as the *Product Key* or *Product ID*.

Consumer IR Port — A port on the front of the computer that allows certain software applications to be controlled by the Dell Travel Remote in some systems. In other systems, this port allows you to transfer data between the computer and infrared-compatible devices without using a cable connection.

Control Panel — A Windows utility that allows you to modify operating system and hardware settings, such as display settings.

controller — A chip that controls the transfer of data between the processor and memory or between the processor and devices.

CRIMM — continuity rambus in-line memory module — A special module that has no memory chips and is used to fill unused RIMM slots.

cursor — The marker on a display or screen that shows where the next keyboard, touch pad, or mouse action will occur. It often is a blinking solid line, an underline character, or a small arrow.

D

DDR SDRAM — double-data-rate SDRAM — A type of SDRAM that doubles the data burst cycle, improving system performance.

DDR2 SDRAM — double-data-rate 2 SDRAM — A type of DDR SDRAM that uses a 4-bit prefetch and other architectural changes to boost memory speed to over 400 MHz.

Dell Travel Remote — A small remote control stored in the portable computer's ExpressCard slot which provides simple functionality for enjoying multimedia content.

device driver — See *driver*.

DIMM — dual in-line memory module — A circuit board with memory chips that connects to a memory module on the system board.

DIN connector — A round, six-pin connector that conforms to DIN (Deutsche Industrie-Norm) standards; it is typically used to connect PS/2 keyboard or mouse cable connectors.

disk striping — A technique for spreading data over multiple disk drives. Disk striping can speed up operations that retrieve data from disk storage. Computers that use disk striping generally allow the user to select the data unit size or stripe width.

DMA — direct memory access — A channel that allows certain types of data transfer between RAM and a device to bypass the processor.

docking device — provides port replication, cable management, and security features to adapt your notebook to a desktop workspace.

DMTF — Distributed Management Task Force — A consortium of hardware and software companies who develop management standards for distributed desktop, network, enterprise, and Internet environments.

domain — A group of computers, programs, and devices on a network that are administered as a unit with common rules and procedures for use by a specific group of users. A user logs on to the domain to gain access to the resources.

DRAM — dynamic random-access memory — Memory that stores information in integrated circuits containing capacitors.

driver — Software that allows the operating system to control a device such as a printer. Many devices do not work properly if the correct driver is not installed in the computer.

DSL — Digital Subscriber Line — A technology that provides a constant, high-speed Internet connection through an analog telephone line.

dual-core — A technology in which two physical computational units exist inside a single processor package, thereby increasing computing efficiency and multi-tasking ability.

dual display mode — A display setting that allows you to use a second monitor as an extension of your display. Also referred to as *extended display mode*.

DVD-R — DVD recordable — A recordable version of a DVD. Data can be recorded only once onto a DVD-R. Once recorded, the data cannot be erased or written over.

DVD+RW — DVD rewritable — A rewritable version of a DVD. Data can be written to a DVD+RW disc, and then erased and written over (rewritten). (DVD+RW technology is different from DVD-RW technology.)

DVD+RW drive — drive that can read DVDs and most CD media and write to DVD+RW (rewritable DVDs) discs.

DVI — digital video interface — A standard for digital transmission between a computer and a digital video display.

E

ECC — error checking and correction — A type of memory that includes special circuitry for testing the accuracy of data as it passes in and out of memory.

ECP — extended capabilities port — A parallel connector design that provides improved bidirectional data transmission. Similar to EPP, ECP uses direct memory access to transfer data and often improves performance.

EIDE — enhanced integrated device electronics — An improved version of the IDE interface for hard drives and CD drives.

EMI — electromagnetic interference — Electrical interference caused by electromagnetic radiation.

ENERGY STAR® — Environmental Protection Agency requirements that decrease the overall consumption of electricity.

EPP — enhanced parallel port — A parallel connector design that provides bidirectional data transmission.

ESD — electrostatic discharge — A rapid discharge of static electricity. ESD can damage integrated circuits found in computer and communications equipment.

expansion card — A circuit board that installs in an expansion slot on the system board in some computers, expanding the capabilities of the computer. Examples include video, modem, and sound cards.

expansion slot — A connector on the system board (in some computers) where you insert an expansion card, connecting it to the system bus.

ExpressCard — A removable I/O card adhering to the PCMCIA standard. Modems and network adapters are common types of ExpressCards. ExpressCards support both the PCI Express and USB 2.0 standard.

Express Service Code — A numeric code located on a sticker on your Dell™ computer. Use the Express Service Code when contacting Dell for assistance. Express Service Code service may not be available in some countries.

extended display mode — A display setting that allows you to use a second monitor as an extension of your display. Also referred to as *dual display mode*.

extended PC Card — A PC Card that extends beyond the edge of the PC Card slot when installed.

F

Fahrenheit — A temperature measurement scale where 32° is the freezing point and 212° is the boiling point of water.

FBD — fully-buffered DIMM — A DIMM with DDR2 DRAM chips and an Advanced Memory Buffer (AMB) that speeds communication between the DDR2 SDRAM chips and the system.

FCC — Federal Communications Commission — A U.S. agency responsible for enforcing communications-related regulations that state how much radiation computers and other electronic equipment can emit.

fingerprint reader — A strip sensor that uses your unique fingerprint to authenticate your user identity to help secure your computer.

folder — A term used to describe space on a disk or drive where files are organized and grouped. Files in a folder can be viewed and ordered in various ways, such as alphabetically, by date, and by size.

format — The process that prepares a drive or disk for file storage. When a drive or disk is formatted, the existing information on it is lost.

FSB — front side bus — The data path and physical interface between the processor and RAM.

FTP — file transfer protocol — A standard Internet protocol used to exchange files between computers connected to the Internet.

G

G — gravity — A measurement of weight and force.

GB — gigabyte — A measurement of data storage that equals 1024 MB (1,073,741,824 bytes). When used to refer to hard drive storage, the term is often rounded to 1,000,000,000 bytes.

GHz — gigahertz — A measurement of frequency that equals one thousand million Hz, or one thousand MHz. The speeds for computer processors, buses, and interfaces are often measured in GHz.

graphics mode — A video mode that can be defined as x horizontal pixels by y vertical pixels by z colors. Graphics modes can display an unlimited variety of shapes and fonts.

GUI — graphical user interface — Software that interacts with the user by means of menus, windows, and icons. Most programs that operate on the Windows operating systems are GUIs.

H

hard drive — A drive that reads and writes data on a hard disk. The terms hard drive and hard disk are often used interchangeably.

heat sink — A metal plate on some processors that helps dissipate heat.

hibernate mode — A power management mode that saves everything in memory to a reserved space on the hard drive and then turns off the computer. When you restart the computer, the memory information that was saved to the hard drive is automatically restored.

HTTP — hypertext transfer protocol — A protocol for exchanging files between computers connected to the Internet.

Hyper-Threading — Hyper-Threading is an Intel technology that can enhance overall computer performance by allowing one physical processor to function as two logical processors, capable of performing certain tasks simultaneously.

Hz — hertz — A unit of frequency measurement that equals 1 cycle per second. Computers and electronic devices are often measured in kilohertz (kHz), megahertz (MHz), gigahertz (GHz), or terahertz (THz).

I

iAMT — Intel® Active Management Technology — Delivers more secure systems management capabilities, regardless of whether the computer is turned on or off, or the operating system is not responding.

IC — integrated circuit — A semiconductor wafer, or chip, on which thousands or millions of tiny electronic components are fabricated for use in computer, audio, and video equipment.

IDE — integrated device electronics — An interface for mass storage devices in which the controller is integrated into the hard drive or CD drive.

IEEE 1394 — Institute of Electrical and Electronics Engineers, Inc. — A high-performance serial bus used to connect IEEE 1394-compatible devices, such as digital cameras and DVD players, to the computer.

infrared sensor — A port that allows you to transfer data between the computer and infrared-compatible devices without using a cable connection.

integrated — Usually refers to components that are physically located on the computer's system board. Also referred to as *built-in*.

I/O — input/output — An operation or device that enters and extracts data from your computer. Keyboards and printers are I/O devices.

I/O address — An address in RAM that is associated with a specific device (such as a serial connector, parallel connector, or expansion slot) and allows the processor to communicate with that device.

IrDA — Infrared Data Association — The organization that creates international standards for infrared communications.

IRQ — interrupt request — An electronic pathway assigned to a specific device so that the device can communicate with the processor. Each device connection must be assigned an IRQ. Although two devices can share the same IRQ assignment, you cannot operate both devices simultaneously.

ISP — Internet service provider — A company that allows you to access its host server to connect directly to the Internet, send and receive e-mail, and access websites. The ISP typically provides you with a software package, user name, and access phone numbers for a fee.

K

Kb — kilobit — A unit of data that equals 1024 bits. A measurement of the capacity of memory integrated circuits.

KB — kilobyte — A unit of data that equals 1024 bytes but is often referred to as 1000 bytes.

key combination — A command requiring you to press multiple keys at the same time.

kHz — kilohertz — A measurement of frequency that equals 1000 Hz.

L

LAN — local area network — A computer network covering a small area. A LAN usually is confined to a building or a few nearby buildings. A LAN can be connected to another LAN over any distance through telephone lines and radio waves to form a wide area network (WAN).

LCD — liquid crystal display — The technology used by portable computer and flat-panel displays.

LED — light-emitting diode — An electronic component that emits light to indicate the status of the computer.

local bus — A data bus that provides a fast throughput for devices to the processor.

LPT — line print terminal — The designation for a parallel connection to a printer or other parallel device.

M

Mb — megabit — A measurement of memory chip capacity that equals 1024 Kb.

Mbps — megabits per second — One million bits per second. This measurement is typically used for transmission speeds for networks and modems.

MB — megabyte — A measurement of data storage that equals 1,048,576 bytes. 1 MB equals 1024 KB. When used to refer to hard drive storage, the term is often rounded to 1,000,000 bytes.

MB/sec — megabytes per second — One million bytes per second. This measurement is typically used for data transfer ratings.

media bay — A bay that supports devices such as optical drives, a second battery, or a Dell TravelLite™ module.

memory — A temporary data storage area inside your computer. Because the data in memory is not permanent, it is recommended that you frequently save your files while you are working on them, and always save your files before you shut down the computer. Your computer can contain several different forms of memory, such as RAM, ROM, and video memory. Frequently, the word memory is used as a synonym for RAM.

memory address — A specific location where data is temporarily stored in RAM.

memory mapping — The process by which the computer assigns memory addresses to physical locations at start-up. Devices and software can then identify information that the processor can access.

memory module — A small circuit board containing memory chips, which connects to the system board.

MHz — megahertz — A measure of frequency that equals 1 million cycles per second. The speeds for computer processors, buses, and interfaces are often measured in MHz.

Mini PCI — A standard for integrated peripheral devices with an emphasis on communications such as modems and NICs. A Mini PCI card is a small external card that is functionally equivalent to a standard PCI expansion card.

Mini-Card — A small card designed for integrated peripherals, such as communication NICs. The Mini-Card is functionally equivalent to a standard PCI expansion card.

modem — A device that allows your computer to communicate with other computers over analog telephone lines. Three types of modems include: external, PC Card, and internal. You typically use your modem to connect to the Internet and exchange e-mail.

module bay — See *media bay*.

MP — megapixel — A measure of image resolution used for digital cameras.

ms — millisecond — A measure of time that equals one thousandth of a second. Access times of storage devices are often measured in ms.

N

network adapter — A chip that provides network capabilities. A computer may include a network adapter on its system board, or it may contain a PC Card with an adapter on it. A network adapter is also referred to as a *NIC* (network interface controller).

NIC — See *network adapter*.

notification area — The section of the Windows taskbar that contains icons for providing quick access to programs and computer functions, such as the clock, volume control, and print status. Also referred to as *system tray*.

ns — nanosecond — A measure of time that equals one billionth of a second.

NVRAM — nonvolatile random access memory — A type of memory that stores data when the computer is turned off or loses its external power source. NVRAM is used for maintaining computer configuration information such as date, time, and other system setup options that you can set.

O

optical drive — A drive that uses optical technology to read or write data from CDs, DVDs, or DVD+RWs. Example of optical drives include CD drives, DVD drives, CD-RW drives, and CD-RW/DVD combo drives.

P

parallel connector — An I/O port often used to connect a parallel printer to your computer. Also referred to as an *LPT port*.

partition — A physical storage area on a hard drive that is assigned to one or more logical storage areas known as logical drives. Each partition can contain multiple logical drives.

PC Card — A removable I/O card adhering to the PCMCIA standard. Modems and network adapters are common types of PC Cards.

PCI — peripheral component interconnect — PCI is a local bus that supports 32- and 64-bit data paths, providing a high-speed data path between the processor and devices such as video, drives, and networks.

PCI Express — A modification to the PCI interface that boosts the data transfer rate between the processor and the devices attached to it. PCI Express can transfer data at speeds from 250 MB/sec to 4 GB/sec. If the PCI Express chip set and the device are capable of different speeds, they will operate at the slower speed.

PCMCIA — Personal Computer Memory Card International Association — The organization that establishes standards for PC Cards.

PIO — programmed input/output — A method of transferring data between two devices through the processor as part of the data path.

pixel — A single point on a display screen. Pixels are arranged in rows and columns to create an image. A video resolution, such as 800 x 600, is expressed as the number of pixels across by the number of pixels up and down.

Plug-and-Play — The ability of the computer to automatically configure devices. Plug and Play provides automatic installation, configuration, and compatibility with existing hardware if the BIOS, operating system, and all devices are Plug and Play compliant.

POST — power-on self-test — Diagnostics programs, loaded automatically by the BIOS, that perform basic tests on the major computer components, such as memory, hard drives, and video. If no problems are detected during POST, the computer continues the start-up.

processor — A computer chip that interprets and executes program instructions. Sometimes the processor is referred to as the CPU (central processing unit).

PS/2 — personal system/2 — A type of connector for attaching a PS/2-compatible keyboard, mouse, or keypad.

PXE — pre-boot execution environment — A WfM (Wired for Management) standard that allows networked computers that do not have an operating system to be configured and started remotely.

R

RAID — redundant array of independent disks — A method of providing data redundancy. Some common implementations of RAID include RAID 0, RAID 1, RAID 5, RAID 10, and RAID 50.

RAM — random-access memory — The primary temporary storage area for program instructions and data. Any information stored in RAM is lost when you shut down your computer.

readme file — A text file included with a software package or hardware product. Typically, readme files provide installation information and describe new product enhancements or corrections that have not yet been documented.

read-only — Data and/or files you can view but cannot edit or delete. A file can have read-only status if:

- It resides on a physically write-protected floppy disk, CD, or DVD.
- It is located on a network in a directory and the system administrator has assigned rights only to specific individuals.

refresh rate — The frequency, measured in Hz, at which your screen's horizontal lines are recharged (sometimes also referred to as its *vertical frequency*). The higher the refresh rate, the less video flicker can be seen by the human eye.

resolution — The sharpness and clarity of an image produced by a printer or displayed on a monitor. The higher the resolution, the sharper the image.

RFI — radio frequency interference — Interference that is generated at typical radio frequencies, in the range of 10 kHz to 100,000 MHz. Radio frequencies are at the lower end of the electromagnetic frequency spectrum and are more likely to have interference than the higher frequency radiations, such as infrared and light.

ROM — read-only memory — Memory that stores data and programs that cannot be deleted or written to by the computer. ROM, unlike RAM, retains its contents after you shut down your computer. Some programs essential to the operation of your computer reside in ROM.

RPM — revolutions per minute — The number of rotations that occur per minute. Hard drive speed is often measured in rpm.

RTC — real time clock — Battery-powered clock on the system board that keeps the date and time after you shut down the computer.

RTCST — real-time clock reset — A jumper on the system board of some computers that can often be used for troubleshooting problems.

S

SAS — serial attached SCSI — A faster, serial version of the SCSI interface (as opposed to the original SCSI parallel architecture).

SATA — serial ATA — A faster, serial version of the ATA (IDE) interface.

ScanDisk — A Microsoft utility that checks files, folders, and the hard disk's surface for errors. ScanDisk often runs when you restart the computer after it has stopped responding.

SCSI — small computer system interface — A high-speed interface used to connect devices to a computer, such as hard drives, CD drives, printers, and scanners. The SCSI can connect many devices using a single controller. Each device is accessed by an individual identification number on the SCSI controller bus.

SDRAM — synchronous dynamic random-access memory — A type of DRAM that is synchronized with the optimal clock speed of the processor.

serial connector — An I/O port often used to connect devices such as a handheld digital device or digital camera to your computer.

Service Tag — A bar code label on your computer that identifies your computer when you access Dell Support at support.dell.com or when you call Dell for customer service or technical support.

setup program — A program that is used to install and configure hardware and software. The **setup.exe** or **install.exe** program comes with most Windows software packages. *Setup program* differs from *system setup*.

shortcut — An icon that provides quick access to frequently used programs, files, folders, and drives. When you place a shortcut on your Windows desktop and double-click the icon, you can open its corresponding folder or file without having to find it first. Shortcut icons do not change the location of files. If you delete a shortcut, the original file is not affected. Also, you can rename a shortcut icon.

SIM — Subscriber Identity Module — A SIM card contains a microchip that encrypts voice and data transmissions. SIM cards can be used in phones or portable computers.

smart card — A card that is embedded with a processor and a memory chip. Smart cards can be used to authenticate a user on computers equipped for smart cards.

S/PDIF — Sony/Philips Digital Interface — An audio transfer file format that allows the transfer of audio from one file to another without converting it to and from an analog format, which could degrade the quality of the file.

standby mode — A power management mode that shuts down all unnecessary computer operations to save energy.

Strike Zone™ — Reinforced area of the platform base that protects the hard drive by acting as a dampening device when a computer experiences resonating shock or is dropped (whether the computer is on or off).

surge protectors — Prevent voltage spikes, such as those that may occur during an electrical storm, from entering the computer through the electrical outlet. Surge protectors do not protect against lightning strikes or against brownouts, which occur when the voltage drops more than 20 percent below the normal AC-line voltage level.

Network connections cannot be protected by surge protectors. Always disconnect the network cable from the network connector during electrical storms.

SVGA — super-video graphics array — A video standard for video cards and controllers. Typical SVGA resolutions are 800 x 600 and 1024 x 768.

The number of colors and resolution that a program displays depends on the capabilities of the monitor, the video controller and its drivers, and the amount of video memory installed in the computer.

S-video TV-out — A connector used to attach a TV or digital audio device to the computer.

SXGA — super-extended graphics array — A video standard for video cards and controllers that supports resolutions up to 1280 x 1024.

SXGA+ — super-extended graphics array plus — A video standard for video cards and controllers that supports resolutions up to 1400 x 1050.

system board — The main circuit board in your computer. Also known as the *motherboard*.

system setup — A utility that serves as an interface between the computer hardware and the operating system. System setup allows you to configure user-selectable options in the BIOS, such as date and time or system password. Unless you understand what effect the settings have on the computer, do not change the settings for this program.

T

TAPI — telephony application programming interface — Enables Windows programs to operate with a wide variety of telephony devices, including voice, data, fax, and video.

text editor — A program used to create and edit files that contain only text; for example, Windows Notepad uses a text editor. Text editors do not usually provide word wrap or formatting functionality (the option to underline, change fonts, and so on).

travel module — A plastic device designed to fit inside the module bay of a portable computer to reduce the weight of the computer.

U

UAC — user account control — Windows Vista® security feature that, when enabled, provides an added layer of security between user accounts and access to operating system settings.

UMA — unified memory allocation — System memory dynamically allocated to video.

UPS — uninterruptible power supply — A backup power source used when the electrical power fails or drops to an unacceptable voltage level. A UPS keeps a computer running for a limited amount of time when there is no electrical power. UPS systems typically provide surge suppression and may also provide voltage regulation. Small UPS systems provide battery power for a few minutes to enable you to shut down your computer.

USB — universal serial bus — A hardware interface for a low-speed device such as a USB-compatible keyboard, mouse, joystick, scanner, set of speakers, printer, broadband devices (DSL and cable modems), imaging devices, or storage devices. Devices are plugged directly in to a 4-pin socket on your computer or in to a multi-port hub that plugs in to your computer. USB devices can be connected and disconnected while the computer is turned on, and they can also be daisy-chained together.

UTP — unshielded twisted pair — Describes a type of cable used in most telephone networks and some computer networks. Pairs of unshielded wires are twisted to protect against electromagnetic interference, rather than relying on a metal sheath around each pair of wires to protect against interference.

UXGA — ultra extended graphics array — A video standard for video cards and controllers that supports resolutions up to 1600 x 1200.

V

video controller — The circuitry on a video card or on the system board (in computers with an integrated video controller) that provides the video capabilities—in combination with the monitor—for your computer.

video memory — Memory that consists of memory chips dedicated to video functions. Video memory is usually faster than system memory. The amount of video memory installed primarily influences the number of colors that a program can display.

video mode — A mode that describes how text and graphics are displayed on a monitor. Graphics-based software, such as Windows operating systems, displays in video modes that can be defined as x horizontal pixels by y vertical pixels by z colors. Character-based software, such as text editors, displays in video modes that can be defined as x columns by y rows of characters.

video resolution — See *resolution*.

virus — A program that is designed to inconvenience you or to destroy data stored on your computer. A virus program moves from one computer to another through an infected disk, software downloaded from the Internet, or e-mail attachments. When an infected program starts, its embedded virus also starts.

A common type of virus is a boot virus, which is stored in the boot sectors of a floppy disk. If the floppy disk is left in the drive when the computer is shut down and then turned on, the computer is infected when it reads the boot sectors of the floppy disk expecting to find the operating system. If the computer is infected, the boot virus may replicate itself onto all the floppy disks that are read or written in that computer until the virus is eradicated.

V — volt — The measurement of electric potential or electromotive force. One V appears across a resistance of 1 ohm when a current of 1 ampere flows through that resistance.

W

W — watt — The measurement of electrical power. One W is 1 ampere of current flowing at 1 volt.

WHr — watt-hour — A unit of measure commonly used to indicate the approximate capacity of a battery. For example, a 66-WHr battery can supply 66 W of power for 1 hour or 33 W for 2 hours.

wallpaper — The background pattern or picture on the Windows desktop. Change your wallpaper through the Windows Control Panel. You can also scan in your favorite picture and make it wallpaper.

WLAN — wireless local area network. A series of interconnected computers that communicate with each other over the air waves using access points or wireless routers to provide Internet access.

write-protected — Files or media that cannot be changed. Use write-protection when you want to protect data from being changed or destroyed. To write-protect a 3.5-inch floppy disk, slide its write-protect tab to the open position.

WWAN — wireless wide area network. A wireless high-speed data network using cellular technology and covering a much larger geographic area than WLAN.

WXGA — wide-aspect extended graphics array — A video standard for video cards and controllers that supports resolutions up to 1280 x 800.

X

XGA — extended graphics array — A video standard for video cards and controllers that supports resolutions up to 1024 x 768.

Z

ZIF — zero insertion force — A type of socket or connector that allows a computer chip to be installed or removed with no stress applied to either the chip or its socket.

Zip — A popular data compression format. Files that have been compressed with the Zip format are called Zip files and usually have a filename extension of **.zip**. A special kind of zipped file is a self-extracting file, which has a filename extension of **.exe**. You can unzip a self-extracting file by double-clicking it.

Zip drive — A high-capacity floppy drive developed by Iomega Corporation that uses 3.5-inch removable disks called Zip disks. Zip disks are slightly larger than regular floppy disks, about twice as thick, and hold up to 100 MB of data.

Index

A

- audio device
 - connecting, 48
 - enabling, 62

B

- battery
 - problems, 101
- beep codes, 90
- BIOS, 77
- boot sequence
 - changing, 82-83
 - option settings, 82
- booting
 - to a USB device, 82

C

- CD-RW drive
 - problems, 103
- CDs, 45
 - operating system, 16
 - playing, 43
- Check Disk, 103
- CMOS settings
 - clearing, 87

- computer
 - beep codes, 90
 - crashes, 106-107
 - restore to previous state, 122
 - specifications, 129
 - stops responding, 106
- conflicts
 - software and hardware incompatibilities, 95, 121
- connecting
 - audio device, 48
 - TV, 48
- contacting Dell, 141
- copying CDs
 - general information, 45
 - helpful tips, 47
 - how to, 45
- copying DVDs
 - general information, 45
 - helpful tips, 47
 - how to, 45

D

- Dell
 - contacting, 141
- Dell Diagnostics, 95
- Dell support site, 14
- DellConnect, 136

- diagnostics
 - beep codes, 90
 - Dell, 95
- documentation
 - End User License Agreement, 12
 - ergonomics, 12
 - online, 14
 - Product Information Guide, 12
 - regulatory, 12
 - safety, 12
 - warranty, 12
- Dolby headphones, setting up, 62
- drivers, 117
 - about, 117
 - identifying, 117
 - reinstalling, 118
- drives
 - problems, 102
 - RAID, 67
- DVDs, 45
 - playing, 43

E

- End User License Agreement, 12
- ergonomics information, 12
- error messages
 - beep codes, 90
 - problems, 103

F

- Factory Image Restore, 124, 126
- Files and Settings Transfer Wizard, 29
- Flex Bay drive
 - Media Card Reader, 18

H

- hard drive
 - problems, 103
- hardware
 - beep codes, 90
 - conflicts, 95, 121
 - Dell Diagnostics, 95
 - drives, RAID configuration, 67
- Hardware Troubleshooter, 95, 121
- hibernate mode, 39, 41-42

I

- IEEE 1394
 - problems, 104
- Internet connection
 - about, 27
 - options, 27
 - setting up, 28
- IRQ conflicts, 95, 121

K

- keyboard
 - problems, 105

L

- labels
 - Microsoft Windows, 13
 - Service Tag, 13

M

- media card reader
 - using, 64
- memory
 - problems, 108
- messages
 - error, 103
- monitor
 - blank, 113
 - clone mode, 37
 - connect DVI, 35-36
 - connect TV, 35, 37
 - connect two, 35-36
 - connect VGA, 35-36
 - display settings, 37
 - extended desktop mode, 37
 - hard to read, 113
- mouse
 - problems, 108

N

- network
 - problems, 109

O

- operating system
 - media, 127
 - reinstalling, 16
- Operating System CD, 16
- optical drive
 - problems, 102

P

- password
 - clearing, 85
 - jumper, 85
- PC Restore, 124
- phone numbers, 141
- playing CDs, 43
- playing DVDs, 43
- power
 - button, 18
 - hibernate mode, 39, 41-42
 - line conditioners
 - options, 40
 - options, schemes, 40
 - problems, 110
 - protection devices
 - sleep mode, 42
 - standby mode, 39
 - surge protectors
 - UPS
- power light, 115
 - conditions, 110
- power options properties, 40

- printer
 - cable, 34
 - connecting, 27, 33
 - problems, 110
 - setting up, 27, 33
 - USB, 34

- problems
 - battery, 101
 - beep codes, 90
 - blue screen, 107
 - CD-RW drive, 103
 - computer crashes, 106-107
 - computer stops responding, 106
 - conflicts, 95, 121
 - Dell Diagnostics, 95
 - drives, 102
 - error messages, 103
 - general, 106
 - hard drive, 103
 - IEEE 1394, 104
 - keyboard, 105
 - memory, 108
 - monitor hard to read, 113
 - monitor is blank, 113
 - mouse, 108
 - network, 109
 - optical drive, 102
 - power, 110
 - power light conditions, 110
 - printer, 110
 - program crashes, 106
 - program stops responding, 106
 - restore to previous state, 122
 - scanner, 111
 - screen hard to read, 113

- problems (*continued*)
 - screen is blank, 113
 - software, 106-107
 - volume adjusting, 112
- Product Information Guide, 12

R

- RAID
 - configuring, 67
- RAID array, creating, 71
- regulatory information, 12
- ResourceCD
 - Dell Diagnostics, 95

S

- S.M.A.R.T., 94
- S/PDIF digital audio
 - enabling, 62
- safety instructions, 12
- scanner
 - problems, 111-112
- Service Tag, 13
- settings
 - system setup, 77
- sleep mode
 - about, 42
- software
 - conflicts, 95, 121
 - problems, 106-107

- specifications, 129
- standby mode, 39
- Starting the Dell Diagnostics
 - From the Drivers and Utilities CD, 97
- Starting the Dell Diagnostics
 - From Your Hard Drive, 96
- support
 - contacting Dell, 141
- support website, 14
- System Restore, 122
- system setup, 77
 - entering, 77
 - options, 79
 - screens, 77

T

- telephone numbers, 141
- transferring information to a new computer, 29
- troubleshooting
 - conflicts, 95, 121
 - Dell Diagnostics, 95
 - Hardware Troubleshooter, 95, 121
 - restore to previous state, 122
- TV
 - connect to computer, 35, 37
 - connecting, 48

U

- uninterruptible power supply.
 - See *UPS*
- UPS
- USB
 - booting to devices, 82

V

- volume
 - adjusting, 112

W

- warranty information, 12
- Windows Vista
 - Factory Image Restore, 124
 - hibernate mode, 42
 - sleep mode, 42
 - System Restore, 122
- Windows XP
 - Device Driver Rollback, 118
 - Files and Settings Transfer Wizard, 29
 - Hardware Troubleshooter, 95, 121
 - hibernate mode, 39
 - PC Restore, 124
 - reinstalling, 16
 - standby mode, 39
 - System Restore, 122
- wizards
 - Files and Settings Transfer Wizard, 29

