

# INSPIRON™

## SETUP GUIDE



YOURS IS HERE



# INSPIRON™

## SETUP GUIDE

Models DCME and DCMF

## Notes, Cautions, and Warnings



**NOTE:** A NOTE indicates important information that helps you make better use of your computer.



**CAUTION:** A CAUTION indicates either potential damage to hardware or loss of data and tells you how to avoid the problem.



**WARNING:** A WARNING indicates a potential for property damage, personal injury, or death.

If you purchased a Dell™ n Series computer, any references in this document to Microsoft® Windows® operating systems are not applicable.

---

**Information in this document is subject to change without notice.**

**© 2009 Dell Inc. All rights reserved.**

Reproduction of these materials in any manner whatsoever without the written permission of Dell Inc. is strictly forbidden.

Trademarks used in this text: *Dell*, the *DELL* logo, *YOURS IS HERE*, *Inspiron*, *Dell On Call*, and *DellConnect* are trademarks of Dell Inc.; *Intel*, *Pentium*, and *Celeron* are registered trademarks and *Core* is a trademark of Intel Corporation in the U.S. and other countries; *AMD*, *AMD Sempron*, *AMD Athlon*, and *AMD Phenom* are trademarks of Advanced Micro Devices, Inc; *Microsoft*, *Windows*, *Windows Vista*, and the *Windows Vista* start button logo are either trademarks or registered trademarks of Microsoft Corporation in the United States and/or other countries; *Blu-ray Disc* is a trademark of the Blu-ray Disc Association; *Bluetooth* is a registered trademark owned by Bluetooth SIG, Inc. and is used by Dell under license.

Other trademarks and trade names may be used in this document to refer to either the entities claiming the marks and names or their products. Dell Inc. disclaims any proprietary interest in trademarks and trade names other than its own.

**February 2009**

**P/N F970N**

**Rev. A00**

# Contents

<b>Setting Up Your Inspiron™ Desktop</b> . . . . .	<b>5</b>	Memory Problems . . . . .	24
Before Setting Up Your Computer . . . . .	5	Lockups and Software Problems . . . . .	25
Connect the Display . . . . .	6	<b>Using Support Tools</b> . . . . .	<b>28</b>
Connect the Keyboard and Mouse . . . . .	8	Dell Support Center . . . . .	28
Connect the Network Cable (Optional) . . . . .	8	Beep Codes . . . . .	29
Connect the Power Cables to Your Display and Computer . . . . .	9	System Messages . . . . .	30
Windows Vista® Setup . . . . .	10	Hardware Troubleshooter . . . . .	32
Connect to the Internet (Optional) . . . . .	11	Dell Diagnostics . . . . .	32
<b>Using Your Inspiron™ Desktop</b> . . . . .	<b>14</b>	<b>System Recovery Options</b> . . . . .	<b>35</b>
Front View Features . . . . .	14	System Restore . . . . .	36
Back View Features . . . . .	16	Dell Factory Image Restore . . . . .	37
Software Features . . . . .	18	Operating System Reinstallation . . . . .	38
<b>Solving Problems</b> . . . . .	<b>21</b>	<b>Getting Help</b> . . . . .	<b>40</b>
Network Problems . . . . .	21	Technical Support and Customer Service . . . . .	41
Power Problems . . . . .	23	DellConnect™ . . . . .	41

## Contents

Online Services . . . . .	42
Automated Order-Status Service . . . . .	43
Product Information . . . . .	43
Returning Items for Repair Under Warranty or for Credit . . . . .	44
Before You Call . . . . .	45
Contacting Dell . . . . .	46
<b>Finding More Information and Resources . . . . .</b>	<b>48</b>
<b>Specifications . . . . .</b>	<b>50</b>
<b>Appendix . . . . .</b>	<b>55</b>
Macrovision Product Notice . . . . .	55
<b>Index . . . . .</b>	<b>56</b>

# Setting Up Your Inspiron™ Desktop

This section provides information about setting up your Inspiron 535/537/545/546 desktop and connecting peripherals.

 **WARNING: Before you begin any of the procedures in this section, read the safety information that shipped with your computer. For additional safety best practice information, see the Regulatory Compliance Homepage at [www.dell.com/regulatory\\_compliance](http://www.dell.com/regulatory_compliance).**

## Before Setting Up Your Computer

When positioning your computer, ensure that you allow easy access to a power source, adequate ventilation, and a level surface to place your computer.







Restricting airflow around your computer may cause it to overheat. To prevent overheating ensure that you leave at least 10.2 cm (4 inches) at the back of the computer and a minimum of 5.1 cm (2 inches) on all other sides. You should never place your computer in an enclosed space, such as a cabinet or drawer when it is powered on.

### Connect the Display

Your computer has an integrated VGA video connector. You can use this connector to connect to the display.

 **NOTE:** A DVI or HDMI connector may be available on your computer if you purchased an optional discrete graphics card.

Refer to the following table when identifying the connectors on your display and computer to select the connection type you will use.

VGA		
HDMI		
DVI		

Connect the display using either the VGA connector, the HDMI connector, or the DVI connector.

- The VGA connector carries only video signals for displays such as monitors and projectors.
- The HDMI connector is a high-performance digital connector that carries both video and audio signals for displays such as TVs and monitors with integrated speakers.

#### Connect Using the VGA Connector

Connect the display using a VGA cable (with blue connectors at both ends).

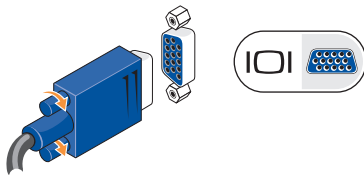



### Connect Using the HDMI Connector

If your display has a DVI connector, use a DVI cable (with white connectors at both ends) with an HDMI-to-DVI adapter.

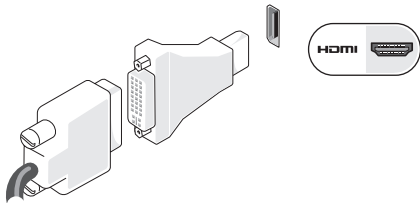

**NOTE:** You can purchase an HDMI-to-DVI adapter from the Dell website at [www.dell.com](http://www.dell.com).

### Connect Using the DVI Connector

If your display has a VGA connector, use the VGA cable (with blue connectors at both ends) with a DVI-to-VGA adapter.

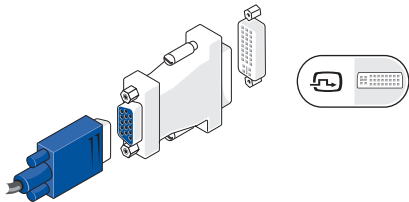

**NOTE:** You can purchase a DVI-to-VGA adapter from the Dell website at [www.dell.com](http://www.dell.com).

### Connect the Keyboard and Mouse

 **NOTE:** The exact location of connectors may be different than what is shown.

Use the USB connectors on the back panel of the computer to connect a USB keyboard and mouse.

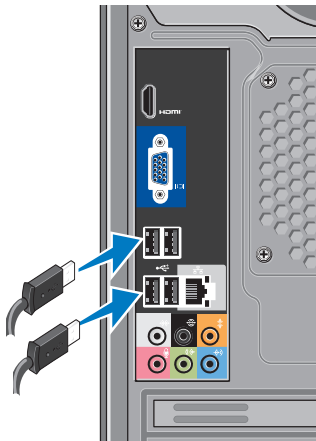

### Connect the Network Cable (Optional)

 **NOTE:** The exact location of connectors may be different than what is shown.

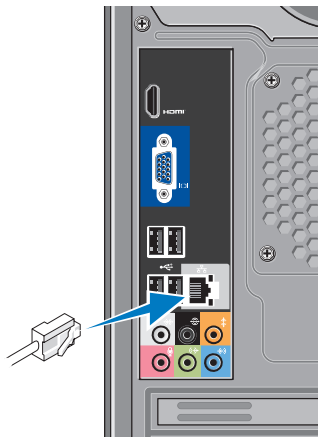

A network connection is not required to complete your computer setup, but if you have an existing network or Internet connection that uses a cable connection (such as a home cable modem or Ethernet jack), you can connect it now. Use only an Ethernet cable (RJ45 connector). Do not plug a telephone cable (RJ11 connector) into the network connector.

To attach your computer to a network or broadband device, connect one end of the network cable to either a network port or a broadband device. Connect the other end of the network cable to the network adapter connector on the back panel of your computer. A click indicates that the network cable has been securely attached.

## Connect the Power Cables to Your Display and Computer

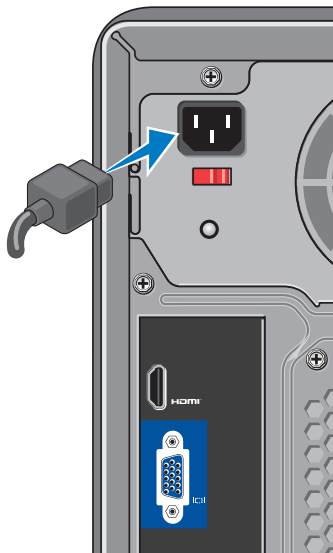

## Press the Power Button on Your Computer and Display



## Windows Vista® Setup

To set up Windows Vista for the first time, follow the instructions on the screen. These steps are mandatory and may take up to 15 minutes to complete. The screens will take you through several procedures including accepting license agreements, setting preferences, and setting up an Internet connection.

**⚠ CAUTION: Do not interrupt the operating system's setup process. Doing so may render your computer unusable.**

## Connect to the Internet (Optional)

 **NOTE:** ISPs and ISP offerings vary by country.

To connect to the Internet, you need an external modem or network connection and an Internet service provider (ISP). Your ISP will offer one or more of the following Internet connection options:

- DSL connections that provide high-speed Internet access through your existing telephone line or cellular telephone service. With a DSL connection, you can access the Internet and use your telephone on the same line simultaneously.
- Cable modem connections that provide high-speed Internet access through your local cable TV line.
- Satellite modem connections that provide high-speed Internet access through a satellite television system.

- Dial-up connections that provide Internet access through a telephone line. Dial-up connections are considerably slower than DSL and cable (or satellite) modem connections. Your computer does not have an integrated modem. An optional USB modem must be used for dial-up service with this computer.

- Wireless LAN (WLAN) connections that provide Internet access using WiFi 802.11 technology. Wireless LAN support requires optional internal components that may or may not be installed in your computer based on decisions made at the time of purchase.

 **NOTE:** If an external USB modem or WLAN adapter is not part of your original order, you can purchase one from the Dell website at [www.dell.com](http://www.dell.com).

## Setting Up Your Inspiron™ Desktop

### Setting Up a Wired Internet Connection

If you are using a dial-up connection, connect the telephone line to the external USB modem (optional) and to the telephone wall jack before you set up your Internet connection. If you are using a DSL or cable/satellite modem connection, contact your ISP or cellular telephone service for setup instructions.

### Setting Up a Wireless Connection

Before you can use your wireless Internet connection, you need to connect to your wireless router. To set up your connection to a wireless router:

1. Save and close any open files, and exit any open programs.
2. Click **Start**  → **Connect To**.
3. Follow the instructions on the screen to complete the setup.

### Setting Up Your Internet Connection

To set up an Internet connection with a provided ISP desktop shortcut:

1. Save and close any open files, and exit any open programs.
2. Double-click the ISP icon on the Microsoft® Windows® desktop.
3. Follow the instructions on the screen to complete the setup.

If you do not have an ISP icon on your desktop or if you want to set up an Internet connection with a different ISP, perform the steps in the following section.



**NOTE:** If you cannot connect to the Internet but have successfully connected in the past, the ISP might have a service outage. Contact your ISP to check the service status, or try connecting again later.

 **NOTE:** Have your ISP information ready. If you do not have an ISP, the **Connect to the Internet** wizard can help you get one.

1. Save and close any open files, and exit any open programs.
2. Click **Start**  → **Control Panel**.
3. Under **Network and Internet**, click **Connect to the Internet**.

The **Connect to the Internet** window appears.

4. Click either **Broadband (PPPoE)** or **Dial-up**, depending on how you want to connect:
  - Choose **Broadband** if you will use a DSL, satellite modem, cable TV modem, or Bluetooth® wireless technology connection.
  - Chose **Dial-up** if you will use an optional USB dial-up modem or ISDN.

 **NOTE:** If you do not know which type of connection to select, click **Help me choose** or contact your ISP.

5. Follow the instructions on the screen and use the setup information provided by your ISP to complete the setup.





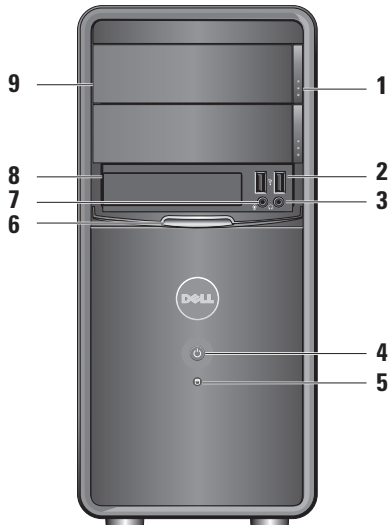

# Using Your Inspiron™ Desktop

Your computer has indicators and buttons that provide information and enable you to perform common tasks. The connectors on your computer provide the option of attaching additional devices.

## Front View Features





- 1 Optical drive panel eject button (2)** — Press to open or close the optical drive.
-  **USB 2.0 connectors (2)** — Connects to USB devices such as memory keys, digital cameras, and MP3 players.
-  **Headphone connector** — Connects to headphones.  
 **NOTE:** To connect to a powered speaker or sound system, use the audio out connector on the back of your computer.
-  **Power button** — Press to turn computer on or off. The light in the center of this button indicates the power state:
  - Solid white — the computer is in power-on state.
  - Blinking amber — there may be a problem with the system board.
  - Solid amber — the computer is in sleep state.
  - Power light is off — the computer is either turned off or is not receiving power.
-  **Hard drive activity light** — The hard drive activity light is on when the computer reads data from or writes data to the hard drive.
- 6 FlexBay panel** — Open the FlexBay panel to access the FlexBay drive.
-  **Microphone connector** — Connects to a microphone for voice or to an audio cable for audio input.
- 8 FlexBay** — Supports a Media Card Reader, or an additional hard drive.
- 9 Optical drive panel (2)** — This panel covers the optical drive. Use the optical drive to play a CD/DVD/Blu-ray Disc™.

## Back View Features

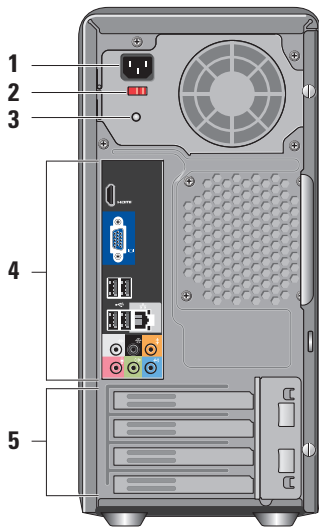



- 1 Power connector** — For power cable connection. Appearance may vary.
- 2 Voltage selector switch** — For selecting the voltage rating.
- 3 Power supply diagnostic light** — Indicates power availability for power supply.
  - Green light — Power is available for the power supply.
  - No light — Power is not available or the power supply is not working.



**NOTE:** The power supply diagnostic light may not be available on some models.
- 4 Back panel connectors** — Plug USB, audio, and other devices into the appropriate connector.
- 5 Expansion card slots** — Access connectors for any installed PCI and PCI express cards.

## Back Panel Connectors

 **NOTE:** Some back panel connectors may not be available on your computer. For details, see “Specifications” on page 50.

  **VGA video connector** —  
Connects to the display.  
On computers with a video card,  
use the connector on the card.

  **HDMI video connector** —  
Connects to the display.  
On computers with a video card,  
use the connector on the card.

  **USB 2.0 connectors (4)** —  
Connects to USB devices, such  
as a mouse, keyboard, printer,  
external drive, or MP3 player.



**Network connector and light** —  
Connects your computer to a  
network or broadband device.  
The network activity light  
flashes when the computer is  
transmitting or receiving data.  
A high volume of network traffic  
may make this light appear to be  
in a steady “on” state.









**Side L/R surround connector  
(silver)** — Connects to surround  
sound speakers.



**Rear L/R surround connector  
(black)** — Connects to  
multichannel-capable sound  
speakers.



**Center/subwoofer connector  
(orange)** — Connects to a  
subwoofer.

-   **Microphone connector (pink)** — Connects to a microphone for voice or audio input into a sound or telephony program.
-   **Line-out connector (green)** — Connects to headphones and speakers with integrated amplifiers.
-   **Line-in connector (blue)** — Connects to devices like cassette or CD players.

## Software Features

 **NOTE:** For more information about the features described in this section, see the *Dell Technology Guide* available on your hard drive or on the Dell Support website at [support.dell.com](http://support.dell.com).

### Productivity and Communication

You can use your computer to create presentations, brochures, greeting cards, fliers, and spreadsheets. You can also edit and view digital photographs and images. Check your purchase order for software installed on your computer.

After connecting to the Internet, you can access websites, setup an e-mail account, upload and download files, and so on.

### Entertainment and Multimedia

You can use your computer to watch videos, play games, create your own CDs, listen to music and radio stations. Your optical disc drive may support multiple disc media formats including CDs, Blu-ray Discs (if the option is selected at the time of purchase), and DVDs.

You can download or copy pictures and video files from portable devices, such as digital cameras and cell phones. Optional software applications enable you to organize and create music and video files that can be recorded to a disc, saved on portable products such as MP3 players and handheld entertainment devices, or played and viewed directly on connected TVs, projectors, and home theater equipment.

### Customizing the Desktop

You can customize your desktop to change the appearance, resolution, wallpaper, screensaver, and so on by accessing the **Personalize appearance and sounds** window.

To access the display properties window:

1. Right-click an open area of the desktop.
2. Click **Personalize**, to open the **Personalize appearance and sounds** window and learn more about your customization options.

### Customizing Your Energy Settings

You can use the power options in your operating system to configure the power settings on your computer. Microsoft® Windows Vista® provides three default options:

- **Balanced** — This power option offers full performance when you need it and saves power during periods of inactivity.
- **Power saver** — This power option saves power on your computer by reducing system performance to maximize the life of the computer and by reducing the amount of energy consumed by your computer over its lifetime.
- **High performance** — This power option provides the highest level of system performance on your computer by adapting processor speed to your activity and by maximizing system performance.

### Backing Up Your Data

It is recommended that you periodically back up files and folders on your computer. To back up files:

1. Click **Start**  → **Control Panel** → **System and Maintenance** → **Welcome Center** → **Transfer files and settings**.
2. Click **Back up files** or **Back up computer**.
3. Click **Continue** on the **User Account Control** window and follow the instructions in the **Back up Files** wizard.

# Solving Problems

This section provides troubleshooting information for your computer. If you are unable to solve your problem using the following guidelines, see “Using Support Tools” on page 28 or “Contacting Dell” on page 46.

 **WARNING: Only trained service personnel should remove the computer cover. See the *Service Manual* on the Dell Support website at [support.dell.com](http://support.dell.com) for advanced service and troubleshooting instructions.**

 **WARNING: Before working inside your computer, read the safety information that shipped with your computer. For additional safety best practice information, see the Regulatory Compliance Homepage at [www.dell.com/regulatory\\_compliance](http://www.dell.com/regulatory_compliance).**

## Network Problems

### Wireless Connections

**If the network connection is lost** — The wireless router is offline or wireless has been disabled on the computer.

- Check your wireless router to ensure it is powered on and connected to your data source (cable modem or network hub).
- Re-establish your connection to the wireless router:
  - a. Save and close any open files, and exit any open programs.
  - b. Click **Start**  → **Connect To**.
  - c. Follow the instructions on the screen to complete the setup.

## Solving Problems

### Wired Connections

**If the network connection is lost** — The cable is loose or damaged.

- Check the cable to ensure it is plugged in and not damaged.

The link integrity and network activity lights on the integrated network connector let you verify that your connection is working and provide information on the status:

#### Link integrity light

- Green light — A good connection exists between a 10/100-Mbps network and the computer.
- Off (no light) — The computer is not detecting a physical connection to the network.

#### Network activity light

- Yellow blinking light — Indicates activity on the network.
- Off (no light) — Indicates no activity on the network.



**NOTE:** The link integrity light on the network connector is only for the wired network connection. The link integrity light does not provide status for wireless connections.



## Power Problems

**If the power light is off** — The computer is either turned off or is not receiving power.

- Reseat the power cable into both the power connector on the computer and the electrical outlet.
- If the computer is plugged into a power strip, ensure that the power strip is plugged into an electrical outlet and that the power strip is turned on. Also bypass power protection devices, power strips, and power extension cables to verify that the computer turns on properly.
- Ensure that the electrical outlet is working by testing it with another device, such as a lamp.
- Ensure that the power supply diagnostic light on the back of the system is on. If the light is off there may be a possible problem with the power supply or the power cable.

**If the power light is solid white and the computer is not responding** — The display may not be connected or powered on. Ensure that the display is properly connected and then turn it off, then back on.

**If the power light is solid amber** — The computer is in sleep state. Press a key on the keyboard, move the pointer on the trackpad or a connected mouse, or press the power button to resume normal operation.

**If the power light is blinking amber** — The computer is receiving electrical power, but a device might be malfunctioning or incorrectly installed. You may have to remove and then reinstall the memory modules (for information on removing and replacing memory modules, see the *Service Manual* on the Dell Support website at [support.dell.com](http://support.dell.com)).

## Solving Problems

**If you encounter interference that hinders reception on your computer** — An unwanted signal is creating interference by interrupting or blocking other signals. Some possible causes of interference are:

- Power, keyboard, and mouse extension cables.
- Too many devices connected to a power strip.
- Multiple power strips connected to the same electrical outlet.

## Memory Problems

**If you receive an insufficient memory message** —

- Save and close any open files and exit any open programs you are not using to see if that resolves the problem.
- See the software documentation for minimum memory requirements. If necessary, install additional memory (see the *Service Manual* on the Dell Support website at **support.dell.com**).
- Reseat the memory modules (see the *Service Manual* on the Dell Support website at **support.dell.com**) to ensure that your computer is successfully communicating with the memory.

**If you experience other memory problems —**

- Ensure that you are following the memory installation guidelines (see the *Service Manual* on the Dell Support website at [support.dell.com](http://support.dell.com)).
- Check if the memory module is compatible with your computer. Your computer supports DDR2 memory. For more information about the type of memory supported by your computer, see “Specifications” on page 50.
- Run the Dell Diagnostics (see “Dell Diagnostics” on page 32).
- Reseat the memory modules (see the *Service Manual* on the Dell Support website at [support.dell.com](http://support.dell.com)) to ensure that your computer is successfully communicating with the memory.

**Lockups and Software Problems**

**If the computer does not start up** — Ensure that the power cable is firmly connected to the computer and to the electrical outlet.

**If a program stops responding** — End the program:

1. Press <Ctrl><Shift><Esc> simultaneously.
2. Click **Applications**.
3. Click the program that is no longer responding
4. Click **End Task**.

**If a program crashes repeatedly** — Check the software documentation. If necessary, uninstall and then reinstall the program.

 **NOTE:** Software usually includes installation instructions in its documentation or on CD.

## Solving Problems

**If the computer stops responding or a solid blue screen appears —**

 **CAUTION: You might lose data if you are unable to perform an operating system shutdown.**

If you are unable to get a response by pressing a key on your keyboard or moving your mouse, press and hold the power button for at least 8 to 10 seconds until the computer turns off. Then restart your computer.

**If a program is designed for an earlier Microsoft® Windows® operating system —**

Run the Program Compatibility Wizard. The Program Compatibility Wizard configures a program so that it runs in an environment similar to non-Windows Vista® operating system environments.

1. Click **Start**  → **Control Panel** → **Programs** → **Use an older program with this version of Windows.**
2. In the welcome screen, click **Next**.
3. Follow the instructions on the screen.

### If you have other software problems —

- Back up your files immediately.
  - Use a virus-scanning program to check the hard drive or CDs.
  - Save and close any open files or programs and shut down your computer through the **Start**  menu.
  - Check the software documentation or contact the software manufacturer for troubleshooting information:
    - Ensure that the program is compatible with the operating system installed on your computer.
    - Ensure that your computer meets the minimum hardware requirements needed to run the software. See the software documentation for information.
- Ensure that the program is installed and configured properly.
  - Verify that the device drivers do not conflict with the program.
  - If necessary, uninstall and then reinstall the program.

# Using Support Tools

## Dell Support Center

The Dell Support Center helps you find the service, support, and system-specific information you need. For more information about Dell Support Center and available support tools, click the **Services** tab at [support.dell.com](http://support.dell.com).



Click the  icon in the taskbar to run the application. The home page provides links to access:

- Self Help (Troubleshooting, Security, System Performance, Network/Internet, Backup/Recovery, and Windows Vista®)
- Alerts (technical support alerts relevant to your computer)
- Assistance from Dell (Technical Support with DellConnect™, Customer Service, Training

and Tutorials, How-To Help with Dell on Call™, and Online Scan with PCCheckUp)

- About Your System (System Documentation, Warranty Information, System Information, Upgrades & Accessories)

The top of the Dell Support Center home page displays your computer's model number along with its Service Tag and Express Service Code.

For more information about the Dell Support Center, see the *Dell Technology Guide* on your hard drive or on the Dell Support website at [support.dell.com](http://support.dell.com).



**WARNING:** To guard against the likelihood of electric shock, laceration by moving fan blades or other unexpected injuries, always unplug your computer from the electrical outlet before removing the cover.

## Beep Codes

Your computer may emit a repetitive beep code during start-up to help troubleshoot problems when error messages cannot be displayed.

 **NOTE:** To replace parts see the *Service Manual* on the Dell Support website at [support.dell.com](http://support.dell.com).

**One beep** — *BIOS ROM checksum failure.  
Possible motherboard failure*

Contact Dell (see “Contacting Dell” on page 46).

**Two beeps** — *No RAM Detected*

- Remove the memory modules, reinstall one module and restart the computer. If the computer starts normally, reinstall each module until you can identify a faulty module or reinstall the modules without an error.
- If available, install memory modules of the same type in your computer.
- If the problem persists, contact Dell (see “Contacting Dell” on page 46).

**Three beeps** — *Possible motherboard failure*

Contact Dell (see “Contacting Dell” on page 46).

**Four beeps** — *RAM Read/Write failure*

- Ensure that no special memory module/memory connector placement requirements exist (see the *Service Manual* on the Dell Support website at [support.dell.com](http://support.dell.com)).
- Verify that the memory modules that you are installing are compatible with your computer.
- If the problem persists contact Dell (see “Contacting Dell” on page 46).

**Five beeps** — *Real Time Clock Failure*

Replace the battery.

**Six beeps** — *Video BIOS Test Failure*

Contact Dell (see “Contacting Dell” on page 46).

**Seven beeps** (Inspiron 535 and 545 only) — *CPU Failure*

Contact Dell (see “Contacting Dell” on page 46).

### System Messages

If your computer has an issue or error, it may display a System Message that will help you identify the cause and action needed to resolve the issue.

 **NOTE:** If the message you received is not listed in the following examples, see the documentation for either the operating system or the program that was running when the message appeared. Alternatively you could see the *Service Manual* on the Dell Support website at [support.dell.com](http://support.dell.com) or see “Contacting Dell” on page 46 for assistance.

**Alert! Previous attempts at booting this system have failed at checkpoint [nnnn]. For help in resolving this problem, please note this checkpoint and contact Dell Technical Support** — The computer failed to complete the boot routine three consecutive times for the same error (see “Contacting Dell” on page 46 for assistance).

**CMOS checksum error** — Possible motherboard failure or RTC battery low. Coin-cell battery needs replacement. See the *Service Manual* on the Dell Support website at [support.dell.com](http://support.dell.com) or see “Contacting Dell” on page 46 for assistance.

**CPU fan failure** — CPU fan has failed. CPU fan needs replacement. See the *Service Manual* on the Dell Support website at [support.dell.com](http://support.dell.com).

**Hard-disk drive failure** — Possible hard disk drive failure during HDD POST (see “Contacting Dell” on page 46 for assistance).

**Hard-disk drive read failure** — Possible hard disk drive failure during HDD boot test (see “Contacting Dell” on page 46 for assistance).

**Keyboard failure** — Replace keyboard or check the cable for loose connection.



**No boot device available** — No bootable partition on hard disk drive, the hard disk drive cable is loose, or no bootable device exists.

- If the hard drive is your boot device, ensure that the cables are connected and that the drive is installed properly and partitioned as a boot device.
- Enter system setup and ensure that the boot sequence information is correct (see the *Service Manual* on the Dell Support website at [support.dell.com](http://support.dell.com)).

**No timer tick interrupt** — A chip on the system board might be malfunctioning or motherboard failure (see the *Service Manual* on the Dell Support website at [support.dell.com](http://support.dell.com) or see “Contacting Dell” on page 46 for assistance).

**USB over current error** — Disconnect the USB device. Your USB device needs more power for it to function properly. Use an external power source to connect the USB device, or if your device has two USB cables, connect both of them.

**NOTICE - Hard Drive SELF MONITORING SYSTEM has reported that a parameter has exceeded its normal operating range. Dell recommends that you back up your data regularly. A parameter out of range may or may not indicate a potential hard drive problem** — S.M.A.R.T error, possible hard disk drive failure. This feature can be enabled or disabled in the BIOS setup (see “Contacting Dell” on page 46 for assistance).

### Hardware Troubleshooter

If a device is either not detected during the operating system setup or is detected but incorrectly configured, you can use the **Hardware Troubleshooter** to resolve the incompatibility.

To start the Hardware Troubleshooter:

1. Click **Start**  → **Help and Support**.
2. Type `hardware troubleshooter` in the search field and press <Enter> to start the search.
3. In the search results, select the option that best describes the problem and follow the remaining troubleshooting steps.

### Dell Diagnostics

If you experience a problem with your computer, perform the checks in “Lockups and Software Problems” on page 25 and run the Dell Diagnostics before you contact Dell for technical assistance.

It is recommended that you print these procedures before you begin.

 **NOTE:** Dell Diagnostics works only on Dell computers.

 **NOTE:** The *Drivers and Utilities* disc is optional and may not ship with your computer.

See the System Setup section in the *Service Manual* to review your computer’s configuration information, and ensure that the device that you want to test displays in the system setup program and is active.

Start the Dell Diagnostics from your hard drive or from the *Drivers and Utilities* disc.

## Starting Dell Diagnostics From Your Hard Drive

The Dell Diagnostics is located on a hidden diagnostic utility partition on your hard drive.

 **NOTE:** If your computer cannot display a screen image, see “Contacting Dell” on page 46.

1. Ensure that the computer is connected to an electrical outlet that is known to be working properly.
2. Turn on (or restart) your computer.
3. When the DELL™ logo appears, press <F12> immediately. Select **Diagnostics** from the boot menu and press <Enter>.

 **NOTE:** If you wait too long and the operating system logo appears, continue to wait until you see the Microsoft® Windows® desktop; then, shut down your computer and try again.

 **NOTE:** If you see a message stating that no diagnostics utility partition has been found, run the Dell Diagnostics from the *Drivers and Utilities* disc.

4. Press any key to start the Dell Diagnostics from the diagnostics utility partition on your hard drive.

## Starting Dell Diagnostics From the Drivers and Utilities Disc

1. Insert the *Drivers and Utilities* disc.
2. Shut down and restart the computer. When the DELL logo appears, press <F12> immediately.

 **NOTE:** If you wait too long and the operating system logo appears, continue to wait until you see the Microsoft® Windows® desktop; then, shut down your computer and try again.

 **NOTE:** The next steps change the boot sequence for one time only. On the next start-up, the computer boots according to the devices specified in the system setup program.

## Using Support Tools

3. When the boot device list appears, highlight **CD/DVD/CD-RW** and press <Enter>.
4. Select the **Boot from CD-ROM** option from the menu that appears and press <Enter>.
5. Type 1 to start the CD menu and press <Enter> to proceed.
6. Select **Run the 32 Bit Dell Diagnostics** from the numbered list. If multiple versions are listed, select the version appropriate for your computer.
7. When the Dell Diagnostics **Main Menu** appears, select the test you want to run.

# System Recovery Options

You can restore your operating system in the following ways:

- System Restore returns your computer to an earlier operating state without affecting data files. Use System Restore as the first solution for restoring your operating system and preserving data files.
- Dell Factory Image Restore returns your hard drive to the operating state it was in when you purchased the computer. This procedure permanently deletes all data on the hard drive and removes any programs installed after you received the computer. Use Dell Factory Image Restore only if System Restore did not resolve your operating system problem.
- If you received an Operating System disc with your computer, you can use it to restore your operating system. However, using the Operating System disc also deletes all data on the hard drive. Use the disc only if System Restore did not resolve your operating system problem.

### System Restore

The Windows operating systems provide a System Restore option which allows you to restore your computer to an earlier operating state (without affecting data files) if changes to the hardware, software, or other system settings have left the computer in an undesirable operating state. Any changes that System Restore makes to your computer are completely reversible.

 **CAUTION:** Make regular backups of your data files. System Restore does not monitor your data files or recover them.

 **NOTE:** The procedures in this document were written for the Windows default view, so they may not apply if you set your Dell™ computer to the Windows Classic view.

#### Starting System Restore

1. Click **Start** .
2. In the **Start Search** box, type `System Restore` and press <Enter>.

 **NOTE:** The **User Account Control** window may appear. If you are an administrator on the computer, click **Continue**; otherwise, contact your administrator to continue the desired action.

3. Click **Next** and follow the remaining prompts on the screen.

In the event that System Restore did not resolve the issue, you may undo the last system restore.

#### Undoing the Last System Restore

 **NOTE:** Before you undo the last system restore, save and close all open files, and exit any open programs. Do not alter, open, or delete any files or programs until the system restoration is complete.

1. Click **Start** .
2. In the **Start Search** box, type `System Restore` and press <Enter>.
3. Click **Undo my last restoration** and click **Next**.

## Dell Factory Image Restore

 **CAUTION:** Using Dell Factory Image Restore permanently deletes all data on the hard drive and removes any programs or drivers installed after you received your computer. If possible, back up the data before using these options. Use Dell Factory Image Restore only if System Restore did not resolve your operating system problem.

 **CAUTION:** Dell Factory Image Restore is not available if the hard drive is formatted or partitioned using the Operating System disc.

 **NOTE:** Dell Factory Image Restore may not be available in certain countries or on certain computers.

Use Dell Factory Image Restore only as the last method to restore your operating system. These options restore your hard drive to the operating state it was in when you purchased

the computer. Any programs or files added since you received your computer—including data files—are permanently deleted from the hard drive. Data files include documents, spreadsheets, e-mail messages, digital photos, music files, and so on. If possible, back up all data before using Factory Image Restore.

### Dell Factory Image Restore

1. Turn on the computer. When the Dell logo appears, press <F8> several times to access the **Vista Advanced Boot Options** window.
2. Select **Repair Your Computer**.
3. The **System Recovery Options** window appears.
4. Select a keyboard layout and click **Next**.
5. To access the recovery options, log on as a local user. To access the command prompt, type `administrator` in the **User name** field, then click **OK**.

6. Click **Dell Factory Image Restore**. The **Dell Factory Image Restore** welcome screen appears.

 **NOTE:** Depending upon your configuration, you may need to select **Dell Factory Tools**, then **Dell Factory Image Restore**.

7. Click **Next**. The **Confirm Data Deletion** screen appears.

 **CAUTION:** If you do not want to proceed with **Factory Image Restore**, click **Cancel**.

8. Click the checkbox to confirm that you want to continue reformatting the hard drive and restoring the system software to the factory condition, then click **Next**.

The restore process begins and may take five or more minutes to complete. A message appears when the operating system and factory-installed applications have been restored to factory condition.

9. Click **Finish** to reboot the system.

## Operating System Reinstallation

### Before You Begin

If you are reinstalling the Microsoft® Windows® operating system to correct a problem with a newly installed driver, first try using Windows Device Driver Rollback. If Device Driver Rollback does not resolve the problem, then use System Restore to return your operating system to the state it was in before you installed the new device driver. See “System Restore” on page 35.

 **CAUTION:** Before performing the installation, back up all data files on your primary hard drive. For conventional hard drive configurations, the primary hard drive is the first drive detected by the computer.

To reinstall Windows, you need the following items:

- Dell *Operating System* disc
- Dell *Drivers and Utilities* disc



 **NOTE:** The Dell *Drivers and Utilities* disc contains drivers that were installed during the assembly of the computer. Use the Dell *Drivers and Utilities* disc to load any required drivers. Depending on the region from which you ordered your computer, or whether you requested the disc, the Dell *Drivers and Utilities* disc and *Operating System* disc may not ship with your computer.

### Reinstalling Windows Vista®

The reinstallation process can take 1 to 2 hours to complete. After you reinstall the operating system, you must also reinstall the device drivers, virus protection program, and other software.

1. Save and close any open files and exit any open programs.
2. Insert the *Operating System* disc.
3. Click **Exit** if the **Install Windows** message appears.

4. Restart the computer.
5. When the DELL logo appears, press <F12> immediately.

 **NOTE:** If you wait too long and the operating system logo appears, continue to wait until you see the Microsoft® Windows® desktop; then, shut down your computer and try again.

 **NOTE:** The next steps change the boot sequence for one time only. On the next start-up, the computer boots according to the devices specified in the system setup program.

6. When the boot device list appears, highlight **CD/DVD/CD-RW Drive** and press <Enter>.
7. Press any key to **Boot from CD-ROM**. Follow the instructions on the screen to complete the installation.

# Getting Help

If you experience a problem with your computer, you can complete the following steps to diagnose and troubleshoot the problem:

1. See “Solving Problems” on page 21 for information and procedures that pertain to the problem your computer is experiencing.
2. See “Dell Diagnostics” on page 32 for procedures on how to run Dell Diagnostics.
3. Fill out the “Diagnostic Checklist” on page 45.
4. Use Dell’s extensive suite of online services available at Dell Support ([support.dell.com](http://support.dell.com)) for help with installation and troubleshooting procedures. See “Online Services” on page 42 for a more extensive list of Dell Support online.
5. If the preceding steps have not resolved the problem, see “Contacting Dell” on page 46.

 **NOTE:** Call Dell Support from a telephone near or at the computer so that the support staff can assist you with any necessary procedures.

 **NOTE:** Dell’s Express Service Code system may not be available in all countries.

When prompted by Dell’s automated telephone system, enter your Express Service Code to route the call directly to the proper support personnel. If you do not have an Express Service Code, open the **Dell Accessories** folder, double-click the **Express Service Code** icon, and follow the directions.

 **NOTE:** Some of the following services are not always available in all locations outside the continental U.S. Call your local Dell representative for information on availability.

## Technical Support and Customer Service

Dell's support service is available to answer your questions about Dell hardware. Our support staff uses computer-based diagnostics to provide fast, accurate answers.

To contact Dell's support service, see "Before You Call" on page 45 and then see the contact information for your region or go to **support.dell.com**.

## DellConnect™

DellConnect is a simple online access tool that allows a Dell service and support associate to access your computer through a broadband connection, diagnose your problem, and repair it all under your supervision. For more information, go to **support.dell.com** and click **DellConnect**.

### Online Services

You can learn about Dell products and services on the following websites:

- **www.dell.com**
- **www.dell.com/ap** (Asian/Pacific countries only)
- **www.dell.com/jp** (Japan only)
- **www.euro.dell.com** (Europe only)
- **www.dell.com/la** (Latin American and Caribbean countries)
- **www.dell.ca** (Canada only)

You can access Dell Support through the following websites and e-mail addresses:

Dell Support websites

- **support.dell.com**
- **support.jp.dell.com** (Japan only)
- **support.euro.dell.com** (Europe only)

Dell Support e-mail addresses

- **mobile\_support@us.dell.com**
- **support@us.dell.com**
- **la-techsupport@dell.com** (Latin America and Caribbean countries only)
- **apsupport@dell.com** (Asian/Pacific countries only)

Dell Marketing and Sales e-mail addresses

- **apmarketing@dell.com** (Asian/Pacific countries only)
- **sales\_canada@dell.com** (Canada only)

Anonymous file transfer protocol (FTP)

- **ftp.dell.com**

Log in as user: *anonymous*, and use your e-mail address as your password.

## Automated Order-Status Service

To check on the status of any Dell products that you have ordered, you can go to **support.dell.com**, or you can call the automated order-status service. A recording prompts you for the information needed to locate and report on your order. For the telephone number to call your region, see “Contacting Dell” on page 46.



If you have a problem with your order, such as missing parts, wrong parts, or incorrect billing, contact Dell for customer assistance. Have your invoice or packing slip handy when you call. For the telephone number to call for your region, see “Contacting Dell” on page 46.

## Product Information

If you need information about additional products available from Dell, or if you would like to place an order, visit the Dell website at **www.dell.com**. For the telephone number to call for your region or to speak to a sales specialist, see “Contacting Dell” on page 46.

### Returning Items for Repair Under Warranty or for Credit

Prepare all items being returned, whether for repair or credit, as follows:

1. Call Dell to obtain a Return Material Authorization Number, and write it clearly and prominently on the outside of the box.
2. For the telephone number to call for your region, see “Contacting Dell” on page 46.
3. Include a copy of the invoice and a letter describing the reason for the return.
4. Include a copy of the Diagnostics Checklist (see “Diagnostic Checklist” on page 45), indicating the tests that you have run and any error messages reported by the Dell Diagnostics (see “Dell Diagnostics” on page 32).
5. Include any accessories that belong with the item(s) being returned (power cables, software, guides, and so on) if the return is for credit.
6. Pack the equipment to be returned in the original (or equivalent) packing materials.
  -  **NOTE:** You are responsible for paying shipping expenses. You are also responsible for insuring any product returned, and you assume the risk of loss during shipment to Dell. Collect On Delivery (C.O.D.) packages are not accepted.
  -  **NOTE:** Returns that are missing any of the preceding requirements will be refused at Dell’s receiving dock and returned to you.

## Before You Call

 **NOTE:** Have your Express Service Code ready when you call. The code helps Dell's automated-support telephone system direct your call more efficiently. You may also be asked for your Service Tag.

Remember to fill out the following Diagnostics Checklist. If possible, turn on your computer before you call Dell for assistance and call from a telephone at or near the computer. You may be asked to type some commands at the keyboard, relay detailed information during operations, or try other troubleshooting steps possible only at the computer itself. Ensure that the computer documentation is available.

## Diagnostic Checklist

- Name:
- Date:
- Address:
- Phone number:
- Service Tag (bar code on the top of the computer):
- Express Service Code:
- Return Material Authorization Number (if provided by Dell support technician):
- Operating system and version:
- Devices:
- Expansion cards:
- Are you connected to a network? Yes/No
- Network, version, and network adapter:
- Programs and versions:

See your operating system documentation to determine the contents of the computer's start-up files. If the computer is connected to

## Getting Help

a printer, print each file. Otherwise, record the contents of each file before calling Dell.

- Error message, beep code, or diagnostic code:
- Description of problem and troubleshooting procedures you performed:

## Contacting Dell

For customers in the United States, call 800-WWW-DELL (800-999-3355).



**NOTE:** If you do not have an active Internet connection, you can find contact information on your purchase invoice, packing slip, bill, or Dell product catalog.

Dell provides several online and telephone-based support and service options. Availability varies by country and product, and some services may not be available in your area.

To contact Dell for sales, technical support, or customer service issues:

1. Visit **support.dell.com**.
2. Verify your country or region in the **Choose A Country/Region** drop-down menu at the bottom of the page.
3. Click **Contact Us** on the left side of the page.



4. Select the appropriate service or support link based on your need.
5. Choose the method of contacting Dell that is convenient for you.

# Finding More Information and Resources

**If you need to:****See:**

---

reinstall your operating system.

your *Operating System* disc.

---

find your system model number.

the back of your computer.

---

run a diagnostic program for your computer, reinstall desktop system software, or update drivers for your computer, and readme files.

the *Drivers and Utilities* disc.



**NOTE:** Drivers and documentation updates can be found on the Dell™ Support website at **support.dell.com**.

---

learn more about your operating system, maintaining peripherals, RAID, Internet, Bluetooth®, networking, and e-mail.

the *Dell Technology Guide* available on your hard drive.

---

upgrade your computer with new or additional memory, or a new hard drive.

the *Service Manual* on the Dell Support website at **support.dell.com**.



**NOTE:** In some countries, opening and replacing parts of your computer may void your warranty. Check your warranty and return policies before working inside your computer.

### If you need to:

find safety best practices information for your computer.

review Warranty information, Terms and Conditions (U.S. only), Safety instructions, Regulatory information, Ergonomics information, and End User License Agreement.

find your Service Tag/Express Service Code— You must use the Service tag to identify your computer on **support.dell.com** or to contact technical support.

find drivers and downloads.

access technical support and product help.

check on your order status for new purchases.

find solutions and answers to common questions.

locate information for last-minute updates about technical changes to your computer or advanced technical-reference material for technicians or experienced users,

### See:

Before working inside your computer, read the safety information that shipped with your computer. For additional safety best practices information, see the Regulatory Compliance Homepage at **www.dell.com/regulatory\_compliance**.

the top of your computer

the Dell Support website at **support.dell.com**.

# Specifications

## Computer Model

---

Inspiron 535

Inspiron 537

Inspiron 545

Inspiron 546

This section provides information that you may need when setting up, updating drivers for, and upgrading your computer.



**NOTE:** Offerings may vary by region.

For more information regarding the configuration of your computer, click

**Start**  → **Help and Support** and select the option to view information about your computer.

## Drives

---

Externally accessible two 5.25-inch drive bays for SATA DVD+/-RW Super Multi Drive or Blu-ray Disc™ combo or Blu-ray Disc RW optical drive

one 3.5 inch bay for a FlexBay drive

Internally accessible two 3.5-inch drive bays for SATA hard drives

**Front Panel Connectors**

USB	two USB 2.0-compliant connectors
Audio	one microphone connector; one headphone connector

**Expansion Slots**

PCI Express x16	one slot supporting full-height cards
PCI Express x1	one slot supporting full-height cards
PCI	two slots supporting full-height cards

**Computer Environment***Temperature ranges:*

Operating	10° to 35° C (50° to 95° F)
Storage	- 40° to 65° C (- 40° to 149° F)
Relative humidity:	20% to 80% (non condensing)

*Maximum vibration (using a random-vibration spectrum that simulates user environment):*

Operating	5 to 350 Hz at 0.0002 G <sup>2</sup> /Hz
Storage	5 to 500 Hz at 0.001 to 0.01 G <sup>2</sup> /Hz

*Maximum shock (measured with hard drive in head-parked position and a 2-ms half-sine pulse):*

Operating	40 G +/- 5% with pulse duration of 2 msec +/- 10% (equivalent to 20 inches/ sec [51 cm/sec])
-----------	--

## Specifications

### Computer Environment

---

Storage 105 G +/- 5% with pulse duration of 2 msec +/- 10% (equivalent to 50 inches/ sec [127 cm/sec])

*Altitude (maximum):*

Operating -15.2 to 3,048 m (-50 to 10,000 ft)

Storage -15.2 to 10,668 m (-50 to 35,000 ft)

Airborne contaminant level G2 or lower as defined by ISA-S71.04-1985

### Power

---

DC Power Supply

Wattage 300 W

### Power

---

Maximum heat dissipation 1,023 BTU/hr

 **NOTE:** Heat dissipation is calculated by using the power supply wattage rating.

Voltage 115/230 VAC, 50/60 Hz, 7/4 A

Coin-cell battery 3-V CR2032 lithium coin cell

### Physical

---

Height (maximum) 37.53 cm (14.8 inches)

Width (maximum) 17.59 cm (6.93 inches)

Depth (maximum) 44.22 cm (17.44 inches)

Weight starting at 7.9 kg (17.4 lb)

 **NOTE:** Depending on the model of your computer, there may be slight variations in the physical dimensions and weight.

By model	535/537	545	546
<b>Processor</b>	Intel® Celeron® Intel Pentium® Dual-Core Intel Core™2 Duo Intel Core2 Quad (537 only)	Intel Celeron Intel Pentium Dual-Core Intel Core2 Duo Intel Core2 Quad	AMD™ Sempron™ AMD Athlon™ AMD Athlon X2 AMD Phenom™
<b>Memory</b>			
Connectors	two	four	four
Minimum	1 GB (1 x 1 GB DIMM)	1 GB (1 x 1 GB DIMM)	2 GB (2 x 1 GB DIMMs)
Maximum	4 GB (2 x 2 GB DIMMs)	8 GB (4 x 2 GB DIMMs)	8 GB (4 x 2 GB DIMMs)
Memory type	800-MHz DDR2 DIMM; non-ECC memory only	800-MHz DDR2 DIMM; non-ECC memory only	800-MHz DDR2 DIMM; non-ECC memory only
Capacities	1 GB and 2 GB	1 GB and 2 GB	1 GB and 2 GB

 **NOTE:** For instructions on upgrading your memory, see the *Service Manual* on the Dell Support website at [support.dell.com](http://support.dell.com).

## Specifications

<b>By model</b>	<b>535/537</b>	<b>545</b>	<b>546</b>
<b>Back Panel Connectors</b>			
Audio	Microphone connector Line-out connector Line-in connector	Microphone connector Line-out connector Line-in connector Side L/R surround connector Rear L/R surround connector Center/subwoofer connector	Microphone connector Line-out connector Line-in connector
USB	four USB 2.0-compliant connectors	four USB 2.0-compliant connectors	four USB 2.0-compliant connectors
Network adapter	RJ45 connector	RJ45 connector	RJ45 connector
Video	VGA connector	VGA connector	VGA connector HDMI connector
<b>Audio Type</b>	Realtek ALC622 integrated 5.1 channel, High Definition Audio	Realtek ALC888 integrated 7.1 channel, High Definition Audio	Via VT1708S integrated 5.1 channel, High Definition Audio



# Appendix

## Macrovision Product Notice

This product incorporates copyright protection technology that is protected by method claims of certain U.S. patents and other intellectual property rights owned by Macrovision Corporation and other rights owners. Use of this copyright protection technology must be authorized by Macrovision Corporation, and is intended for home and other limited viewing uses only unless otherwise authorized by Macrovision Corporation. Reverse engineering or disassembly is prohibited.

# Index

## B

- backups
  - creating **20**

## C

- calling Dell **45**
- CDs, playing and creating **19**
- computer capabilities **18**
- connect(ing)
  - displays **6**
  - optional network cable **8**
  - to the Internet **10**
  - using dial-up **11**
- conserving energy **20**
- Contacting Dell online **46**
- customer service **41**

- customizing
  - your desktop **19**
  - your energy settings **20**

## D

- data, backing up **20**
- DellConnect **41**
- Dell Diagnostics **32**
- Dell Factory Image Restore **35**
- Dell Support Center **28**
- Dell support website **48**
- Dell Technology Guide
  - for further information **48**
- Diagnostic Checklist **45**
- drivers and downloads **48**
- DVDs, playing and creating **19**

**E**

- email addresses
  - for technical support **42**
- energy
  - conserving **20**

**F**

- finding more information **48**
- front-side connectors **14**
- FTP login, anonymous **42**

**H**

- hard drive
  - type **50**
- hardware problems
  - diagnosing **32**
- Hardware Troubleshooter **32**
- HDMI
  - display **6**

headphone

- front connector **15**

help

- getting assistance and support **40**

**I**

Internet connection **11**

ISP

- Internet Service Provider **11**

**M**

memory problems

- solving **24**

**N**

network connection

- fixing **22**

network connector

- location **17**

## Index

network speed  
testing **21**

## O

order status **43**

## P

power button and light **15**

power problems, solving **23**

problems, solving **21**

products

information and purchasing **43**

## R

reinstalling Windows **35**

resources, finding more **48**

restoring factory image **37**

## S

shipping products

for return or repair **44**

software features **18**

software problems **25**

solving problems **21**

specifications **50**

support email addresses **42**

support sites

worldwide **41**

System Messages **30**

system reinstall options **35**

System Restore **35**

## T

technical support **41**

temperature

operating and storage ranges **51**

**U**

## USB 2.0

back connectors **17**front connectors **15****W**warranty returns **44**Windows, reinstalling **35**

## Windows Vista

Program Compatibility Wizard **26**reinstalling **39**setup **10**wireless network connection **21**







Printed in the U.S.A.

[www.dell.com](http://www.dell.com) | [support.dell.com](http://support.dell.com)



OF970NA00