

# Inspiron 24-3480 Service Manual

**Regulatory Model: W21C**  
**Regulatory Type: W21C003**



# Notes, cautions, and warnings

---



**NOTE:** A NOTE indicates important information that helps you make better use of your product.



**CAUTION:** A CAUTION indicates either potential damage to hardware or loss of data and tells you how to avoid the problem.



**WARNING:** A WARNING indicates a potential for property damage, personal injury, or death.

---

© 2018 Dell Inc. or its subsidiaries. All rights reserved. Dell, EMC, and other trademarks are trademarks of Dell Inc. or its subsidiaries. Other trademarks may be trademarks of their respective owners.

2018 - 12

Rev. A00

# Contents

<b>Before working inside your computer.....</b>	<b>10</b>
Before you begin .....	10
Safety instructions.....	10
Recommended tools.....	11
Screw list.....	12
System-board components.....	14
<b>After working inside your computer.....</b>	<b>16</b>
<b>Removing the stand.....</b>	<b>17</b>
Easel Stand.....	17
Pedestal stand.....	18
<b>Replacing the stand.....</b>	<b>21</b>
Easel stand.....	21
Pedestal stand.....	22
<b>Removing the back cover.....</b>	<b>25</b>
Prerequisite.....	25
Procedure.....	26
<b>Replacing the back cover.....</b>	<b>27</b>
Procedure.....	27
Post-requisite.....	28
<b>Removing the rubber feet.....</b>	<b>29</b>
Prerequisites.....	29
Procedure.....	29

<b>Replacing the rubber feet.....</b>	<b>31</b>
Procedure.....	31
Post-requisites.....	31
<b>Removing the hard drive.....</b>	<b>33</b>
Prerequisites.....	33
Procedure.....	33
<b>Replacing the hard drive.....</b>	<b>35</b>
Procedure.....	35
Post-requisites.....	36
<b>Removing the system-board shield.....</b>	<b>37</b>
Prerequisites.....	37
Procedure.....	37
<b>Replacing the system-board shield.....</b>	<b>39</b>
Procedure.....	39
Post-requisites.....	40
<b>Removing the memory module.....</b>	<b>41</b>
Prerequisites.....	41
Procedure.....	41
<b>Replacing the memory module.....</b>	<b>43</b>
Procedure.....	43
Post-requisites.....	43
<b>Removing the wireless card.....</b>	<b>44</b>
Prerequisites.....	44
Procedure.....	44

<b>Replacing the wireless card.....</b>	<b>47</b>
Procedure.....	47
Post-requisites.....	48
<b>Removing the antennas.....</b>	<b>49</b>
Prerequisites.....	49
Procedure.....	49
<b>Replacing the antennas.....</b>	<b>51</b>
Procedure.....	51
Post-requisites.....	52
<b>Removing the solid-state drive/Intel Optane memory module.....</b>	<b>53</b>
Prerequisites.....	53
Procedure.....	54
<b>Replacing the solid-state drive/Intel Optane memory module.....</b>	<b>55</b>
Procedure.....	56
Post-requisites.....	57
<b>Removing the media-card reader.....</b>	<b>58</b>
Prerequisites.....	58
Procedure.....	58
<b>Replacing the media-card reader.....</b>	<b>60</b>
Procedure.....	60
Post-requisites.....	61

- Removing the power-button board..... 62**
  - Prerequisites.....62
  - Procedure.....62
  
- Replacing the power-button board..... 64**
  - Procedure.....64
  - Post-requisites..... 65
  
- Removing the microphone..... 66**
  - Prerequisites..... 66
  - Procedure..... 66
  
- Replacing the microphone..... 68**
  - Procedure.....68
  - Post-requisites..... 69
  
- Removing the camera..... 70**
  - Prerequisites..... 70
  - Procedure..... 70
  
- Replacing the camera..... 73**
  - Procedure..... 73
  - Post-requisites..... 75
  
- Removing the coin-cell battery..... 76**
  - Prerequisites..... 76
  - Procedure..... 77
  
- Replacing the coin-cell battery..... 78**
  - Procedure..... 78
  - Post-requisites..... 78

<b>Removing the fan.....</b>	<b>79</b>
Prerequisites.....	79
Procedure.....	79
<b>Replacing the fan.....</b>	<b>81</b>
Procedure.....	81
Post-requisites.....	82
<b>Removing the heat sink.....</b>	<b>83</b>
Prerequisites.....	83
Procedure.....	83
<b>Replacing the heat sink.....</b>	<b>85</b>
Procedure.....	85
Post-requisites.....	86
<b>Removing the speakers.....</b>	<b>87</b>
Prerequisites.....	87
Procedure.....	87
<b>Replacing the speakers.....</b>	<b>89</b>
Procedure.....	89
Post-requisites.....	90
<b>Removing the system board.....</b>	<b>91</b>
Prerequisites.....	91
Procedure.....	91
<b>Replacing the system board.....</b>	<b>94</b>
Procedure.....	94
Post-requisites.....	96
Flashing the BIOS.....	96

<b>Removing the display panel.....</b>	<b>98</b>
Prerequisites.....	98
Procedure.....	98
<b>Replacing the display panel.....</b>	<b>102</b>
Procedure.....	102
Post-requisites.....	106
<b>Removing the middle frame.....</b>	<b>107</b>
Prerequisites.....	107
Procedure.....	107
<b>Replacing the middle frame.....</b>	<b>111</b>
Procedure.....	111
Post-requisites.....	112
<b>Downloading drivers.....</b>	<b>114</b>
Operating system.....	114
Downloading the audio driver.....	114
Downloading the graphics driver.....	115
Downloading the USB driver.....	116
Downloading the WiFi driver.....	117
Downloading the media-card reader driver.....	117
Downloading the chipset driver.....	118
Downloading the network driver.....	119
Device drivers.....	120
Intel Chipset Software Installation Utility.....	120
Video drivers.....	120
Intel Serial IO driver.....	120
Intel Serial IO driver.....	121
Intel Trusted Execution Engine Interface.....	121





Intel Virtual Button driver.....	121
Wireless and Bluetooth drivers.....	121
<b>System setup.....</b>	<b>122</b>
BIOS overview.....	122
Entering BIOS setup program.....	122
Navigation keys.....	123
Boot Sequence.....	123
System Setup Options.....	124
System and setup password.....	129
Assigning a system setup password.....	130
Deleting or changing an existing system setup password.....	130
Clearing CMOS settings.....	131
Clearing BIOS (System Setup) and System passwords.....	132
<b>Troubleshooting.....</b>	<b>133</b>
Flashing the BIOS.....	133
Reinstall Windows using a USB recovery drive.....	133
Enhanced Pre-Boot System Assessment (ePSA) diagnostics.....	134
Running the ePSA diagnostics.....	135
Display built-in self test.....	135
Diagnostics.....	135
Enabling Intel Optane memory.....	136
Disabling Intel Optane memory.....	137
Flea power release.....	138
WiFi power cycle.....	138
<b>Getting help and contacting Dell.....</b>	<b>139</b>
Self-help resources.....	139
Contacting Dell.....	140

# Before working inside your computer

---

 **NOTE:** The images in this document may differ from your computer depending on the configuration you ordered.

## Before you begin

- 1 Save and close all open files and exit all open applications.
- 2 Shut down your computer. Click **Start** →  **Power** → **Shut down**.  
 **NOTE:** If you are using a different operating system, see the documentation of your operating system for shut-down instructions.
- 3 Disconnect your computer and all attached devices from their electrical outlets.
- 4 Disconnect all attached network devices and peripherals, such as keyboard, mouse, and monitor from your computer.
- 5 Remove any media card and optical disc from your computer, if applicable.
- 6 After the computer is unplugged, press and hold the power button for 5 seconds to ground the system board.







 **CAUTION:** Place the computer on a flat, soft, and clean surface to avoid scratches on the display.

- 7 Place the computer face down.

## Safety instructions

Use the following safety guidelines to protect your computer from potential damage and ensure your personal safety.

 **WARNING:** Before working inside your computer, read the safety information that shipped with your computer. For more safety best practices, see the Regulatory Compliance home page at [www.dell.com/regulatory\\_compliance](http://www.dell.com/regulatory_compliance).

-  **WARNING:** Disconnect all power sources before opening the computer cover or panels. After you finish working inside the computer, replace all covers, panels, and screws before connecting to the electrical outlet.
-  **CAUTION:** To avoid damaging the computer, ensure that the work surface is flat and clean.
-  **CAUTION:** To avoid damaging the components and cards, handle them by their edges, and avoid touching pins and contacts.
-  **CAUTION:** You should only perform troubleshooting and repairs as authorized or directed by the Dell technical assistance team. Damage due to servicing that is not authorized by Dell is not covered by your warranty. See the safety instructions that shipped with the product or at [www.dell.com/regulatory\\_compliance](http://www.dell.com/regulatory_compliance).
-  **CAUTION:** Before touching anything inside your computer, ground yourself by touching an unpainted metal surface, such as the metal at the back of the computer. While you work, periodically touch an unpainted metal surface to dissipate static electricity, which could harm internal components.
-  **CAUTION:** When you disconnect a cable, pull on its connector or on its pull tab, not on the cable itself. Some cables have connectors with locking tabs or thumb-screws that you must disengage before disconnecting the cable. When disconnecting cables, keep them evenly aligned to avoid bending any connector pins. When connecting cables, ensure that the ports and connectors are correctly oriented and aligned.
-  **CAUTION:** Press and eject any installed card from the media-card reader.

## Recommended tools

The procedures in this document may require the following tools:

- Philips screwdriver #1
- Flat-head screwdriver
- Plastic scribe







# Screw list











 **NOTE:** When removing screws from a component, it is recommended to note the screw type, the quantity of screws, and then place them in a screw storage box. This is to ensure that the correct number of screws and correct screw type is restored when the component is replaced.

 **NOTE:** Some computers have magnetic surfaces. Ensure that the screws are not left attached to such surface when replacing a component.

 **NOTE:** Screw color may vary with the configuration ordered.

**Table 1. Screw list**

Component	Secured to	Screw type	Quantity	Screw image
Stand	System-board shield	M3x5	4	
Hard-drive bracket	Display-assembly base	M3x5	1	
Hard-drive bracket	Hard drive	M3x3.5	4	
System-board shield	Display-assembly base	M3x5	5	
Media-card reader cover	Display-assembly base	M3x5	1	
Media-card reader	Display-assembly base	M3x5	1	
Power-button board	Display-assembly base	M3x5	1	

<b>Component</b>	<b>Secured to</b>	<b>Screw type</b>	<b>Quantity</b>	<b>Screw image</b>
Microphone	Display-assembly base	M2x2.5	2	
Speakers	Display-assembly base	M3 4+7.1	4	
Fan	Display-assembly base	M2x2.5	3	
Retractable-camera assembly	Display-assembly base	M3x5	2	
System board	Display-assembly base	M3x5	6	
Wireless-card shield	System board	M2x2.5	2	
Wireless card	System board	M2x2.5	1	
Display panel	Display-assembly base	M3x5	8	
Middle frame	Display-assembly base	M3x5, black	13	
Rubber feet	Display-assembly base	M3x5, black	4	
Solid-state drive	System board	M2x2.5	1	

# System-board components

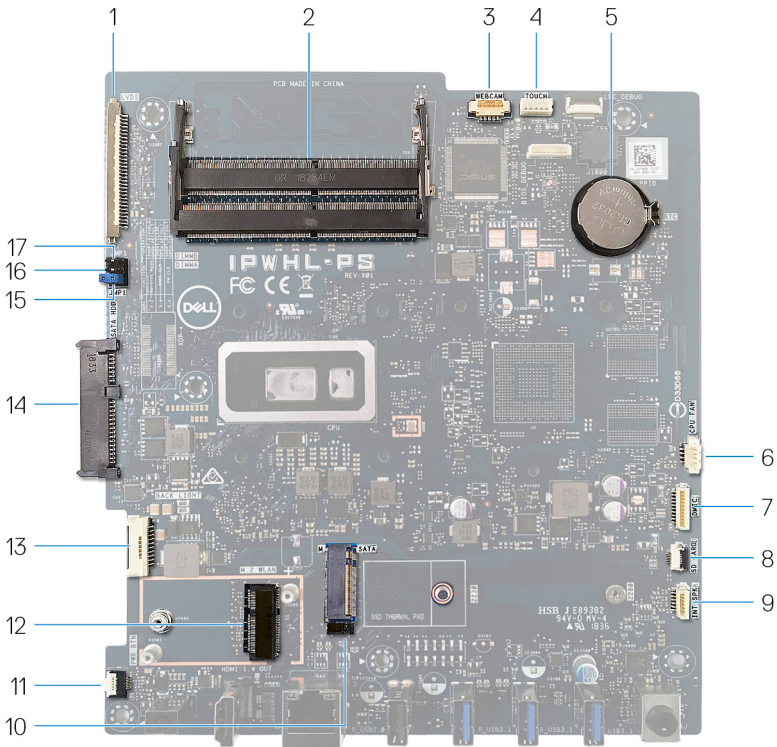

- |    |                                    |    |                                   |
|----|------------------------------------|----|-----------------------------------|
| 1  | display-cable connector            | 2  | memory-module (SO-DIMM) slots (2) |
| 3  | camera-cable connector             | 4  | touchscreen cable connector       |
| 5  | coin-cell battery                  | 6  | fan-cable connector               |
| 7  | microphone-cable connector         | 8  | media-card reader cable connector |
| 9  | speaker-cable connector            | 10 | M.2 PCIe/SATA slot                |
| 11 | power-button board cable connector | 12 | M.2 wireless-card slot connector  |
| 13 | display-backlight cable            | 14 | hard-drive connector              |

15 Password clear jumper  
17 Service mode jumper

16 CMOS clear jumper

# After working inside your computer

---



**CAUTION: Leaving stray or loose screws inside your computer may severely damage your computer.**

- 1** Replace all screws and ensure that no stray screws remain inside your computer.
- 2** Connect any external devices, peripherals, or cables you removed before working on your computer.
- 3** Replace any media cards, discs, or any other parts that you removed before working on your computer.
- 4** Connect your computer and all attached devices to their electrical outlets.
- 5** Turn on your computer.



# Removing the stand

---

**⚠ WARNING:** Before working inside your computer, read the safety information that shipped with your computer and follow the steps in [Before working inside your computer](#). After working inside your computer, follow the instructions in [After working inside your computer](#). For more safety best practices, see the Regulatory Compliance home page at [www.dell.com/regulatory\\_compliance](http://www.dell.com/regulatory_compliance).

## Easel Stand

- 1 **⚠ CAUTION:** Place the computer on a flat, soft, and clean surface to avoid scratches on the display.

Place the computer on a clean and flat surface.

- 2 Using your fingertips, pry the stand cover off the back cover.



- 3 Remove the four screws (M3x5) that secure the stand to the system-board shield.

- 4 Lift and slide the stand from the system-board shield.

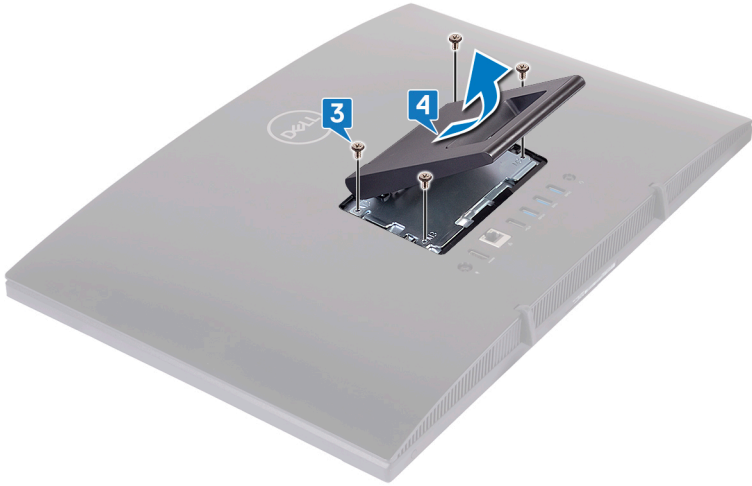

## Pedestal stand

- 1  **CAUTION: Place the computer on a flat, soft, and clean surface to avoid damaging the display.**

Place the computer on a clean and flat surface.

- 2 Extend the stand upward.



- 3 Using your fingertips, pry the stand cover off the back cover.

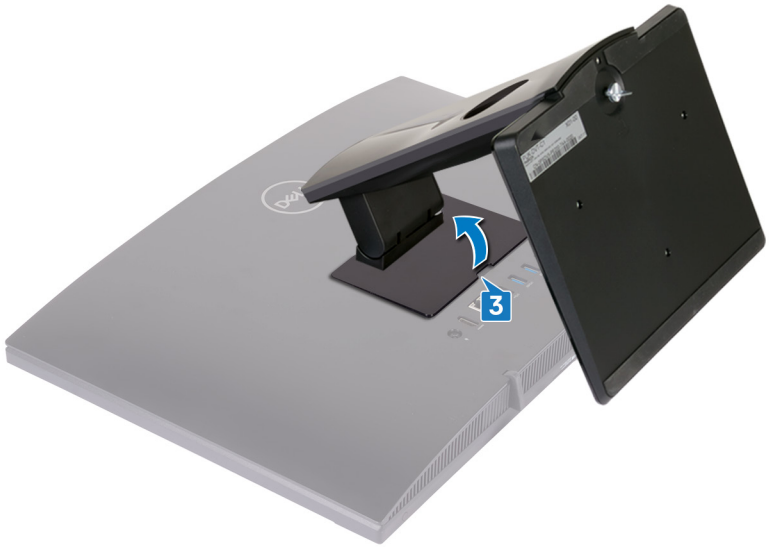

- 4 Remove the four screws (M3x5) that secure the stand bracket to the system-board shield.

5 Lift and slide the stand off the system-board shield.

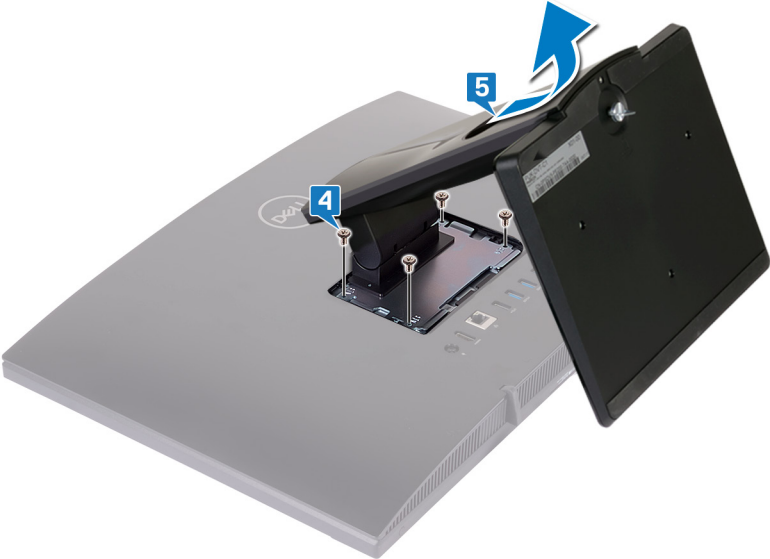

# Replacing the stand

---

 **WARNING:** Before working inside your computer, read the safety information that shipped with your computer and follow the steps in [Before working inside your computer](#). After working inside your computer, follow the instructions in [After working inside your computer](#). For more safety best practices, see the Regulatory Compliance home page at [www.dell.com/regulatory\\_compliance](http://www.dell.com/regulatory_compliance).

## Easel stand

- 1 Insert the tabs on the stand bracket into the slots on the system-board shield and align the screw holes on the stand with the screw holes on the system-board shield.
- 2 Replace the four screws (M3x5) that secure the stand to the system-board shield.

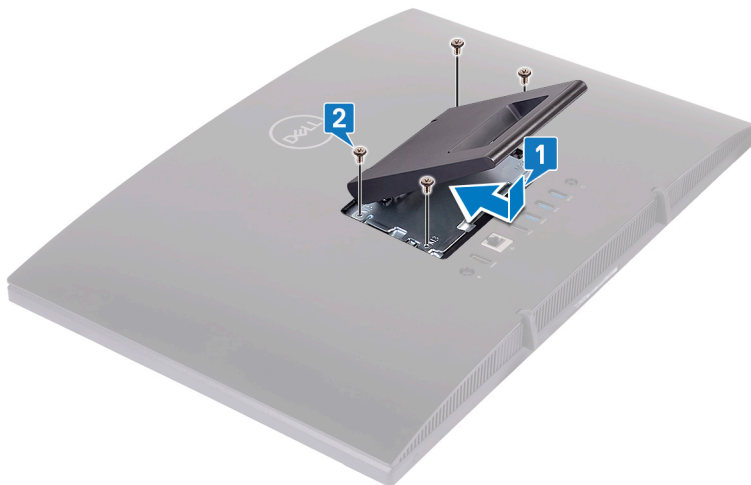

- 3 Replace the stand cover.



## Pedestal stand

- 1 Insert the tabs on the stand bracket into the slots on the system-board shield and align the screw holes on the stand bracket with the screw holes on the system-board shield.

- 2 Replace the four screws (M3x5) that secure the stand bracket to the system-board shield.

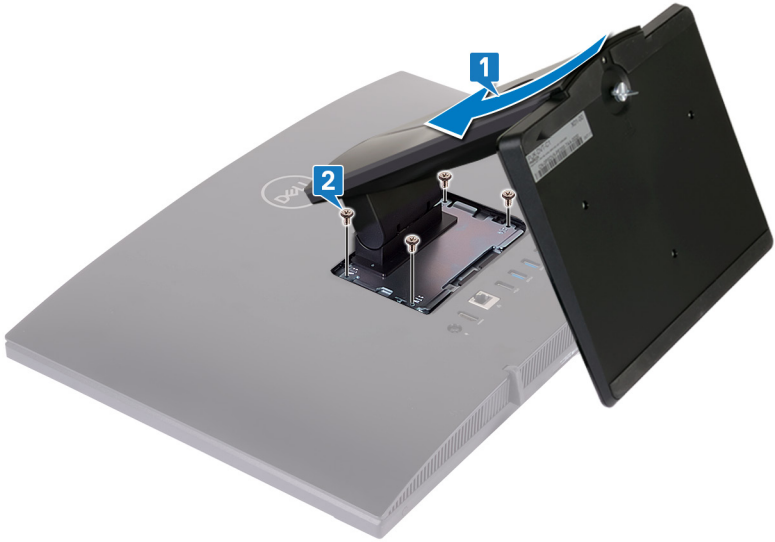

- 3** Replace the stand cover.

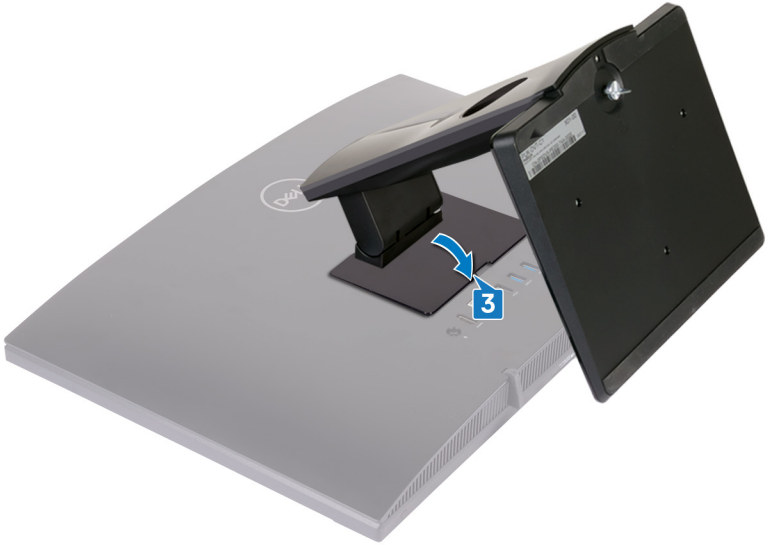

- 4** Place the computer in an upright position.





# Removing the back cover

---



**WARNING:** Before working inside your computer, read the safety information that shipped with your computer and follow the steps in [Before working inside your computer](#). After working inside your computer, follow the instructions in [After working inside your computer](#). For more safety best practices, see the Regulatory Compliance home page at [www.dell.com/regulatory\\_compliance](http://www.dell.com/regulatory_compliance).

## Prerequisite

Remove the [stand](#).

# Procedure

**⚠ CAUTION: Do not remove the computer cover unless you must install or replace internal components on your computer.**

Use one hand to stabilize your computer, and use another hand to pull the back cover from the center to lift it off the display assembly base.



# Replacing the back cover

---

**⚠ WARNING:** Before working inside your computer, read the safety information that shipped with your computer and follow the steps in [Before working inside your computer](#). After working inside your computer, follow the instructions in [After working inside your computer](#). For more safety best practices, see the Regulatory Compliance home page at [www.dell.com/regulatory\\_compliance](http://www.dell.com/regulatory_compliance).

## Procedure

**⚠ CAUTION:** Check and ensure that no cables are caught between the back cover and the display-assembly base.

Align the tabs on the back cover with the slots on the display-assembly base and snap the back cover into place.

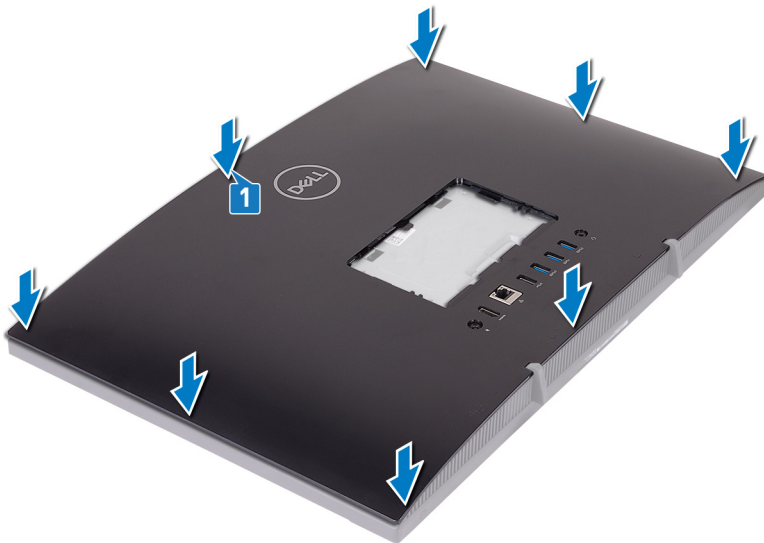

# Post-requisite

Replace the [stand](#).

# Removing the rubber feet

---



**WARNING:** Before working inside your computer, read the safety information that shipped with your computer and follow the steps in [Before working inside your computer](#). After working inside your computer, follow the instructions in [After working inside your computer](#). For more safety best practices, see the Regulatory Compliance home page at [www.dell.com/regulatory\\_compliance](http://www.dell.com/regulatory_compliance).

## Prerequisites

- 1 Remove the [stand](#).
- 2 Remove the [back cover](#).

## Procedure

- 1 Remove the four screws (M3x5 black) that secure the rubber feet to the display-assembly base.

2 Lift the rubber feet off the display-assembly base.

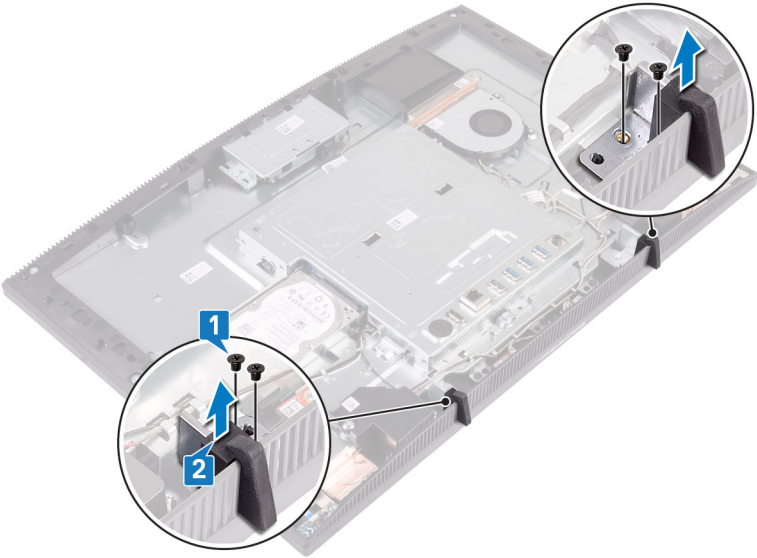

# Replacing the rubber feet

**⚠ WARNING:** Before working inside your computer, read the safety information that shipped with your computer and follow the steps in [Before working inside your computer](#). After working inside your computer, follow the instructions in [After working inside your computer](#). For more safety best practices, see the Regulatory Compliance home page at [www.dell.com/regulatory\\_compliance](http://www.dell.com/regulatory_compliance).

## Procedure

- 1 Align the screw holes on the rubber feet with the screw holes on the display-assembly base.
- 2 Replace the four screws (M3x5 black) that secure the rubber feet to the display-assembly base.

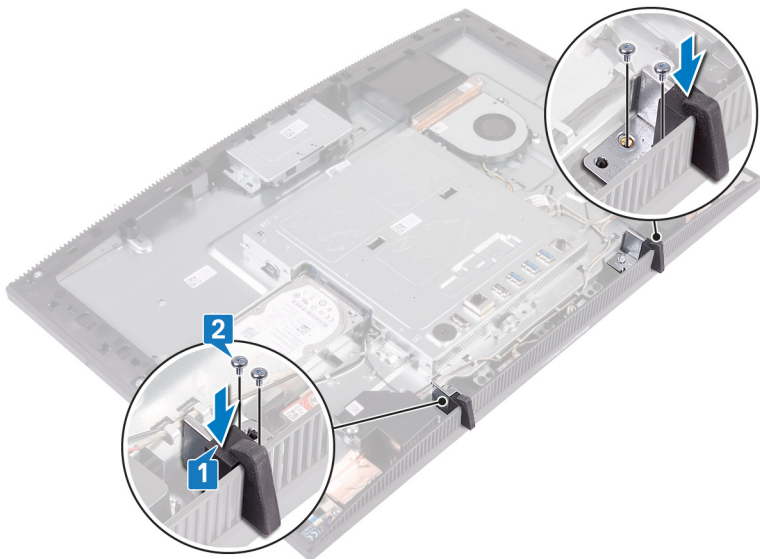

## Post-requisites

- 1 Replace the [back cover](#).

2 Replace the [stand](#).



# Removing the hard drive

---

 **WARNING:** Before working inside your computer, read the safety information that shipped with your computer and follow the steps in [Before working inside your computer](#). After working inside your computer, follow the instructions in [After working inside your computer](#). For more safety best practices, see the Regulatory Compliance home page at [www.dell.com/regulatory\\_compliance](http://www.dell.com/regulatory_compliance).

 **CAUTION:** Hard drives are fragile. Exercise care when handling the hard drive.

 **CAUTION:** To avoid data loss, do not remove the hard drive while the computer is in sleep or on state.

## Prerequisites

- 1 Remove the [stand](#).
- 2 Remove the [back cover](#).

## Procedure

- 1 Remove the screw (M3x5) that secures the hard-drive assembly to the display-assembly base.

- 2 Slide and lift the hard-drive assembly off the display-panel base.

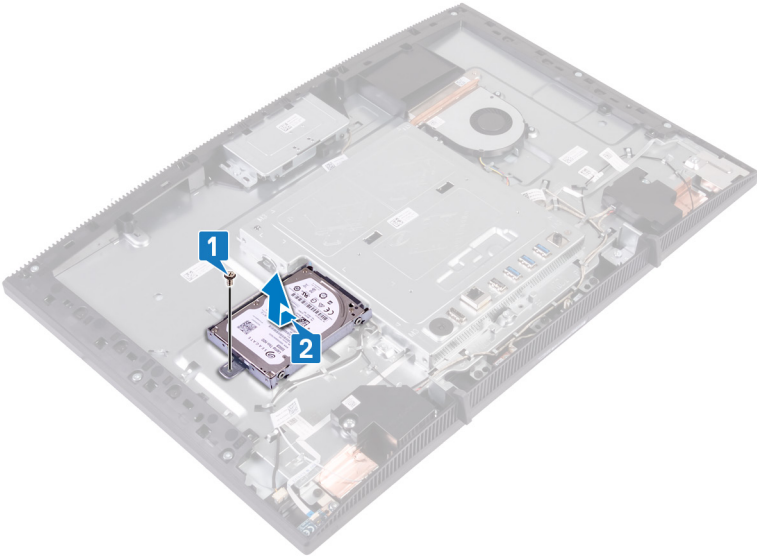

- 3 Remove the four screws (M3x3.5) that secure the hard-drive bracket to the hard drive.
- 4 Lift the hard drive off the hard-drive bracket.



# Replacing the hard drive

---

**⚠ WARNING:** Before working inside your computer, read the safety information that shipped with your computer and follow the steps in [Before working inside your computer](#). After working inside your computer, follow the instructions in [After working inside your computer](#). For more safety best practices, see the Regulatory Compliance home page at [www.dell.com/regulatory\\_compliance](http://www.dell.com/regulatory_compliance).

**⚠ CAUTION:** Hard drives are fragile. Exercise care when handling the hard drive.

## Procedure

- 1 Place the hard drive in the hard-drive bracket with the label facing up.
- 2 Align the screw holes on the hard drive with the screw holes on the hard-drive bracket .
- 3 Replace the four screws (M3x3.5) that secure the hard-drive bracket to the hard drive.



- 4 Align the socket on the hard-drive assembly with the connector on the system board.
- 5 Slide the hard-drive assembly to connect the hard-drive assembly to the system board.

- 6 Replace the screw (M3x5) that secures the hard-drive assembly to the display-assembly base.

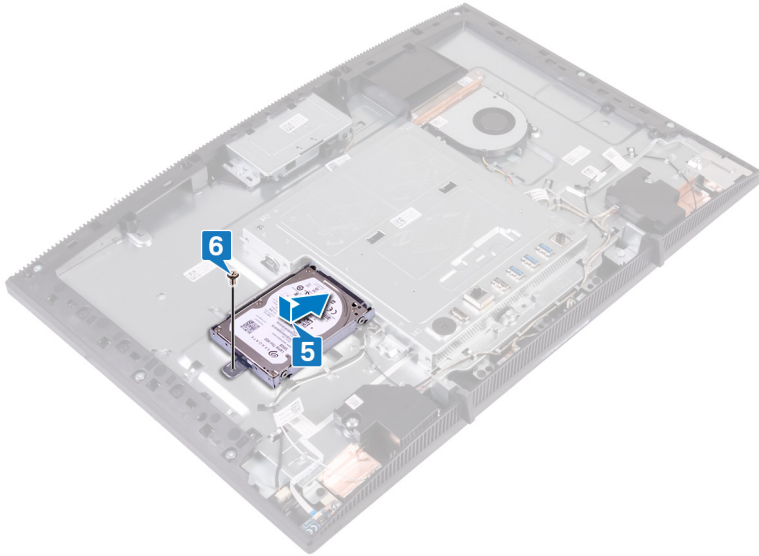

## Post-requisites

- 1 Replace the [back cover](#).
- 2 Replace the [stand](#).

# Removing the system-board shield

---



**WARNING:** Before working inside your computer, read the safety information that shipped with your computer and follow the steps in [Before working inside your computer](#). After working inside your computer, follow the instructions in [After working inside your computer](#). For more safety best practices, see the Regulatory Compliance home page at [www.dell.com/regulatory\\_compliance](http://www.dell.com/regulatory_compliance).

## Prerequisites

- 1 Remove the [stand](#).
- 2 Remove the [back cover](#).

## Procedure

- 1 Remove the five screws (M3x5) that secure the system-board shield to the display-assembly base.

2 Use the handle to lift the system-board shield off the display-assembly base.

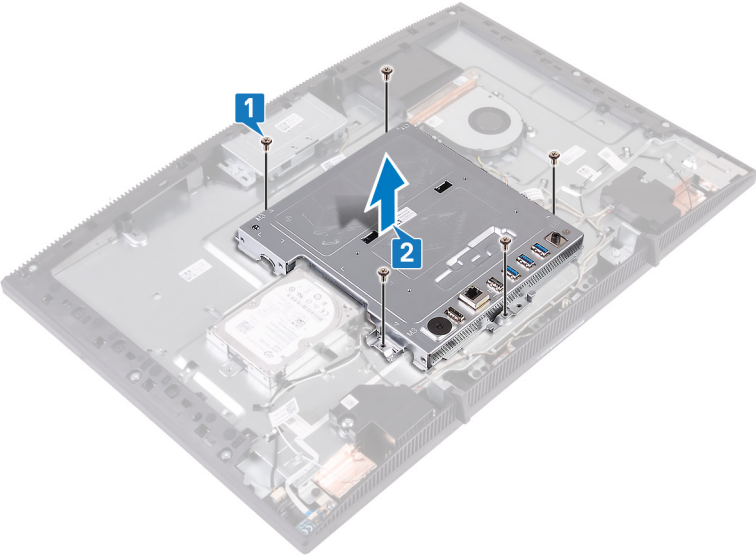

# Replacing the system-board shield

---



**WARNING:** Before working inside your computer, read the safety information that shipped with your computer and follow the steps in [Before working inside your computer](#). After working inside your computer, follow the instructions in [After working inside your computer](#). For more safety best practices, see the Regulatory Compliance home page at [www.dell.com/regulatory\\_compliance](http://www.dell.com/regulatory_compliance).

## Procedure

- 1 Align the slots on the system-board shield with the ports on the system board and place the system-board shield on the display-assembly base.
- 2 Align the screw holes on the system-board shield with the screw holes on the display-assembly base.

- 3 Replace the five screws (M3x5) that secure the system-board shield to the display-assembly base.

 **NOTE:** Ensure that no cable is pinched by the system-board shield.

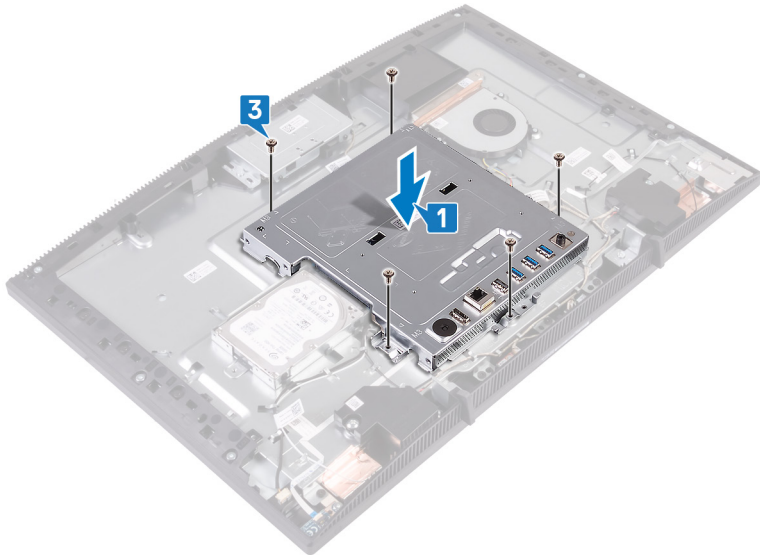

## Post-requisites

- 1 Replace the [back cover](#).
- 2 Replace the [stand](#).



# Removing the memory module

**⚠ WARNING:** Before working inside your computer, read the safety information that shipped with your computer and follow the steps in [Before working inside your computer](#). After working inside your computer, follow the instructions in [After working inside your computer](#). For more safety best practices, see the Regulatory Compliance home page at [www.dell.com/regulatory\\_compliance](http://www.dell.com/regulatory_compliance).

## Prerequisites

- 1 Remove the [stand](#).
- 2 Remove the [back cover](#).
- 3 Remove the [system-board shield](#).

## Procedure

- 1 Locate the memory module on the system board.

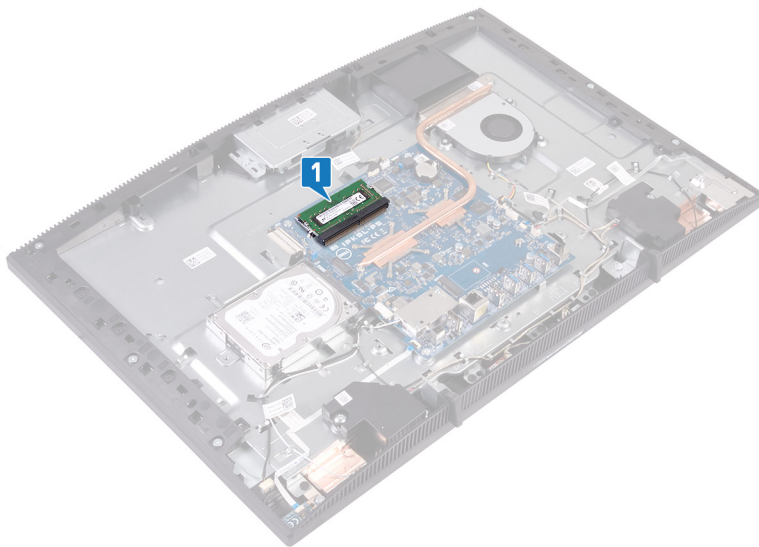

- 2 Using your fingertips, spread apart the securing clips at each end of the memory-module slot until the memory module pops up.
- 3 Slide and remove the memory module from the memory-module slot.

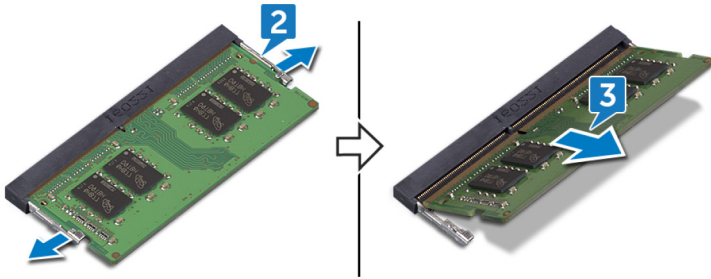

# Replacing the memory module

 **WARNING:** Before working inside your computer, read the safety information that shipped with your computer and follow the steps in [Before working inside your computer](#). After working inside your computer, follow the instructions in [After working inside your computer](#). For more safety best practices, see the Regulatory Compliance home page at [www.dell.com/regulatory\\_compliance](http://www.dell.com/regulatory_compliance).

## Procedure

 **NOTE:** Replace the DIMM2, and then replace the DIMM1.

- 1 Align the notch on the memory module with the tab on the memory-module slot.
- 2 Slide the memory module firmly into the slot at an angle.
- 3 Press the memory module down until it clicks into place.

 **NOTE:** If you do not hear the click, remove the memory module and reinstall it.

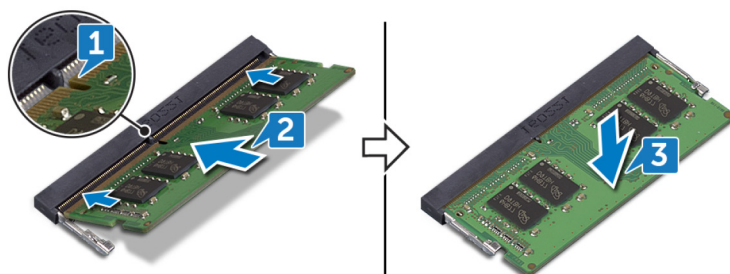

## Post-requisites

- 1 Replace the [system-board shield](#).
- 2 Replace the [back cover](#).
- 3 Replace the [stand](#).

# Removing the wireless card

---



**WARNING:** Before working inside your computer, read the safety information that shipped with your computer and follow the steps in [Before working inside your computer](#). After working inside your computer, follow the instructions in [After working inside your computer](#). For more safety best practices, see the Regulatory Compliance home page at [www.dell.com/regulatory\\_compliance](http://www.dell.com/regulatory_compliance).

## Prerequisites

- 1 Remove the [stand](#).
- 2 Remove the [back cover](#).
- 3 Remove the [system-board shield](#).

## Procedure

- 1 Remove the two screws (M2x2.5) that secure the wireless-card shield to the system board.

- 2 Lift the wireless-card shield from the system board.

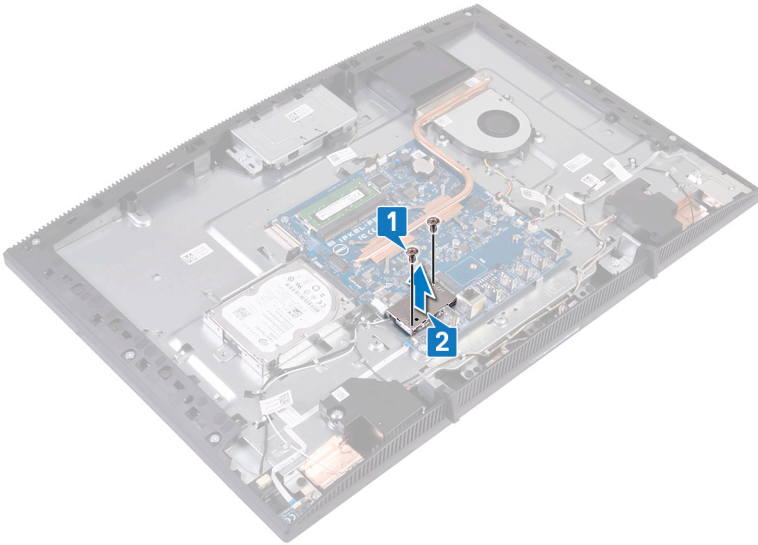

- 3 Remove the screw (M2x2.5) that secures the wireless-card bracket and the wireless card to the system board.
- 4 Slide the wireless-card bracket off the wireless card.
- 5 Disconnect the antenna cables from the wireless card.

6 Slide the wireless card out of the wireless-card slot.

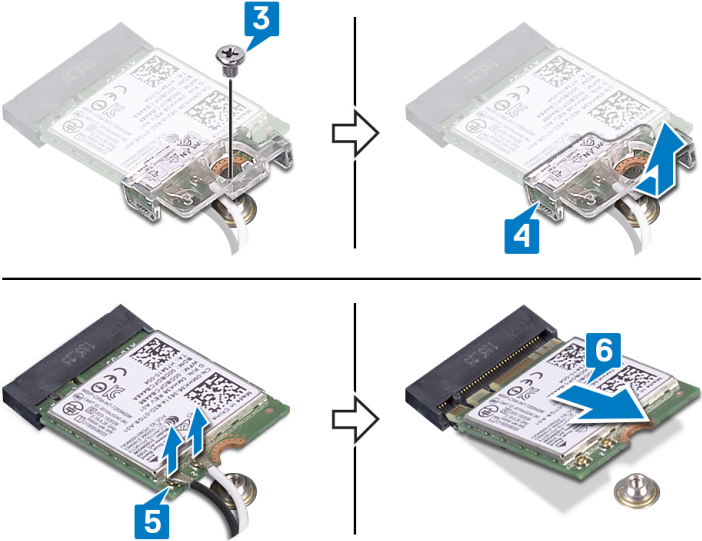

# Replacing the wireless card

---



**WARNING:** Before working inside your computer, read the safety information that shipped with your computer and follow the steps in [Before working inside your computer](#). After working inside your computer, follow the instructions in [After working inside your computer](#). For more safety best practices, see the Regulatory Compliance home page at [www.dell.com/regulatory\\_compliance](http://www.dell.com/regulatory_compliance).

## Procedure

- 1 Connect the antenna cables to the wireless card.

The following table provides the antenna-cable color scheme for the wireless card supported by your computer:

**Table 2. Antenna-cable color scheme**

Connectors on the wireless card	Antenna cable color
Auxiliary (black triangle)	Black
Main (white triangle)	White

- 2 Slide the wireless-card bracket onto the wireless card and secure the antenna cables with the wireless-card bracket.
- 3 Align the notch on the wireless card with the tab on the wireless-card slot, and then insert the wireless card into the wireless-card slot on the system board.
- 4 Press down the other end of the wireless card, and then align the screw hole on the wireless-card bracket and wireless card with the screw hole on the system board.

- 5 Replace the screw that secures the wireless-card bracket and the wireless card to the system board.

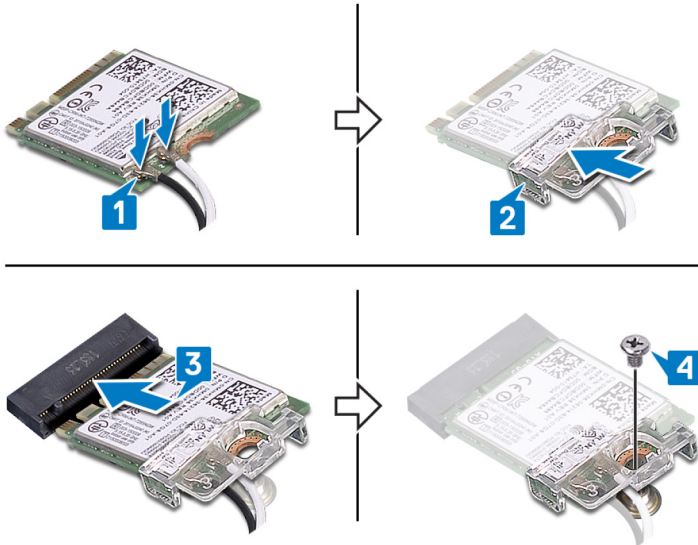

- 6 Place the wireless-card shield on top of the wireless card.

 **NOTE: There is a cut-out on the wireless-card shield for the antenna cables to come out.**

- 7 Align the screw holes on the wireless-card shield with the screw holes on the system board.
- 8 Replace the two screws (M2x2.5) that secure the wireless-card shield to the system board.

## Post-requisites

- 1 Replace the [system-board shield](#).
- 2 Replace the [back cover](#).
- 3 Replace the [stand](#).



# Removing the antennas

---



**WARNING:** Before working inside your computer, read the safety information that shipped with your computer and follow the steps in [Before working inside your computer](#). After working inside your computer, follow the instructions in [After working inside your computer](#). For more safety best practices, see the Regulatory Compliance home page at [www.dell.com/regulatory\\_compliance](http://www.dell.com/regulatory_compliance).

## Prerequisites

- 1 Remove the [stand](#).
- 2 Remove the [back cover](#).
- 3 Remove the [system-board shield](#).
- 4 Remove the [wireless card](#).

## Procedure

- 1 Note the routing of the antenna cables, and remove it from the routing guides on the display-assembly base.
- 2 Remove the two screws (M2x2.5) that secure the antenna modules to the display-assembly base.

3 Peel off the antenna modules from the display-assembly base.

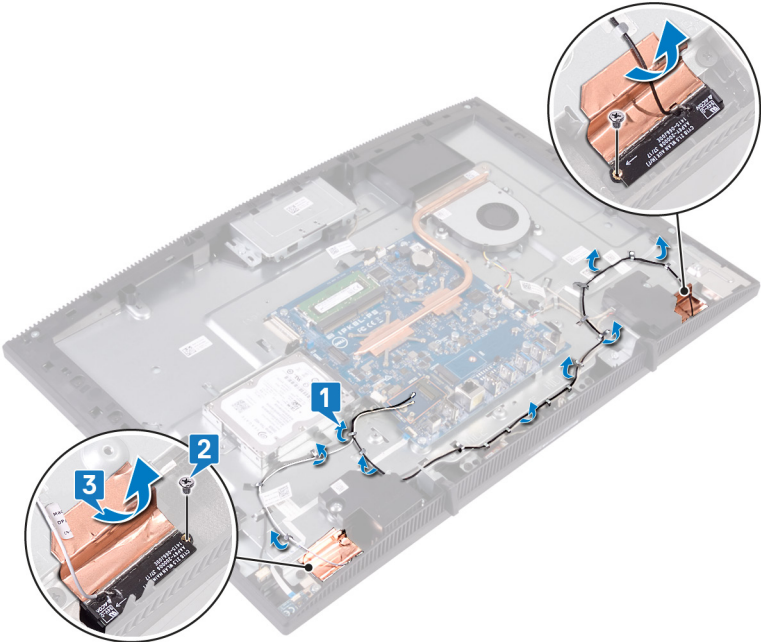

# Replacing the antennas

**⚠ WARNING:** Before working inside your computer, read the safety information that shipped with your computer and follow the steps in [Before working inside your computer](#). After working inside your computer, follow the instructions in [After working inside your computer](#). For more safety best practices, see the Regulatory Compliance home page at [www.dell.com/regulatory\\_compliance](http://www.dell.com/regulatory_compliance).

## Procedure

- 1 Adhere the antennas to the slot on the display-assembly base.
- 2 Replace the two screws (M2x2.5) that secure antennas to the display-assembly base.
- 3 Route the antenna cables through the routing guides on the display-assembly base.

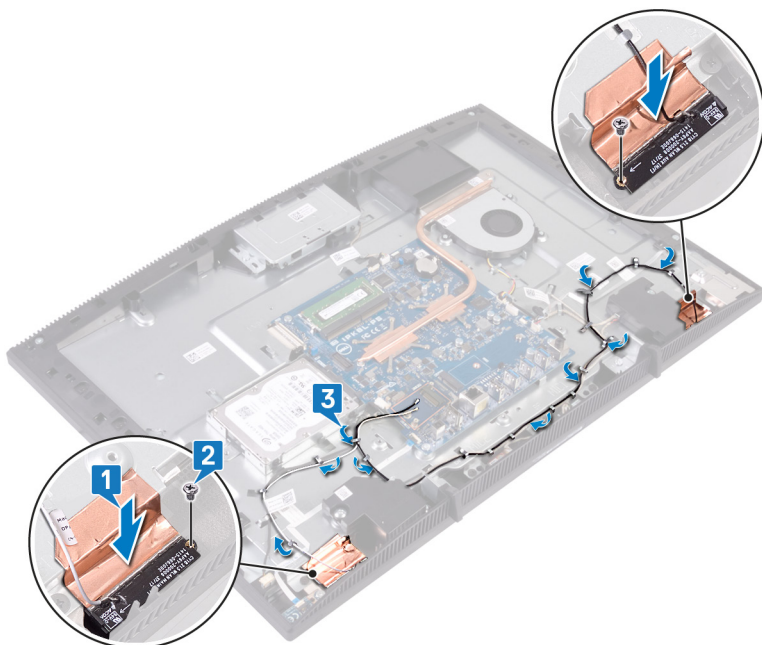

## Post-requisites

- 1 Replace the [wireless card](#).
- 2 Replace the [system-board shield](#).
- 3 Replace the [back cover](#).
- 4 Replace the [stand](#).

# Removing the solid-state drive/ Intel Optane memory module

---

You need to disable the Intel Optane memory before removing Intel Optane memory module from your computer. For more information about disabling the Intel Optane memory, see [Disabling Intel Optane memory](#).



**WARNING:** Before working inside your computer, read the safety information that shipped with your computer and follow the steps in [Before working inside your computer](#). After working inside your computer, follow the instructions in [After working inside your computer](#). For more safety best practices, see the Regulatory Compliance home page at [www.dell.com/regulatory\\_compliance](http://www.dell.com/regulatory_compliance).

## Prerequisites

- 1 Remove the [stand](#).
- 2 Remove the [back cover](#).
- 3 Remove the [system-board shield](#).

## Procedure

- 1 Locate the solid-state drive/Intel Optane memory on the system board.

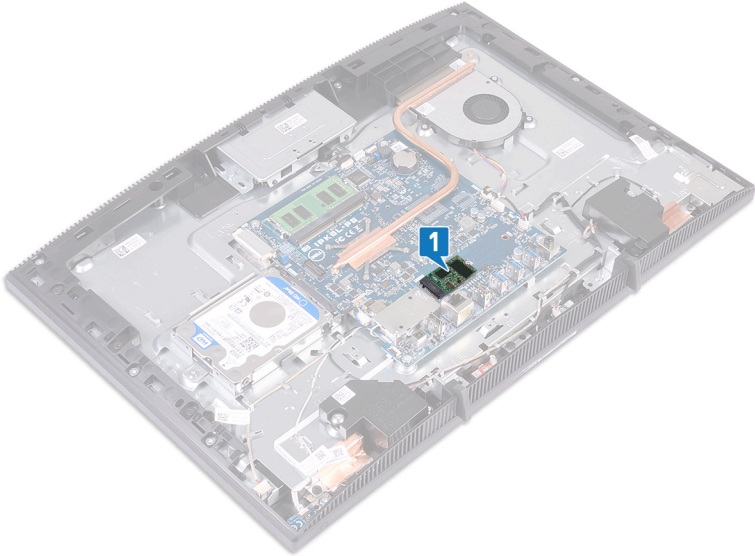

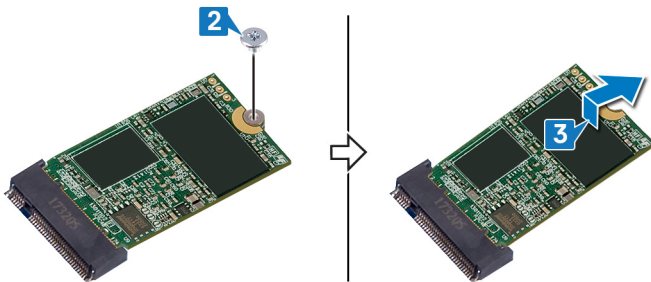

- 2 Remove the screw (M2x3) that secures the solid-state drive/Intel Optane memory to the system board.
- 3 Slide and remove the solid-state drive/Intel Optane memory from the M.2 slot.



# Replacing the solid-state drive/ Intel Optane memory module

---

Enable the Intel Optane memory after you replace the Intel Optane memory module. For more information about enabling the Intel Optane memory, see [Enabling Intel Optane memory](#).

-  **WARNING:** Before working inside your computer, read the safety information that shipped with your computer and follow the steps in [Before working inside your computer](#). After working inside your computer, follow the instructions in [After working inside your computer](#). For more safety best practices, see the Regulatory Compliance home page at [www.dell.com/regulatory\\_compliance](http://www.dell.com/regulatory_compliance).
  
-  **CAUTION:** Solid-state drives are fragile. Exercise care when handling the solid-state drive.

# Procedure

- 1 Replace the thermal pad on the rectangular outline marked on the system board.

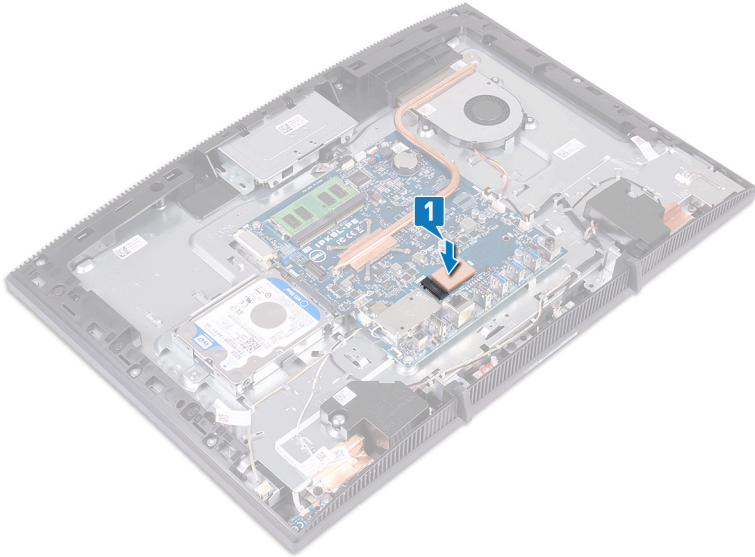

- 2 Align the notch on the solid-state drive/Intel Optane memory with the tab on the solid-state drive/Intel Optane memory slot.
- 3 Slide the solid-state drive/Intel Optane memory firmly into the solid-state drive/Intel Optane memory slot at an angle.



- 4 Press the other end of the solid-state drive/Intel Optane memory and replace the screw (M2x3) that secures the solid-state drive/Intel Optane memory to the keyboard shield.

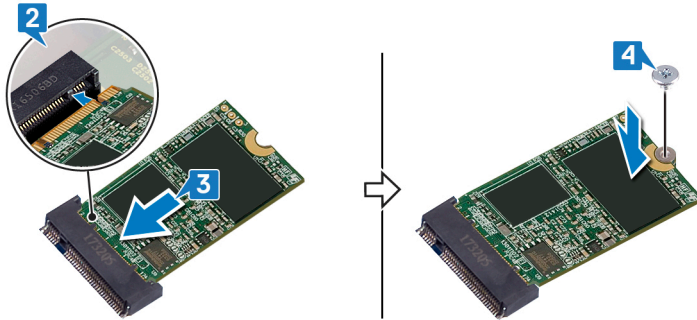

## Post-requisites

- 1 Replace the [system-board shield](#).
- 2 Replace the [back cover](#).
- 3 Replace the [stand](#).

# Removing the media-card reader

---



**WARNING:** Before working inside your computer, read the safety information that shipped with your computer and follow the steps in [Before working inside your computer](#). After working inside your computer, follow the instructions in [After working inside your computer](#). For more safety best practices, see the Regulatory Compliance home page at [www.dell.com/regulatory\\_compliance](http://www.dell.com/regulatory_compliance).

## Prerequisites

- 1 Remove the [stand](#).
- 2 Remove the [back cover](#).
- 3 Remove the [system-board shield](#).

## Procedure

- 1 Open the latch, and disconnect the media-card reader cable from the system board.
- 2 Peel off the media-card reader cable from the display-assembly base and slide it through the microphone cable and speaker cable.
- 3 Remove the screw (M3x5) that secures the media-card reader shield to the display-assembly base.
- 4 Lift the media-card cover from the display-assembly base.
- 5 Remove the screw (M3x5) that secures the media-card reader board to the display-assembly base.

6 Lift the media-card reader board from the display-assembly base.

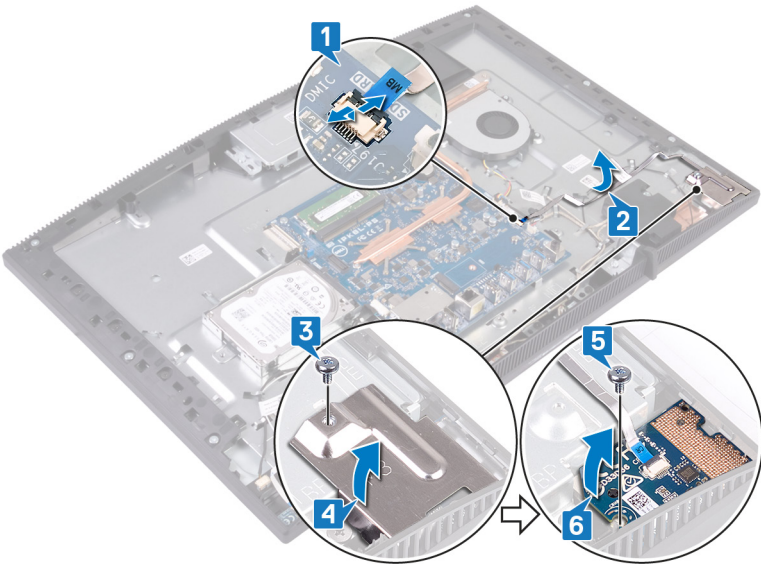

# Replacing the media-card reader

---



**WARNING:** Before working inside your computer, read the safety information that shipped with your computer and follow the steps in [Before working inside your computer](#). After working inside your computer, follow the instructions in [After working inside your computer](#). For more safety best practices, see the Regulatory Compliance home page at [www.dell.com/regulatory\\_compliance](http://www.dell.com/regulatory_compliance).

## Procedure

- 1 Place the media-card reader board on the display-assembly base.
- 2 Using the alignment post, align the screw hole on the media-card reader board with the screw hole on the display-assembly base.
- 3 Replace the screw (M3x5) that secures the media-card reader board to the display-assembly base.
- 4 Place the media-card reader shield on the media-card board and align the screw hole on the media-card reader shield with the screw hole on the display-assembly base.
- 5 Replace the screw (M3x5) that secures the media-card reader shield to the display-assembly base.
- 6 Adhere the media-card reader cable to the display-assembly base.

- 7 Connect the media-card reader cable to the system board.

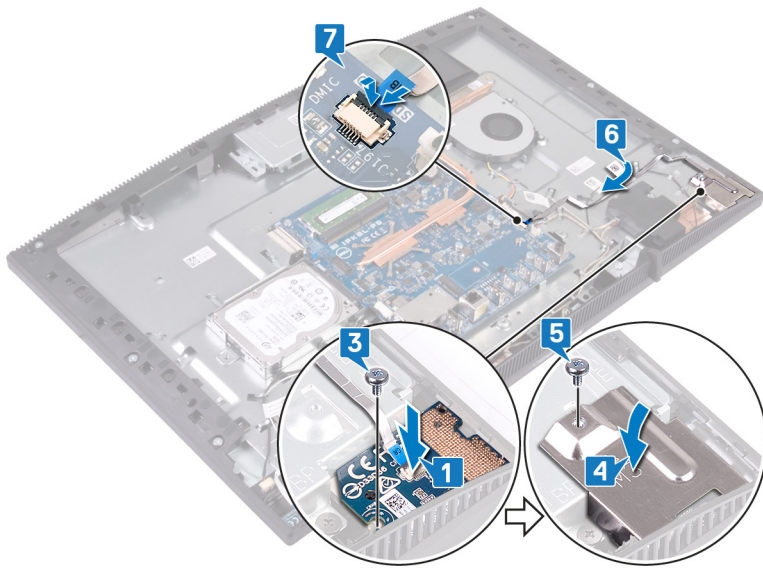

## Post-requisites

- 1 Replace the [system-board shield](#).
- 2 Replace the [back cover](#).
- 3 Replace the [stand](#).

# Removing the power-button board

---



**WARNING:** Before working inside your computer, read the safety information that shipped with your computer and follow the steps in [Before working inside your computer](#). After working inside your computer, follow the instructions in [After working inside your computer](#). For more safety best practices, see the Regulatory Compliance home page at [www.dell.com/regulatory\\_compliance](http://www.dell.com/regulatory_compliance).

## Prerequisites

- 1 Remove the [stand](#).
- 2 Remove the [back cover](#).
- 3 Remove the [system-board shield](#).

## Procedure

- 1 Open the latch, and disconnect the power-button board cable from the system board.
- 2 Peel off the power-button board cable from the display-assembly base and slide it through the antenna cable.
- 3 Remove the screw (M3x5) that secures the power-button board to the display-assembly base.

4 Lift the power-button board, along with its cable, off the display-assembly base.

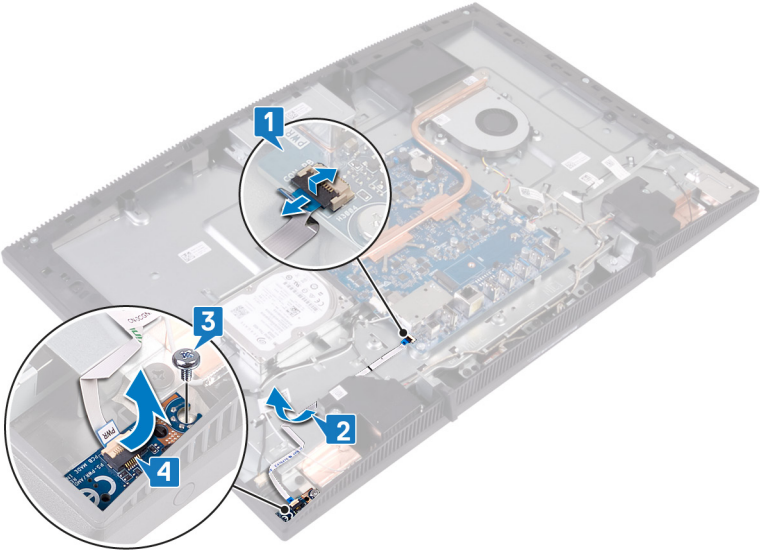

# Replacing the power-button board

---



**WARNING:** Before working inside your computer, read the safety information that shipped with your computer and follow the steps in [Before working inside your computer](#). After working inside your computer, follow the instructions in [After working inside your computer](#). For more safety best practices, see the Regulatory Compliance home page at [www.dell.com/regulatory\\_compliance](http://www.dell.com/regulatory_compliance).

## Procedure

- 1 Using the alignment post, align the screw hole on the power-button board with the screw hole on the display-assembly base.
- 2 Replace the screw (M3x5) that secures the power-button board to the display-assembly base.
- 3 Adhere the power-button board cable to the display-assembly base.



- 4 Slide the power-button board cable into the connector on the system board and close the latch to secure the cable.

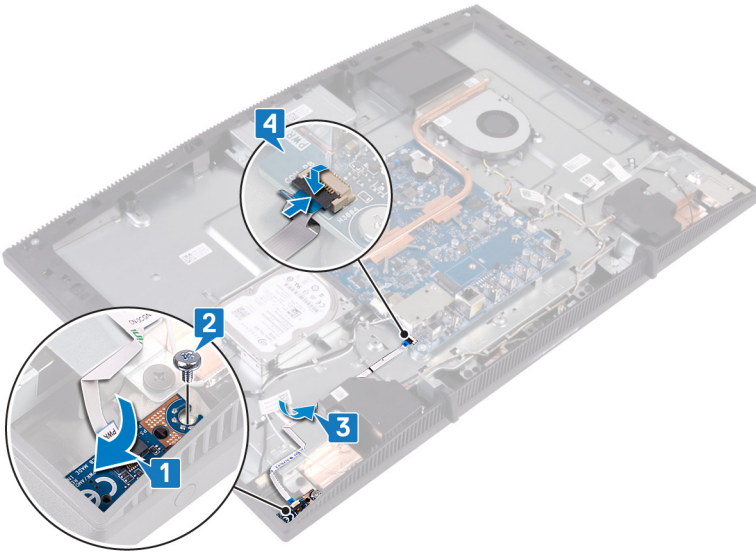

## Post-requisites

- 1 Replace the [system-board shield](#).
- 2 Replace the [back cover](#).
- 3 Replace the [stand](#).

# Removing the microphone

---



**WARNING:** Before working inside your computer, read the safety information that shipped with your computer and follow the steps in [Before working inside your computer](#). After working inside your computer, follow the instructions in [After working inside your computer](#). For more safety best practices, see the Regulatory Compliance home page at [www.dell.com/regulatory\\_compliance](http://www.dell.com/regulatory_compliance).

## Prerequisites

- 1 Remove the [stand](#).
- 2 Remove the [back cover](#).
- 3 Remove the [system-board shield](#).

## Procedure

- 1 Disconnect the microphone cable from the system board.
- 2 Note the routing of the microphone cable, and then remove it from the routing guides on the display-assembly base.
- 3 Remove the two screws (M2x2.5) that secure the microphone boards to the display-assembly base.

4 Lift the microphone boards off the display-assembly base.

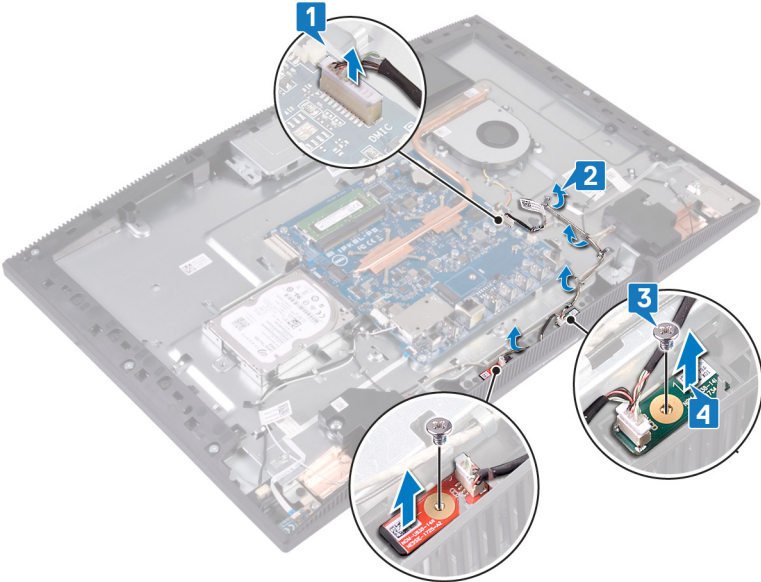

# Replacing the microphone

**⚠ WARNING:** Before working inside your computer, read the safety information that shipped with your computer and follow the steps in [Before working inside your computer](#). After working inside your computer, follow the instructions in [After working inside your computer](#). For more safety best practices, see the Regulatory Compliance home page at [www.dell.com/regulatory\\_compliance](http://www.dell.com/regulatory_compliance).

## Procedure

- 1 Slide the microphone modules into the slots on the display-assembly base.
- 2 Replace the two screws (M2x2.5) that secure the microphone modules to the display-assembly base.
- 3 Route the microphone cable through the routing guides on the display-assembly base.
- 4 Connect the microphone cable to the system board.

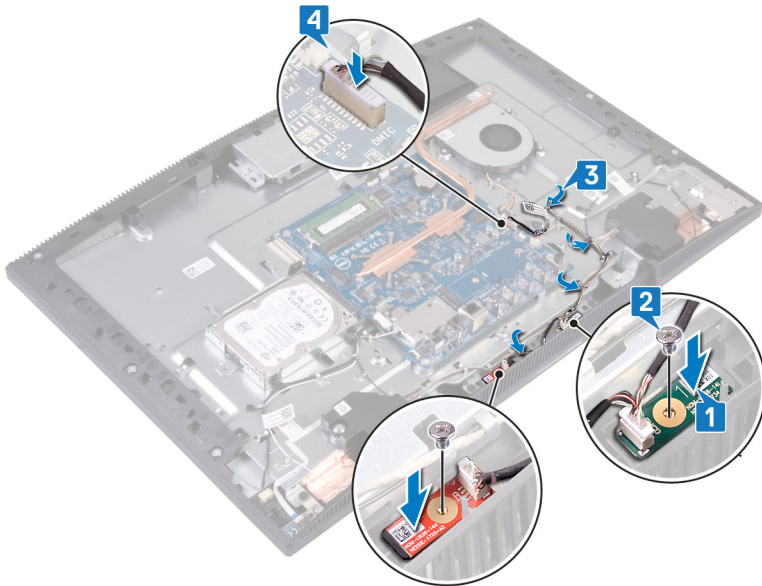

# Post-requisites

- 1 Replace the [system-board shield](#).
- 2 Replace the [back cover](#).
- 3 Replace the [stand](#).

# Removing the camera

---



**WARNING:** Before working inside your computer, read the safety information that shipped with your computer and follow the steps in [Before working inside your computer](#). After working inside your computer, follow the instructions in [After working inside your computer](#). For more safety best practices, see the Regulatory Compliance home page at [www.dell.com/regulatory\\_compliance](http://www.dell.com/regulatory_compliance).

## Prerequisites

- 1 Remove the [stand](#).
- 2 Remove the [back cover](#).
- 3 Remove the [system-board shield](#).

## Procedure

- 1 Disconnect the camera cable from the system board.
- 2 Remove the two screws (M3x5) that secure the retractable-camera assembly to the display-assembly base.
- 3 Slide and lift the retractable-camera assembly out of the display-assembly base.

- 4 Note the routing of the camera cable, and remove it from the routing guides.

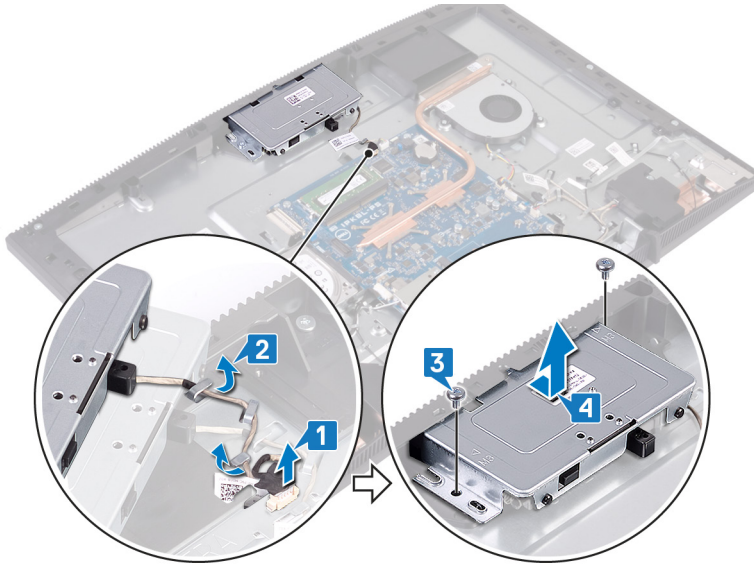

- 5 Press the top of the retractable-camera assembly to extend the retractable camera.

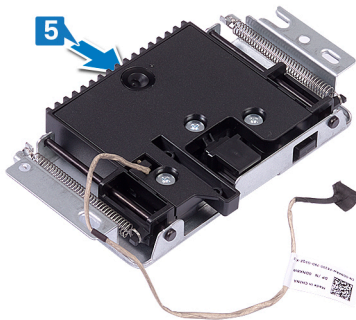

- 6 Remove the three screws (M3x5) that secure the retractable-camera bezel to the retractable-camera assembly.

- 7 Lift the retractable-camera bezel off the retractable-camera assembly.

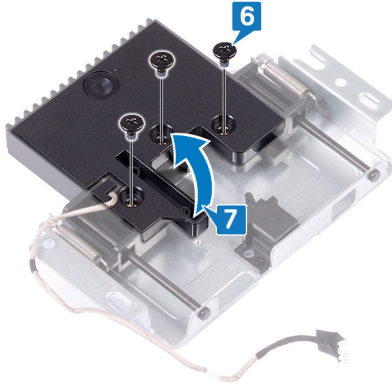

- 8 Pull the clip on the retractable-camera assembly, and rotate the camera and camera bracket along with the camera cable, off the retractable-camera assembly.

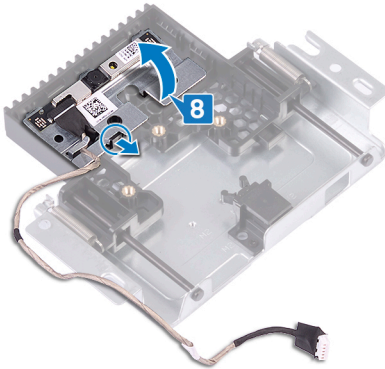



# Replacing the camera

---

-  **WARNING:** Before working inside your computer, read the safety information that shipped with your computer and follow the steps in [Before working inside your computer](#). After working inside your computer, follow the instructions in [After working inside your computer](#). For more safety best practices, see the Regulatory Compliance home page at [www.dell.com/regulatory\\_compliance](http://www.dell.com/regulatory_compliance).

## Procedure

- 1 Place the camera and camera bracket in the slot on the retractable-camera assembly and snap it in place.

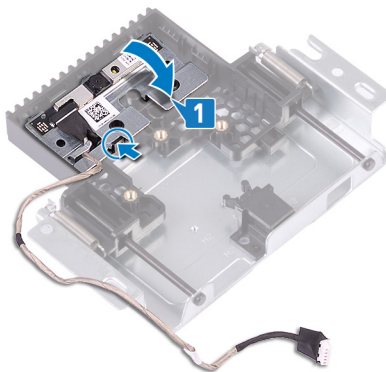

- 2 Align the screw holes on the camera-assembly cover with the screw holes on the retractable-camera assembly.

- 3 Replace the three screws (M3x5) that secure the camera-assembly cover to the retractable-camera assembly.

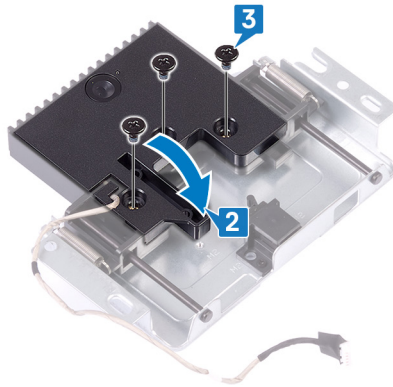

- 4 Press the top of the retractable-camera assembly to retract the retractable camera.

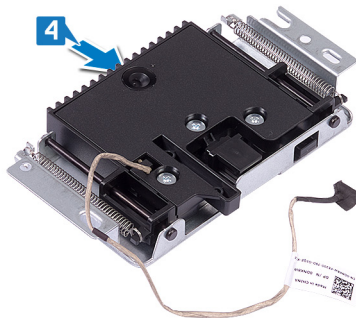

- 5 Route the camera cable through the routing guides on the display-assembly base.
- 6 Place and slide the retractable-camera assembly on the display-panel base, aligning the screw holes on the retractable camera assembly with the screw holes on the display-panel base.
- 7 Replace the two screws (M3x5) that secure the retractable-camera assembly to the display-assembly base.

- 8 Connect the camera cable to the system board.

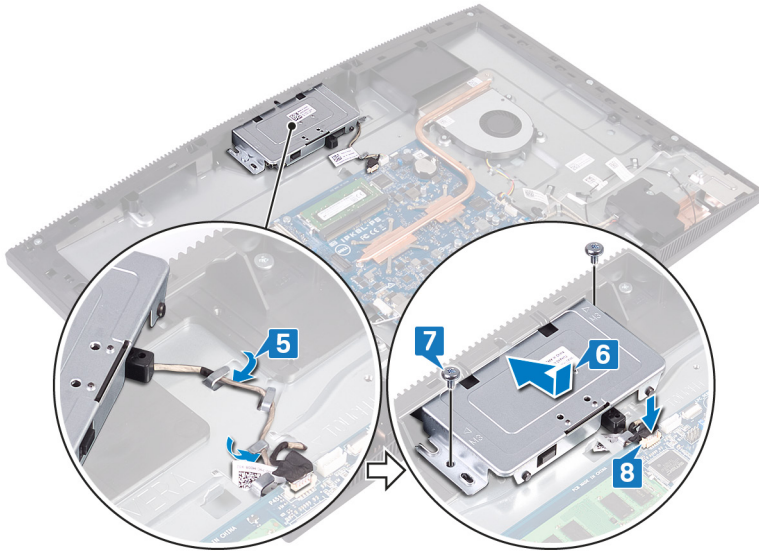



## Post-requisites

- 1 Replace the [system-board shield](#).
- 2 Replace the [back cover](#).
- 3 Replace the [stand](#).

# Removing the coin-cell battery

---

 **WARNING:** Before working inside your computer, read the safety information that shipped with your computer and follow the steps in [Before working inside your computer](#). After working inside your computer, follow the instructions in [After working inside your computer](#). For more safety best practices, see the Regulatory Compliance home page at [www.dell.com/regulatory\\_compliance](http://www.dell.com/regulatory_compliance).

 **CAUTION:** Removing the coin-cell battery resets the BIOS setup program's settings to default. It is recommended that you note the BIOS setup program's settings before removing the coin-cell battery.

## Prerequisites

- 1 Remove the [stand](#).
- 2 Remove the [back cover](#).
- 3 Remove the [system-board shield](#).

# Procedure

- 1 Locate the coin-cell battery on the system board.

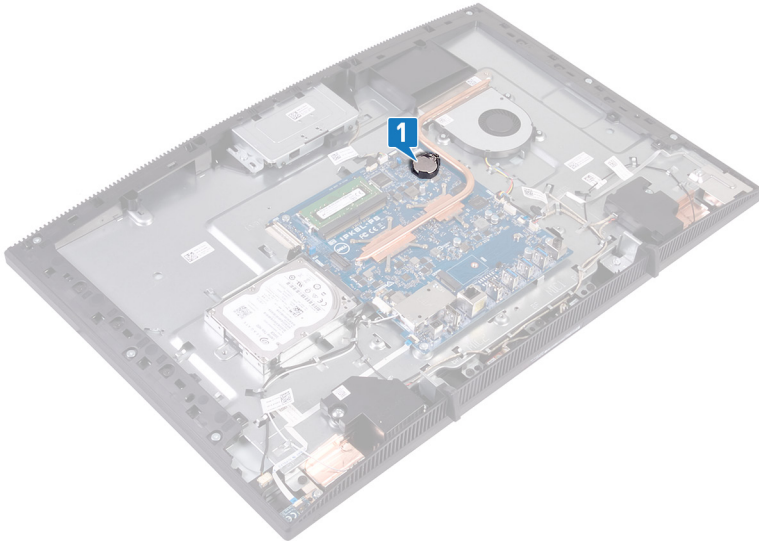

- 2 Press the tab on the coin-cell battery socket until the coin-cell battery pops up.
- 3 Lift the coin-cell battery out of the coin-cell battery socket.

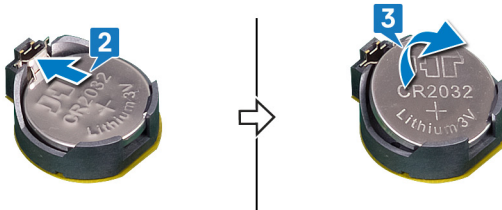

# Replacing the coin-cell battery

**⚠ WARNING:** Before working inside your computer, read the safety information that shipped with your computer and follow the steps in [Before working inside your computer](#). After working inside your computer, follow the instructions in [After working inside your computer](#). For more safety best practices, see the Regulatory Compliance home page at [www.dell.com/regulatory\\_compliance](http://www.dell.com/regulatory_compliance).

## Procedure

- 1 With the positive-side facing up, insert the coin-cell battery into the battery socket.
- 2 Press down the battery into place.

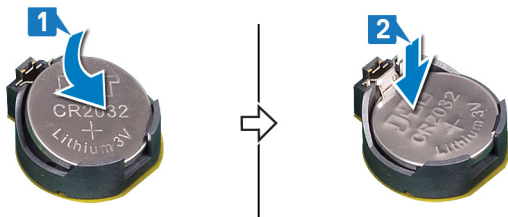

## Post-requisites

- 1 Replace the [system-board shield](#).
- 2 Replace the [back cover](#).
- 3 Replace the [stand](#).

# Removing the fan

---



**WARNING:** Before working inside your computer, read the safety information that shipped with your computer and follow the steps in [Before working inside your computer](#). After working inside your computer, follow the instructions in [After working inside your computer](#). For more safety best practices, see the Regulatory Compliance home page at [www.dell.com/regulatory\\_compliance](http://www.dell.com/regulatory_compliance).

## Prerequisites

- 1 Remove the [stand](#).
- 2 Remove the [back cover](#).
- 3 Remove the [system-board shield](#).

## Procedure

- 1 Disconnect the fan cable from the system board and remove it from the routing guides.
- 2 Remove the three screws (M2x2.5) that secure the fan to the display-assembly base.

**3** Lift and slide the fan from under the heat sink.

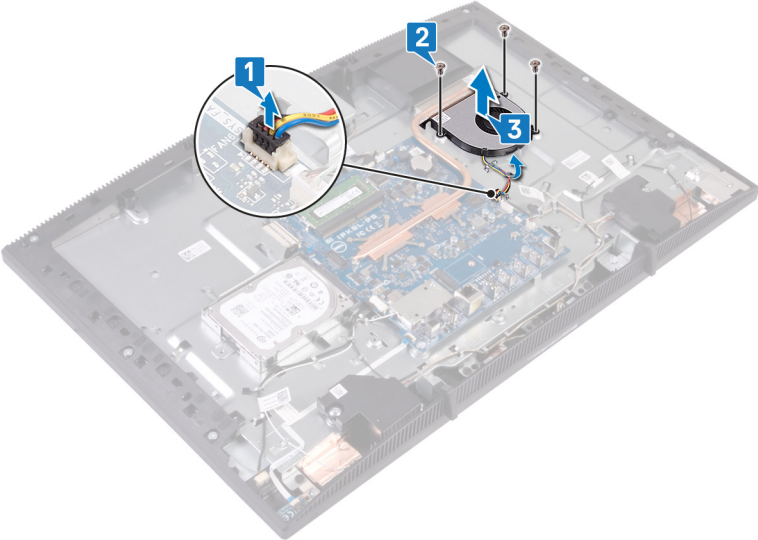



# Replacing the fan

**⚠ WARNING:** Before working inside your computer, read the safety information that shipped with your computer and follow the steps in [Before working inside your computer](#). After working inside your computer, follow the instructions in [After working inside your computer](#). For more safety best practices, see the Regulatory Compliance home page at [www.dell.com/regulatory\\_compliance](http://www.dell.com/regulatory_compliance).

## Procedure

- 1 Slide the fan under the heat sink and place it on the display-assembly base.
- 2 Align the screw holes on the fan with the screw holes on the display-assembly base.
- 3 Replace the three screws (M2x2.5) that secure the fan to the display-assembly base.
- 4 Route the fan cable through the routing guides.
- 5 Connect the fan cable to the system board.

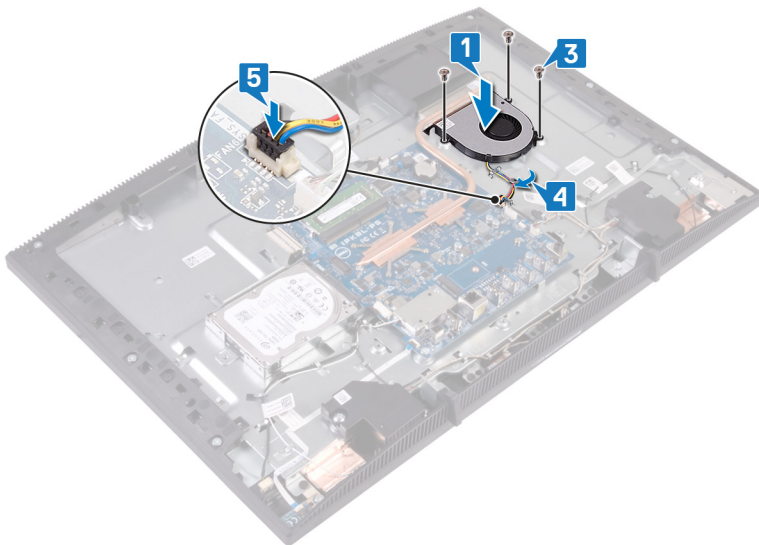

## Post-requisites

- 1 Replace the [system-board shield](#).
- 2 Replace the [back cover](#).
- 3 Replace the [stand](#).

# Removing the heat sink

---

 **WARNING:** Before working inside your computer, read the safety information that shipped with your computer and follow the steps in [Before working inside your computer](#). After working inside your computer, follow the instructions in [After working inside your computer](#). For more safety best practices, see the Regulatory Compliance home page at [www.dell.com/regulatory\\_compliance](http://www.dell.com/regulatory_compliance).

 **WARNING:** The heat sink may become hot during normal operation. Allow sufficient time for the heat sink to cool before you touch it.

 **CAUTION:** For maximum cooling of the processor, do not touch the heat transfer areas on the heat sink. The oils in your skin can reduce the heat transfer capability of the thermal grease.

## Prerequisites

- 1 Remove the [stand](#).
- 2 Remove the [back cover](#).
- 3 Remove the [system-board shield](#).

## Procedure

 **NOTE:** The number of captive screws on the heat sink vary depending on the configuration ordered.

- Without discrete graphics: 4 captive screws
  - Discrete graphics: 7 captive screws
- 1 In reversed order (as indicated on the heat sink), loosen the captive screws that secure the heat sink to the system board.
  - 2 Loosen the captive screw that secures the heat sink to the display-assembly base.

**3** Lift the heat sink off the system board.

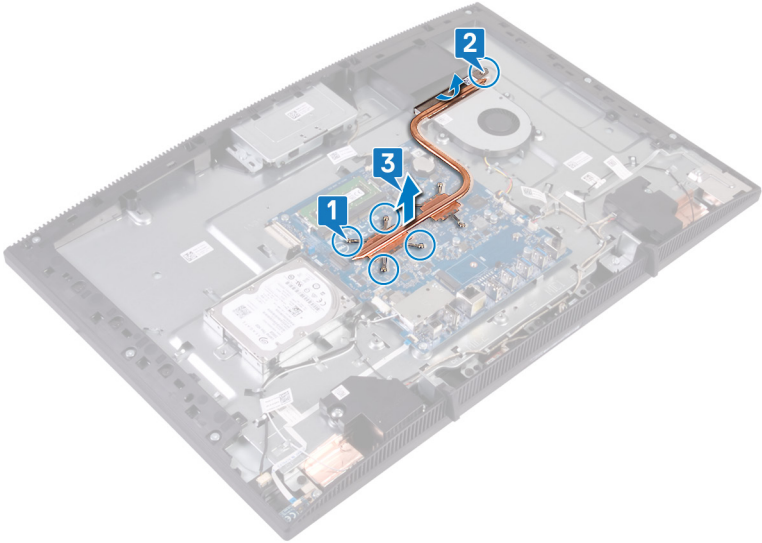

# Replacing the heat sink

---



**WARNING:** Before working inside your computer, read the safety information that shipped with your computer and follow the steps in [Before working inside your computer](#). After working inside your computer, follow the instructions in [After working inside your computer](#). For more safety best practices, see the Regulatory Compliance home page at [www.dell.com/regulatory\\_compliance](http://www.dell.com/regulatory_compliance).



**CAUTION:** Incorrect alignment of the heat sink can damage the system board and processor.



**NOTE:** If either the system board or the heat sink is replaced, use the thermal pad provided in the kit to ensure that thermal conductivity is achieved.

## Procedure



**NOTE:** The number of captive screws on the heat sink vary depending on the configuration ordered.

- Without discrete graphics: 4 captive screws
  - Discrete graphics: 7 captive screws
- 1** Slide the heat sink under the fan shroud and between the fan.
  - 2** Align the captive screws on the heat sink with the screw holes on the system board and the display assembly base.
  - 3** Tighten the captive screw that secures the heat sink to the display-assembly base.

- 4 In sequential order (as indicated on the heat sink), tighten the captive screws that secure the heat sink to the system board.

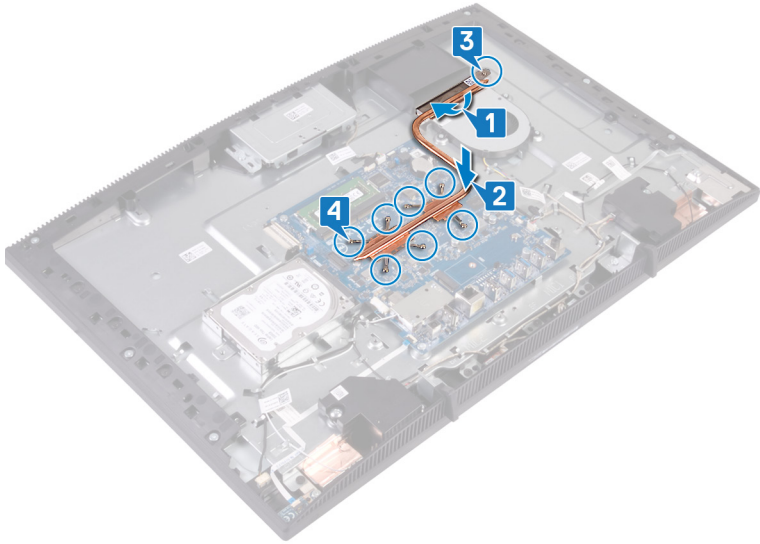

## Post-requisites

- 1 Replace the [system-board shield](#).
- 2 Replace the [back cover](#).
- 3 Replace the [stand](#).

# Removing the speakers

---



**WARNING:** Before working inside your computer, read the safety information that shipped with your computer and follow the steps in [Before working inside your computer](#). After working inside your computer, follow the instructions in [After working inside your computer](#). For more safety best practices, see the Regulatory Compliance home page at [www.dell.com/regulatory\\_compliance](http://www.dell.com/regulatory_compliance).

## Prerequisites

- 1 Remove the [stand](#).
- 2 Remove the [back cover](#).
- 3 Remove the [system-board shield](#).

## Procedure

- 1 Disconnect the speaker cable from the system board.
- 2 Remove the four screws (M3 4+7.1) that secures the tape to the display-assembly base.
- 3 Lift the speaker (SPK1) from the display-assembly base.
- 4 Note the routing of the speaker cable and remove the speaker cable from the routing guides.

- 5 Lift the speaker (SPK2), along with the speaker cable, off the display-assembly base.

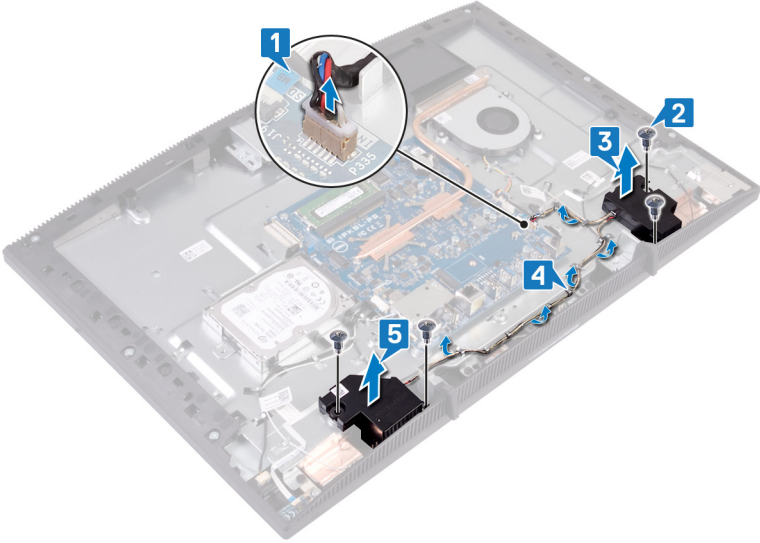



# Replacing the speakers

**⚠ WARNING:** Before working inside your computer, read the safety information that shipped with your computer and follow the steps in [Before working inside your computer](#). After working inside your computer, follow the instructions in [After working inside your computer](#). For more safety best practices, see the Regulatory Compliance home page at [www.dell.com/regulatory\\_compliance](http://www.dell.com/regulatory_compliance).

## Procedure

- 1 Using the alignment posts on the display-assembly base, place the speakers on the display-assembly base.
- 2 Replace the four screws (M3 4+7.1) that secure the speakers to the display-assembly base.
- 3 Route the speaker cable through the routing guides on the display-assembly base.
- 4 Connect the speaker cable to the system board.

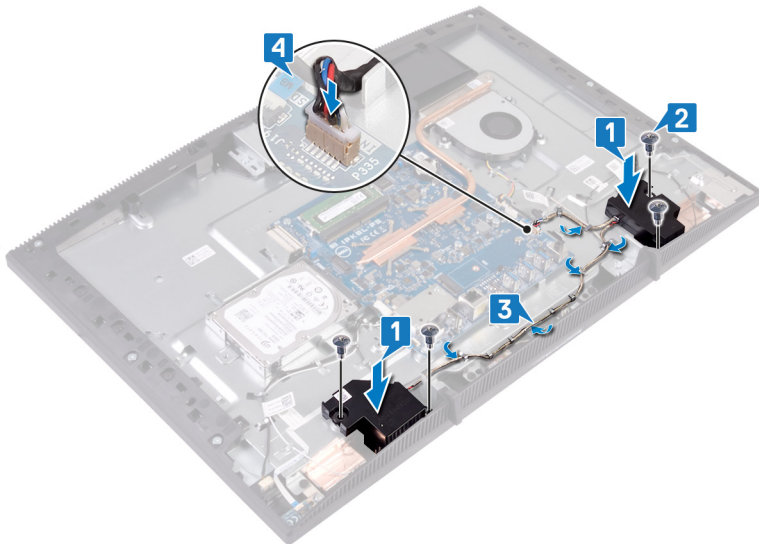

## Post-requisites

- 1 Replace the [system-board shield](#).
- 2 Replace the [back cover](#).
- 3 Replace the [stand](#).

# Removing the system board

---



**WARNING:** Before working inside your computer, read the safety information that shipped with your computer and follow the steps in [Before working inside your computer](#). After working inside your computer, follow the instructions in [After working inside your computer](#). For more safety best practices, see the Regulatory Compliance home page at [www.dell.com/regulatory\\_compliance](http://www.dell.com/regulatory_compliance).



**NOTE:** Your computer's Service Tag is stored in the system board. You must enter the Service Tag in the BIOS setup program after you replace the system board.



**NOTE:** Replacing the system board removes any changes you have made to the BIOS using the BIOS setup program. You must make the appropriate changes again after you replace the system board.



**NOTE:** Before disconnecting the cables from the system board, note the location of the connectors so that you can reconnect the cables correctly after you replace the system board.

## Prerequisites

- 1 Remove the [stand](#).
- 2 Remove the [back cover](#).
- 3 Remove the [hard drive](#).
- 4 Remove the [system-board shield](#).
- 5 Remove the [heat sink](#).
- 6 Remove the [memory module](#).
- 7 Remove the [wireless card](#).

## Procedure

- 1 Disconnect the camera cable from the system board.
- 2 Disconnect the touch-screen cable from the system board.
- 3 Disconnect the fan cable from the system board.
- 4 Disconnect the microphone cable from the system board.

- 5 Open the latch, and disconnect the media-card reader cable from the system board.
- 6 Disconnect the speaker cable from the system board.
- 7 Open the latch, and disconnect the power-button board cable from the system board.
- 8 Disconnect the display-backlight cable from the system board.
- 9 Peel off the tape that secures the display cable from the connector on the system board.
- 10 Using your finger tips, push the securing clips on the display cable inwards and disconnect the display cable from the system board.

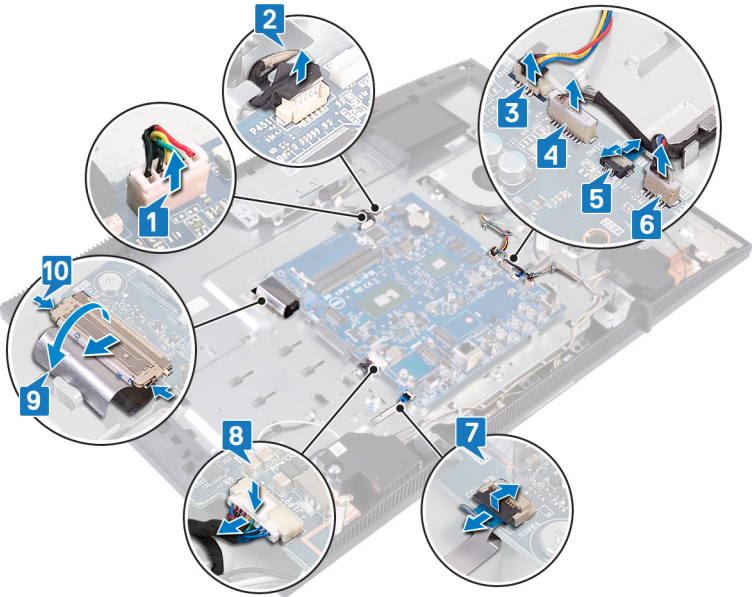

- 11 Remove the six screws (M3x5) that secure the system board to the display-assembly base.

12 Lift the system board off the display-assembly base.

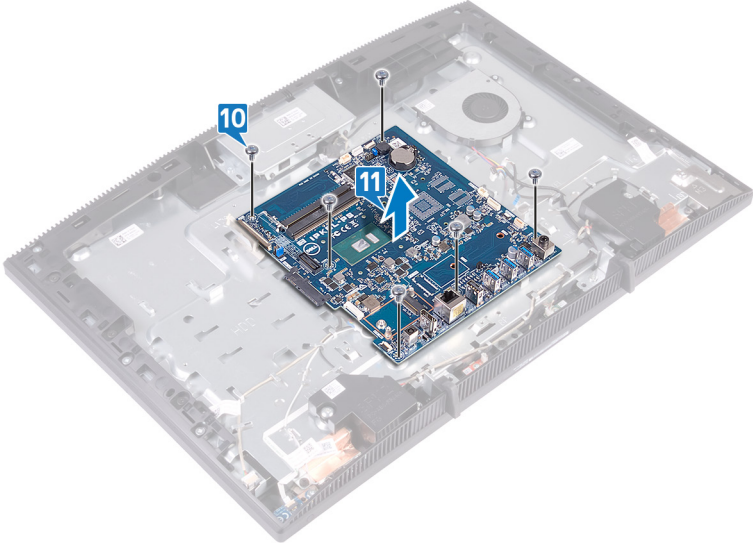

# Replacing the system board

---



**WARNING:** Before working inside your computer, read the safety information that shipped with your computer and follow the steps in [Before working inside your computer](#). After working inside your computer, follow the instructions in [After working inside your computer](#). For more safety best practices, see the Regulatory Compliance home page at [www.dell.com/regulatory\\_compliance](http://www.dell.com/regulatory_compliance).



**NOTE:** Your computer's Service Tag is stored in the system board. You must enter the Service Tag in the BIOS setup program after you replace the system board.



**NOTE:** Replacing the system board removes any changes you have made to the BIOS using the BIOS setup program. You must make the appropriate changes again after you replace the system board.

## Procedure

- 1 Align the screw holes on the system board with the screw holes on the display-assembly base.

- 
- 2** Replace the six screws (M3x5) that secure the system board to the display-assembly base.

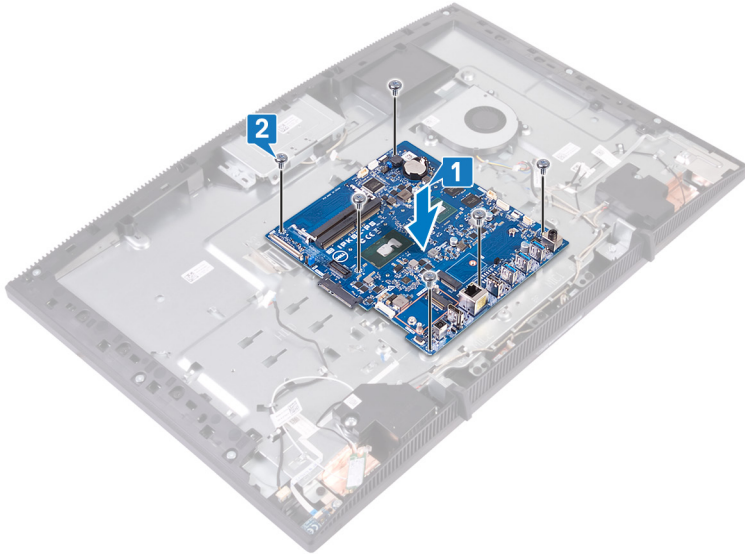

- 
- 
- 3** Slide the display cable into the connector on the system board and close the latch to secure the cable.
- 4** Adhere the tape that secures the display cable from the connector on the system board.
- 5** Connect the display-backlight cable to the system board.
- 6** Slide the power-button board cable into the connector on the system board and close the latch to secure the cable.
- 7** Connect the microphone cable to the system board.
- 8** Slide the media-card reader cable into the connector on the system board and close the latch to secure the cable.
- 9** Connect the speaker cable to the system board.
- 10** Connect the fan cable to the system board.

- 11 Connect the touch-screen cable and camera cable to the system board.

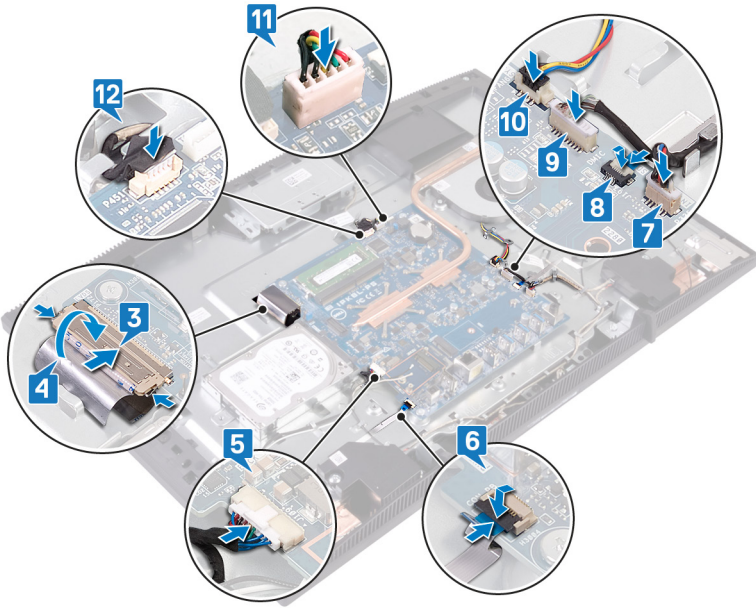

## Post-requisites

- 1 Replace the [wireless card](#).
- 2 Replace the [memory module](#).
- 3 Replace the [heat sink](#).
- 4 Replace the [system-board shield](#).
- 5 Replace the [hard drive](#).
- 6 Replace the [back cover](#).
- 7 Replace the [stand](#).

## Flashing the BIOS

You may need to flash (update) the BIOS when an update is available or when you replace the system board.



Follow these steps to flash the BIOS:

- 1 Turn on your computer.
- 2 Go to [www.dell.com/support](http://www.dell.com/support).
- 3 Click **Product support**, enter the Service Tag of your computer, and then click **Submit**.  
 **NOTE: If you do not have the Service Tag, use the auto-detect feature or manually browse for your computer model.**
- 4 Click **Drivers & downloads** → **Find it myself**.
- 5 Select the operating system installed on your computer.
- 6 Scroll down the page and expand **BIOS**.
- 7 Click **Download** to download the latest version of the BIOS for your computer.
- 8 After the download is complete, navigate to the folder where you saved the BIOS update file.
- 9 Double-click the BIOS update file icon and follow the instructions on the screen.

# Removing the display panel

---



**WARNING:** Before working inside your computer, read the safety information that shipped with your computer and follow the steps in [Before working inside your computer](#). After working inside your computer, follow the instructions in [After working inside your computer](#). For more safety best practices, see the Regulatory Compliance home page at [www.dell.com/regulatory\\_compliance](http://www.dell.com/regulatory_compliance).

## Prerequisites

- 1 Remove the [stand](#).
- 2 Remove the [back cover](#).
- 3 Remove the [system-board shield](#).

## Procedure

- 1 Peel off the tape that secures the display cable to the connector on the system board.
- 2 Using your finger tips, push the securing clips on the display cable inwards and disconnect it from the system board.
- 3 Disconnect the display back-light cable and touch-screen cable (optional) from the display panel.

- 4 Remove the eight screws (M3x5) that secure the display-assembly base to the display assembly.

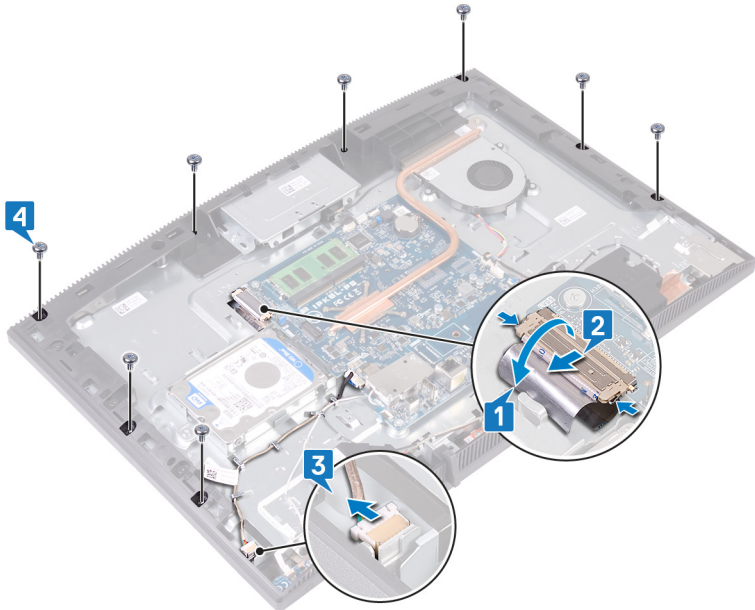

- 5 Place the display-assembly base in its upright position.
- 6 Push the display panel away from the display-assembly base.
- 7 Slide the display cable and the touch-screen cable (optional) through the slots on the display-assembly base.

8 Lift the display panel off the display-assembly base.

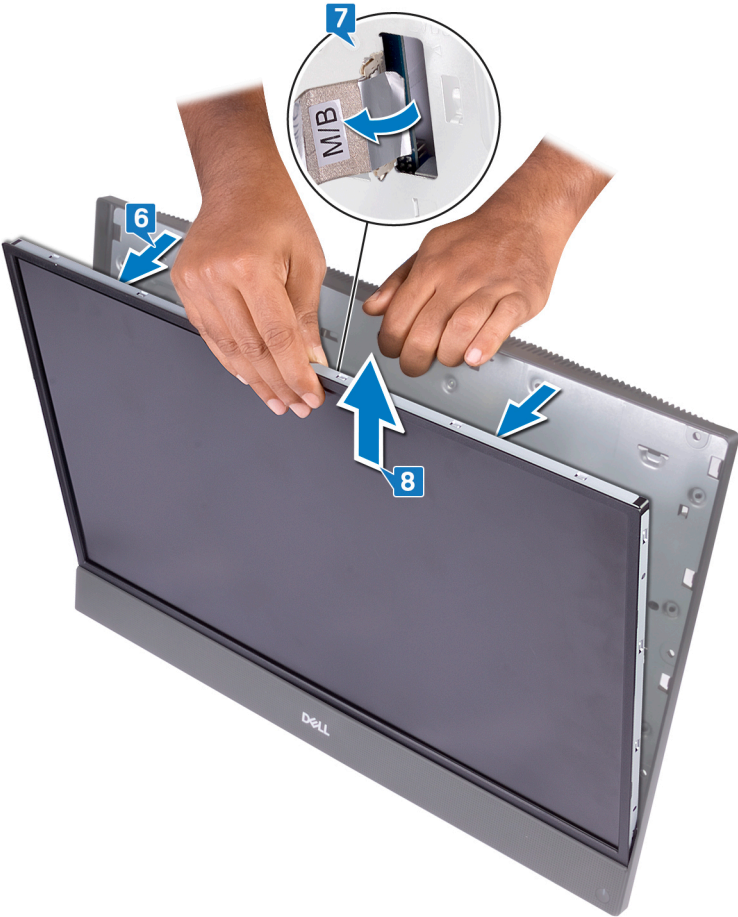

9 After performing the above steps, you are left with the display panel.



# Replacing the display panel

 **WARNING:** Before working inside your computer, read the safety information that shipped with your computer and follow the steps in [Before working inside your computer](#). After working inside your computer, follow the instructions in [After working inside your computer](#). For more safety best practices, see the Regulatory Compliance home page at [www.dell.com/regulatory\\_compliance](http://www.dell.com/regulatory_compliance).

## Procedure

- 1 Note the positions of the four jig screws on the display panel.



- 2 Place the display-assembly base in its upright position, and slide the display panel into the display-assembly base.
- 3 Push the display cable and the touch-screen cable (optional) through the slot on the display-assembly base.
- 4 Align the four jig screws on the display panel with the screw holes on the display-assembly base.

- 5 Push the display panel into the slot on the display-assembly base.

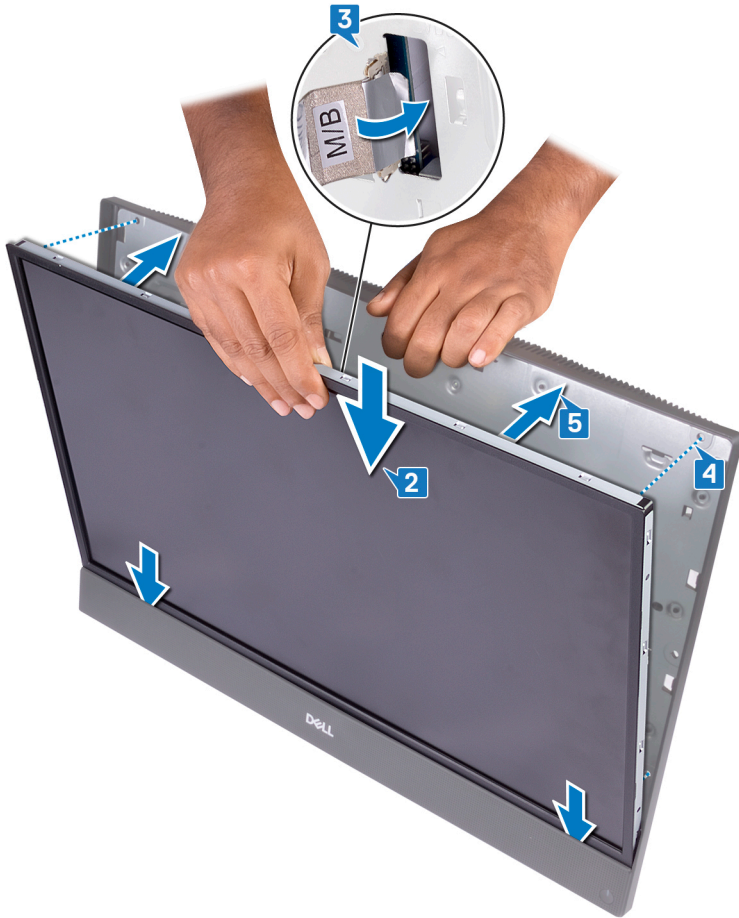

- 6 Place the display-assembly base on a clean and flat surface with the display panel facing down.

- 7 In sequential order indicated on the image, replace the four screws (M3x5) that secure the display panel to the display-assembly base.

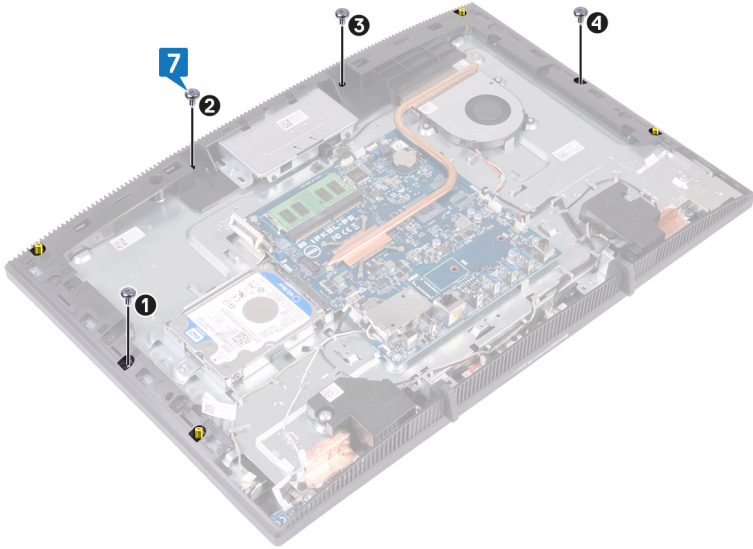



- 8 Remove the four jig screws from the display panel.

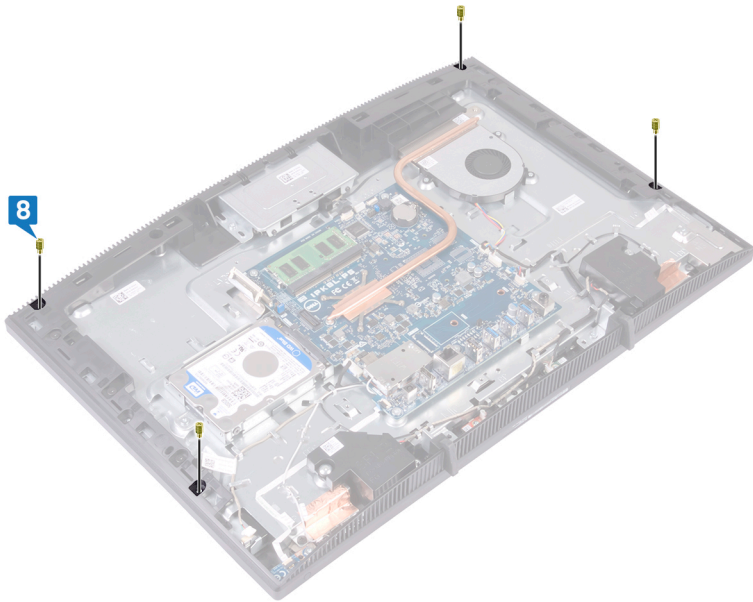

- 9 Replace the four screws (M3x5) that secure the display panel to the display-assembly base.
- 10 Connect the display-backlight cable to the display panel, and then connect the touch-screen cable (optional) to the system board.
- 11 Push the securing clips inward, and connect the display cable to the system board.

- 12 Adhere the tape that secures the display cable to the connector on the system board.

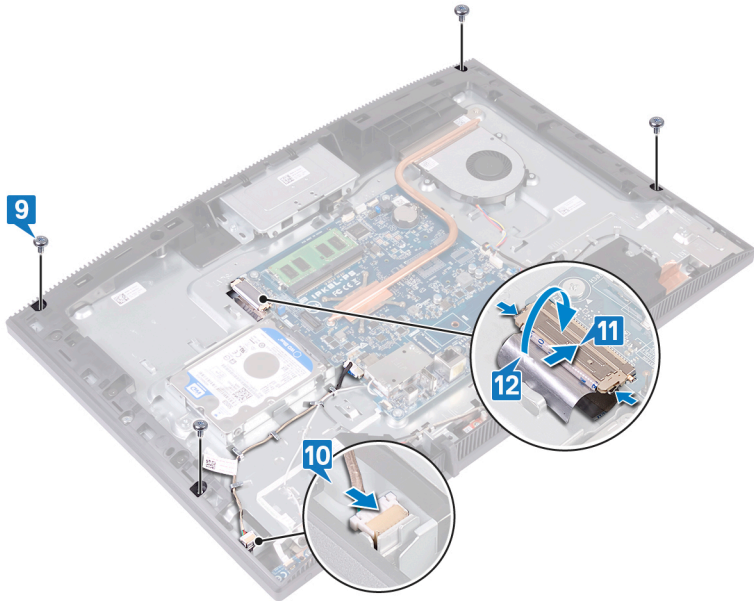

## Post-requisites

- 1 Replace the [system-board shield](#).
- 2 Replace the [back cover](#).
- 3 Replace the [stand](#).

# Removing the middle frame

---



**WARNING:** Before working inside your computer, read the safety information that shipped with your computer and follow the steps in [Before working inside your computer](#). After working inside your computer, follow the instructions in [After working inside your computer](#). For more safety best practices, see the Regulatory Compliance home page at [www.dell.com/regulatory\\_compliance](http://www.dell.com/regulatory_compliance).

## Prerequisites

- 1 Remove the [stand](#).
- 2 Remove the [back cover](#).
- 3 Remove the [hard drive](#).
- 4 Remove the [system-board shield](#).
- 5 Remove the [memory module](#).
- 6 Remove the [wireless card](#).
- 7 Remove the [antenna](#).
- 8 Remove the [media-card reader](#).
- 9 Remove the [power-button board](#).
- 10 Remove the [microphone](#).
- 11 Remove the [camera](#).
- 12 Remove the [coin-cell battery](#).
- 13 Remove the [fan](#).
- 14 Remove the [heat sink](#).
- 15 Remove the [speakers](#).
- 16 Remove the [system board](#).
- 17 Remove the [display panel](#).
- 18 Remove the [rubber feet](#).

## Procedure

- 1 Remove the 13 screws (M3x5 black) that secure the middle frame to the display-assembly base.

- 2** Slide and lift to release the tabs on the middle frame from the slots on the display-assembly base from the top.

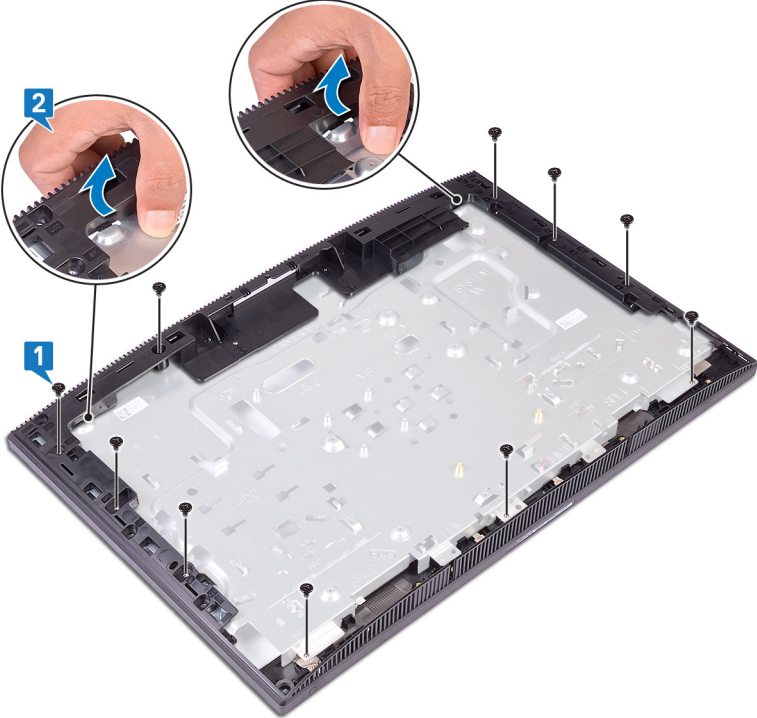

3 Lift and slide the middle frame off the display-assembly base.

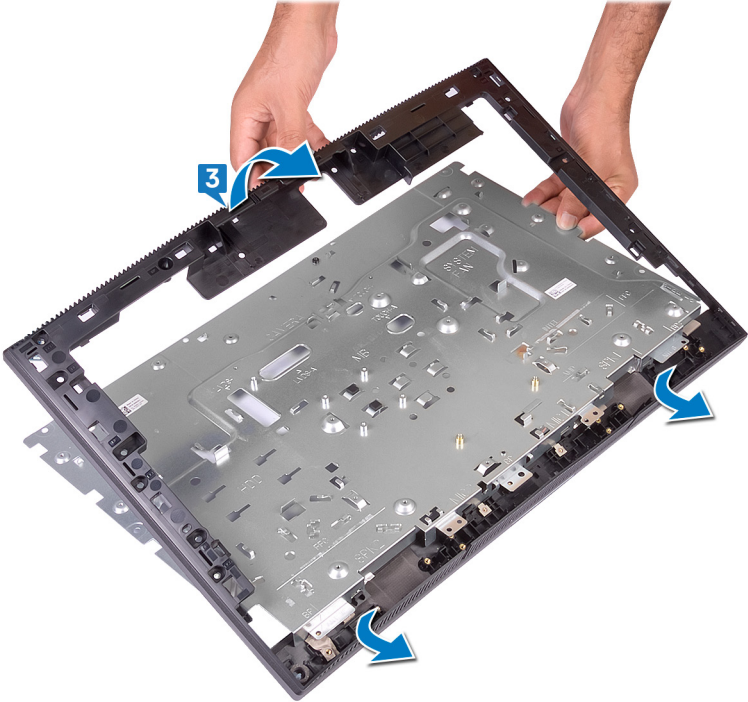

4 After performing the above steps, you are left with the middle frame.

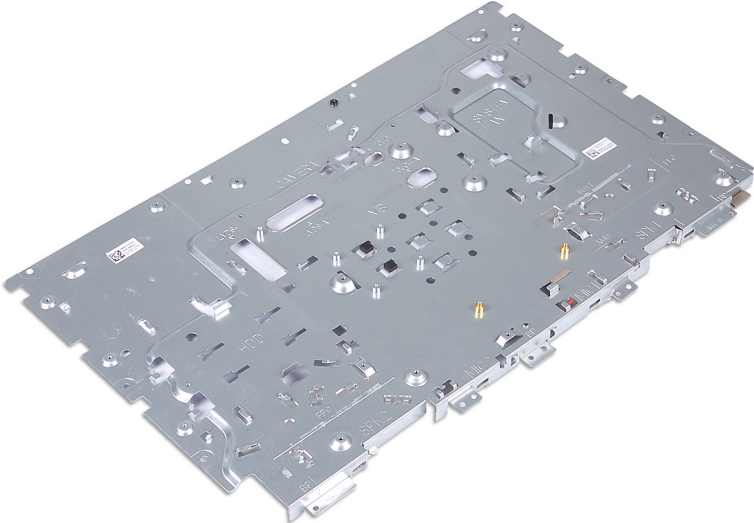

# Replacing the middle frame

**!** **WARNING:** Before working inside your computer, read the safety information that shipped with your computer and follow the steps in [Before working inside your computer](#). After working inside your computer, follow the instructions in [After working inside your computer](#). For more safety best practices, see the Regulatory Compliance home page at [www.dell.com/regulatory\\_compliance](http://www.dell.com/regulatory_compliance).

## Procedure

- 1 Slide the middle frame onto the display-assembly base.
- 2 Snap the display-assembly base and the middle frame into place.

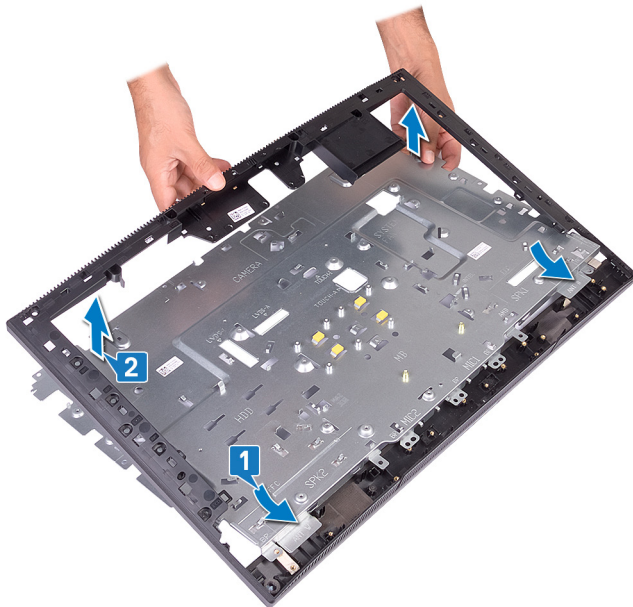

- 3 Replace the 13 screws (M3x5 black) that secure the middle frame to the display-assembly base.



## Post-requisites

- 1 Replace the [rubber feet](#).
- 2 Replace the [display panel](#).
- 3 Replace the [system board](#).
- 4 Replace the [speakers](#).
- 5 Replace the [heat sink](#).
- 6 Replace the [fan](#).
- 7 Replace the [coin-cell battery](#).
- 8 Replace the [camera](#).
- 9 Replace the [microphone](#).
- 10 Replace the [power-button board](#).
- 11 Replace the [media-card reader](#).
- 12 Replace the [antenna](#).
- 13 Replace the [wireless card](#).
- 14 Replace the [memory module](#).



- 15** Replace the [system-board shield](#).
- 16** Replace the [hard drive](#).
- 17** Replace the [back cover](#).
- 18** Replace the [stand](#).



# Downloading drivers

---

## Operating system



- Windows 10 Home (64-bit)
- Windows 10 Professional (64-bit)
- Ubuntu

## Downloading the audio driver

- 1 Turn on your computer.
- 2 Go to [www.dell.com/support](http://www.dell.com/support).
- 3 Enter the Service Tag of your computer, and then click **Submit**.  
 **NOTE: If you do not have the Service Tag, use the auto-detect feature or manually browse for your computer model.**
- 4 Click **Drivers & downloads**.
- 5 Click the **Detect Drivers** button.
- 6 Review and agree to the Terms and Conditions to use **SupportAssist**, then click **Continue**.
- 7 If necessary, your computer starts to download and install **SupportAssist**.  
 **NOTE: Review on-screen instructions for browser-specific instructions.**
- 8 Click **View Drivers for My System**.
- 9 Click **Download and Install** to download and install all driver updates detected for your computer.
- 10 Select a location to save the files.
- 11 If prompted, approve requests from **User Account Control** to make changes on the system.
- 12 The application installs all drivers and updates identified.  
 **NOTE: Not all files can be installed automatically. Review the installation summary to identify if manual installation is necessary.**
- 13 For manual download and installation, click **Category**.
- 14 Click **Audio** in the drop-down list.



- 15 Click **Download** to download the audio driver for your computer.
- 16 After the download is complete, navigate to the folder where you saved the audio driver file.
- 17 Double-click the audio driver file icon and follow the instructions on the screen to install the driver.

## Downloading the graphics driver



- 1 Turn on your computer.
- 2 Go to [www.dell.com/support](http://www.dell.com/support).
- 3 Enter the Service Tag of your computer, and then click **Submit**.  
 **NOTE: If you do not have the Service Tag, use the auto-detect feature or manually browse for your computer model.**
- 4 Click **Drivers & downloads**.
- 5 Click the **Detect Drivers** button.
- 6 Review and agree to the Terms and Conditions to use **SupportAssist**, then click **Continue**.
- 7 If necessary, your computer starts to download and install **SupportAssist**.  
 **NOTE: Review on-screen instructions for browser-specific instructions.**
- 8 Click **View Drivers for My System**.
- 9 Click **Download and Install** to download and install all driver updates detected for your computer.
- 10 Select a location to save the files.
- 11 If prompted, approve requests from **User Account Control** to make changes on the system.
- 12 The application installs all drivers and updates identified.  
 **NOTE: Not all files can be installed automatically. Review the installation summary to identify if manual installation is necessary.**
- 13 For manual download and installation, click **Category**.
- 14 Click **Video** in the drop-down list.
- 15 Click **Download** to download the graphics driver for your computer.
- 16 After the download is complete, navigate to the folder where you saved the graphics driver file.

- 17 Double-click the graphics driver file icon and follow the instructions on the screen to install the driver.

## Downloading the USB driver



- 1 Turn on your computer.
- 2 Go to [www.dell.com/support](http://www.dell.com/support).
- 3 Enter the Service Tag of your computer, and then click **Submit**.  
 **NOTE: If you do not have the Service Tag, use the auto-detect feature or manually browse for your computer model.**
- 4 Click **Drivers & downloads**.
- 5 Click the **Detect Drivers** button.
- 6 Review and agree to the Terms and Conditions to use **SupportAssist**, then click **Continue**.
- 7 If necessary, your computer starts to download and install **SupportAssist**.  
 **NOTE: Review on-screen instructions for browser-specific instructions.**
- 8 Click **View Drivers for My System**.
- 9 Click **Download and Install** to download and install all driver updates detected for your computer.
- 10 Select a location to save the files.
- 11 If prompted, approve requests from **User Account Control** to make changes on the system.
- 12 The application installs all drivers and updates identified.  
 **NOTE: Not all files can be installed automatically. Review the installation summary to identify if manual installation is necessary.**
- 13 For manual download and installation, click **Category**.
- 14 Click **Chipset** in the drop-down list.
- 15 Click **Download** to download the USB driver for your computer.
- 16 After the download is complete, navigate to the folder where you saved the USB driver file.
- 17 Double-click the USB driver file icon and follow the instructions on the screen to install the driver.

# Downloading the WiFi driver

- 1 Turn on your computer.
- 2 Go to [www.dell.com/support](http://www.dell.com/support).
- 3 Enter the Service Tag of your computer, and then click **Submit**.  
 **NOTE: If you do not have the Service Tag, use the auto-detect feature or manually browse for your computer model.**
- 4 Click **Drivers & downloads**.
- 5 Click the **Detect Drivers** button.
- 6 Review and agree to the Terms and Conditions to use **SupportAssist**, then click **Continue**.
- 7 If necessary, your computer starts to download and install **SupportAssist**.  
 **NOTE: Review on-screen instructions for browser-specific instructions.**
- 8 Click **View Drivers for My System**.
- 9 Click **Download and Install** to download and install all driver updates detected for your computer.
- 10 Select a location to save the files.
- 11 If prompted, approve requests from **User Account Control** to make changes on the system.
- 12 The application installs all drivers and updates identified.  
 **NOTE: Not all files can be installed automatically. Review the installation summary to identify if manual installation is necessary.**
- 13 For manual download and installation, click **Category**.
- 14 Click **Network** in the drop-down list.
- 15 Click **Download** to download the WiFi driver for your computer.
- 16 After the download is complete, navigate to the folder where you saved the WiFi driver file.
- 17 Double-click the WiFi driver icon and follow the instructions on the screen to install the driver.

# Downloading the media-card reader driver

- 1 Turn on your computer.

- 2 Go to [www.dell.com/support](http://www.dell.com/support).
- 3 Enter the Service Tag of your computer, and then click **Submit**.
  -  **NOTE: If you do not have the Service Tag, use the auto-detect feature or manually browse for your computer model.**
- 4 Click **Drivers & downloads**.
- 5 Click the **Detect Drivers** button.
- 6 Review and agree to the Terms and Conditions to use **SupportAssist**, then click **Continue**.
- 7 If necessary, your computer starts to download and install **SupportAssist**.
  -  **NOTE: Review on-screen instructions for browser-specific instructions.**
- 8 Click **View Drivers for My System**.
- 9 Click **Download and Install** to download and install all driver updates detected for your computer.
- 10 Select a location to save the files.
- 11 If prompted, approve requests from **User Account Control** to make changes on the system.
- 12 The application installs all drivers and updates identified.
  -  **NOTE: Not all files can be installed automatically. Review the installation summary to identify if manual installation is necessary.**
- 13 For manual download and installation, click **Category**.
- 14 Click **Chipset** in the drop-down list.
- 15 Click **Download** to download the media-card reader driver for your computer.
- 16 After the download is complete, navigate to the folder where you saved the media-card reader driver file.
- 17 Double-click the media-card reader driver file icon and follow the instructions on the screen to install the driver.

## Downloading the chipset driver

- 1 Turn on your computer.
- 2 Go to [www.dell.com/support](http://www.dell.com/support).
- 3 Enter the Service Tag of your computer, and then click **Submit**.
  -  **NOTE: If you do not have the Service Tag, use the auto-detect feature or manually browse for your computer model.**

- 4 Click **Drivers & downloads**.
- 5 Click the **Detect Drivers** button.
- 6 Review and agree to the Terms and Conditions to use **SupportAssist**, then click **Continue**.
- 7 If necessary, your computer starts to download and install **SupportAssist**.



**NOTE: Review on-screen instructions for browser-specific instructions.**

- 8 Click **View Drivers for My System**.
- 9 Click **Download and Install** to download and install all driver updates detected for your computer.
- 10 Select a location to save the files.
- 11 If prompted, approve requests from **User Account Control** to make changes on the system.
- 12 The application installs all drivers and updates identified.



**NOTE: Not all files can be installed automatically. Review the installation summary to identify if manual installation is necessary.**

- 13 For manual download and installation, click **Category**.
- 14 Click **Chipset** in the drop-down list.
- 15 Click **Download** to download the chipset driver for your computer.
- 16 After the download is complete, navigate to the folder where you saved the saved the chipset driver file.
- 17 Double-click the chipset driver file icon and follow the instructions on the screen to install the driver.

## Downloading the network driver

- 1 Turn on your computer.
- 2 Go to [www.dell.com/support](http://www.dell.com/support).
- 3 Enter the Service Tag of your computer, and then click **Submit**.



**NOTE: If you do not have the Service Tag, use the auto-detect feature or manually browse for your computer model.**

- 4 Click **Drivers & downloads**.
- 5 Click the **Detect Drivers** button.
- 6 Review and agree to the Terms and Conditions to use **SupportAssist**, then click **Continue**.

- 7 If necessary, your computer starts to download and install **SupportAssist**.



**NOTE: Review on-screen instructions for browser-specific instructions.**

- 8 Click **View Drivers for My System**.
- 9 Click **Download and Install** to download and install all driver updates detected for your computer.
- 10 Select a location to save the files.
- 11 If prompted, approve requests from **User Account Control** to make changes on the system.
- 12 The application installs all drivers and updates identified.



**NOTE: Not all files can be installed automatically. Review the installation summary to identify if manual installation is necessary.**

- 13 For manual download and installation, click **Category**.
- 14 Click **Network** in the drop-down list.
- 15 Click **Download** to download the network driver for your computer.
- 16 After the download is complete, navigate to the folder where you saved the network driver file.
- 17 Double-click the network driver file icon and follow the instructions on the screen to install the driver.

## Device drivers

### Intel Chipset Software Installation Utility

In the Device Manager, check if the chipset driver is installed.

Install the Intel chipset updates from [www.dell.com/support](http://www.dell.com/support).

### Video drivers

In the Device Manager, check if the video driver is installed.

Install the video driver update from [www.dell.com/support](http://www.dell.com/support).

### Intel Serial IO driver

In the Device Manager, check if the Intel Serial IO driver is installed.

Install the driver updates from [www.dell.com/support](http://www.dell.com/support).



## **Intel Serial IO driver**

In the Device Manager, check if the Intel Serial IO driver is installed.

Install the driver updates from [www.dell.com/support](http://www.dell.com/support).

## **Intel Trusted Execution Engine Interface**

In the Device Manager, check if the Intel Trusted Execution Engine Interface driver is installed.

Install the driver update from [www.dell.com/support](http://www.dell.com/support).

## **Intel Virtual Button driver**

In the Device Manager, check if the Intel Virtual Button driver is installed.

Install the driver updates from [www.dell.com/support](http://www.dell.com/support).

## **Wireless and Bluetooth drivers**

In the Device Manager, check if the network card driver is installed.

Install the driver updates from [www.dell.com/support](http://www.dell.com/support).

In the Device Manager, check if the Bluetooth driver is installed.

Install the driver updates from [www.dell.com/support](http://www.dell.com/support).

# System setup

---

 **CAUTION:** Unless you are an expert computer user, do not change the settings in the BIOS Setup program. Certain changes can make your computer work incorrectly.

 **NOTE:** Before you change BIOS Setup program, it is recommended that you write down the BIOS Setup program screen information for future reference.

Use the BIOS Setup program for the following purposes:

- Get information about the hardware installed in your computer, such as the amount of RAM and the size of the hard drive.
- Change the system configuration information.
- Set or change a user-selectable option, such as the user password, type of hard drive installed, and enabling or disabling base devices.

## BIOS overview

The BIOS manages data flow between the computer's operating system and attached devices such as hard disk, video adapter, keyboard, mouse, and printer.

## Entering BIOS setup program

- 1 Turn on (or restart) your computer.
- 2 During POST, when the DELL logo is displayed, watch for the F2 prompt to appear, and then press F2 immediately.

 **NOTE:** The F2 prompt indicates that the keyboard is initialized. This prompt can appear very quickly, so you must watch for it, and then press F2. If you press F2 before the F2 prompt, this keystroke is lost. If you wait too long and the operating system logo appears, continue to wait until you see the desktop. Then, turn off your computer and try again.

## Navigation keys

 **NOTE: For most of the System Setup options, changes that you make are recorded but do not take effect until you restart the system.**

Keys	Navigation
Up arrow	Moves to the previous field.
Down arrow	Moves to the next field.
Enter	Selects a value in the selected field (if applicable) or follow the link in the field.
Spacebar	Expands or collapses a drop-down list, if applicable.
Tab	Moves to the next focus area.

 **NOTE: For the standard graphics browser only.**

Esc	Moves to the previous page until you view the main screen. Pressing Esc in the main screen displays a message that prompts you to save any unsaved changes and restarts the system.
-----	---

## Boot Sequence

Boot Sequence allows you to bypass the System Setup–defined boot device order and boot directly to a specific device (for example: optical drive or hard drive). During the Power-on Self Test (POST), when the Dell logo appears, you can:

- Access System Setup by pressing F2 key
- Bring up the one-time boot menu by pressing F12 key

The one-time boot menu displays the devices that you can boot from including the diagnostic option. The boot menu options are:

- Removable Drive (if available)
- STXXXX Drive

 **NOTE: XXX denotes the SATA drive number.**

- Optical Drive (if available)
- SATA Hard Drive (if available)
- Diagnostics

 **NOTE: Choosing Diagnostics, will display the ePSA diagnostics screen.**

The boot sequence screen also displays the option to access the System Setup screen.

## System Setup Options

 **NOTE: Depending on your computer and its installed devices, the items listed in this section may or may not appear.**

**Table 3. System setup options—Main menu**

Main	
System Time	Displays the current time in hh:mm:ss format.
System Date	Displays the current date in mm/dd/yyyy format.
BIOS Version	Displays the BIOS version number.
Product Name	Displays the product name.
Service Tag	Allows you to enter the service tag of your computer.
Asset Tag	Displays the asset tag of your computer.
CPU Type	Displays the CPU type.
CPU Speed	Displays the speed of the CPU.
CPU ID	Displays the CPU identification code.
Cache L1	Displays the processor L1 cache size.
Cache L2	Displays the processor L2 cache size.
Cache L3	Displays the processor L3 cache size.
First HDD	Displays the primary hard disk.

---

**Main**

---

AC Adapter Type	Displays the power adapter type.
System Memory	Displays the total computer memory installed.
Memory Speed	Displays the memory speed.

**Table 4. System setup options—Advanced menu**

---

**Advanced**

---

**Advanced BIOS Features**

Intel(R)SpeedStep(TM)	Enable or disable the Intel SpeedStep feature. Default: Enabled.
Integrated NIC	Enable or disable the on-board LAN controller. Default: Enabled
Intel Speed Shift Technology	Enable/disable Intel Speed Shift Technology support . Setting this option to enable to allows the operating system to select the appropriate processor performance automatically. Default: Enabled
SATA Option	This option configures the operating mode of the integrated SATA hard drive controller. Default: AHCI
Adapter Warnings	Enables or disables the power adapter warnings. Default: Enabled
Intel Software Guard Extensions	Enable/Disable/Software Controlled Intel® Software Guard Extensions (SGX). Default: Software controlled
Intel Software Guard Extensions allocated memory size	Setting memory allocation for Intel Software Guard Extensions (SGX). The support would be 128MB allocation by default. When SGX is set to Software

---

**Advanced**

---

	Controlled this setting is not available and has no effect.
BIOS Recovery from Hard Drive	Enable or disable BIOS recovery from hard drive. Default: Enabled
BIOS Auto-Recovery	Enable or disable BIOS Auto-Recovery. Default :Disabled
Integrity Check	When enabled, BIOS checks the BIOS image integrity on every boot. When Disabled, BIOS checks the image integrity only if the previous boot did not complete. Default :Disabled
Intel BIOS Guard Support	Enable or disable the Intel BIOS Guard Support. Default: Enabled

**USB Configuration**

Rear USB Ports	Allows you to enable or disable the rear USB ports.
----------------	---

**Power Options**

Wake Up by Integrated LAN	Enable or disable the computer to be powered on by special LAN signals. Default: Disabled
AC Recovery	Sets what action the computer takes when power is restored.
Deep Sleep Control	Enable or disable the Deep Sleep mode support. Default: Enabled
USB Wake support	Enable or disable USB devices to wake the system from Standby. Default: Enabled
USB Powershare Support State	Enable or disable charging USB devices. Default: Disabled

---

**Advanced**

---

Auto Power On	This option sets the time of day when you would like the system to turn on automatically.
Auto Power On Mode	System turns on automatically.
Auto Power On Date	Auto power on date.
Auto Power On Time	Auto power on time.
Numlock Key	Allows you to set the status of the Numlock key during boot to On or Off.

**SupportAssist System Resolution**

Auto OS Recovery Threshold	Control the automatic boot flow for SupportAssist System Resolution Console and for Dell OS Recovery tool.
SupportAssist OS Recovery	The SupportAssist OS Recovery option will enable or disable the boot flow for SupportAssist OS Recovery tool in the event of certain system errors. If the SupportAssist OS Recovery setup option is set to disabled then all automatic boot flow for SupportAssist OS Recovery tool will be disabled. Default: Disabled

**Table 5. System setup options—Security menu**

---

**Security**

---

Unlock Setup Status	Displays the Unlock Setup status.
Admin Password Status	Displays the administrative password status.
System Password Status	Displays the system password status.
HDD Password Status	Displays the hard-drive password status.
Asset Tag	Displays the asset tag of your computer.
Admin Password	Allows you to set the admin password.

---

**Security**

---

System Password	Allows you to set the system password.
HDD Password	Allows you to set the hard drive password.
Password change	Allows you determine whether changes to the System and Hard Disk passwords are permitted when an administrator password is set.
Computrance	Allows you to help track assets and provide recovery services in the event the computer is lost or stolen.
Firmware TPM	Allows you to enable or disable the firmware TPM function.
PPI Bypass for Clear Command	Allows you to control the TPM Physical Presence Interface (PPI). When enabled, this setting will allow the OS to skip BIOS PPI user prompts when issuing the Clear command. Changes to this setting take effect immediately..
UEFI Firmware Capsule Updates	Allows you to enable or disable the UEFI Firmware Capsule Updates function. Default: Enabled

**Table 6. System setup options—Boot menu**

---

**Boot**

---

Boot List Option	Allows you to select system boot from Legacy or UEFI.
File Browser Add Boot Option	Allows you to browse into the file system of devices to select the bootloader.
File Browser Del Boot Option	Allows you to delete the boot menu.
Secure Boot	Allows you to enable or disable the secure boot control.



<b>Boot</b>	
	Default: Disabled
Legacy option ROMs	Enable or disable the Legacy Option ROMs.
Attempt Legacy Boot	Allows the system to immediately boot the Legacy Boot List if system fails to boot the UEFI Boot List.
Boot Option Priorities	Displays the boot option priorities.
Boot Option #1	Displays the first boot option.
Boot Option #2	Displays the second boot option.
Boot Option #3	Displays the third boot option.

**Table 7. System setup options—Exit menu**

<b>Exit</b>	
Save Changes and Reset	Allows you to reset the system after saving the changes.
Discard Changes and Reset	Allows you to reset the system without saving any changes.
Restore defaults	Allows you to restore defaults.
Discard Changes	Allows you to discard your changes.
Save Changes	Allows you to save your changes.

## System and setup password

**Table 8. System and setup password**

<b>Password type</b>	<b>Description</b>
System password	Password that you must enter to log on to your system.
Setup password	Password that you must enter to access and make changes to the BIOS settings of your computer.

You can create a system password and a setup password to secure your computer.

 **CAUTION: The password features provide a basic level of security for the data on your computer.**

 **CAUTION: Anyone can access the data stored on your computer if it is not locked and left unattended.**

 **NOTE: System and setup password feature is disabled.**

## Assigning a system setup password

You can assign a new **System or Admin Password** only when the status is in **Not Set**.

To enter the system setup, press F2 immediately after a power-on or re-boot.

- 1 In the **System BIOS** or **System Setup** screen, select **Security** and press Enter. The **Security** screen is displayed.
- 2 Select **System/Admin Password** and create a password in the **Enter the new password** field.  
Use the following guidelines to assign the system password:
  - A password can have up to 32 characters.
  - The password can contain the numbers 0 through 9.
  - Only lower case letters are valid, upper case letters are not allowed.
  - Only the following special characters are allowed: space, ("), (+), (,), (-), (.), (/), (:), ([), (\), (]), ( ` ).
- 3 Type the system password that you entered earlier in the **Confirm new password** field and click **OK**.
- 4 Press Esc and a message prompts you to save the changes.
- 5 Press Y to save the changes.  
The computer reboots.

## Deleting or changing an existing system setup password

Ensure that the **Password Status** is Unlocked (in the System Setup) before attempting to delete or change the existing System and/or Setup password. You cannot delete or change an existing System or Setup password, if the **Password Status** is Locked.

To enter the System Setup, press F2 immediately after a power-on or reboot.

- 1 In the **System BIOS** or **System Setup** screen, select **System Security** and press Enter.  
The **System Security** screen is displayed.
- 2 In the **System Security** screen, verify that **Password Status** is **Unlocked**.
- 3 Select **System Password**, alter or delete the existing system password and press Enter or Tab.
- 4 Select **Setup Password**, alter or delete the existing setup password and press Enter or Tab.  
 **NOTE: If you change the System and/or Setup password, re-enter the new password when prompted. If you delete the System and/or Setup password, confirm the deletion when prompted.**
- 5 Press Esc and a message prompts you to save the changes.
- 6 Press Y to save the changes and exit from System Setup.  
The computer reboot.

## Clearing CMOS settings

 **WARNING:** Before working inside your computer, read the safety information that shipped with your computer and follow the steps in [Before working inside your computer](#). After working inside your computer, follow the instructions in [After working inside your computer](#). For more safety best practices, see the Regulatory Compliance home page at [www.dell.com/regulatory\\_compliance](http://www.dell.com/regulatory_compliance).

### Prerequisites

- 1 Remove the [stand](#).
- 2 Remove the [back cover](#).
- 3 Remove the [system-board shield](#).

### Procedure

- 1 Locate the CMOS reset jumper (RTCRST) on the system board.  
 **NOTE: For more information on the location of the jumper, see “[System-board components](#)”.**
- 2 Remove the jumper plug from the password jumper-pins and connect it to the CMOS jumper-pins.

- 3 Wait for 5 seconds and then replace the jumper plug in its original location.

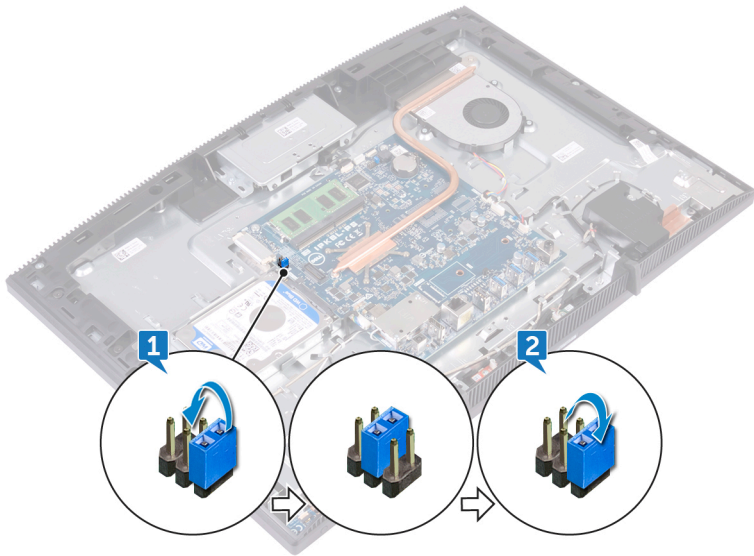

### Post-requisites

- 1 Replace the [system-board shield](#).
- 2 Replace the [back cover](#).
- 3 Replace the [stand](#).

## Clearing BIOS (System Setup) and System passwords

To clear the system or BIOS passwords, contact Dell technical support as described at [www.dell.com/contactdell](http://www.dell.com/contactdell).

 **NOTE:** For information on how to reset Windows or application passwords, refer to the documentation accompanying Windows or your application.

# Troubleshooting

---

## Flashing the BIOS

You may need to flash (update) the BIOS when an update is available or when you replace the system board.

Follow these steps to flash the BIOS:

- 1 Turn on your computer.
- 2 Go to [www.dell.com/support](http://www.dell.com/support).
- 3 Click **Product support**, enter the Service Tag of your computer, and then click **Submit**.  
 **NOTE: If you do not have the Service Tag, use the auto-detect feature or manually browse for your computer model.**
- 4 Click **Drivers & downloads** → **Find it myself**.
- 5 Select the operating system installed on your computer.
- 6 Scroll down the page and expand **BIOS**.
- 7 Click **Download** to download the latest version of the BIOS for your computer.
- 8 After the download is complete, navigate to the folder where you saved the BIOS update file.
- 9 Double-click the BIOS update file icon and follow the instructions on the screen.

## Reinstall Windows using a USB recovery drive

 **CAUTION: This process formats the hard drive and removes all data on your computer. Ensure that you back up data on your computer before beginning this task.**

 **NOTE: Before reinstalling Windows, ensure your computer has more than 2 GB of memory and more than 32 GB of storage space.**

 **NOTE: This process may take up to an hour to complete and your computer will restart during the recovery process.**

- 1 Connect the USB recovery drive to your computer.
- 2 Restart your computer.

- 3 Press F12 after the Dell logo is displayed on the screen to access the boot menu. A **Preparing one-time boot menu** message appears.
- 4 After the boot menu loads, select the USB recovery device under **UEFI BOOT**. The system reboots and a screen to **Choose the keyboard layout** is displayed.
- 5 Choose your keyboard layout.
- 6 In the **Choose an option** screen, click **Troubleshoot**.
- 7 Click **Recover from a drive**.
- 8 Choose one of the following options:
  - **Just remove my files** to do a quick format.
  - **Fully clean the drive** to do a complete format.
- 9 Click **Recover** to start the recovery process.

## Enhanced Pre-Boot System Assessment (ePSA) diagnostics



**CAUTION: Use the ePSA diagnostics to test only your computer. Using this program with other computers may cause invalid results or error messages.**

The ePSA diagnostics (also known as system diagnostics) performs a complete check of your hardware. The ePSA is embedded with the BIOS and is launched by the BIOS internally. The embedded system diagnostics provides a set of options for particular devices or device groups allowing you to:

- Run tests automatically or in an interactive mode
- Repeat tests
- Display or save test results
- Run thorough tests to introduce additional test options to provide extra information about the failed device(s)
- View status messages that inform you if tests are completed successfully
- View error messages that inform you of problems encountered during testing



**NOTE: Some tests for specific devices require user interaction. Always ensure that you are present at the computer terminal when the diagnostic tests are performed.**

For more information, see [Dell ePSA Diagnostic 3.0](#).

## Running the ePSA diagnostics

- 1 Turn on your computer.
- 2 As the computer boots, press the F12 key as the Dell logo appears.
- 3 On the boot menu screen, select the **Diagnostics** option.
- 4 Click the arrow at the bottom left corner.  
Diagnostics front page is displayed.
- 5 Click the arrow in the lower-right corner to go to the page listing.  
The items detected are listed.
- 6 To run a diagnostic test on a specific device, press Esc and click **Yes** to stop the diagnostic test.
- 7 Select the device from the left pane and click **Run Tests**.
- 8 If there are any issues, error codes are displayed.  
Note the error code and validation number and contact Dell.

## Display built-in self test

The following procedure provides the instructions on how to run the built-in self test for the display:

- 1 Turn off your computer.
- 2 Press and hold the display built-in self test button.
- 3 Press and hold the power button.
- 4 Release the power button.
- 5 Hold the display built-in self test button until the test starts.

## Diagnostics

**Power status light:** Indicates the power status.

**Solid Amber** – The computer is unable to boot to the operating system. This indicates that the power supply or another device in the computer is failing.

**Blinking Amber** – The computer is unable to boot to the operating system. This indicates that the power supply is normal but another device in the computer is failing or not installed properly.



**NOTE: See the light patterns to determine the device that is failing.**

**Off** – Computer is in hibernation or turned off.

The power status light blinks amber along with beep codes indicating failures.

For example, the power status light blinks amber two times followed by a pause, and then blinks white three times followed by a pause. This 2,3 pattern continues until the computer is turned off indicating the Recovery image is not found.

The following table shows different light patterns and what they indicate:

**Table 9. System diagnostic lights**

Light pattern	Problem description
1	System board, BIOS corruption, or ROM error
2	Memory not found
3	System board, chipset failure
4	Memory or RAM failure
5	Coin-cell battery failure
6	GPU failure
7	CPU failure
8	Display failure
3,6	BIOS recovery image not found
3,7	BIOS recovery image found but invalid
<b>Solid Amber → 2,1</b>	CPU failure

The computer may emit a series of beeps during start-up if the errors or problems cannot be displayed. The repetitive beep codes help the user troubleshoot problems with the computer.

**Camera status light:** Indicates whether the camera is in use.

- Solid white – Camera is in use.
- Off – Camera is not in use.

## Enabling Intel Optane memory

- 1 On the taskbar, click the search box, and then type `Intel Rapid Storage Technology`.



- 2 Click **Intel Rapid Storage Technology**.  
The **Intel Rapid Storage Technology** window is displayed.
- 3 On the **Status** tab, click **Enable** to enable the Intel Optane memory.
- 4 On the warning screen, select a compatible fast drive, and then click **Yes** to continue enabling Intel Optane memory.
- 5 Click **Intel Optane memory** → **Reboot** to complete enabling your Intel Optane memory.

 **NOTE: Applications may take up to three subsequent launches after enablement to see the full performance benefits.**

## Disabling Intel Optane memory

 **CAUTION: After disabling Intel Optane memory, do not uninstall the driver for Intel Rapid Storage Technology as it will result in a blue screen error. The Intel Rapid Storage Technology user interface can be removed without uninstalling the driver.**

 **NOTE: Disabling Intel Optane memory is required before removing the SATA storage device accelerated by the Intel Optane memory module from the computer.**

- 1 On the taskbar, click the search box, and then type `Intel Rapid Storage Technology`.
- 2 Click **Intel Rapid Storage Technology**.  
The **Intel Rapid Storage Technology** window is displayed.
- 3 On the **Intel Optane memory** tab, click **Disable** to disable the Intel Optane memory.

 **NOTE: For computers in which Intel Optane memory acts as a primary storage, do not disable the Intel Optane memory. The Disable option will be grayed out.**

- 4 Click **Yes** if you accept the warning.  
The disabling progress is displayed.
- 5 Click **Reboot** to complete disabling your Intel Optane memory and restart your computer.

## Flea power release

Flea power is the residual static electricity that remains on the computer even after it has been powered off and the battery has been removed. The following procedure provides the instructions on how to conduct flea power release:

- 1 Turn off your computer.
- 2 Disconnect the power adapter from your computer.
- 3 Press and hold the power button for 15 seconds to drain the flea power.
- 4 Connect the power adapter to your computer.
- 5 Turn on your computer.

## WiFi power cycle

If your computer is unable to access the internet due to WiFi connectivity issues a WiFi power cycle procedure may be performed. The following procedure provides the instructions on how to conduct a WiFi power cycle:

 **NOTE: Some ISPs (Internet Service Providers) provide a modem/router combo device.**



- 1 Turn off your computer.
- 2 Turn off the modem.
- 3 Turn off the wireless router.
- 4 Wait for 30 seconds.
- 5 Turn on the wireless router.
- 6 Turn on the modem.
- 7 Turn on your computer.

# Getting help and contacting Dell

## Self-help resources

You can get information and help on Dell products and services using these self-help resources:

**Table 10. Self-help resources**

Self-help resources	Resource location
Information about Dell products and services	<a href="http://www.dell.com">www.dell.com</a>
My Dell	
Tips	
Contact Support	In Windows search, type <b>Contact Support</b> , and press Enter.
Online help for operating system	<a href="http://www.dell.com/support/windows">www.dell.com/support/windows</a> <a href="http://www.dell.com/support/linux">www.dell.com/support/linux</a>
Troubleshooting information, user manuals, setup instructions, product specifications, technical help blogs, drivers, software updates, and so on.	<a href="http://www.dell.com/support">www.dell.com/support</a>
Dell knowledge base articles for a variety of computer concerns.	<ol style="list-style-type: none"><li>1 Go to <a href="http://www.dell.com/support">www.dell.com/support</a>.</li><li>2 Type the subject or keyword in the <b>Search</b> box.</li><li>3 Click <b>Search</b> to retrieve the related articles.</li></ol>
Learn and know the following information about your product:	See <i>Me and My Dell</i> at <a href="http://www.dell.com/support/manuals">www.dell.com/support/manuals</a> .

Self-help resources	Resource location
<ul style="list-style-type: none"> <li>• Product specifications</li> <li>• Operating system</li> <li>• Setting up and using your product</li> <li>• Data backup</li> <li>• Troubleshooting and diagnostics</li> <li>• Factory and system restore</li> <li>• BIOS information</li> </ul>	<p>To locate the <i>Me and My Dell</i> relevant to your product, identify your product through one of the following:</p> <ul style="list-style-type: none"> <li>• Select <b>Detect Product</b>.</li> <li>• Locate your product through the drop-down menu under <b>View Products</b>.</li> <li>• Enter the <b>Service Tag number</b> or <b>Product ID</b> in the search bar.</li> </ul>

## Contacting Dell

To contact Dell for sales, technical support, or customer service issues, see [www.dell.com/contactdell](http://www.dell.com/contactdell).



**NOTE: Availability varies by country and product, and some services may not be available in your country.**



**NOTE: If you do not have an active internet connection, you can find contact information on your purchase invoice, packing slip, bill, or Dell product catalog.**