



Dell™ OptiPlex™ 380 Service Manual—Small Form Factor

[Working on Your Computer](#)
[Specifications](#)
[Removing and Replacing Parts](#)
[System Board Layout](#)
[System Setup](#)
[Diagnostics](#)

Notes, Cautions, and Warnings

-  **NOTE:** A NOTE indicates important information that helps you make better use of your computer.
-  **CAUTION:** A CAUTION indicates potential damage to hardware or loss of data if instructions are not followed.
-  **WARNING:** A WARNING indicates a potential for property damage, personal injury, or death.

If you purchased a Dell™ n Series computer, any references in this document to Microsoft® Windows® operating systems are not applicable.

Information in this document is subject to change without notice.
© 2010 Dell Inc. All rights reserved.

Reproduction of this material in any manner whatsoever without the written permission of Dell Inc. is strictly forbidden.

Trademarks used in this text: *Dell*, the *DELL* logo, and *OptiPlex* are trademarks of Dell Inc.; *ATI Radeon* is a trademarks of Advanced Micro Devices, Inc; *Intel* and *Core* are either trademarks or registered trademarks of Intel Corporation; *Blu-ray Disc* is a trademark of the Blu-ray Disc Association; *Microsoft*, *Windows*, *Windows Vista*, and the *Windows Vista* start button are either trademarks or registered trademarks of Microsoft Corporation in the United States and/or other countries.

Other trademarks and trade names may be used in this document to refer to either the entities claiming the marks and names or their products. Dell Inc. disclaims any proprietary interest in trademarks and trade names other than its own.

March 2010 Rev. A01

[Back to Contents Page](#)

System Setup

Dell™ OptiPlex™ 380 Service Manual—Small Form Factor

- [Boot Menu](#)
- [Navigation Keystrokes](#)
- [Entering System Setup](#)
- [System Setup Simulation](#)
- [System Setup Menu Options](#)

Boot Menu

Press <F12> when the Dell™ logo appears to initiate a one-time boot menu with a list of the valid boot devices for the computer.

The options listed are:

Internal HDD
CD/DVD/CD-RW Drive
Onboard NIC
BIOS Setup
Diagnostics

This menu is useful when you are attempting to boot to a particular device or to bring up the diagnostics for the computer. Using the boot menu does not make any changes to the boot order stored in the BIOS.

Navigation Keystrokes

Use the following keystrokes to navigate the System Setup screens.

Navigation Keystrokes	
Action	Keystroke
Expand and collapse field	<Enter>, left- or right-arrow key, or +/-
Expand or collapse all fields	<>
Exit BIOS	<Esc>—Remain in Setup, Save/Exit, Discard/Exit
Change a setting	Left or right-arrow key
Select field to change	<Enter>
Cancel modification	<Esc>
Reset defaults	<Alt><F> or Load Defaults menu option

Entering System Setup

Your computer offers the following BIOS and System Setup options:

- Bring up a one-time boot menu by pressing <F12>
- Access System Setup by pressing <F2>

<F12> Menu

Press <F12> when the Dell™ logo appears to initiate a one-time boot menu with a list of the valid boot devices for the computer. **Diagnostics** and **Enter Setup** options are also included in this menu. The devices listed on the boot menu depend on the bootable devices installed in the computer. This menu is useful when you are attempting to boot to a particular device or to bring up the diagnostics for the computer. Making changes in the boot menu does not make any changes to the boot order stored in the BIOS.

<F2>

Press <F2> to enter System Setup and make changes to user-definable settings. If you have trouble entering System Setup using this key, press <F2> when the keyboard lights first flash.

System Setup Menu Options

 **NOTE:** System Setup options may vary depending on your computer and may not appear in the exact same order.

General	
System Board	<p>Displays the following information:</p> <ul style="list-style-type: none">• System information: Displays BIOS Info, System Info, Service Tag, Express Service Code, Asset Tag, Manufacture Date, and the Ownership Date.• Memory information: Displays Installed Memory, Usable Memory, Memory Speed, Memory Channel Mode, Memory Technology, DIMM_1 Size, DIMM_2 Size, DIMM_3 Size, and DIMM_4 Size.• Processor information: Displays the Processor Type, Processor Speed, Processor Bus Speed, Processor L2 cache, Processor ID, Microcode Version, Multi Core Capable and HT Capable 64-bit Technology.• PCI information: Displays available slots on the system board.

Date/Time	Displays the computer date and time. Changes to the system date and time take effect immediately.
Boot Sequence	Specifies the order in which the computer attempts to find an operating system from the devices specified in this list. <ul style="list-style-type: none"> • Onboard or USB Floppy • Hard drive (lists the model number of the hard drive currently installed in the computer) • Onboard or USB CD-Rom Drive • USB Device

Drives	
Diskette drive	This field determines how the BIOS configures floppy drives, Operating Systems with USB support will recognize USB Floppy drives regardless of this setting: <ul style="list-style-type: none"> • Disable - All Floppy drive are disable • Enable - All floppy drive are enable. <p>The "USB Controller" Setup option will affect floppy operation.</p>
SATA Operation	configures the operating mode of the integrated hard drive controller. <ul style="list-style-type: none"> • RAID Autodetect / AHCI = RAID if signed drives, otherwise AHCI • RAID Autodetect / ATA= RAID if signed drives, otherwise ATA • RAID On / ATA= SATA is configured for RAID on every boot • Legacy = The hard drive controller is configured for legacy mode <p>Legacy mode provides for compatibility with some older operating systems that do not support native resources assigned to the drive controller.</p> <p>NOTE: RAID Mode is incompatible with ImageServer. Disable RAID mode to enable Image Server.</p>
S.M.A.R.T. Reporting	This field controls whether hard drive errors for integrated drives are reported during startup. This technology is part of the Self Monitoring Analysis and Reporting Technology (SMART) specification. <p>This option is disabled by default.</p>
Drives	Enables or disables the SATA or ATA drives connected to the system board.

System Configuration	
Integrated NIC	Enables or disables the integrated network card. You can set the integrated NIC to: <ul style="list-style-type: none"> • Disable • Enable (default) • Enable with PXE • Enable with ImageSever <p>ImageServe is incompatible with RAID mode. Please disable RAID if enabling ImageServer.</p> <p>PXE is needed only if intending to boost to an operating system located on a server, not if you are booting on an OS located on a hard drive in this computer.</p>
USB for Flexbay	This field enable and disable the internal USB for FlexBay, you can set: <ul style="list-style-type: none"> • Disable - Internal USB for FlexBay is disable • Enable - Internal USB for FlexBay is enable • No Boot - Internal USB for FlexBay is enable, but not bootable. (default)
USB Controller	Enables or disables the integrated USB controller. You can set the USB controller to: <ul style="list-style-type: none"> • Enable (default) • Disable • No boot <p>Operating systems with USB support will recognize USB Storage</p>
Parallel Port	Identifies and defines the parallel port settings. You can set the parallel port to: <ul style="list-style-type: none"> • Disable • AT • PS/2 (default) • EPP • ECP No DMA • ECP DMA 1 • ECP DMA 3
Parallel Port Address	Sets the base I/O address of the integrated parallel port.
Serial Port #1	Identifies and defines the serial port settings. You can set the serial port to: <ul style="list-style-type: none"> • Disable • Auto (default) • COM1 • COM3 <p>The Operating System may allocate resources even though the setting is disabled.</p>
Serial Port #2	Identifies and defines the serial port settings. You can set the serial port to:

	<ul style="list-style-type: none"> • Disable • Auto (default) • COM2 • COM4 <p>The Operating System may allocate resources even though the setting is disabled.</p>
Miscellaneous Devices	<p>Enables or disables the following onboard devices:</p> <ul style="list-style-type: none"> • Front USB • PCI slots • Audio

Video

Primary Video	<p>This field determines which video controller will become the primary video controller when 2 controllers are available in the computer. This selection matters only if there are 2 video controller present.</p> <ul style="list-style-type: none"> • Auto(default) - Use the add-in video controller. • Onboard/Card - Use the integrated video controller unless a Graphic care is installed. A PCI Express Graphic(PEG) card will override and disable the integrated video controller.
---------------	-------------------------------------------------------------------------------------------------------------------------------------------------------------------------------------------------------------------------------------------------------------------------------------------------------------------------------------------------------------------------------------------------------------------------------------------------------------------------------------------------------------------------------------

Performance

Multi Core Support	<p>This field specifies whether the processor will have one or all cores enable. The performance of some application will improve with the additional cores.</p>
Intel® SpeedStep™	<p>This Option enables or disables the Intel® SpeedStep™ mode of the processor. When disabled, the computer is placed into the highest performance state and the Intel® SpeedStep™ applet or native operating system driver are prevented from adjusting the processor's performance. When enable. the Intel® SpeedStep™, enabled CPU is allowed to operate in multiple performance states.</p> <p>This option is disabled by default.</p>
C States Control	<p>This option enables or disables additional processor sleep states. The operating system may optionally use these for additional power saving when idle.</p> <p>This option is disabled by default.</p>
Limit CPUID Value	<p>This field limits the maximum value the processor Standard CPUID Function will support. Some operating systems will not complete installation when the maximum CPUID Function supported is greater than 3.</p> <p>This option is disabled by default.</p>
HDD Acoustic Mode	<p>This option allows you to optimize your hard drives performance and acoustic noise level based on your personal preferences.</p> <ul style="list-style-type: none"> • Bypass(default)- Do nothing (needed for older drives) • Quiet- The drive is slower, but quieter. • Suggested - Allow drive manufacturer to select the mode. • Performance- The drive is faster, but possibly noisier.

Virtualization Support

Virtualization	<p>This Option specifies whether a Virtual Machine Monitor (VMM) can utilize the additional hardware capabilities provided by Intel® Virtualization Technology.</p> <p>Enable Intel® Virtualization Technology - This option is disabled by default.</p>
VT for Direct I/O	<p>Enables or disables the Virtual Machine Monitor (VMM) from utilizing the additional hardware capabilities provided by Intel® Virtualization technology for direct I/O.</p> <p>Enable Intel® Virtualization Technology for Direct I/O - This option is disabled by default.</p>
Trusted Execution	<p>Field specifies whether a Measured Virtual Machine(MVMM) can utilize the additional hardware capabilities provided by Intel® Trusted Execution Technology.</p> <p>Enable Intel® Trusted Execution Technology - This option is disabled by default.</p>

Security

Administrative Password	<p>Provides restricted access to the computer's system setup program in the same way that access to the computer can be restricted with the System Password option.</p> <p>This option is not set by default.</p>
System Password	<p>Displays the current status of the system password security feature and allows a new system password to be assigned and verified.</p> <p>This option is not set by default.</p>
Password Changes	<p>Enables or disables the user from changing the system password without the administrative password.</p> <p>This option is enabled by default.</p>

CPU XD Support	Enables or disables the execute disable mode of the processor. This option is enabled by default.
Computrace(R)	Enables or disables the optional Computrace® service designed for asset management. You can set this option to: <ul style="list-style-type: none"> • Deactivate (default) • Disable • Activate
SATA-0 Password	Displays the current status of the password set for the hard drive connected to the SATA-0 connector on the system board. You can also set a new password. This option is not set by default. NOTE: The system setup program displays a password for each of the hard drives connected to your system board.

Power Management	
AC Recovery	Determines how the computer responds when AC power is re-applied after a power loss. You can set the AC Recovery to: <ul style="list-style-type: none"> • Power Off (default) • Power On • Last State
Auto On Time	Sets time to automatically turn on the computer. Time is kept in the standard 12-hour format (hours:minutes:seconds). Change the startup time by typing the values in the time and AM/PM fields. NOTE: This feature does not work if you turn off your computer using the switch on a power strip or surge protector or if Auto Power On is set to disabled .
Low Power Mode	Enables or disables low power mode. This option is disabled by default. When low power mode is enabled, the integrated network card is disabled when the computer shutdown or hibernates. Only add-in network cards will be able to remotely wake the computer.
Remote Wakeup	Allows the computer to power up when a network interface controller receives a wake up signal. You can set Remote Wakeup to: <ul style="list-style-type: none"> • Disable (default) • Enable • Enable with Boot NIC
Suspend Mode	Sets the power management suspend mode to: <ul style="list-style-type: none"> • S1 • S3 (default)
Fan Control Override	Controls the speed of the system fan. NOTE: When enabled, the fan runs at full speed.

Maintenance	
Service Tag	Displays the Service Tag of your computer.
Asset Tag	Allows you to create a system asset tag if an asset tag is not already set. This option is not set by default.
SERR Messages	Controls the SERR Message mechanism. This option is enabled by default. Some graphics cards require the SERR Message mechanism be disabled.

Image Server	
Lookup Method	Specifies how the ImageServer looks up the server address. <ul style="list-style-type: none"> • Static IP • DNS NOTE: You must set the Integrated NIC to Enable with ImageServer to set the Lookup Method .
ImageServer IP	Specifies the primary static IP address of the ImageServer with which the client software communicates. The default IP address is 255.255.255.255 NOTE: You must set the Integrated NIC to Enable with ImageServer to set the ImageServer IP .

ImageServer Port	Specifies the primary IP port of the image server with which the client software communicates. The default IP port is 06910 .
Client DHCP	Specifies how the client obtains the IP address. <ul style="list-style-type: none">• Static IP• DHCP (default)
Client IP	Specifies the static IP address of the client. The default IP address is 255.255.255.255 NOTE: To set Client IP you must set Client DHCP to Static IP
Client SubnetMask	Specifies the subnet mask for the client. The default setting is 255.255.255.255 NOTE: To set the Client SubnetMask you must set Client DHCP to Static IP
Client Gateway	Specifies the gateway IP address for the client. The default setting is 255.255.255.255 NOTE: To set the Client SubnetMask you must set Client DHCP to Static IP
License Status	Displays the current license status.

Post Behavior	
Fast Boot	When enabled (default), your computer starts more quickly because it skips certain configurations and tests.
NumLock LED	Enables or disables the NumLock feature when your computer starts. When enabled (default), this option activates the numeric and mathematical features shown at the top of each key. When disabled, this option activates the cursor-control functions labeled on the bottom of each key
POST Hotkeys	Allows you to specify the function keys to display on the screen when the computer starts. <ul style="list-style-type: none">• Enable F2 = Setup (enabled by default)• Enable F12 = Boot menu (enabled by default)
Keyboard Errors	Enables or disables keyboard error reporting when the computer starts. This option is enabled by default.
MEBx Hotkey	sign-on displays a message stating the keystroke sequence required to enter the Manageability Engine BIOS Extensions(MEBx) Setup program. This option is enabled by default.
OS Install	Set the maximum memory for operating system to load while installation. If enabled the maximum available memory is 256 MB RAM. This option is disable by default. Reason being some operating system will not complete install with more then 2 GB of memory.

System Logs	
BIOS Events	Displays the system event log and allows you to: <ul style="list-style-type: none">• Clear Log• Mark all Entries

[Back to Contents Page](#)

[Back to Contents Page](#)

Coin-Cell Battery

Dell™ OptiPlex™ 380 Service Manual—Small Form Factor



WARNING: Before working inside your computer, read the safety information that shipped with your computer. For additional safety best practices information, see the Regulatory Compliance Homepage at www.dell.com/regulatory_compliance.

Removing the Coin-Cell Battery

1. Follow the procedures in [Before Working Inside Your Computer](#).
2. Remove the [hard-drive assembly](#).
3. Press in on the coin-cell battery release latch.

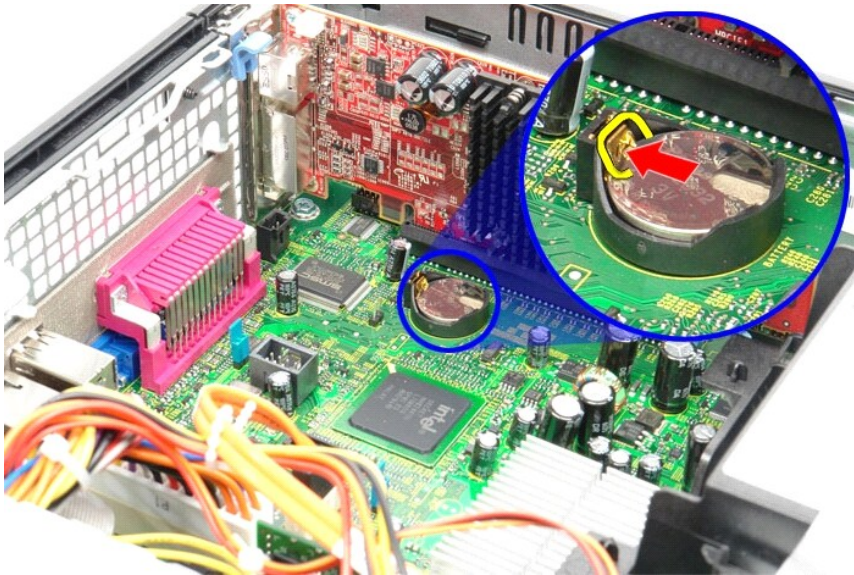

3. Remove the coin-cell battery from the computer.

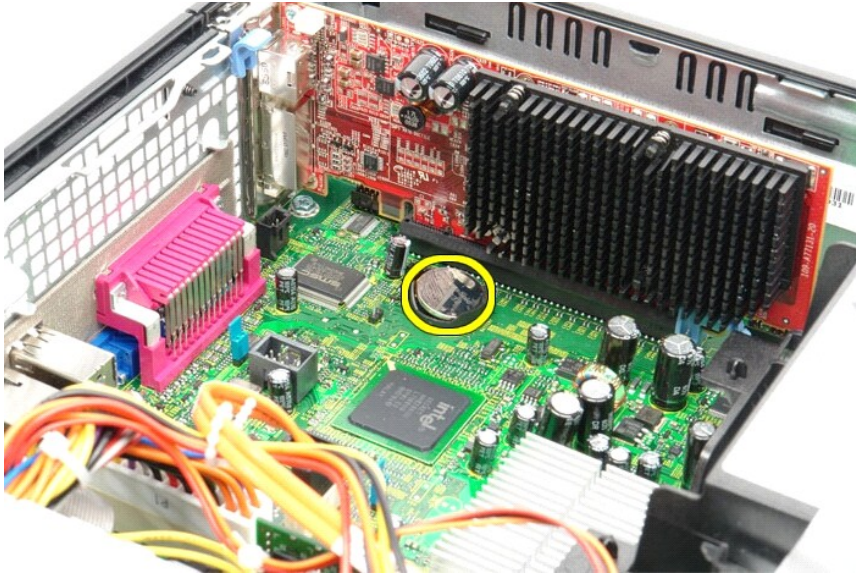

Replacing the Coin-Cell Battery

To replace the coin-cell battery, perform the above steps in reverse order.

[Back to Contents Page](#)

[Back to Contents Page](#)

Cover

Dell™ OptiPlex™ 380 Service Manual—Small Form Factor



⚠ WARNING: Before working inside your computer, read the safety information that shipped with your computer. For additional safety best practices information, see the Regulatory Compliance Homepage at www.dell.com/regulatory_compliance.

Removing the Cover

1. Follow the procedures in [Before Working Inside Your Computer](#).
2. Slide back the cover release latch.

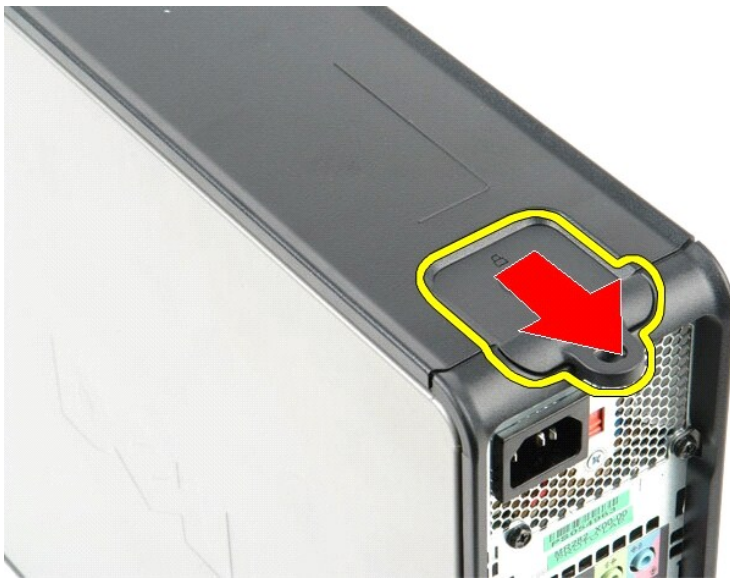

3. Tilt the cover from the top outward and remove the cover from the computer.



Replacing the Cover

To replace the cover, perform the above steps in reverse order.

[Back to Contents Page](#)

Diagnostics

Dell™ OptiPlex™ 380 Service Manual

- [Dell Diagnostics](#)
- [Power Button Light Codes](#)
- [Beep Codes](#)
- [Diagnostic Lights](#)

Dell Diagnostics

When to Use the Dell Diagnostics

It is recommended that you print these procedures before you begin.

- 📌 **NOTE:** The Dell Diagnostics software works only on Dell computers.
- 📌 **NOTE:** The *Drivers and Utilities* media is optional and may not ship with your computer.

Enter system setup (see [Entering System Setup](#)), review your computer's configuration information, and ensure that the device you want to test displays in System Setup and is active.

Start the Dell Diagnostics from either your hard drive or from the *Drivers and Utilities* media.

Starting the Dell Diagnostics From Your Hard Drive

1. Turn on (or restart) your computer.
2. When the DELL logo appears, press <F12> immediately.

- 📌 **NOTE:** If you see a message stating that no diagnostics utility partition has been found, run the Dell Diagnostics from your *Drivers and Utilities* media.

If you wait too long and the operating system logo appears, continue to wait until you see the Microsoft® Windows® desktop. Then shut down your computer and try again.

3. When the boot device list appears, highlight **Boot to Utility Partition** and press <Enter>.
4. When the Dell Diagnostics **Main Menu** appears, select the test that you want to run.

Starting the Dell Diagnostics From the Drivers and Utilities Disc

1. Insert the *Drivers and Utilities* disc.
2. Shut down and restart the computer.

When the DELL logo appears, press <F12> immediately.

If you wait too long and the Windows logo appears, continue to wait until you see the Windows desktop. Then shut down your computer and try again.

- 📌 **NOTE:** The next steps change the boot sequence for one time only. On the next startup, the computer boots according to the devices specified in the system setup program.

3. When the boot device list appears, highlight **Onboard or USB CD-ROM Drive** and press <Enter>.
4. Select the **Boot from CD-ROM** option from the menu that appears and press <Enter>.
5. Type 1 to start the menu and press <Enter> to proceed.
6. Select **Run the 32 Bit Dell Diagnostics** from the numbered list. If multiple versions are listed, select the version appropriate for your computer.
7. When the Dell Diagnostics **Main Menu** appears, select the test you want to run.

Dell Diagnostics Main Menu

1. After the Dell Diagnostics loads and the **Main Menu** screen appears, click the button for the option you want.

Option	Function
Express Test	Performs a quick test of devices. This test typically takes 10 to 20 minutes and requires no interaction on your part. Run Express Test first to increase the possibility of tracing the problem quickly.
Extended Test	Performs a thorough check of devices. This test typically takes 1 hour or more and requires you to answer questions periodically.
Custom Test	Tests a specific device. You can customize the tests you want to run.
Symptom Tree	Lists the most common symptoms encountered and allows you to select a test based on the symptom of the problem you are having.





- If a problem is encountered during a test, a message appears with an error code and a description of the problem. Write down the error code and problem description and follow the instructions on the screen.
- If you run a test from the **Custom Test** or **Symptom Tree** option, click the applicable tab described in the following table for more information.

Tab	Function
Results	Displays the results of the test and any error conditions encountered.
Errors	Displays error conditions encountered, error codes, and the problem description.
Help	Describes the test and may indicate requirements for running the test.
Configuration	Displays your hardware configuration for the selected device. The Dell Diagnostics obtains configuration information for all devices from system setup, memory, and various internal tests, and it displays the information in the device list in the left pane of the screen. The device list may not display the names of all the components installed on your computer or all devices attached to your computer.
Parameters	Allows you to customize the test by changing the test settings.

- When the tests are completed, if you are running the Dell Diagnostics from the *Drivers and Utilities* disc, remove the disc.
- Close the test screen to return to the **Main Menu** screen. To exit the Dell Diagnostics and restart the computer, close the **Main Menu** screen.

Power Button Light Codes

The diagnostic lights give much more information about the system state, but legacy power light states are also supported in your computer. The power light states are shown in following table.

Power Light State	Description
 Off	Power is off, light is blank.
 Blinking Amber	Initial state of light at power up. Indicates system has power, but the POWER_GOOD signal is not yet active. If the Hard Drive light is off , it is probable that the power supply needs to be replaced. If the Hard Drive light on , it is probable that an onboard regulator or VRM has failed. Look at the diagnostic lights for further information.
 Solid Amber	Second state of the light at power up. Indicates the POWER_GOOD signal is active and it is probable that the power supply is fine. Look at the diagnostic lights for further information.
 Blinking Green	System is in a low power state, either S1 or S3. Look at the diagnostic lights to determine which state the system is in.
 Solid Green	System is in S0 state, the normal power state of a functioning machine. The BIOS will turn the light to this state to indicate it has started fetching op-codes.

Beep Codes

If the monitor cannot display error messages during the POST, the computer may emit a series of beeps that identifies the problem or that can help you identify a faulty component or assembly. The following table lists the beep codes that may be generated during the POST. Most beep codes indicate a fatal error that prevents the computer from completing the boot routine until the indicated condition is corrected.











Code	Cause
1-1-2	Microprocessor register failure
1-1-3	NVRAM read/write failure
1-1-4	ROM BIOS checksum failure
1-2-1	Programmable interval timer failure
1-2-2	DMA initialization failure
1-2-3	DMA page register read/write failure
1-3	Video Memory Test failure
1-3-1 through 2-4-4	Memory not being properly identified or used
3-1-1	Slave DMA register failure
3-1-2	Master DMA register failure
3-1-3	Master interrupt mask register failure
3-1-4	Slave interrupt mask register failure
3-2-2	Interrupt vector loading failure
3-2-4	Keyboard Controller Test failure
3-3-1	NVRAM power loss

3-3-2	Invalid NVRAM configuration
3-3-4	Video Memory Test failure
3-4-1	Screen initialization failure
3-4-2	Screen retrace failure
3-4-3	Search for video ROM failure
4-2-1	No timer tick
4-2-2	Shutdown failure
4-2-3	Gate A20 failure
4-2-4	Unexpected interrupt in protected mode
4-3-1	Memory failure above address 0FFFFh
4-3-3	Timer-chip counter 2 failure
4-3-4	Time-of-day clock stopped
4-4-1	Serial or parallel port test failure
4-4-2	Failure to decompress code to shadowed memory
4-4-3	Math-coprocessor test failure
4-4-4	Cache test failure

Diagnostic Lights

To help troubleshoot a problem, your computer has four lights labeled 1, 2, 3, and 4 on the bank panel. When the computer starts normally, the lights flash before turning off. If the computer malfunctions, the sequence of the lights help to identify the problem.

 **NOTE:** After the computer completes POST, all four lights turn off before booting to the operating system.

Light Pattern	Problem Description	Suggested Resolution
	The computer is in a normal <i>off</i> condition or a possible pre-BIOS failure has occurred. The diagnostic lights are not lit after the computer successfully boots to the operating system.	<ul style="list-style-type: none"> Plug the computer into a working electrical outlet. If the problem persists, contact Dell.
	A possible processor failure has occurred.	<ul style="list-style-type: none"> Reseat the processor (see Processor information for your computer). If the problem persists, contact Dell.
	Memory modules are detected, but a memory failure has occurred.	<ul style="list-style-type: none"> If two or more memory modules are installed, remove the modules, then reinstall one module and restart the computer. If the computer starts normally, continue to install additional memory modules (one at a time) until you have identified a faulty module or reinstalled all modules without error. If available, install working memory of the same type into your computer. If the problem persists, contact Dell.
	A possible graphics card failure has occurred.	<ul style="list-style-type: none"> Reseat any installed graphics cards. If available, install a working graphics card into your computer. If the problem persists, contact Dell.
	A possible floppy drive or hard drive failure has occurred.	Reseat all power and data cables.
	A possible USB failure has occurred.	Reinstall all USB devices and check all cable connections.
	No memory modules are detected.	<ul style="list-style-type: none"> If two or more memory modules are installed, remove the modules, then reinstall one module and restart the computer. If the computer starts normally, continue to install additional memory modules (one at a time) until you have identified a faulty module or reinstalled all modules without error. If available, install working memory of the same type into your computer. If the problem persists, contact Dell.
	Memory modules are detected, but a memory configuration or compatibility error has occurred.	<ul style="list-style-type: none"> Ensure that no special requirements for memory module/connector placement exist. Ensure that the memory you are using is supported by your computer (see the Specifications section for your computer). If the problem persists, contact Dell.
	A possible expansion card failure has occurred.	<ul style="list-style-type: none"> Determine if a conflict exists by removing an expansion card (not a graphics card) and restarting the computer. If the problem persists, reinstall the card you removed, then remove a different card and restart the computer. Repeat this process for each expansion card installed. If the computer starts normally, troubleshoot the last card removed from the computer for resource conflicts. If the problem persists, contact Dell.
	Another failure has occurred.	<ul style="list-style-type: none"> Ensure that all hard drive and optical drive cables are properly connected to the system board. If there is an error message on the screen identifying a problem with a device (such as the floppy drive or hard drive), check the device to make sure it is functioning properly.

- | | | |
|--|--|-------------------------------------------------------------------------------------------------------------------------------------------------------------------------------------------------------------------------------------------------------------------------------------------------------------------|
| | | <ul style="list-style-type: none">• If the operating system is attempting to boot from a device (such as the floppy drive or optical drive), check system setup to ensure the boot sequence is correct for the devices installed on your computer.• If the problem persists, contact Dell. |
|--|--|-------------------------------------------------------------------------------------------------------------------------------------------------------------------------------------------------------------------------------------------------------------------------------------------------------------------|

[Back to Contents Page](#)

[Back to Contents Page](#)

Expansion Card

Dell™ OptiPlex™ 380 Service Manual—Small Form Factor



⚠ WARNING: Before working inside your computer, read the safety information that shipped with your computer. For additional safety best practices information, see the Regulatory Compliance Homepage at www.dell.com/regulatory_compliance.

Removing Expansion Cards

1. Follow the procedures in [Before Working Inside Your Computer](#).
2. Push in on the release tab on the card retention latch from the inside, then pivot the latch open.



3. If you are removing a PCI-Express x16 video card go to [step 4](#), else go to [step 5](#).
4. Press the lever on the securing tab until you release the securing tab.



5. Grasp the card by its top corners and ease it out of its connector.



Replacing Expansion Cards

To replace the expansion cards, perform the above steps in reverse order.

[Back to Contents Page](#)

[Back to Contents Page](#)

Fan

Dell™ OptiPlex™ 380 Service Manual—Small Form Factor



⚠ WARNING: Before working inside your computer, read the safety information that shipped with your computer. For additional safety best practices information, see the Regulatory Compliance Homepage at www.dell.com/regulatory_compliance.

Removing the Fan

1. Follow the procedures in [Before Working Inside Your Computer](#).
2. Remove the [system board](#).
3. Remove the diagnostic-lights ribbon cable.



4. Press in on the retaining clips to release the fan from the computer chassis.



5. Tilt the fan forward and remove it from the computer chassis.

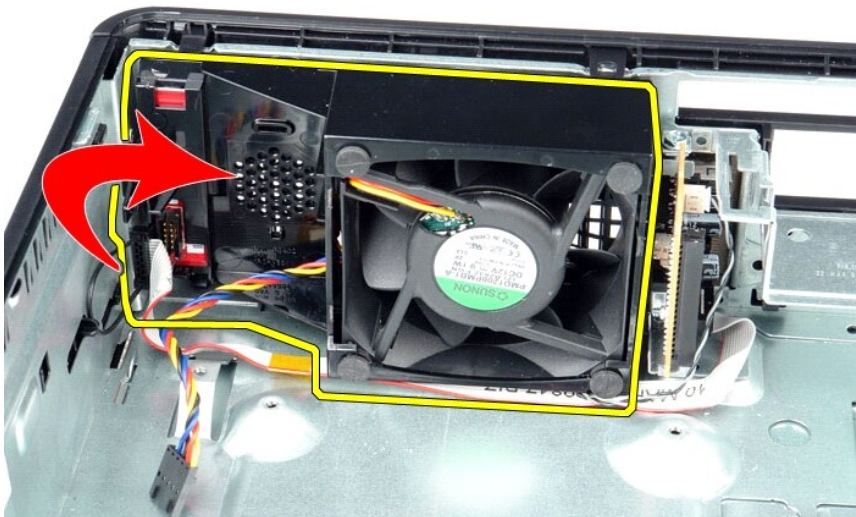

Replacing the Fan

To replace the fan, perform the above steps in reverse order.

[Back to Contents Page](#)

[Back to Contents Page](#)

Hard Drive

Dell™ OptiPlex™ 380 Service Manual—Small Form Factor



⚠ WARNING: Before working inside your computer, read the safety information that shipped with your computer. For additional safety best practices information, see the Regulatory Compliance Homepage at www.dell.com/regulatory_compliance.

Removing the Hard Drive

1. Follow the procedures in [Before Working Inside Your Computer](#).
2. Release the cable tie.



3. Disconnect the data cable from the system board.



4. Press in on the blue securing tabs on each side of the hard-drive assembly and slide the assembly up and out of the computer.

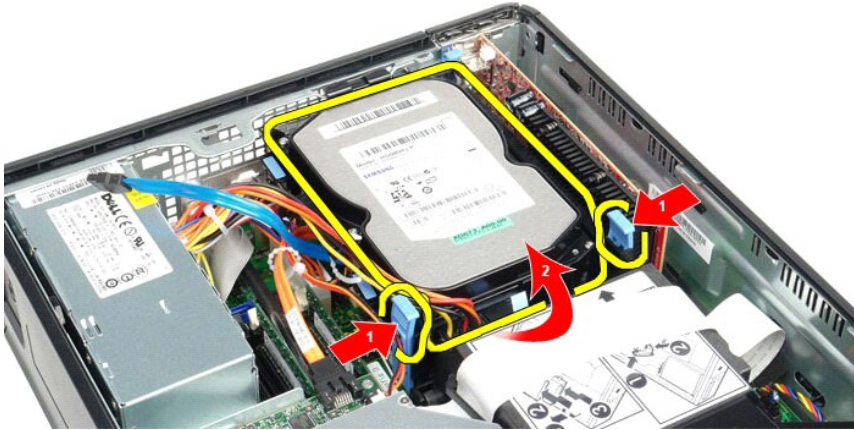

5. Disconnect the hard-drive power cable.



6. Disconnect the hard-drive fan cable.



7. Remove the hard-drive assembly from the computer.

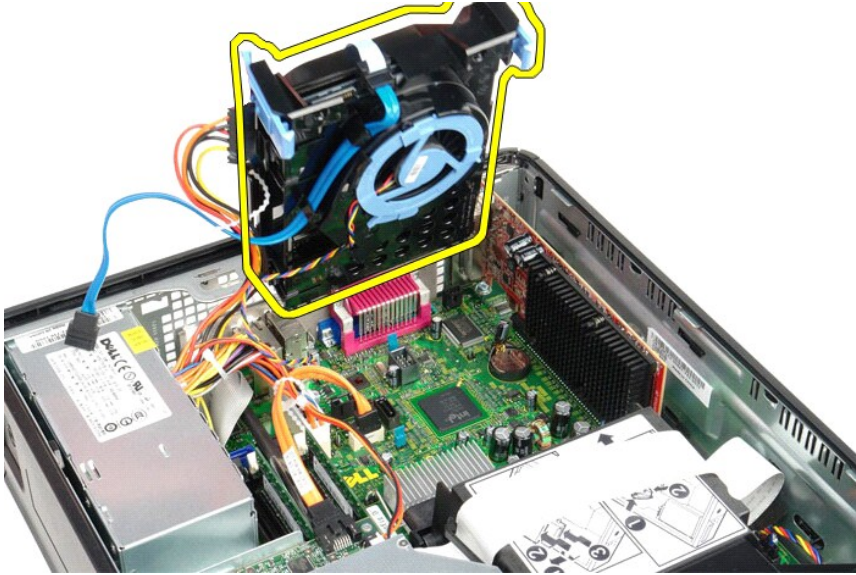

8. Pull on the blue tab to disconnect the hard-drive data cable from the hard-drive assembly.

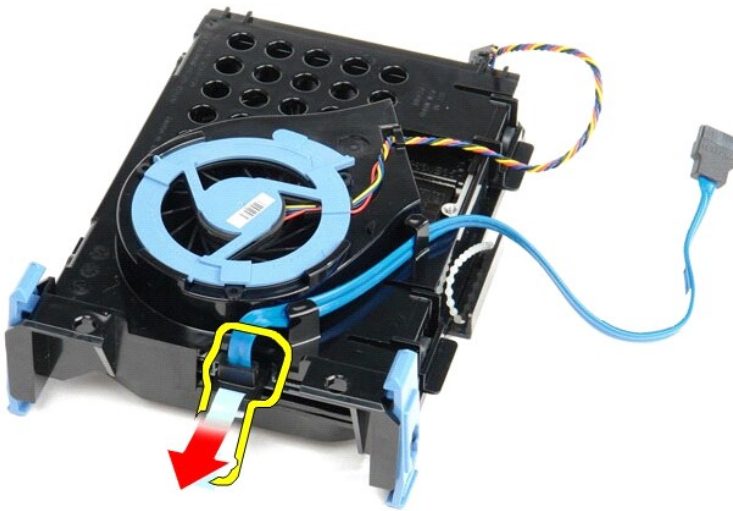

9. Remove the hard-drive data cable from the outside of the hard-drive assembly.



10. Remove the hard-drive fan cable from the outside of the hard-drive assembly.



11. Lift up on the blue tab and rotate it counter-clockwise to release the hard-drive fan from the hard-drive assembly.

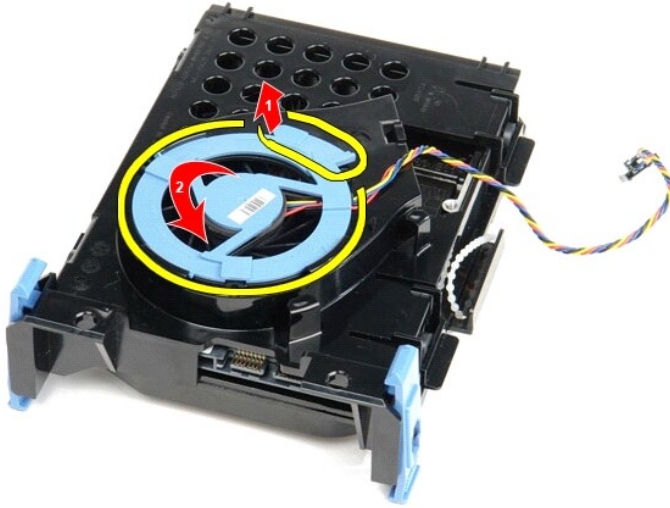

12. Remove the hard-drive fan from the hard drive assembly.

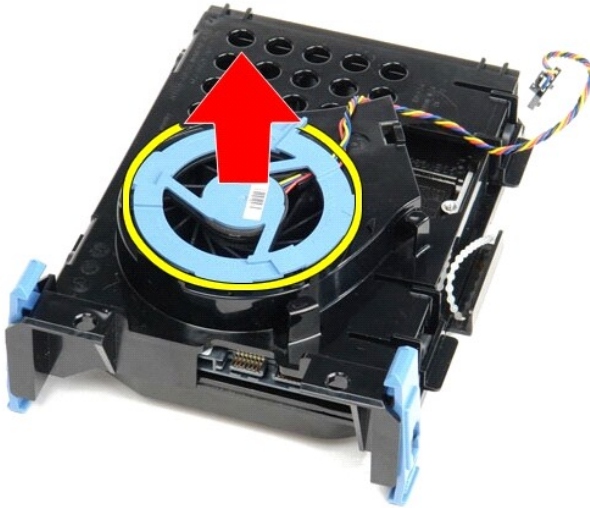

13. Pull back on the blue tabs and pull forward on the hard drive to remove the hard drive from the hard drive assembly.



14. Remove the hard drive from the hard-drive assembly.



Replacing the Hard Drive

To replace the hard drive, perform the above steps in reverse order.

[Back to Contents Page](#)

[Back to Contents Page](#)

Heat Sink and Processor

Dell™ OptiPlex™ 380 Service Manual—Small Form Factor



⚠ WARNING: Before working inside your computer, read the safety information that shipped with your computer. For additional safety best practices information, see the Regulatory Compliance Homepage at www.dell.com/regulatory_compliance.

Removing the Heat Sink and Processor

1. Follow the procedures in [Before Working Inside Your Computer](#).
2. Loosen the screws that secure the heat sink to the system board.

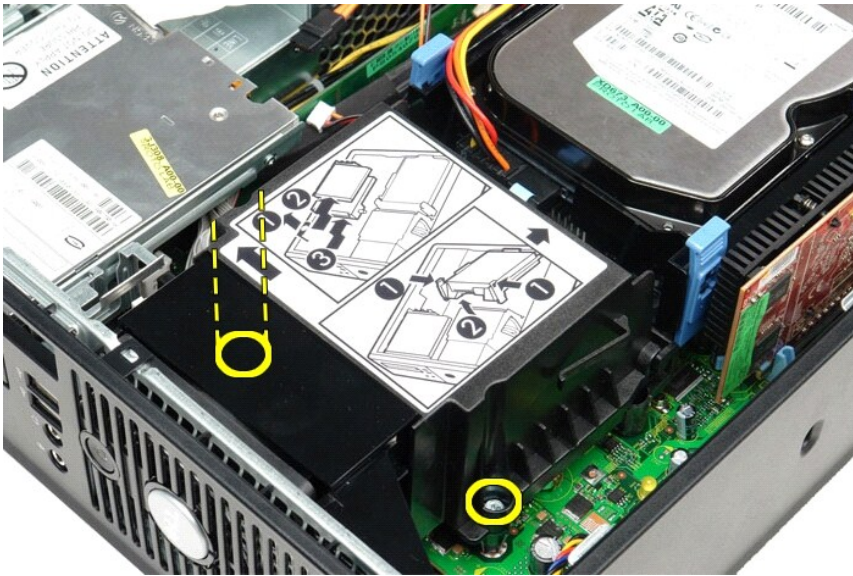

3. Rotate the heat sink towards the back of the computer and remove the heat sink.

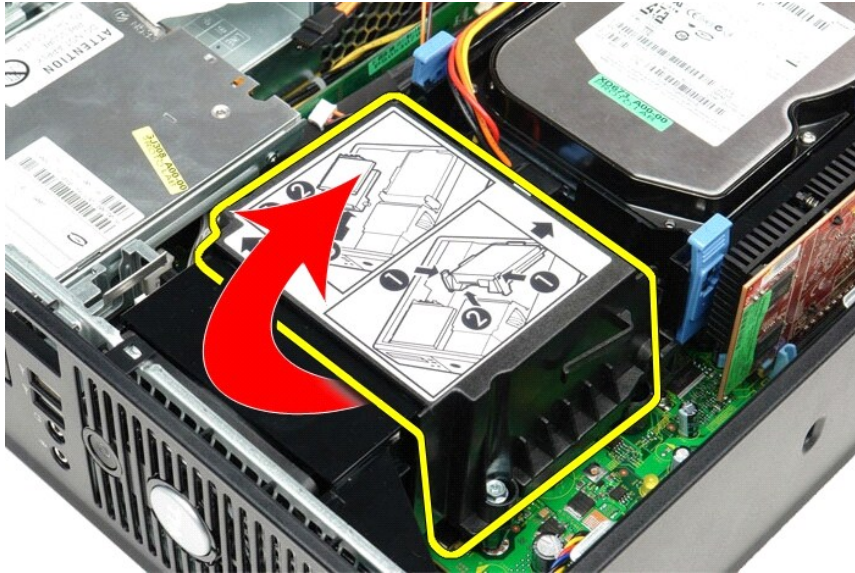

4. Press processor cover release lever down and out to release the cover.



5. Lift the processor cover.

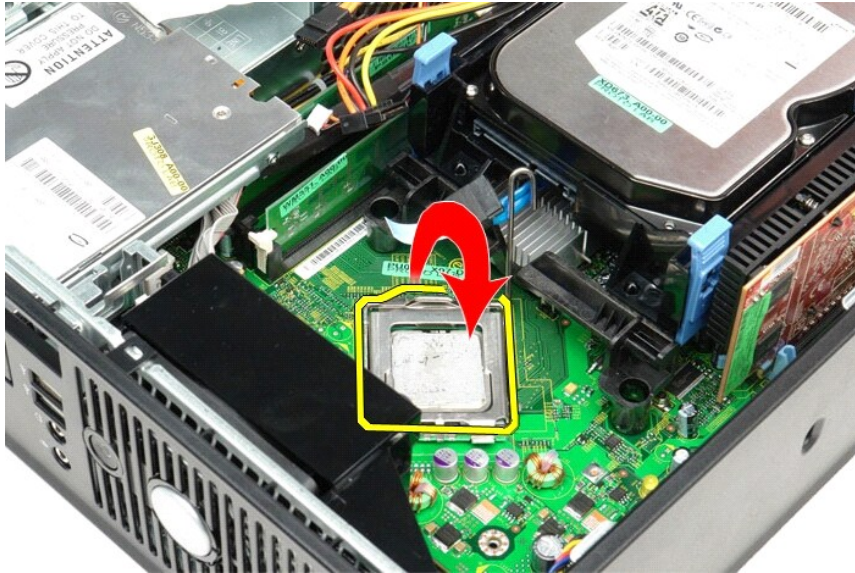

6. Remove the processor from the system board.



⚠ CAUTION: When replacing the processor, do not touch any of the pins inside the socket or allow any objects to fall on the pins in the socket.

Replacing the Heat Sink and Processor

To replace the heat sink and processor, perform the above steps in reverse order.

[Back to Contents Page](#)

[Back to Contents Page](#)

I/O Panel

Dell™ OptiPlex™ 380 Service Manual—Small Form Factor



⚠ WARNING: Before working inside your computer, read the safety information that shipped with your computer. For additional safety best practices information, see the Regulatory Compliance Homepage at www.dell.com/regulatory_compliance.

Removing the I/O Panel

1. Follow the procedures in [Before Working Inside Your Computer](#).
2. Remove the [system board](#).
3. Remove the [fan](#).
4. Press the clips on either sides of the air temperature sensor and remove it from the computer chassis.

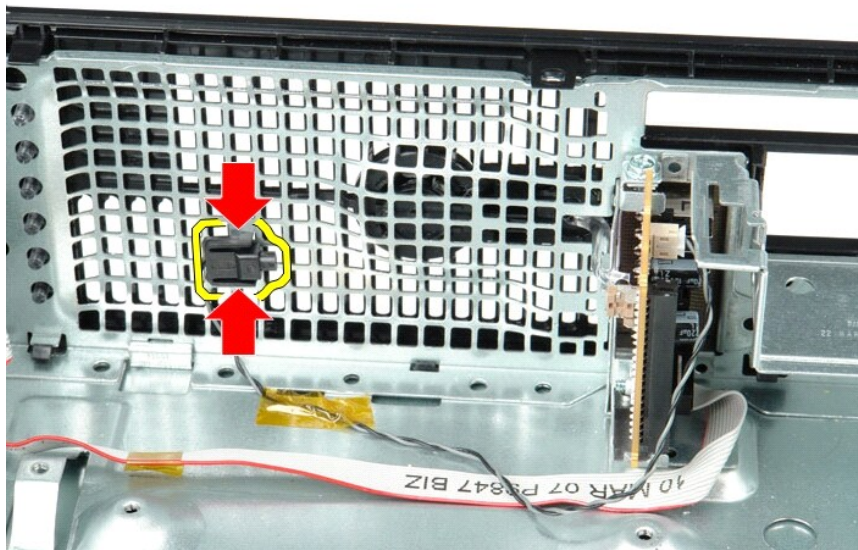

5. Remove the mounting screw that secures the I/O panel to the computer.

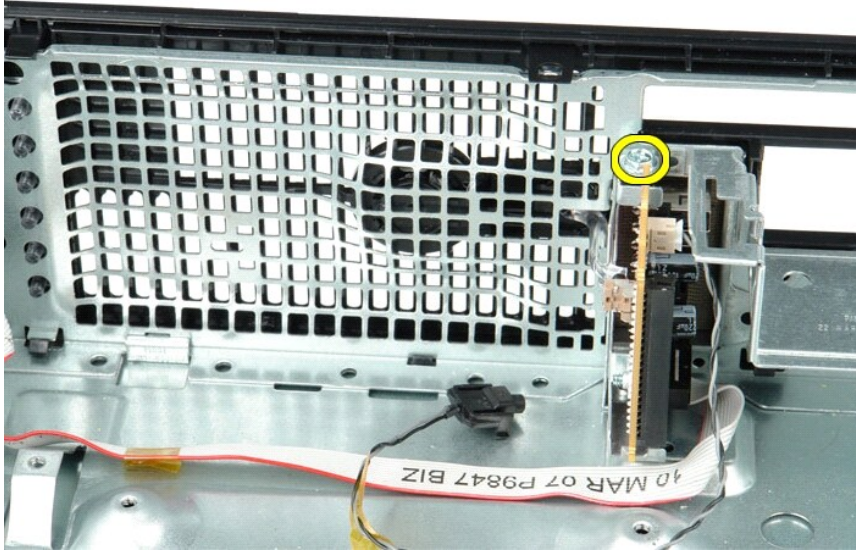

6. Ease the I/O panel back and forth to release its circular tabs from the chassis.

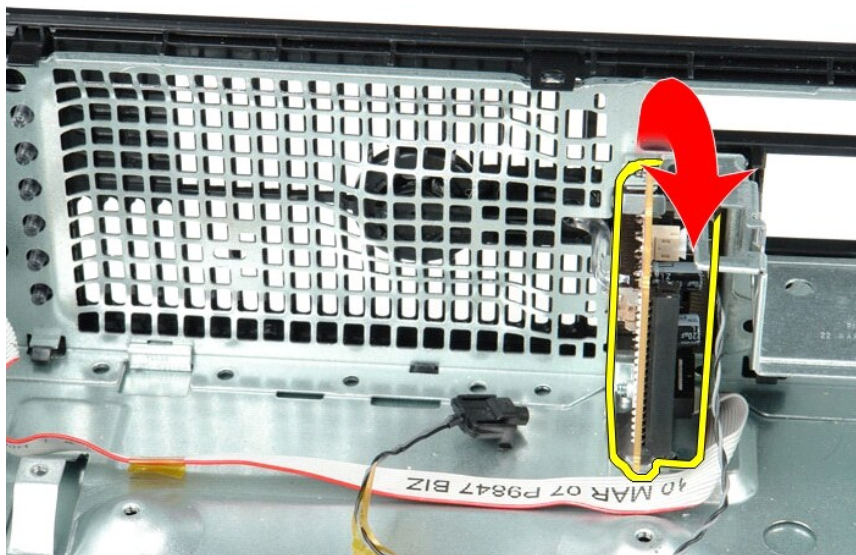

7. Remove the I/O panel from the computer.

Replacing the I/O Panel

To replace the I/O panel, perform the above steps in reverse order.

[Back to Contents Page](#)

[Back to Contents Page](#)

Memory

Dell™ OptiPlex™ 380 Service Manual—Small Form Factor



WARNING: Before working inside your computer, read the safety information that shipped with your computer. For additional safety best practices information, see the Regulatory Compliance Homepage at www.dell.com/regulatory_compliance.

Removing the Memory Module(s)

1. Follow the procedures in [Before Working Inside Your Computer](#).
2. Push down on the memory retention clips to release the memory module.

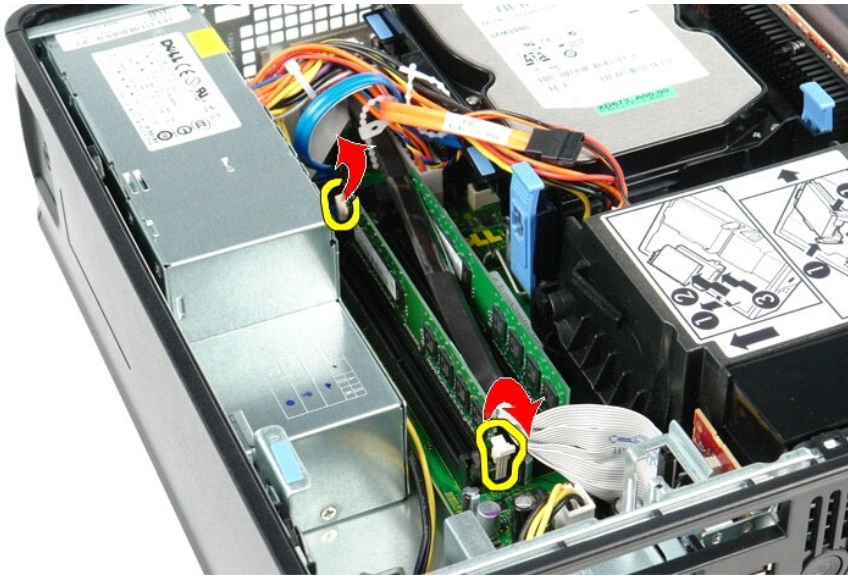

3. Lift the memory module out its connector on the system board and remove it from the computer.

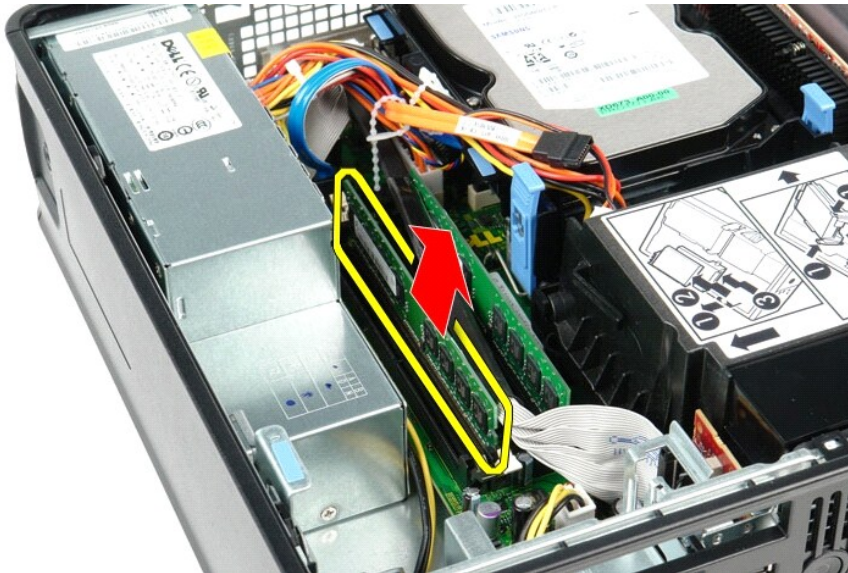

Replacing the Memory Module(s)

To replace the memory module, perform the above steps in reverse order.

[Back to Contents Page](#)

[Back to Contents Page](#)

Optical Drive

Dell™ OptiPlex™ 380 Service Manual—Small Form Factor



⚠ WARNING: Before working inside your computer, read the safety information that shipped with your computer. For additional safety best practices information, see the Regulatory Compliance Homepage at www.dell.com/regulatory_compliance.

Removing the Optical Drive

1. Follow the procedures in [Before Working Inside Your Computer](#).
2. Disconnect the power cable from the back of the optical drive.



3. Disconnect the data cable from the back of the optical drive.



4. Pull up on the drive-release latch and slide the optical drive towards the back of the computer.

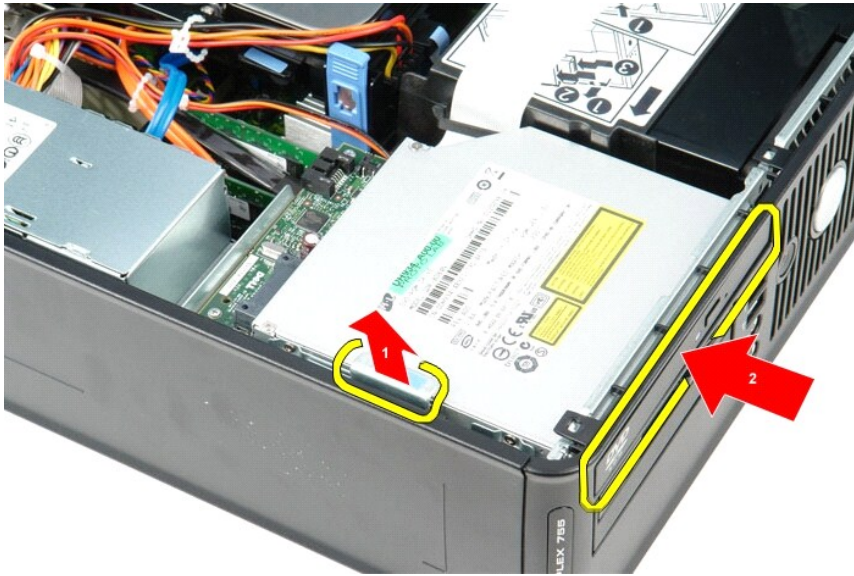

5. Lift the optical drive up and out of the computer.



Replacing the Optical Drive

To replace the optical drive, perform the above steps in reverse order.

[Back to Contents Page](#)

[Back to Contents Page](#)

Removing and Replacing Parts

Dell™ OptiPlex™ 380 Service Manual—Small Form Factor

- [Cover](#)
- [Optical Drive](#)
- [Memory](#)
- [Heat Sink and Processor](#)
- [Coin-Cell Battery](#)
- [Fan](#)
- [Hard Drive](#)
- [Expansion Cards](#)
- [Power Supply](#)
- [System Board](#)
- [I/O Panel](#)

[Back to Contents Page](#)

[Back to Contents Page](#)

Power Supply

Dell™ OptiPlex™ 380 Service Manual—Small Form Factor



⚠ WARNING: Before working inside your computer, read the safety information that shipped with your computer. For additional safety best practices information, see the Regulatory Compliance Homepage at www.dell.com/regulatory_compliance.

Removing the Power Supply

1. Follow the procedures in [Before Working Inside Your Computer](#).
2. Remove the [optical drive](#).
3. Disconnect the processor power cable from the system board.

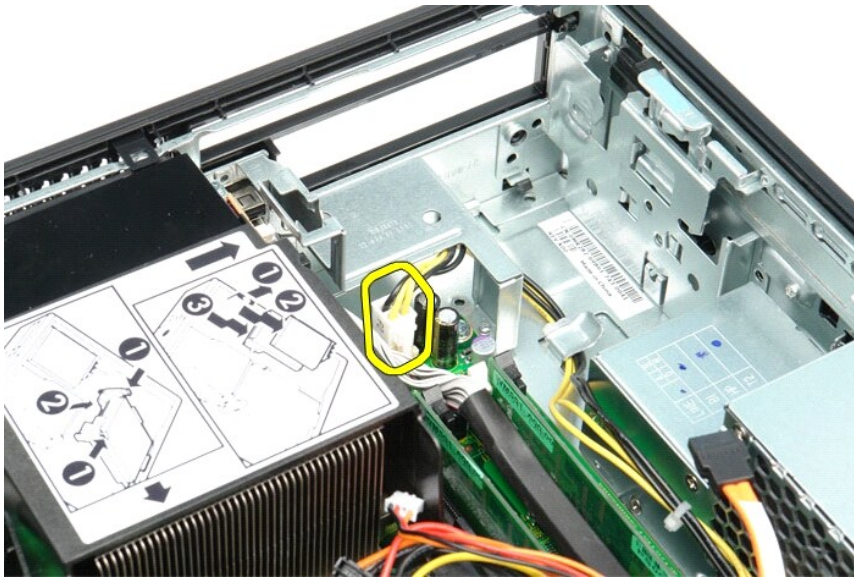

4. Remove the processor power cable from its routing guides on the chassis.

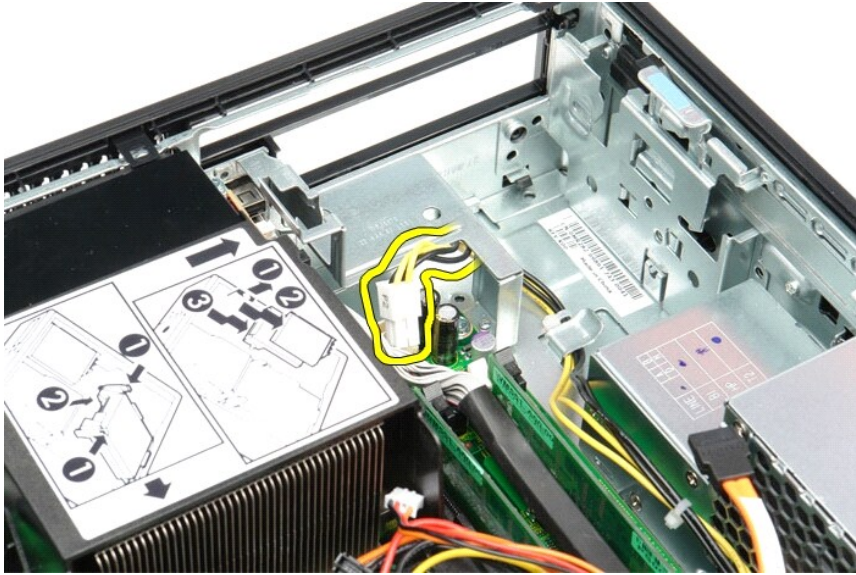

5. Press the release latch and disconnect the main power cable from the system board.



6. Remove the screws that secure the power supply to the computer chassis.

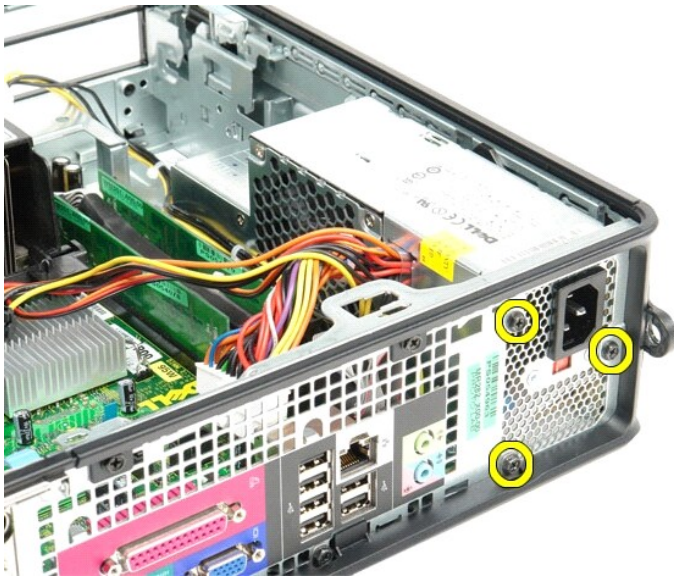

7. Slide the power supply towards the front of the computer.



8. Lift the power supply up and out of the computer.



Replacing the Power Supply

To replace the power supply, perform the above steps in reverse order.

[Back to Contents Page](#)

[Back to Contents Page](#)

Specifications

Dell™ OptiPlex™ 380 Service Manual—Small Form Factor

- [System Information](#)
- [Memory](#)
- [Audio](#)
- [Expansion Bus](#)
- [Drives](#)
- [System Board Connectors](#)
- [Physical](#)
- [Processor](#)
- [Video](#)
- [Network](#)
- [Cards](#)
- [External Connectors](#)
- [Power](#)
- [Environmental](#)

 **NOTE:** Offerings may vary by region. For more information regarding the configuration of your computer, click Start→ Help and Support and select the option to view information about your computer.

System Information	
Chipset	Intel® G41 Express chipset
DMA channels	eight
Interrupt levels	24
BIOS chip (NVRAM)	16 Mb (2 MB)

Processor	
Type	Intel Core™2 Quad, Core2 Duo, Intel Pentium® Dual-Core, Intel Celeron® Dual-Core, Intel Celeron
Level 2 (L2) cache	512 KB – 12 MB (depending on processor model)

Memory	
Type	DDR3 SDRAM (non-ECC memory only)
Speed	1067 MHz
Connectors	two
Capacity	1 GB or 2 GB
Minimum memory	1 GB
Maximum memory	4 GB

Video	
Integrated	Intel GMA X4500
Discrete	PCI-E x16 half-length graphics card with two DVI and one S-Video out, or one DVI, one VGA, and one S-Video out: NVIDIA GeForce 9300 GE – 256 MB ATI Radeon™ HD 3450 – 256 MB

Audio	
Integrated	5.1 channel High Definition audio

Network	
Integrated	Broadcom BCM57780 Gigabit network interface card capable of 10/100/1000 Mb/s communication

Expansion Bus	
Bus type	PCI 2.3 PCI Express 1.0 SATA 1.0A and 2.0 USB 2.0
Bus speed	PCI: 133 MB/s PCI Express: x16-slot bidirectional speed — 8 GB/s SATA: 1.5 Gb/s and 3.0 Gb/s USB: 480 Mb/s

Cards		
PCI:	Full Height	Low Profile
Mini-tower	two	none
Desktop	two (with a PCI riser installed)	
Small form factor	none	one
PCI-Express x16 (with support for PCI-		

Express x1):		
Mini-tower	one	
Desktop	one (with combo riser installed)	
Small form factor	none	one

Drives	
Externally accessible:	
5.25-inch drive bays	Mini-tower — two Desktop — one Small form factor — one (slim line)
Internally accessible:	
3.5-inch drive bays	Mini-tower — two Desktop — one Small form factor — one

External Connectors	
Audio:	
back panel	two connectors for line-out and line-in/microphone
front panel	two connectors for microphone and headphone
Network adapter	one RJ45 connector
Serial	one 9-pin connector; 16550C compatible
Parallel	one 25-pin connector
USB:	
front panel	two
back panel	six
Video	15-pin VGA connector 28-pin DVI-I connector NOTE: Available video connectors may vary based on the graphics card selected.

System Board Connectors	
PCI 2.3:	
connectors	120-pin connector
data width (maximum)	32 bits
PCI Express x16:	
connectors	164-pin connector
data width (maximum)	16 PCI-Express lanes
Serial ATA	Mini-tower — three 7-pin connectors Desktop — three 7-pin connectors Small form factor — two 7-pin connectors
Memory	two 240-pin connectors
Processor fan	one 5-pin connector
System fan	one 5-pin connector
Front panel control/front panel audio	one 40-pin connector
Processor	one LGA775 connector
Power 12V	one 4-pin connector
Power	one 24-pin connector

Power			
Mini-Tower:	Wattage	Maximum heat dissipation	Voltage
Non-EPA	255 W	1338 BTU/hr	115/230 VAC, 50/60 Hz, 6.5/3.5 A
EPA	255 W	1023 BTU/hr	100-240 VAC, 50/60 Hz, 1.8/3.6 A
Desktop:			
Non-EPA	235 W	1233 BTU/hr	115/230 VAC, 50/60 Hz, 6.5/3.5 A
EPA	255 W	1023 BTU/hr	100-240 VAC, 50/60 Hz, 2.0/4.0 A
Small Form Factor:			
Non-EPA	235 W	1233 BTU/hr	115/230 VAC, 50/60 Hz, 6.5/3.5 A
EPA	235 W	943 BTU/hr	100-240 VAC, 50/60 Hz, 1.8/3.5 A
Coin-cell battery	3V CR2032 lithium coin cell		

NOTE: Heat dissipation is calculated by using the power supply wattage rating.

NOTE: See the safety information that shipped with your computer for important voltage-setting information.

Physical				
	Height	Width	Depth	Weight
Mini-Tower	40.8 cm (16.1 inches)	18.7 cm (7.4 inches)	43.3 cm (17.0 inches)	12.0 kg (26.5 lb)
Desktop	11.4 cm (4.5 inches)	39.9 cm (15.7 inches)	35.3 cm (13.9 inches)	9.0 kg (19.8 lb)
Small Form Factor	9.3 cm (3.7 inches)	31.4 cm (12.4 inches)	34.0 cm (13.4 inches)	7.0 kg (15.4 lb)

Environmental	
Temperature:	
Operating	10 °C to 35 °C (50 °F to 95 °F)
Storage	-40 °C to 65 °C (-40 °F to 149 °F)
Relative humidity (noncondensing)	operating: 20 % to 80 % (maximum wet bulb temperature: 29 °C) storage: 5 % to 95 % (maximum wet bulb temperature: 38 °C)
Maximum vibration:	
Operating	5-350 Hz at 0.0002 G2/Hz
Storage	5-500 Hz at 0.001 to 0.01 G2/Hz
Maximum shock:	
Operating	40 G +/- 5 % with pulse duration of 2 msec +/- 10 % (equivalent to 20 in/sec [51 cm/sec])
Storage	105 G +/- 5 % with pulse duration of 2 msec +/- 10 % (equivalent to 50 in/sec [127 cm/sec])
Altitude:	
Operating	-15.2 m to 3048 m (-50 ft to 10,000 ft)
Storage	-15.2 m to 10,668 m (-50 ft to 35,000 ft)
Airborne contaminant level	G2 or lower as defined by ISA-S71.04-1985

[Back to Contents Page](#)

System Board Layout

Dell™ OptiPlex™ 380 Service Manual—Small Form Factor

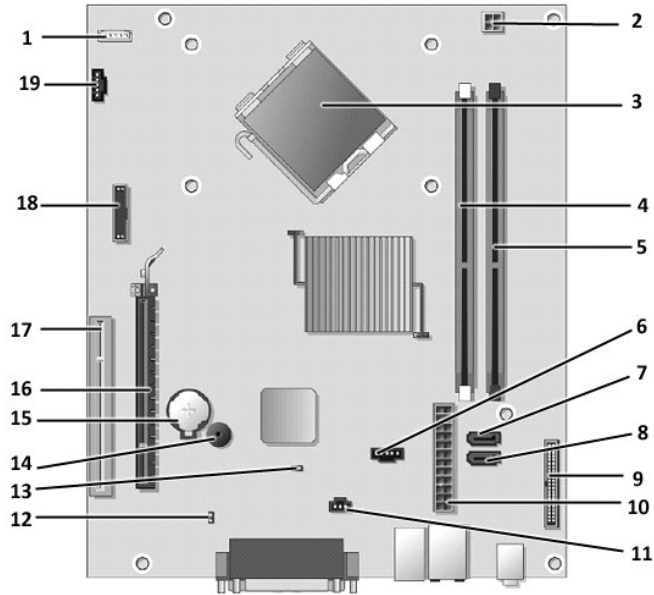

1	speaker connector (INT_SPKR)	2	processor power connector (12 V POWER)
3	processor connector (CPU)	4	memory module connector (DIMM_1)
5	memory module connector (DIMM_2)	6	hard-drive fan connector (FAN_HDD)
7	SATA drive connector (SATA 0)	8	SATA drive connector (SATA1)
9	front panel connector (FRONTPANEL)	10	power connector (POWER)
11	chassis intrusion switch connector (INTRUDER)	12	password jumper (PSWD)
13	reset jumper (RTCST)	14	internal speaker (SPKR)
15	coin-cell battery socket (BATTERY)	16	PCI Express x16 connector (SLOT1)
17	PCI connectors (SLOT2 and SLOT3)	18	serial/PS/2 connector (PS2/SER2)
19	processor fan connector (FAN_CPU)		

[Back to Contents Page](#)

System Board

Dell™ OptiPlex™ 380 Service Manual—Small Form Factor



⚠ WARNING: Before working inside your computer, read the safety information that shipped with your computer. For additional safety best practices information, see the Regulatory Compliance Homepage at www.dell.com/regulatory_compliance.

Removing the System Board

1. Follow the procedures in [Before Working Inside Your Computer](#).
2. Remove the [optical drive](#).
3. Remove the [hard drive](#).
4. Remove the [expansion card\(s\)](#).
5. Remove the [memory](#).
6. Remove the [heat sink and processor](#).
7. Disconnect the processor power cable from the system board.



9. Disconnect the hard-drive and optical-drive data cables from the system board.



10. Disconnect the main power connector.



11. Remove the I/O panel cable from the system board.

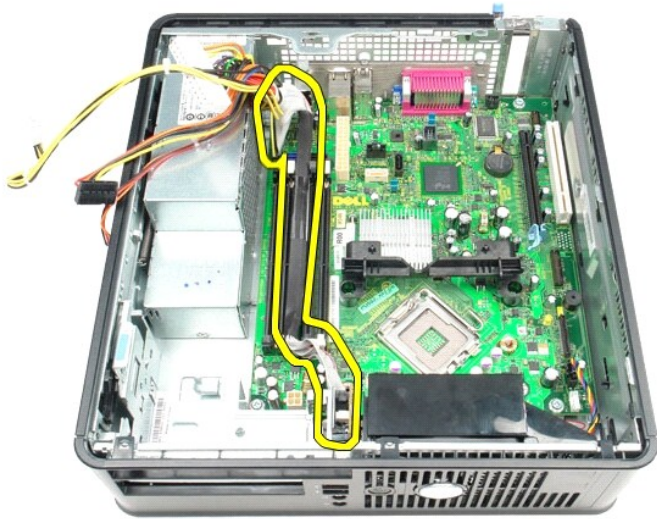

12. Disconnect the system-fan cable.



13. Remove the screws that secure the heat-sink retention module to the system board.



14. Remove the heat-sink retention module.



15. Remove the screws that secure the system board to the computer chassis.

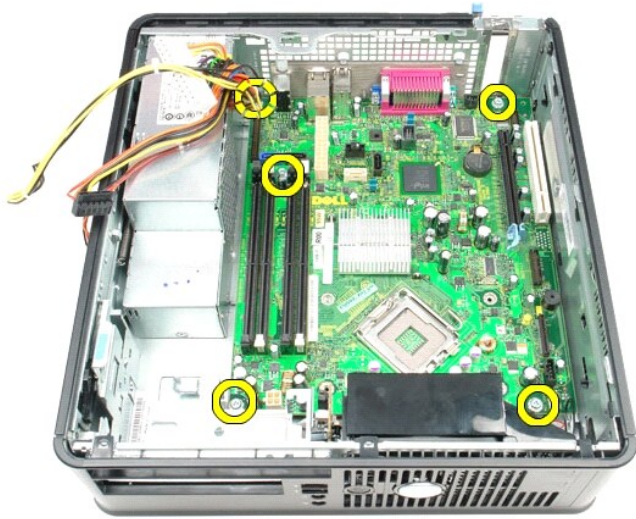

16. Remove the system board.

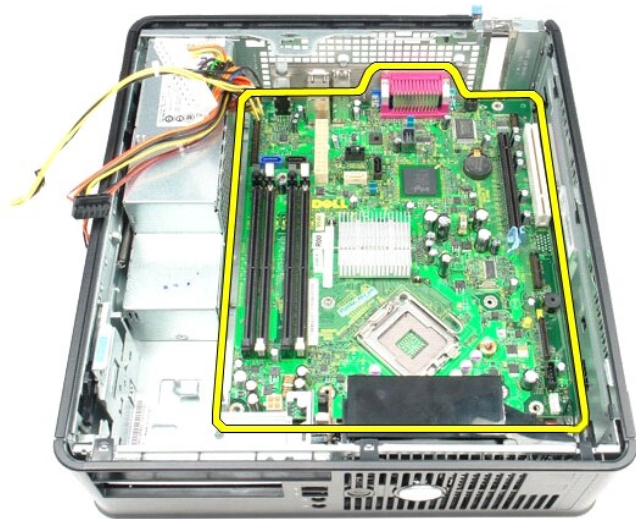

Replacing the System Board

To replace the system board, perform the above steps in reverse order.

[Back to Contents Page](#)

Working on Your Computer

Dell™ OptiPlex™ 380 Service Manual—Small Form Factor

- [Before Working Inside Your Computer](#)
- [Recommended Tools](#)
- [Turning Off Your Computer](#)
- [After Working Inside Your Computer](#)

Before Working Inside Your Computer

Use the following safety guidelines to help protect your computer from potential damage and to help to ensure your personal safety. Unless otherwise noted, each procedure included in this document assumes that the following conditions exist:

- You have performed the steps in [Working on Your Computer](#).
- You have read the safety information that shipped with your computer.
- A component can be replaced or—if purchased separately—installed by performing the removal procedure in reverse order.

WARNING: Before working inside your computer, read the safety information that shipped with your computer. For additional safety best practices information, see the Regulatory Compliance Homepage at www.dell.com/regulatory_compliance.

CAUTION: Only a certified service technician should perform repairs on your computer. Damage due to servicing that is not authorized by Dell is not covered by your warranty.

CAUTION: To avoid electrostatic discharge, ground yourself by using a wrist grounding strap or by periodically touching an unpainted metal surface, such as a connector on the back of the computer.

CAUTION: Handle components and cards with care. Do not touch the components or contacts on a card. Hold a card by its edges or by its metal mounting bracket. Hold a component such as a processor by its edges, not by its pins.

CAUTION: When you disconnect a cable, pull on its connector or on its pull-tab, not on the cable itself. Some cables have connectors with locking tabs; if you are disconnecting this type of cable, press in on the locking tabs before you disconnect the cable. As you pull connectors apart, keep them evenly aligned to avoid bending any connector pins. Also, before you connect a cable, ensure that both connectors are correctly oriented and aligned.

NOTE: The color of your computer and certain components may appear differently than shown in this document.

To avoid damaging your computer, perform the following steps before you begin working inside the computer.

1. Ensure that your work surface is flat and clean to prevent the cover from being scratched.
2. Turn off your computer (see [Turning Off Your Computer](#)).

CAUTION: To disconnect a network cable, first unplug the cable from your computer and then unplug the cable from the network device.

3. Disconnect all network cables from the computer.
4. Disconnect your computer and all attached devices from their electrical outlets.
5. Press and hold the power button while the computer is unplugged to ground the system board.
6. Remove the [cover](#).

CAUTION: Before touching anything inside your computer, ground yourself by touching an unpainted metal surface, such as the metal at the back of the computer. While you work, periodically touch an unpainted metal surface to dissipate static electricity, which could harm internal components.

Recommended Tools

The procedures in this document may require the following tools:

- Small flat-blade screwdriver
- Phillips screwdriver
- Small plastic scribe
- Flash BIOS update program media

Turning Off Your Computer

CAUTION: To avoid losing data, save and close all open files and exit all open programs before you turn off your computer.

1. Shut down the operating system:

- **In Windows Vista®:**

Click **Start** , then click the arrow in the lower-right corner of the **Start** menu as shown below, and then click **Shut Down**.



- **In Windows® XP:**

Click **Start**→ **Turn Off Computer**→ **Turn Off**.

The computer turns off after the operating system shutdown process is complete.

2. Ensure that the computer and all attached devices are turned off. If your computer and attached devices did not automatically turn off when you shut down your operating system, press and hold the power button for about 6 seconds to turn them off.

After Working Inside Your Computer

After you complete any replacement procedure, ensure you connect any external devices, cards, and cables before turning on your computer.

1. Replace the [cover](#).

 **CAUTION:** To connect a network cable, first plug the cable into the network device and then plug it into the computer.

2. Connect any telephone or network cables to your computer.
3. Connect your computer and all attached devices to their electrical outlets.
4. Turn on your computer.
5. Verify that the computer works correctly by running the Dell Diagnostics. See [Dell Diagnostics](#).

[Back to Contents Page](#)