

Dell Vostro 3580

Service Manual

Notes, cautions, and warnings

 **NOTE:** A NOTE indicates important information that helps you make better use of your product.

 **CAUTION:** A CAUTION indicates either potential damage to hardware or loss of data and tells you how to avoid the problem.

 **WARNING:** A WARNING indicates a potential for property damage, personal injury, or death.

© 2019 Dell Inc. or its subsidiaries. All rights reserved. Dell, EMC, and other trademarks are trademarks of Dell Inc. or its subsidiaries. Other trademarks may be trademarks of their respective owners.

1 Working on your computer	6
Safety instructions	6
Turning off your computer — Windows 10	6
Before working inside your computer	7
After working inside your computer	7
2 Technology and components	8
DDR4	8
HDMI 1.4	9
USB features	10
Intel Optane memory	11
Enabling Intel Optane memory	12
Disabling Intel Optane memory	12
3 Removing and installing components	13
Recommended tools	13
Screw list	13
Micro Secure Digital Card	14
Removing the Micro Secure Digital card	14
Installing the Micro Secure Digital card	15
Optical drive assembly	16
Removing the optical drive assembly	16
Installing the optical drive assembly	17
Base cover	19
Removing the base cover	19
Installing the base cover	20
Memory modules	22
Removing the memory module	22
Installing the memory module	22
WLAN card	23
Removing the WLAN card	23
Installing the WLAN card	24
Solid-state drive/Intel Optane	25
Removing the M.2 2230 Solid-state drive	25
Installing the M.2 2230 Solid-state drive	26
Removing the M.2 2280 Solid-state drive or Intel Optane memory - Optional	28
Installing the M.2 2280 Solid-state drive or Intel Optane memory - Optional	28
Coin-cell battery	29
Removing the coin-cell	29
Installing the coin-cell battery	30
Battery	31
Lithium-ion battery precautions	31
Removing the battery	32
Installing the battery	32

Hard drive.....	33
Removing the hard drive assembly.....	33
Installing the hard drive assembly.....	35
System fan.....	37
Removing the system fan.....	37
Installing the system fan.....	39
Heat sink.....	41
Removing the heatsink.....	41
Installing the heatsink.....	41
VGA Daughterboard.....	42
Removing the VGAcable.....	42
Installing the VGA cable.....	43
Speakers.....	44
Removing the speakers.....	44
Installing the speakers.....	45
IO board.....	46
Removing the IO board.....	46
Installing the IO board.....	48
Touchpad.....	49
Removing the touch pad assembly.....	49
Installing the touch pad assembly.....	51
Display assembly.....	53
Removing the display assembly.....	53
Installing the display assembly.....	56
Power-button board.....	58
Removing the power button board.....	58
Installing the power button board.....	59
System board.....	59
Removing the system board.....	59
Installing the system board.....	63
Power button.....	66
Removing the power button with fingerprint reader.....	66
Installing the power button with fingerprint reader.....	67
Power-adapter port.....	68
Removing the power adapter port.....	68
Installing the power adapter port.....	69
Display bezel.....	70
Removing the display bezel.....	70
Installing the display bezel	71
Camera.....	72
Removing the camera.....	72
Installing the camera.....	73
Display panel.....	74
Removing the display panel.....	74
Installation display panel.....	76
Display hinges.....	78
Removing the display hinges.....	78
Installing the display hinges.....	79
Display cable.....	80
Removing the display cable.....	80

Installing the display cable.....	81
Display back-cover and antenna assembly.....	82
Removing the display back-cover.....	82
Installing the display back-cover.....	84
Palm-rest and keyboard assembly.....	85
Removing the palmrest and keyboard assembly.....	85
4 Troubleshooting.....	87
Enhanced Pre-Boot System Assessment (ePSA) diagnostics.....	87
Running the ePSA diagnostics.....	87
System diagnostic lights.....	87
Flashing BIOS (USB key).....	88
Flashing the BIOS.....	88
Backup media and recovery options.....	89
WiFi power cycle.....	89
Flea power release.....	89
5 Getting help.....	90
Contacting Dell.....	90

Working on your computer

Safety instructions

Prerequisites

Use the following safety guidelines to protect your computer from potential damage and to ensure your personal safety. Unless otherwise noted, each procedure included in this document assumes that the following conditions exist:

- You have read the safety information that shipped with your computer.
- A component can be replaced or, if purchased separately, installed by performing the removal procedure in reverse order.

About this task

 **NOTE:** Disconnect all power sources before opening the computer cover or panels. After you finish working inside the computer, replace all covers, panels, and screws before connecting to the power source.

 **WARNING:** Before working inside your computer, read the safety information that shipped with your computer. For additional safety best practices information, see the [Regulatory Compliance Homepage](#)

 **CAUTION:** Many repairs may only be done by a certified service technician. You should only perform troubleshooting and simple repairs as authorized in your product documentation, or as directed by the online or telephone service and support team. Damage due to servicing that is not authorized by Dell is not covered by your warranty. Read and follow the safety instructions that came with the product.

 **CAUTION:** To avoid electrostatic discharge, ground yourself by using a wrist grounding strap or by periodically touching an unpainted metal surface at the same time as touching a connector on the back of the computer.

 **CAUTION:** Handle components and cards with care. Do not touch the components or contacts on a card. Hold a card by its edges or by its metal mounting bracket. Hold a component such as a processor by its edges, not by its pins.

 **CAUTION:** When you disconnect a cable, pull on its connector or on its pull-tab, not on the cable itself. Some cables have connectors with locking tabs; if you are disconnecting this type of cable, press in on the locking tabs before you disconnect the cable. As you pull connectors apart, keep them evenly aligned to avoid bending any connector pins. Also, before you connect a cable, ensure that both connectors are correctly oriented and aligned.

 **NOTE:** The color of your computer and certain components may appear differently than shown in this document.

Turning off your computer — Windows 10

About this task

 **CAUTION:** To avoid losing data, save and close all open files and exit all open programs before you turn off your computer or remove the side cover.

Steps

1. Click or tap .
2. Click or tap  and then click or tap **Shut down**.

 **NOTE:** Ensure that the computer and all attached devices are turned off. If your computer and attached devices did not automatically turn off when you shut down your operating system, press and hold the power button for about 6 seconds to turn them off.

Before working inside your computer

About this task

To avoid damaging your computer, perform the following steps before you begin working inside the computer.

Steps

1. Ensure that you follow the [Safety Instruction](#).
2. Ensure that your work surface is flat and clean to prevent the computer cover from being scratched.
3. Turn off your computer.
4. Disconnect all network cables from the computer.

 **CAUTION:** To disconnect a network cable, first unplug the cable from your computer and then unplug the cable from the network device.

5. Disconnect your computer and all attached devices from their electrical outlets.
6. Press and hold the power button while the computer is unplugged to ground the system board.

 **NOTE:** To avoid electrostatic discharge, ground yourself by using a wrist grounding strap or by periodically touching an unpainted metal surface at the same time as touching a connector on the back of the computer.

After working inside your computer

About this task

After you complete any replacement procedure, ensure that you connect any external devices, cards, and cables before turning on your computer.

Steps

1. Connect any telephone or network cables to your computer.

 **CAUTION:** To connect a network cable, first plug the cable into the network device and then plug it into the computer.

2. Connect your computer and all attached devices to their electrical outlets.
3. Turn on your computer.
4. If required, verify that the computer works correctly by running **ePSA diagnostics**.

Technology and components

NOTE: Instructions provided in this section are applicable on computers shipped with Windows 10 operating system. Windows 10 is factory-installed with this computer.

Topics:

- [DDR4](#)
- [HDMI 1.4](#)
- [USB features](#)
- [Intel Optane memory](#)

DDR4

DDR4 (double data rate fourth generation) memory is a higher-speed successor to the DDR2 and DDR3 technologies and allows up to 512 GB in capacity, compared to the DDR3's maximum of 128 GB per DIMM. DDR4 synchronous dynamic random-access memory is keyed differently from both SDRAM and DDR to prevent the user from installing the wrong type of memory into the system.

DDR4 needs 20 percent less or just 1.2 volts, compared to DDR3 which requires 1.5 volts of electrical power to operate. DDR4 also supports a new, deep power-down mode that allows the host device to go into standby without needing to refresh its memory. Deep power-down mode is expected to reduce standby power consumption by 40 to 50 percent.

DDR4 Details

There are subtle differences between DDR3 and DDR4 memory modules, as listed below.

Key notch difference

The key notch on a DDR4 module is in a different location from the key notch on a DDR3 module. Both notches are on the insertion edge but the notch location on the DDR4 is slightly different, to prevent the module from being installed into an incompatible board or platform.

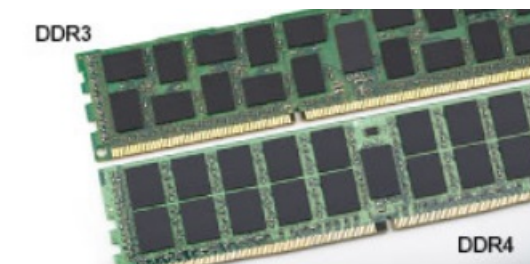

Figure 1. Notch difference

Increased thickness

DDR4 modules are slightly thicker than DDR3, to accommodate more signal layers.

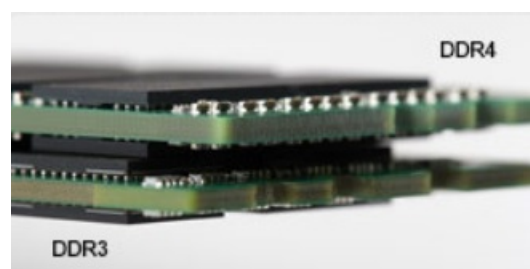

Figure 2. Thickness difference

Curved edge

DDR4 modules feature a curved edge to help with insertion and alleviate stress on the PCB during memory installation.

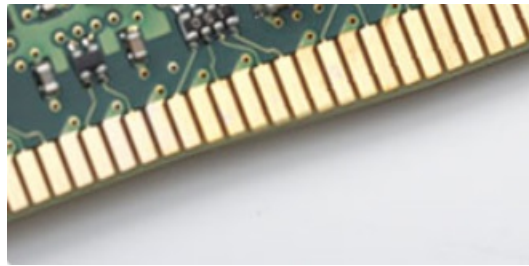

Figure 3. Curved edge

Memory Errors

Memory errors on the system display the new ON-FLASH-FLASH or ON-FLASH-ON failure code. If all memory fails, the LCD does not turn on. Troubleshoot for possible memory failure by trying known good memory modules in the memory connectors on the bottom of the system or under the keyboard, as in some portable systems.

NOTE: The DDR4 memory is imbedded in board and not a replaceable DIMM as shown and referred.

HDMI 1.4

This topic explains the HDMI 1.4 and its features along with the advantages.

HDMI (High-Definition Multimedia Interface) is an industry-supported, uncompressed, all-digital audio/video interface. HDMI provides an interface between any compatible digital audio/video source, such as a DVD player, or A/V receiver and a compatible digital audio and/or video monitor, such as a digital TV (DTV). The intended applications for HDMI TVs, and DVD players. The primary advantage is cable reduction and content protection provisions. HDMI supports standard, enhanced, or high-definition video, plus multichannel digital audio on a single cable.

NOTE: The HDMI 1.4 will provide 5.1 channel audio support.

HDMI 1.4 Features

- **HDMI Ethernet Channel** - Adds high-speed networking to an HDMI link, allowing users to take full advantage of their IP-enabled devices without a separate Ethernet cable
- **Audio Return Channel** - Allows an HDMI-connected TV with a built-in tuner to send audio data "upstream" to a surround audio system, eliminating the need for a separate audio cable
- **3D** - Defines input/output protocols for major 3D video formats, paving the way for true 3D gaming and 3D home theater applications
- **Content Type** - Real-time signaling of content types between display and source devices, enabling a TV to optimize picture settings based on content type
- **Additional Color Spaces** - Adds support for additional color models used in digital photography and computer graphics
- **4K Support** - Enables video resolutions far beyond 1080p, supporting next-generation displays that will rival the Digital Cinema systems used in many commercial movie theaters
- **HDMI Micro Connector** - A new, smaller connector for phones and other portable devices, supporting video resolutions up to 1080p
- **Automotive Connection System** - New cables and connectors for automotive video systems, designed to meet the unique demands of the motoring environment while delivering true HD quality

Advantages of HDMI

- Quality HDMI transfers uncompressed digital audio and video for the highest, crispest image quality.
- Low -cost HDMI provides the quality and functionality of a digital interface while also supporting uncompressed video formats in a simple, cost-effective manner
- Audio HDMI supports multiple audio formats from standard stereo to multichannel surround sound
- HDMI combines video and multichannel audio into a single cable, eliminating the cost, complexity, and confusion of multiple cables currently used in A/V systems

- HDMI supports communication between the video source (such as a DVD player) and the DTV, enabling new functionality

USB features

Universal Serial Bus, or USB, was introduced in 1996. It dramatically simplified the connection between host computers and peripheral devices like mice, keyboards, external drives, and printers.

Let's take a quick look on the USB evolution referencing to the table below.

Table 1. USB evolution

Type	Data Transfer Rate	Category	Introduction Year
USB 2.0	480 Mbps	High Speed	2000
USB 3.0/USB 3.1 Gen 1	5 Gbps	Super Speed	2010
USB 3.1 Gen 2	10 Gbps	Super Speed	2013

USB 3.0/USB 3.1 Gen 1 (SuperSpeed USB)

For years, the USB 2.0 has been firmly entrenched as the de facto interface standard in the PC world with about 6 billion devices sold, and yet the need for more speed grows by ever faster computing hardware and ever greater bandwidth demands. The USB 3.0/USB 3.1 Gen 1 finally has the answer to the consumers' demands with a theoretically 10 times faster than its predecessor. In a nutshell, USB 3.1 Gen 1 features are as follows:

- Higher transfer rates (up to 5 Gbps)
- Increased maximum bus power and increased device current draw to better accommodate power-hungry devices
- New power management features
- Full-duplex data transfers and support for new transfer types
- Backward USB 2.0 compatibility
- New connectors and cable

The topics below cover some of the most commonly asked questions regarding USB 3.0/USB 3.1 Gen 1.



Speed

Currently, there are 3 speed modes defined by the latest USB 3.0/USB 3.1 Gen 1 specification. They are Super-Speed, Hi-Speed and Full-Speed. The new SuperSpeed mode has a transfer rate of 4.8Gbps. While the specification retains Hi-Speed, and Full-Speed USB mode, commonly known as USB 2.0 and 1.1 respectively, the slower modes still operate at 480Mbps and 12Mbps respectively and are kept to maintain backward compatibility.

USB 3.0/USB 3.1 Gen 1 achieves the much higher performance by the technical changes below:

- An additional physical bus that is added in parallel with the existing USB 2.0 bus (refer to the picture below).
- USB 2.0 previously had four wires (power, ground, and a pair for differential data); USB 3.0/USB 3.1 Gen 1 adds four more for two pairs of differential signals (receive and transmit) for a combined total of eight connections in the connectors and cabling.
- USB 3.0/USB 3.1 Gen 1 utilizes the bidirectional data interface, rather than USB 2.0's half-duplex arrangement. This gives a 10-fold increase in theoretical bandwidth.

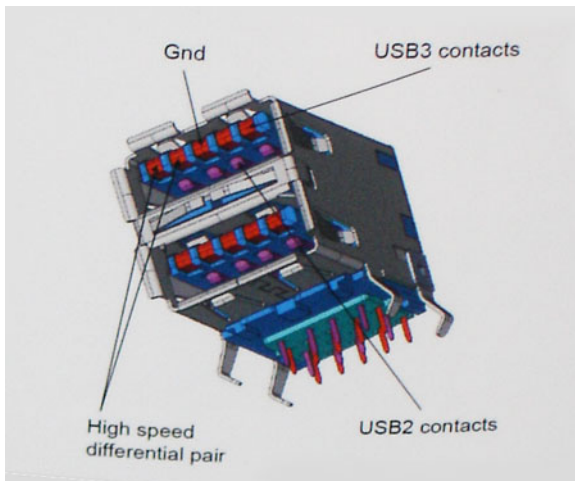

With today's ever increasing demands placed on data transfers with high-definition video content, terabyte storage devices, high megapixel count digital cameras etc., USB 2.0 may not be fast enough. Furthermore, no USB 2.0 connection could ever come close to the 480Mbps theoretical maximum throughput, making data transfer at around 320Mbps (40MB/s) — the actual real-world maximum. Similarly, USB 3.0/USB 3.1 Gen 1 connections will never achieve 4.8Gbps. We will likely see a real-world maximum rate of 400MB/s with overheads. At this speed, USB 3.0/USB 3.1 Gen 1 is a 10x improvement over USB 2.0.

Applications

USB 3.0/USB 3.1 Gen 1 opens up the laneways and provides more headroom for devices to deliver a better overall experience. Where USB video was barely tolerable previously (both from a maximum resolution, latency, and video compression perspective), it's easy to imagine that with 5-10 times the bandwidth available, USB video solutions should work that much better. Single-link DVI requires almost 2Gbps throughput. Where 480Mbps was limiting, 5Gbps is more than promising. With its promised 4.8Gbps speed, the standard will find its way into some products that previously weren't USB territory, like external RAID storage systems.

Listed below are some of the available SuperSpeed USB 3.0/USB 3.1 Gen 1 products:

- External Desktop USB 3.0/USB 3.1 Gen 1 Hard Drives
- Portable USB 3.0/USB 3.1 Gen 1 Hard Drives
- USB 3.0/USB 3.1 Gen 1 Drive Docks & Adapters
- USB 3.0/USB 3.1 Gen 1 Flash Drives & Readers
- USB 3.0/USB 3.1 Gen 1 Solid-state Drives
- USB 3.0/USB 3.1 Gen 1 RAIDs
- Optical Media Drives
- Multimedia Devices
- Networking
- USB 3.0/USB 3.1 Gen 1 Adapter Cards & Hubs

Compatibility

The good news is that USB 3.0/USB 3.1 Gen 1 has been carefully planned from the start to peacefully co-exist with USB 2.0. First of all, while USB 3.0/USB 3.1 Gen 1 specifies new physical connections and thus new cables to take advantage of the higher speed capability of the new protocol, the connector itself remains the same rectangular shape with the four USB 2.0 contacts in the exact same location as before. Five new connections to carry receive and transmitted data independently are present on USB 3.0/USB 3.1 Gen 1 cables and only come into contact when connected to a proper SuperSpeed USB connection.

Windows 10 will be bringing native support for USB 3.1 Gen 1 controllers. This is in contrast to previous versions of Windows, which continue to require separate drivers for USB 3.0/USB 3.1 Gen 1 controllers.

Intel Optane memory

Intel Optane memory functions only as a storage accelerator. It neither replaces nor adds to the memory (RAM) installed on your computer.

NOTE: Intel Optane memory is supported on computers that meet the following requirements:

- **7th Generation or higher Intel Core i3/i5/i7 processor**
- **Windows 10 64-bit version 1607 or higher**
- **Intel Rapid Storage Technology driver version 15.9.1.1018 or higher**

Table 2. Intel Optane memory specifications

Feature	Specifications
Interface	PCIe 3x2 NVMe 1.1
Connector	M.2 card slot (2230/2280)
Configurations supported	<ul style="list-style-type: none"> • 7th Generation or higher Intel Core i3/i5/i7 processor • Windows 10 64-bit version 1607 or higher • Intel Rapid Storage Technology driver version 15.9.1.1018 or higher
Capacity	16 GB

Enabling Intel Optane memory

Steps

1. On the taskbar, click the search box, and type "**Intel Rapid Storage Technology**".
2. Click **Intel Rapid Storage Technology**.
3. On the **Status** tab, click **Enable** to enable the Intel Optane memory.
4. On the warning screen, select a compatible fast drive, and then click **Yes** to continue enabling Intel Optane memory.
5. Click **Intel Optane memory > Reboot** to enable the Intel Optane memory.

 **NOTE:** Applications may take up to three subsequent launches after enablement to see the full performance benefits.

Disabling Intel Optane memory

About this task

 **CAUTION:** After disabling Intel Optane memory, do not uninstall the driver for Intel Rapid Storage Technology as it will result in a blue screen error. The Intel Rapid Storage Technology user interface can be removed without uninstalling the driver.

 **NOTE:** Disabling Intel Optane memory is required before removing the SATA storage device, accelerated by the Intel Optane memory module, from the computer.

Steps

1. On the taskbar, click the search box, and then type "**Intel Rapid Storage Technology**".
2. Click **Intel Rapid Storage Technology**. The **Intel Rapid Storage Technology** window is displayed.
3. On the **Intel Optane memory** tab, click **Disable** to disable the Intel Optane memory.
4. Click **Yes** if you accept the warning. The disabling progress is displayed.
5. Click **Reboot** to complete disabling Intel Optane memory and restart your computer.

Removing and installing components

Recommended tools

The procedures in this document require the following tools:









- Phillips #0 screwdriver
- Phillips #1 screwdriver
- Plastic scribe

NOTE: The #0 screw driver is for screws 0-1 and the #1 screw driver is for screws 2-4.













Screw list

The table provides the list of screws that are used for securing different components.

Table 3. Screw list

Component	Screw type	Quantity	Screw image
Optical-drive assembly	M2x3		
Optical-drive bracket	M2x3	2	
Optical-drive connector board	M2x2 Big Head	1	
Base cover	M2.5x7	6	
	M2x4	1	
	M2x2	2	
Battery	M2x3	4	
			
Solid-state drive to thermal plate	M2x2 Big Head	1	
Solid-state drive	M2x0.8x2.2	1	
Hard-drive assembly	M2x3	4	
Hard-drive bracket	M3x3	4	
System Fan	M2.5x5	3	

NOTE: Screw color may vary depending on the configuration ordered.

Component	Screw type	Quantity	Screw image
Heat sink	M2x3	3	
VGA daughterboard	M2x3	2	
I/O board	M2x4	1	
Touchpad	M2x2	4	
Touch pad bracket	M2x2	2	
Power-button board	M2x2 Big Head	1	
System board	M2x4	1	
Power button with fingerprint reader (optional)	M2x2 Big Head	1	
Power-adaptor port	M2x3	1	
Display panel	M2x2	4	
Hinges	M2.5x2.5	8	
	M2x2	2	
Wireless-card bracket	M2x3	1	

Micro Secure Digital Card

Removing the Micro Secure Digital card

Prerequisites

1. Follow the procedure in [Before working inside your computer](#)

Steps

1. Push the micro secure digital card to release it from the computer.
2. Slide the micro secure digital card out of the computer.



Installing the Micro Secure Digital card

Steps

1. Slide the micro secure digital into the slot until it clicks into place.
2. Follow the procedures in [After working inside your computer](#).



Optical drive assembly

Removing the optical drive assembly

Prerequisites

1. Follow the procedure in [before working inside your computer](#)
2. Remove the [SD memory card](#)

Steps

1. Remove the single (M2x4) screw that secures the optical drive to the system [1].
2. Slide the optical drive out of the computer [2].



3. Remove the two (M2x3) screws that secure the optical drive bracket to the optical drive [1].
4. Remove the optical drive bracket from the optical drive [2].

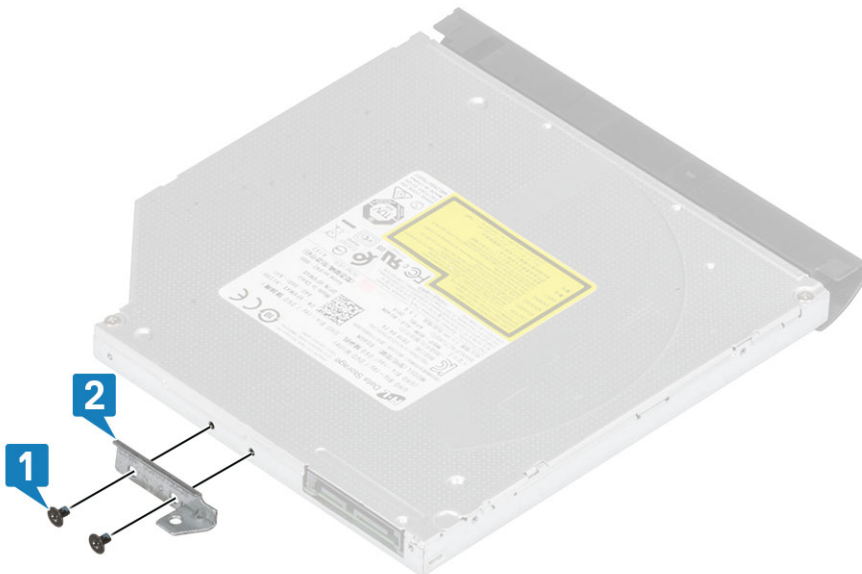

Installing the optical drive assembly

Steps

1. Align the optical drive bracket to the screw holes on the optical drive [1].
2. Replace the two (M2x3) screws that secure the optical drive bracket to the optical drive [2].

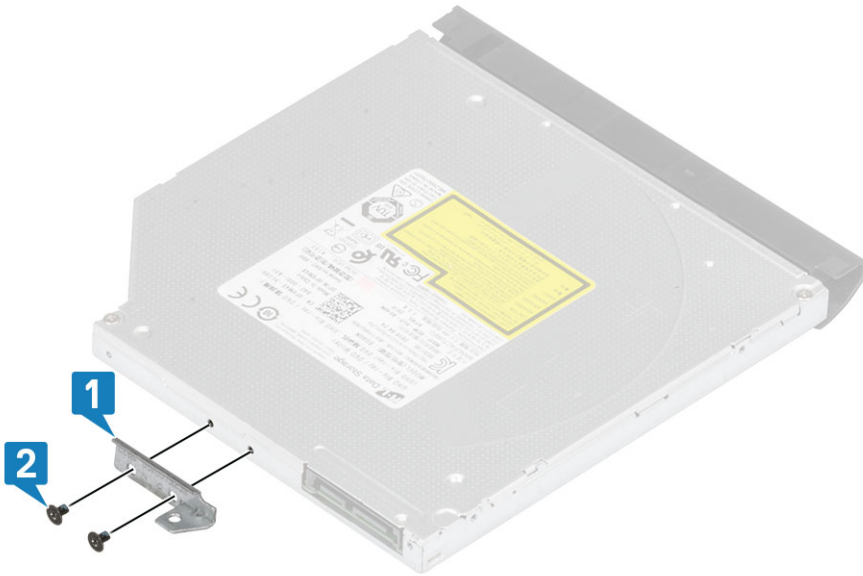

3. Insert the optical drive into the slot until it clicks into place [1].
4. Replace the single (M2x4) screw that secures the optical drive to the system [2].



Next steps

1. Replace the [SD memory card](#)
2. Follow the procedure in [after working inside your computer](#)

Base cover

Removing the base cover

Prerequisites

1. Follow the procedure in [before working inside your computer](#)
2. Remove the [SD memory card](#)
3. Remove the [optical drive assembly](#)

Steps

1. Loosen the three captive screws [1].
2. Remove the single (M2x4) screw, two (M2x2) screws, and six (M2.5x7) screws that secure the base cover to the palmrest and keyboard assembly [2, 3, 4].



3. Pry the base cover from the top-right corner [1] and continue to open the right side of the base cover [2].
4. Lift the left side of the base cover and remove it off the system [3].

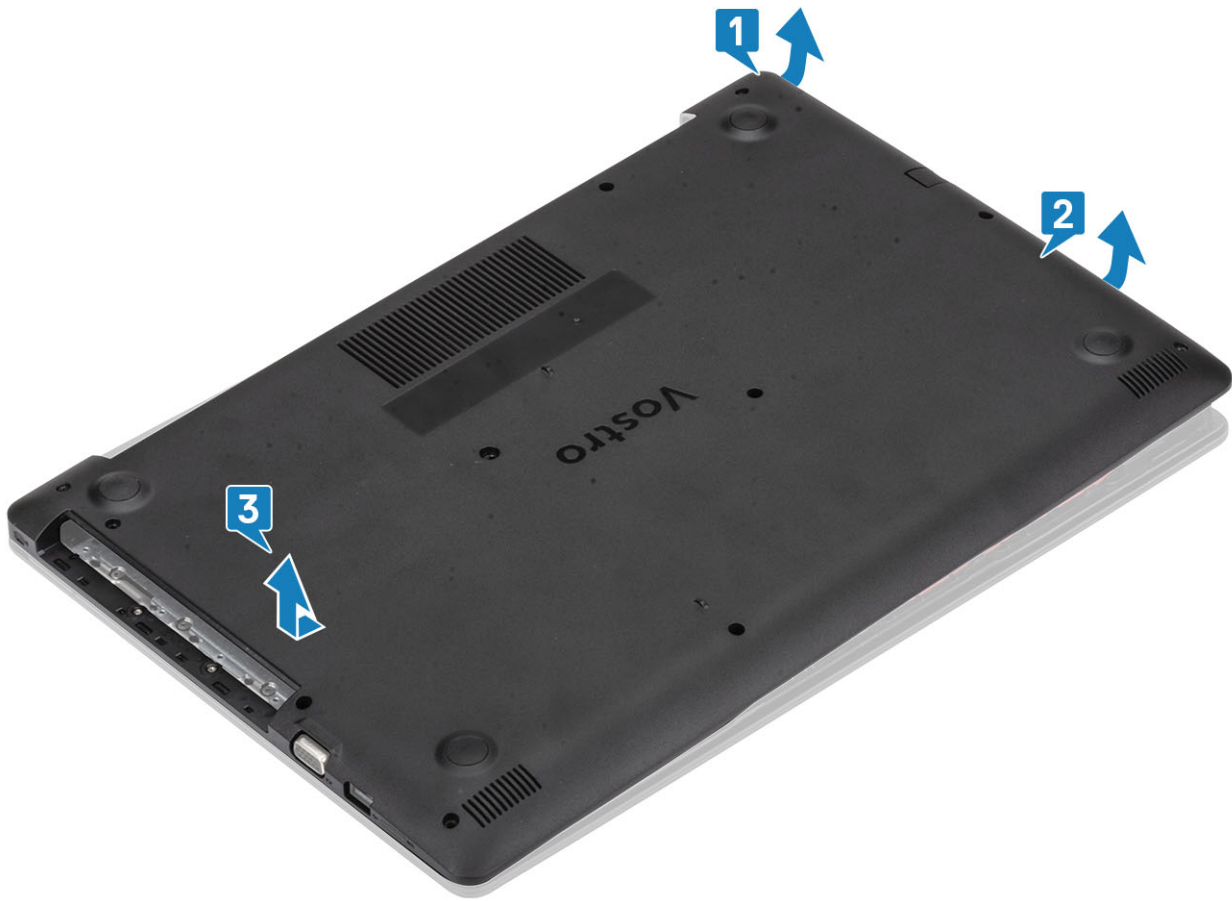

Installing the base cover

Steps

1. Place the base cover on the palmrest and keyboard assembly [1].
2. Press the right side of the base cover until it snaps into place [2, 3].

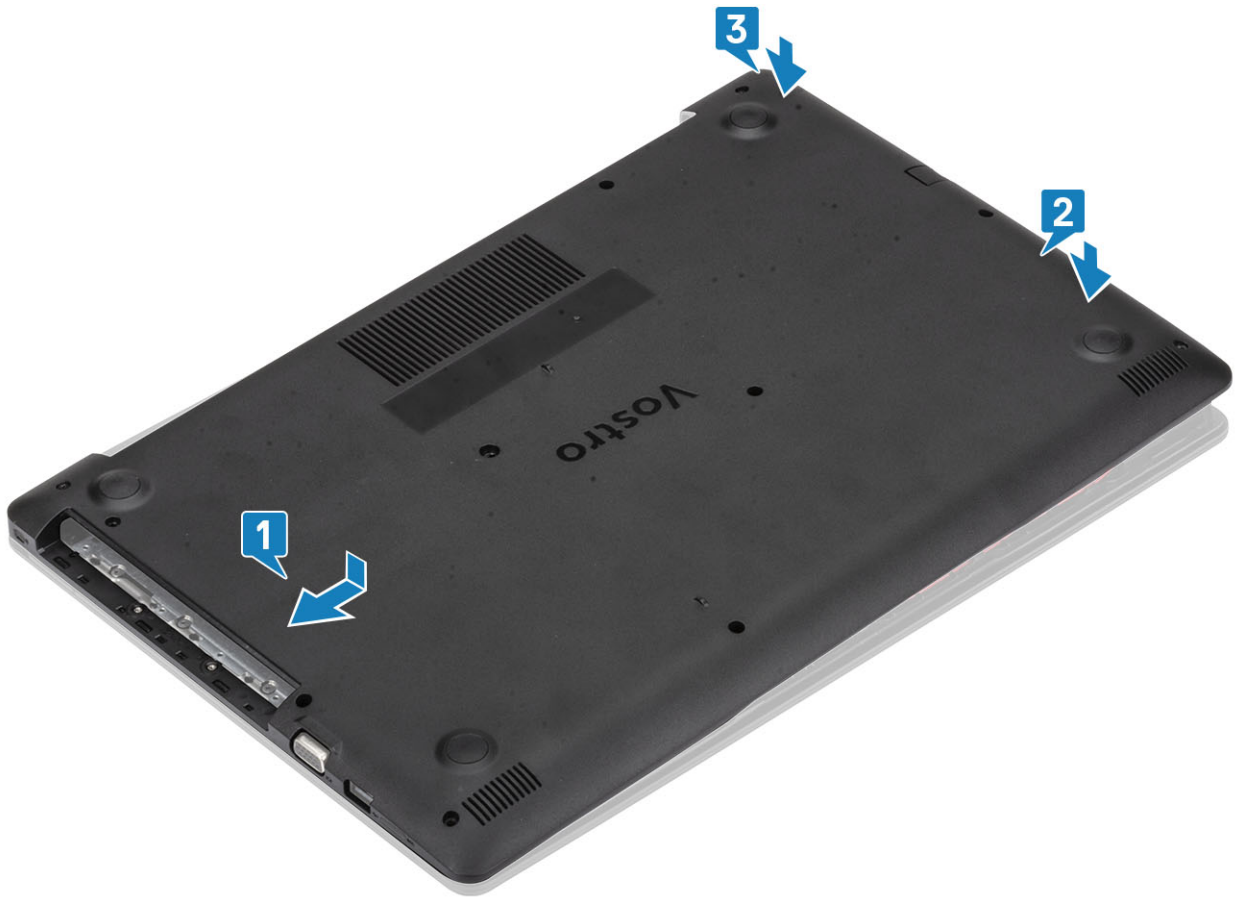

3. Tighten the three captive screws, and replace the single (M2x4) screw that secures the base cover to the palmrest and keyboard assembly [1, 2].
4. Replace the two (M2x2) screws, and six (M2.5x7) screws that secure the base cover to the palmrest and keyboard assembly [3, 4].



Next steps

1. Replace the [optical drive assembly](#)
2. Replace the [SD memory card](#)
3. Follow the procedure in [after working inside your computer](#)

Memory modules

Removing the memory module

Prerequisites

1. Follow the procedure in [before working inside your computer](#)
2. Remove the [SD memory card](#)
3. Remove the [optical drive assembly](#)
4. Remove the [base cover](#)
5. Disconnect the [battery](#) cable from the connector on the system board.

Steps

1. Pry the clips securing the memory module until the memory module pops-up [1].
2. Remove the memory module from the memory module slot [2].

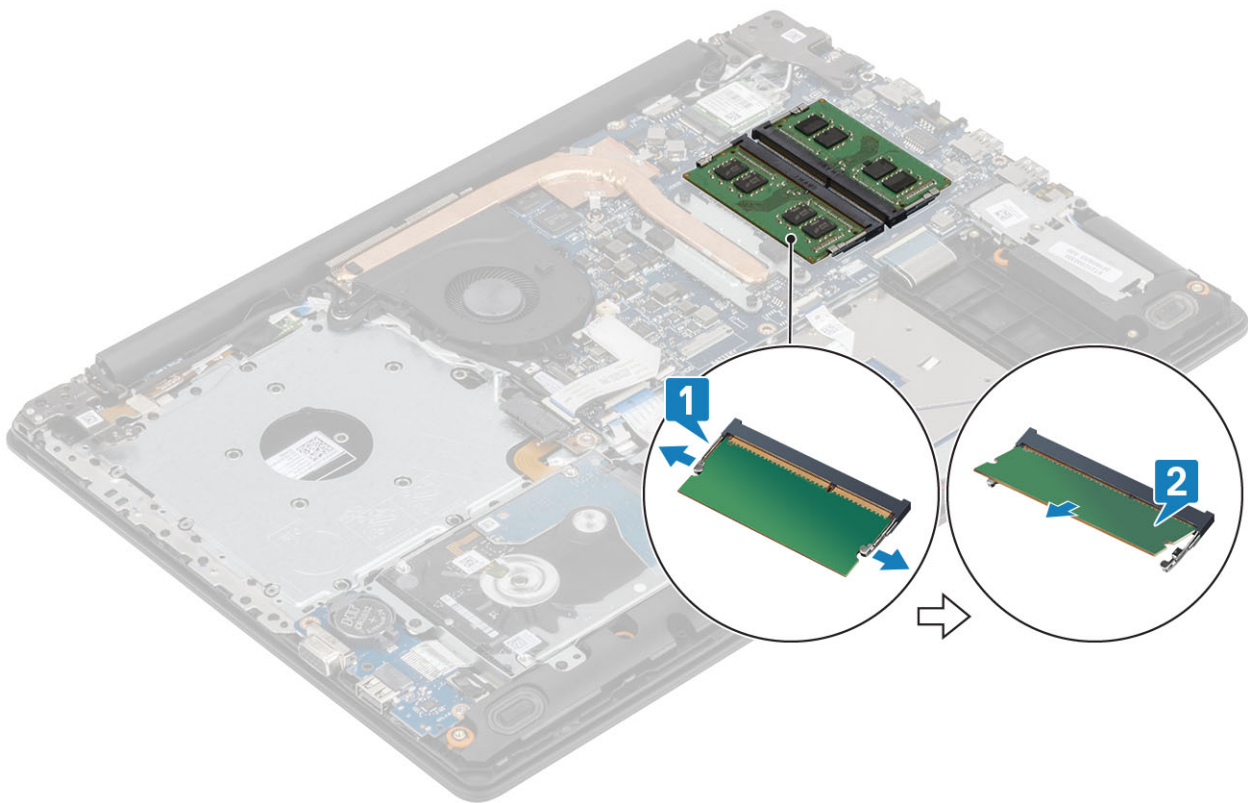

Installing the memory module

Steps

1. Align the notch on the memory module with the tab on the memory-module slot.
2. Slide the memory module firmly into the slot at an angle [1].
3. Press the memory module down until the clips secure it [2].

NOTE: If you do not hear the click, remove the memory module and reinstall it.

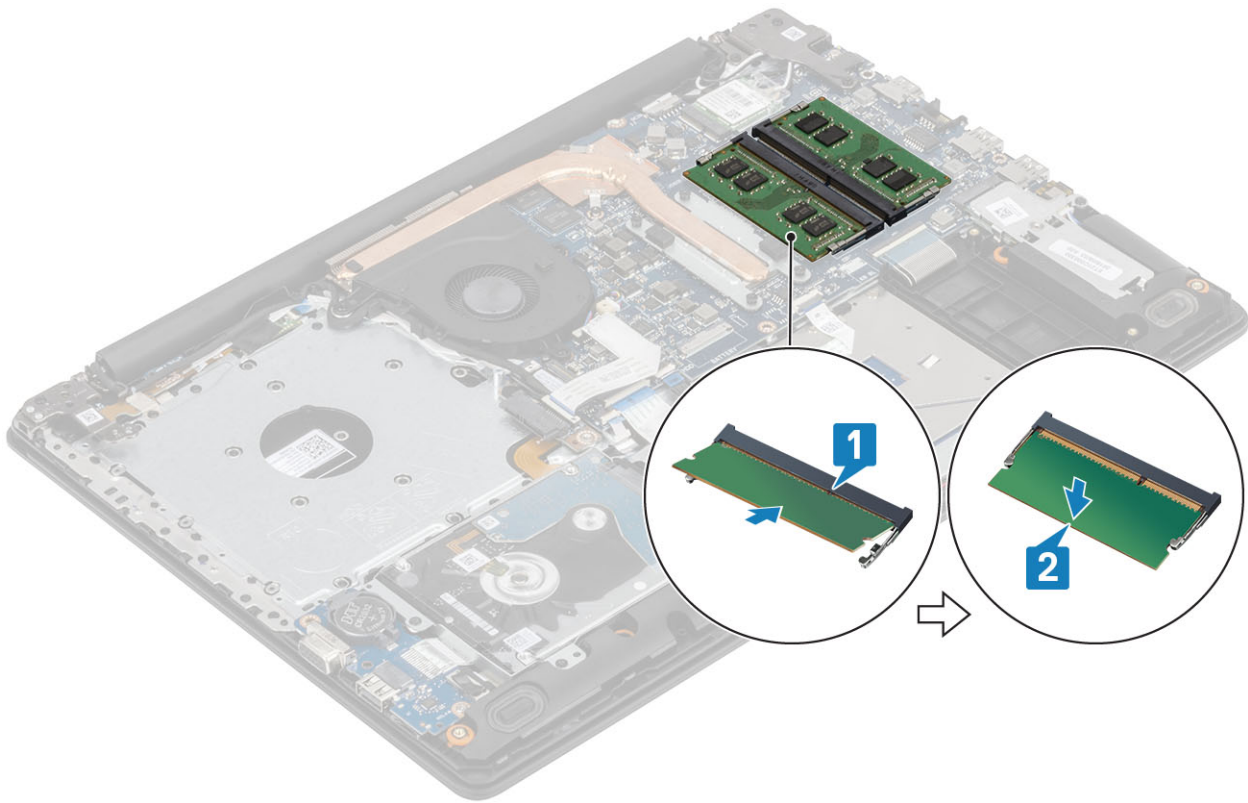

Next steps

1. Connect the [battery](#) cable to the connector on the system board.
2. Replace the [base cover](#)
3. Replace the [optical drive assembly](#)
4. Replace the [SD memory card](#)
5. Follow the procedure in [after working inside your computer](#)

WLAN card

Removing the WLAN card

Prerequisites

1. Follow the procedure in [before working inside your computer](#)
2. Remove the [SD memory card](#)
3. Remove the [optical drive assembly](#)
4. Remove the [base cover](#)
5. Disconnect the [battery](#) cable from the connector on the system board.

Steps

1. Remove the single (M2x3) screw that secures the WLAN card bracket to the system board [1].
2. Slide and remove the WLAN card bracket that secures the WLAN cables [2].
3. Disconnect the WLAN cables from the connectors on the WLAN card [3].
4. Lift the WLAN card away from the connector [4].

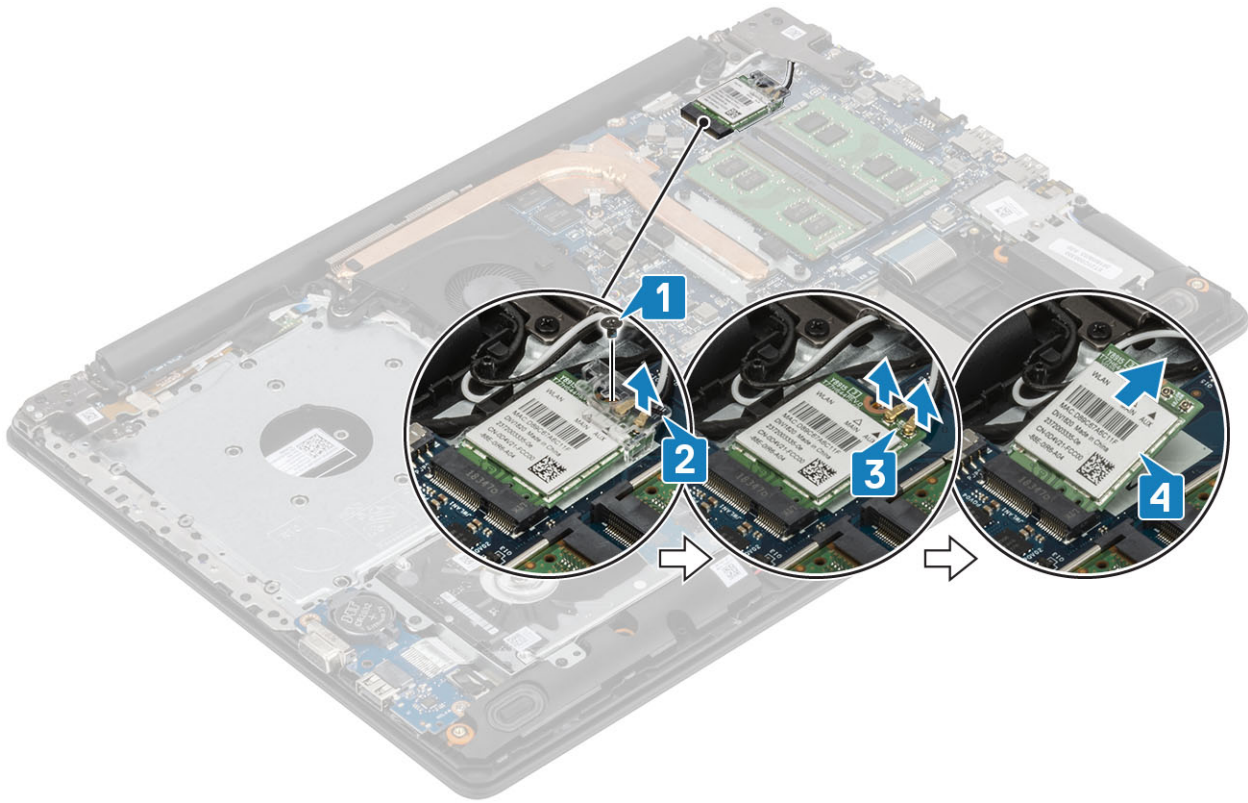

Installing the WLAN card

About this task

CAUTION: To avoid damage to the WLAN card, do not place any cables under it.

Steps

1. Insert the WLAN card into the connector on the system board [1].
2. Connect the WLAN cables to the connectors on the WLAN card [2].
3. Place the WLAN card bracket to secure the WLAN cables to the WLAN card [3].
4. Replace the single (M2x3) screw to secure the WLAN bracket to the WLAN card [4].

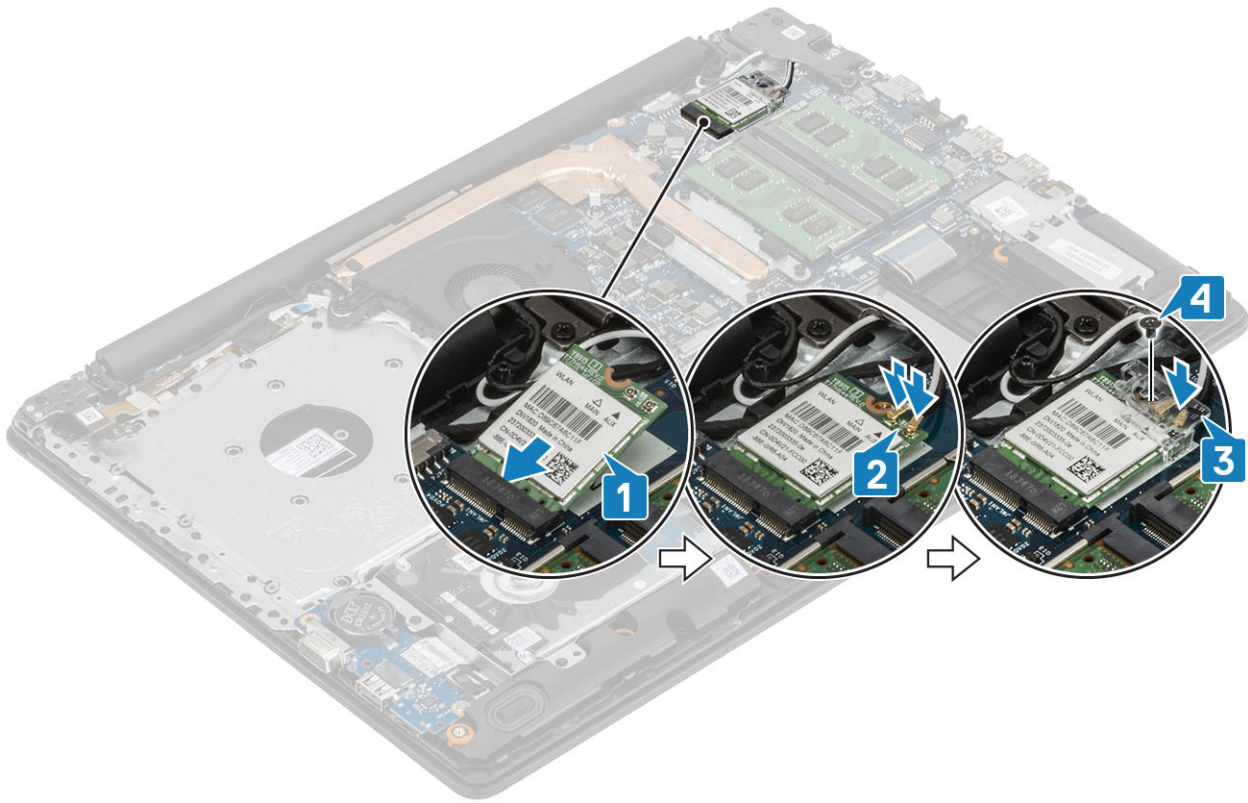

Next steps

1. Connect the [battery](#) cable to the connector on the system board.
2. Replace the [base cover](#)
3. Replace the [optical drive assembly](#)
4. Replace the [SD memory card](#)
5. Follow the procedure in [after working inside your computer](#)

Solid-state drive/Intel Optane

Removing the M.2 2230 Solid-state drive

Prerequisites

1. Follow the procedure in [before working inside your computer](#)
2. Remove the [SD memory card](#)
3. Remove the [optical drive assembly](#)
4. Remove the [base cover](#)
5. Disconnect the [battery](#) cable from the connector on the system board.

Steps

1. Loosen the captive screw that secures the thermal plate to the palmrest and keyboard assembly [1].
2. Remove the single (M2x3) screw that secures the thermal plate to the palmrest and keyboard assembly [2].
3. Slide and remove the thermal plate from the solid-state drive slot [3].

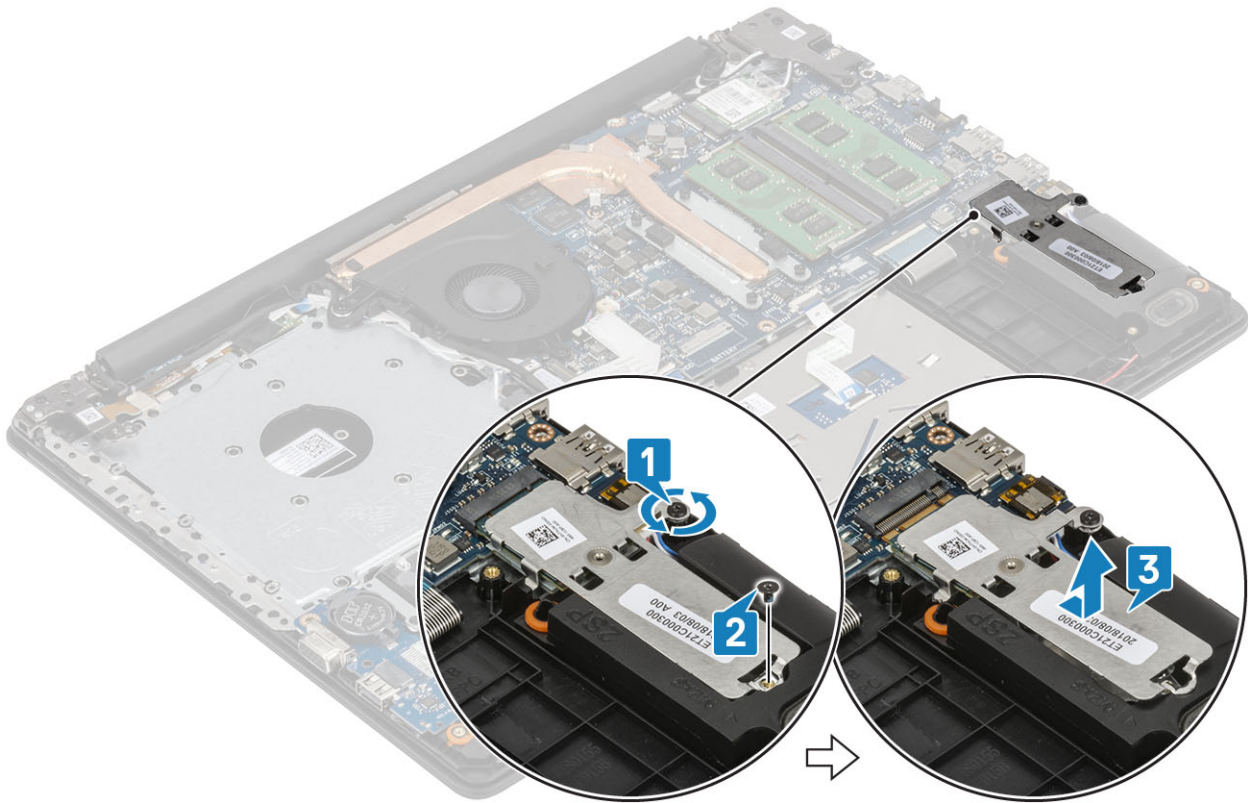

4. Turn the thermal plate over.
5. Remove the single (M2x2) screw that secures the solid-state drive to the thermal plate [1].
6. Lift the solid-state drive off the thermal plate [2].

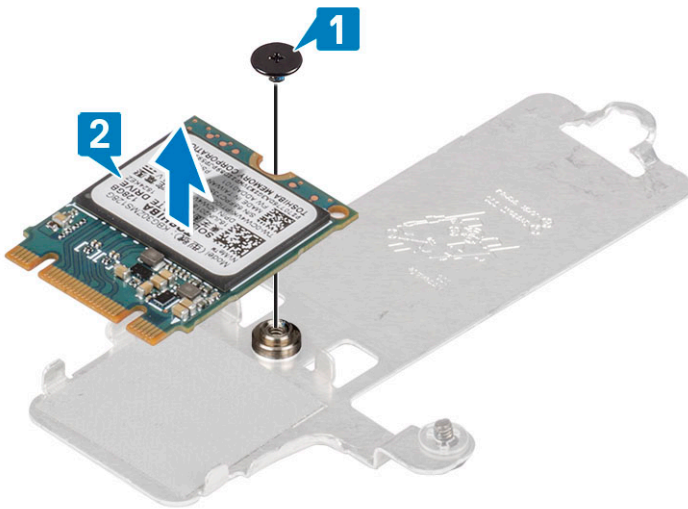

Installing the M.2 2230 Solid-state drive

Steps

1. Place the solid-state drive into the thermal plate slot [1].
2. Replace the single (M2x2) screw that secures the solid-state drive to the thermal plate [2].

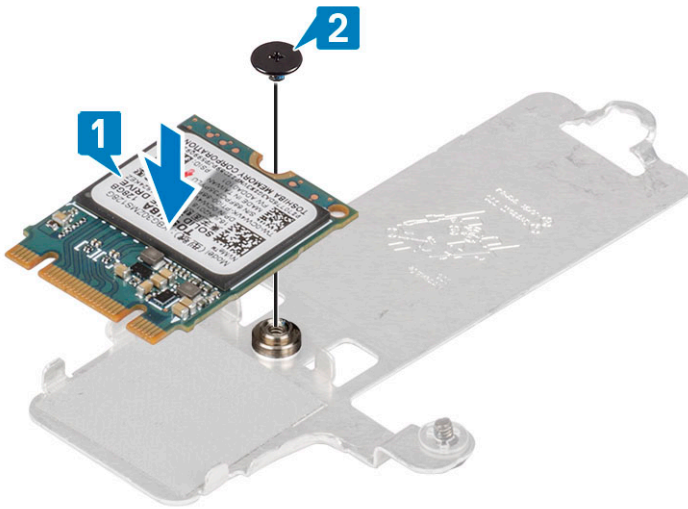

3. Align the notch on the solid-state drive with the tab on the solid-state drive slot.
4. Slide and insert the tab of the solid-state drive into the solid-state drive slot [1].
5. Tighten the captive screw that secures the thermal plate to the palmrest and keyboard assembly [2].
6. Replace the single (M2x3) screw that secures the thermal plate to the palmrest and keyboard assembly [3].

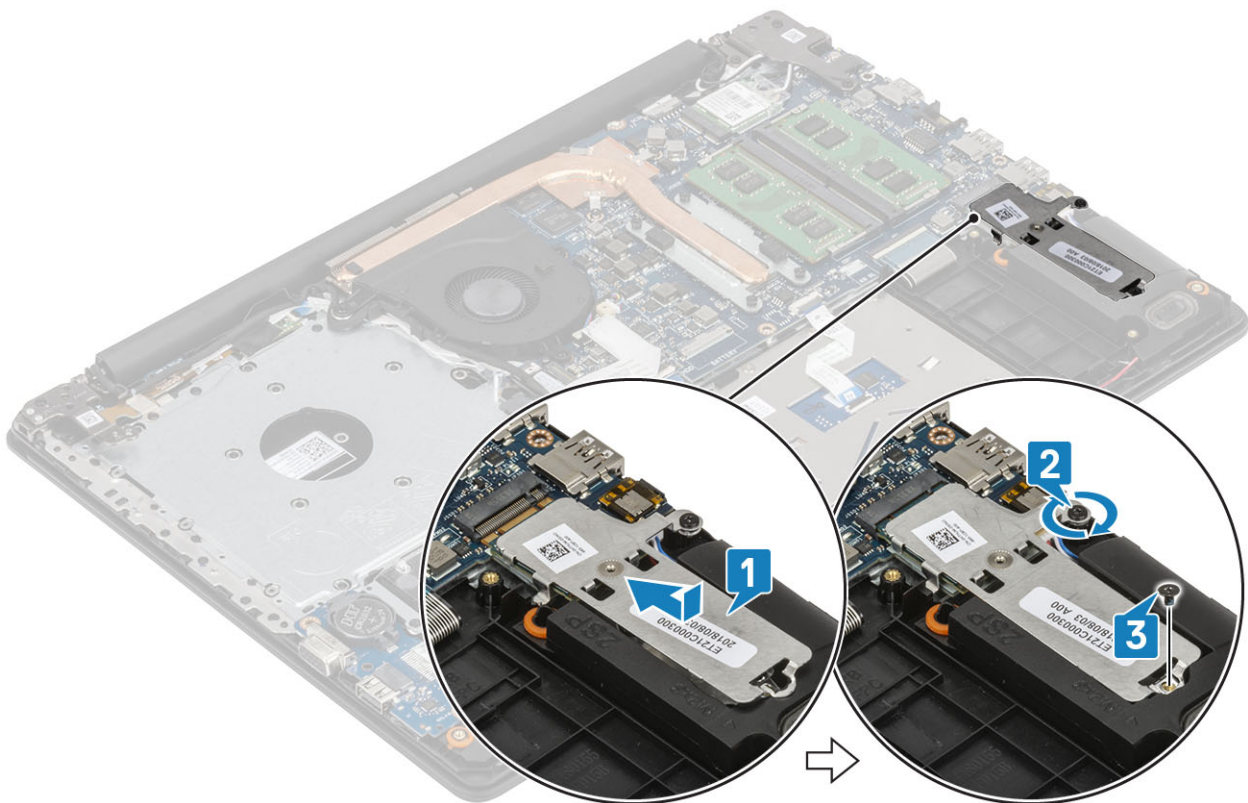

Next steps

1. Connect the [battery](#) cable to the connector on the system board.
2. Replace the [base cover](#)
3. Replace the [optical drive assembly](#)
4. Replace the [SD memory card](#)
5. Follow the procedure in [after working inside your computer](#)

Removing the M.2 2280 Solid-state drive or Intel Optane memory - Optional

Prerequisites

1. Follow the procedure in [before working inside your computer](#)
2. Remove the [SD memory card](#)
3. Remove the [optical drive assembly](#)
4. Remove the [base cover](#)
5. Disconnect the [battery](#) cable from the connector on the system board.

Steps

1. Loosen the captive screw that secures the thermal plate to the palmrest and keyboard assembly [1].
2. Remove the single (M2x3) screw that secures the thermal plate to the palmrest and keyboard assembly [2].
3. Slide and remove the thermal plate from the solid-state drive/Intel Optane slot [3].
4. Slide and lift the solid-state drive/Intel Optane off the palmrest and keyboard assembly [4].

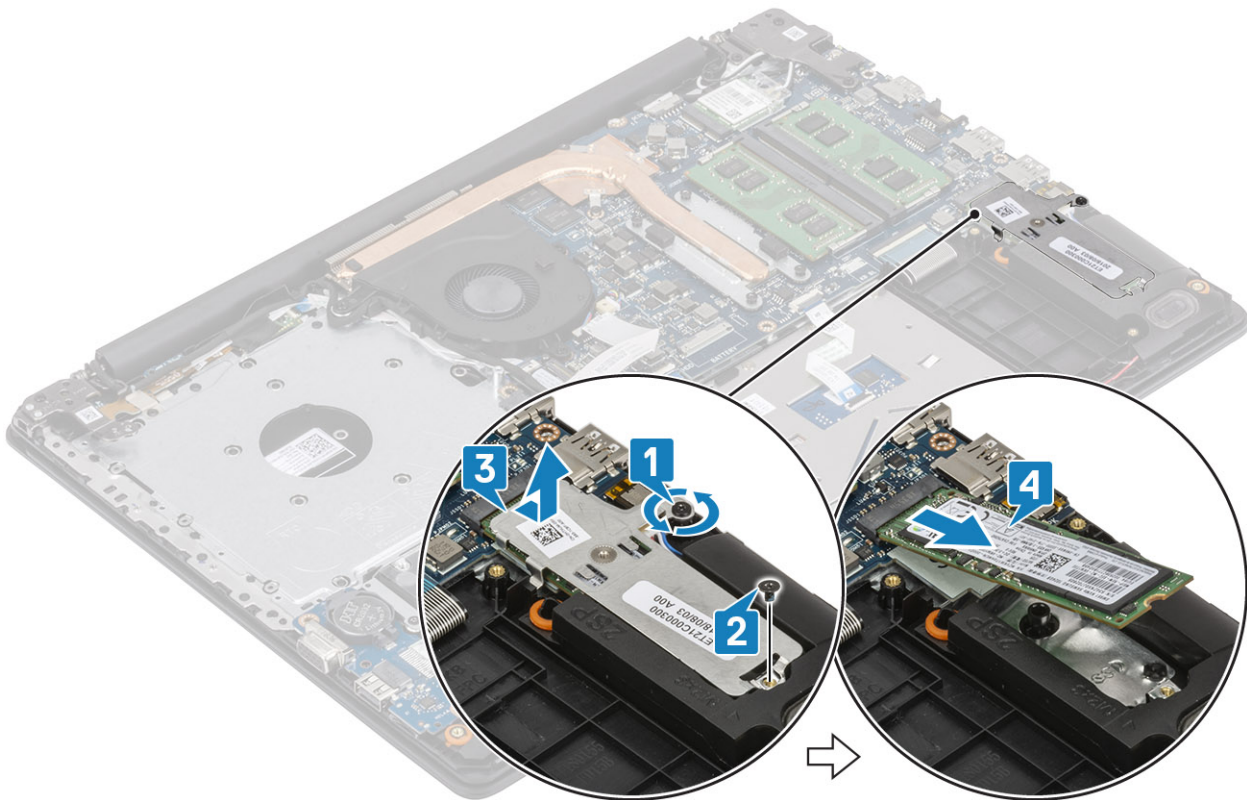

Installing the M.2 2280 Solid-state drive or Intel Optane memory - Optional

Steps

1. Slide and insert the tab of the solid-state drive/Intel Optane into the solid-state drive/Intel Optane slot [1, 2].
2. Align the thermal plate on the solid-state drive and tighten the captive screw that secures the thermal plate to the palmrest and keyboard assembly [3].
3. Replace the single (M2x3) screw that secures the thermal plate to the palmrest and keyboard assembly [4].

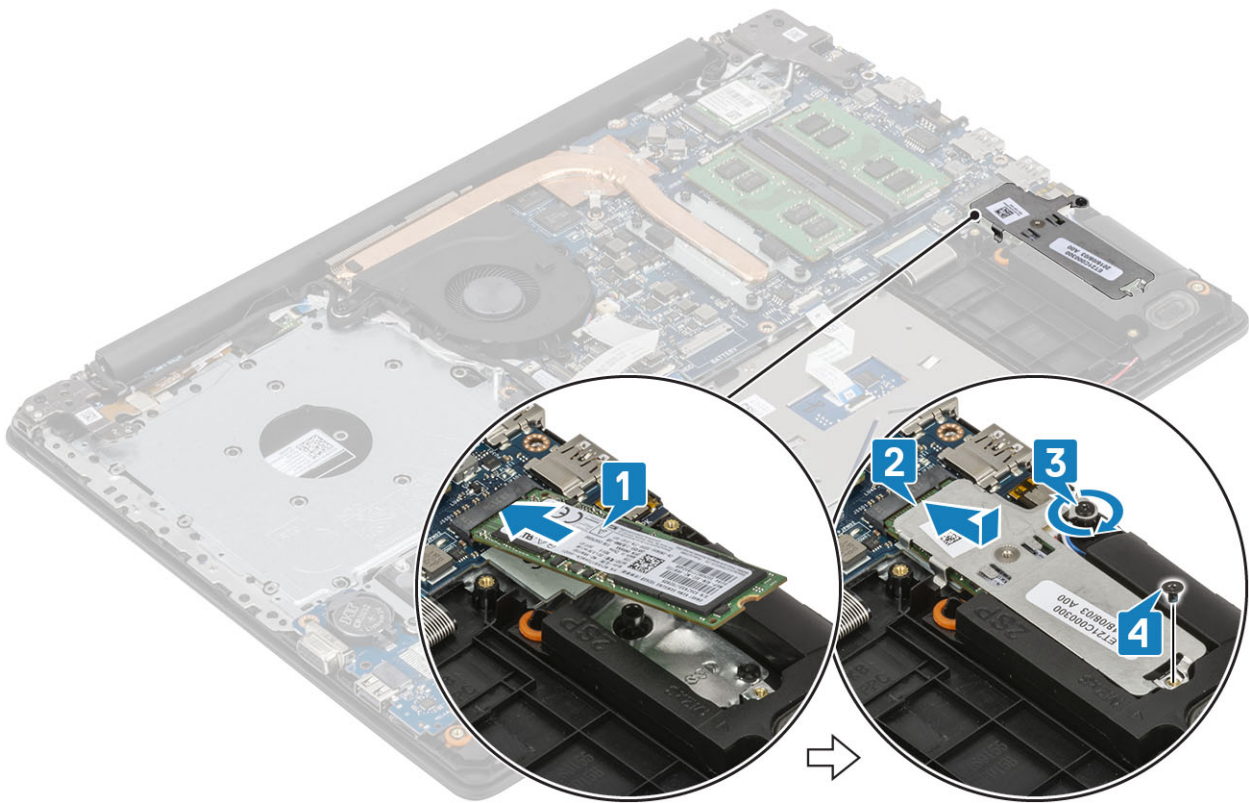

Next steps

1. Connect the [battery](#) cable to the connector on the system board.
2. Replace the [base cover](#)
3. Replace the [optical drive assembly](#)
4. Replace the [SD memory card](#)
5. Follow the procedure in [after working inside your computer](#)

Coin-cell battery

Removing the coin-cell

Prerequisites

1. Follow the procedure in [before working inside your computer](#)
2. Remove the [SD memory card](#)
3. Remove the [optical drive assembly](#)
4. Remove the [base cover](#)
5. Disconnect the [battery](#) cable from the connector on the system board.

Steps

1. Using a plastic scribe, gently pry the coin-cell battery out of the slot on the I/O board [1].
2. Remove the coin-cell battery away from the system [2].

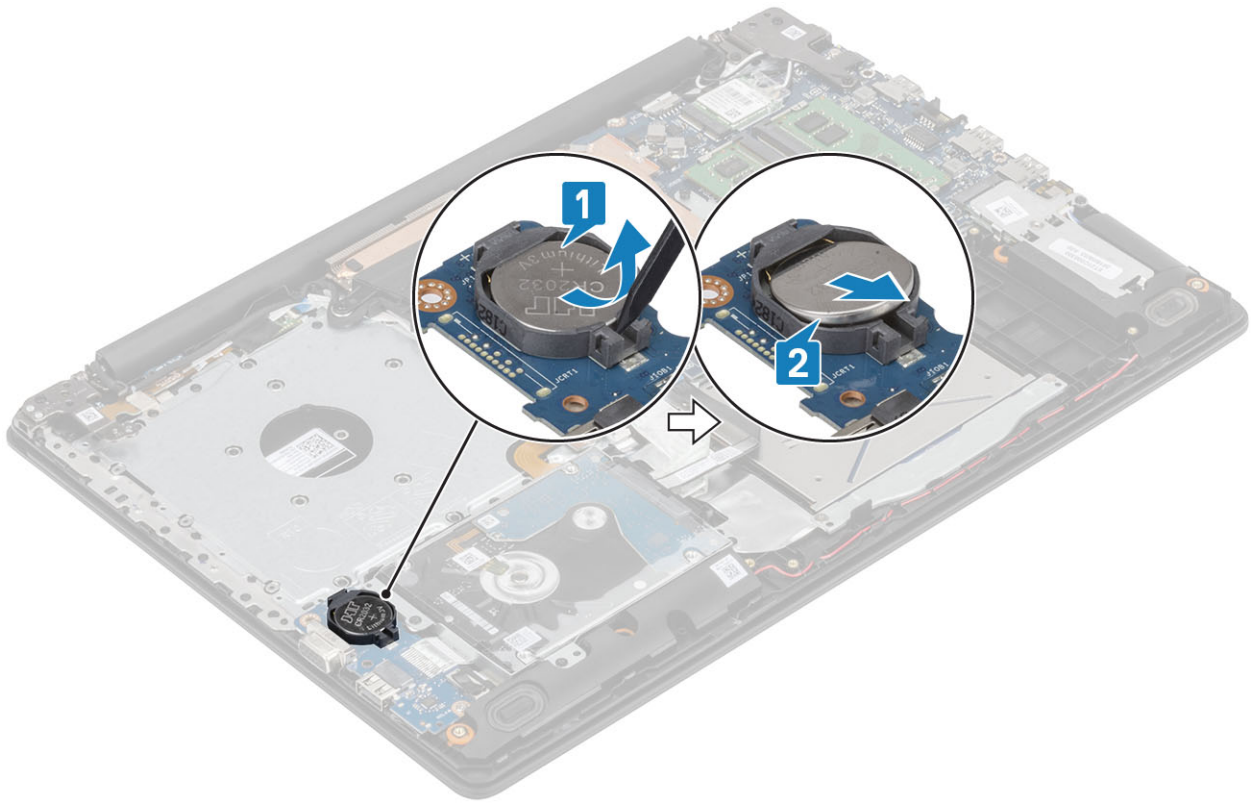

Installing the coin-cell battery

Steps

1. With the positive-side facing up, insert the coin-cell battery into the battery socket on the I/O board [1].
2. Press the battery until it clicks into place [2].

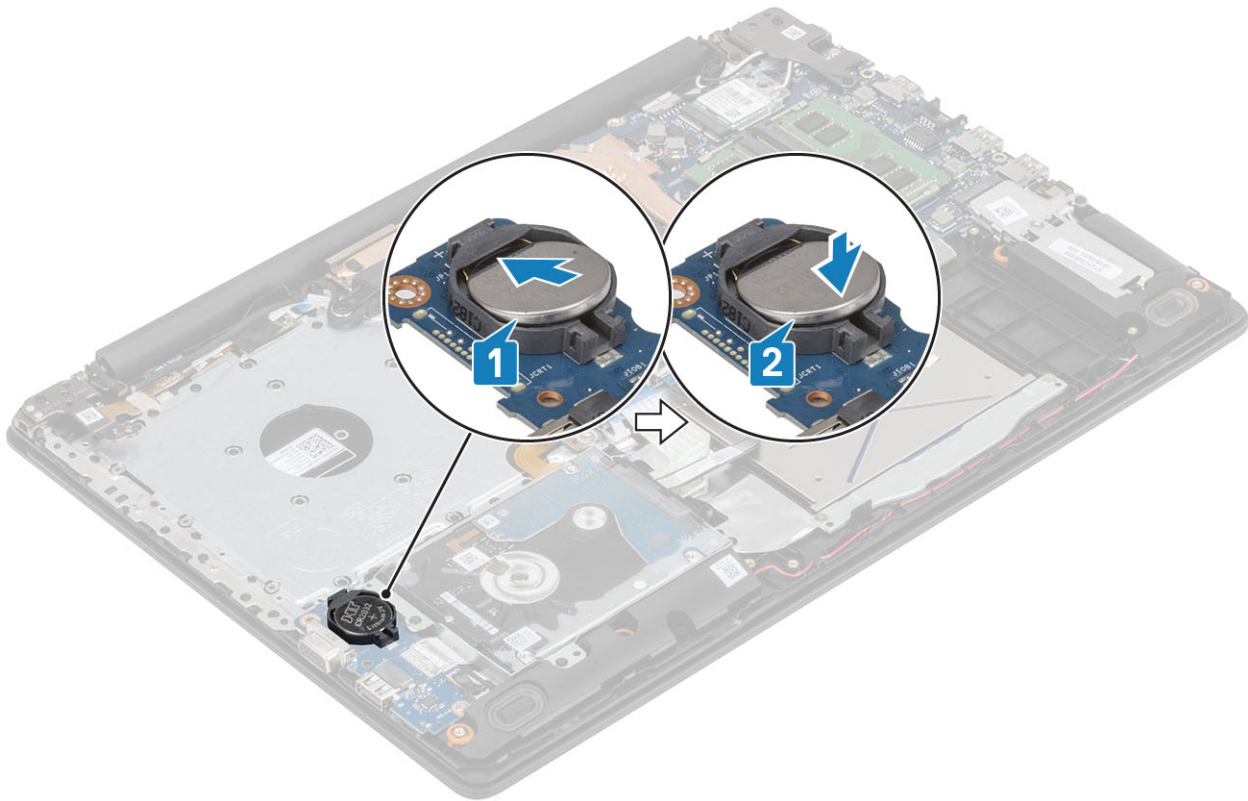

Next steps

1. Connect the [battery](#) cable to the connector on the system board.
2. Replace the [base cover](#)
3. Replace the [optical drive assembly](#)
4. Replace the [SD memory card](#)
5. Follow the procedure in [after working inside your computer](#)

Battery

Lithium-ion battery precautions

⚠ CAUTION:

- Exercise caution when handling Lithium-ion batteries.
- Discharge the battery as much as possible before removing it from the system. This can be done by disconnecting the AC adapter from the system to allow the battery to drain.
- Do not crush, drop, mutilate, or penetrate the battery with foreign objects.
- Do not expose the battery to high temperatures, or disassemble battery packs and cells.
- Do not apply pressure to the surface of the battery.
- Do not bend the battery.
- Do not use tools of any kind to pry on or against the battery.
- Ensure any screws during the servicing of this product are not lost or misplaced, to prevent accidental puncture or damage to the battery and other system components.
- If the battery gets stuck inside your computer as a result of swelling, do not try to release it as puncturing, bending, or crushing a lithium-ion battery can be dangerous. In such an instance, contact Dell technical support for assistance. See www.dell.com/contactdell.
- Always purchase genuine batteries from www.dell.com or authorized Dell partners and resellers.

Removing the battery

Prerequisites

1. Follow the procedure in [before working inside your computer](#)
2. Remove the [SD memory card](#)
3. Remove the [optical drive assembly](#)
4. Remove the [base cover](#)

Steps

1. Disconnect the battery cable from the system board [1].
2. Remove the four (M2x3) screws that secure the battery to the palmrest and keyboard assembly [2].
3. Lift the battery off the palmrest and keyboard assembly [3].

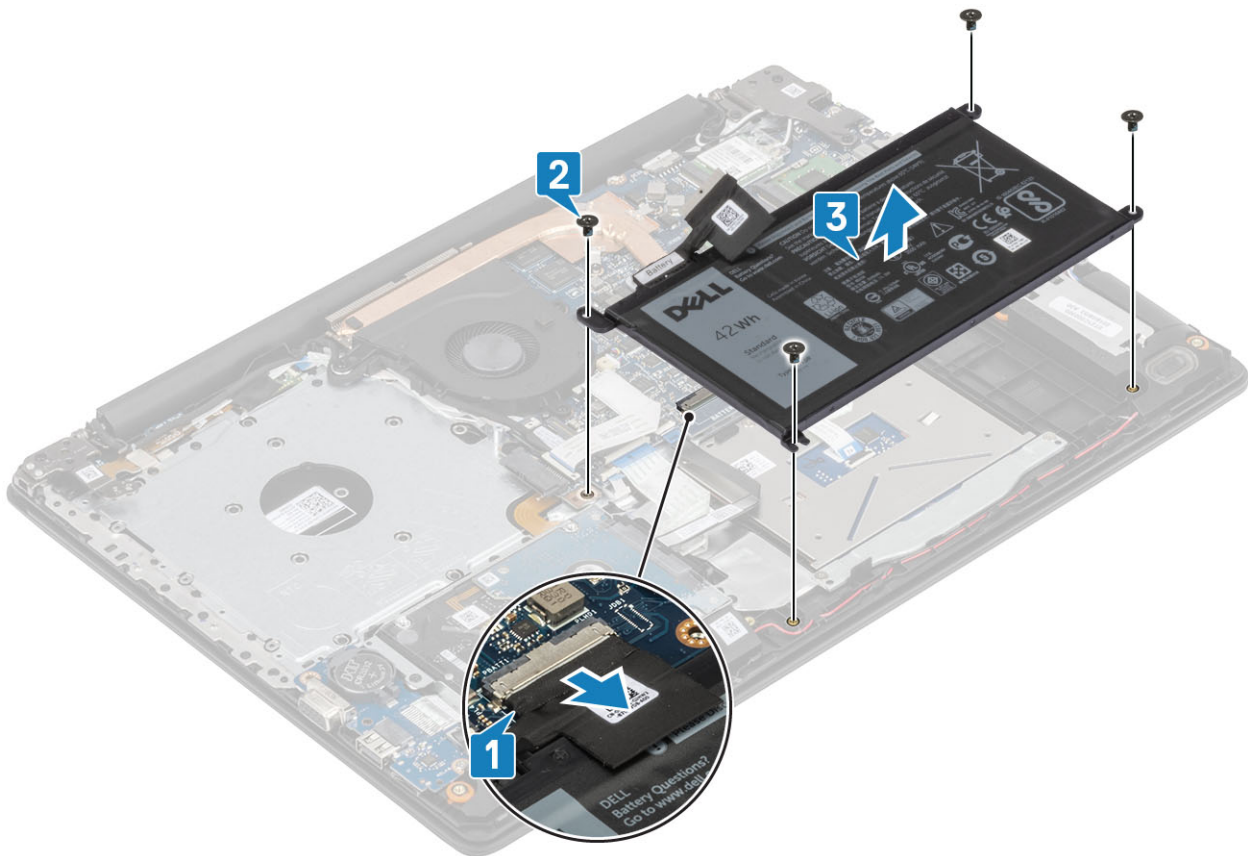

Installing the battery

Steps

1. Align the screw holes on the battery with the screw holes on the palmrest and keyboard assembly [1].
2. Replace the four (M2x3) screws that secure the battery to the palmrest and keyboard assembly [2].
3. Connect the battery cable to the system board [3].

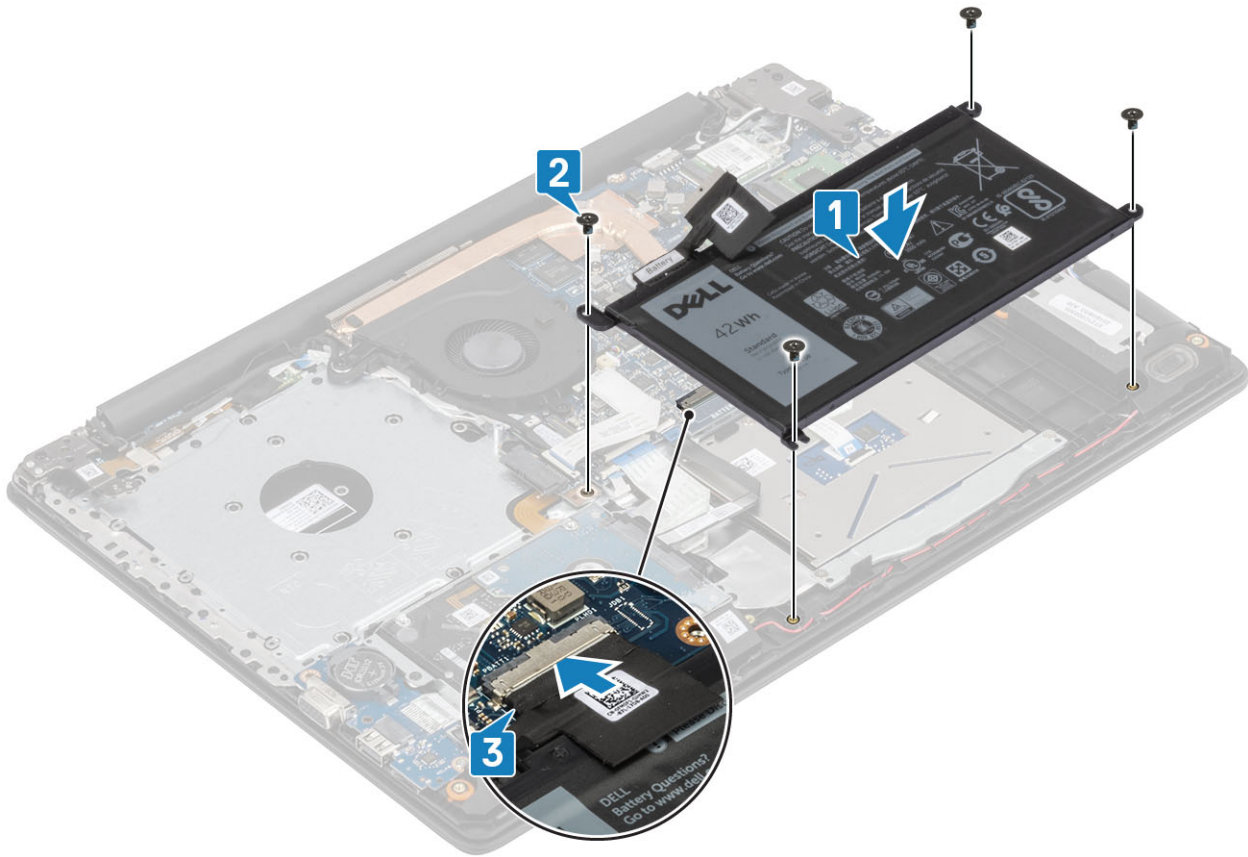

Next steps

1. Replace the [base cover](#)
2. Replace the [optical drive assembly](#)
3. Replace the [SD memory card](#)
4. Follow the procedure in [after working inside your computer](#)

Hard drive

Removing the hard drive assembly

Prerequisites

1. Follow the procedure in [before working inside your computer](#)
2. Remove the [SD memory card](#)
3. Remove the [optical drive assembly](#)
4. Remove the [base cover](#)
5. Remove the [battery](#)

Steps

1. Lift the latch and disconnect the hard drive cable from the system board [1].
2. Remove the four (M2x3) screws that secure the hard drive assembly to the palm rest and keyboard assembly [2].
3. Lift the hard drive assembly along with its cable off the palm rest and keyboard assembly [3].

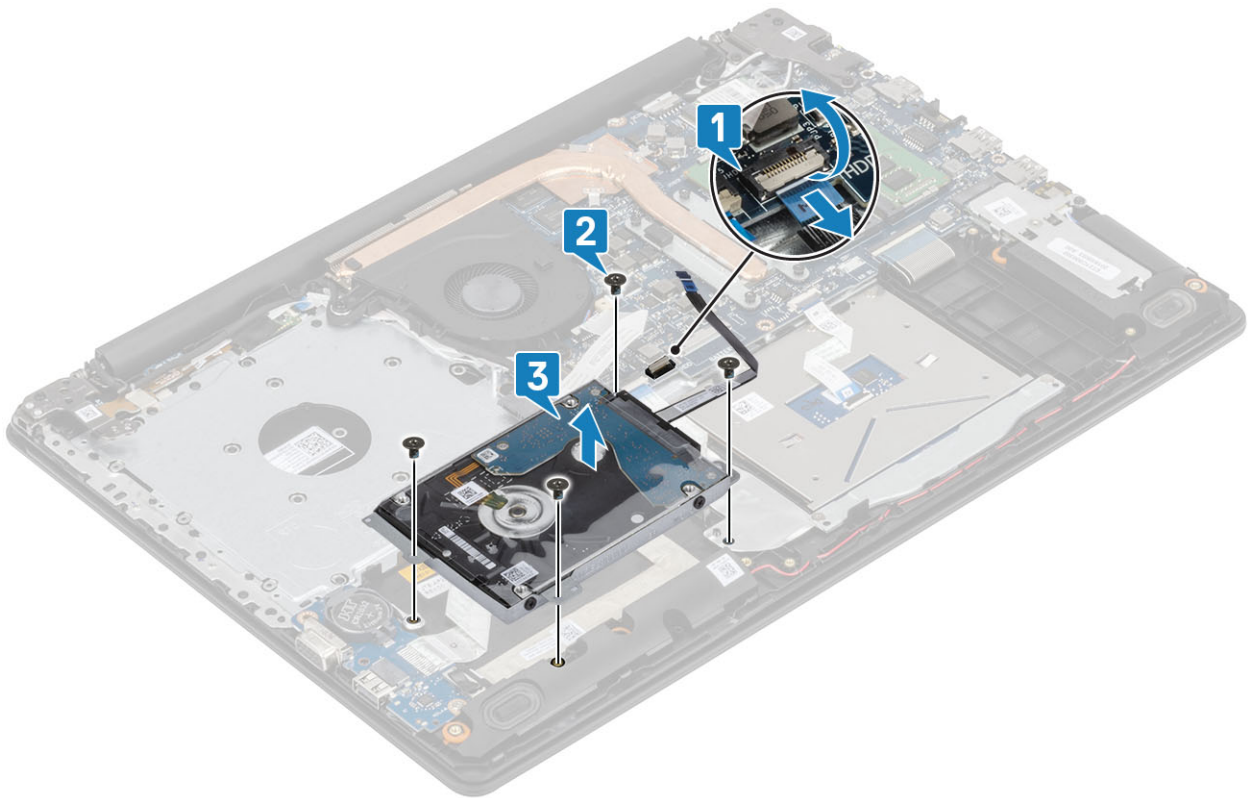

4. Disconnect the interposer from the hard drive.



5. Remove the four (M3x3) screws that secure the hard drive bracket to the hard drive [1].

6. Lift the hard drive bracket off the hard drive [2].

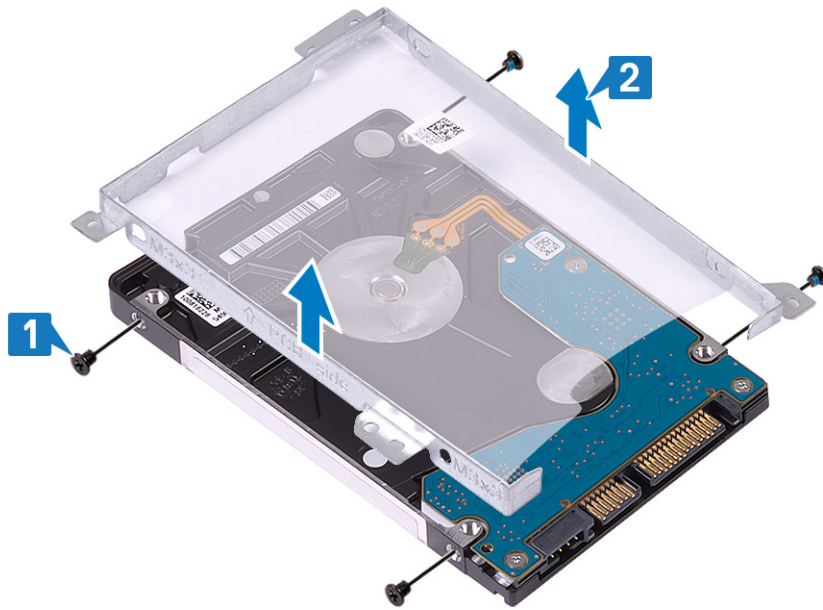

Installing the hard drive assembly

Steps

1. Align the screw holes on the hard drive bracket with the screw holes on the hard drive [1].
2. Replace the four (M3x3) screws that secure the hard drive bracket to the hard drive [2].

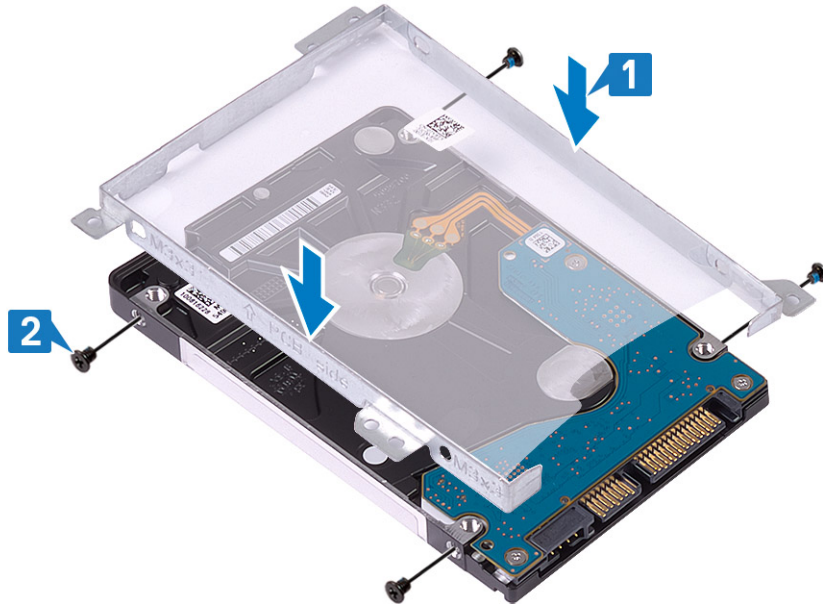

3. Connect the interposer to the hard drive.



4. Align the screw holes on the hard drive assembly with the screw holes on the palm rest and keyboard assembly [1].
5. Replace the four (M2x3) screws that secure the hard drive assembly to the palm rest and keyboard assembly [2].
6. Connect the hard drive cable to the system board and close the latch to secure the cable [3].

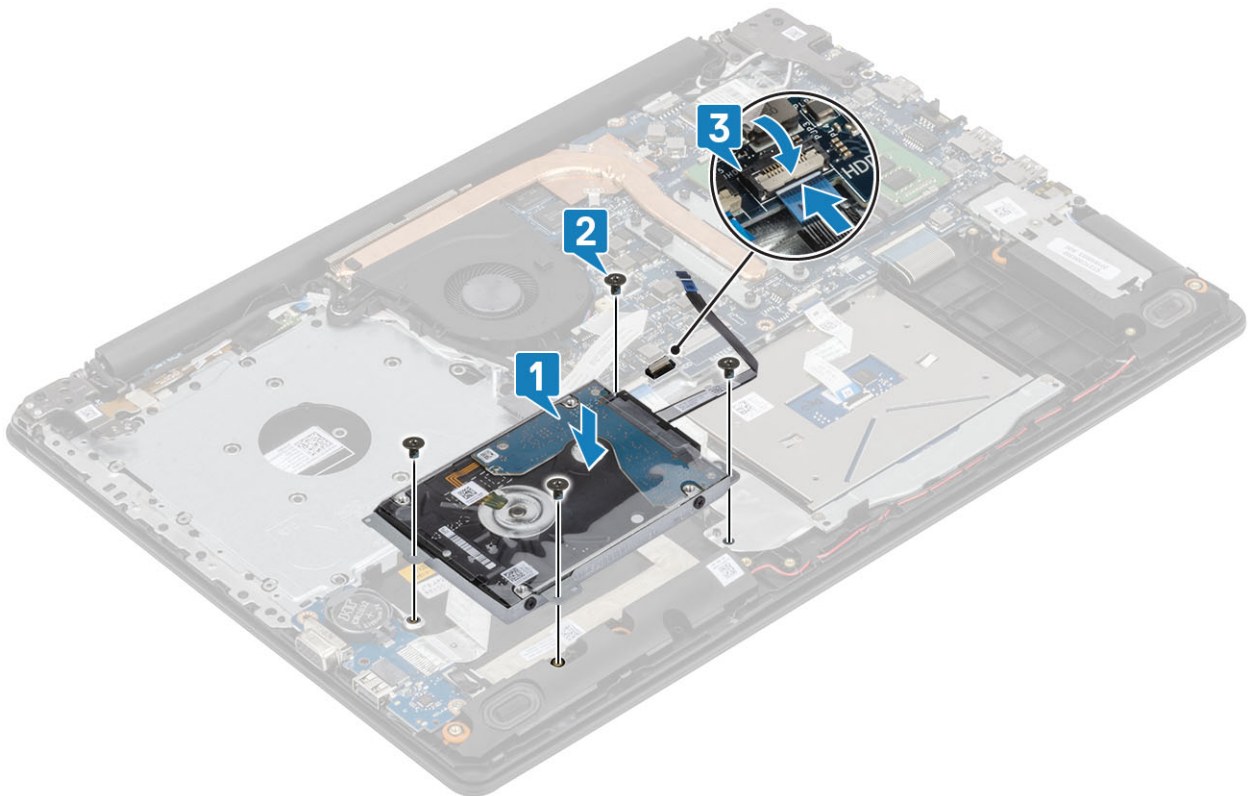

Next steps

1. Replace the [battery](#)
2. Replace the [base cover](#)
3. Replace the [optical drive assembly](#)
4. Replace the [SD memory card](#)
5. Follow the procedure in [after working inside your computer](#)

System fan

Removing the system fan

Prerequisites

1. Follow the procedure in [before working inside your computer](#)
2. Remove the [SD memory card](#)
3. Remove the [optical drive assembly](#)
4. Remove the [base cover](#)
5. Disconnect the battery cable from the connector on the system board.

Steps

1. Disconnect the ODD cable, display cable and fan cable from the system board [1, 2, 3].

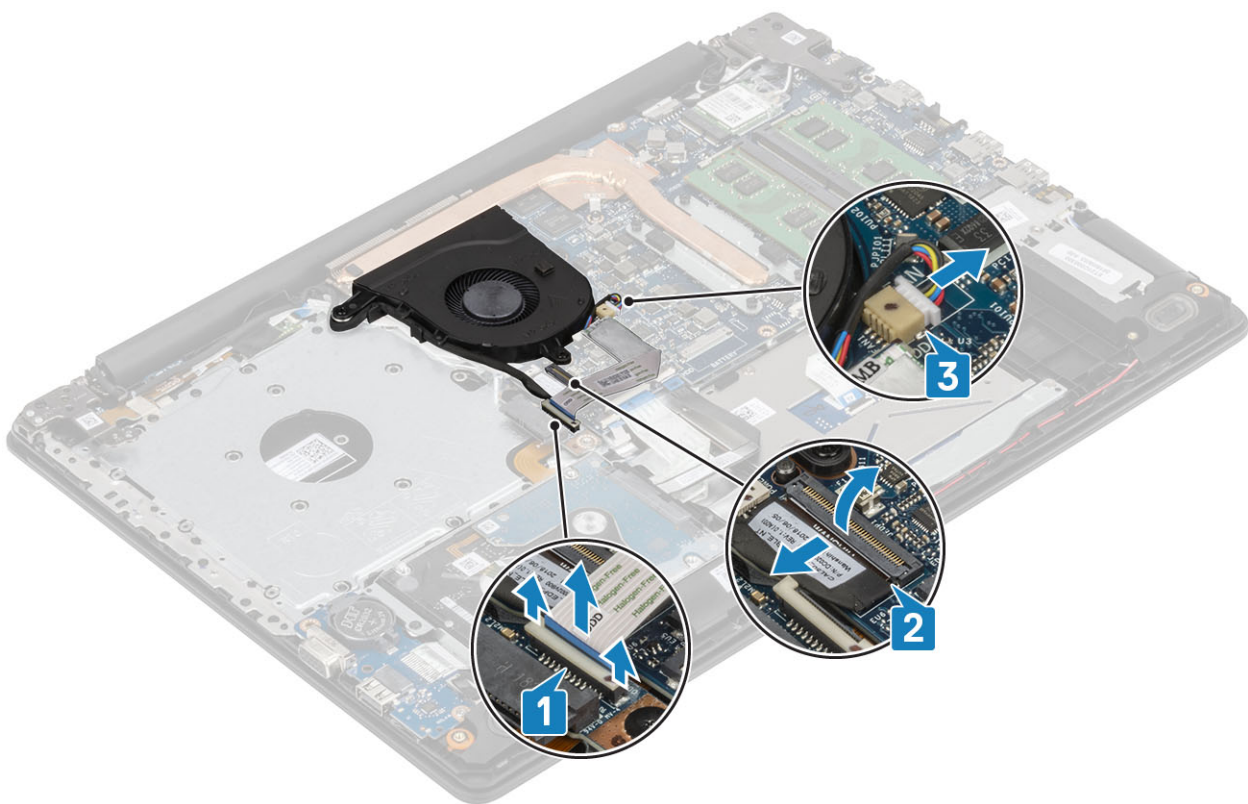

2. Unroute the display cable from the routing guides on the fan [1].

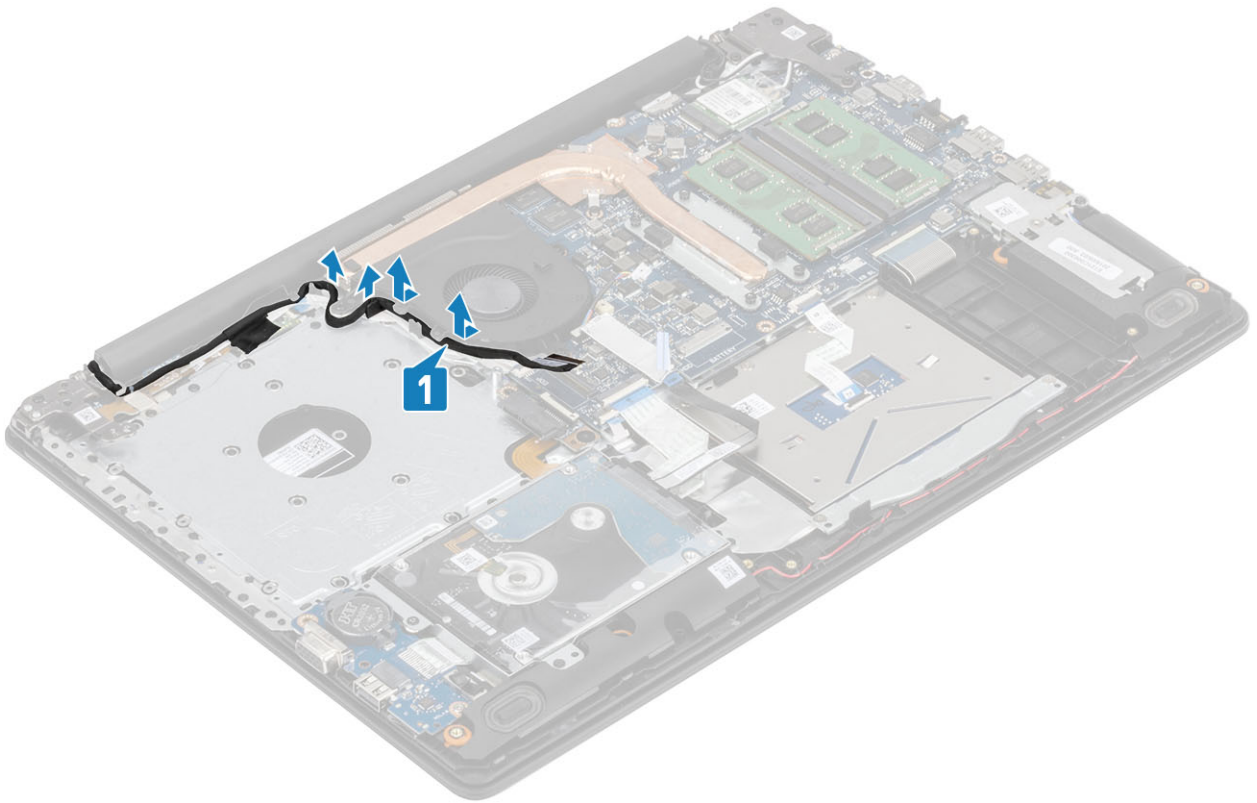

3. Remove the three (M2.5x5) screws that secure the fan to the palm rest and keyboard board assembly [1].
4. Lift the fan off the palm rest and keyboard board assembly [2].

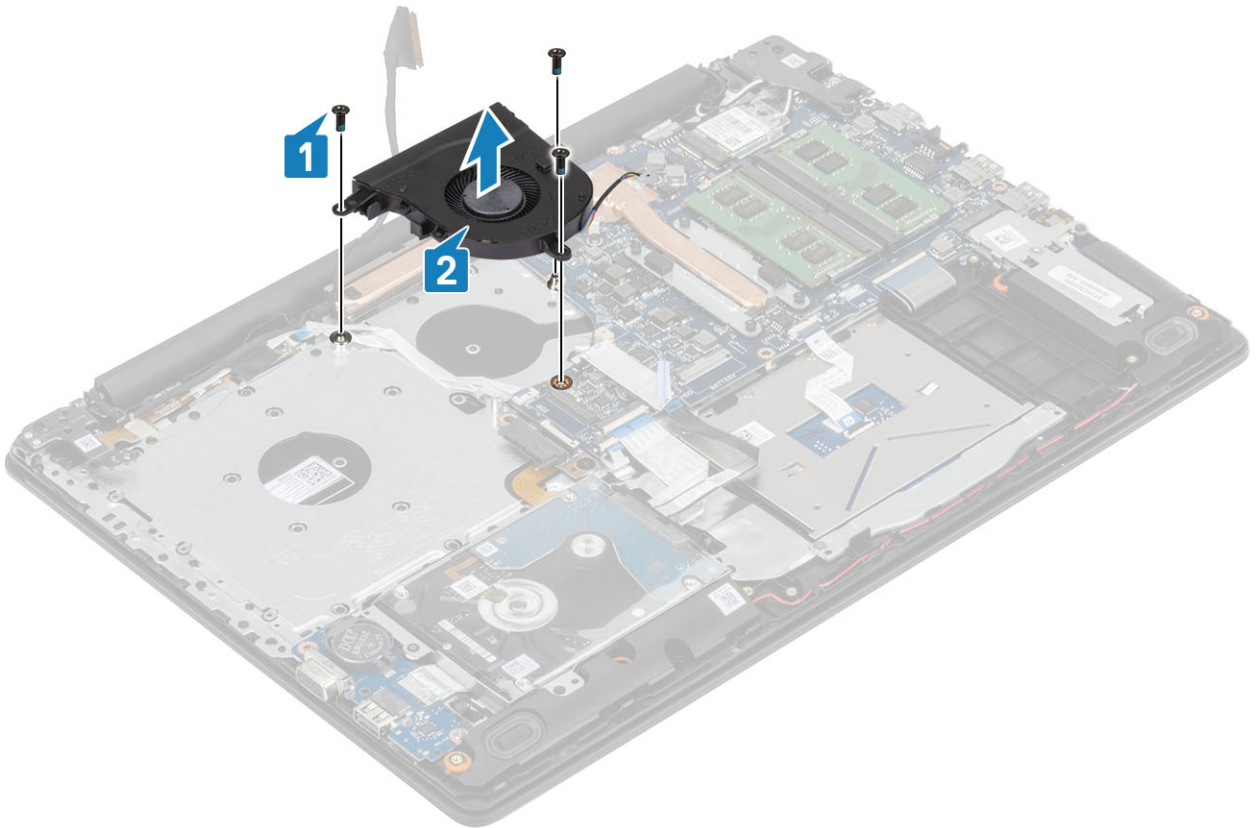

Installing the system fan

Steps

1. Align the screw holes on the fan with the screw holes on the palm rest and keyboard board assembly [1].
2. Replace the three (M2.5x5) screws that secure the fan to the palm rest and keyboard board assembly [2].

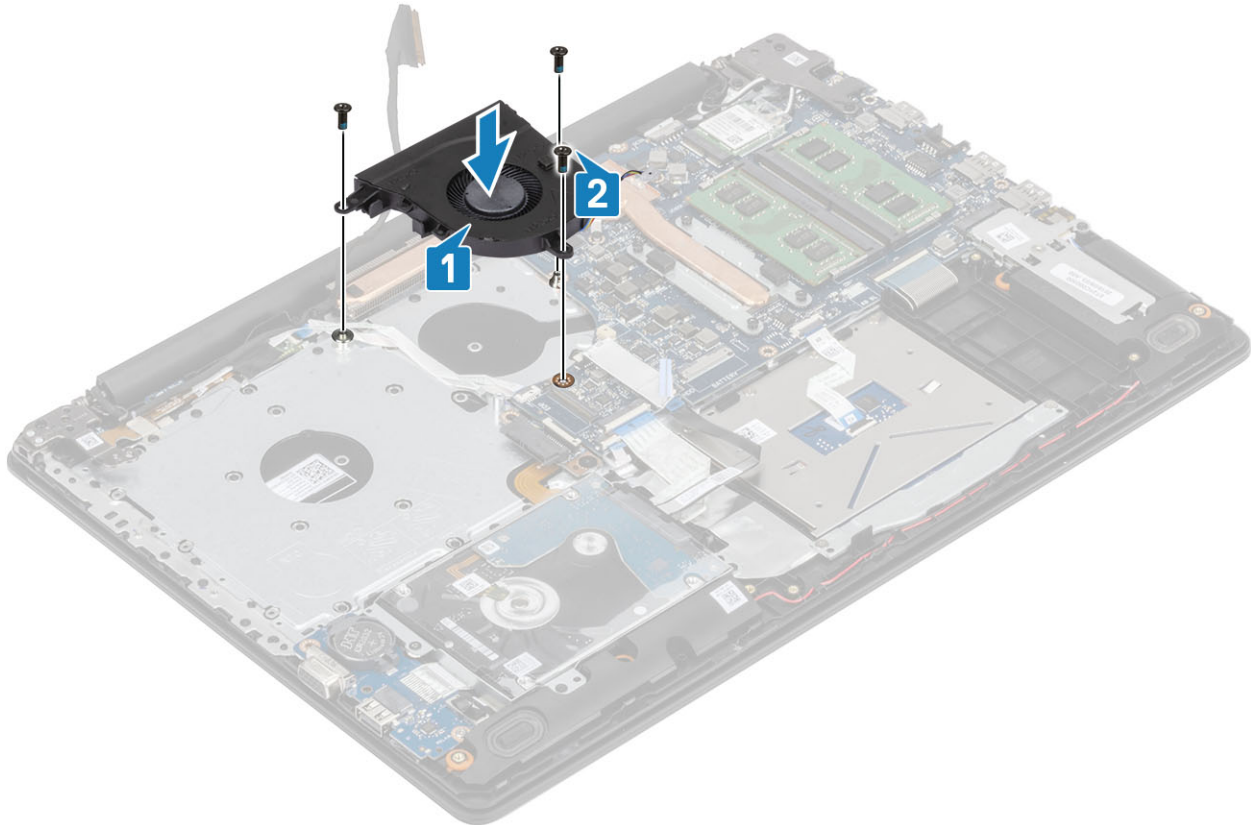

3. Route the display cable through the routing guides on the fan [1].

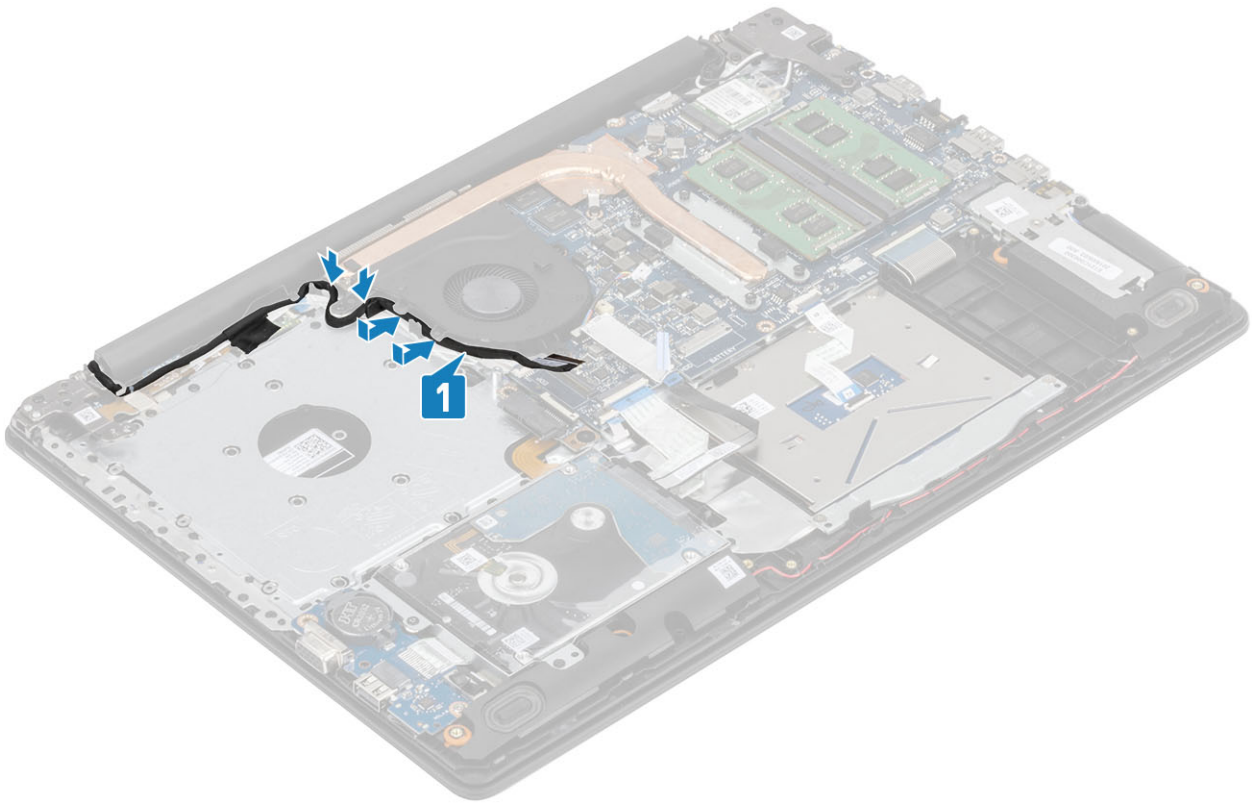

4. Connect the ODD cable, display cable and fan cable to the system board [3,2,1].

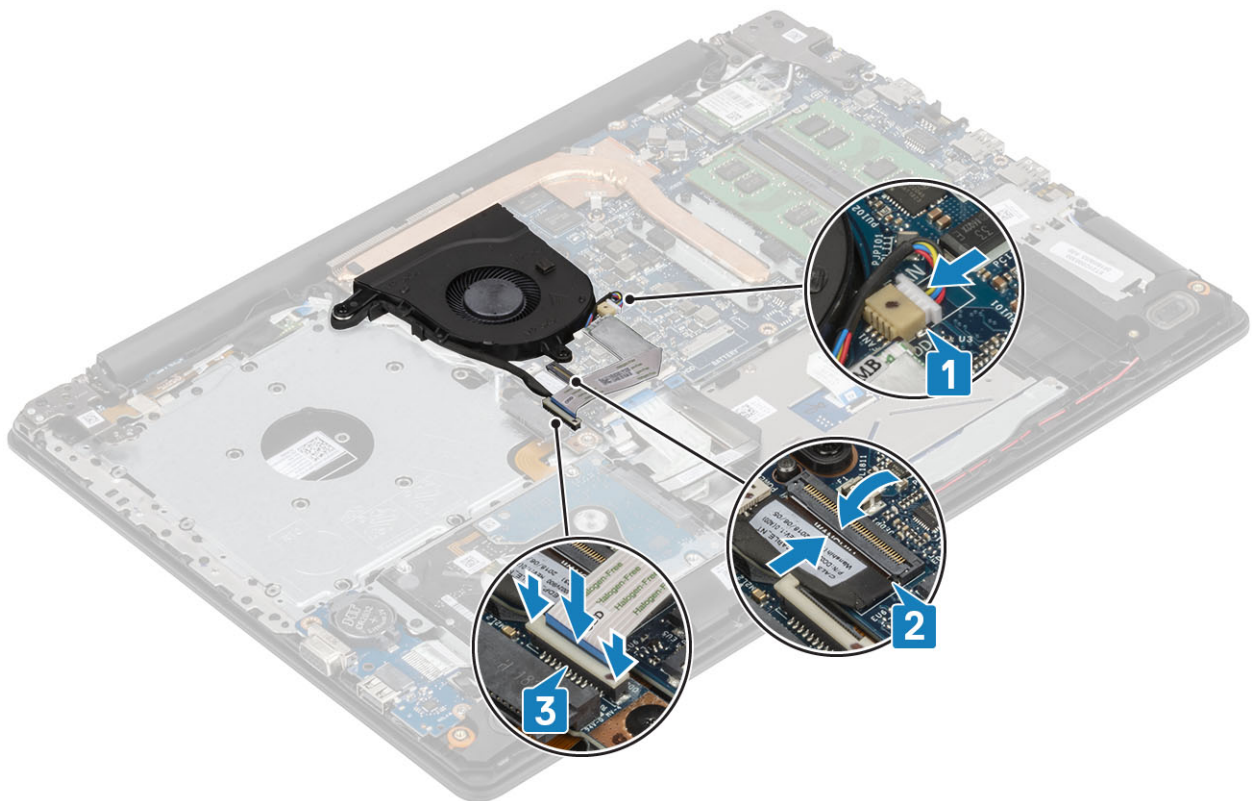

Next steps

1. Replace the [battery](#)
2. Replace the [base cover](#)
3. Replace the [optical drive assembly](#)

4. Replace the [SD memory card](#)
5. Follow the procedure in [after working inside your computer](#)

Heat sink

Removing the heatsink

Prerequisites

1. Follow the procedure in [before working inside your computer](#)
2. Remove the [SD memory card](#)
3. Remove the [optical drive assembly](#)
4. Remove the [base cover](#)
5. Disconnect the battery cable from the connector on the system board.

Steps

1. Loosen the four captive screws that secure the heatsink to the system board [1].
NOTE: Loosen the screws in the order of the callout numbers [1, 2, 3, 4] as indicated on the heatsink.
2. Remove the three (M2x3) screws that secure the heatsink to the system board [2].
3. Lift the heatsink off the system board [3].

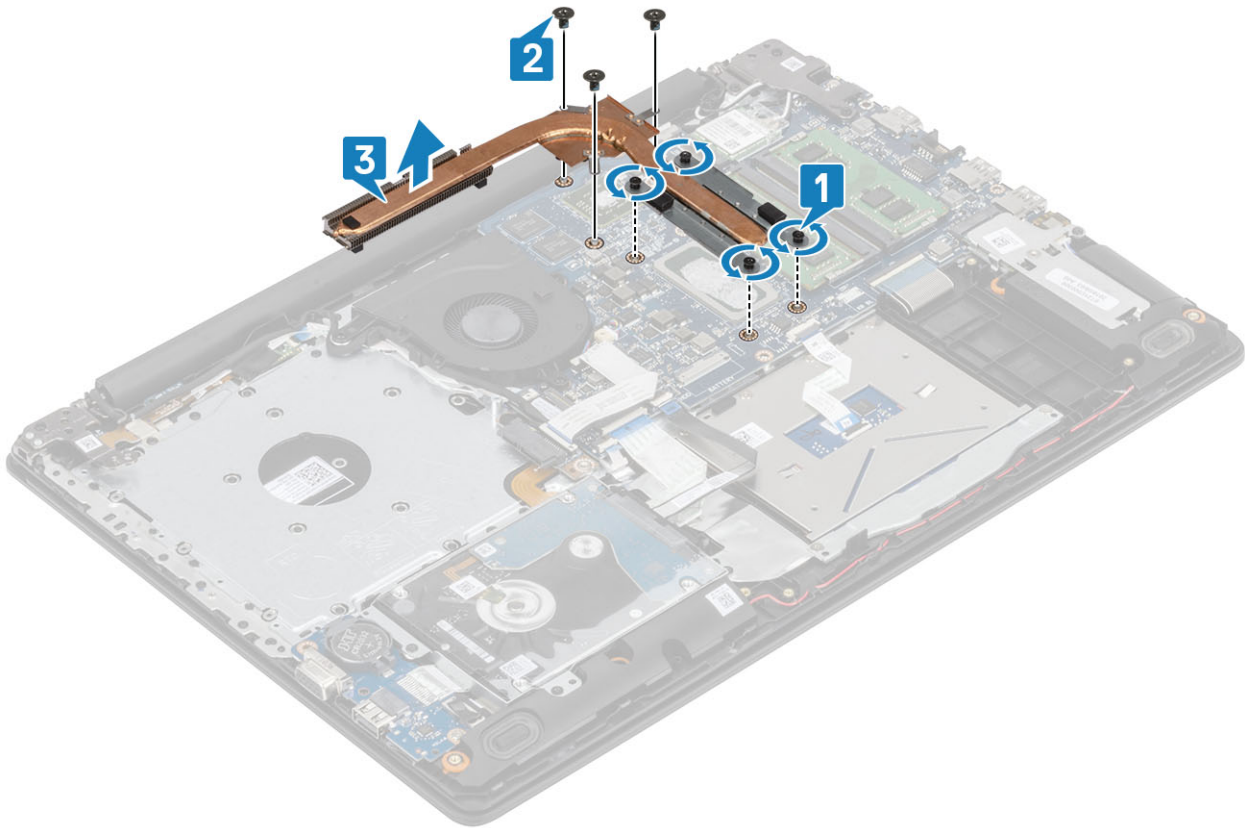

Installing the heatsink

Steps

1. Place the heatsink on the system board and align the screw holes on the heatsink with the screw holes on the system board [1].

2. Replace the three (M2x3) screws that secure the heatsink to the system board [2].
3. In sequential order (as indicated on the heatsink), tighten the four captive screws that secure the heatsink to the system board [3].

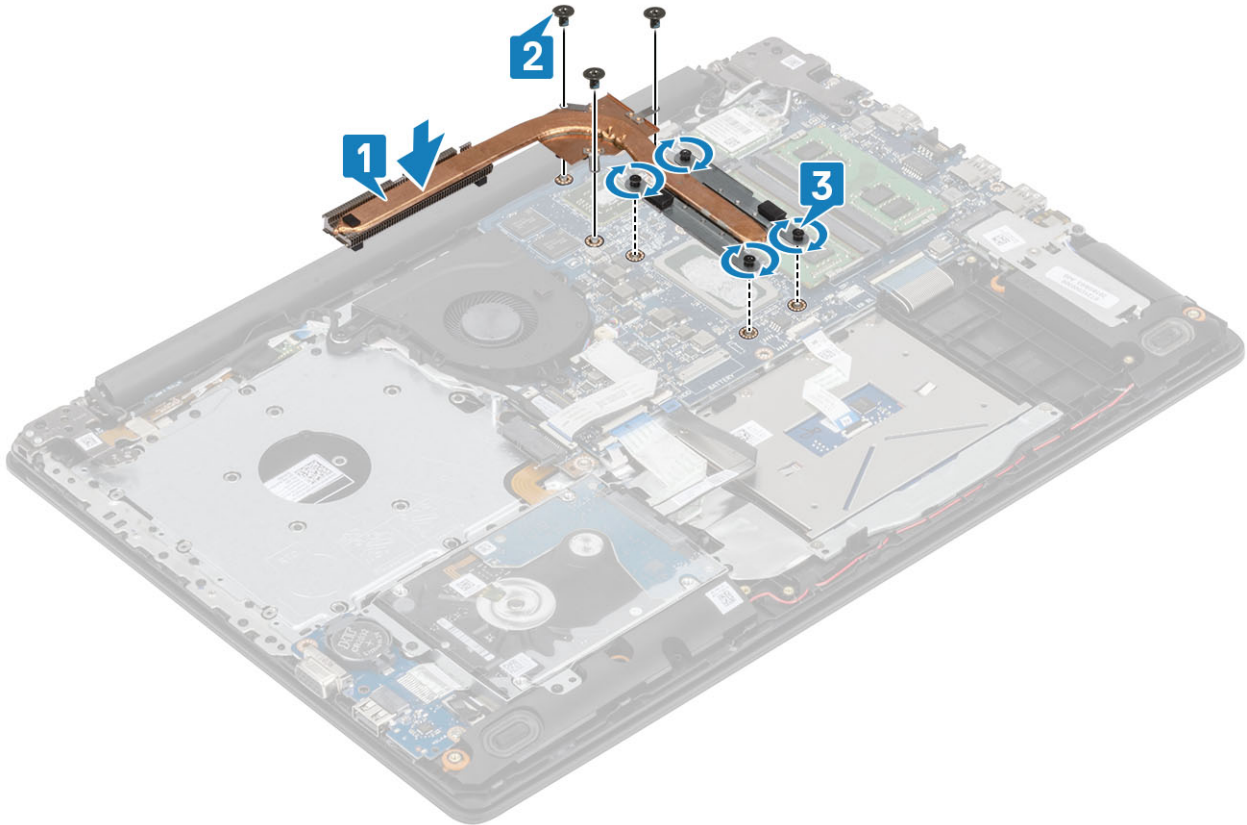

Next steps

1. Connect the battery cable to the connector on the system board.
2. Replace the [base cover](#)
3. Replace the [optical drive assembly](#)
4. Replace the [SD memory card](#)
5. Follow the procedure in [after working inside your computer](#)

VGA Daughterboard

Removing the VGAcable

Prerequisites

1. Follow the procedure in [before working inside your computer](#)
2. Remove the [SD memory card](#)
3. Remove the [optical drive assembly](#)
4. Remove the [base cover](#)
5. Disconnect the battery cable from the connector on the system board.
6. Remove the [memory](#)
7. Remove the [WLAN](#)
8. Remove the [SSD](#)
9. Remove the [coin cell battery](#)
10. Remove the [hard drive assembly](#)
11. Remove the [system fan](#)
12. Remove the [heatsink](#)

13. Remove the [IO board](#)
14. Remove the [display assembly](#)
15. Remove the [system board](#)

Steps

Disconnect the VGA cable and remove it from the palmrest and keyboard assembly [1].



Installing the VGA cable

Steps

Connect the VGA cable and affix it to the palmrest and keyboard assembly [1].



Next steps

1. Replace the [system board](#)
2. Replace the [display assembly](#)
3. Replace the [IO board](#)
4. Replace the [heatsink](#)
5. Replace the [system fan](#)
6. Replace the [hard drive assembly](#)
7. Replace the [coin cell battery](#)
8. Replace the [SSD](#)
9. Replace the [WLAN](#)
10. Replace the [memory](#)
11. Connect the battery cable to the connector on the system board.
12. Replace the [base cover](#)
13. Replace the [optical drive assembly](#)
14. Replace the [SD memory card](#)
15. Follow the procedure in [after working inside your computer](#)

Speakers

Removing the speakers

Prerequisites

1. Follow the procedure in [before working inside your computer](#)
2. Remove the [SD memory card](#)
3. Remove the [optical drive assembly](#)
4. Remove the [base cover](#)
5. Remove the [battery](#)
6. Remove the [SSD](#)

Steps

1. Disconnect the speaker cable from the system board [1].
2. Unroute and remove the speaker cable from the routing guides on palm rest and keyboard assembly [2].
3. Lift the speakers, along with the cable, off the palm rest and keyboard assembly [3].

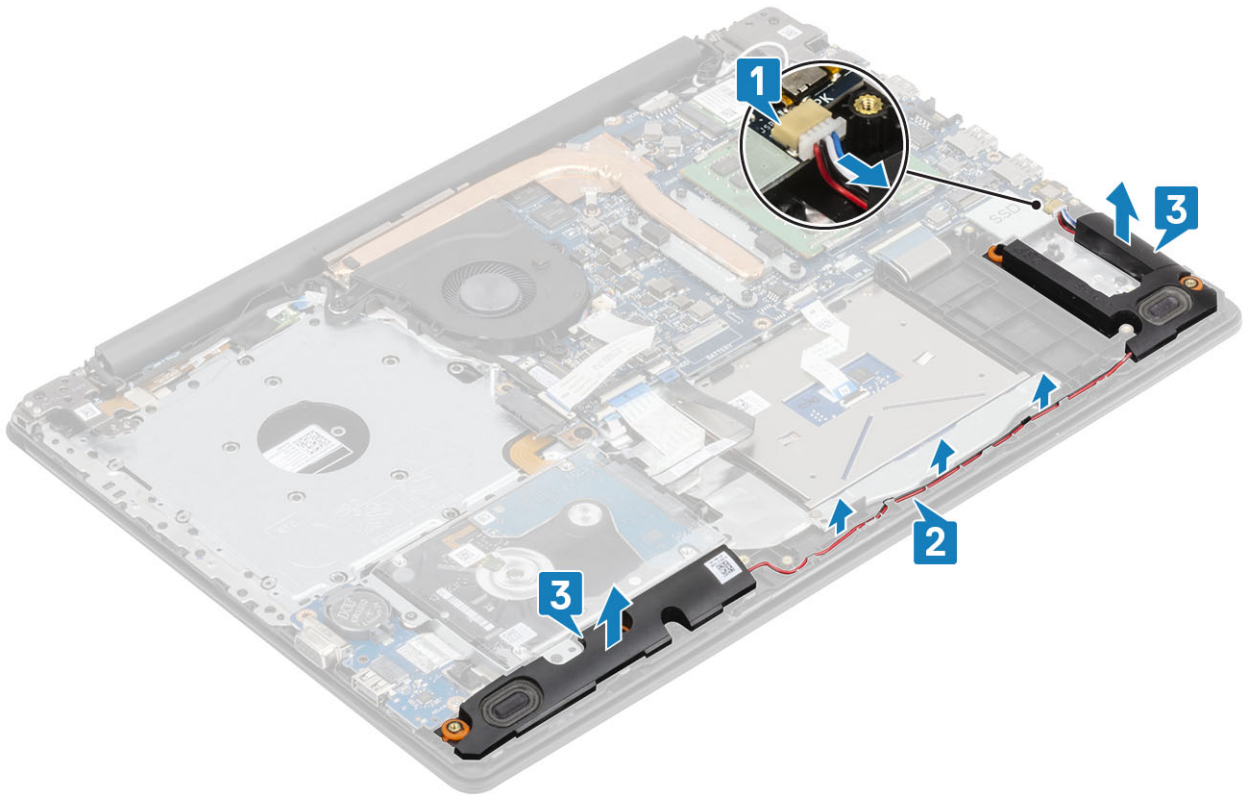

Installing the speakers

About this task

NOTE: If the rubber grommets are pushed out when removing the speakers, push them back in before replacing the speakers.

Steps

1. Using the alignment posts and rubber grommets, place the speakers in the slots on the palm rest and keyboard assembly [1].
2. Route the speaker cable through the routing guides on the palm rest and keyboard assembly [2].
3. Connect the speaker cable to the system board [3].

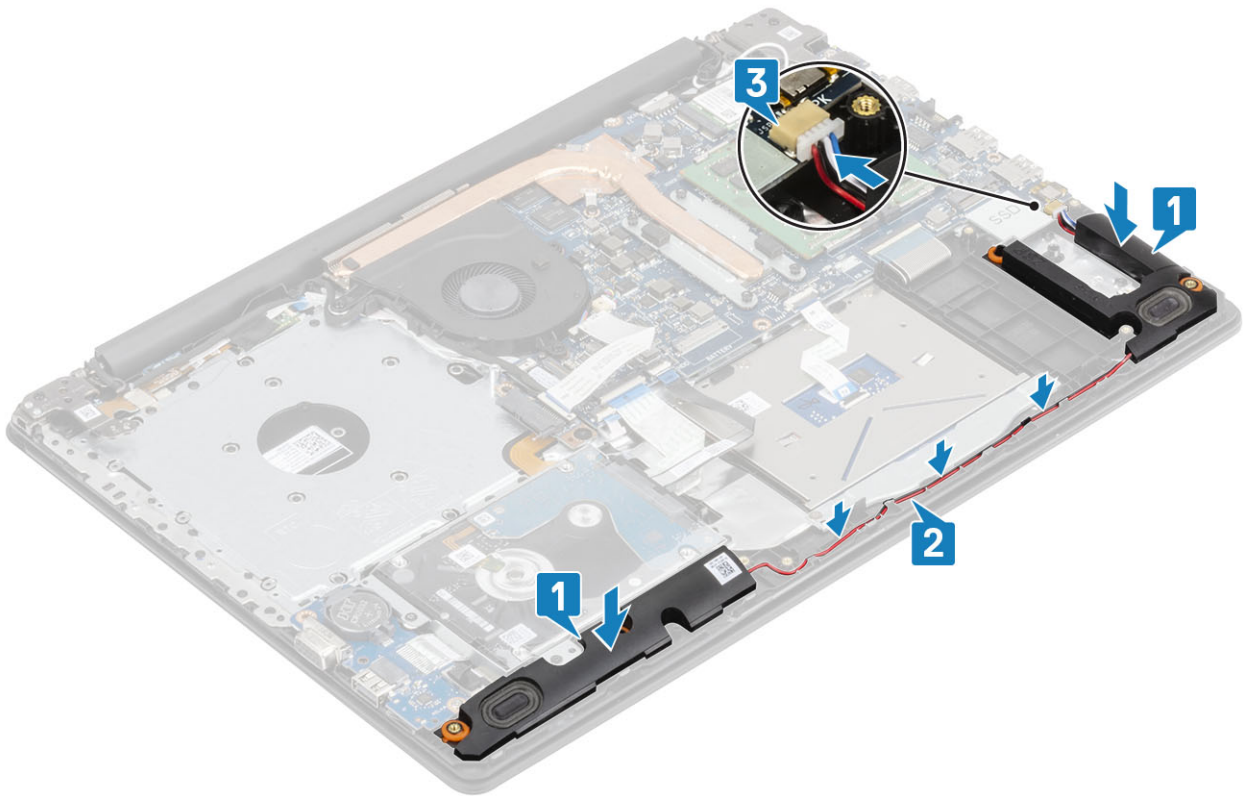

Next steps

1. Replace the [SSD](#)
2. Replace the [battery](#)
3. Replace the [base cover](#)
4. Replace the [optical drive assembly](#)
5. Replace the [SD memory card](#)
6. Follow the procedure in [after working inside your computer](#)

IO board

Removing the IO board

Prerequisites

1. Follow the procedure in [before working inside your computer](#)
2. Remove the [SD memory card](#)
3. Remove the [optical drive assembly](#)
4. Remove the [base cover](#)
5. Remove the [battery](#)
6. Remove the [hard drive assembly](#)

Steps

1. Disconnect the VGA cable from the I/O board [1].
2. Open the latch and disconnect the I/O board cable from the system board [2].

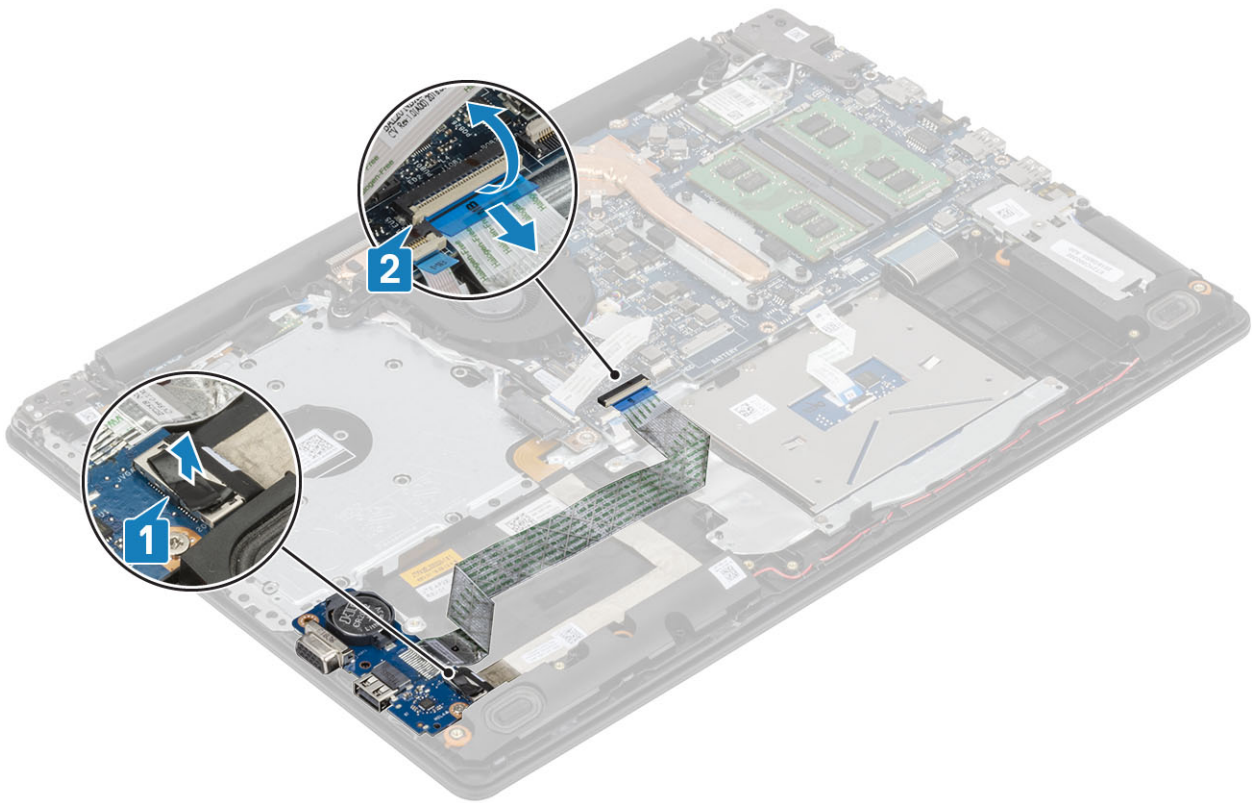

3. Remove the single (M2x4) screw that secures the I/O board to the palm rest and keyboard assembly [1].
4. Lift the I/O board, along with the cable, off the palm rest and keyboard assembly [2].

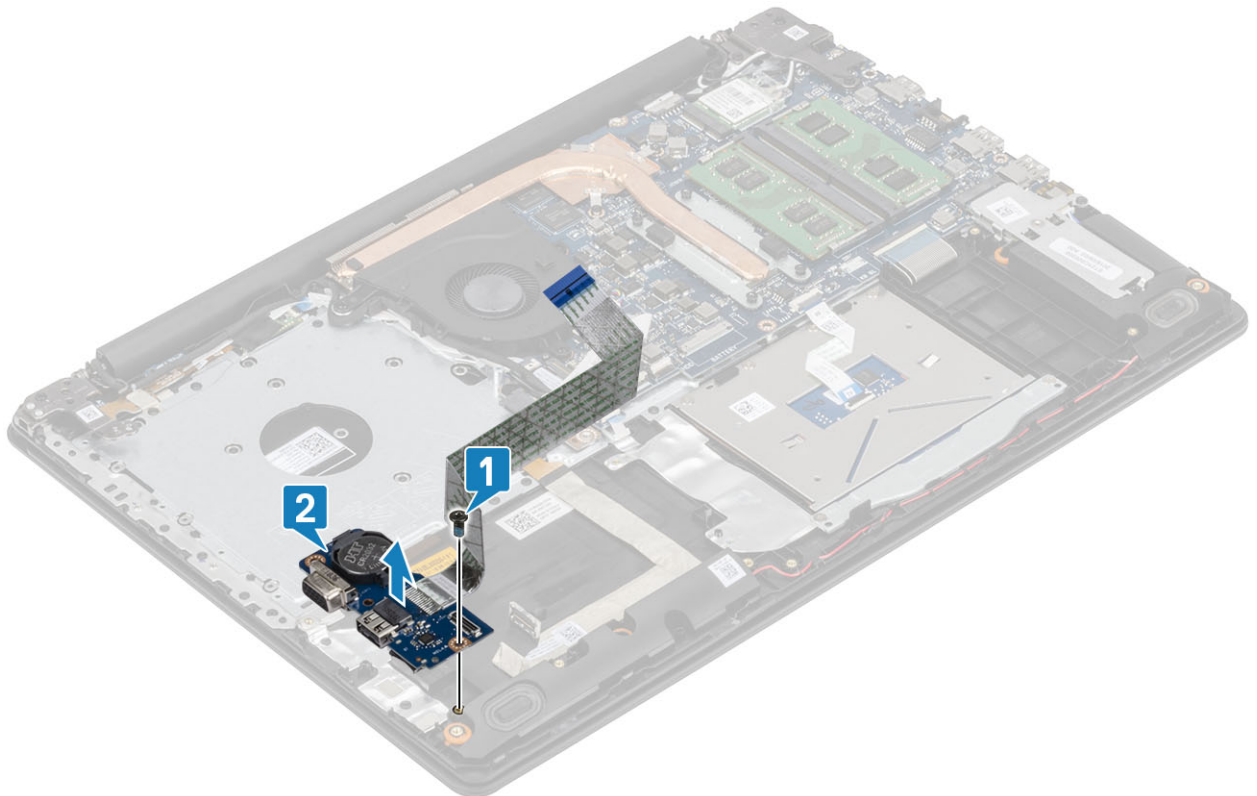

NOTE: When the IO board cable is disconnected from the system board, an RTC error occurs. This error occurs whenever the RTC/coin-cell battery, IO board, or system board are removed.

In such instances, after the system is reassembled, it will undergo an RTC reset cycle and the computer turns on and turn off several times.

An "Invalid Configuration" error message is displayed prompting you to enter the BIOS and configure the date and time. The computer starts functioning normally after setting the date and time.

Installing the IO board

Steps

1. Using the alignment posts, place the I/O board on the palm rest and keyboard assembly [1].
2. Replace the single (M2x4) screw that secures the I/O board to the palm rest and keyboard assembly [2].

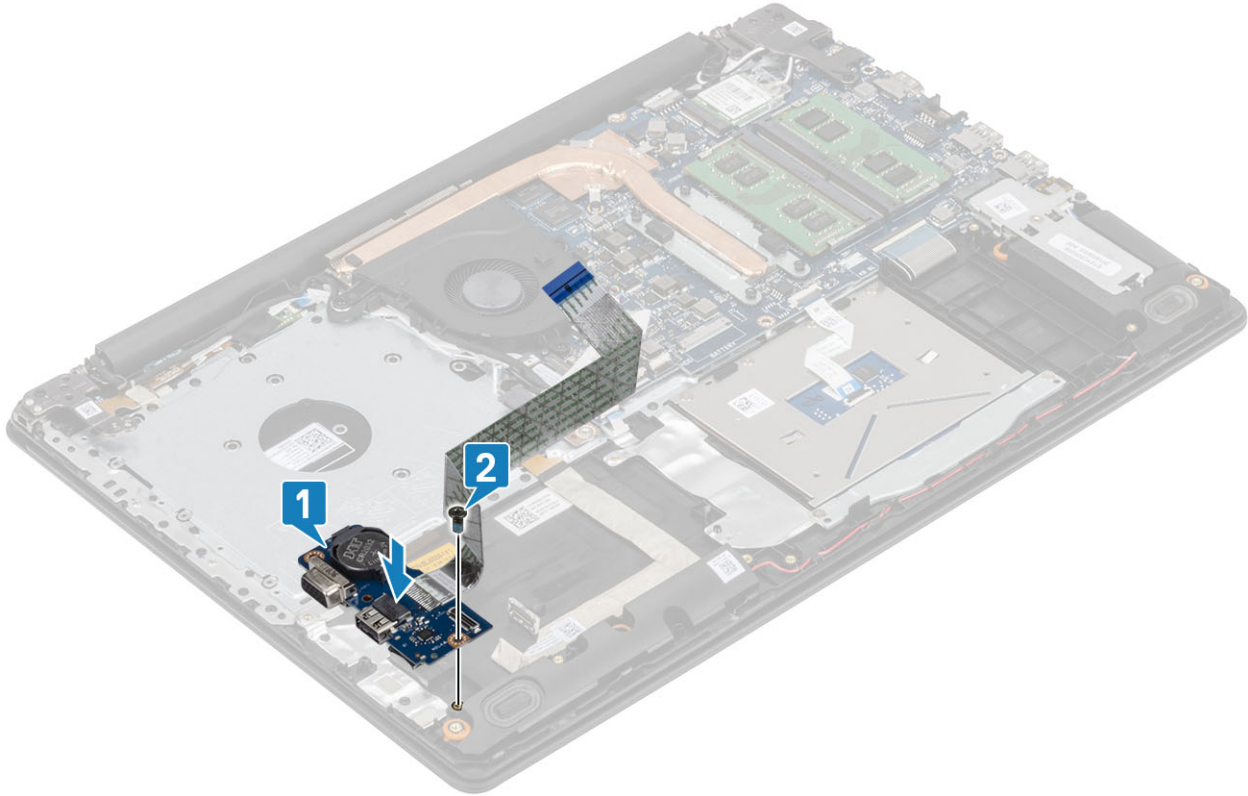

3. Connect the VGA cable to the I/O board [1].
4. Connect the I/O board cable to the system board and close the latch to secure the cable [2].

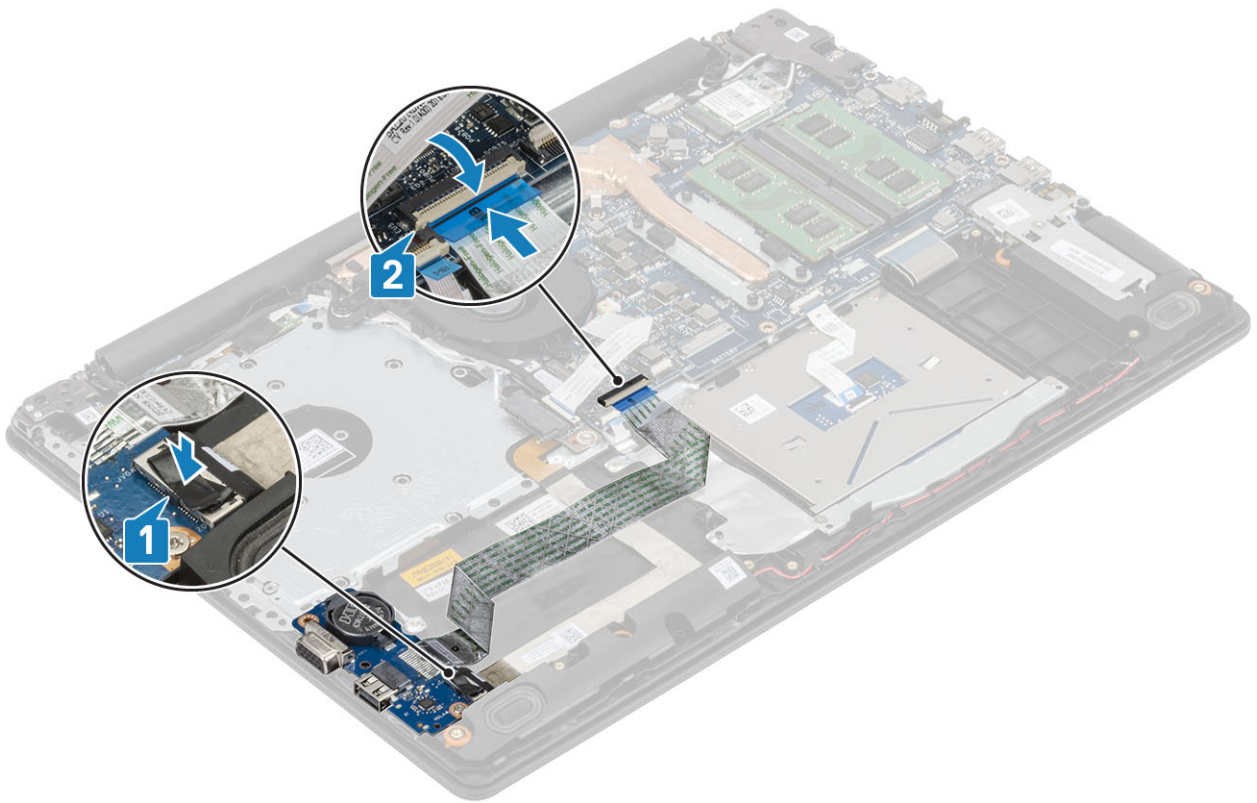

Next steps

1. Replace the [hard drive assembly](#)
2. Replace the [battery](#)
3. Replace the [base cover](#)
4. Replace the [optical drive assembly](#)
5. Replace the [SD memory card](#)
6. Follow the procedure in [after working inside your computer](#)

Touchpad

Removing the touch pad assembly

Prerequisites

1. Follow the procedure in [before working inside your computer](#)
2. Remove the [SD memory card](#)
3. Remove the [optical drive assembly](#)
4. Remove the [base cover](#)
5. Remove the [battery](#)

Steps

1. Open the latch and disconnect the hard drive cable and touch pad cable from the system board [1, 2].
2. Peel the tape that secures the touch pad to the palmrest and keyboard assembly [3].

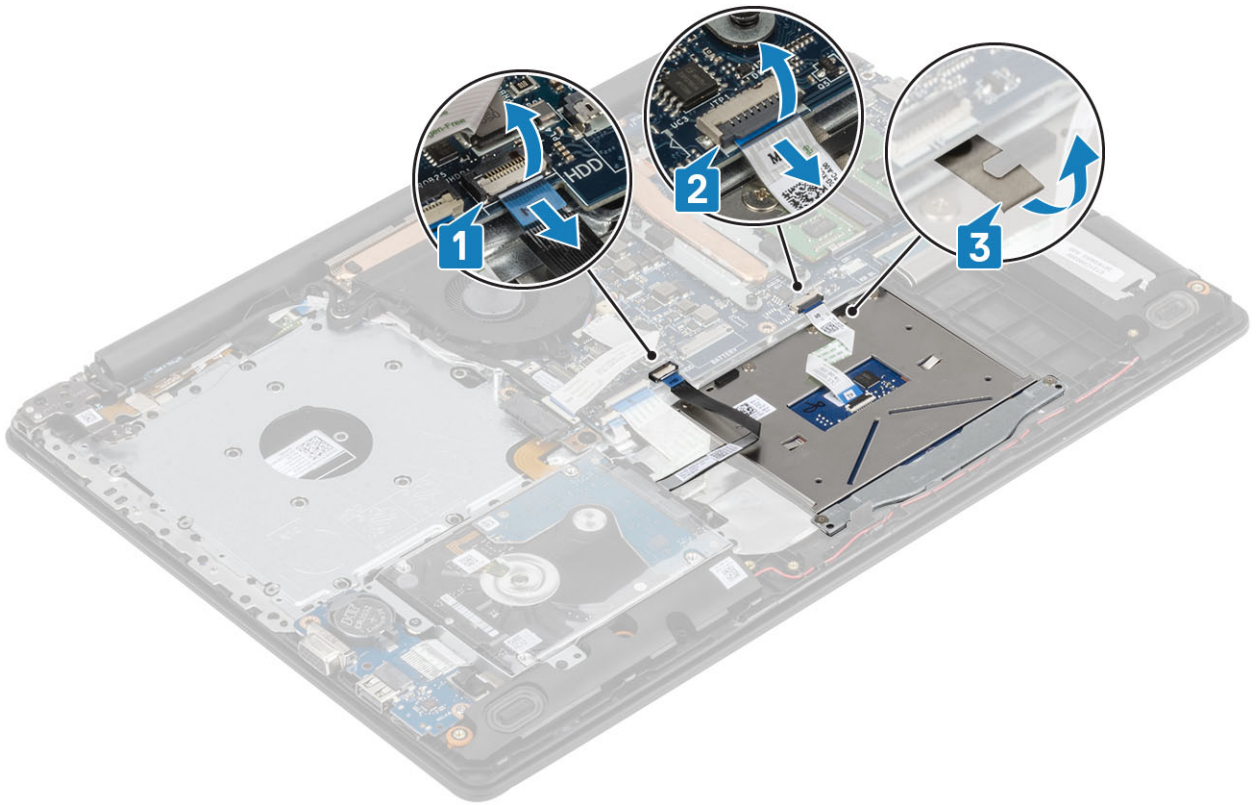

3. Remove the two (M2x2) screws that secure the touch pad bracket to the palmrest and keyboard assembly [1].
4. Lift the touch pad bracket off the palm rest and keyboard assembly [2].

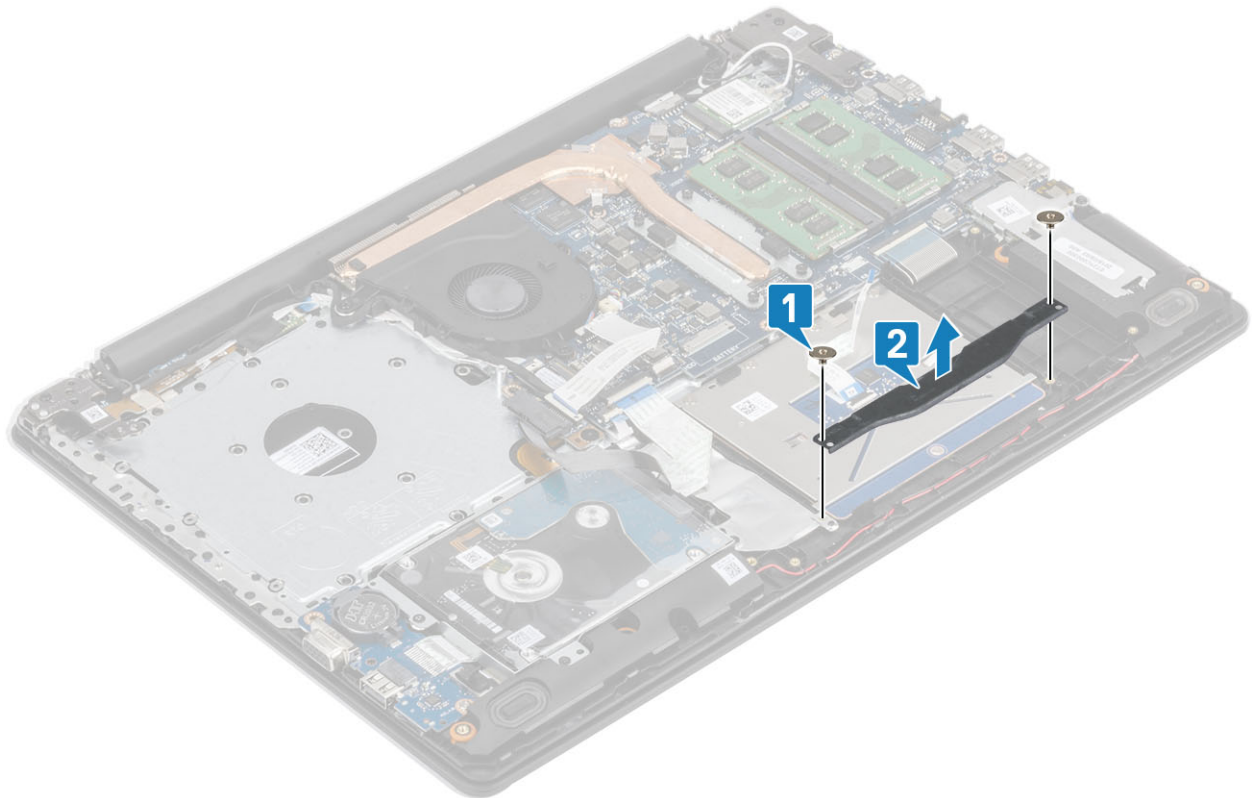

5. Remove the four (M2x2) screws that secure the touch pad to the palmrest and keyboard assembly [1].
6. Lift the touch pad off the palmrest and keyboard assembly [2].

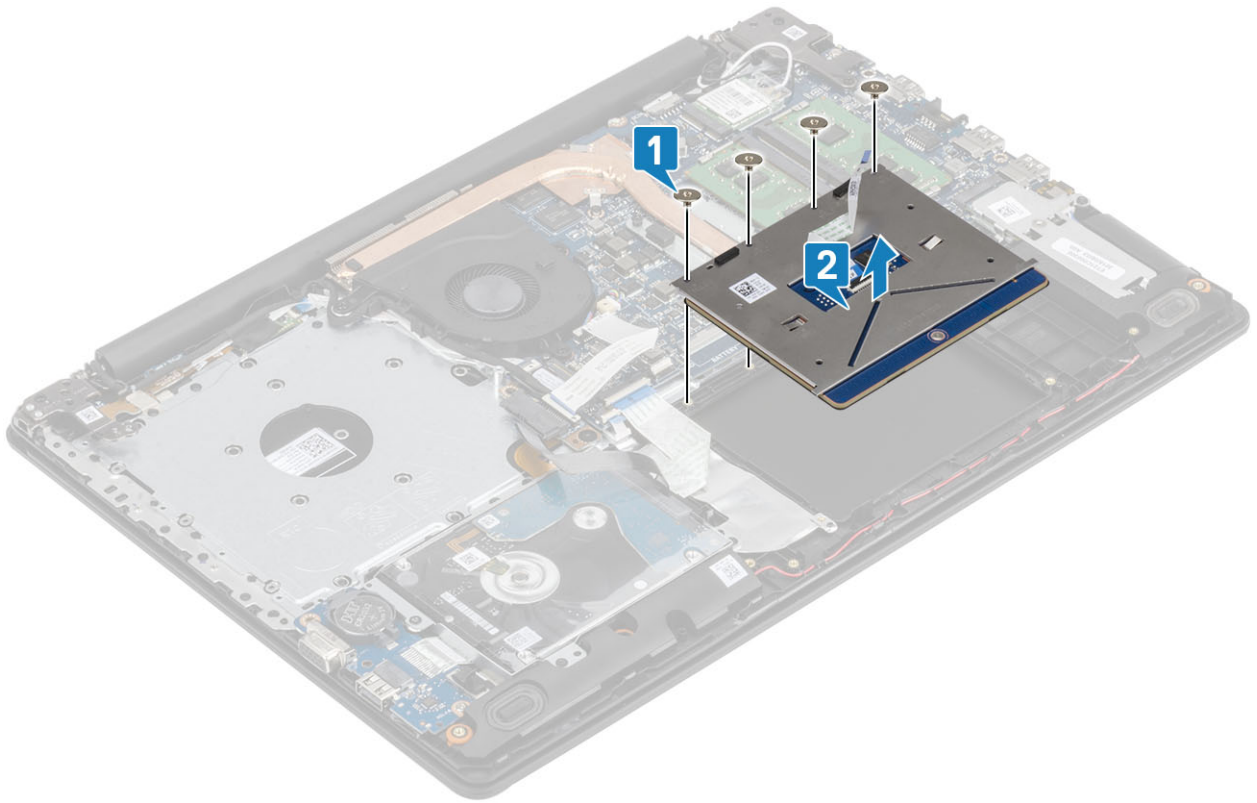

Installing the touch pad assembly

About this task

NOTE: Ensure that the touch pad is aligned with the guides available on the palm-rest and keyboard assembly, and the gap on either sides of the touch pad is equal.

Steps

1. Place the touch pad into the slot on the palmrest and keyboard assembly [1].
2. Replace the four (M2x2) screws that secure the touch pad to the palmrest and keyboard assembly [2].

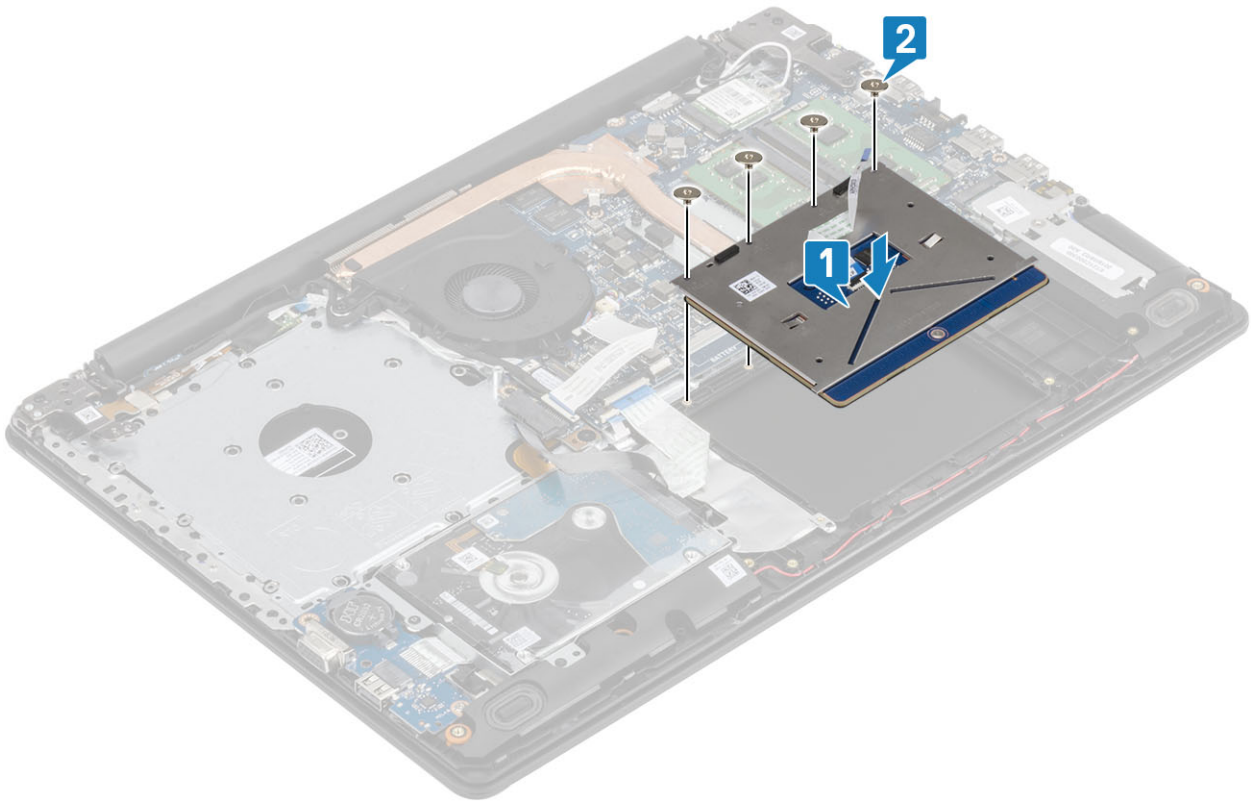

3. Place the touch pad bracket into the slot on the palmrest and keyboard assembly [1].
4. Replace the two screws (M2x2) that secure the touch pad bracket to the palmrest and keyboard assembly [2].

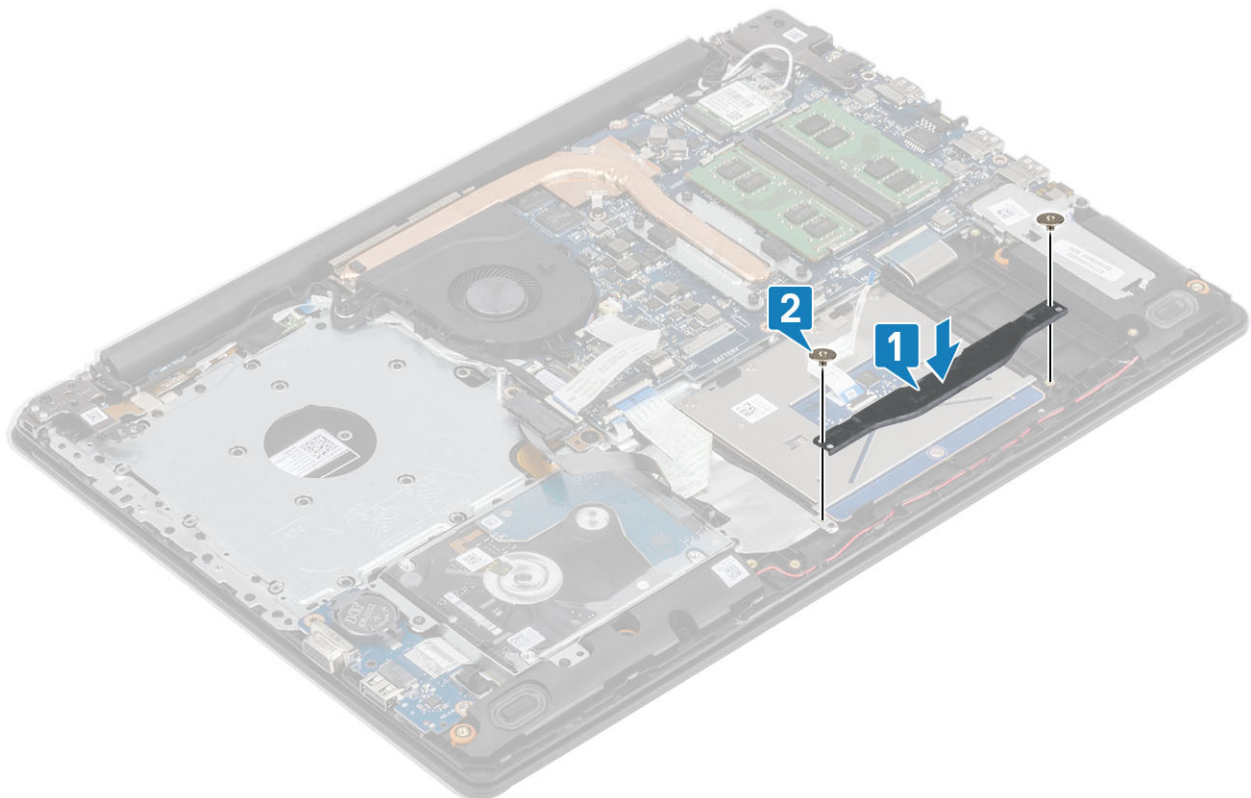

5. Affix the tape that secures the touch pad to the palmrest and keyboard assembly [1].
6. Slide the touch pad cable and hard drive cable into its connector on the system board and close the latch to secure the cables [2, 3].

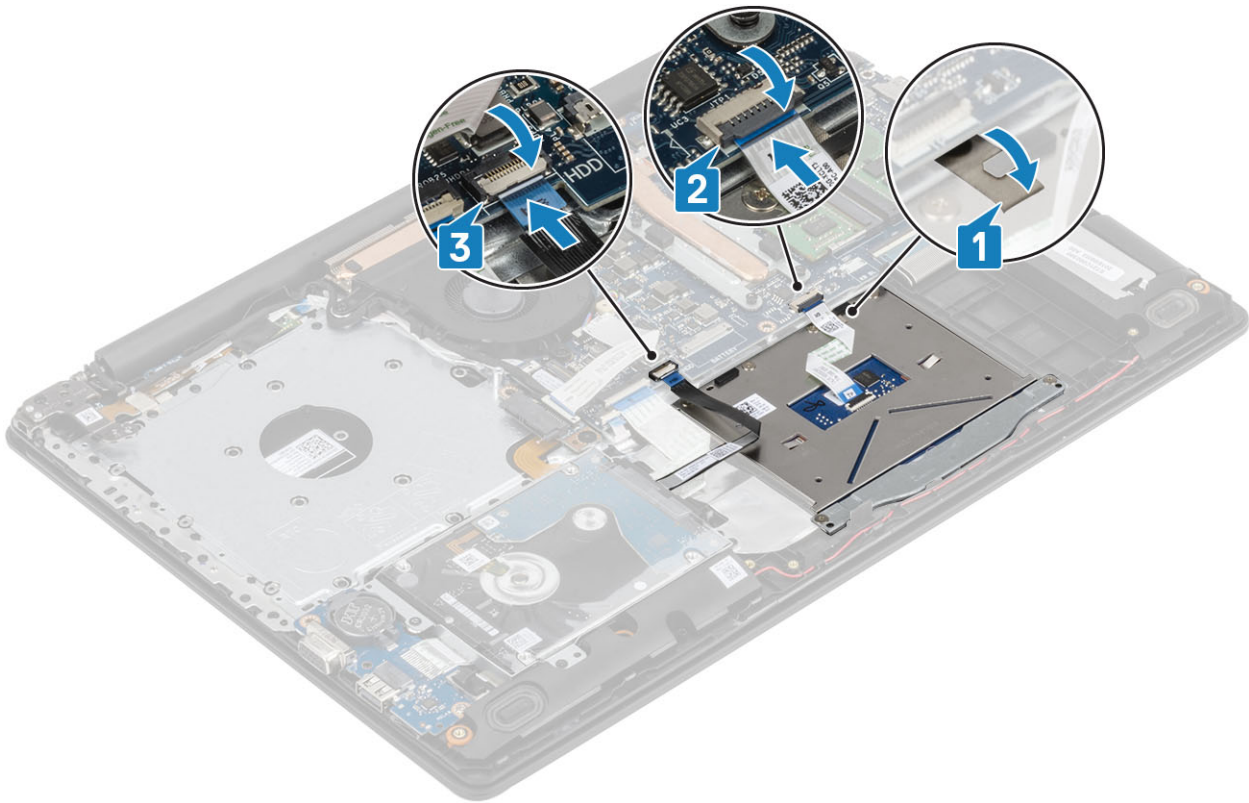

Next steps

1. Replace the [battery](#)
2. Replace the [base cover](#)
3. Replace the [optical drive assembly](#)
4. Replace the [SD memory card](#)
5. Follow the procedure in [after working inside your computer](#)

Display assembly

Removing the display assembly

Prerequisites

1. Follow the procedure in [before working inside your computer](#)
2. Remove the [SD memory card](#)
3. Remove the [optical drive assembly](#)
4. Remove the [base cover](#)
5. Disconnect the battery cable from the connector on the system board
6. Remove the [WLAN](#)

Steps

1. Open the latch and disconnect the optical drive cable and display cable from the system board [1, 2].
2. Peel off the tape securing the wireless antenna from the system board [3].
3. Unroute the display cable from the routing guides on the palmrest and keyboard assembly [4].

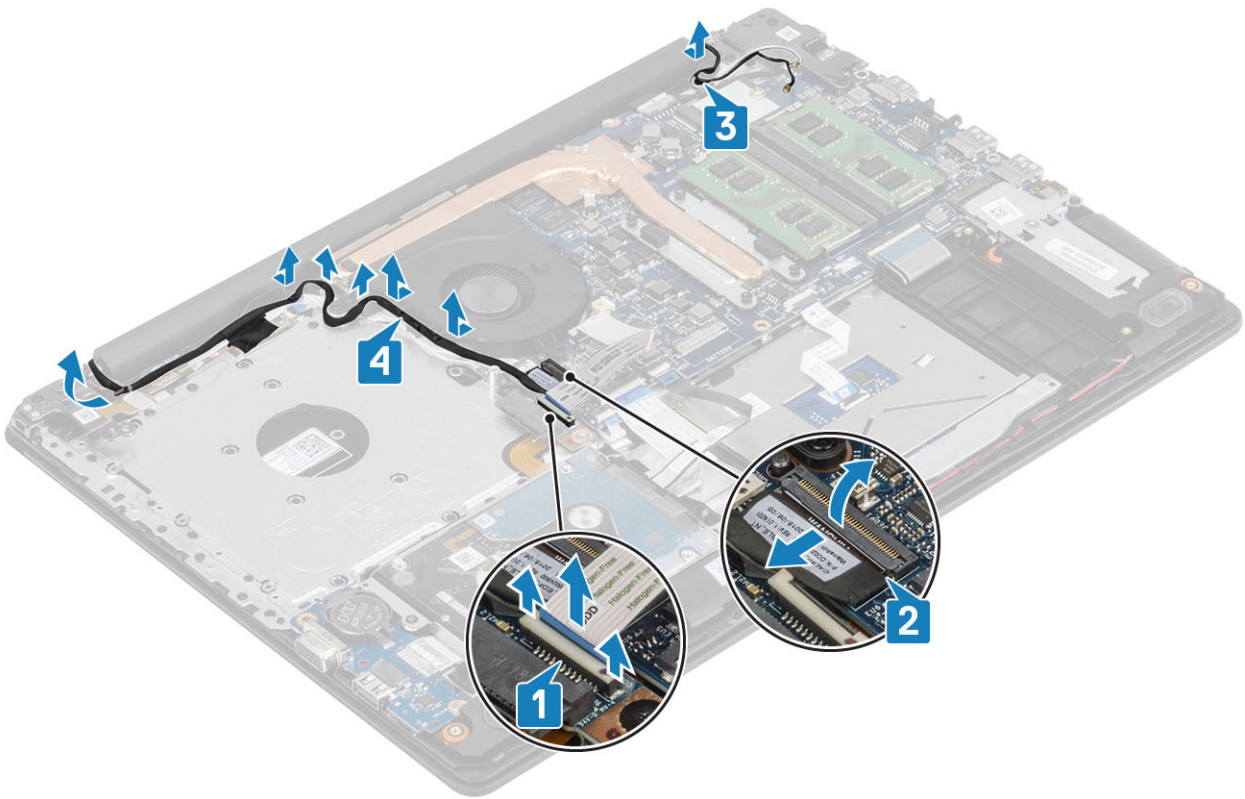

4. Remove the five (M2.5x5) screws that secure the left and right hinges to the system board, and palmrest and keyboard assembly [1].
5. Lift the palmrest and keyboard assembly at an angle [2].

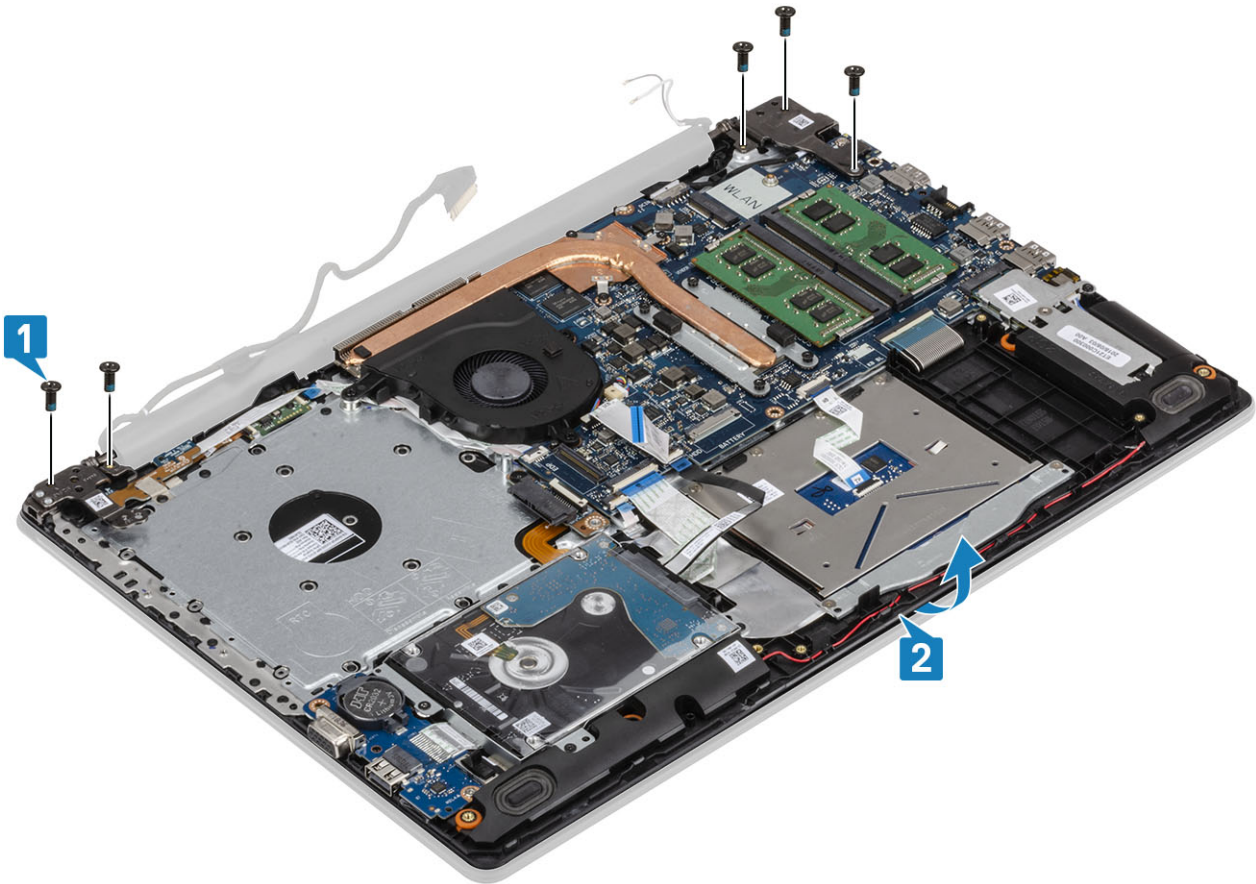

6. Lift the hinges. Remove the palmrest and keyboard assembly off the display assembly [1, 2]

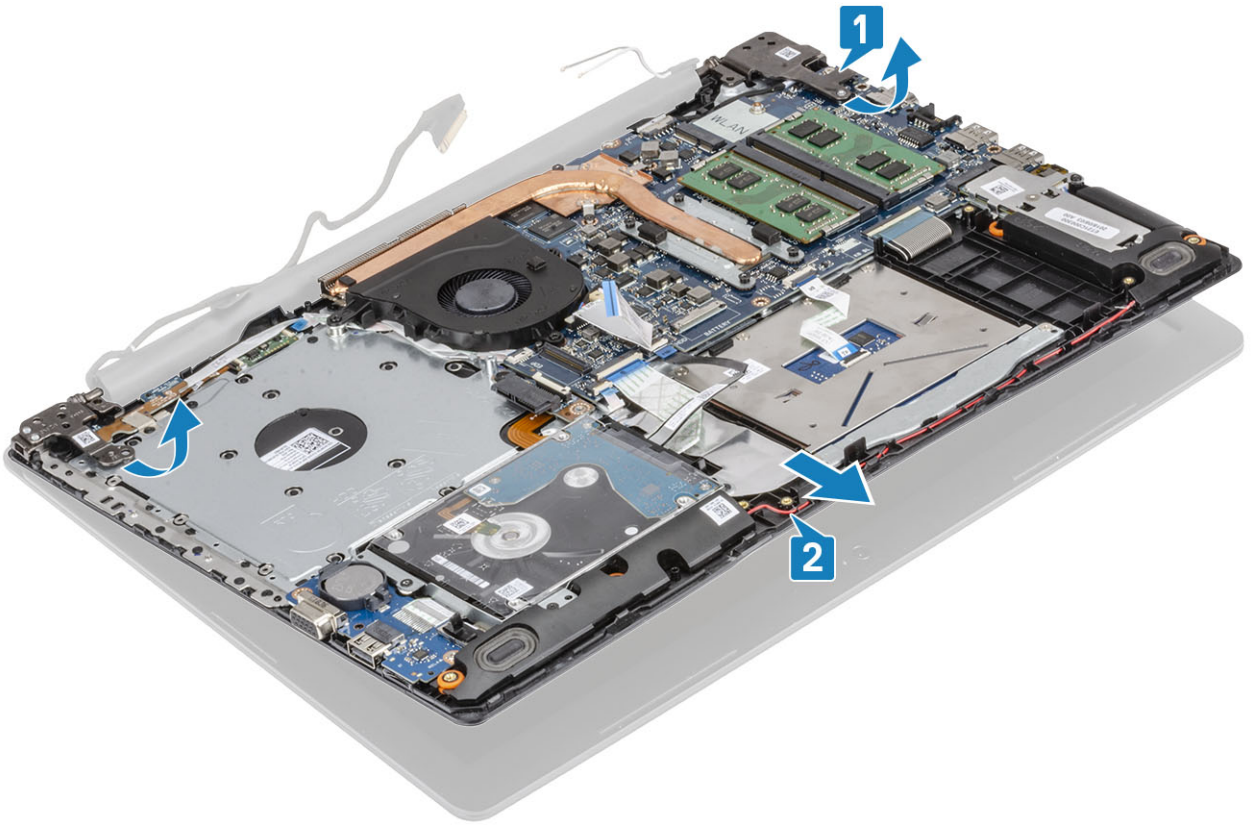

7. After performing all the preceding steps, you are left with display assembly.



Installing the display assembly

About this task

NOTE: Ensure that the hinges are opened to the maximum before replacing the display assembly on the palmrest and keyboard assembly.

Steps

1. Align and place the palmrest and keyboard assembly under the hinges on the display assembly [1].
2. Seat the palmrest and keyboard assembly on the display assembly [2].
3. Press the hinges down on the system board, and palmrest and keyboard assembly [3].

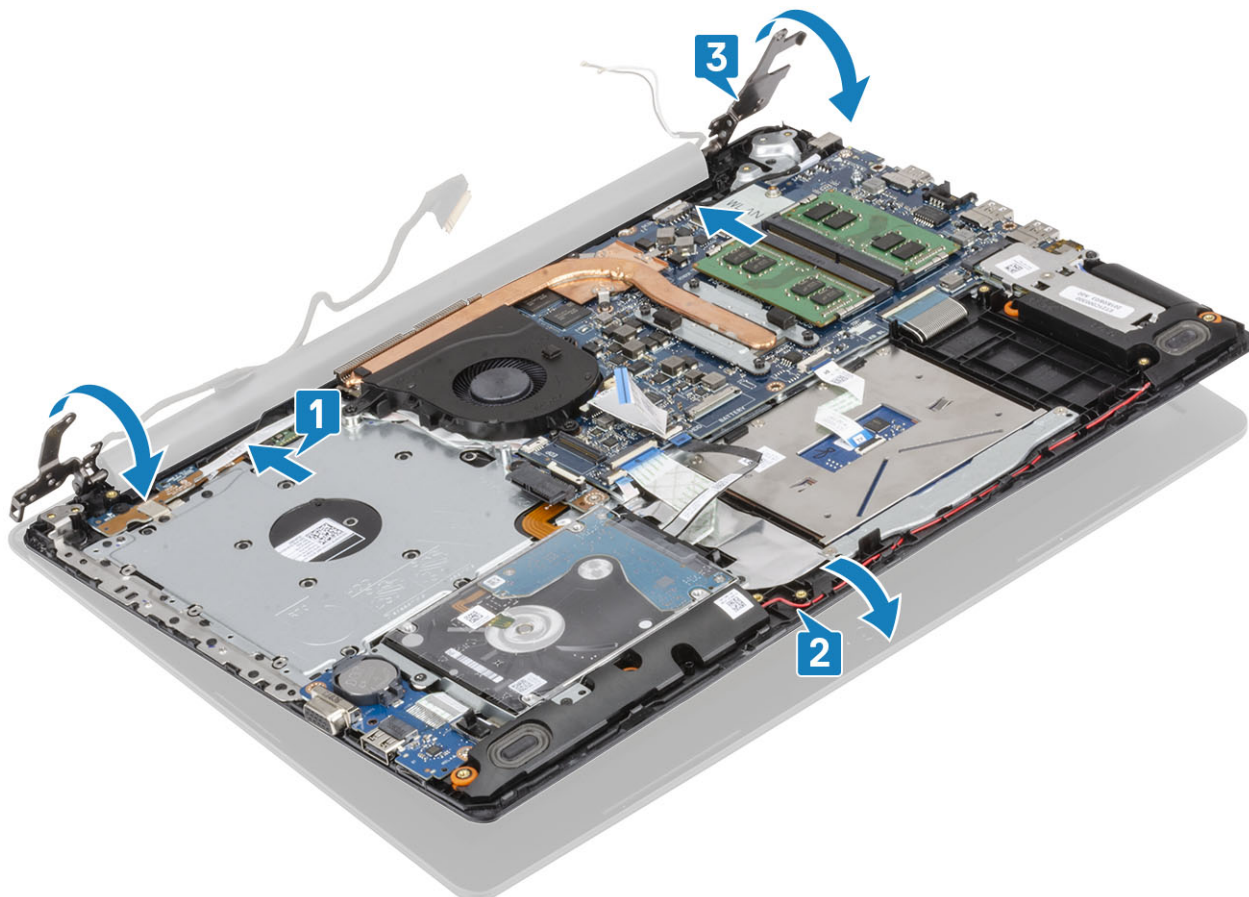

4. Replace the five (M2.5x5) screws that secure the left and right hinges to the system board, and palmrest and keyboard assembly [1].

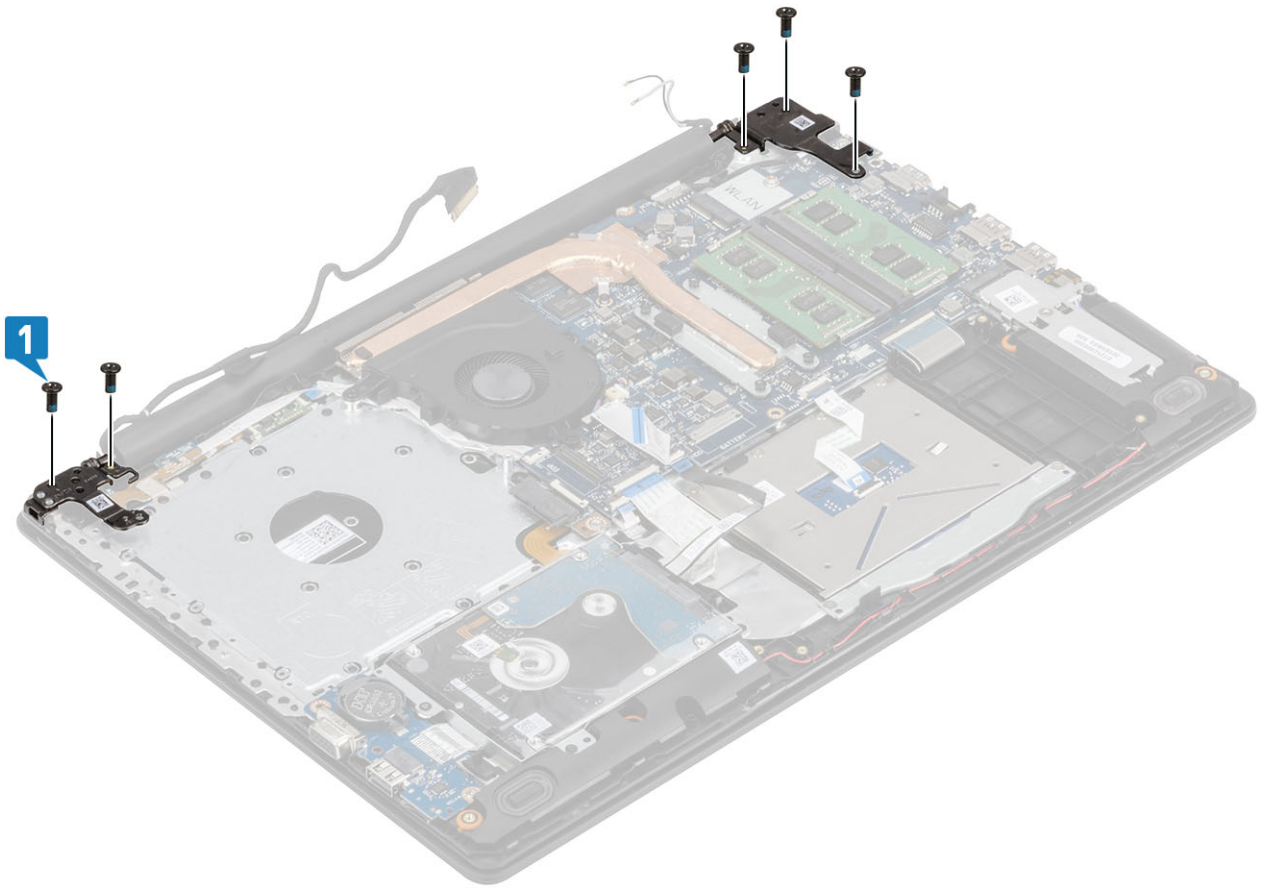

- 5. Route the display cable through the routing guides on the palmrest and keyboard assembly [1].
- 6. Affix the antenna cables to the system board [2].
- 7. Connect the display cable and the optical drive cable to the connector on the system board [3, 4].

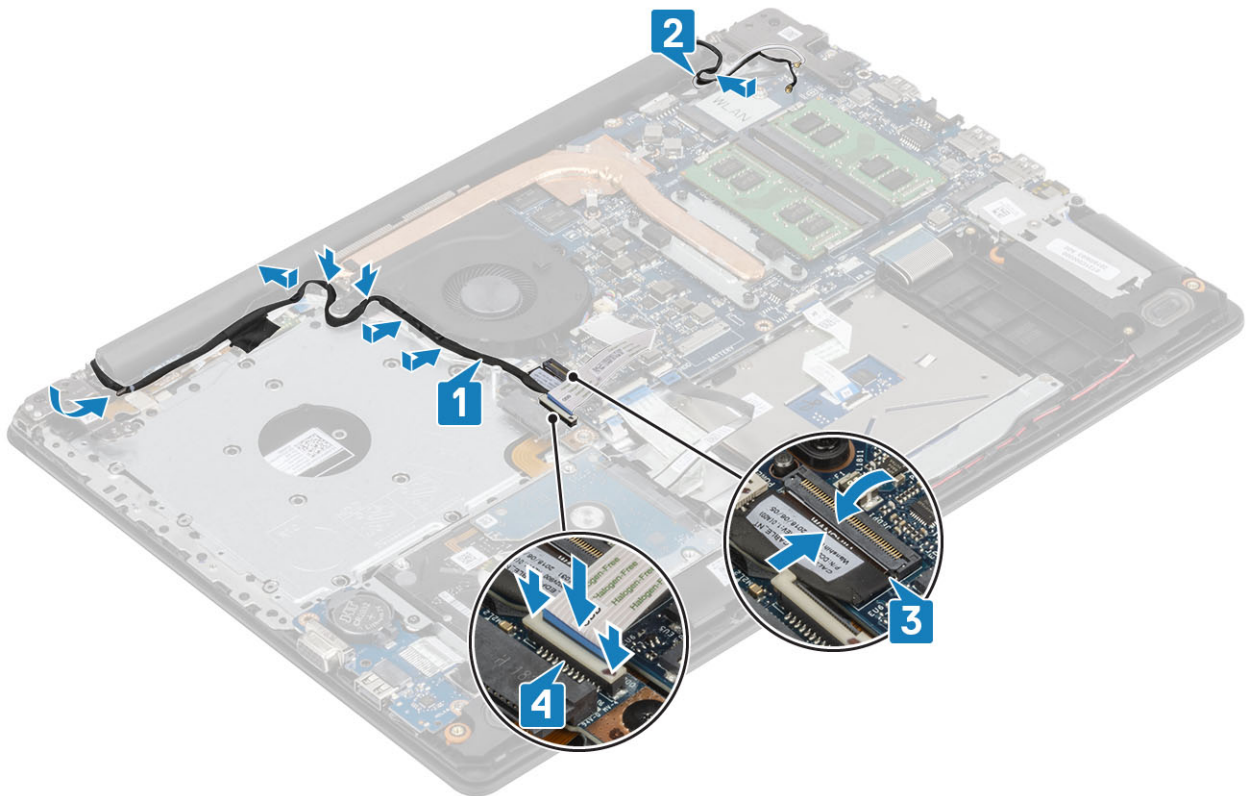

Next steps

1. Replace the [WLAN](#)
2. Connect the battery cable to the connector on the system board.
3. Replace the [base cover](#)
4. Replace the [optical drive assembly](#)
5. Replace the [SD memory card](#)
6. Follow the procedure in [after working inside your computer](#)

Power-button board

Removing the power button board

Prerequisites

1. Follow the procedure in [before working inside your computer](#)
2. Remove the [SD memory card](#)
3. Remove the [optical drive assembly](#)
4. Remove the [base cover](#)
5. Disconnect the battery cable from the connector on the system board.
6. Remove the [WLAN](#)
7. Remove the [system fan](#)
8. Remove the [display assembly](#)

Steps

1. Open the latch and disconnect the power button board cable from the system [1].
2. Peel the conductive tape off the power button board [2].
3. Remove the single (M2x2) screw that secures the power button board to the palmrest and keyboard assembly [3].
4. Lift the power button board, along with the cable off the palmrest and keyboard assembly [4].

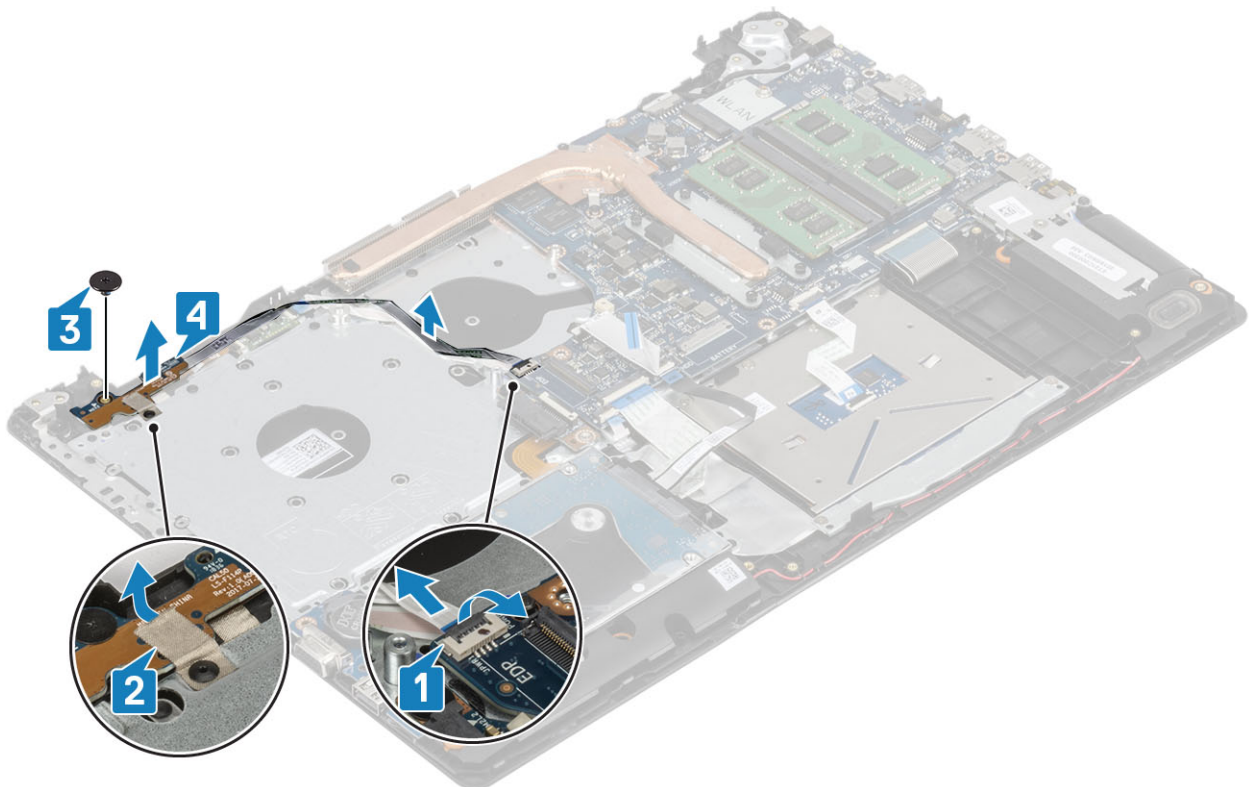

Installing the power button board

Steps

1. Place the power-button board into the slot on the palmrest and keyboard assembly [1].
2. Replace the single (M2x2) screw that secures the power button board to the palmrest and keyboard assembly [2].
3. Affix the conductive tape to the power button board [3].
4. Slide the power button cable to the system board and close the latch to secure the cable [4].

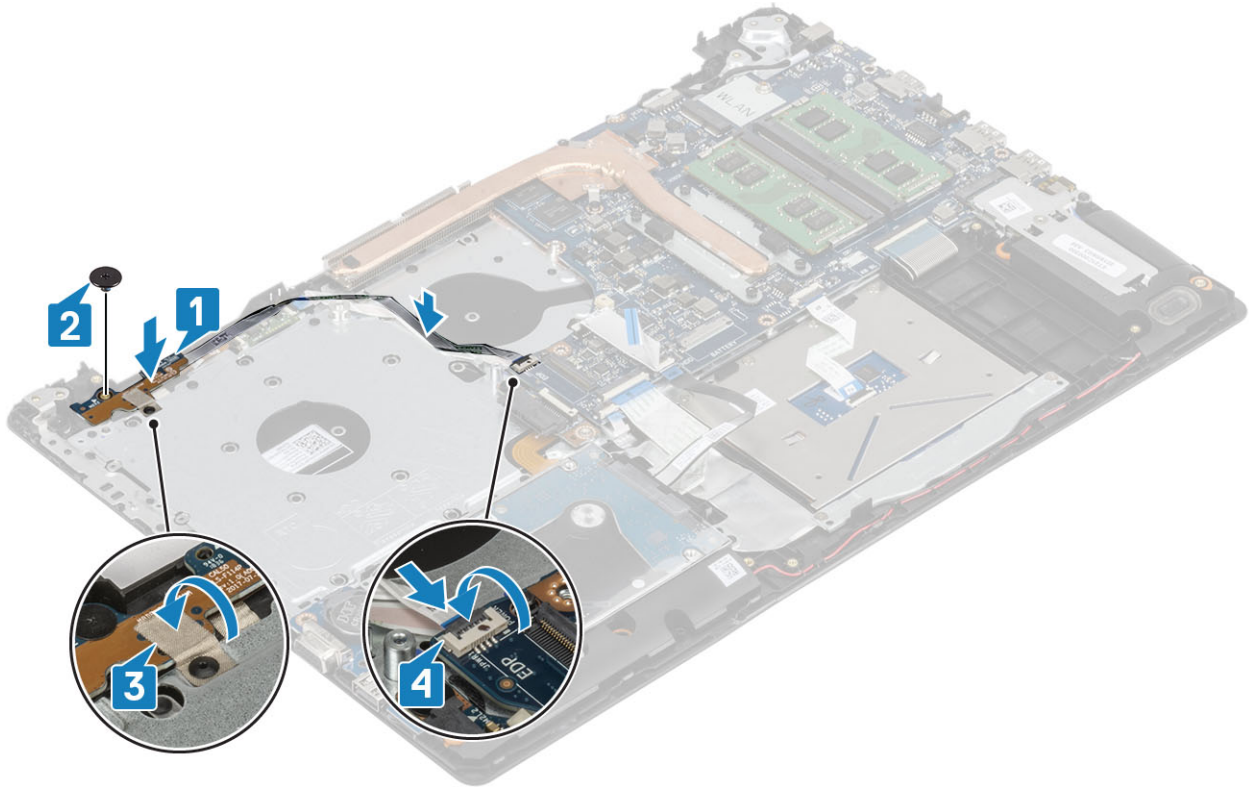

Next steps

1. Replace the [display assembly](#)
2. Replace the [system fan](#)
3. Replace the [WLAN](#)
4. Connect the battery cable to the connector on the system board.
5. Replace the [base cover](#)
6. Replace the [optical drive assembly](#)
7. Replace the [SD memory card](#)
8. Follow the procedure in [after working inside your computer](#)

System board

Removing the system board

Prerequisites

1. Follow the procedure in [before working inside your computer](#)
2. Remove the [SD memory card](#)
3. Remove the [base cover](#)
4. Remove the [battery](#)

5. Remove the [memory](#)
6. Remove the [WLAN](#)
7. Remove the [SSD](#)
8. Remove the [system fan](#)
9. Remove the [heatsink](#)
10. Remove the [display assembly](#)

Steps

1. Disconnect the power adapter port cable, optical drive cable and speaker cable from the system board [1, 2, 3].

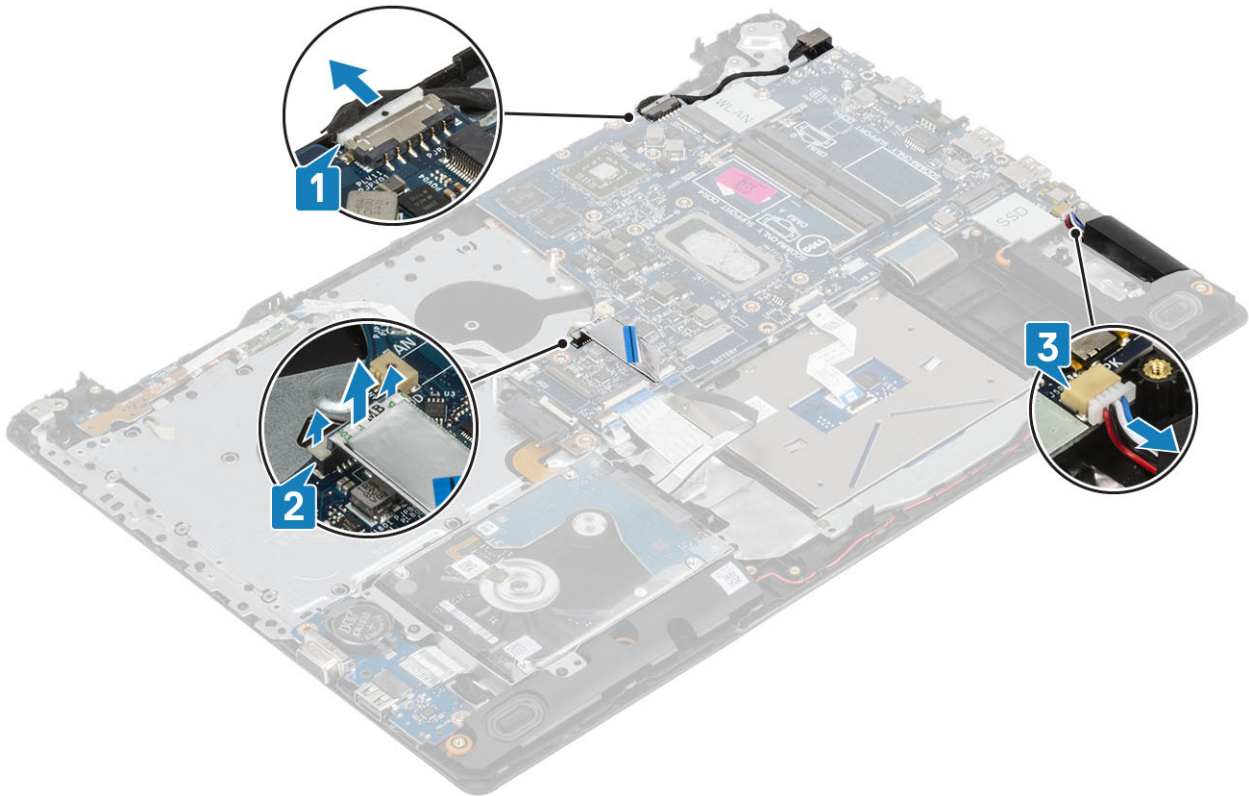

2. Remove the single (M2x2) screw that secures the optical drive connector to the system board [1].
3. Lift the optical drive connector [2].

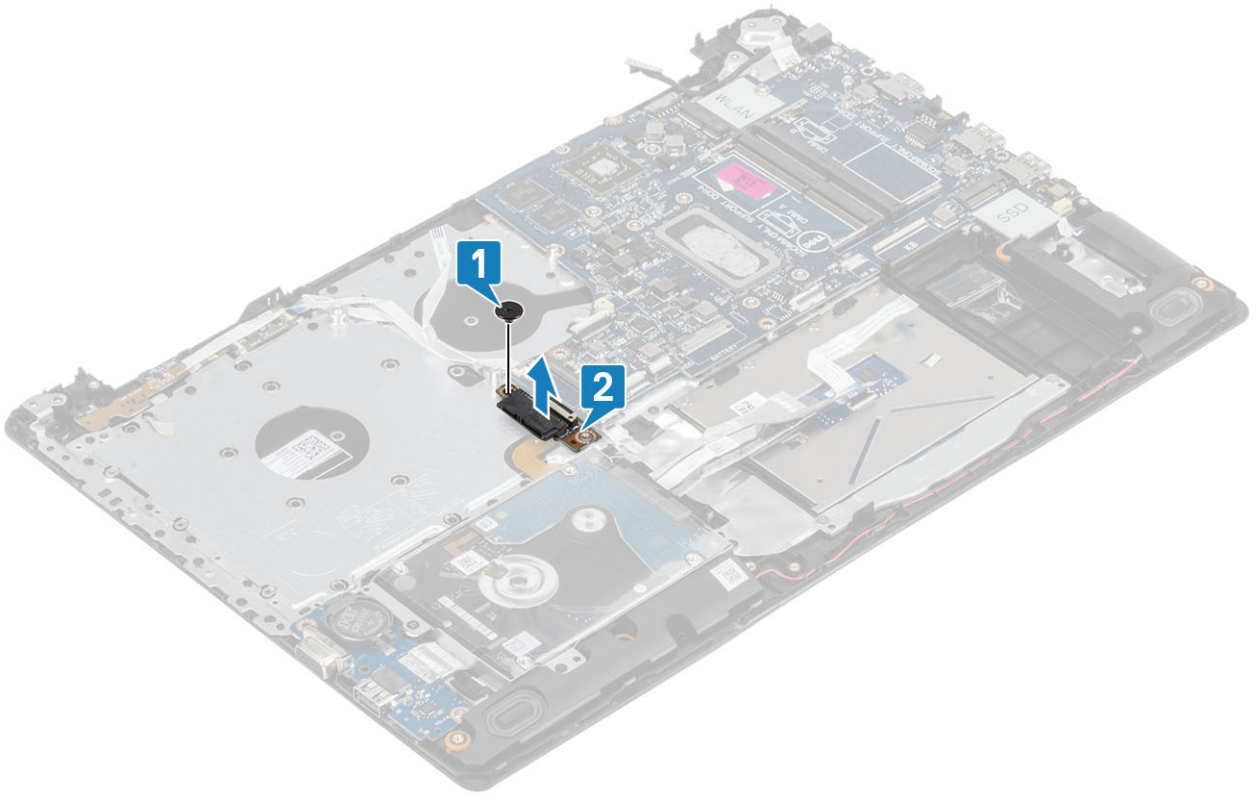

4. Disconnect the following cables from the system board:
- a) Power button board cable [1].
 - b) Finger print board cable [2].
 - c) IO board cable [3].
 - d) Hard drive cable [4].
 - e) Touchpad cable [5].
 - f) Keyboard cable [6].

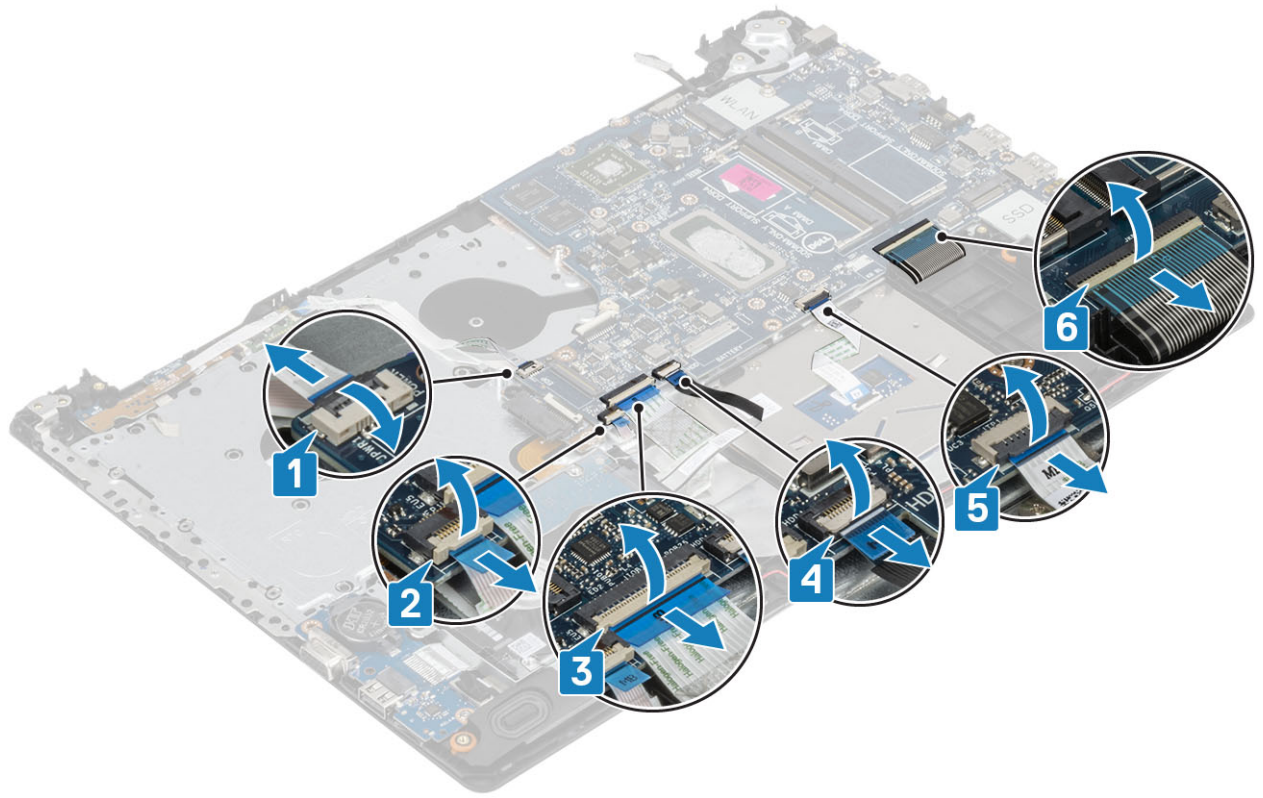

5. Remove the single (M2x4) screw that secures the system board to the palmrest and keyboard assembly [1].
6. Flip the system board off the palmrest and keyboard assembly [2].

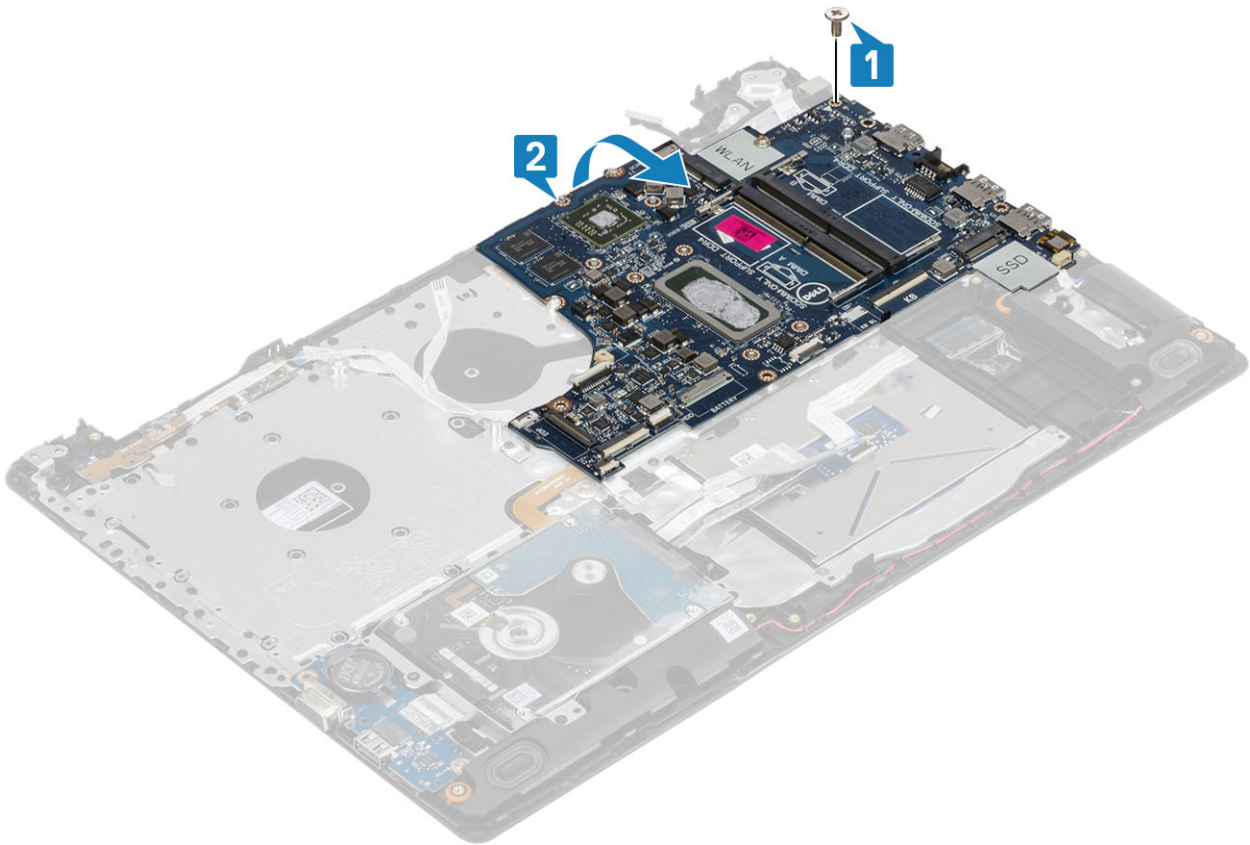

7. Disconnect the VGA daughterboard cable from the system board [1].
8. Lift the system board off the palmrest and keyboard assembly [2].

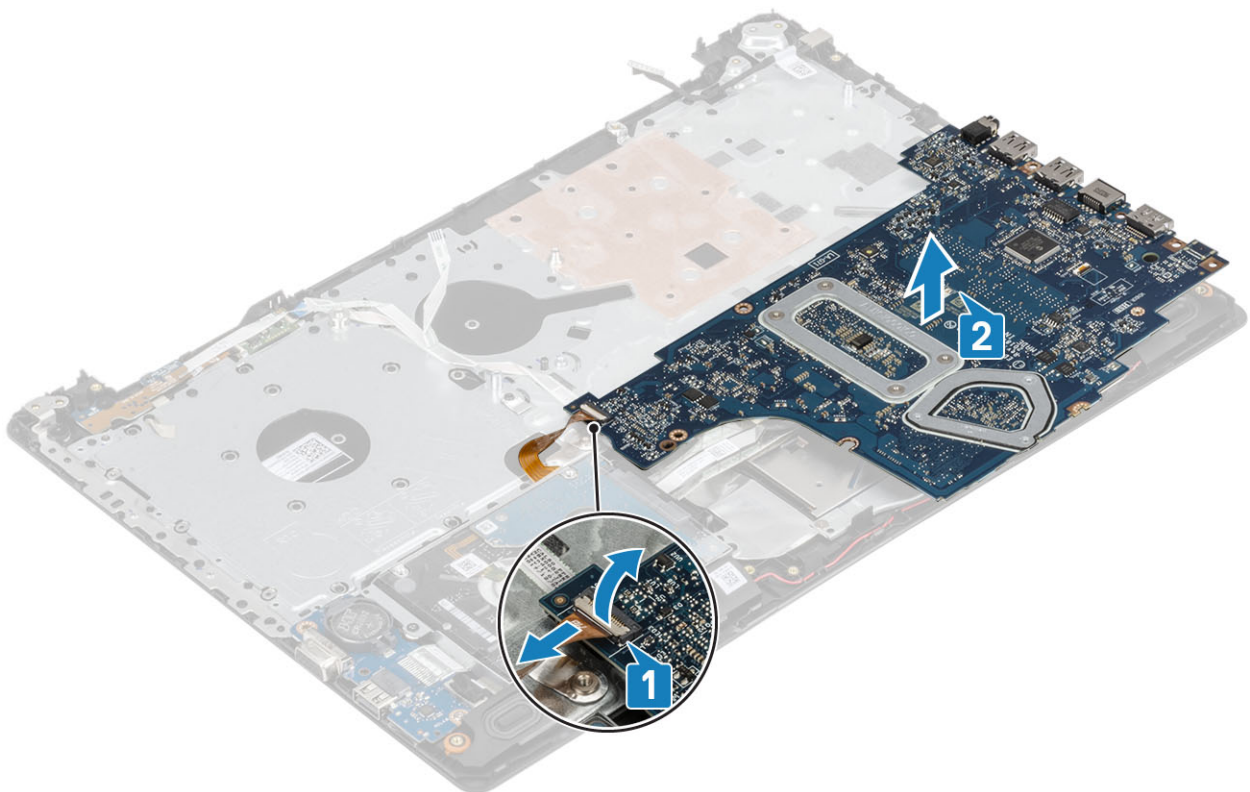

Installing the system board

Steps

1. Place the system board on the palmrest and keyboard assembly [1].
2. Connect the VGA daughterboard cable to the system board [2].
3. Flip the system board on the palmrest and keyboard assembly [3].

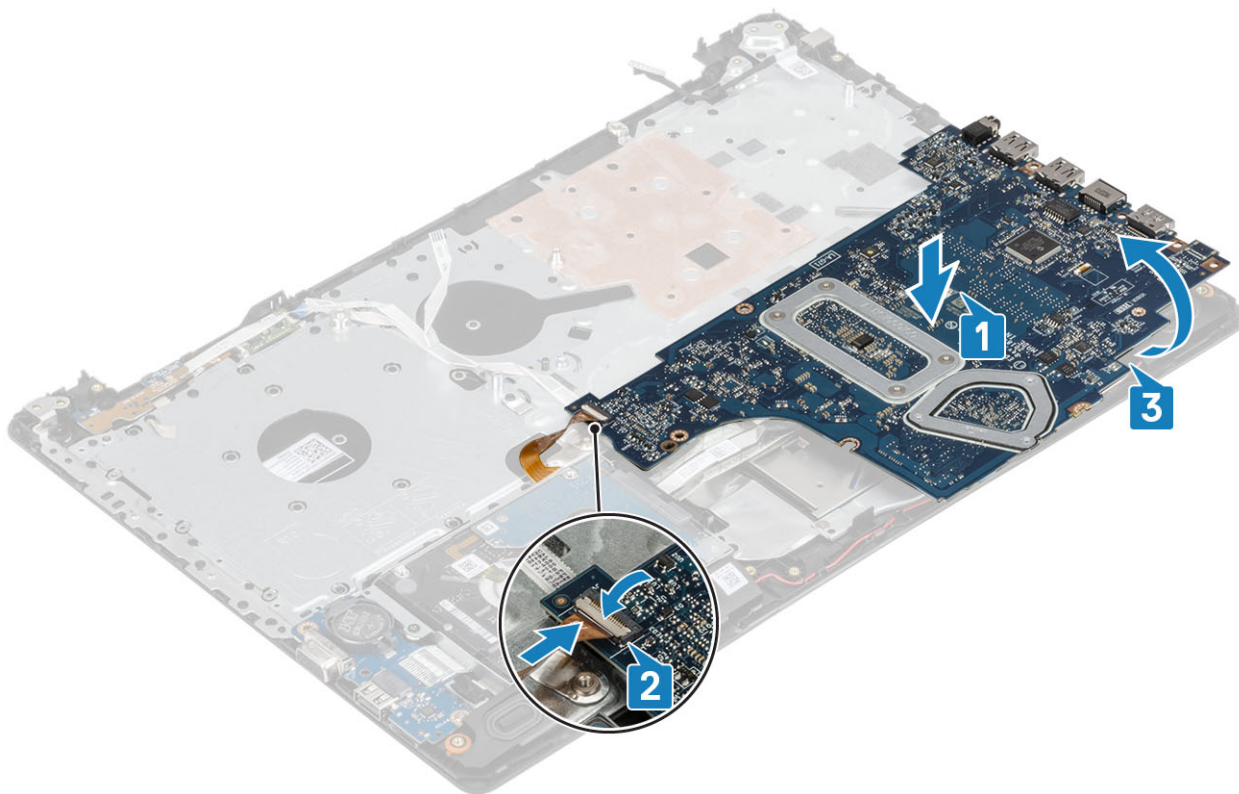

4. Align the screw hole on the system board with the screw hole on the palmrest and keyboard assembly.
5. Replace the single (M2x4) screw that secures the system board to the palmrest and keyboard assembly [1].



6. Place the optical drive connector and replace the single (M2x2) screw that secures it to the system board [1, 2].

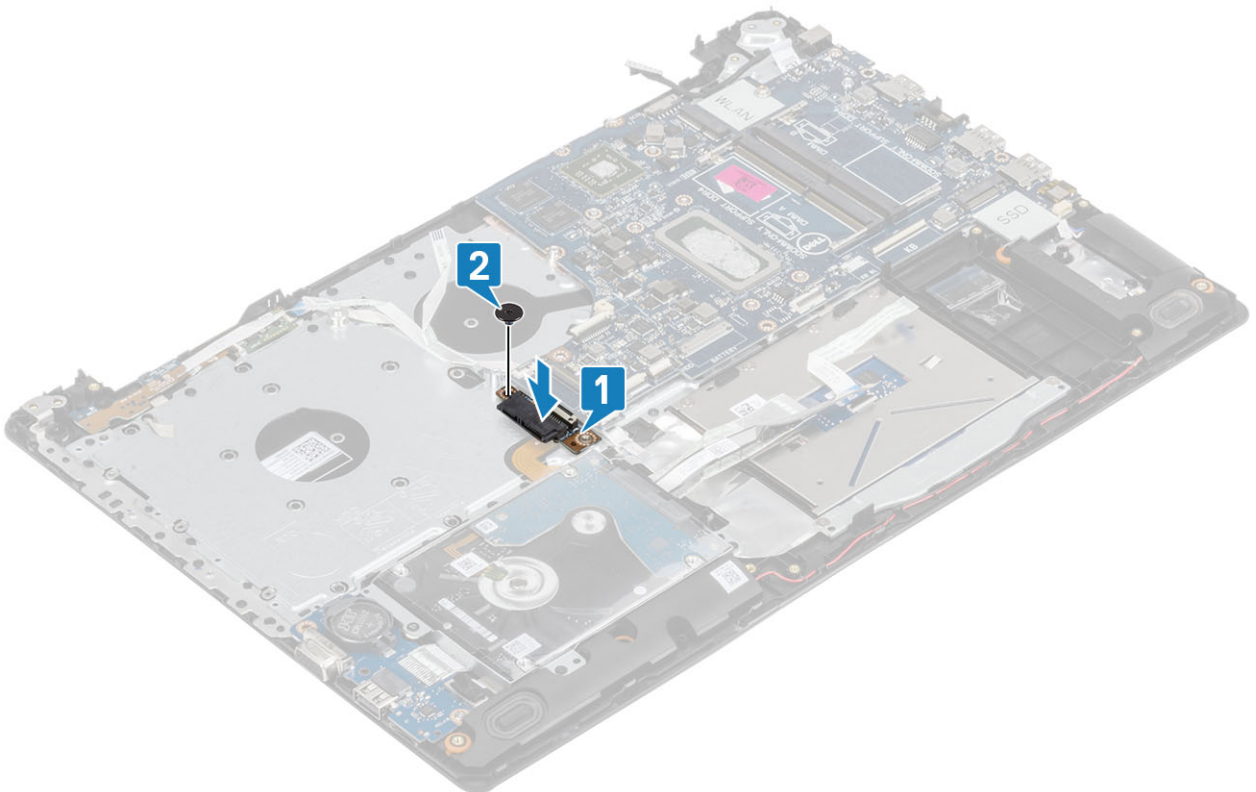

7. Connect the following cables to the system board:

- a) Power button board cable [1].
- b) Finger print board cable [2].
- c) IO board cable [3].

- d) Hard drive cable [4].
- e) Touchpad cable [5].
- f) Keyboard cable [6].

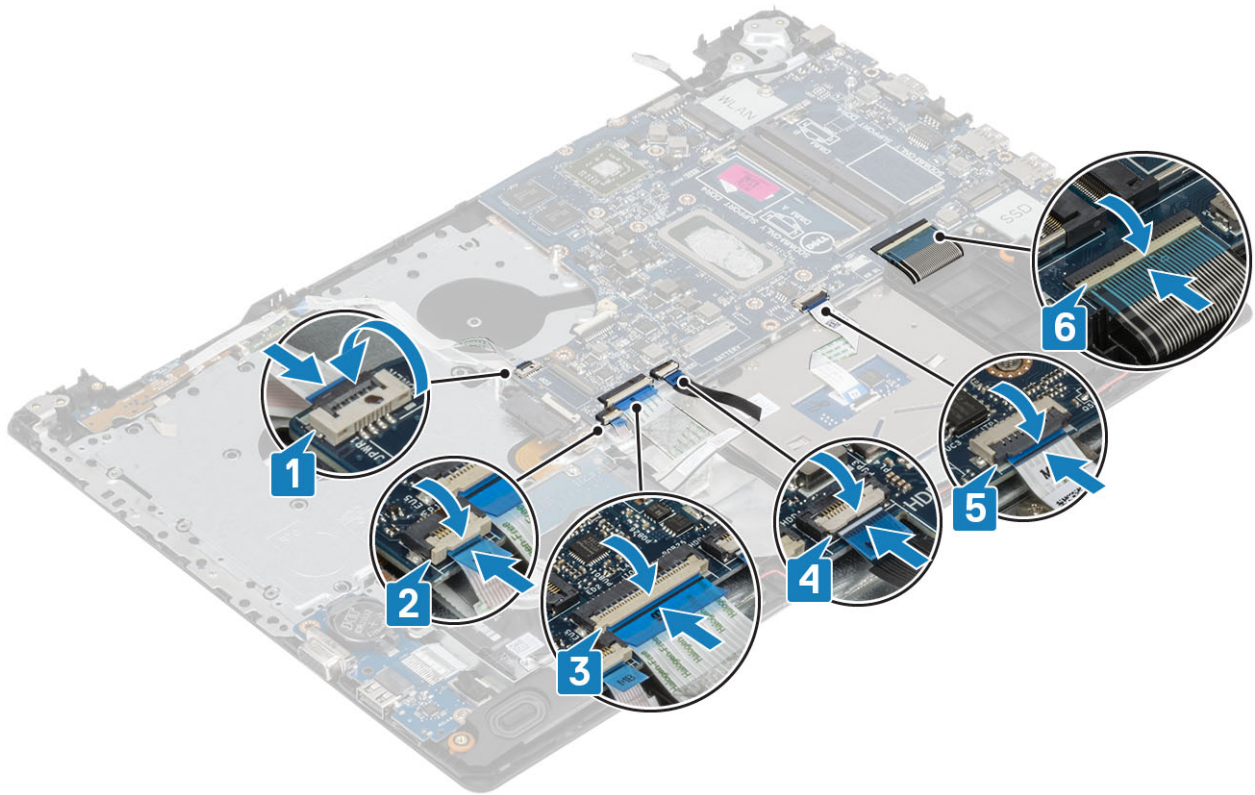

8. Connect the power adapter port cable, optical drive cable and speaker cable to the system board [1, 2, 3].

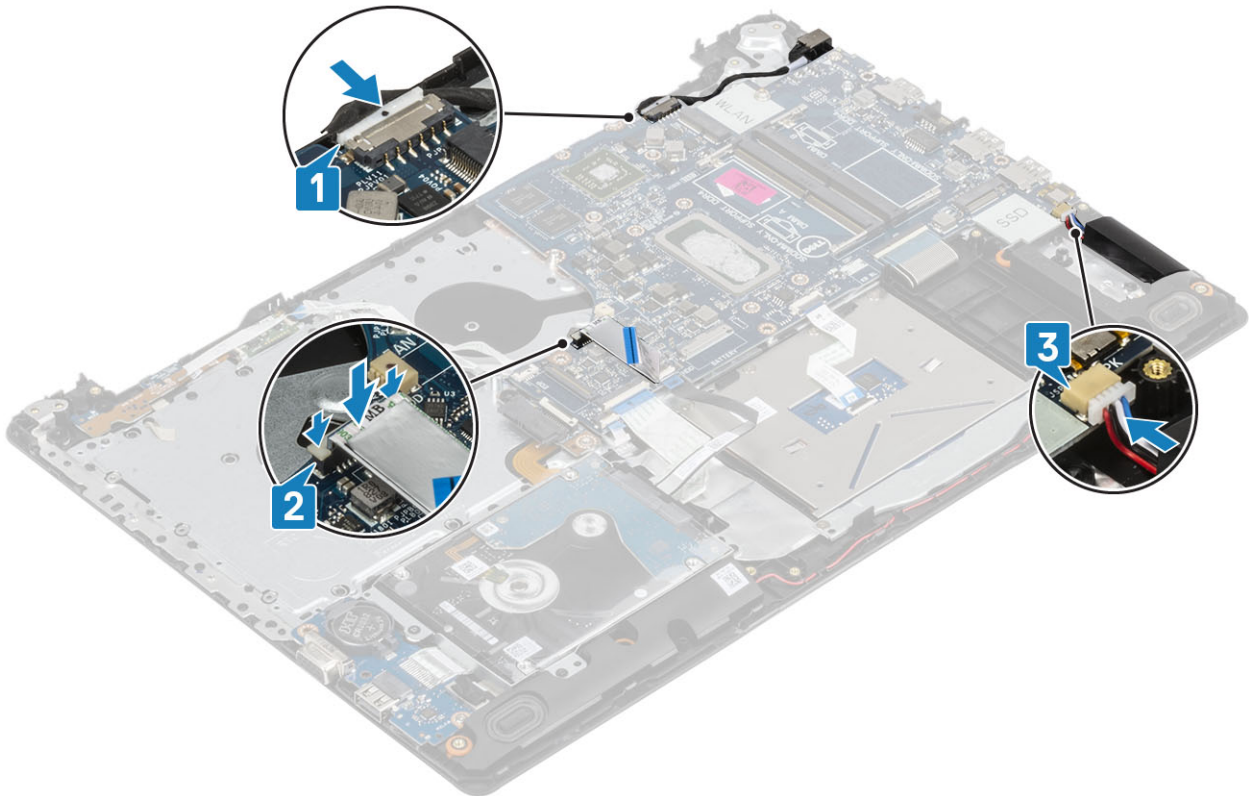

Next steps

1. Replace the [display assembly](#)
2. Replace the [heatsink](#)
3. Replace the [system fan](#)
4. Replace the [SSD](#)
5. Replace the [WLAN](#)
6. Replace the [memory](#)
7. Replace the [battery](#)
8. Replace the [base cover](#)
9. Replace the [SD memory card](#)
10. Follow the procedure in [after working inside your computer](#)

Power button

Removing the power button with fingerprint reader

Prerequisites

1. Follow the procedure in [before working inside your computer](#)
2. Remove the [SD memory card](#)
3. Remove the [optical drive assembly](#)
4. Remove the [base cover](#)
5. Remove the [battery](#)
6. Remove the [WLAN](#)
7. Remove the [SSD](#)
8. Remove the [system fan](#)
9. Remove the [heatsink](#)
10. Remove the [display assembly](#)
11. Remove the [power button board](#)
12. Remove the [system board](#)

Steps

1. Remove the single (M2x2) screw that secures the power button on the palmrest and keyboard assembly [1].
2. Lift the power button with fingerprint reader board off the palmrest and keyboard assembly [2].
3. Peel the fingerprint reader cable off the palmrest and keyboard assembly.

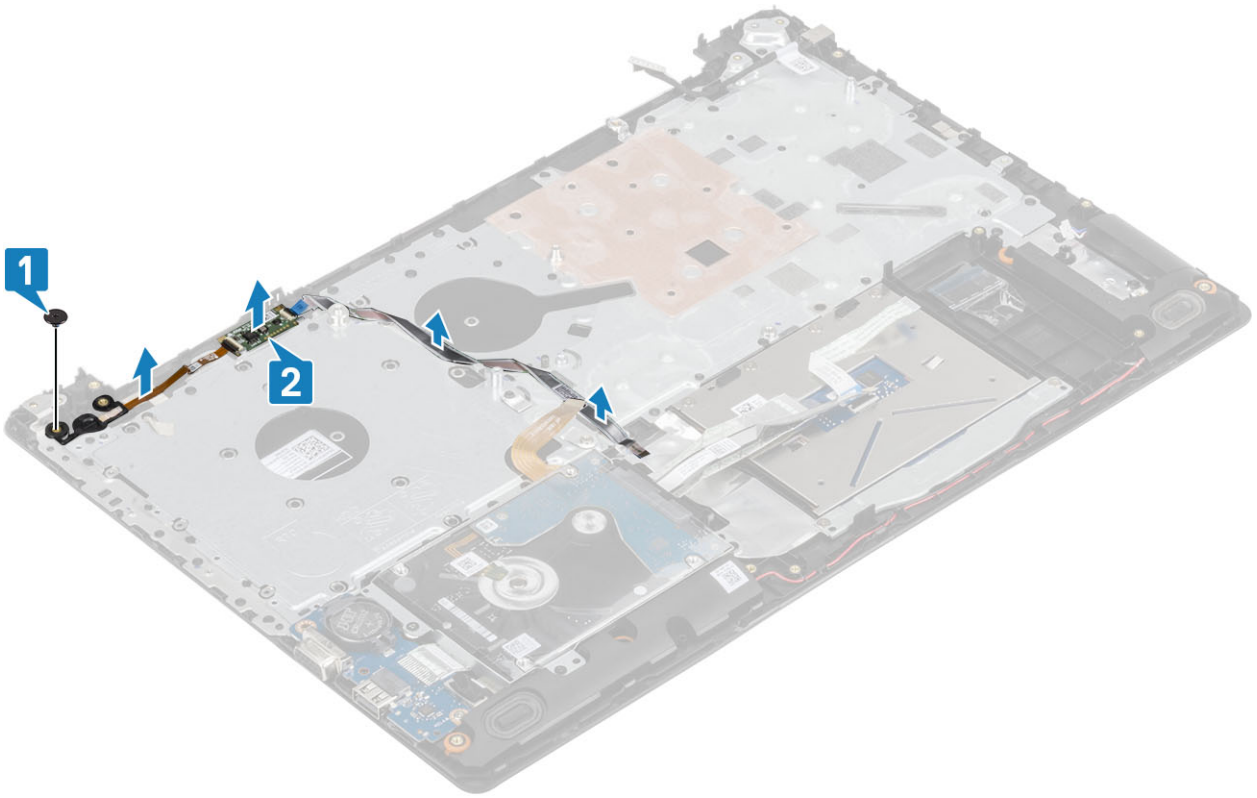

Installing the power button with fingerprint reader

Steps

1. Affix the fingerprint reader cable on the palm rest and keyboard assembly.
2. Using the alignment posts, align and place the power button on the palmrest and keyboard assembly [1].
3. Replace the single (M2x2) screw that secures the power button on the palmrest and keyboard assembly [2].

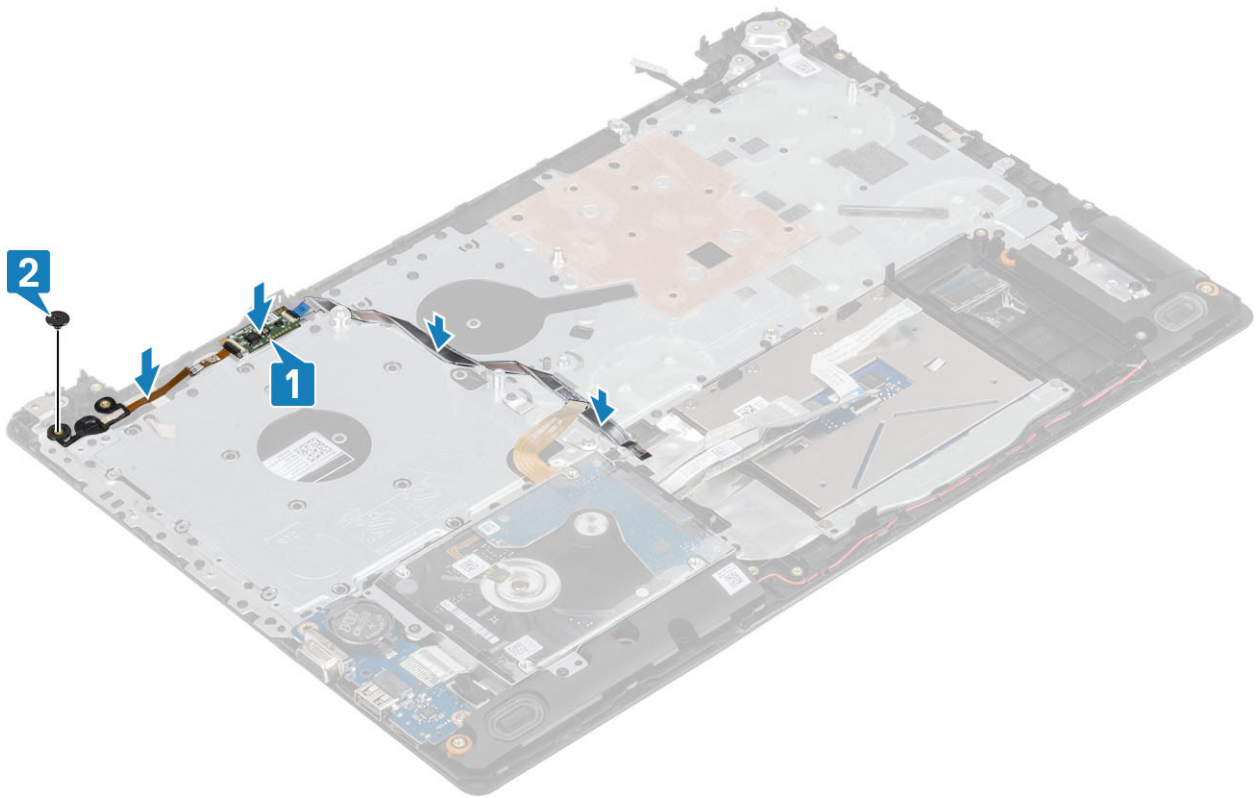

Next steps

1. Replace the [system board](#)
2. Replace the [power button board](#)
3. Replace the [display assembly](#)
4. Replace the [heatsink](#)
5. Replace the [system fan](#)
6. Replace the [SSD](#)
7. Replace the [WLAN](#)
8. Replace the [battery](#)
9. Replace the [base cover](#)
10. Replace the [optical drive assembly](#)
11. Replace the [SD memory card](#)
12. Follow the procedure in [after working inside your computer](#)

Power-adapter port

Removing the power adapter port

Prerequisites

1. Follow the procedure in [before working inside your computer](#)
2. Remove the [SD memory card](#)
3. Remove the [optical drive assembly](#)
4. Remove the [base cover](#)
5. Remove the [battery](#)
6. Remove the [WLAN](#)
7. Remove the [SSD](#)
8. Remove the [display assembly](#)
9. Remove the [power button board](#)

Steps

1. Disconnect and route the power adapter cable from the system board [1, 2].
2. Remove the single (M2x3) screw that secures the power adapter port to the palmrest and keyboard assembly [3].
3. Lift the power adapter port, along with its cable, off the palmrest and keyboard assembly [4].

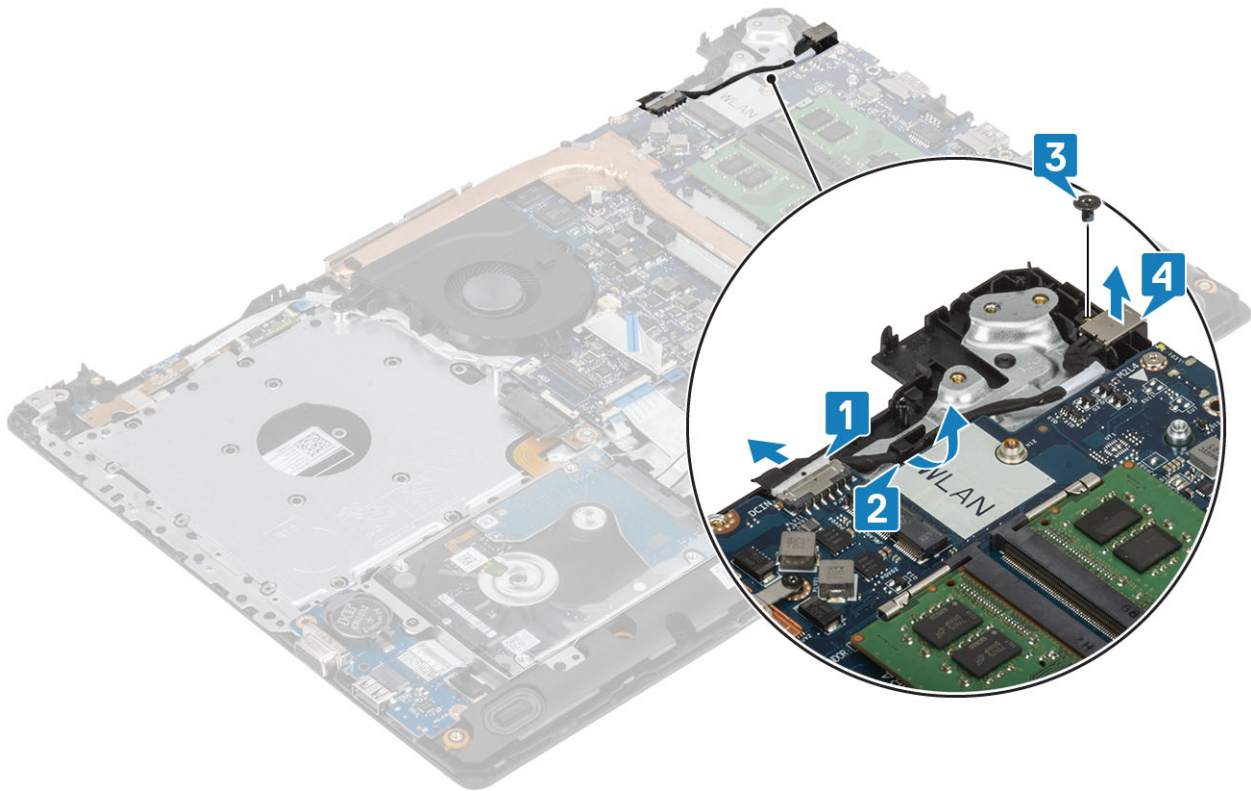

Installing the power adapter port

Steps

1. Place the power adapter port into the slot on the palmrest and keyboard assembly [1].
2. Replace the single (M2x3) screw that secures the power adapter port to the palmrest and keyboard assembly [2].
3. Route the power adapter cable through the routing channels [3].
4. Connect the power adapter cable to the system board [4].

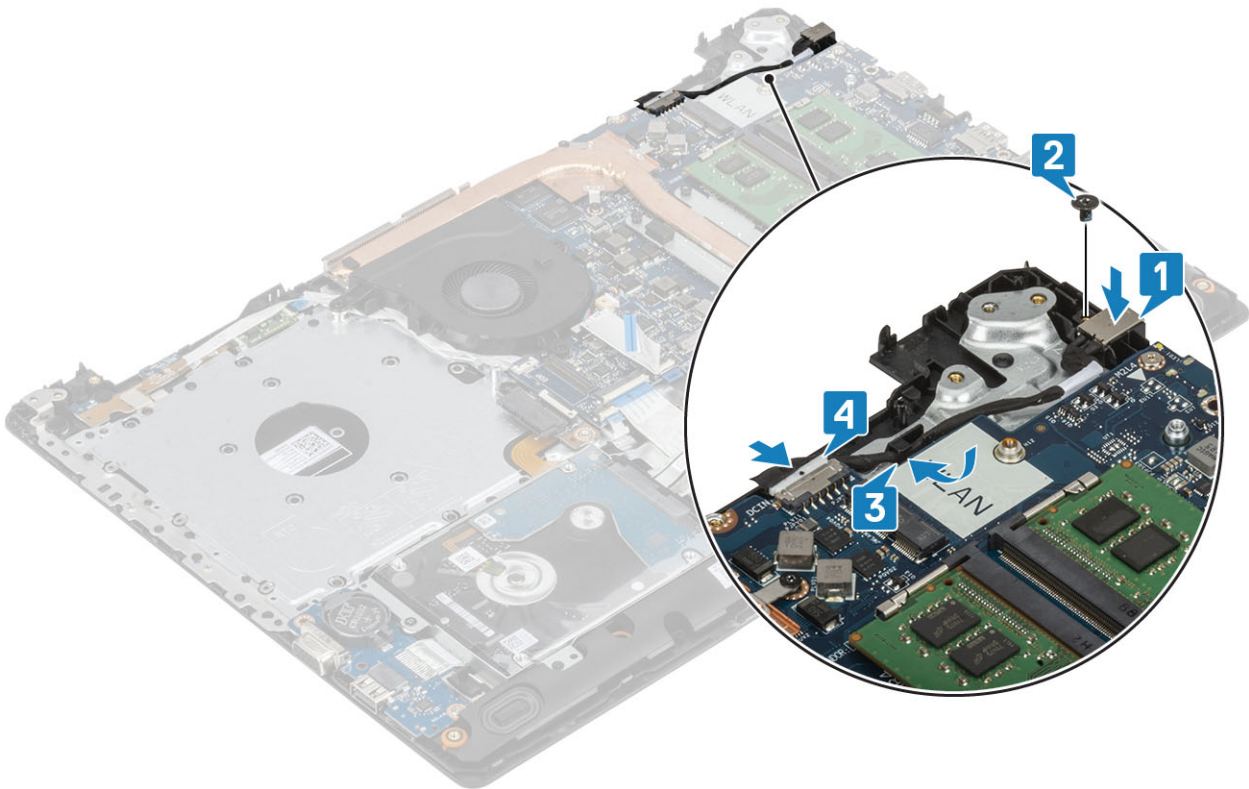

Next steps

1. Replace the [power button board](#)
2. Replace the [display assembly](#)
3. Replace the [SSD](#)
4. Replace the [WLAN](#)
5. Replace the [battery](#)
6. Replace the [base cover](#)
7. Replace the [optical drive assembly](#)
8. Replace the [SD memory card](#)
9. Follow the procedure in [after working inside your computer](#)

Display bezel

Removing the display bezel

Prerequisites

1. Follow the procedure in [before working inside your computer](#)
2. Remove the [SD memory card](#)
3. Remove the [optical drive assembly](#)
4. Remove the [base cover](#)
5. Disconnect the battery cable from the connector on the system board
6. Remove the [memory](#)
7. Remove the [WLAN](#)
8. Remove the [SSD](#)
9. Remove the [hard drive assembly](#)
10. Remove the [system fan](#)
11. Remove the [heatsink](#)
12. Remove the [display assembly](#)

Steps

1. Pry the inner top side of the display bezel [1].
2. Continue to pry the inner left and inner right edges of the display bezel [2].
3. Pry up the bottom inner edge of the display bezel and lift the bezel off the display assembly [3].

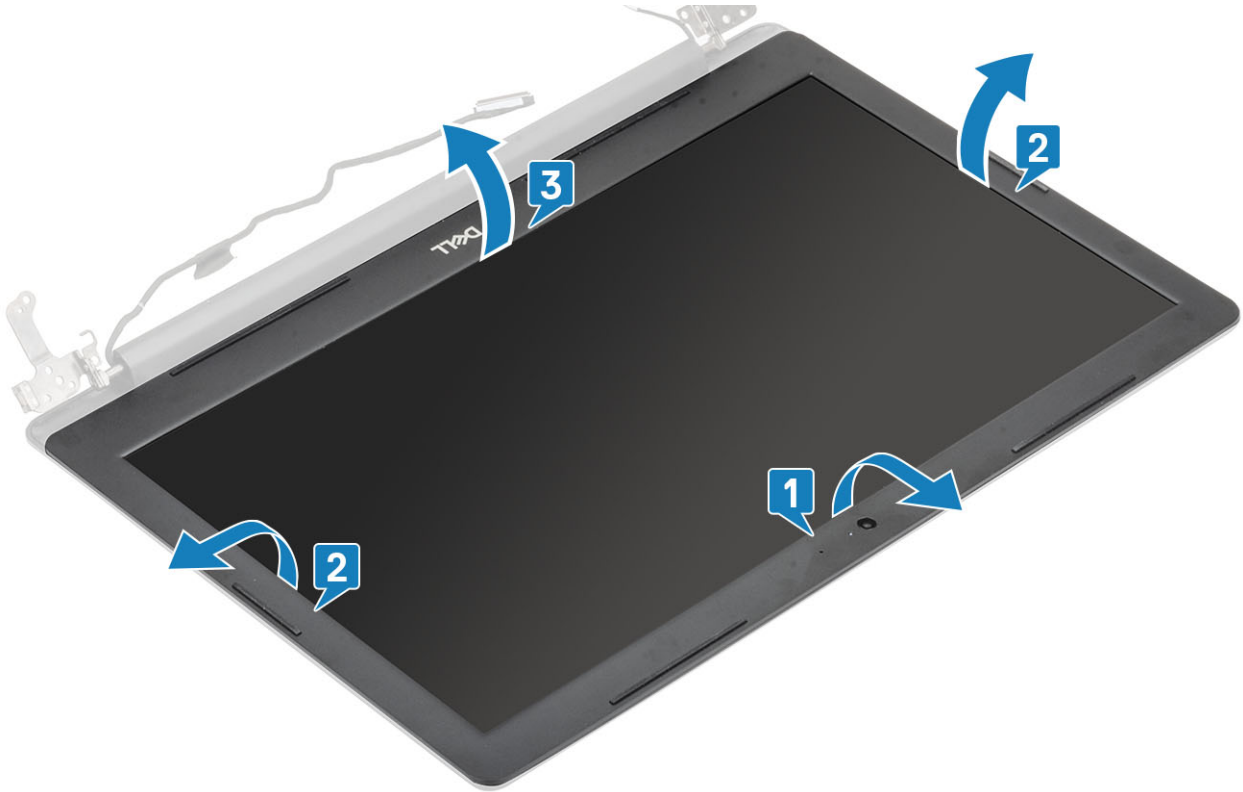

Installing the display bezel

Steps

Align the display bezel with the display back-cover and antenna assembly, and then gently snap the display bezel into place [1].



Next steps

1. Replace the [display assembly](#)
2. Replace the [hard drive assembly](#)
3. Replace the [system fan](#)
4. Replace the [heatsink](#)
5. Replace the [SSD](#)
6. Replace the [WLAN](#)
7. Replace the [memory](#)
8. Connect the battery cable to the connector on the system board.
9. Replace the [base cover](#)
10. Replace the [optical drive assembly](#)
11. Replace the [SD memory card](#)
12. Follow the procedure in [after working inside your computer](#)

Camera

Removing the camera

Prerequisites

1. Follow the procedure in [before working inside your computer](#)
2. Remove the [SD memory card](#)
3. Remove the [optical drive assembly](#)
4. Remove the [base cover](#)
5. Remove the [battery](#)
6. Remove the [WLAN](#)
7. Remove the [SSD](#)
8. Remove the [hard drive assembly](#)
9. Remove the [system fan](#)

10. Remove the [heatsink](#)
11. Remove the [display assembly](#)
12. Remove the [display bezel](#)

Steps

1. Using a plastic scribe, gently pry the camera off the display back-cover and antenna assembly [1].
2. Disconnect the camera cable from the camera module [2].
3. Lift the camera module from the display back-cover and antenna assembly [3].

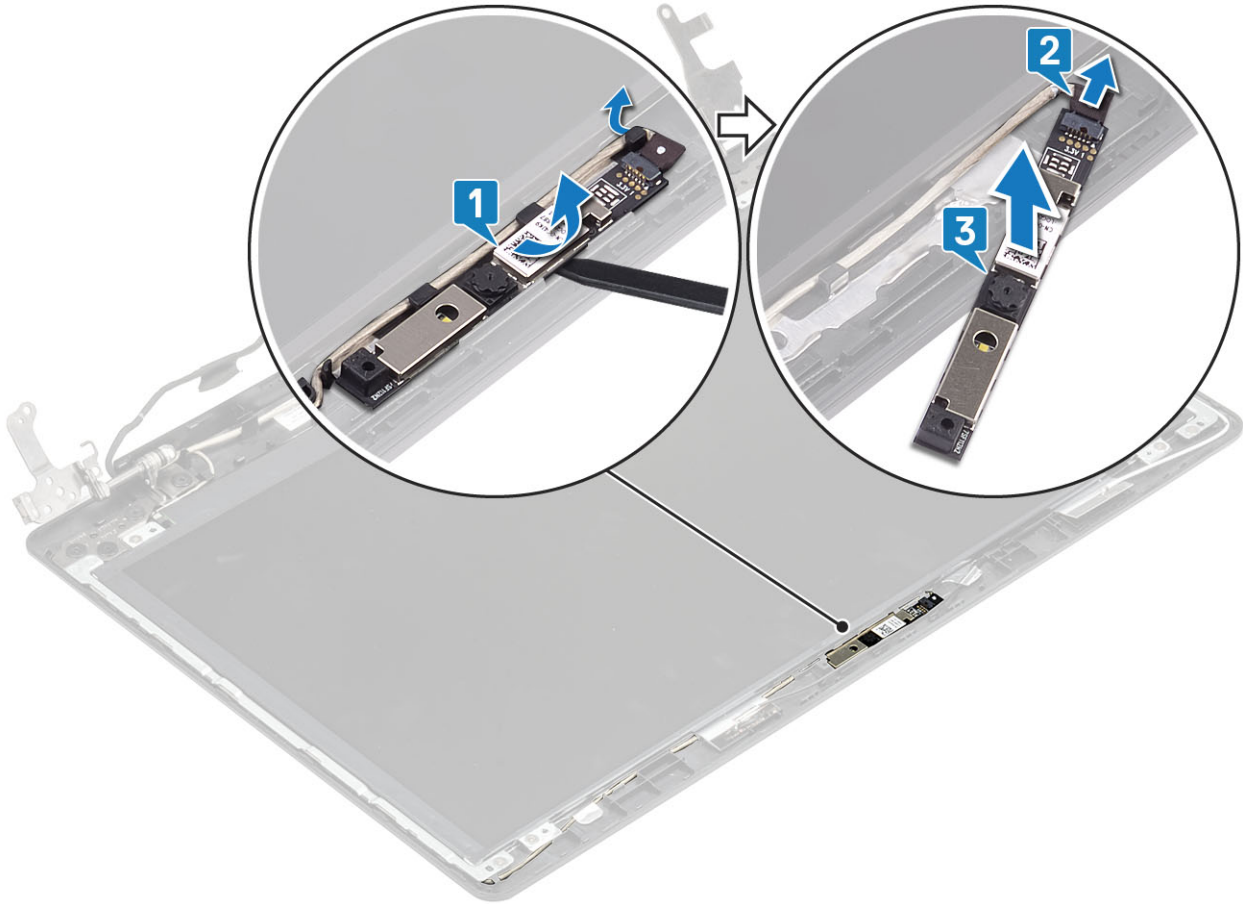

Installing the camera

Steps

1. Connect the camera cable to the camera module [1].
2. Using the alignment post, adhere the camera module on the display back-cover and antenna assembly [2].
3. Route the camera cable through the routing channels [3].

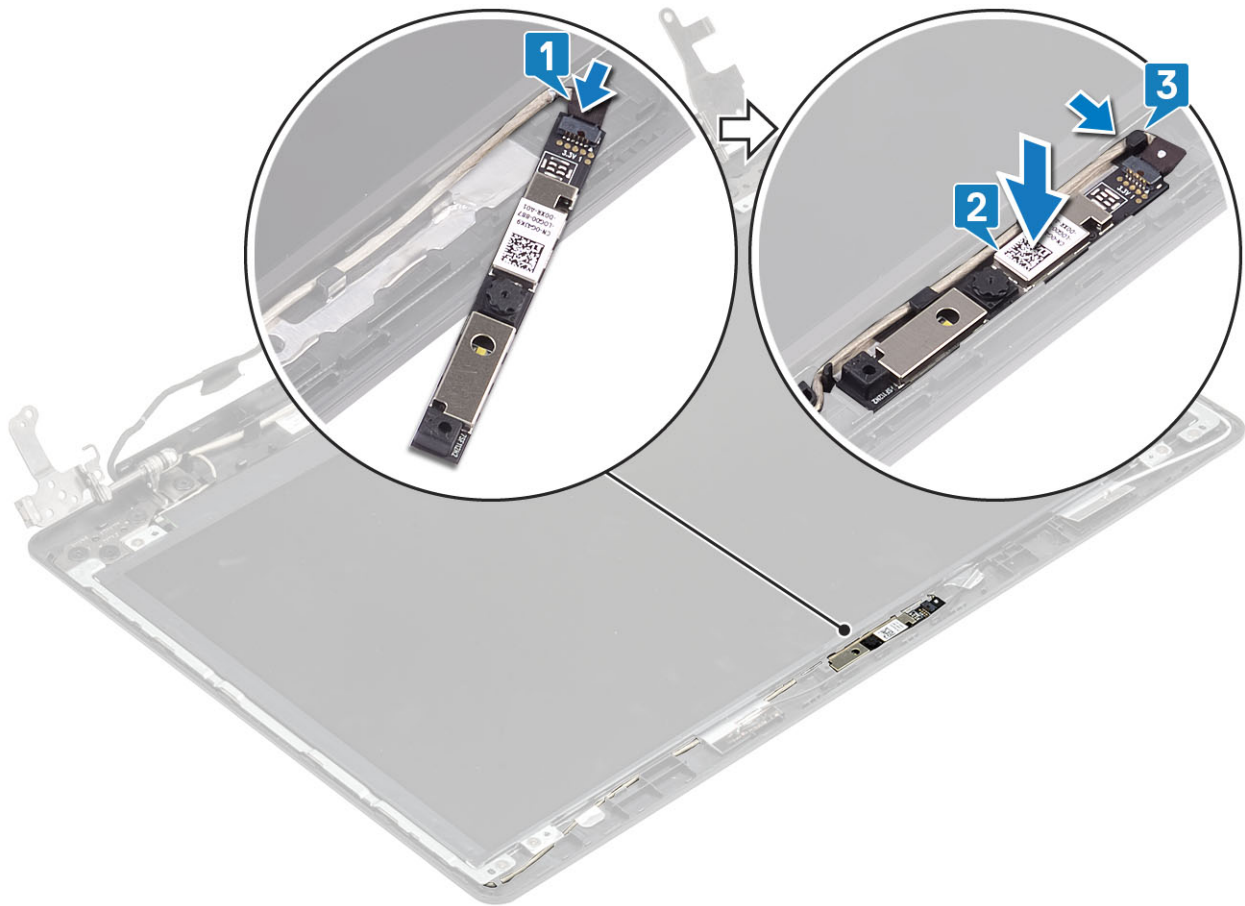

Next steps

1. Replace the [display bezel](#)
2. Replace the [display assembly](#)
3. Replace the [hard drive assembly](#)
4. Replace the [system fan](#)
5. Replace the [heatsink](#)
6. Replace the [SSD](#)
7. Replace the [WLAN](#)
8. Replace the [battery](#)
9. Replace the [base cover](#)
10. Replace the [optical drive assembly](#)
11. Replace the [SD memory card](#)
12. Follow the procedure in [after working inside your computer](#)

Display panel

Removing the display panel

Prerequisites

1. Follow the procedure in [before working inside your computer](#)
2. Remove the [SD memory card](#)
3. Remove the [optical drive assembly](#)
4. Remove the [base cover](#)
5. Remove the [battery](#)
6. Remove the [WLAN](#)

7. Remove the [SSD](#)
8. Remove the [hard drive assembly](#)
9. Remove the [system fan](#)
10. Remove the [heatsink](#)
11. Remove the [display assembly](#)
12. Remove the [display bezel](#)
13. Remove the [camera](#)

Steps

1. Remove the four (M2x2) screws that secure the display panel to the display back-cover and antenna assembly [1].
2. Lift the display panel and turn it over [2].

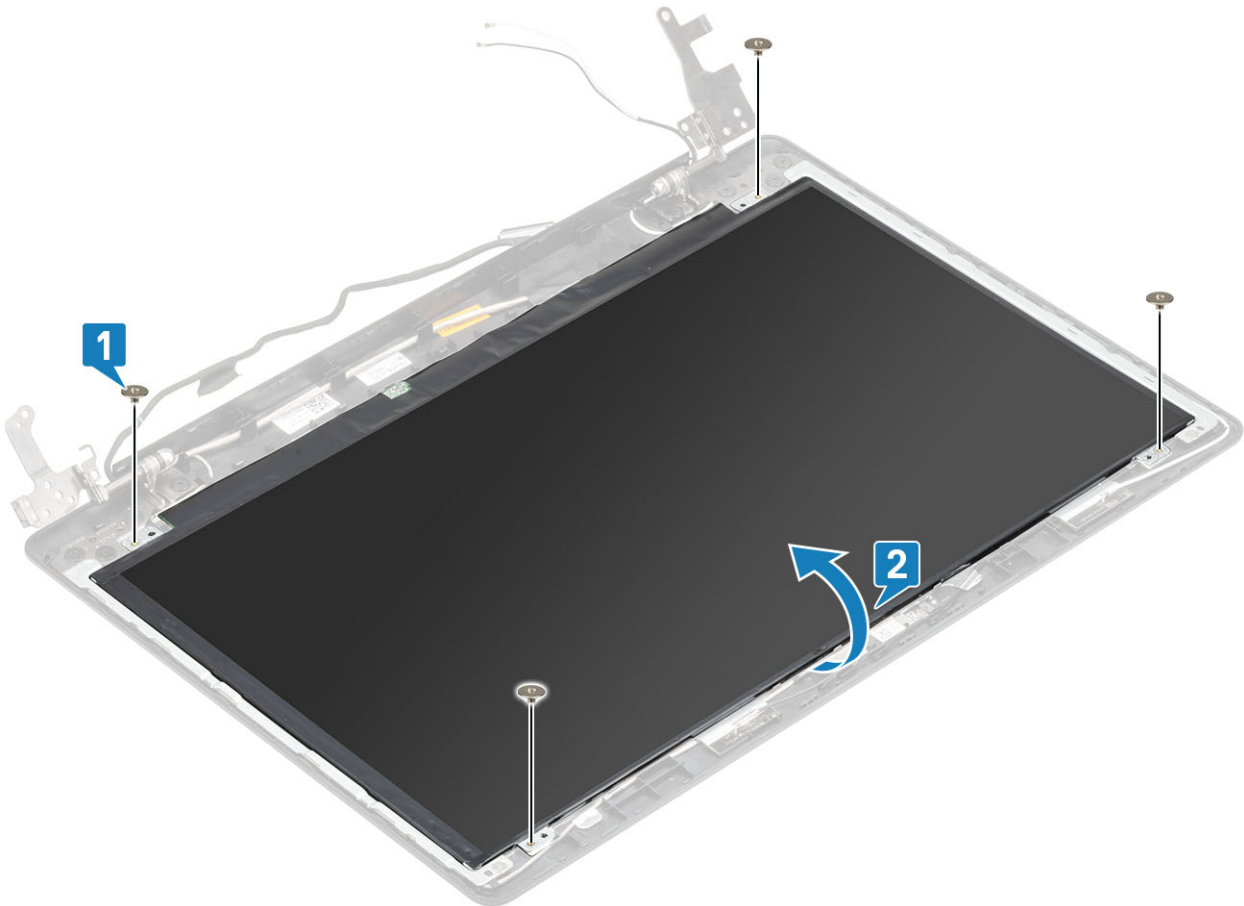

3. Peel the tape that secures the display cable to the back of the display panel [1].
4. Lift the latch and disconnect the display cable from the display-panel cable connector [2].
5. Lift the display panel away from the display back-cover and antenna assembly [3].

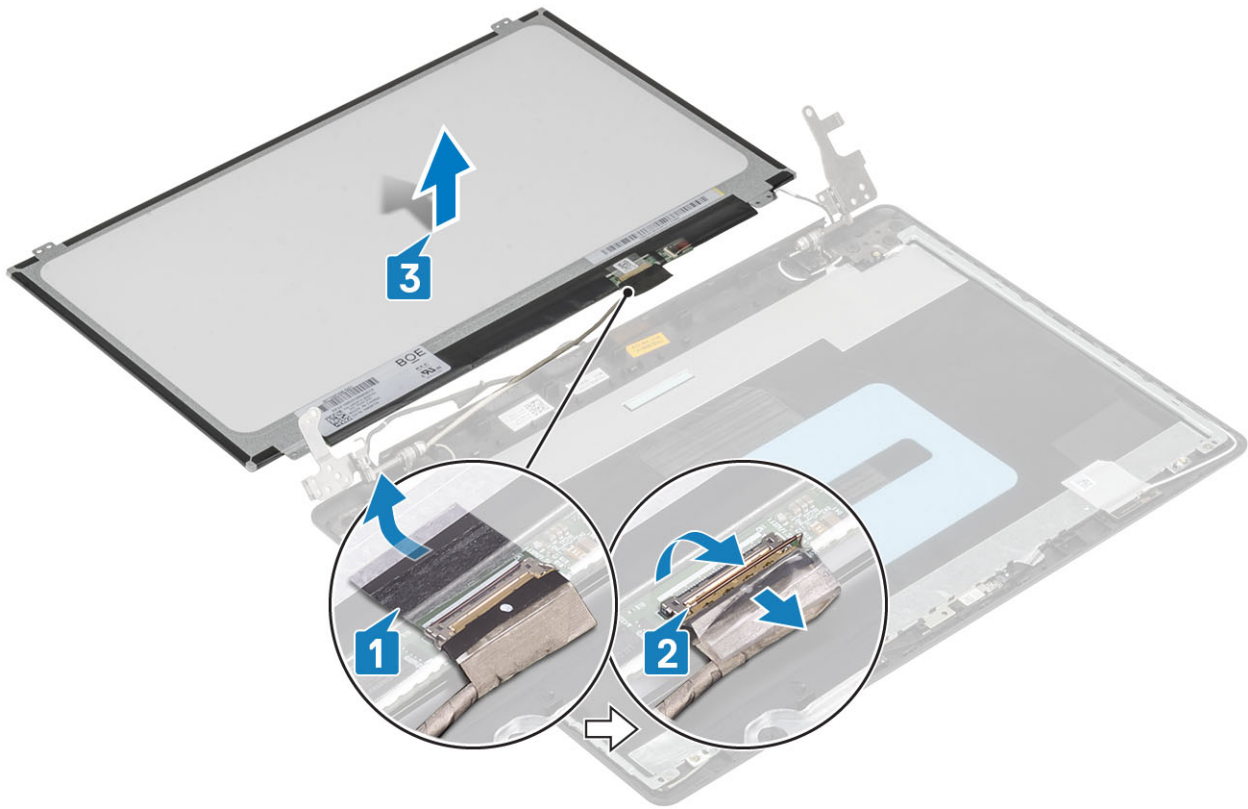

Installation display panel

Steps

1. Place the display panel on a flat and clean surface [1].
2. Connect the display cable to the connector at the back of the display panel and close the latch to secure the cable [2].
3. Adhere the tape that secures the display cable to the back of the display panel [3].
4. Turn the display panel over and place it on the display back-cover and antenna assembly [4].

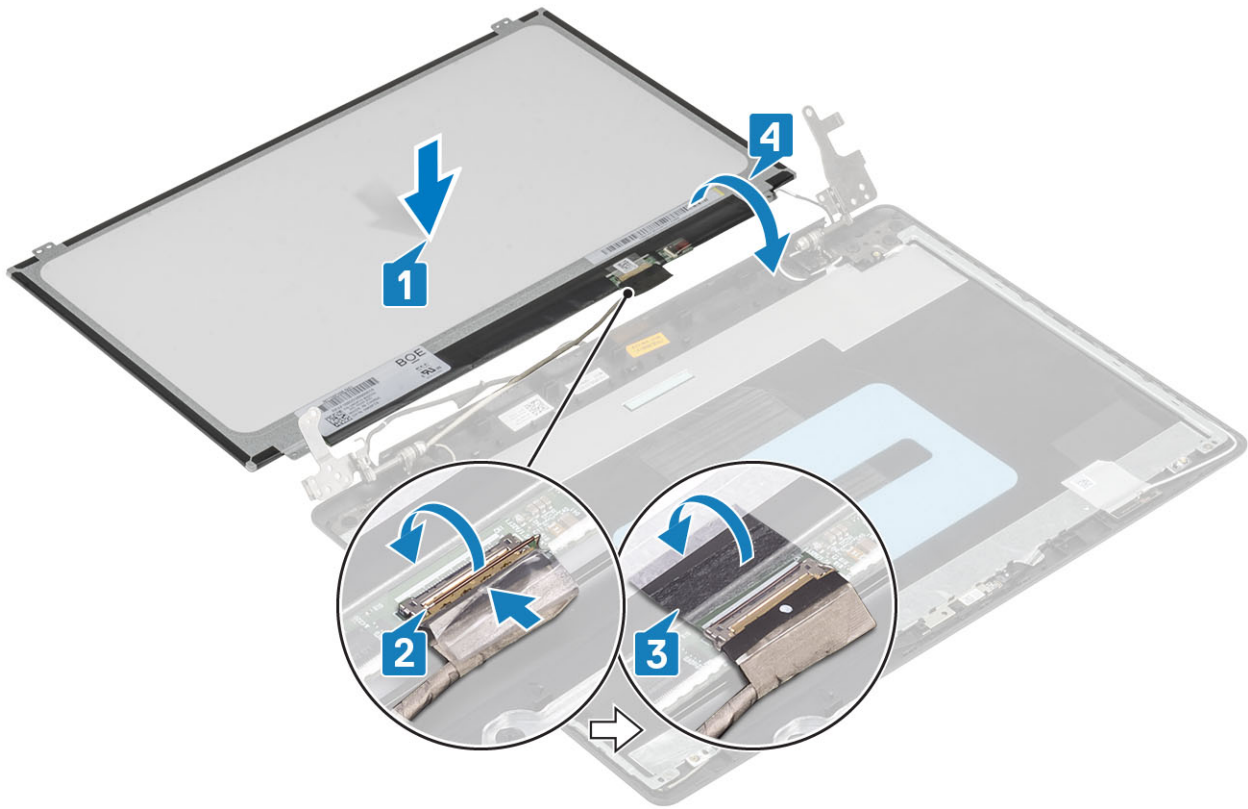

5. Align the screw holes on the display panel with the screw holes on the display back-cover and antenna assembly.
6. Replace the four (M2x2) screws that secure the display panel to the display back-cover and antenna assembly [1].

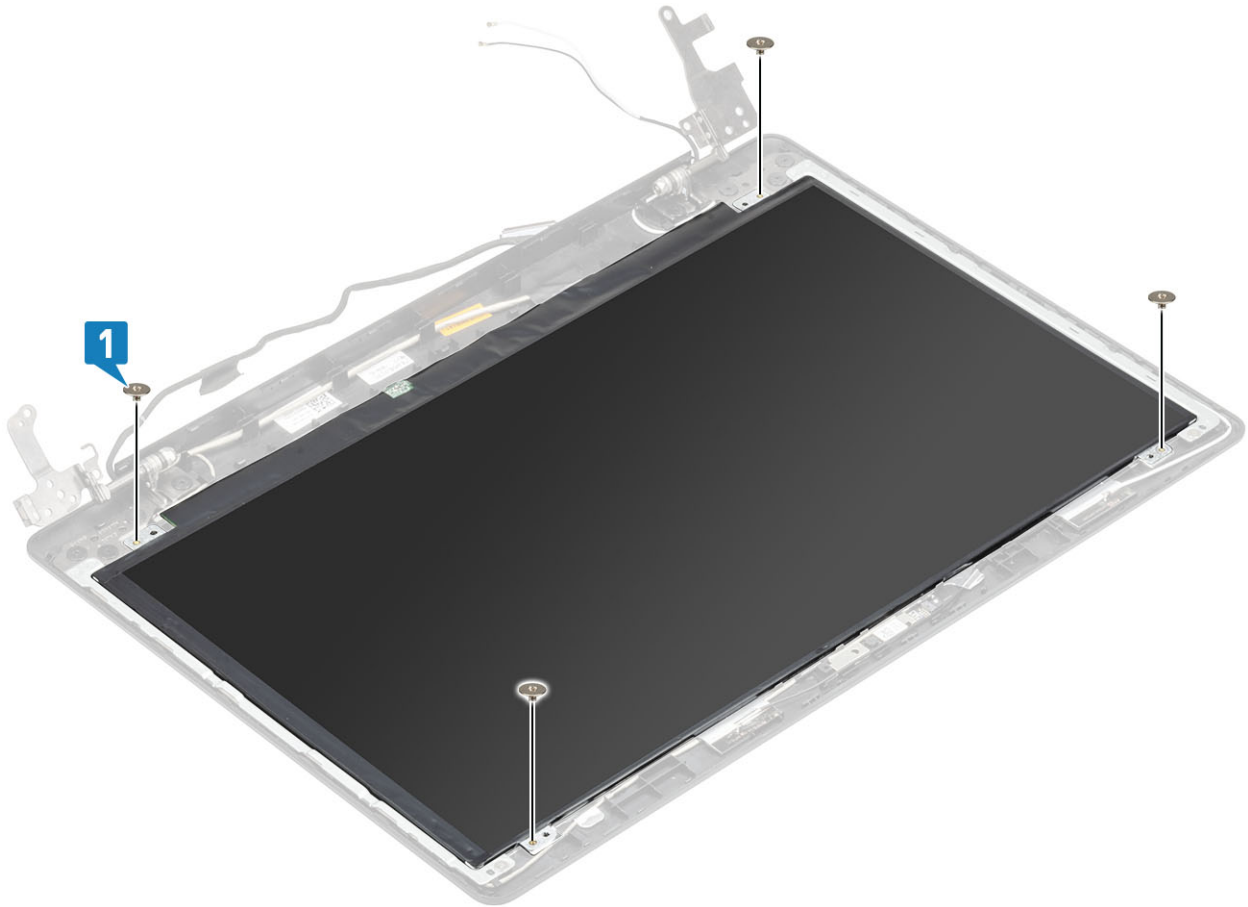

Next steps

1. Replace the [camera](#)
2. Replace the [display bezel](#)
3. Replace the [display assembly](#)
4. Replace the [hard drive assembly](#)
5. Replace the [system fan](#)
6. Replace the [heatsink](#)
7. Replace the [SSD](#)
8. Replace the [WLAN](#)
9. Replace the [battery](#)
10. Replace the [base cover](#)
11. Replace the [optical drive assembly](#)
12. Replace the [SD memory card](#)
13. Follow the procedure in [after working inside your computer](#)

Display hinges

Removing the display hinges

Prerequisites

1. Follow the procedure in [before working inside your computer](#)
2. Remove the [SD memory card](#)
3. Remove the [optical drive assembly](#)
4. Remove the [base cover](#)
5. Remove the [battery](#)
6. Remove the [WLAN](#)
7. Remove the [SSD](#)
8. Remove the [hard drive assembly](#)
9. Remove the [system fan](#)
10. Remove the [heatsink](#)
11. Remove the [display assembly](#)
12. Remove the [display bezel](#)
13. Remove the [camera](#)
14. Remove the [display panel](#)

Steps

1. Remove the eight (M2.5x2.5) screws and two (M2x2) screws that secure the hinges to the display back-cover and antenna assembly [1, 2].
2. Lift the hinges and brackets off the display back-cover and antenna assembly [3].

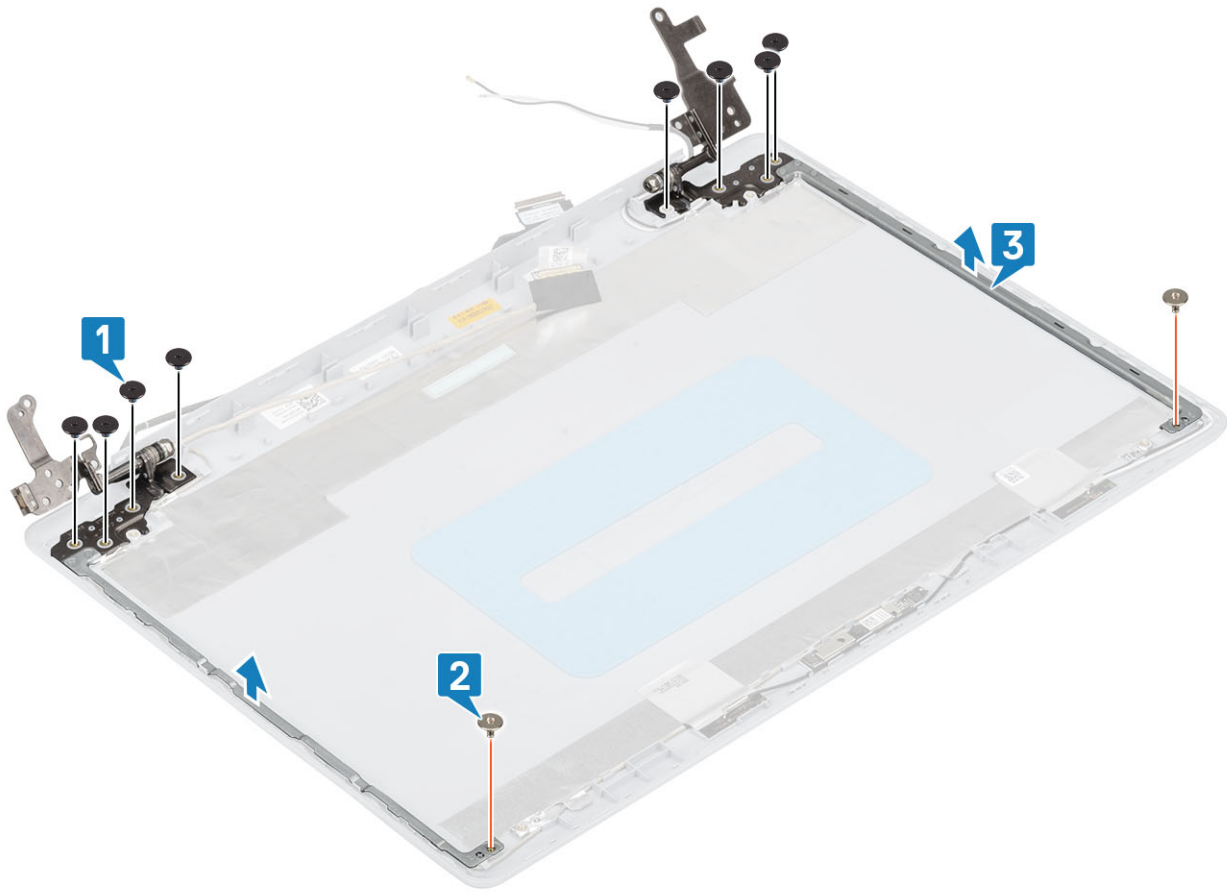

Installing the display hinges

Steps

1. Align the screw holes on the hinges and brackets with the screw holes on the display back-cover and antenna assembly [1].
2. Replace the eight (M2.5x2.5) screws and two (M2x2) screws that secure the hinges to the display back-cover and antenna assembly [3,2].

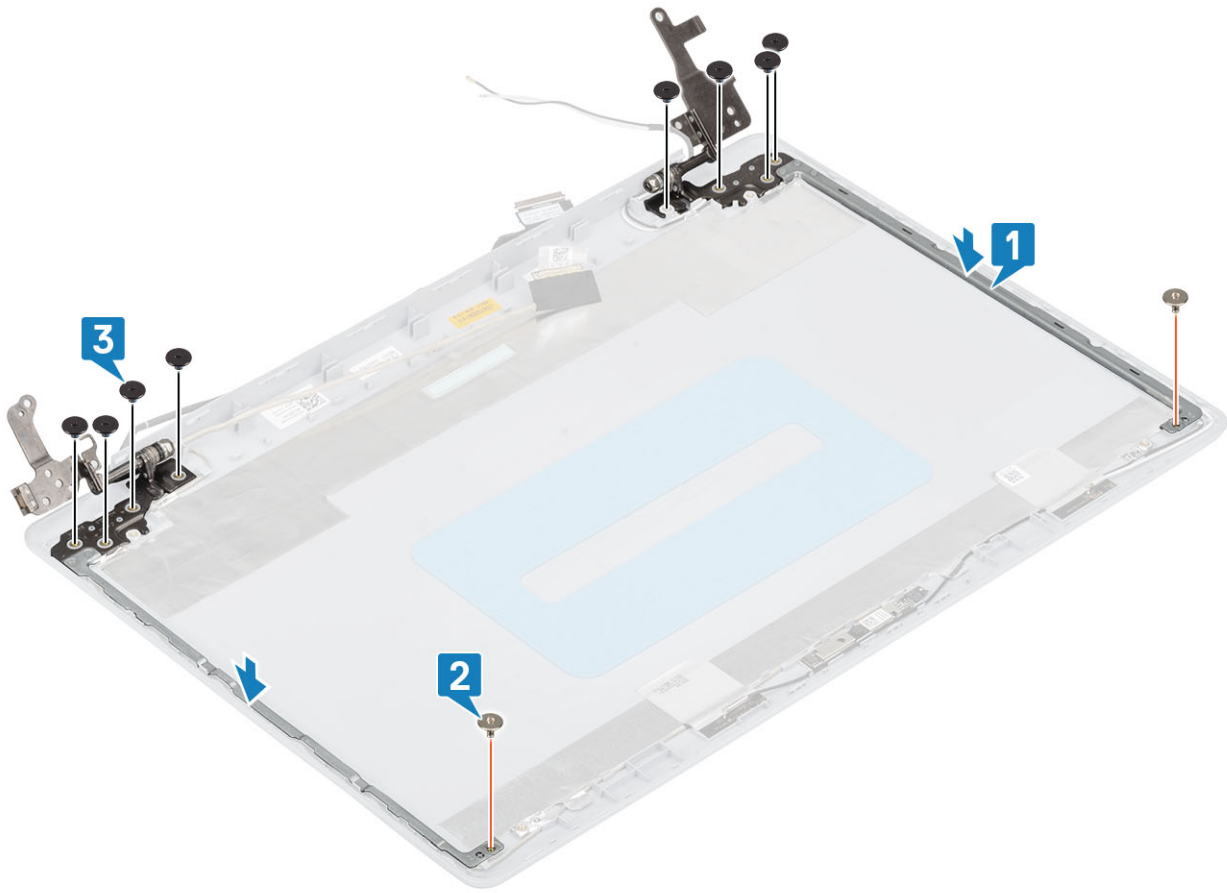

Next steps

1. Replace the [display panel](#)
2. Replace the [camera](#)
3. Replace the [display bezel](#)
4. Replace the [display assembly](#)
5. Replace the [hard drive assembly](#)
6. Replace the [system fan](#)
7. Replace the [heatsink](#)
8. Replace the [SSD](#)
9. Replace the [WLAN](#)
10. Replace the [battery](#)
11. Replace the [base cover](#)
12. Replace the [optical drive assembly](#)
13. Replace the [SD memory card](#)
14. Follow the procedure in [after working inside your computer](#)

Display cable

Removing the display cable

Prerequisites

1. Follow the procedure in [before working inside your computer](#)
2. Remove the [SD memory card](#)
3. Remove the [optical drive assembly](#)
4. Remove the [base cover](#)

5. Remove the [battery](#)
6. Remove the [WLAN](#)
7. Remove the [SSD](#)
8. Remove the [hard drive assembly](#)
9. Remove the [system fan](#)
10. Remove the [heatsink](#)
11. Remove the [display assembly](#)
12. Remove the [display bezel](#)
13. Remove the [display panel](#)
14. Remove the [display hinges](#)

Steps

1. Disconnect the camera cable on the display back-cover and antenna assembly [1].
2. Peel the adhesive that secures the camera cable [2].
3. Remove the camera cable and the display cable from the routing guides on the display back-cover and antenna assembly[3]

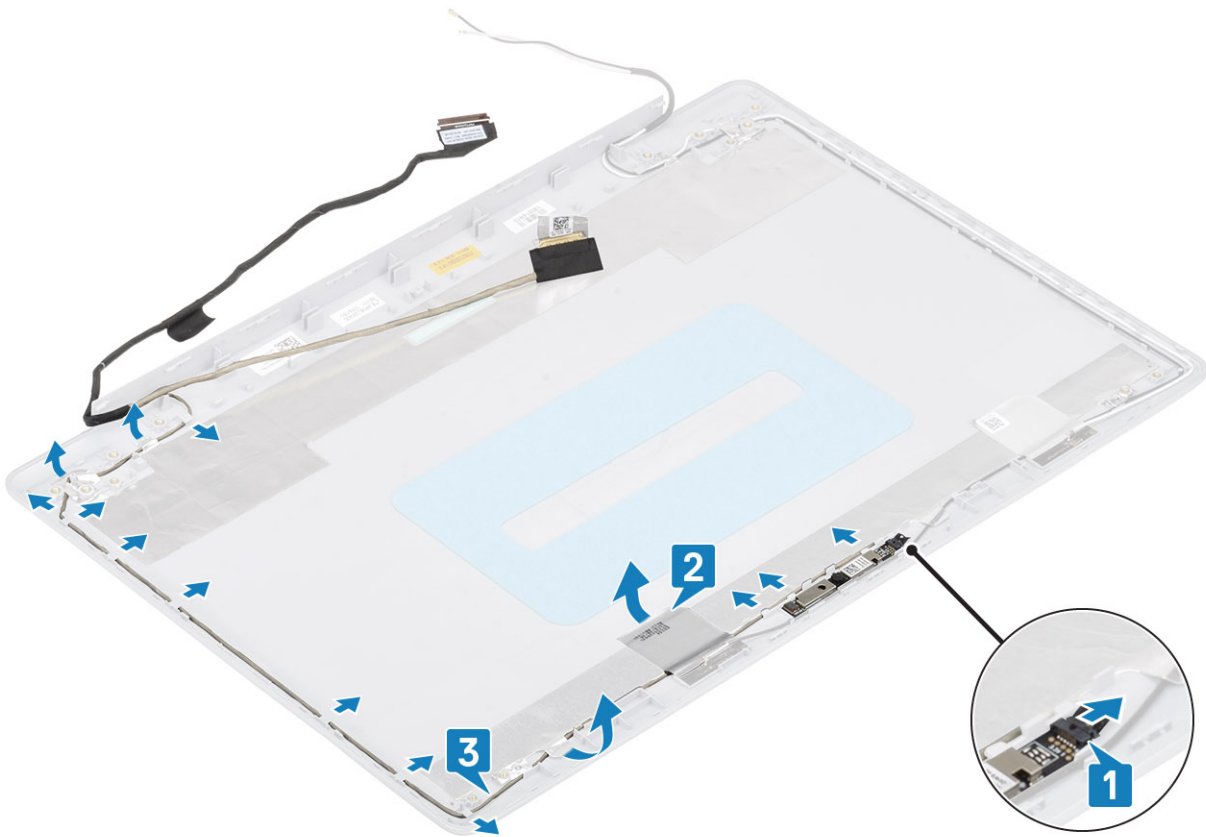

Installing the display cable

Steps

1. Route the camera cable through the routing guides on the display back-cover and antenna assembly [1].
2. Affix the adhesive that secures the camera cable [2].
3. Connect the camera cable on the display back-cover and antenna assembly [3].

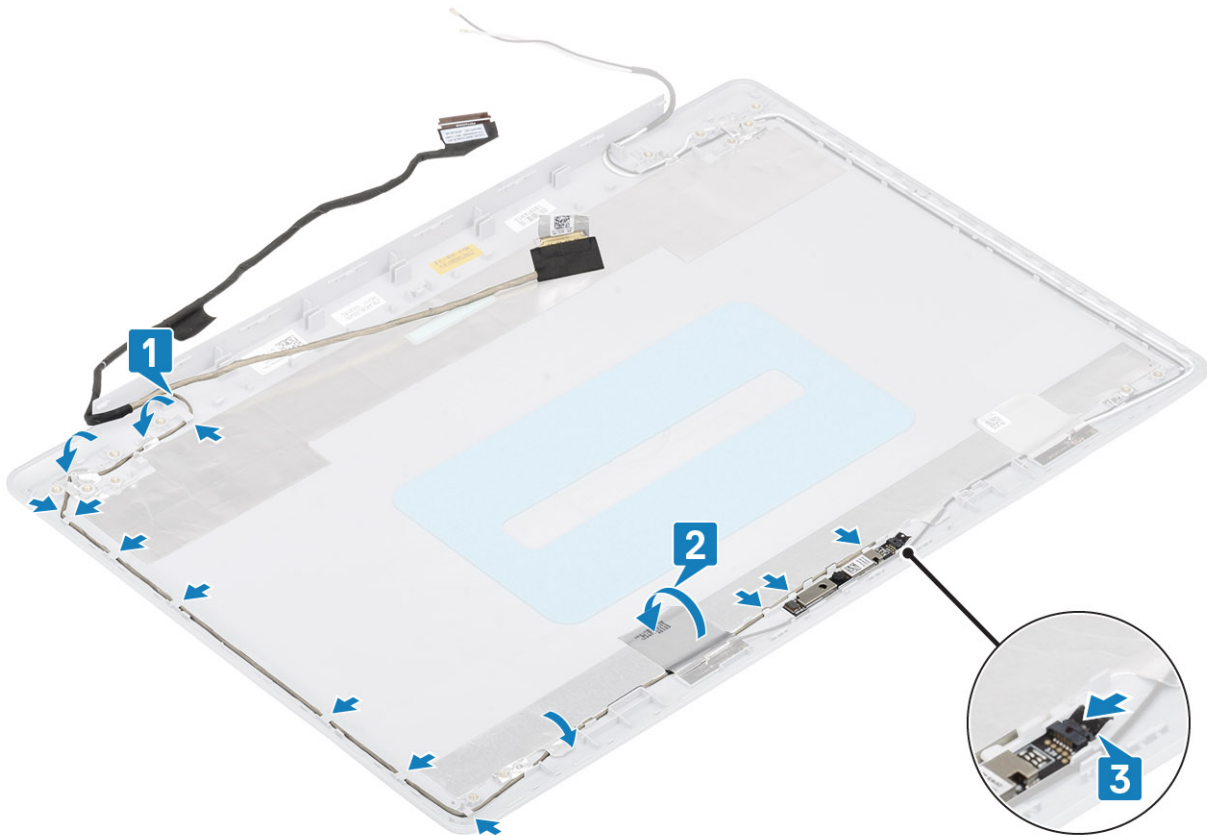

Next steps

1. Replace the [display hinges](#)
2. Replace the [display panel](#)
3. Replace the [display bezel](#)
4. Replace the [display assembly](#)
5. Replace the [hard drive assembly](#)
6. Replace the [system fan](#)
7. Replace the [heatsink](#)
8. Replace the [SSD](#)
9. Replace the [WLAN](#)
10. Replace the [battery](#)
11. Replace the [base cover](#)
12. Replace the [optical drive assembly](#)
13. Replace the [SD memory card](#)
14. Follow the procedure in [after working inside your computer](#)

Display back-cover and antenna assembly

Removing the display back-cover

Prerequisites

1. Follow the procedure in [before working inside your computer](#)
2. Remove the [SD memory card](#)
3. Remove the [optical drive assembly](#)
4. Remove the [base cover](#)
5. Remove the [battery](#)

6. Remove the [WLAN](#)
7. Remove the [SSD](#)
8. Remove the [hard drive assembly](#)
9. Remove the [system fan](#)
10. Remove the [heatsink](#)
11. Remove the [display assembly](#)
12. Remove the [display bezel](#)
13. Remove the [camera](#)
14. Remove the [display panel](#)
15. Remove the [display hinges](#)
16. Remove the [display cable](#)

About this task

After performing all the preceding steps, you are left with the display back-cover.

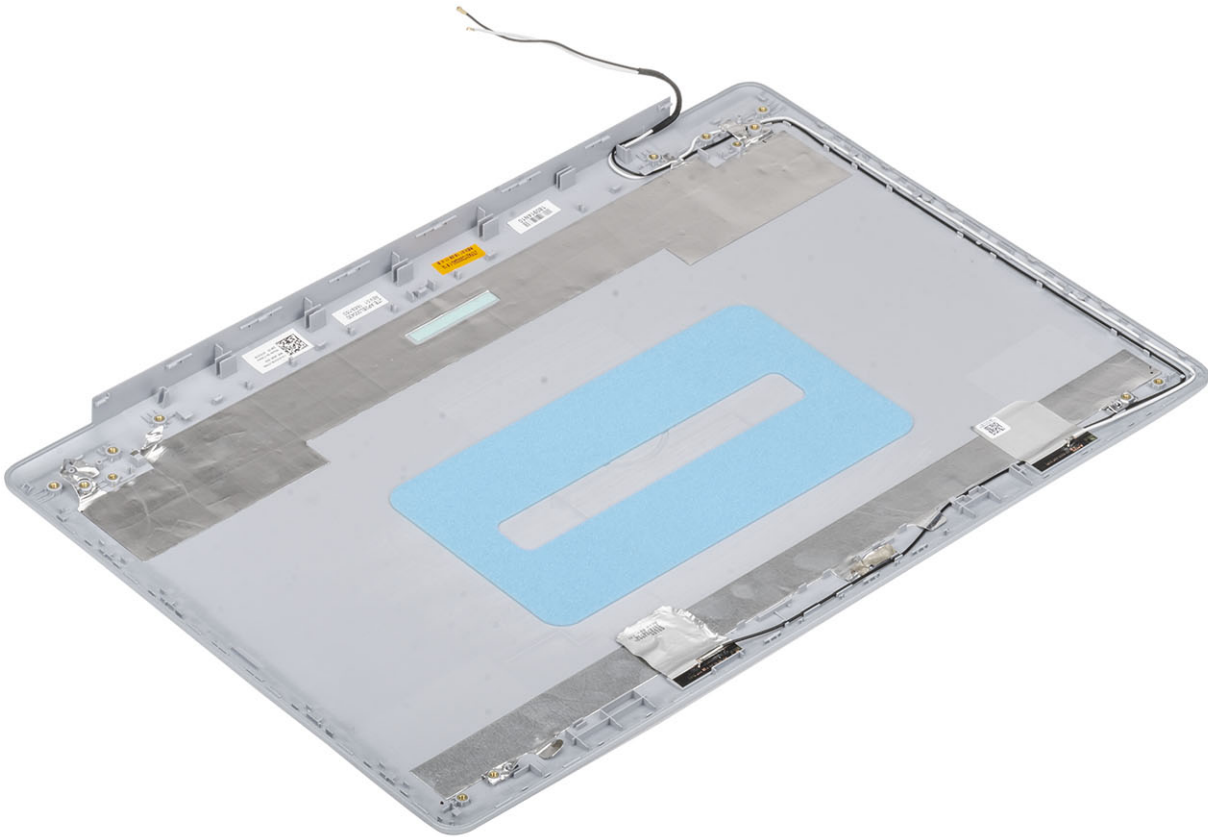

Installing the display back-cover

About this task

Place the display back-cover on a clean and flat surface.

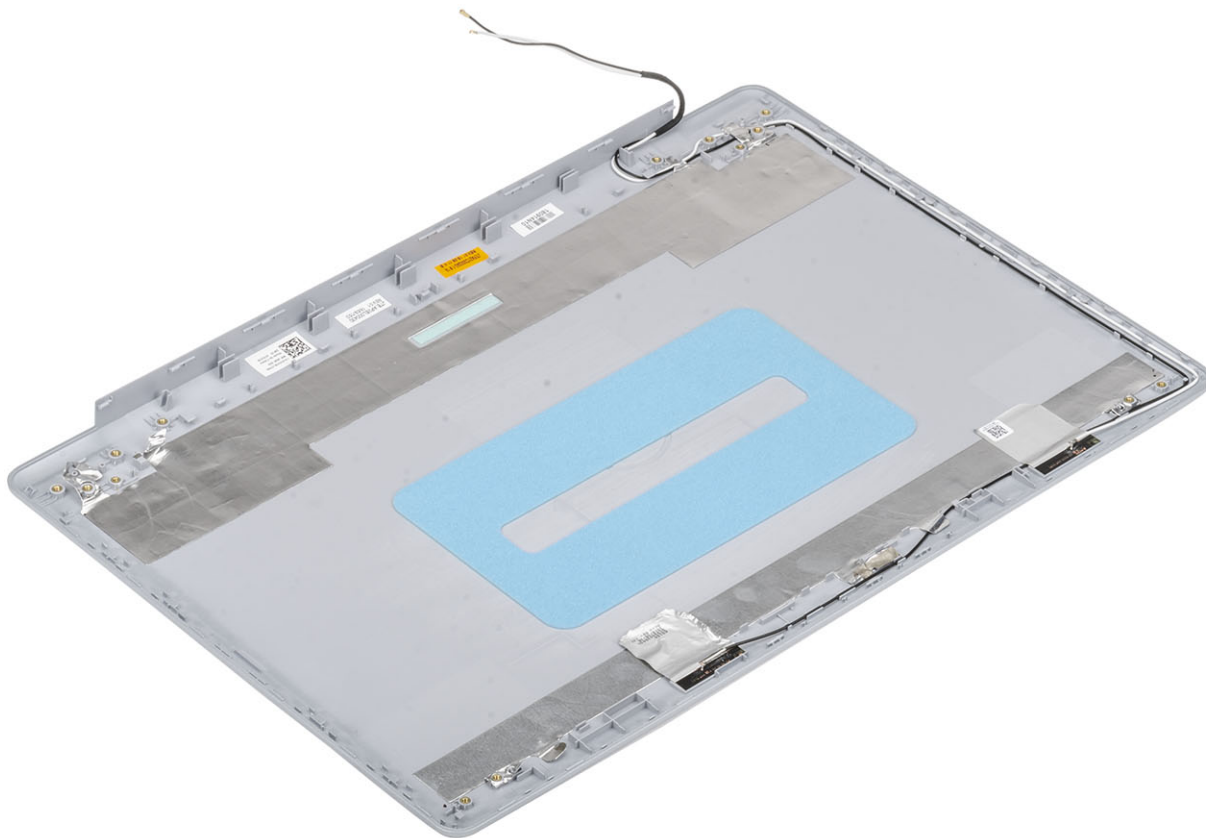

Next steps

1. Replace the [display cable](#)
2. Replace the [display hinges](#)
3. Replace the [display panel](#)
4. Replace the [camera](#)
5. Replace the [display bezel](#)
6. Replace the [display assembly](#)
7. Replace the [hard drive assembly](#)
8. Replace the [system fan](#)
9. Replace the [heatsink](#)
10. Replace the [SSD](#)
11. Replace the [WLAN](#)
12. Replace the [battery](#)
13. Replace the [base cover](#)
14. Replace the [optical drive assembly](#)
15. Replace the [SD memory card](#)
16. Follow the procedure in [after working inside your computer](#)

Palm-rest and keyboard assembly

Removing the palmrest and keyboard assembly

Prerequisites

1. Follow the procedure in [before working inside your computer](#)
2. Remove the [SD memory card](#)
3. Remove the [optical drive assembly](#)
4. Remove the [base cover](#)
5. Remove the [battery](#)
6. Remove the [memory](#)
7. Remove the [WLAN](#)
8. Remove the [SSD](#)
9. Remove the [speakers](#)
10. Remove the [coin-cell battery](#)
11. Remove the [hard drive assembly](#)
12. Remove the [system fan](#)
13. Remove the [heatsink](#)
14. Remove the [VGA daughterboard](#)
15. Remove the [IO board](#)
16. Remove the [touchpad](#)
17. Remove the [display assembly](#)
18. Remove the [power button board](#)
19. Remove the [power button with fingerprint reader](#)
20. Remove the [display hinges](#)
21. Remove the [power adapter port](#)
22. Remove the [system board](#)

About this task

After performing the preceding steps, you are left with the palmrest and keyboard assembly.

 **NOTE:** The system board can be removed and installed together with the heatsink still attached.



Troubleshooting

Enhanced Pre-Boot System Assessment (ePSA) diagnostics

About this task

The ePSA diagnostics (also known as system diagnostics) performs a complete check of your hardware. The ePSA is embedded with the BIOS and is launched by the BIOS internally. The embedded system diagnostics provides a set of options for particular devices or device groups allowing you to:

- Run tests automatically or in an interactive mode
- Repeat tests
- Display or save test results
- Run thorough tests to introduce additional test options to provide extra information about the failed device(s)
- View status messages that inform you if tests are completed successfully
- View error messages that inform you of problems encountered during testing

NOTE: Some tests for specific devices require user interaction. Always ensure that you are present at the computer terminal when the diagnostic tests are performed.

Running the ePSA diagnostics

Steps

1. Turn on your computer.
2. As the computer boots, press the F12 key as the Dell logo appears.
3. On the boot menu screen, select the **Diagnostics** option.
4. Click the arrow at the bottom left corner.
Diagnostics front page is displayed.
5. Click the arrow in the lower-right corner to go to the page listing.
The items detected are listed.
6. To run a diagnostic test on a specific device, press Esc and click **Yes** to stop the diagnostic test.
7. Select the device from the left pane and click **Run Tests**.
8. If there are any issues, error codes are displayed.
Note the error code and validation number and contact Dell.

System diagnostic lights

Battery-status light

Indicates the power and battery-charge status.

Solid white — Power adapter is connected and the battery has more than 5 percent charge.

Amber — Computer is running on battery and the battery has less than 5 percent charge.

Off

- Power adapter is connected and the battery is fully charged.
- Computer is running on battery and the battery has more than 5 percent charge.
- Computer is in sleep state, hibernation, or turned off.

The power and battery-status light blinks amber along with beep codes indicating failures.

For example, the power and battery-status light blinks amber two times followed by a pause, and then blinks white three times followed by a pause. This 2,3 pattern continues until the computer is turned off indicating no memory or RAM is detected.

The following table shows different power and battery-status light patterns and associated problems.

Table 4. LED codes

Diagnostic light codes	Problem description
2,1	Processor failure
2,2	System board: BIOS or ROM (Read-Only Memory) failure
2,3	No memory or RAM (Random-Access Memory) detected
2,4	Memory or RAM (Random-Access Memory) failure
2,5	Invalid memory installed
2,6	System-board or chipset error
2,7	Display failure
2,8	LCD power rail failure. Replace system board
3,1	Coin-cell battery failure
3,2	PCI, video card/chip failure
3,3	Recovery image not found
3,4	Recovery image found but invalid
3,5	Power-rail failure
3,6	System BIOS Flash incomplete
3,7	Management Engine (ME) error

Camera status light: Indicates whether the camera is in use.

- Solid white — Camera is in use.
- Off — Camera is not in use.

Caps Lock status light: Indicates whether Caps Lock is enabled or disabled.

- Solid white — Caps Lock enabled.
- Off — Caps Lock disabled.

Flashing BIOS (USB key)

Steps

1. Follow the procedure from step 1 to step 7 in "[Flashing the BIOS](#)" to download the latest BIOS setup program file.
2. Create a bootable USB drive. For more information see the knowledge base article [SLN143196](#) at www.dell.com/support.
3. Copy the BIOS setup program file to the bootable USB drive.
4. Connect the bootable USB drive to the computer that needs the BIOS update.
5. Restart the computer and press **F12** when the Dell logo is displayed on the screen.
6. Boot to the USB drive from the **One Time Boot Menu**.
7. Type the BIOS setup program filename and press **Enter**.
8. The **BIOS Update Utility** appears. Follow the instructions on the screen to complete the BIOS update.

Flashing the BIOS

About this task

You may need to flash (update) the BIOS when an update is available or when you replace the system board.

Follow these steps to flash the BIOS:

Steps

1. Turn on your computer.
2. Go to www.dell.com/support.
3. Click **Product support**, enter the Service Tag of your computer, and then click **Submit**.

 **NOTE: If you do not have the Service Tag, use the auto-detect feature or manually browse for your computer model.**

4. Click **Drivers & downloads > Find it myself**.
5. Select the operating system installed on your computer.
6. Scroll down the page and expand **BIOS**.
7. Click **Download** to download the latest version of the BIOS for your computer.
8. After the download is complete, navigate to the folder where you saved the BIOS update file.
9. Double-click the BIOS update file icon and follow the instructions on the screen.

Backup media and recovery options

It is recommended to create a recovery drive to troubleshoot and fix problems that may occur with Windows. Dell proposes multiple options for recovering Windows operating system on your Dell PC. For more information, see [Dell Windows Backup Media and Recovery Options](#).

WiFi power cycle

About this task

If your computer is unable to access the internet due to WiFi connectivity issues a WiFi power cycle procedure may be performed. The following procedure provides the instructions on how to conduct a WiFi power cycle:

 **NOTE: Some ISPs (Internet Service Providers) provide a modem/router combo device.**

Steps

1. Turn off your computer.
2. Turn off the modem.
3. Turn off the wireless router.
4. Wait for 30 seconds.
5. Turn on the wireless router.
6. Turn on the modem.
7. Turn on your computer.

Flea power release

About this task

Flea power is the residual static electricity that remains on the computer even after it has been powered off and the battery has been removed. The following procedure provides the instructions on how to conduct flea power release:

Steps

1. Turn off your computer.
2. Disconnect the power adapter from your computer.
3. Press and hold the power button for 15 seconds to drain the flea power.
4. Connect the power adapter to your computer.
5. Turn on your computer.

Getting help

Topics:

- [Contacting Dell](#)

Contacting Dell

Prerequisites

 **NOTE:** If you do not have an active Internet connection, you can find contact information on your purchase invoice, packing slip, bill, or Dell product catalog.

About this task

Dell provides several online and telephone-based support and service options. Availability varies by country and product, and some services may not be available in your area. To contact Dell for sales, technical support, or customer service issues:

Steps

1. Go to **Dell.com/support**.
2. Select your support category.
3. Verify your country or region in the **Choose a Country/Region** drop-down list at the bottom of the page.
4. Select the appropriate service or support link based on your need.