

# Dell™ Inspiron™ 530 Series Owner's Manual

**Model DCMF**

# Notes, Notices, and Cautions



**NOTE:** A NOTE indicates important information that helps you make better use of your computer.



**NOTICE:** A NOTICE indicates either potential damage to hardware or loss of data and tells you how to avoid the problem.



**CAUTION:** A CAUTION indicates a potential for property damage, personal injury, or death.

If you purchased a Dell™ n Series computer, any references in this document to Microsoft® Windows® operating systems are not applicable.

## Abbreviations and Acronyms

For a complete list of abbreviations and acronyms, see the "Glossary" on page 203.

---

**Information in this document is subject to change without notice.**

© 2007–2008 Dell Inc. All rights reserved.

Reproduction of these materials in any manner whatsoever without the written permission of Dell Inc. is strictly forbidden.

Trademarks used in this text: *Dell*, the *DELL* logo, *YOURS IS HERE*, and *Inspiron* are trademarks of Dell Inc.; *Bluetooth* is a registered trademark owned by Bluetooth SIG, Inc. and is used by Dell under license; *Microsoft*, *Windows*, *Internet Explorer*, *Windows Vista*, and *Windows Vista* start button logo are either trademarks or registered trademarks of Microsoft Corporation in the United States and/or other countries; *Intel*, *Pentium*, and *Celeron* are registered trademarks, *SpeedStep* and *Core* are trademarks of Intel Corporation in the U.S. and other countries.

Other trademarks and trade names may be used in this document to refer to either the entities claiming the marks and names or their products. Dell Inc. disclaims any proprietary interest in trademarks and trade names other than its own.

Model DCMF

September 2008

P/N KP338

Rev. A05

# Contents

<b>Finding Information</b> . . . . .	<b>11</b>
<b>1 Setting Up and Using Your Computer</b> . . .	<b>15</b>
<b>Front View of the Computer</b> . . . . .	<b>15</b>
Inspiron 530/530a/530c . . . . .	15
Inspiron 530b/530d . . . . .	17
<b>Back View of the Computer</b> . . . . .	<b>19</b>
Inspiron 530/530a/530c . . . . .	19
Inspiron 530b/530d . . . . .	21
<b>Back Panel Connectors</b> . . . . .	<b>22</b>
Inspiron 530/530a/530c . . . . .	22
Inspiron 530b/530d . . . . .	25
<b>Installing Your Computer in an Enclosure.</b> . . . . .	<b>27</b>
<b>Setting Up a Printer</b> . . . . .	<b>29</b>
Printer Cable . . . . .	29
Connecting a USB Printer . . . . .	29
<b>Playing CDs and DVDs.</b> . . . . .	<b>31</b>
Adjusting the Volume . . . . .	32
Configuring the Audio Connectors for 5.1-Channel . . . . .	33
Adjusting the Picture . . . . .	33

<b>Copying CDs and DVDs</b> . . . . .	<b>34</b>
How to Copy a CD or DVD . . . . .	34
Using Blank CDs and DVDs . . . . .	35
Helpful Tips . . . . .	36
<b>Using a Media Card Reader (Optional)</b> . . . . .	<b>36</b>
<b>Connecting Two Monitors</b> . . . . .	<b>38</b>
Connecting Two Monitors With VGA Connectors . . . . .	38
Connecting One Monitor With a VGA Connector and One Monitor With a DVI Connector . . . . .	39
Connecting a TV . . . . .	39
Changing the Display Settings . . . . .	40
<b>Power Management</b> . . . . .	<b>40</b>
Power Management Options in Microsoft® Windows® XP . . . . .	40
Standby Mode . . . . .	40
Hibernate Mode . . . . .	41
Power Options Properties . . . . .	42
Power Management Options in Windows Vista® . . . . .	43
Standby Mode . . . . .	44
Hibernate Mode . . . . .	44
Power Plan Properties . . . . .	45
<b>Enabling SpeedStep™ Technology</b> . . . . .	<b>46</b>
<b>About RAID Configurations</b> . . . . .	<b>47</b>
RAID Level 1 Configuration . . . . .	47
Configuring Your Hard Drives for RAID . . . . .	48
Configuring for RAID Using the Intel® Option ROM Utility . . . . .	49
Configuring for RAID Using the Intel® Matrix Storage Manager . . . . .	50

<b>Transferring Information to a New Computer . . . . .</b>	<b>54</b>
Microsoft® Windows® XP . . . . .	54
<b>Setting Up a Home and Office Network. . . . .</b>	<b>58</b>
Connecting to a Network Adapter . . . . .	58
Setting Up a Network in the Microsoft® Windows® XP Operating System. . . . .	59
Setting Up a Network in the Windows Vista® Operating System. . . . .	59
<b>Connecting to the Internet. . . . .</b>	<b>60</b>
Setting Up Your Internet Connection. . . . .	60
<b>2 Solving Problems. . . . .</b>	<b>63</b>
<b>Troubleshooting Tips. . . . .</b>	<b>63</b>
<b>Battery Problems . . . . .</b>	<b>63</b>
<b>Drive Problems. . . . .</b>	<b>64</b>
CD and DVD drive problems . . . . .	65
Hard drive problems . . . . .	66
<b>E-Mail, Modem, and Internet Problems. . . . .</b>	<b>66</b>
<b>Error Messages . . . . .</b>	<b>68</b>
<b>Keyboard Problems . . . . .</b>	<b>69</b>
<b>Lockups and Software Problems . . . . .</b>	<b>70</b>
The computer does not start up . . . . .	70
The computer stops responding . . . . .	70
A program stops responding . . . . .	70
A program crashes repeatedly. . . . .	70
A program is designed for an earlier Microsoft® Windows® operating system . . . . .	71

A solid blue screen appears . . . . .	71
Other software problems . . . . .	72
<b>Media Card Reader Problems . . . . .</b>	<b>73</b>
<b>Memory Problems . . . . .</b>	<b>74</b>
<b>Mouse Problems . . . . .</b>	<b>75</b>
<b>Network Problems . . . . .</b>	<b>76</b>
<b>Power Problems . . . . .</b>	<b>77</b>
<b>Printer Problems . . . . .</b>	<b>78</b>
<b>Scanner Problems . . . . .</b>	<b>80</b>
<b>Sound and Speaker Problems . . . . .</b>	<b>81</b>
No sound from speakers . . . . .	81
No sound from headphones . . . . .	82
<b>Video and Monitor Problems . . . . .</b>	<b>82</b>
If the screen is blank . . . . .	83
If the screen is difficult to read . . . . .	84
<b>3 Troubleshooting Tools . . . . .</b>	<b>85</b>
<b>Power Lights . . . . .</b>	<b>85</b>
<b>Beep Codes . . . . .</b>	<b>86</b>
<b>System Messages . . . . .</b>	<b>88</b>
<b>Dell Diagnostics . . . . .</b>	<b>90</b>
When to Use the Dell Diagnostics . . . . .	90
Starting the Dell Diagnostics From Your Hard Drive . . . . .	90

Starting the Dell Diagnostics From the <i>Drivers and Utilities</i> Media . . . . .	91
Dell Diagnostics Main Menu . . . . .	92
<b>Drivers . . . . .</b>	<b>94</b>
What is a Driver? . . . . .	94
Identifying Drivers . . . . .	94
Reinstalling Drivers and Utilities . . . . .	95
<b>Troubleshooting Software and Hardware Problems in the Microsoft Windows® XP and Windows Vista® Operating System . . . . .</b>	<b>97</b>
<b>Restoring Your Operating System . . . . .</b>	<b>98</b>
Using Microsoft® Windows® System Restore . . . . .	98
Using Dell PC Restore and Dell Factory Image Restore . . . . .	100
Using the Operating System CD . . . . .	103
<b>4 Removing and Installing Parts . . . . .</b>	<b>105</b>
<b>    Before You Begin . . . . .</b>	<b>105</b>
Recommended Tools . . . . .	105
Turning Off Your Computer . . . . .	106
Before Working Inside Your Computer . . . . .	106
<b>    Removing the Computer Cover . . . . .</b>	<b>107</b>
<b>    Inside View of Your Computer . . . . .</b>	<b>109</b>
<b>    System Board Components . . . . .</b>	<b>110</b>
Inspiron 530 . . . . .	110
Inspiron 530a . . . . .	112
Inspiron 530b . . . . .	114
Inspiron 530c . . . . .	116
Inspiron 530d . . . . .	118

<b>Power Supply DC Connector Pin Assignments . . . . .</b>	<b>120</b>
<b>Memory . . . . .</b>	<b>123</b>
Memory Installation Guidelines . . . . .	124
Installing Memory. . . . .	126
Removing Memory . . . . .	128
<b>Cards . . . . .</b>	<b>129</b>
PCI and PCI Express Cards . . . . .	129
<b>Bezel . . . . .</b>	<b>136</b>
Removing the Bezel. . . . .	136
Replacing the Bezel. . . . .	137
<b>Drives. . . . .</b>	<b>138</b>
Recommended Drive Cable Connections. . . . .	139
Connecting Drive Cables . . . . .	139
Drive Interface Connectors. . . . .	139
Connecting and Disconnecting Drive Cables. . . . .	140
Hard Drives . . . . .	140
Floppy Drive (Optional) . . . . .	145
Media Card Reader . . . . .	151
CD/DVD Drive . . . . .	154
<b>Battery . . . . .</b>	<b>160</b>
Replacing the Battery. . . . .	160
<b>Power Supply . . . . .</b>	<b>161</b>
Replacing the Power Supply . . . . .	162
<b>I/O Panel . . . . .</b>	<b>163</b>
Removing the I/O Panel. . . . .	164
Installing the I/O Panel . . . . .	165



<b>Processor Fan</b> . . . . .	<b>165</b>
Removing the Processor Fan/Heat Sink Assembly . . . . .	166
Installing the Processor Fan/Heat Sink Assembly . . . . .	167
<b>Processor</b> . . . . .	<b>168</b>
Removing the Processor . . . . .	168
Installing the Processor . . . . .	170
<b>Chassis Fan</b> . . . . .	<b>172</b>
Removing the Chassis Fan . . . . .	172
Replacing the Chassis Fan . . . . .	173
<b>System Board</b> . . . . .	<b>174</b>
Removing the System Board . . . . .	174
Installing the System Board . . . . .	176
Replacing the Computer Cover . . . . .	176
<b>A Appendix</b> . . . . .	<b>179</b>
<b>Specifications</b> . . . . .	<b>179</b>
Inspiron 530/530a/530c . . . . .	179
Inspiron 530b/530d . . . . .	182
Inspiron 530/530a/530b/530c/530d . . . . .	185
<b>System Setup</b> . . . . .	<b>187</b>
Overview . . . . .	187
Entering System Setup . . . . .	188
System Setup Options . . . . .	189
Boot Sequence . . . . .	191

<b>Clearing Forgotten Passwords</b> . . . . .	<b>193</b>
Inspiron 530 . . . . .	193
Inspiron 530a . . . . .	194
Inspiron 530b . . . . .	194
Inspiron 530c . . . . .	195
Inspiron 530d . . . . .	195
<b>Clearing CMOS Settings</b> . . . . .	<b>196</b>
<b>Flashing the BIOS</b> . . . . .	<b>197</b>
<b>Cleaning Your Computer</b> . . . . .	<b>198</b>
Computer, Keyboard, and Monitor . . . . .	198
Mouse . . . . .	198
Floppy Drive (Optional) . . . . .	199
CDs and DVDs . . . . .	199
<b>Dell Technical Support Policy (U.S. Only)</b> . . . . .	<b>199</b>
Definition of "Dell-Installed" Software and Peripherals . . . . .	200
Definition of "Third-Party" Software and Peripherals . . . . .	200
<b>FCC Notice (U.S. Only)</b> . . . . .	<b>200</b>
FCC Class B . . . . .	200
<b>Contacting Dell</b> . . . . .	<b>202</b>
 Glossary . . . . .	 203
 Index . . . . .	 219

# Finding Information

 **NOTE:** Some features or media may be optional and may not ship with your computer. Some features or media may not be available in certain countries.

 **NOTE:** Additional information may ship with your computer.

---

## What Are You Looking For?

## Find it Here

- Warranty information
- Terms and Conditions (U.S. only)
- Safety instructions
- Regulatory information
- Ergonomics information
- End User License Agreement

### Dell™ Product Information Guide



- 
- How to set up my computer

### Setup Diagram

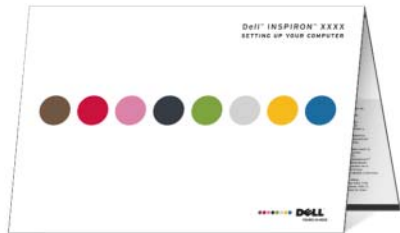

- 
- Model Number

See the back of your computer for the model number.

**NOTE:** If there is no label present, the model number is Inspiron 530.

---

**What Are You Looking For?**

- Service Tag and Express Service Code
- Microsoft Windows License Label

**Find it Here****Service Tag and Microsoft® Windows® License**

These labels are located on your computer.

- Use the Service Tag to identify your computer when you use [support.dell.com](http://support.dell.com) or contact support.



- Enter the Express Service Code to direct your call when contacting support.

- 
- Solutions — Troubleshooting hints and tips, articles from technicians, and online courses, frequently asked questions
  - Community — Online discussion with other Dell customers
  - Upgrades — Upgrade information for components, such as memory, the hard drive, and the operating system
  - Customer Care — Contact information, service call and order status, warranty, and repair information
  - Service and support — Service call status and support history, service contract, online discussions with technical support
  - Reference — Computer documentation, details on my computer configuration, product specifications, and white papers
  - Downloads — Certified drivers, patches, and software updates

**Dell Support Website — [support.dell.com](http://support.dell.com)**

**NOTE:** Select your region to view the appropriate support site.

**NOTE:** Corporate, government, and education customers can also use the customized Dell Premier Support website at [premier.support.dell.com](http://premier.support.dell.com).

What Are You Looking For?	Find it Here
<ul style="list-style-type: none"> <li>• Desktop System Software (DSS)— If you reinstall the operating system for your computer, you should also reinstall the DSS utility. DSS provides critical updates for your operating system and support for Dell™ 3.5-inch USB floppy drives, optical drives, and USB devices. DSS is necessary for correct operation of your Dell computer. The software automatically detects your computer and operating system and installs the updates appropriate for your configuration.</li> </ul>	<p>To download Desktop System Software:</p> <ol style="list-style-type: none"> <li><b>1</b> Go to <a href="http://support.dell.com">support.dell.com</a> and click <b>Drivers and Downloads</b>.</li> <li><b>2</b> Click <b>Select Model</b>.</li> <li><b>3</b> Select your product model and click <b>Confirm</b>, or enter a service tag and click <b>Go</b>.</li> <li><b>4</b> Click <b>System Utilities</b>.</li> <li><b>5</b> Click <b>Desktop System Software</b> under <b>Dell - Utility</b>, and click <b>Download Now</b>.</li> <li><b>6</b> Click <b>Run</b> to run the driver, or <b>Save</b> to save the driver to your computer.</li> </ol> <p><b>NOTE:</b> The <a href="http://support.dell.com">support.dell.com</a> user interface may vary depending on your selections.</p> <p><b>NOTE:</b> DSS may or may not be available for your desktop model.</p>
<ul style="list-style-type: none"> <li>• How to use your Windows® operating system</li> <li>• How to work with programs and files</li> <li>• How to personalize my desktop</li> </ul>	<p><b>Windows Help and Support</b></p> <ol style="list-style-type: none"> <li><b>1</b> To access Windows Help and Support: <ul style="list-style-type: none"> <li>• In Windows XP, click <b>Start</b> and click <b>Help and Support</b>.</li> <li>• In Windows Vista®, click the Windows Vista Start button  and click <b>Help and Support</b>.</li> </ul> </li> <li><b>2</b> Type a word or phrase that describes your problem, and then click the arrow icon.</li> <li><b>3</b> Click the topic that describes your problem.</li> <li><b>4</b> Follow the instructions on the screen.</li> </ol>





# 2

## Setting Up and Using Your Computer

### Front View of the Computer

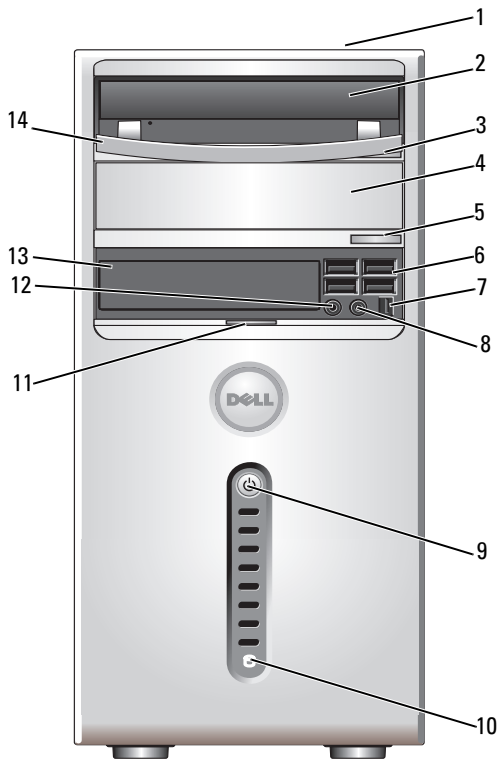
Inspiron 530/530a/530c





- |    |  |  |
|----|--|--|
| 1  | Service Tag (located on top of the chassis towards the back) | Use the Service Tag to identify your computer when you access the Dell Support website or call technical support.  |
| 2  | CD/DVD drive   | Use the CD/DVD drive for playing a CD/DVD.   |
| 3  | CD/DVD eject button  | Press to eject a disk from the CD or DVD drive.  |
| 4  | optional CD/DVD drive bay                                    | Can contain an optional CD/DVD drive.  |
| 5  | optional CD/DVD eject button                                 | Press to eject a disk from the optional CD or DVD drive.   |
| 6  | USB 2.0 connectors (4)                                       | Use the front USB connectors for devices that you connect occasionally, such as joysticks or cameras, or for bootable USB devices (see "System Setup Options" on page 189 for more information on booting to a USB device).<br>It is recommended that you use the back USB connectors for devices that typically remain connected, such as printers and keyboards. |
| 7  | IEEE 1394 connector (optional)                               | Attach high-speed serial multimedia devices, such as digital video cameras.  |
| 8  | headphone connector  | Use the headphone connector to attach headphones and most kinds of speakers.   |
| 9  | power button, power light                                    | Press the power button to turn on the computer. The light in the center of this button indicates power state. See "Controls and Lights" on page 185 for more information.  |
|    |  |  <b>NOTICE:</b> To avoid losing data, do not use the power button to turn off the computer. Instead, perform an operating system shutdown.  |
| 10 | drive activity light   | The drive activity light is on when the computer reads data from or writes data to the hard drive. The light might also be on when a device such as a CD player is operating.  |
| 11 | front panel door grip  | Slide up the front panel door grip to cover the FlexBay drive, four Universal Serial Bus (USB) connectors, one headphone connector, and one microphone connector.  |

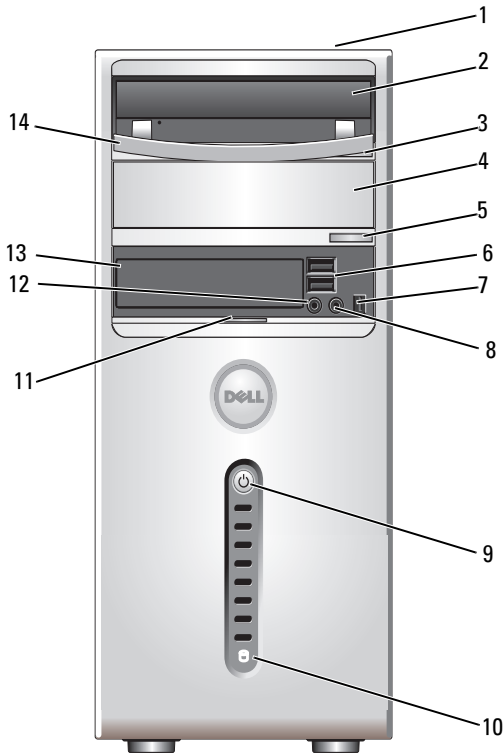

- 12 microphone connector      Use the microphone connector to attach a personal computer microphone for voice or musical input into a sound or telephony program. On computers with a sound card, the microphone connector is on the card.
- 13 FlexBay drive              Can contain an optional floppy drive or optional Media Card Reader.
- 14 CD/DVD drive panel      This panel covers the CD/DVD drive. (Shown in open position)

**Inspiron 530b/530d**



- |    |  |  |
|----|--|--|
| 1  | Service Tag (located on top of the chassis towards the back) | Use the Service Tag to identify your computer when you access the Dell Support website or call technical support.  |
| 2  | CD/DVD drive   | Use the CD/DVD drive for playing a CD/DVD.   |
| 3  | CD/DVD eject button  | Press to eject a disk from the CD or DVD drive.  |
| 4  | optional CD/DVD drive bay                                    | Can contain an optional CD/DVD drive.  |
| 5  | optional CD/DVD eject button                                 | Press to eject a disk from the optional CD or DVD drive.   |
| 6  | USB 2.0 connectors (2)                                       | Use the front USB connectors for devices that you connect occasionally, such as joysticks or cameras, or for bootable USB devices (see "System Setup Options" on page 189 for more information on booting to a USB device).<br>It is recommended that you use the back USB connectors for devices that typically remain connected, such as printers and keyboards. |
| 7  | IEEE 1394 connector (optional)                               | Attach high-speed serial multimedia devices, such as digital video cameras.  |
| 8  | headphone connector  | Use the headphone connector to attach headphones and most kinds of speakers.   |
| 9  | power button, power light                                    | Press the power button to turn on the computer. The light in the center of this button indicates power state. See "Controls and Lights" on page 185 for more information.  |
|    |  |  <b>NOTICE:</b> To avoid losing data, do not use the power button to turn off the computer. Instead, perform an operating system shutdown.  |
| 10 | drive activity light   | The drive activity light is on when the computer reads data from or writes data to the hard drive. The light might also be on when a device such as a CD player is operating.  |
| 11 | front panel door grip  | Slide up the front panel door grip to cover the FlexBay drive, four Universal Serial Bus (USB) connectors, one headphone connector, and one microphone connector.  |

- 12 microphone connector      Use the microphone connector to attach a personal computer microphone for voice or musical input into a sound or telephony program. On computers with a sound card, the microphone connector is on the card.
- 13 FlexBay drive              Can contain an optional floppy drive or optional Media Card Reader.
- 14 CD/DVD drive panel      This panel covers the CD/DVD drive. (Shown in open position)

## Back View of the Computer

### Inspiron 530/530a/530c

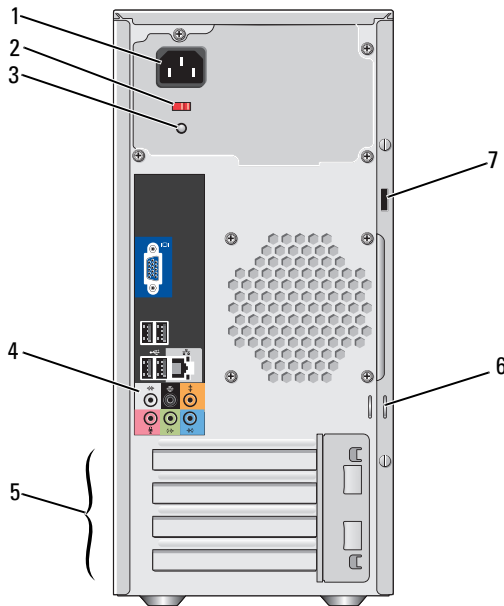

- |   |                         |   |
|---|-------------------------|---|
| 1 | power connector         | Insert the power cable.   |
| 2 | voltage selector switch | For selecting voltage rating.   |
| 3 | power supply light      | Indicates power availability for power supply.  |
| 4 | back panel connectors   | Plug USB, audio, and other devices into the appropriate connector. See "Back Panel Connectors" on page 22 for more information.   |
| 5 | card slots              | Access connectors for any installed PCI and PCI Express cards.  |
| 6 | padlock rings           | Padlock rings are for attaching a commercially available theft-deterrent device. The padlock rings allow you to secure the computer cover to the chassis with a padlock to prevent unauthorized access to the inside of the computer. To use the padlock rings, insert a commercially available padlock through the rings, and then lock the padlock. |
| 7 | security cable slot     | Security cable slot lets you attach a commercially available antitheft device to the computer. For more information, see the instructions included with the device.   |



**CAUTION: Ensure that none of the system air vents are blocked. Blocking them can cause serious thermal problems.**

# Inspiron 530b/530d

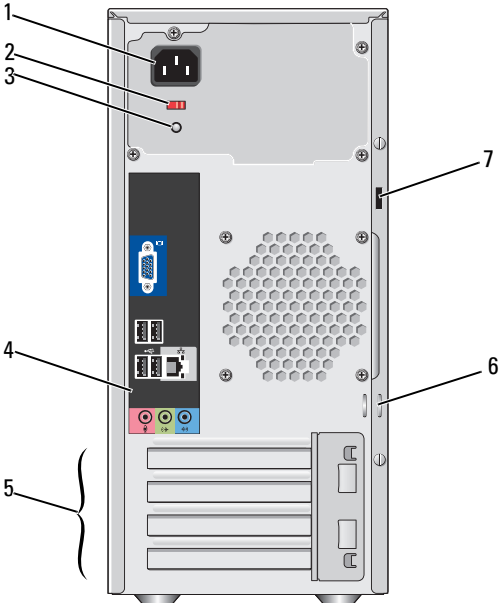

- 1 **power connector**     Insert the power cable.
- 2 **voltage selector switch**     For selecting voltage rating.
- 3 **power supply light**     Indicates power availability for power supply.
- 4 **back panel connectors**     Plug USB, audio, and other devices into the appropriate connector. See "Back Panel Connectors" on page 22 for more information.
- 5 **card slots**     Access connectors for any installed PCI and PCI Express cards.
- 6 **padlock rings**     Padlock rings are for attaching a commercially available theft-deterrent device. The padlock rings allow you to secure the computer cover to the chassis with a padlock to prevent unauthorized access to the inside of the computer. To use the padlock rings, insert a commercially available padlock through the rings, and then lock the padlock.
- 7 **security cable slot**     Security cable slot lets you attach a commercially available antitheft device to the computer. For more information, see the instructions included with the device.

## Back Panel Connectors

### Inspiron 530/530a/530c

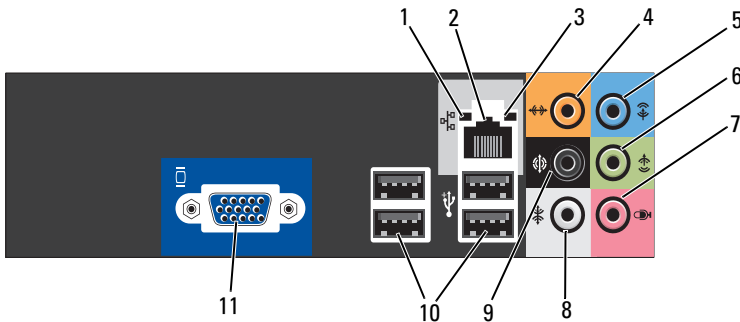

- |   |                                   |   |
|---|-----------------------------------|---|
| 1 | <b>network activity light</b>     | Flashes a yellow light when the computer is transmitting or receiving network data. A high volume of network traffic may make this light appear to be in a steady "on" state.   |
| 2 | <b>network adapter connector</b>  | <p>To attach your computer to a network or broadband device, connect one end of a network cable to either a network port or your network or broadband device. Connect the other end of the network cable to the network adapter connector on the back panel of your computer. A click indicates that the network cable has been securely attached.</p> <p><b>NOTE:</b> Do not plug a telephone cable into the network connector.</p> <p>On computers with a network connector card, use the connector on the card.</p> <p>It is recommended that you use Category 5 wiring and connectors for your network. If you must use Category 3 wiring, force the network speed to 10 Mbps to ensure reliable operation.</p> |
| 3 | <b>link integrity light</b>       | <ul style="list-style-type: none"> <li>• Green — A good connection exists between a 10/100-Mbps network and the computer.</li> <li>• Off — The computer is not detecting a physical connection to the network.</li> </ul>   |
| 4 | <b>center/subwoofer connector</b> | Use the orange connector to attach a speaker to a Low Frequency Effects (LFE) audio channel. LFE audio channel is found in digital surround sound audio schemes that carries only low frequency information of 80 Hz and below. The LFE channel drives a subwoofer to provide extremely low bass extension. Systems not using subwoofers can shunt the LFE information to the main speakers in the surround sound set-up.   |
| 5 | <b>line-in connector</b>          | Use the blue line-in connector to attach a record/playback device such as a cassette player, CD player, or VCR. On computers with a sound card, use the connector on the card.  |

- |    |                                     |  |
|----|-------------------------------------|--|
| 6  | <b>front L/R line-out connector</b> | Use the green line-out connector (available on computers with integrated sound) to attach headphones and most speakers with integrated amplifiers.<br>On computers with a sound card, use the connector on the card.                             |
| 7  | <b>microphone</b>                   | Use the pink connector to attach a personal computer microphone for voice or musical input into a sound or telephony program.<br>On computers with a sound card, the microphone connector is on the card.  |
| 8  | <b>side L/R surround connector</b>  | Use the gray connector to provide enhanced surround audio for computers with 7.1 speakers.<br>On computers with a sound card, the microphone connector is on the card.   |
| 9  | <b>rear L/R surround connector</b>  | Use the black surround connector to attach multichannel-capable speakers.  |
| 10 | <b>USB 2.0 connectors (4)</b>       | Use the back USB connectors for devices that typically remain connected, such as printers and keyboards.<br><br>It is recommended that you use the front USB connectors for devices that you connect occasionally, such as joysticks or cameras. |
| 11 | <b>VGA video connector</b>          | Connect the monitor's VGA cable to the VGA connector on the computer.<br><br>On computers with a video card, use the connector on the card.  |



## Inspiron 530b/530d

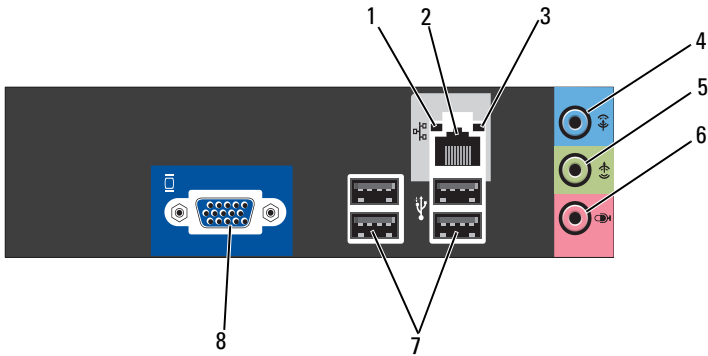

- |   |                                  |  |
|---|----------------------------------|--|
| 1 | <b>network activity light</b>    | Flashes a yellow light when the computer is transmitting or receiving network data. A high volume of network traffic may make this light appear to be in a steady "on" state.  |
| 2 | <b>network adapter connector</b> | To attach your computer to a network or broadband device, connect one end of a network cable to either a network port or your network or broadband device. Connect the other end of the network cable to the network adapter connector on the back panel of your computer. A click indicates that the network cable has been securely attached.<br><b>NOTE:</b> Do not plug a telephone cable into the network connector.<br><br>On computers with a network connector card, use the connector on the card.<br>It is recommended that you use Category 5 wiring and connectors for your network. If you must use Category 3 wiring, force the network speed to 10 Mbps to ensure reliable operation. |
| 3 | <b>link integrity light</b>      | <ul style="list-style-type: none"><li>• Green — A good connection exists between a 10/100-Mbps network and the computer.</li><li>• Off — The computer is not detecting a physical connection to the network.</li></ul>   |

- 4    **line-in connector / surround out**    Use the blue line-in connector to attach a record/playback device such as a cassette player, CD player, or VCR. On computers with a sound card, use the connector on the card.  
**NOTE:** To configure this connector to 5.1 - Channel, see "Configuring the Audio Connectors for 5.1-Channel" on page 33.
- 5    **front L/R line-out connector**    Use the green line-out connector (available on computers with integrated sound) to attach headphones and most speakers with integrated amplifiers. On computers with a sound card, use the connector on the card.
- 6    **microphone connector / center / sub woofer speaker out**    Use the pink connector to attach a personal computer microphone for voice or musical input into a sound or telephony program. On computers with a sound card, the microphone connector is on the card.  
**NOTE:** To configure this connector to 5.1 - Channel, see "Configuring the Audio Connectors for 5.1-Channel" on page 33.
- 7    **USB 2.0 connectors (4)**    Use the back USB connectors for devices that typically remain connected, such as printers and keyboards. It is recommended that you use the front USB connectors for devices that you connect occasionally, such as joysticks or cameras.
- 8    **VGA video connector**    Connect the monitor's VGA cable to the VGA connector on the computer. On computers with a video card, use the connector on the card.

# Installing Your Computer in an Enclosure

Installing your computer in an enclosure can restrict the airflow and impact your computer's performance, possibly causing it to overheat. Follow the guidelines below when installing your computer in an enclosure:

- ➔ **NOTICE:** The operating temperature specifications indicated in this Owner's Manual reflects the maximum ambient operating temperature. The room ambient temperature needs to be a consideration when installing your computer in an enclosure. For example, if the ambient room temperature is at 25° C (77° F), depending on your computer's specifications, you only have 5° to 10° C (9° to 18° F) temperature margin before you reach your computer's maximum operating temperature. For details about your computer's specifications, see "Specifications" on page 179.
- Leave a 10.2 cm (4 inches) minimum clearance on all vented sides of the computer to permit the airflow required for proper ventilation.
- If your enclosure has doors, they need to be of a type that allows at least 30% airflow through the enclosure (front and back).

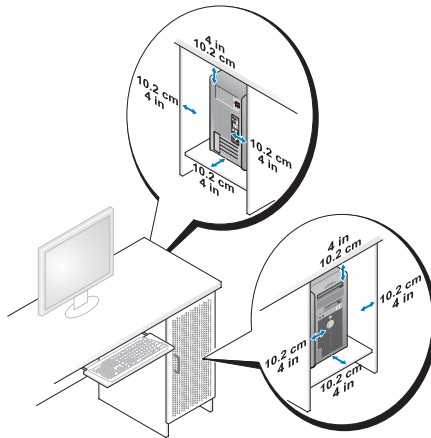

- If your computer is installed in a corner on a desk or under a desk, leave at least 5.1 cm (2 inches) clearance from the back of the computer to the wall to permit the airflow required for proper ventilation.

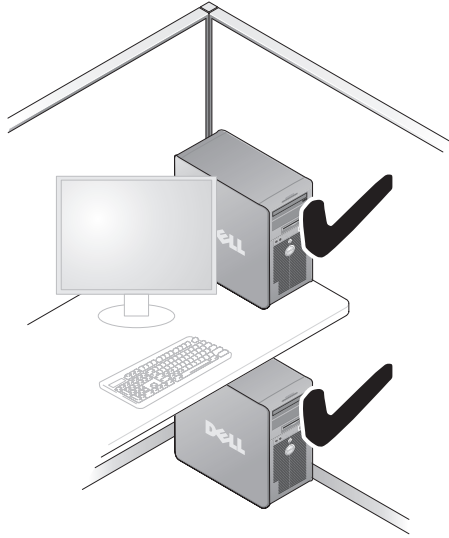

- Do not install your computer in an enclosure that does not allow airflow. Restricting the airflow impacts your computer's performance, possibly causing it to overheat.

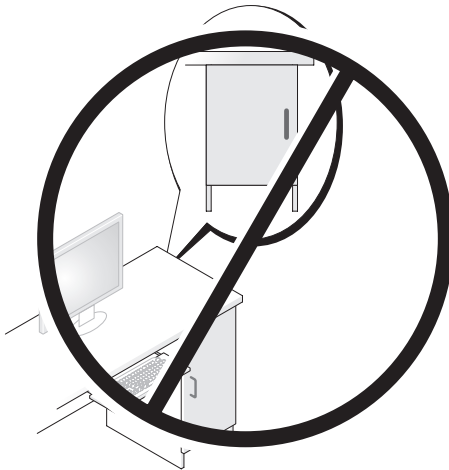

# Setting Up a Printer



**NOTICE:** Complete the operating system setup before you connect a printer to the computer.

See the documentation that came with the printer for setup information, including how to:

- Obtain and install updated drivers.
- Connect the printer to the computer.
- Load paper and install the toner or ink cartridge.

For technical assistance, refer to the printer owner's manual or contact the printer manufacturer.

## Printer Cable

Your printer connects to your computer with either a USB cable or a parallel cable. Your printer may not come with a printer cable, so if you purchase a cable separately, ensure that it is compatible with your printer and computer. If you purchased a printer cable at the same time you purchased your computer, the cable may arrive in the computer's shipping box.

## Connecting a USB Printer



**NOTE:** You can connect USB devices while the computer is turned on.

- 1 Complete the operating system setup if you have not already done so.
- 2 Attach the USB printer cable to the USB connectors on the computer and the printer. The USB connectors fit only one way.

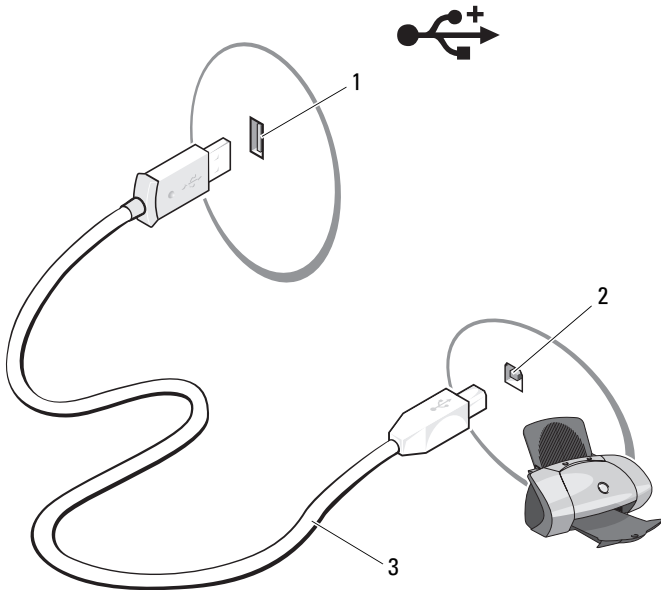

- 1 USB connector on computer      2 USB connector on printer      3 USB printer cable

- 3 Turn on the printer and then turn on the computer.
- 4 Depending on your computer's operating system, a printer wizard may be available to help you install the printer driver:  
If your computer is running the Microsoft® Windows® XP operating system and the **Add New Hardware Wizard** window appears, click **Cancel**.  
If your computer is running the Windows Vista® operating system, click the Windows Vista Start button , and click **Network**→ **Add a printer** to start the **Add Printer Wizard**.
- 5 Install the printer driver if necessary. See "Reinstalling Drivers and Utilities" on page 95 and the documentation that came with your printer.

## Playing CDs and DVDs

**➡ NOTICE:** Do not press down on the CD or DVD tray when you open or close it. Keep the tray closed when you are not using the drive.

**➡ NOTICE:** Do not move the computer when you are playing CDs or DVDs.

- 1 Press the eject button on the front of the drive.
- 2 Place the disc, label side up, in the center of the tray.











- 3 Press the eject button or gently push in the tray.

To format CDs for storing data, to create music CDs, or to copy CDs, see the CD software that came with your computer.

**✍ NOTE:** Ensure that you follow all copyright laws when you create CDs.

A CD player includes the following basic buttons:











---

	Play
	Move backward within the current track
	Pause
	Move forward within the current track
	Stop
	Go to the previous track
	Eject
	Go to the next track

---

A DVD player includes the following basic buttons:

---

	Stop
	Restart the current chapter
	Play
	Fast forward
	Pause
	Fast reverse
	Advance a single frame while in pause mode
	Go to the next title or chapter
	Continuously play the current title or chapter
	Go to the previous title or chapter
	Eject

---

For more information on playing CDs or DVDs, click **Help** on the CD or DVD player (if available).

## Adjusting the Volume

 **NOTE:** When the speakers are muted, you do not hear the CD or DVD playing.

Microsoft® Windows® XP:

- 1 Click **Start**, point to **Control Panel**→ **Sounds**, and then click **Audio Devices**.
- 2 Under the **Volume** tab, click and drag the device volume slider to adjust the sound volume.

Windows Vista®:

- 1 Click **Start** , point to **Control Panel**→ **Hardware and Sound**→ **Sound**, and then click **Adjust System Volume**.
- 2 In the **Volume Mixer** window, click and drag the bar in the **Speakers** column and slide it up or down to increase or decrease the volume.



## Configuring the Audio Connectors for 5.1-Channel



**NOTE:** The following is applicable only for Inspiron 530b/530d.

Windows XP:

- 1 Click **Start**, point to **Control Panel**→ **Sounds**→ **Audio devices**→ **Volume**.
- 2 Under **Speaker settings** click **Advanced**.
- 3 Under **Speaker Setup** choose **Surround sound 5.1 setup**.

Windows Vista:

- 1 Click **Start** , point to **Control Panel**→ **Hardware and Sound**→ **Sound**.
- 2 Under the **Playback** tab select **Speakers/Headphones**. Click on **Configure** and select **5.1 Surround**. Click **Next**.
- 3 Under **Speaker Setup**, customize your configuration by selecting the check boxes for **Optional speakers**. Click **Next**.
- 4 Select the check boxes for **Full-range speakers**. Click **Next**→ **Finish**.

## Adjusting the Picture

If an error message notifies you that the current resolution and color depth are using too much memory and preventing DVD playback, adjust the display properties:

Windows XP:

- 1 Click **Start**→ **Control Panel**→ **Appearance and Themes**.
- 2 Under **Pick a task...**, click **Change the screen resolution**.
- 3 Under **Screen resolution**, click and drag the bar to reduce the resolution setting.
- 4 In the drop-down menu under **Color quality**, click **Medium (16 bit)** and click **OK**.

Windows Vista:

- 1 Click **Start** , click **Control Panel**, and then click **Appearance and Personalization**.
- 2 Under **Personalization**, click **Adjust Screen Resolution**.  
The **Display Properties** window appears.
- 3 Under **Resolution**: click and drag the bar reduce the resolution setting.
- 4 In the drop-down menu under **Colors**:, click **Medium (16 bit)**.
- 5 Click **OK**.

## Copying CDs and DVDs

 **NOTE:** Ensure that you observe all copyright laws when creating CDs or DVDs.

This section applies only to computers that have a CD-RW, DVD+/-RW, or CD-RW/DVD (combo) drive.

 **NOTE:** The types of CD or DVD drives offered by Dell may vary by country.

The following instructions explain how to make an exact copy of a CD or DVD. You can also use Sonic DigitalMedia for other purposes, such as creating music CDs from audio files stored on your computer or backing up important data. For help, open Sonic DigitalMedia and then click the question mark icon in the upper-right corner of the window.

### How to Copy a CD or DVD

 **NOTE:** CD-RW/DVD combo drives cannot write to DVD media. If you have a CD-RW/DVD combo drive and you experience recording problems, check for available software patches on the Sonic support website at [www.sonic.com](http://www.sonic.com).

The DVD-writable drives installed in Dell™ computers can write to and read DVD+/-R, DVD+/-RW and DVD+R DL (dual layer) media, but cannot write to and may not read DVD-RAM or DVD-R DL media.

 **NOTE:** Most commercial DVDs have copyright protection and cannot be copied using Sonic DigitalMedia.

- 1 Click **Start**  → **All Programs** → **Sonic** → **DigitalMedia Projects** → **Copy** → **Disc Copy**.
- 2 To copy the CD or DVD:
  - *If you have one CD or DVD drive*, ensure that the settings are correct and click the **Disc Copy** button. The computer reads your source CD or DVD and copies the data to a temporary folder on your computer hard drive.  
When prompted, insert a blank CD or DVD into the drive and click **OK**.
  - *If you have two CD or DVD drives*, select the drive into which you have inserted your source CD or DVD and click the **Disc Copy** button. The computer copies the data from the source CD or DVD to the blank CD or DVD.

Once you have finished copying the source CD or DVD, the CD or DVD that you have created automatically ejects.

## Using Blank CDs and DVDs

CD-RW drives can write to CD recording media only (including high-speed CD-RW) while DVD-writable drives can write to both CD and DVD recording media.

Use blank CD-Rs to record music or permanently store data files. After creating a CD-R, you cannot write to that CD-R again (see the Sonic documentation for more information). Use blank CD-RWs to write to CDs or to erase, rewrite, or update data on CDs.

Blank DVD+/-Rs can be used to permanently store large amounts of information. After you create a DVD+/-R disc, you may not be able to write to that disc again if the disc is "finalized" or "closed" during the final stage of the disc creation process. Use blank DVD+/-RWs if you plan to erase, rewrite, or update information on that disc later.

### CD-Writable Drives

Media Type	Read	Write	Rewritable
CD-R	Yes	Yes	No
CD-RW	Yes	Yes	Yes

### DVD-Writable Drives

Media Type	Read	Write	Rewritable
CD-R	Yes	Yes	No
CD-RW	Yes	Yes	Yes
DVD+R	Yes	Yes	No
DVD-R	Yes	Yes	No
DVD+RW	Yes	Yes	Yes
DVD-RW	Yes	Yes	Yes
DVD+R DL	Yes	Yes	No

## Helpful Tips

- Use Microsoft® Windows® Explorer to drag and drop files to a CD-R or CD-RW only after you start Sonic DigitalMedia and open a DigitalMedia project.
- Use CD-Rs to burn music CDs that you want to play in regular stereos. CD-RWs do not play in most home or car stereos.
- You cannot create audio DVDs with Sonic DigitalMedia.
- Music MP3 files can be played only on MP3 players or on computers that have MP3 software installed.
- Commercially available DVD players used in home theater systems may not support all available DVD formats. For a list of formats supported by your DVD player, see the documentation provided with your DVD player or contact the manufacturer.
- Do not burn a blank CD-R or CD-RW to its maximum capacity; for example, do not copy a 650-MB file to a blank 650-MB CD. The CD-RW drive needs 1–2 MB of the blank space to finalize the recording.
- Use a blank CD-RW to practice CD recording until you are familiar with CD recording techniques. If you make a mistake, you can erase the data on the CD-RW and try again. You can also use blank CD-RWs to test music file projects before you record the project permanently to a blank CD-R.
- See the Sonic website at [www.sonic.com](http://www.sonic.com) for additional information.

## Using a Media Card Reader (Optional)

Use the Media Card Reader to transfer data directly to your computer.

The Media Card Reader supports the following memory types:

- xD-Picture Card
- SmartMedia (SMC)
- CompactFlash Type I and II (CF I/II)
- MicroDrive Card
- SecureDigital Card (SD)
- MultiMediaCard (MMC)
- Memory Stick (MS/MS Pro)

For information on installing a Media Card Reader, see "Installing a Media Card Reader" on page 152.

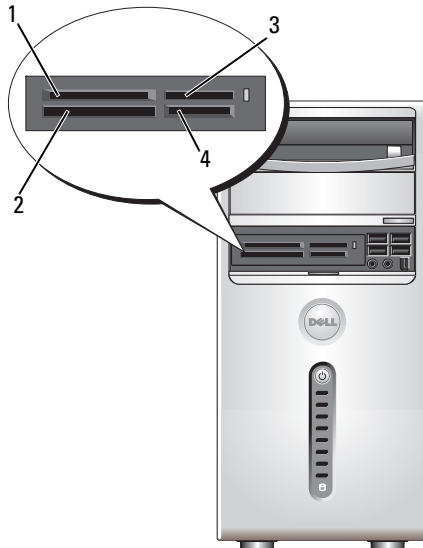

- |   |                                      |   |  |
|---|--------------------------------------|---|--|
| 1 | xD-Picture Card and SmartMedia (SMC) | 2 | CompactFlash Type I and II (CF I/II) and MicroDrive Card |
| 3 | Memory Stick (MS/MS Pro)             | 4 | SecureDigital Card (SD)/ MultiMediaCard (MMC)            |

To use the Media Card Reader:

- 1 Check the media or card to determine the proper orientation for insertion.
- 2 Slide the media or card into the appropriate slot until it is completely seated in the connector.

If you encounter resistance, do not force the media or card. Check the card orientation and try again.

## Connecting Two Monitors

 **CAUTION:** Before you begin any of the procedures in this section, follow the safety instructions in the *Product Information Guide*.

If you purchased a graphics card that supports dual monitors, follow these instructions to connect and enable your monitors. The instructions tell you how to connect either two monitors (each with a VGA connector), one monitor with a VGA connector and one monitor with a DVI connector, or a TV.

 **NOTICE:** If you are connecting two monitors that have VGA connectors, you must have the optional DVI adapter to connect the cable. If you are connecting two flat-panel monitors, at least one of them must have a VGA connector. If you are connecting a TV, you may connect only one monitor (VGA or DVI) in addition to the TV.

### Connecting Two Monitors With VGA Connectors

- 1 Follow the procedures in "Before You Begin" on page 105.
-  **NOTE:** If your computer has integrated video, do not connect either monitor to the integrated video connector. If the integrated video connector is covered by a cap, do not remove the cap to connect the monitor or the monitor will not function.
- 2 Connect one of the monitors to the VGA (blue) connector on the back of the computer.
- 3 Connect the other monitor to the optional DVI adapter and connect the DVI adapter to the DVI (white) connector on the back of the computer.

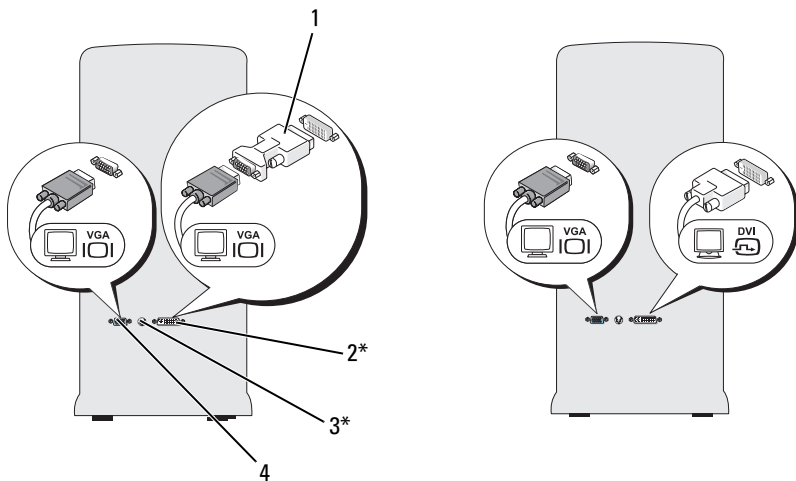

\*May not be present on your computer

- |                        |                         |
|------------------------|-------------------------|
| 1 optional DVI adapter | 2 DVI (white) connector |
| 3 TV-OUT connector     | 4 VGA (blue) connector  |

## Connecting One Monitor With a VGA Connector and One Monitor With a DVI Connector

- 1 Follow the procedures in "Before You Begin" on page 105.
- 2 Connect the VGA connector on the monitor to the VGA (blue) connector on the back of the computer.
- 3 Connect the DVI connector on the other monitor to the DVI (white) connector on the back of the computer.

## Connecting a TV

**NOTE:** You must purchase an S-video cable, available at most consumer electronics stores, to connect a TV to your computer. It is not included with your computer.

- 1 Follow the procedures in "Before You Begin" on page 105.
- 2 Connect one end of the S-video cable to the optional TV-OUT connector on the back of the computer.

- 3 Connect the other end of the S-video cable to the S-video input connector on your TV.
- 4 Connect the VGA or DVI monitor.

## Changing the Display Settings

- 1 After you connect the monitor(s) or TV, turn on the computer. The Microsoft® Windows® desktop displays on the primary monitor.
- 2 Enable extended desktop mode in the display settings. In extended desktop mode, you can drag objects from one screen to the other, effectively doubling the amount of viewable work space.

## Power Management

### Power Management Options in Microsoft® Windows® XP

The Microsoft® Windows® XP power management features can reduce the amount of electricity your computer uses when it is on and you are not using it. You can reduce power to just the monitor or the hard drive, or you can use standby mode or hibernate mode to reduce power to the entire computer. When the computer exits from a power conservation mode, it returns to the operating state it was in prior to entering the mode.



**NOTE:** Windows XP Professional includes security and networking features not available in Windows XP Home Edition. When a Windows XP Professional computer is connected to a network, different options related to security and networking appear in certain windows.



**NOTE:** The procedures to activate the standby and hibernate modes may vary according to your operating system.

### Standby Mode

Standby mode conserves power by turning off the display and the hard drive after a designated period of time, known as a time-out. When the computer exits from standby mode, it returns to the operating state it was in prior to entering standby mode.



**NOTICE:** If your computer loses power while in standby mode, it may lose data.



 **NOTICE:** The graphics card in your computer is installed in the PCI Express x16 slot. When there is a card in this slot and you add a peripheral that does not support s3 suspend, your computer will not enter standby mode.

To set standby mode to automatically activate after a defined period of inactivity:

- 1 Click the **Start** button, then click **Control Panel**.
- 2 Define your standby settings on the **Power Schemes** tab and **Advanced** tab.

To immediately activate standby mode without a period of inactivity, click the **Start** button, click **Turn Off Computer**, and then click **Stand by**.

To exit from standby mode, press a key on the keyboard or move the mouse.

## **Hibernate Mode**

Hibernate mode conserves power by copying system data to a reserved area on the hard drive, and then completely turning off the computer. When the computer exits from hibernate mode, the desktop is restored to the state it was in prior to entering hibernate mode.

To activate hibernate mode:

- 1 Click the **Start** button, then click **Control Panel**.
- 2 Define your hibernate settings on the **Power Schemes** tab, **Advanced** tab, and **Hibernate** tab.

To exit from hibernate mode, press the power button. The computer may take a short time to exit from hibernate mode. Because the keyboard and the mouse do not function when the computer is in hibernate mode, pressing a key on the keyboard or moving the mouse does not bring the computer out of hibernation.

Because hibernate mode requires a special file on your hard drive with enough disk space to store the contents of the computer memory, Dell creates an appropriately sized hibernate mode file before shipping the computer to you. If the computer's hard drive becomes corrupted, Windows XP recreates the hibernate file automatically.

## Power Options Properties

Define your standby mode settings, hibernate mode settings, and other power settings in the **Power Options Properties** window. To access the **Power Options Properties** window:

- 1 Click the **Start** button, then click **Control Panel**.
- 2 Define your power settings on the **Power Schemes** tab, **Advanced** tab, and **Hibernate** tab.

### Power Schemes Tab

Each standard power setting is called a scheme. If you want to select one of the standard Windows schemes installed on your computer, choose a scheme from the **Power schemes** drop-down menu. The settings for each scheme appear in the fields below the scheme name. Each scheme has different settings for starting standby mode, hibernate mode, turning off the monitor, and turning off the hard drive.



**NOTICE:** If you set the hard drive to time-out before the monitor does, your computer may appear to be locked up. To recover, press any key on the keyboard or click the mouse. To avoid this problem, always set the monitor to time-out before the hard drive.

The **Power schemes** drop-down menu displays the following schemes:

- **Always On** (default) — If you want to use your computer with no power conservation.
- **Home/Office Desk** — If you use your computer as a home or office computer and you require minimal power conservation.
- **Minimal Power Management** — If you want your computer to run with minimal power conservation.
- **Max Battery** — If your computer is a portable computer and you run your computer from batteries for extended periods of time.

If you want to change the default settings for a scheme, click the drop-down menu in the **Turn off monitor**, **Turn off hard disks**, **System standby**, or **System hibernates** field, and then select a time-out from the displayed list. Changing the time-out for a scheme field permanently changes the default settings for that scheme, unless you click **Save As** and enter a new name for the changed scheme.

## Advanced Tab

The **Advanced** tab allows you to:

- Place the power options icon  in the Windows taskbar for quick access.
- Set the computer to prompt you for your Windows password before the computer exits from standby mode or hibernate mode.
- Program the power button to activate standby mode, activate hibernate mode, or turn off the computer.

To program these functions, click an option from the corresponding drop-down menu and click **OK**.

## Hibernate Tab

The **Hibernate** tab allows you to enable hibernate mode. If you want to use the hibernate settings as defined on the **Power Schemes** tab, click the **Enable hibernate support** check box on the **Hibernate** tab.

For more information on power management options:

- 1** Click the **Start** button, then click **Help and Support**.
- 2** In the **Help and Support** window, click **Performance and maintenance**.
- 3** In the **Performance and maintenance** window, click **Conserving power on your computer**.

## Power Management Options in Windows Vista®

The Windows Vista® power management features are designed to reduce the amount of electricity your computer uses when it is on and you are not using it. You can reduce power to just the monitor or the hard drive, and Windows Vista sets the default "off" state to standby mode or you can set hibernate mode to reduce power even further.

When the computer exits from a power conservation mode (Standby or Hibernate), the Windows desktop is restored to the state it was in before it entered the mode.

Windows Vista has three main default power management modes:

- Balanced
- Power Saver
- High Performance

Dell has added a fourth, **Dell-Recommended** mode that sets power management to the most typical settings for the majority of our customers. This is the active Power Plan.

## Standby Mode

Standby mode is the default "off" state for Windows Vista. Standby mode conserves power by turning off the display and the hard drive after a time-out. When the computer exits from standby mode, it returns to the operating state it was in before it entered standby mode.

To set standby mode to automatically activate after a defined period of inactivity:

- 1 Click **Start**  and click **Control Panel**.
- 2 Click **System and Maintenance**.
- 3 Under **System and Maintenance**, click **Power Options**.

The next dialog box will show three power plans - the top option is **Dell Recommended** - this is the currently active plan.

There is also a **show additional plans** arrow underneath the three power plans. You can have many power plans, but only three are displayed and the top one is the active plan.

To immediately activate standby mode without a period of inactivity, click **Start** , and then click the **off** button icon. Windows Vista sets **Standby** as the default off state.

To exit from standby mode, press a key on the keyboard or move the mouse.



**NOTICE:** If your computer loses power while in standby mode, it may lose data.

Windows Vista has a new feature called **Hybrid Sleep** mode - this saves the data into a file and also puts the system into standby. If you lose power, the system retains your data on the hard drive and resumes to the same state you left it. Go to **Help and Support** and search for **Hybrid Sleep** for further information. **Hybrid Sleep** provides fast wake if the system is in standby, but also keeps your data safe by storing it to the hard drive.

## Hibernate Mode

Hibernate mode conserves power by copying system data to a reserved area on the hard drive and then completely turning off the computer. When the computer exits from hibernate mode, the desktop is restored to the state it was in before it entered hibernate mode. Windows Vista may mask **Hibernate** from the user if Hybrid Sleep is enabled. See **Help and Support** for further information - search for **Hibernate**.

To activate hibernate mode immediately (if available):

- 1 Click **Start**  and click the **arrow** (pointing to the right) beside the **lock** icon.
- 2 Select **Hibernate** from the list.

To exit from hibernate mode, press the power button. The computer may take a short time to exit from hibernate mode. Pressing a key on the keyboard or moving the mouse does not bring the computer out of hibernation, because the keyboard and the mouse do not function when the computer is in hibernate mode.

Because hibernate mode requires a special file on your hard drive with enough disk space to store the contents of the computer memory, Dell creates an appropriately sized hibernate mode file before shipping the computer to you. If the computer's hard drive becomes corrupted, Windows Vista recreates the hibernate file automatically.

## **Power Plan Properties**

Define your standby mode settings, display mode settings, hibernate mode settings (if available), and other power settings in the **Power Plan Properties** window. To access the **Power Plan Properties** window:

- 1 Click **Start**  and click **Control Panel**.
- 2 Click **System and Maintenance**.
- 3 Under **System and Maintenance**, click **Power Options**.

This takes you to the main **Select a Power Plan** window.

- 4 In the **Select A Power Plan** window, you can change or modify power settings.

To change the default settings for a plan:

- 1 Click **Start** , and click **Control Panel**.
- 2 Under **Pick a category**, click **System and Maintenance**.
- 3 Under **System and Maintenance**, click **Power Options**.

A number of options are available on the left-hand side of the **Power Options** dialog box.

Click **Change Plan Settings** just below any of the power plans to change settings such as:

- Require a password on wakeup.
- Choose what power buttons do.
- Create a power plan (you can choose the settings you want and create a custom power plan here).
- Choose when to turn off the display
- Change when the computer sleeps.

### **Advanced Tab**

The Advanced tab allows you to set many different settings beyond the basic ones above. If you do not know or are not sure what to set, then leave settings at the default. To access the advanced settings:

- 1 Choose the **Power Plan** you want to change.
- 2 Click **Change Plan Settings** from just below the plan name.
- 3 Click **Change Advanced Power Settings**.

 **CAUTION: There are many different settings in the Power Options, Advanced Settings dialog box. Use care when making setting changes.**

Click **Start**  and then click **Help and Support** to explore the capabilities of the advanced settings.

## **Enabling SpeedStep™ Technology**

SpeedStep technology controls your computer's processor performance automatically, dynamically adjusting the operating frequency and voltage, according to the task at hand. When an application does not require full performance, significant amounts of power can be saved. Performance is designed to still be responsive, with maximum processor performance being delivered when required, and automatic power savings when possible.

Windows Vista automatically sets Intel Speedstep technologies in the **Dell Recommended**, **Balanced**, and **Power Saver** power plans. It is disabled in the **High Performance** power plan.

# About RAID Configurations

 **NOTE:** RAID is not supported on Inspiron 530b/530d.

This section provides an overview of the redundant array of independent disks (RAID) configuration you may have selected when you purchased your computer. Your computer supports RAID level 1. A RAID level 1 configuration is recommended for the data integrity requirements of digital photography and audio.

The Intel RAID controller on your computer can only create a RAID volume using two physical drives. If a third drive is present, then that drive cannot be made part of a RAID volume using the Intel RAID configuration program, although it can be used as a spare drive in a RAID 1 configuration. However, if four drives are present in your computer, then each pair of drives can be made into a RAID level 1 volume. The drives should be the same size in order to ensure that the larger drive does not contain unallocated (and therefore unusable) space.

## RAID Level 1 Configuration

RAID level 1 uses a data-redundancy storage technique known as "mirroring." When data is written to the primary drive, it is then duplicated, or mirrored, on the other drive. A RAID level 1 configuration sacrifices high data access rates for its data redundancy advantages.

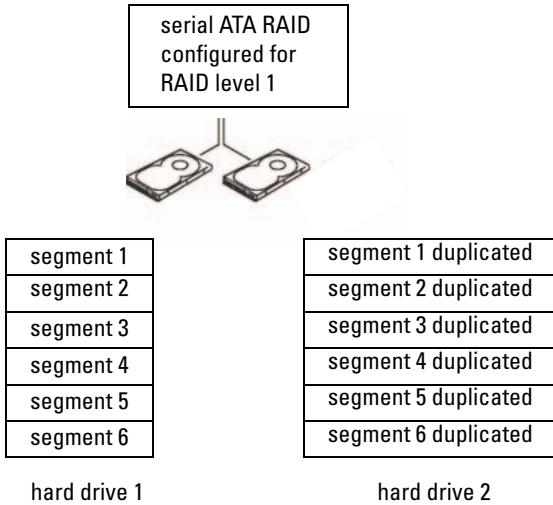

If a drive failure occurs, subsequent read and write operations are directed to the surviving drive. A replacement drive can then be rebuilt using the data from the surviving drive. Also, because data is duplicated on both drives, two 120-GB RAID level 1 drives collectively have a maximum of 120-GB on which to store data.

**NOTE:** In a RAID level 1 configuration, the size of the configuration is equal to the size of the smallest drive in the configuration.

### Configuring Your Hard Drives for RAID

Your computer can be configured for RAID even if you did not select a RAID configuration when you purchased your computer. You must have at least two hard drives installed in your computer to set up a RAID configuration. For instructions on how to install a hard drive, see "Hard Drives" on page 140.

You can use one of two methods to configure RAID hard drive volumes. One method uses the Intel® Option ROM utility, and is performed before you install the operating system onto the hard drive. The second method uses the Intel Matrix Storage Manager or Intel Storage Utility, and this method is performed after you have installed the operating system and the Intel Storage Utility. Both methods require that you set your computer to RAID-enabled mode before starting any of the RAID configuration procedures in this document. Both methods require that you set your computer to RAID-enabled mode before you begin.



## Setting Your Computer to RAID-Enabled Mode

- 1 Enter the system setup (see "Entering System Setup" on page 188).
- 2 Press the left- and right- arrow keys to highlight **Integrated Peripherals** and press <Enter>.
- 3 Press the up- and down- arrow keys to highlight **Drive Controller**, and then press <Enter>.
- 4 Press the up- and down- arrow keys to highlight **SATA Mode**, and then press <Enter> to access the options.
- 5 Press the up- and down- arrow keys to highlight **RAID**, and then press <Enter> to enable RAID.
- 6 Press <F10> to save and exit System Setup.

## Configuring for RAID Using the Intel® Option ROM Utility



**NOTE:** Although any size drives may be used to create a RAID configuration using the Intel Option ROM utility, ideally the drives should be of equal size. In a RAID level 0 configuration, the size of the array will be the size of the smallest disk multiplied by the number (two) of disks in the array. In a RAID level 1 configuration, the size of the array will be the smaller of the two disks used.

## Creating a RAID Level 1 Configuration

- 1 Set your computer to RAID-enabled mode (see "Setting Your Computer to RAID-Enabled Mode" on page 49).
- 2 Press <Ctrl><i> when you are prompted to enter Intel RAID Option ROM.
- 3 Use the up- and down-arrow keys to highlight **Create RAID Volume**, and press <Enter>.
- 4 Enter a RAID volume name or accept the default, and press <Enter>.
- 5 Use the up- and down-arrow keys to select **RAID1 (Mirror)**, and press <Enter>.
- 6 If there are more than two hard disks available, use the up- and down-arrow keys and space bar to select the two disks you want to use to make up your array, and then press <Enter>.
- 7 Select the desired capacity for the volume, and press <Enter>. The default value is the maximum available size.

- 8 Press <Enter> to create the volume.
- 9 Press <y> to confirm that you want to create the RAID volume.
- 10 Confirm that the correct volume configuration is displayed on the main Intel Option ROM screen.
- 11 Use the up- and down-arrow keys to select **Exit**, and press <Enter>.
- 12 Install the operating system.

### Deleting a RAID Volume



**NOTE:** When you perform this operation, all data on the RAID drives will be lost.



**NOTE:** If your computer currently boots to RAID and you delete the RAID volume in the Intel RAID Option ROM, your computer will become unbootable.

- 1 Press <Ctrl><i> when you are prompted to enter the Intel RAID Option ROM utility.
- 2 Use the up- and down-arrow keys to highlight **Delete RAID Volume**, and press <Enter>.
- 3 Use the up- and down-arrow keys to highlight the RAID volume you want to delete, and press <Delete>.
- 4 Press <y> to confirm the deletion of the RAID volume.
- 5 Press <Esc> to exit the Intel Option ROM utility.

### Configuring for RAID Using the Intel® Matrix Storage Manager

If you already have one hard drive with the operating system installed on it, and you want to add a second hard drive and reconfigure both drives into a RAID volume without losing the existing operating system and any data, you need to use the migrating option (see "Migrating to a RAID 1 Volume" on page 52). Create a RAID 1 Volume only when:

- You are adding two new drives to an existing single-drive computer (and the operating system is on the single drive), and you want to configure the two new drives into a RAID volume.
- You already have a two-hard drive computer configured into an array, but you still have some space left on the array that you want to designate as a second RAID volume.

## Creating a RAID 1 Volume



**NOTE:** When you perform this operation, all data on the RAID drives will be lost.

- 1 Set your computer to RAID-enabled mode (see "Setting Your Computer to RAID-Enabled Mode" on page 49).
- 2 Click **Start**  and point to **All Programs**→ **Intel<sup>®</sup> Matrix Storage Manager**→ **Intel Matrix Storage Console** to launch the Intel<sup>®</sup> Matrix Storage Manager.



**NOTE:** If you do not see an **Actions** menu option, you have not yet set your computer to RAID-enabled mode (see "Setting Your Computer to RAID-Enabled Mode" on page 49).

- 3 On the **Actions** menu, select **Create RAID Volume** to launch the Create RAID Volume Wizard.
- 4 Click **Next** at the first screen.
- 5 Confirm the volume name, select **RAID 1** as the RAID level, and then click **Next** to continue.
- 6 On the **Select Volume Location** screen, click the first hard drive you want to use to create your RAID 1 volume, and then click the right arrow. Click a second hard drive until two drives appear in the **Selected** window, and then click **Next**.
- 7 In the **Specify Volume Size** window, select the **Volume Size** desired and click **Next**.
- 8 Click **Finish** to create the volume, or click **Back** to make changes.
- 9 Follow Microsoft Windows procedures for creating a partition on the new RAID volume.

## Deleting a RAID Volume



**NOTE:** While this procedure deletes the RAID 1 volume, it also splits the RAID 1 volume into two non-RAID hard drives with a partition, and leaves any existing data files intact.

- 1 Click **Start**  and point to **All Programs**→ **Intel<sup>®</sup> Matrix Storage Manager**→ **Intel Matrix Storage Console** to launch the Intel<sup>®</sup> Matrix Storage Manager.
- 2 Right-click the **Volume** icon of the RAID volume you want to delete, and select **Delete Volume**.
- 3 On the **Delete RAID Volume Wizard** screen, click **Next**.
- 4 Highlight the RAID volume you want to delete in the **Available** box, click the right-arrow button to move the highlighted RAID volume into the **Selected** box, and then click **Next**.
- 5 Click **Finish** to delete the volume.

## Migrating to a RAID 1 Volume

- 1 Set your computer to RAID-enabled mode (see "Setting Your Computer to RAID-Enabled Mode" on page 49).
- 2 Click **Start**  and point to **All Programs**→ **Intel<sup>®</sup> Matrix Storage Manager**→ **Intel Matrix Storage Console** to launch the Intel<sup>®</sup> Matrix Storage Manager.



**NOTE:** If you do not see an **Actions** menu option, you have not yet set your computer to RAID-enabled mode (see "Setting Your Computer to RAID-Enabled Mode" on page 49).

- 3 On the **Actions** menu, click **Create RAID Volume From Existing Hard Drive** to launch the Migration Wizard.
- 4 Click **Next** on the first Migration Wizard screen.
- 5 Enter a RAID volume name or accept the default.
- 6 From the drop-down box, select **RAID 1** as the RAID level.



**NOTE:** Select the hard drive that already has the data or operating system files that you want to maintain on the RAID volume as your source hard drive.

- 7 On the **Select Source Hard Drive** screen, double-click the hard drive from which you want to migrate, and click **Next**.

- 8 On the **Select Member Hard Drive** screen, double-click the hard drive to select the member drive that you want to act as the mirror in the array, and click **Next**.
- 9 On the **Specify Volume Size** screen, select the volume size you want, and click **Next**.



**NOTE:** In the following step, you will lose all data contained on the member drive.

- 10 Click **Finish** to start migrating, or click **Back** to make changes. You can use your computer normally during migration process.

### Creating a Spare Hard Drive

A spare hard drive may be created with a RAID 1 array. The spare hard drive is not recognized by the operating system, but you can see the spare drive from within Disk Manager or the Intel Option ROM Utility. When a member of the RAID 1 array is broken, the computer automatically rebuilds the mirror array using the spare hard drive as the broken member's replacement.

To Mark a Drive as a Spare Hard Drive:

- 1 Click **Start**  and point to **All Programs**→ **Intel<sup>®</sup> Matrix Storage Manager**→ **Intel Matrix Storage Console** to launch the Intel<sup>®</sup> Matrix Storage Manager.
- 2 Right-click the hard drive you want to mark as a spare hard drive.
- 3 Click **Mark as Spare**.

To Remove Spare Marking From a Spare Hard Drive:

- 1 Right-click the spare hard drive icon.
- 2 Click **Reset Hard Drive to Non-RAID**.

## Rebuilding a Degraded RAID 1 Volume

If your computer does not have a spare hard drive, and the computer has reported a degraded RAID 1 volume, you can manually rebuild the computer's redundancy mirror to a new hard drive by performing the following steps:

- 1 Click **Start**  and point to **All Programs**→ **Intel<sup>®</sup> Matrix Storage Manager**→ **Intel Matrix Storage Console** to launch the Intel<sup>®</sup> Matrix Storage Manager.
- 2 Right-click the available hard drive to which you want to rebuild the RAID 1 volume, and click **Rebuild to this Disk**.



**NOTE:** You can use your computer while the computer is rebuilding the RAID 1 volume.

## Transferring Information to a New Computer

You can use your operating system "wizards" to help you transfer files and other data from one computer to another—for example, from an *old* computer to a *new* computer. For instructions, see the following section that corresponds to the operating system that your computer is running.

### Microsoft<sup>®</sup> Windows<sup>®</sup> XP

The Microsoft Windows XP operating system provides the Files and Settings Transfer Wizard to move data from a source computer to a new computer. You can transfer data, such as:

- E-mail messages
- Toolbar settings
- Window sizes
- Internet bookmarks

You can transfer the data to the new computer over a network or serial connection, or you can store it on removable media, such as a writable CD, for transfer to the new computer.



**NOTE:** You can transfer information from an old computer to a new computer by directly connecting a serial cable to the input/output (I/O) ports of the two computers. To transfer data over a serial connection, you must access the Network Connections utility from the Control Panel and perform additional configuration steps, such as setting up an advanced connection and designating the host computer and the guest computer.

For instructions on setting up a direct cable connection between two computers, see Microsoft Knowledge Base Article #305621, titled *How to Set Up a Direct Cable Connection Between Two Computers in Windows XP*. This information may not be available in certain countries.

For transferring information to a new computer, you must run the Files and Settings Transfer Wizard. You can use the optional *Operating System* media for this process or you can create a wizard disk with the Files and Settings Transfer Wizard.

### Running the Files and Settings Transfer Wizard With the Operating System Media



**NOTE:** This procedure requires the *Operating System* media. This media is optional and may not be included with certain computers.

To prepare a new computer for the file transfer:

- 1 Open the Files and Settings Transfer Wizard: click **Start**→ **All Programs**→ **Accessories**→ **System Tools**→ **Files and Settings Transfer Wizard**.
- 2 When the **Files and Settings Transfer Wizard** welcome screen appears, click **Next**.
- 3 On the **Which computer is this?** screen, click **New Computer**→ **Next**.
- 4 On the **Do you have a Windows XP CD?** screen, click **I will use the wizard from the Windows XP CD**→ **Next**.
- 5 When the **Now go to your old computer** screen appears, go to your old or source computer. Do *not* click **Next** at this time.

To copy data from the old computer:

- 1 On the old computer, insert the Windows XP *Operating System* media.
- 2 On the **Welcome to Microsoft Windows XP** screen, click **Perform additional tasks**.
- 3 Under **What do you want to do?**, click **Transfer files and settings**→ **Next**.
- 4 On the **Which computer is this?** screen, click **Old Computer**→ **Next**.
- 5 On the **Select a transfer method** screen, click the transfer method you prefer.
- 6 On the **What do you want to transfer?** screen, select the items you want to transfer and click **Next**.

After the information has been copied, the **Completing the Collection Phase** screen appears.

- 7 Click **Finish**.

To transfer data to the new computer:

- 1 On the **Now go to your old computer** screen on the new computer, click **Next**.
- 2 On the **Where are the files and settings?** screen, select the method you chose for transferring your settings and files and click **Next**.

The wizard reads the collected files and settings and applies them to your new computer.

When all of the settings and files have been applied, the **Finished** screen appears.

- 3 Click **Finished** and restart the new computer.

### **Running the Files and Settings Transfer Wizard Without the Operating System Media**

To run the Files and Settings Transfer Wizard without the *Operating System* media, you must create a wizard disk that will allow you to create a backup image file to removable media.

To create a wizard disk, use your new computer with Windows XP and perform the following steps:

- 1 Open the Files and Settings Transfer Wizard: click **Start**→**All Programs**→**Accessories**→**System Tools**→**Files and Settings Transfer Wizard**.
- 2 When the **Files and Settings Transfer Wizard** welcome screen appears, click **Next**.
- 3 On the **Which computer is this?** screen, click **New Computer**→**Next**.
- 4 On the **Do you have a Windows XP CD?** screen, click **I want to create a Wizard Disk in the following drive**→**Next**.
- 5 Insert the removable media, such as a writable CD, and click **OK**.
- 6 When the disk creation completes and the **Now go to your old computer** message appears, *do not* click **Next**.
- 7 Go to the old computer.

To copy data from the old computer:

- 1 On the old computer, insert the wizard disk.
- 2 Click **Start**→**Run**.



- 3** In the **Open** field on the **Run** window, browse to the path for **fastwiz** (on the appropriate removable media) and click **OK**.
- 4** On the **Files and Settings Transfer Wizard** welcome screen, click **Next**.
- 5** On the **Which computer is this?** screen, click **Old Computer**→ **Next**.
- 6** On the **Select a transfer method** screen, click the transfer method you prefer.
- 7** On the **What do you want to transfer?** screen, select the items you want to transfer and click **Next**.

After the information has been copied, the **Completing the Collection Phase** screen appears.

- 8** Click **Finish**.

To transfer data to the new computer:

- 1** On the **Now go to your old computer** screen on the new computer, click **Next**.
- 2** On the **Where are the files and settings?** screen, select the method you chose for transferring your settings and files and click **Next**. Follow the instructions on the screen.

The wizard reads the collected files and settings and applies them to your new computer.

When all of the settings and files have been applied, the **Finished** screen appears.

- 3** Click **Finished** and restart the new computer.



**NOTE:** For more information about this procedure, search [support.dell.com](http://support.dell.com) for document #154781 (*What Are The Different Methods To Transfer Files From My Old Computer To My New Dell™ Computer Using the Microsoft® Windows® XP Operating System?*).



**NOTE:** Access to the Dell™ Knowledge Base document may not be available in certain countries.

## Windows Vista®

The Windows Vista® operating system provides the Windows Easy Transfer wizard to move data from a source computer to a new computer. You can transfer data, such as:

- User account
- Files and folders
- Program settings
- Internet settings and favorites
- E-mail settings, contacts, and messages

You can transfer the data to the new computer over a network or serial connection, or you can store it on removable media, such as a writable CD, for transfer to the new computer.

There are two ways to access the Easy Transfer wizard:

- 1 When Vista setup is completed, you will see the Vista Welcome Center. One icon in the Welcome Center is **Transfer Files and Settings**. Click this icon to start Windows easy Transfer.
- 2 If the Welcome Center dialog box has been closed, you can access Easy Transfer by clicking **Start**  → **All Programs** → **Accessories** → **System Tools** → **Easy Transfer**.

Double-click the **Easy Transfer** icon to begin the process.

## Setting Up a Home and Office Network

### Connecting to a Network Adapter



**NOTICE:** Plug the network cable into the network adapter connector on the computer. Do not plug the network cable into the modem connector on the computer. Do not plug a network cable into a telephone wall jack.

- 1 Connect the network cable to the network adapter connector on the back of your computer.  
Insert the cable until it clicks into place, and then gently pull it to ensure that it is secure.
- 2 Connect the other end of the network cable to a network device.

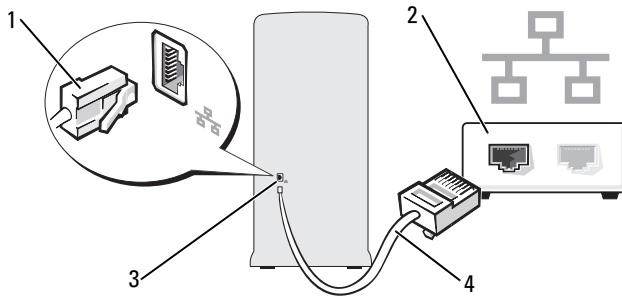

- |   |                                       |   |                |
|---|---------------------------------------|---|----------------|
| 1 | network adapter connector             | 2 | network device |
| 3 | network adapter connector on computer | 4 | network cable  |

## Setting Up a Network in the Microsoft® Windows® XP Operating System

- 1 Click Start→ All Programs→ Accessories→ Communications→ Network Setup Wizard→ Next→ Checklist for creating a network.

 **NOTE:** Selecting the connection method labeled **This computer connects directly to the Internet** enables the integrated firewall provided with Windows XP Service Pack 2 (SP2).

- 2 Complete the checklist.
- 3 Return to the Network Setup Wizard and follow the instructions in the wizard.

## Setting Up a Network in the Windows Vista® Operating System

- 1 Click the Windows Vista Start button , and then click **Connect To→ Set up a connection or network**.
- 2 Select an option under **Choose a connection option**.
- 3 Click **Next**, and then follow the instructions in the wizard.

# Connecting to the Internet

 **NOTE:** ISPs and ISP offerings vary by country.

To connect to the Internet, you need a modem or network connection and an Internet service provider (ISP). Your ISP will offer one or more of the following Internet connection options:

- DSL connections that provide high-speed Internet access through your existing telephone line or cellular telephone service. With a DSL connection, you can access the Internet and use your telephone on the same line simultaneously.
- Cable modem connections that provide high-speed Internet access through your local cable TV line.
- Satellite modem connections that provide high-speed Internet access through a satellite television system.
- Dial-up connections that provide Internet access through a telephone line. Dial-up connections are considerably slower than DSL and cable (or satellite) modem connections.
- Wireless LAN connections that provide Internet access using Bluetooth® wireless technology.

If you are using a dial-up connection, connect a telephone line to the modem connector on your computer and to the telephone wall jack before you set up your Internet connection. If you are using a DSL or cable/satellite modem connection, contact your ISP or cellular telephone service for setup instructions.

## Setting Up Your Internet Connection

To set up an Internet connection with a provided ISP desktop shortcut:

- 1 Save and close any open files, and exit any open programs.
- 2 Double-click the ISP icon on the Microsoft® Windows® desktop.
- 3 Follow the instructions on the screen to complete the setup.

If you do not have an ISP icon on your desktop or if you want to set up an Internet connection with a different ISP, perform the steps in the following section that corresponds to the operating system your computer is using.



**NOTE:** If you are having problems connecting to the Internet, see "E-Mail, Modem, and Internet Problems" on page 66. If you cannot connect to the Internet but have successfully connected in the past, the ISP might have a service outage. Contact your ISP to check the service status, or try connecting again later.

## Windows XP

- 1 Save and close any open files, and exit any open programs.
- 2 Click **Start**→ **Internet Explorer**.  
The **New Connection Wizard** appears.
- 3 Click **Connect to the Internet**.
- 4 In the next window, click the appropriate option:
  - If you do not have an ISP and want to select one, click **Choose from a list of Internet service providers (ISPs)**.
  - If you have already obtained setup information from your ISP but you did not receive a setup CD, click **Set up my connection manually**.
  - If you have a CD, click **Use the CD I got from an ISP**.
- 5 Click **Next**.

If you selected **Set up my connection manually**, continue to step 6. Otherwise, follow the instructions on the screen to complete the setup.



**NOTE:** If you do not know which type of connection to select, contact your ISP.

- 6 Click the appropriate option under **How do you want to connect to the Internet?**, and then click **Next**.
- 7 Use the setup information provided by your ISP to complete the setup.

## Windows Vista®



**NOTE:** Have your ISP information ready. If you do not have an ISP, the **Connect to the Internet** wizard can help you get one.

- 1 Save and close any open files, and exit any open programs.
- 2 Click **Start** , and click **Control Panel**
- 3 Under **Network and Internet**, click **Connect to the Internet**.  
The **Connect to the Internet** window appears.

- 4 Click either **Broadband (PPPoE)** or **Dial-up**, depending on how you want to connect:
  - Choose **Broadband** if you will use a DSL, satellite modem, cable TV modem, or Bluetooth wireless technology connection.
  - Chose **Dial-up** if you will use a dial-up modem or ISDN.
-  **NOTE:** If you do not know which type of connection to select, click **Help me choose** or contact your ISP.
- 5 Follow the instructions on the screen and use the setup information provided by your ISP to complete the setup.

# Solving Problems

 **CAUTION:** Some of the parts described in this chapter may be replaceable by a certified service technician only and are not custom replaceable.

## Troubleshooting Tips

Follow these tips when you troubleshoot your computer:

- If you added or removed a part before the problem started, review the installation procedures and ensure that the part is correctly installed.
- If a peripheral device does not work, ensure that the device is properly connected.
- If an error message appears on the screen, write down the exact message. This message may help technical support personnel diagnose and fix the problem.
- If an error message occurs in a program, see the program's documentation.

## Battery Problems

 **CAUTION:** There is a danger of a new battery exploding if it is incorrectly installed. Replace the battery only with the same or equivalent type recommended by the manufacturer. Discard used batteries according to the manufacturer's instructions.

 **CAUTION:** Before you begin any of the procedures in this section, follow the safety instructions in the *Product Information Guide*.

**REPLACE THE BATTERY** — If you have to repeatedly reset time and date information after turning on the computer, or if an incorrect time or date displays during start-up, replace the battery (see "Replacing the Battery" on page 160). If the battery still does not work properly, contact Dell (see "Contacting Dell" on page 202).

# Drive Problems



**CAUTION:** Before you begin any of the procedures in this section, follow the safety instructions in the *Product Information Guide*.

## **ENSURE THAT MICROSOFT® WINDOWS® RECOGNIZES THE DRIVE —**

*Windows XP:*

- Click **Start** and click **My Computer**.

*Windows Vista®:*

- Click the Windows Vista Start button  and click **Computer**.

If the drive is not listed, perform a full scan with your antivirus software to check for and remove viruses. Viruses can sometimes prevent Windows from recognizing the drive.

**ENSURE THAT THE DRIVE IS ENABLED IN THE SYSTEM SETUP PROGRAM —** See "System Setup" on page 187)

## **TEST THE DRIVE —**

- Insert another floppy disk, CD, or DVD to eliminate the possibility that the original one is defective.
- Insert bootable media and restart the computer.

**CLEAN THE DRIVE OR DISK —** See "Cleaning Your Computer" on page 198.

## **CHECK THE CABLE CONNECTIONS**

**RUN THE HARDWARE TROUBLESHOOTER —** See "Troubleshooting Software and Hardware Problems in the Microsoft Windows® XP and Windows Vista® Operating System" on page 97.

**RUN THE DELL DIAGNOSTICS —** See "Starting the Dell Diagnostics From Your Hard Drive" on page 90.



## CD and DVD drive problems



**NOTE:** High-speed CD or DVD drive vibration is normal and may cause noise, which does not indicate a defect in the drive or the CD or DVD.



**NOTE:** Because of different regions worldwide and different disc formats, not all DVD titles work in all DVD drives.

### ADJUST THE WINDOWS VOLUME CONTROL —

- Click the speaker icon in the lower-right corner of your screen.
- Ensure that the volume is turned up by clicking the slider and dragging it up.
- Ensure that the sound is not muted by clicking any boxes that are checked.

**CHECK THE SPEAKERS AND SUBWOOFER** — See "Sound and Speaker Problems" on page 81.

## Problems writing to a CD/DVD-RW drive

**CLOSE OTHER PROGRAMS** — The CD/DVD-RW drive must receive a steady stream of data when writing. If the stream is interrupted, an error occurs. Try closing all programs before you write to the CD/DVD-RW.

### TURN OFF STANDBY MODE IN WINDOWS BEFORE WRITING TO A CD/DVD-RW DISC —

- 1 Click Start  and click Control Panel.
- 2 Under System and Maintenance and click Power Options.
- 3 Under Preferred Plans, click Change Plan Settings for the selected plan.
- 4 Click the dropdown menu for Turn Off the Display and select Never.

## Hard drive problems

### **RUN CHECK DISK —**

*Windows XP:*

- 1 Click **Start** and click **My Computer**.
- 2 Right-click **Local Disk C:**.
- 3 Click **Properties**→ **Tools**→ **Check Now**.
- 4 Click **Scan for and attempt recovery of bad sectors** and click **Start**.

*Windows Vista:*

- 1 Click **Start**  and click **Computer**.
- 2 Right-click **Local Disk C:**.
- 3 Click **Properties**→ **Tools**→ **Check Now**.

The **User Account Control** window may appear. If you are an administrator on the computer, click **Continue**; otherwise, contact your administrator to continue the desired action.

- 4 Follow the instructions on the screen.

## E-Mail, Modem, and Internet Problems



**CAUTION:** Before you begin any of the procedures in this section, follow the safety instructions in the *Product Information Guide*.



**NOTE:** Connect the modem to an analog telephone jack only. The modem does not operate while it is connected to a digital telephone network.

**CHECK THE WINDOWS MAIL EXPRESS SECURITY SETTINGS —** If you cannot open your e-mail attachments:

- 1 In **Windows Mail**, click **Tools**, click **Options**, and then click **Security**.
- 2 Click **Do not allow attachments** to remove the checkmark.

**CHECK THE TELEPHONE LINE CONNECTION —**

**CHECK THE TELEPHONE JACK —**

**CONNECT THE MODEM DIRECTLY TO THE TELEPHONE WALL JACK —**

**USE A DIFFERENT TELEPHONE LINE —**

- Verify that the telephone line is connected to the jack on the modem. (The jack has either a green label or a connector-shaped icon next to it.)
- Ensure that you feel a click when you insert the telephone line connector into the modem.
- Disconnect the telephone line from the modem and connect it to a telephone. Listen for a dial tone.
- If you have other telephone devices sharing the line, such as an answering machine, fax machine, surge protector, or line splitter, then bypass them and use the telephone to connect the modem directly to the telephone wall jack. If you are using a line that is 3 m (10 ft) or more in length, try a shorter one.

**RUN THE MODEM HELPER DIAGNOSTICS —** Click **Start** , point to **All Programs**, and then click **Modem Helper**. Follow the instructions on the screen to identify and resolve modem problems. (Modem Helper is not available on all computers.)

**VERIFY THAT THE MODEM IS COMMUNICATING WITH WINDOWS —**

- 1 Click **Start**  and click **Control Panel**.
  - 2 Click **Hardware and Sound**.
  - 3 Click **Phone and Modem Options** and click the **Modems** tab.
  - 4 Click the COM port for your modem.
  - 5 Click **Properties**, click the **Diagnostics** tab, and then click **Query Modem** to verify that the modem is communicating with Windows.
- If all commands receive responses, the modem is operating properly.

**ENSURE THAT YOU ARE CONNECTED TO THE INTERNET —** Ensure that you have subscribed to an Internet provider. With the Windows Mail e-mail program open, click **File**. If **Work Offline** has a checkmark next to it, click the checkmark to remove it and connect to the Internet. For help, contact your Internet service provider.

## Error Messages

 **CAUTION:** Before you begin any of the procedures in this section, follow the safety instructions in the *Product Information Guide*.

If the message is not listed, see the documentation for the operating system or the program that was running when the message appeared.

**A FILENAME CANNOT CONTAIN ANY OF THE FOLLOWING CHARACTERS: \ / : \* ? " < > | —** Do not use these characters in filenames.

**A REQUIRED .DLL FILE WAS NOT FOUND** — The program that you are trying to open is missing an essential file. To remove and then reinstall the program:

*Windows XP:*

- 1 Click **Start** → **Control Panel** → **Add or Remove Programs** → **Programs and Features**.
- 2 Select the program you want to remove.
- 3 Click **Uninstall**.
- 4 See the program documentation for installation instructions.

*Windows Vista:*

- 1 Click **Start**  → **Control Panel** → **Programs** → **Programs and Features**.
- 2 Select the program you want to remove.
- 3 Click **Uninstall**.
- 4 See the program documentation for installation instructions.

**drive letter : \ IS NOT ACCESSIBLE. THE DEVICE IS NOT READY** — The drive cannot read the disk. Insert a disk into the drive and try again.

**INSERT BOOTABLE MEDIA** — Insert a bootable floppy disk or CD.

**NON-SYSTEM DISK ERROR** — Remove the floppy disk from the drive and restart your computer.

**NOT ENOUGH MEMORY OR RESOURCES. CLOSE SOME PROGRAMS AND TRY AGAIN** — Close all windows and open the program that you want to use. In some cases, you might have to restart your computer to restore computer resources. If so, run the program that you want to use first.

**OPERATING SYSTEM NOT FOUND** — Contact Dell (see "Contacting Dell" on page 202).

## Keyboard Problems



**CAUTION:** Before you begin any of the procedures in this section, follow the safety instructions in the *Product Information Guide*.

### **CHECK THE KEYBOARD CABLE** —

- Ensure that the keyboard cable is firmly connected to the computer.
- Shut down the computer (see "Turning Off Your Computer" on page 106), reconnect the keyboard cable as shown on the setup diagram for your computer, and then restart the computer.
- Check the cable connector for bent or broken pins and for damaged or frayed cables. Straighten bent pins.
- Remove keyboard extension cables and connect the keyboard directly to the computer.

**TEST THE KEYBOARD** — Connect a properly working keyboard to the computer, and try using the keyboard.

**ENSURE THAT THE USB PORTS ARE ENABLED IN THE SYSTEM SETUP PROGRAM** — See "System Setup" on page 187.

**RUN THE HARDWARE TROUBLESHOOTER** — See "Troubleshooting Software and Hardware Problems in the Microsoft Windows® XP and Windows Vista® Operating System" on page 97.

# Lockups and Software Problems



**CAUTION:** Before you begin any of the procedures in this section, follow the safety instructions in the *Product Information Guide*.

## The computer does not start up

Ensure that the power cable is firmly connected to the computer and to the electrical outlet.

## The computer stops responding



**NOTICE:** You might lose data if you are unable to perform an operating system shutdown.

**TURN THE COMPUTER OFF** — If you are unable to get a response by pressing a key on your keyboard or moving your mouse, press and hold the power button for at least 8 to 10 seconds until the computer turns off. Then restart your computer.

## A program stops responding

### END THE PROGRAM —

- 1 Press <Ctrl><Shift><Esc> simultaneously.
- 2 Click **Applications**.
- 3 Click the program that is no longer responding.
- 4 Click **End Task**.

## A program crashes repeatedly



**NOTE:** Software usually includes installation instructions in its documentation or on a floppy disk or CD.

**CHECK THE SOFTWARE DOCUMENTATION** — If necessary, uninstall and then reinstall the program.

## A program is designed for an earlier Microsoft® Windows® operating system

### **RUN THE PROGRAM COMPATIBILITY WIZARD —**

*Windows XP:*

The Program Compatibility Wizard configures a program so that it runs in an environment similar to non-XP operating system environments.

- 1** Click **Start** → **All Programs** → **Accessories** → **Program Compatibility Wizard** → **Next**.
- 2** Follow the instructions on the screen.

*Windows Vista:*

The Program Compatibility Wizard configures a program so that it runs in an environment similar to non-Windows Vista operating system environments.

- 1** Click **Start**  → **Control Panel** → **Programs** → **Use an older program with this version of Windows**.
- 2** In the welcome screen, click **Next**.
- 3** Follow the instructions on the screen.

## A solid blue screen appears

**TURN THE COMPUTER OFF —** If you are unable to get a response by pressing a key on your keyboard or moving your mouse, press and hold the power button for at least 8 to 10 seconds until the computer turns off. Then restart your computer.

## Other software problems

### **CHECK THE SOFTWARE DOCUMENTATION OR CONTACT THE SOFTWARE MANUFACTURER FOR TROUBLESHOOTING INFORMATION —**

- Ensure that the program is compatible with the operating system installed on your computer.
- Ensure that your computer meets the minimum hardware requirements needed to run the software. See the software documentation for information.
- Ensure that the program is installed and configured properly.
- Verify that the device drivers do not conflict with the program.
- If necessary, uninstall and then reinstall the program.

### **BACK UP YOUR FILES IMMEDIATELY**

### **USE A VIRUS-SCANNING PROGRAM TO CHECK THE HARD DRIVE, FLOPPY DISKS, OR CDS**

### **SAVE AND CLOSE ANY OPEN FILES OR PROGRAMS AND SHUT DOWN YOUR COMPUTER THROUGH THE START MENU**



# Media Card Reader Problems

## **NO DRIVE LETTER IS ASSIGNED —**

When Windows Vista detects the Media Card Reader, the device is automatically assigned a drive letter as the next logical drive after all other physical drives in the system. If the next logical drive after the physical drives is mapped to a network drive, Windows Vista does not automatically assign a drive letter to the Media Card Reader.

To manually assign a drive for the Media Card Reader:

- 1** Click **Start** , right-click **Computer** and select **Manage**.
- 2** Click **Continue** if prompted.
- 3** Expand the **Storage** object and select **Disk Management**.
- 4** Right-click the corresponding drive letter in the right pane that needs to be changed.
- 5** Select **Change Drive Letter and Paths**.
- 6** Click **Change**.
- 7** From the drop-down list, select the new drive letter assignment for the Media Card Reader.
- 8** Click **OK** to confirm your selection.

**NOTE:** The Media Card Reader only appears as a mapped drive when it is connected. Each of the four Media Card Reader slots are mapped to a drive even if no media is installed. If you attempt to access the Media Card Reader when no media is inserted, you are prompted to insert media.

## **FLEXBAY DEVICE IS DISABLED —**

There is a **FlexBay disable** option in the BIOS setup that appears only when the FlexBay device is installed. If the FlexBay device is physically installed, but it is not running, check to see if it is enabled in the BIOS setup.

# Memory Problems



**CAUTION:** Before you begin any of the procedures in this section, follow the safety instructions in the *Product Information Guide*.

## **IF YOU RECEIVE AN INSUFFICIENT MEMORY MESSAGE —**

- Save and close any open files and exit any open programs you are not using to see if that resolves the problem.
- See the software documentation for minimum memory requirements. If necessary, install additional memory (see "Memory Installation Guidelines" on page 124).
- Reseat the memory modules (see "Installing Memory" on page 126) to ensure that your computer is successfully communicating with the memory.
- Run the Dell Diagnostics (see "Dell Diagnostics" on page 90).

## **IF YOU EXPERIENCE OTHER MEMORY PROBLEMS —**

- Reseat the memory modules (see "Installing Memory" on page 126) to ensure that your computer is successfully communicating with the memory.
- Ensure that you are following the memory installation guidelines (see "Memory Installation Guidelines" on page 124).
- Your computer supports DDR2 memory. For more information about the type of memory supported by your computer, see "Memory" on page 179.
- Run the Dell Diagnostics (see "Dell Diagnostics" on page 90).

# Mouse Problems



**CAUTION:** Before you begin any of the procedures in this section, follow the safety instructions in the *Product Information Guide*.

**CLEAN THE MOUSE** — See "Mouse" on page 198 for instructions on cleaning the mouse.

## **CHECK THE MOUSE CABLE** —

- 1 Remove mouse extension cables, if used, and connect the mouse directly to the computer.
- 2 Reconnect the mouse cable as shown on the setup diagram for your computer.

## **RESTART THE COMPUTER** —

- 1 Simultaneously press <Ctrl><Esc> to display the **Start** menu.
- 2 Type **u**, press the keyboard arrow keys to highlight **Shut down** or **Turn Off**, and then press <Enter>.
- 3 After the computer turns off, reconnect the mouse cable as shown on the on the setup diagram for your computer.
- 4 Start the computer.

**ENSURE THAT THE USB PORTS ARE ENABLED IN THE SYSTEM SETUP PROGRAM** — See "System Setup" on page 187.

**TEST THE MOUSE** — Connect a properly working mouse to the computer, and try using the mouse.

## **CHECK THE MOUSE SETTINGS** —

*Windows XP*

- 1 Click **Start** → **Control Panel** → **Mouse**.
- 2 Adjust the settings as needed.

*Windows Vista:*

- 1 Click **Start**  → **Control Panel** → **Hardware and Sound** → **Mouse**.
- 2 Adjust the settings as needed.

**REINSTALL THE MOUSE DRIVER** — See "Reinstalling Drivers and Utilities" on page 95.

**RUN THE HARDWARE TROUBLESHOOTER** — See "Troubleshooting Software and Hardware Problems in the Microsoft Windows® XP and Windows Vista® Operating System" on page 97.

## Network Problems



**CAUTION:** Before you begin any of the procedures in this section, follow the safety instructions in the *Product Information Guide*.

**CHECK THE NETWORK CABLE CONNECTOR** — Ensure that the network cable is firmly inserted into both the network connector on the back of the computer and the network port or device.

**CHECK THE NETWORK LIGHTS ON THE BACK OF THE COMPUTER** — If the link integrity light is off, that indicates no network communication exists. Replace the network cable. For a description of network lights, see "Controls and Lights" on page 185.

**RESTART THE COMPUTER AND LOG ON TO THE NETWORK AGAIN**

**CHECK YOUR NETWORK SETTINGS** — Contact your network administrator or the person who set up your network to verify that your network settings are correct and that the network is functioning.

**RUN THE HARDWARE TROUBLESHOOTER** — See "Troubleshooting Software and Hardware Problems in the Microsoft Windows® XP and Windows Vista® Operating System" on page 97.

# Power Problems



**CAUTION:** Before you begin any of the procedures in this section, follow the safety instructions in the *Product Information Guide*.

**IF THE POWER LIGHT IS OFF** — The computer is either turned off or is not receiving power.

- Reseat the power cable into both the power connector on the back of the computer and the electrical outlet.
- If the computer is plugged into a power strip, ensure that the power strip is plugged into an electrical outlet and that the power strip is turned on. Also bypass power protection devices, power strips, and power extension cables to verify that the computer turns on properly.
- Ensure that the electrical outlet is working by testing it with another device, such as a lamp.

**IF THE POWER LIGHT IS STEADY BLUE AND THE COMPUTER IS NOT RESPONDING** — See "Beep Codes" on page 86.

**IF THE POWER LIGHT IS BLINKING BLUE** — The computer is in standby mode. Press a key on the keyboard, move the mouse, or press the power button to resume normal operation.

**IF THE POWER LIGHT IS STEADY AMBER** — Power problem or internal device malfunction.

- Ensure that the 12-volt power connector (12V) is securely connected to the system board (see "System Board Components" on page 110).
- Ensure that the main power cable and front panel cable are securely connected to the system board (see "System Board Components" on page 110).

**IF THE POWER LIGHT IS BLINKING AMBER** — The computer is receiving electrical power, a device might be malfunctioning or incorrectly installed.

- Remove and then reinstall the memory modules (see "Installing Memory" on page 126).
- Remove and then reinstall any cards (see "Cards" on page 129).
- Remove and then reinstall the graphics card, if applicable (see "Removing a PCI/PCI Express Card" on page 134).

**ELIMINATE INTERFERENCE** — Some possible causes of interference are:

- Power, keyboard, and mouse extension cables.
- Too many devices on a power strip.
- Multiple power strips connected to the same electrical outlet.

## Printer Problems



**CAUTION:** Before you begin any of the procedures in this section, follow the safety instructions in the *Product Information Guide*.



**NOTE:** If you need technical assistance for your printer, contact the printer's manufacturer.

**CHECK THE PRINTER DOCUMENTATION** — See the printer documentation for setup and troubleshooting information.

**ENSURE THAT THE PRINTER IS TURNED ON**

**CHECK THE PRINTER CABLE CONNECTIONS** —

- See the printer documentation for cable connection information.
- Ensure that the printer cables are securely connected to the printer and the computer (see "Setting Up a Printer" on page 29).

**TEST THE ELECTRICAL OUTLET** — Ensure that the electrical outlet is working by testing it with another device, such as a lamp.

## **VERIFY THAT THE PRINTER IS RECOGNIZED BY WINDOWS —**

*Windows XP:*

- 1** Click **Start** → **Control Panel** → **Printers and Other Hardware** → **View installed printers or fax printers**.
- 2** If the printer is listed, right-click the printer icon.
- 3** Click **Properties** → **Ports**. For a parallel printer, ensure that the **Print to the following port(s)**: setting is **LPT1 (Printer Port)**. For a USB printer, ensure that the **Print to the following port(s)**: setting is **USB**.

*Windows Vista:*

- 1** Click **Start**  → **Control Panel** → **Hardware and Sound** → **Printer**.
- 2** If the printer is listed, right-click the printer icon.
- 3** Click **Properties** and click **Ports**.
- 4** Adjust the settings, as needed.

**REINSTALL THE PRINTER DRIVER —** See the printer documentation for instructions.

# Scanner Problems



**CAUTION:** Before you begin any of the procedures in this section, follow the safety instructions in the *Product Information Guide*.



**NOTE:** If you need technical assistance for your scanner, contact the scanner's manufacturer.

**CHECK THE SCANNER DOCUMENTATION** — See the scanner documentation for setup and troubleshooting information.

**UNLOCK THE SCANNER** — Ensure that your scanner is unlocked if it has a locking tab or button.

**RESTART THE COMPUTER AND TRY THE SCANNER AGAIN**

**CHECK THE CABLE CONNECTIONS** —

- See the scanner documentation for cable connection information.
- Ensure that the scanner cables are securely connected to the scanner and the computer.

**VERIFY THAT THE SCANNER IS RECOGNIZED BY MICROSOFT WINDOWS** —

*Windows XP:*

- 1 Click **Start** → **Control Panel** → **Printers and Other Hardware** → **Scanners and Cameras**.
- 2 If your scanner is listed, Windows recognizes the scanner.

*Windows Vista:*

- 1 Click **Start**  → **Control Panel** → **Hardware and Sound** → **Scanners and Cameras**.
- 2 If the scanner is listed, Windows recognizes the scanner.

**REINSTALL THE SCANNER DRIVER** — See the scanner documentation for instructions.



# Sound and Speaker Problems



**CAUTION:** Before you begin any of the procedures in this section, follow the safety instructions in the *Product Information Guide*.

## No sound from speakers



**NOTE:** The volume control in some MP3 players overrides the Windows volume setting. If you have been listening to MP3 songs, ensure that you did not turn the player volume down or off.

**CHECK THE SPEAKER CABLE CONNECTIONS** — Ensure that the speakers are connected as shown on the setup diagram supplied with the speakers. If you purchased a sound card, ensure that the speakers are connected to the card.

**ENSURE THAT THE CORRECT AUDIO SOLUTION IS ENABLED IN THE BIOS SETUP PROGRAM** — See "System Setup" on page 187.

**ENSURE THAT THE SUBWOOFER AND THE SPEAKERS ARE TURNED ON** — See the setup diagram supplied with the speakers. If your speakers have volume controls, adjust the volume, bass, or treble to eliminate distortion.

**ADJUST THE WINDOWS VOLUME CONTROL** — Click or double-click the speaker icon in the lower-right corner of your screen. Ensure that the volume is turned up and that the sound is not muted.

**DISCONNECT HEADPHONES FROM THE HEADPHONE CONNECTOR** — Sound from the speakers is automatically disabled when headphones are connected to the computer's front-panel headphone connector.

**TEST THE ELECTRICAL OUTLET** — Ensure that the electrical outlet is working by testing it with another device, such as a lamp.

**ELIMINATE POSSIBLE INTERFERENCE** — Turn off nearby fans, fluorescent lights, or halogen lamps to check for interference.

**REINSTALL THE SOUND DRIVER** — See "Manually Reinstalling Drivers" on page 97.

**RUN THE HARDWARE TROUBLESHOOTER** — See "Troubleshooting Software and Hardware Problems in the Microsoft Windows® XP and Windows Vista® Operating System" on page 97.

## No sound from headphones

**CHECK THE HEADPHONE CABLE CONNECTION** — Ensure that the headphone cable is securely inserted into the headphone connector (see "Front View of the Computer" on page 15).

**ADJUST THE WINDOWS VOLUME CONTROL** — Click or double-click the speaker icon in the lower-right corner of your screen. Ensure that the volume is turned up and that the sound is not muted.

**ENSURE THAT THE CORRECT AUDIO SOLUTION IS ENABLED IN THE BIOS SETUP PROGRAM** — See "System Setup" on page 187.

## Video and Monitor Problems



**CAUTION:** Before you begin any of the procedures in this section, follow the safety instructions in the *Product Information Guide*.



**NOTE:** See the monitor documentation for troubleshooting procedures.

## If the screen is blank

### **CHECK THE MONITOR CABLE CONNECTION** —

- Ensure that the graphics cable is connected as shown on the setup diagram for your computer.  
If an optional video card is installed, check that the monitor cable is connected to the card, rather than the video connector on the system board.
- If you are using a graphics extension cable and removing the cable solves the problem, the cable is defective.
- Swap the computer and monitor power cables to determine whether the power cable is defective.
- Check the connector for bent or broken pins. (It is normal for monitor cable connectors to have missing pins.)

**CHECK THE MONITOR POWER LIGHT** — If the power light is off, firmly press the button to ensure that the monitor is turned on. If the power light is lit or blinking, the monitor has power. If the power light is blinking, press a key on the keyboard or move the mouse.

**TEST THE ELECTRICAL OUTLET** — Ensure that the electrical outlet is working by testing it with another device, such as a lamp.

**CHECK THE DIAGNOSTIC LIGHTS** — See "Beep Codes" on page 86.

## If the screen is difficult to read

**CHECK THE MONITOR SETTINGS** — See the monitor documentation for instructions on adjusting the contrast and brightness, demagnetizing (degaussing) the monitor, and running the monitor self-test.

**MOVE THE SUBWOOFER AWAY FROM THE MONITOR** — If your speaker system includes a subwoofer, ensure that the subwoofer is at least 60 cm (2 ft) away from the monitor.

**MOVE THE MONITOR AWAY FROM EXTERNAL POWER SOURCES** — Fans, fluorescent lights, halogen lamps, and other electrical devices can cause the screen image to appear "shaky." Turn off nearby devices to check for interference.

**ROTATE THE MONITOR TO ELIMINATE SUNLIGHT GLARE AND POSSIBLE INTERFERENCE**

**ADJUST THE WINDOWS DISPLAY SETTINGS** —

*Windows XP:*

- 1 Click **Start** → **Control Panel** → **Appearance and Themes**.
- 2 Click the area you want to change or click the **Display** icon.
- 3 Try different settings for **Color quality** and **Screen resolution**.

*Windows Vista:*

- 1 Click **Start**  → **Control Panel** → **Hardware and Sound** → **Personalization** → **Display Settings**.
- 2 Adjust **Resolution** and **Colors** settings, as needed.

# Troubleshooting Tools

## Power Lights

 **CAUTION:** Before you begin any of the procedures in this section, follow the safety instructions in the *Product Information Guide*.

The power button light (bi-color LED) located on the front of the computer illuminates and blinks or remains solid to indicate different states:

- If the power light is off, the computer is either turned off or is not receiving power.
  - Reseat the power cable in the power connector on the back of the computer and the electrical outlet.
  - If the computer is plugged into a power strip, ensure that the power strip is plugged into an electrical outlet and that the power strip is turned on. Also, bypass power protection devices, power strips, and power extension cables to verify that the computer turns on properly.
  - Ensure that the electrical outlet is working by testing it with another device, such as a lamp.
- If the power light is steady blue and the computer is not responding:
  - Ensure that the display is connected and powered on.
  - If the display is connected and powered on, see "Beep Codes" on page 86.
- If the power light is blinking blue, the computer is in standby mode. Press a key on the keyboard, move the mouse, or press the power button to resume normal operation. If the power light is blue and the computer is not responding:
  - Ensure the display is connected and powered on.
  - If the display is connected and powered on, see "Beep Codes" on page 86.

- If the power light is blinking amber, the computer is receiving electrical power, a device might be malfunctioning or incorrectly installed.
  - Remove and then reinstall the memory modules (see "Memory" on page 123).
  - Remove and then reinstall any cards (see "Cards" on page 129).
  - Remove and then reinstall the graphics card, if applicable (see "Cards" on page 129).
- If the power light is steady amber, there may be a power problem or an internal device malfunction.
  - Ensure that all power cables are securely connected to the system board (see "System Board Components" on page 110).
  - Ensure that the main power cable and front panel cable are securely connected to the system board (see "System Board Components" on page 110).

## Beep Codes

Your computer might emit a series of beeps during start-up if the monitor cannot display errors or problems. This series of beeps, called a beep code, identifies a problem. One possible beep code consists of repetitive three short beeps. This beep code tells you that the computer encountered a possible motherboard failure.

If your computer beeps during start-up:

- 1 Write down the beep code.
- 2 Run the Dell Diagnostics to identify a more serious cause (see "Dell Diagnostics" on page 90).

<b>Code (repetitive short beeps)</b>	<b>Description</b>	<b>Suggested Remedy</b>
1	BIOS checksum failure. Possible motherboard failure.	Contact Dell.
2	No memory modules are detected	<p><b>1</b> If you have two or more memory modules installed, remove the modules, reinstall one module (see "Installing Memory" on page 126), and then restart the computer. If the computer starts normally, reinstall an additional module. Continue until you have identified a faulty module or reinstalled all modules without error.</p> <p><b>2</b> If available, install good memory of the same type into your computer (see "Installing Memory" on page 126).</p> <p><b>3</b> If the problem persists, contact Dell.</p>
3	Possible motherboard failure	Contact Dell.
4	RAM Read/Write failure	<p><b>1</b> Ensure that no special memory module/memory connector placement requirements exist (see "Memory Installation Guidelines" on page 124).</p> <p><b>2</b> Verify that the memory modules that you are installing are compatible with your computer (see "Memory Installation Guidelines" on page 124).</p> <p><b>3</b> If the problem persists, contact Dell.</p>
5	Real time clock failure. Possible battery failure or motherboard failure.	<p><b>1</b> Replace the battery (see "Replacing the Battery" on page 160).</p> <p><b>2</b> If the problem persists, contact Dell.</p>
6	Video BIOS Test Failure	Contact Dell.
7	CPU cache test failure	Contact Dell.

# System Messages



**NOTE:** If the message you received is not listed in the table, see the documentation for either the operating system or the program that was running when the message appeared.

**ALERT! PREVIOUS ATTEMPTS AT BOOTING THIS SYSTEM HAVE FAILED AT CHECKPOINT [NNNN]. FOR HELP IN RESOLVING THIS PROBLEM, PLEASE NOTE THIS CHECKPOINT AND CONTACT DELL TECHNICAL SUPPORT** — The computer failed to complete the boot routine three consecutive times for the same error (see "Contacting Dell" on page 202 for assistance).

**CMOS CHECKSUM ERROR** — Possible motherboard failure or RTC battery low. Replace battery. See "Replacing the Battery" on page 160 or see "Contacting Dell" on page 202 for assistance.

**CPU FAN FAILURE** — CPU fan failure. Replace CPU fan. See "Removing the Processor Fan/Heat Sink Assembly" on page 166.

**DISKETTE DRIVE 0 SEEK FAILURE** — A cable may be loose, or the computer configuration information may not match the hardware configuration. Check cable connections or see "Contacting Dell" on page 202 for assistance.

**DISKETTE READ FAILURE** — The floppy disk may be defective or a cable may be loose. Replace floppy disk/check for loose cable connection.

**HARD-DISK DRIVE FAILURE** — Possible hard disk drive failure during HDD POST. Check cables /swap hard disks or see "Contacting Dell" on page 202 for assistance.

**HARD-DISK DRIVE READ FAILURE** — Possible HDD failure during HDD boot test (see "Contacting Dell" on page 202 for assistance).

**KEYBOARD FAILURE** — Keyboard failure or keyboard cable loose (see "Keyboard Problems" on page 69).



**NO BOOT DEVICE AVAILABLE** — No bootable partition on HDD or Not a bootable floppy in floppy driver, or HDD/Floppy cable loose, or No bootable device exists.

- If the floppy drive is your boot device, ensure that a bootable floppy disk is in the drive.
- If the hard drive is your boot device, ensure that the cables are connected and that the drive is installed properly and partitioned as a boot device.
- Enter system setup and ensure that the boot sequence information is correct (see "Entering System Setup" on page 188).

**NO TIMER TICK INTERRUPT** — A chip on the system board might be malfunctioning or motherboard failure (see "Contacting Dell" on page 202 for assistance).

**NON-SYSTEM DISK OR DISK ERROR** — Replace the floppy disk with one that has a bootable operating system or remove the floppy disk from drive A and restart the computer.

**NOT A BOOT DISKETTE** — Insert a bootable floppy disk and restart your computer.

**USB OVER CURRENT ERROR** — Disconnect the USB device. Use external power source for the USB device.

**NOTICE - HARD DRIVE SELF MONITORING SYSTEM HAS REPORTED THAT A PARAMETER HAS EXCEEDED ITS NORMAL OPERATING RANGE. DELL RECOMMENDS THAT YOU BACK UP YOUR DATA REGULARLY. A PARAMETER OUT OF RANGE MAY OR MAY NOT INDICATE A POTENTIAL HARD DRIVE PROBLEM.** — S.M.A.R.T error, possible HDD failure. This feature can be enabled or disabled in BIOS setup.

# Dell Diagnostics



**CAUTION:** Before you begin any of the procedures in this section, follow the safety instructions in the *Product Information Guide*.

## When to Use the Dell Diagnostics

If you experience a problem with your computer, perform the checks in Lockups and Software Problems (see "Lockups and Software Problems" on page 70) and run the Dell Diagnostics before you contact Dell for technical assistance.

It is recommended that you print these procedures before you begin.



**NOTICE:** The Dell Diagnostics works only on Dell™ computers.



**NOTE:** The *Drivers and Utilities* media is optional and may not ship with your computer.

See "System Setup" on page 187 to review your computer's configuration information, and ensure that the device that you want to test displays in the system setup program and is active.

Start the Dell Diagnostics from your hard drive or from the *Drivers and Utilities* media.

## Starting the Dell Diagnostics From Your Hard Drive

The Dell Diagnostics is located on a hidden diagnostic utility partition on your hard drive.



**NOTE:** If your computer cannot display a screen image, see "Contacting Dell" on page 202.

- 1 Ensure that the computer is connected to an electrical outlet that is known to be working properly.
- 2 Turn on (or restart) your computer.

- 3 When the DELL™ logo appears, press <F12> immediately. Select **Boot to Utility Partition** from the boot menu and press <Enter>.



**NOTE:** If you wait too long and the operating system logo appears, continue to wait until you see the Microsoft® Windows® desktop; then, shut down your computer and try again.



**NOTE:** If you see a message stating that no diagnostics utility partition has been found, run the Dell Diagnostics from the *Drivers and Utilities* media.

- 4 Press any key to start the Dell Diagnostics from the diagnostics utility partition on your hard drive.

### Starting the Dell Diagnostics From the *Drivers and Utilities* Media

- 1 Insert the *Drivers and Utilities* media.
- 2 Shut down and restart the computer.

When the DELL logo appears, press <F12> immediately.



**NOTE:** If you wait too long and the operating system logo appears, continue to wait until you see the Microsoft® Windows® desktop; then, shut down your computer and try again.



**NOTE:** The next steps change the boot sequence for one time only. On the next start-up, the computer boots according to the devices specified in the system setup program.

- 3 When the boot device list appears, highlight **CD/DVD/CD-RW** and press <Enter>.
- 4 Select the **Boot from CD-ROM** option from the menu that appears and press <Enter>.
- 5 Type 1 to start the CD menu and press <Enter> to proceed.
- 6 Select **Run the 32 Bit Dell Diagnostics** from the numbered list. If multiple versions are listed, select the version appropriate for your computer.
- 7 When the Dell Diagnostics **Main Menu** appears, select the test you want to run.

## Dell Diagnostics Main Menu

- 1 After the Dell Diagnostics loads and the **Main Menu** screen appears, click the button for the option you want.



**NOTE:** It is recommended that you select **Test System** to run a complete test on your computer.

Option	Function
Test Memory	Run the stand-alone memory test
Test System	Run System Diagnostics
Exit	Exit the Diagnostics

- 2 After you have selected the **Test System** option from the main menu, the following menu appears:



**NOTE:** It is recommended that you select **Extended Test** from the menu below to run a more thorough check of devices in the computer.

Option	Function
Express Test	Performs a quick test of devices in the system. This typically can take 10 to 20 minutes.
Extended Test	Performs a thorough check of devices in the system. This typically can take an hour or more.
Custom Test	Use to test a specific device or customize the tests to be run.
Symptom Tree	This option allows you to select tests based on a symptom of the problem you are having. This option lists the most common symptoms.

- 3 If a problem is encountered during a test, a message appears with an error code and a description of the problem. Write down the error code and problem description and see "Contacting Dell" on page 202.



**NOTE:** The Service Tag for your computer is located at the top of each test screen. If you contact Dell, technical support will ask for your Service Tag.

- 4 If you run a test from the **Custom Test or Symptom Tree** option, click the applicable tab described in the following table for more information.

<b>Tab</b>	<b>Function</b>
Results	Displays the results of the test and any error conditions encountered.
Errors	Displays error conditions encountered, error codes, and the problem description.
Help	Describes the test and may indicate requirements for running the test.
Configuration	Displays your hardware configuration for the selected device.  The Dell Diagnostics obtains configuration information for all devices from system setup, memory, and various internal tests, and it displays the information in the device list in the left pane of the screen. The device list may not display the names of all the components installed on your computer or all devices attached to your computer.
Parameters	Allows you to customize the test by changing the test settings.

- 5 When the tests are complete, close the test screen to return to the **Main Menu** screen. To exit the Dell Diagnostics and restart the computer, close the **Main Menu** screen.
- 6 Remove the *Drivers and Utilities* media (if applicable).

# Drivers

## What is a Driver?

A driver is a program that controls a device such as a printer, mouse, or keyboard. All devices require a driver program.

A driver acts like a translator between the device and any other programs that use the device. Each device has its own set of specialized commands that only its driver recognizes.

Dell ships your computer to you with required drivers already installed—no further installation or configuration is needed.



**NOTICE:** The *Drivers and Utilities* media may contain drivers for operating systems that are not on your computer. Ensure that you are installing software appropriate for your operating system.

Many drivers, such as the keyboard driver, come with your Microsoft Windows operating system. You may need to install drivers if you:

- Upgrade your operating system.
- Reinstall your operating system.
- Connect or install a new device.

## Identifying Drivers

If you experience a problem with any device, identify whether the driver is the source of your problem and, if necessary, update the driver.

- 1 Click the **Start** , and right-click **Computer**.
- 2 Click **Properties**→ **Device Manager**.



**NOTE:** The **User Account Control** (located to the left under **Tasks** window) may appear. If you are an administrator on the computer, click **Continue**; otherwise, contact your administrator to continue.

Scroll down the list to see if any device has an exclamation point (a yellow circle with a [!]) on the device icon.

If an exclamation point is next to the device name, you may need to reinstall the driver or install a new driver (see "Reinstalling Drivers and Utilities" on page 95).

## Reinstalling Drivers and Utilities



**NOTICE:** The Dell Support website at [support.dell.com](http://support.dell.com) and your *Drivers and Utilities* media provide approved drivers for Dell™ computers. If you install drivers obtained from other sources, your computer might not work correctly.



### Using Windows Device Driver Rollback

If a problem occurs on your computer after you install or update a driver, use Windows Device Driver Rollback to replace the driver with the previously installed version.

*Windows XP:*

- 1 Click **Start**→ **My Computer**→ **Properties**→ **Hardware**→ **Device Manager**.
- 2 Right-click the device for which the new driver was installed and click **Properties**.
- 3 Click the **Drivers** tab→ **Roll Back Driver**.

*Windows Vista:*

- 1 Click **Start** , and right-click **Computer**.
- 2 Click **Properties**→ **Device Manager**.  
 **NOTE:** The **User Account Control** window may appear. If you are an administrator on the computer, click **Continue**; otherwise, contact your administrator to enter the **Device Manager**.
- 3 Right-click the device for which the new driver was installed and click **Properties**.
- 4 Click the **Drivers** tab→ **Roll Back Driver**.

If Device Driver Rollback does not resolve the problem, then use System Restore ("Restoring Your Operating System" on page 98) to return your computer to the operating state that existed before you installed the new driver.

## Using the *Drivers and Utilities* media

If using Device Driver Rollback or System Restore ("Restoring Your Operating System" on page 98) does not resolve the problem, then reinstall the driver from the *Drivers and Utilities* media.

- 1 With the Windows desktop displayed, insert the *Drivers and Utilities* media. If this is your first time to use the *Drivers and Utilities* media, go to step 2. If not, go to step 5.
- 2 When the *Drivers and Utilities* media installation program starts, follow the prompts on the screen.
- 3 When the **InstallShield Wizard Complete** window appears, remove the *Drivers and Utilities* media and click **Finish** to restart the computer.
- 4 When you see the Windows desktop, reinsert the *Drivers and Utilities* media.
- 5 At the **Welcome Dell System Owner** screen, click **Next**.



**NOTE:** The *Drivers and Utilities* media displays drivers only for hardware that came installed in your computer. If you installed additional hardware, the drivers for the new hardware might not be displayed by the *Drivers and Utilities* media. If those drivers are not displayed, exit the *Drivers and Utilities* media program. For drivers information, see the documentation that came with the device.

A message appears, stating that the *Drivers and Utilities* media is detecting hardware in your computer.

The drivers that are used by your computer are automatically displayed in the **My Drivers—The Drivers and Utilities media has identified these components in your system** window.



- 6 Click the driver that you want to reinstall and follow the instructions on the screen.

If a particular driver is not listed, that driver is not required by your operating system.



## Manually Reinstalling Drivers

After extracting the driver files to your hard drive as described in the previous section, do the following:

- 1 Click **Start** , and right-click **Computer**.
- 2 Click **Properties**→ **Device Manager**.  
 **NOTE:** The **User Account Control** window may appear. If you are an administrator on the computer, click **Continue**; otherwise, contact your administrator to enter the Device Manager.
- 3 Double-click the type of device for which you are installing the driver (for example, **Audio** or **Video**).
- 4 Double-click the name of the device for which you are installing the driver.
- 5 Click the **Driver** tab→ **Update Driver**→ **Browse my computer for driver software**.
- 6 Click **Browse** and browse to the location to which you previously copied the driver files.
- 7 When the name of the appropriate driver appears, click the name of the driver→ **OK**→ **Next**.
- 8 Click **Finish** and restart your computer.

## Troubleshooting Software and Hardware Problems in the Microsoft Windows<sup>®</sup> XP and Windows Vista<sup>®</sup> Operating System

If a device is either not detected during the operating system setup or is detected but incorrectly configured, you can use the Hardware Troubleshooter to resolve the incompatibility.

To start the Hardware Troubleshooter:

*Windows XP:*

- 1 Click **Start**→ **Help and Support**.
- 2 Type `hardware troubleshooter` in the search field and press <Enter> to start the search.
- 3 In the **Fix a Problem** section, click **Hardware Troubleshooter**.
- 4 In the **Hardware Troubleshooter** list, select the option that best describes the problem and click **Next** to follow the remaining troubleshooting steps.

Windows Vista:

- 1 Click the Windows Vista Start button , and click **Help and Support**.
- 2 Type `hardware troubleshooter` in the search field and press <Enter> to start the search.

In the search results, select the option that best describes the problem and follow the remaining troubleshooting steps.

## Restoring Your Operating System

You can restore your operating system in the following ways:

- Microsoft Windows XP System Restore and Windows Vista System Restore return your computer to an earlier operating state without affecting data files. Use System Restore as the first solution for restoring your operating system and preserving data files.
- Dell PC Restore by Symantec restores your hard drive to the operating state it was in when you purchased the computer. Dell PC Restore permanently deletes all data on the hard drive and removes any applications installed after you received the computer. Use PC Restore only if System Restore did not resolve your operating system problem.
- *If you received an Operating System CD with your computer, you can use it to restore your operating system. Use the CD *only* if System Restore did not resolve your operating system problem.*

### Using Microsoft® Windows® System Restore

The Windows operating systems provide a System Restore option which allows you to return your computer to an earlier operating state (without affecting data files) if changes to the hardware, software, or other system settings have left the computer in an undesirable operating state. Any changes that System Restore makes to your computer are completely reversible.



**NOTICE:** Make regular backups of your data files. System Restore does not monitor your data files or recover them.



**NOTE:** The procedures in this document were written for the Windows default view, so they may not apply if you set your Dell™ computer to the Windows Classic view.



## Starting System Restore

*Windows XP:*

 **NOTICE:** Before you restore the computer to an earlier operating state, save and close any open files and exit any open programs. Do not alter, open, or delete any files or programs until the system restoration is complete.

- 1 Click Start→ All Programs→ Accessories→ System Tools→ System Restore.
- 2 Click either **Restore my computer to an earlier time** or **Create a restore point**.
- 3 Click **Next** and follow the remaining on-screen prompts.

*Windows Vista:*

- 1 Click the Windows Vista Start button , and click **Help and Support**.
- 2 In the search box, type **System Restore** and press <Enter>.   
 **NOTE:** The **User Account Control** window may appear. If you are an administrator on the computer, click **Continue**; otherwise, contact your administrator to continue the desired action.
- 3 Click **Next** and follow the remaining prompts on the screen.

In the event that System Restore did not resolve the issue, you may undo the last system restore.

## Undoing the Last System Restore

 **NOTICE:** Before you undo the last system restore, save and close all open files and exit any open programs. Do not alter, open, or delete any files or programs until the system restoration is complete.

*Windows XP:*

- 1 Click Start→ All Programs→ Accessories→ System Tools→ System Restore.
- 2 Click **Undo my last restoration** and click **Next**.

*Windows Vista:*

- 1 Click the Windows Vista Start button , and click **Help and Support**.
- 2 In the search box, type **System Restore** and press <Enter>.
- 3 Click **Undo my last restoration** and click **Next**.

## Enabling System Restore



**NOTE:** Windows Vista does not disable System Restore; regardless of low disk space. Therefore, the steps below apply only to Windows XP.

If you reinstall Windows XP with less than 200 MB of free hard-disk space available, System Restore is automatically disabled.

To see if System Restore is enabled:

- 1 Click **Start**→ **Control Panel**→ **Performance and Maintenance**→ **System**.

Click the **System Restore** tab and ensure that **Turn off System Restore** is unchecked.

## Using Dell PC Restore and Dell Factory Image Restore



**NOTICE:** Using Dell PC Restore or Dell Factory Image Restore permanently deletes all data on the hard drive and removes any programs or drivers installed after you received your computer. If possible, back up the data before using these options. Use PC Restore or Dell Factory Image Restore only if System Restore did not resolve your operating system problem.



**NOTE:** Dell PC Restore by Symantec and Dell Factory Image Restore may not be available in certain countries or on certain computers.

Use Dell PC Restore (Windows XP) or Dell Factory Image Restore (Windows Vista) only as the last method to restore your operating system. These options restore your hard drive to the operating state it was in when you purchased the computer. Any programs or files added since you received your computer—including data files—are permanently deleted from the hard drive. Data files include documents, spreadsheets, e-mail messages, digital photos, music files, and so on. If possible, back up all data before using PC Restore and Dell Factory Image Restore.

### Windows XP: Dell PC Restore

- 1 Turn on the computer.

During the boot process, a blue bar with [www.dell.com](http://www.dell.com) appears at the top of the screen.

- 2 Immediately upon seeing the blue bar, press <Ctrl><F11>.

If you do not press <Ctrl><F11> in time, let the computer finish starting, and then restart the computer again.

 **NOTICE:** If you do *not* want to proceed with PC Restore, click **Reboot** in the following step.

**3** On the next screen that appears, click **Restore**.

**4** On the next screen, click **Confirm**.

The restore process takes approximately 6–10 minutes to complete.

**5** When prompted, click **Finish** to reboot the computer.

 **NOTE:** Do not manually shut down the computer. Click **Finish** and let the computer completely reboot.

**6** When prompted, click **Yes**.

The computer restarts. Because the computer is restored to its original operating state, the screens that appear, such as the End User License Agreement, are the same ones that appeared the first time the computer was turned on.

**7** Click **Next**.

The **System Restore** screen appears and the computer restarts.

**8** After the computer restarts, click **OK**.

### **Windows Vista: Dell Factory Image Restore**

**1** Turn on the computer. When the Dell logo appears, press <F8> several times to access the Vista Advanced Boot Options Window.

**2** Select **Repair Your Computer**.

The System Recovery Options window appears.

**3** Select a keyboard layout and click **Next**.

**4** To access the recovery options, log on as a local user. To access the command prompt, type **administrator** in the User name field, then click **OK**.

**5** Click **Dell Factory Image Restore**.

 **NOTE:** Depending upon your configuration, you may need to select **Dell Factory Tools**, then **Dell Factory Image Restore**.

The Dell Factory Image Restore welcome screen appears.

**6** Click **Next**.

The Confirm Data Deletion screen appears.

 **NOTICE:** If you do not want to proceed with Factory Image Restore, click **Cancel**.

- 7 Click the checkbox to confirm that you want to continue reformatting the hard drive and restoring the system software to the factory condition, then click **Next**.

The restore process begins and may take five or more minutes to complete.

A message appears when the operating system and factory-installed applications have been restored to factory condition.

- 8 Click **Finish** to reboot the system.

### Removing Dell PC Restore



**NOTICE:** Removing Dell PC Restore from the hard drive permanently deletes the PC Restore utility from your computer. After you have removed Dell PC Restore, you will not be able to use it to restore your computer's operating system.

Dell PC Restore enables you to restore your hard drive to the operating state it was in when you purchased your computer. It is recommended that you *do not* remove PC Restore from your computer, even to gain additional hard-drive space. If you remove PC Restore from the hard-drive, you cannot ever recall it, and you will never be able to use PC Restore to return your computer's operating system to its original state.

To remove PC Restore:

- 1 Log on to the computer as a local administrator.
- 2 In Windows Explorer, go to `c:\dell\utilities\DSR`.
- 3 Double-click the filename `DSRIRRemv2.exe`.



**NOTE:** If you do not log on as a local administrator, a message appears stating that you must log on as administrator. Click **Quit**, and then log on as a local administrator.



**NOTE:** If the partition for PC Restore does not exist on your computer's hard drive, a message appears stating that the partition was not found. Click **Quit**; there is no partition to delete.

- 4 Click **OK** to remove the PC Restore partition on the hard drive.
- 5 Click **Yes** when a confirmation message appears.

The PC Restore partition is deleted and the newly available disk space is added to the free space allocation on the hard drive.

- 6 Right-click **Local Disk (C)** in Windows Explorer, click **Properties**, and verify that the additional disk space is available as indicated by the increased value for **Free Space**.
- 7 Click **Finish** to close the **PC Restore Removal** window.
- 8 Restart the computer.

## Using the Operating System CD

### Before You Begin

If you are considering reinstalling the Windows operating system to correct a problem with a newly installed driver, first try using Windows Vista Device Driver Rollback (see "Using Windows Device Driver Rollback" on page 95). If Device Driver Rollback does not resolve the problem, then use System Restore to return your operating system to the operating state it was in before you installed the new device driver (see "Using Microsoft® Windows® System Restore" on page 98).

 **NOTICE:** Before performing the installation, back up all data files on your primary hard drive. For conventional hard drive configurations, the primary hard drive is the first drive detected by the computer.

To reinstall Windows, you need the following items:

- Dell™ *Operating System* CD
- *Drivers and Utilities* CD

 **NOTE:** The *Drivers and Utilities* CD contains drivers that were installed during assembly of the computer. Use the *Drivers and Utilities* CD to load any required drivers. Depending on the region from where you ordered your computer, or whether you requested the CDs/DVDs, the *Drivers and Utilities* CD and *Operating System* CD may not ship with your system.

### Reinstalling Windows® XP or Windows Vista®

The reinstallation process can take 1 to 2 hours to complete. After you reinstall the operating system, you must also reinstall the device drivers, virus protection program, and other software.

 **NOTICE:** The *Operating System* CD provides options for reinstalling Windows XP or Windows Vista. The options will overwrite files and possibly affect programs installed on your hard drive. Therefore, do not reinstall Windows Vista unless a Dell technical support representative instructs you to do so.

- 1 Save and close any open files and exit any open programs.
- 2 Insert the *Operating System* CD. Click **Exit** if the **Install Windows** message appears.
- 3 Restart the computer. Press <F12> immediately after the DELL™ logo appears.



**NOTE:** If you wait too long and the operating system logo appears, continue to wait until you see the Microsoft® Windows® desktop; then, shut down your computer and try again.



**NOTE:** The next steps change the boot sequence for one time only. On the next start-up, the computer boots according to the devices specified in the system setup program.

- 4 When the boot device list appears, highlight **CD/DVD/CD-RW Drive** and press <Enter>.
- 5 Press any key to **Boot from CD-ROM**.
- 6 Follow the instructions on the screen to complete the installation.



# Removing and Installing Parts

 **CAUTION:** To guard against likelihood of electric shock, laceration by moving fan blades or other unexpected injuries, always unplug your computer from the electrical outlet before opening the cover.

 **CAUTION:** Do not operate your computer with any cover(s) (including computer covers, bezels, filler brackets, front-panel inserts, and so on) removed.

 **CAUTION:** Some of the parts described in this chapter may be replaceable by a certified service technician only and are not custom replaceable.

## Before You Begin

This chapter provides procedures for removing and installing the components in your computer. Unless otherwise noted, each procedure assumes that the following conditions exist:



- You have performed the steps in "Turning Off Your Computer" on page 106 and "Before Working Inside Your Computer" on page 106.
- You have read the safety information in the Dell™ *Product Information Guide*.
- A component can be replaced or—if purchased separately—installed by performing the removal procedure in reverse order.

## Recommended Tools

The procedures in this document may require the following tools:

- Small flat-blade screwdriver
- Small Phillips screwdriver
- Small plastic scribe
- Flash BIOS executable update program on the Dell Support website at [support.dell.com](http://support.dell.com)

## Turning Off Your Computer

- ➔ **NOTICE:** To avoid losing data, save and close all open files and exit all open programs before you turn off your computer.
  - 1 Save and close any open files and exit any open programs.
  - 2 Click Start , click the arrow , and then click **Shut Down**.

The computer turns off after the operating system shutdown process finishes.
  - 3 Ensure that the computer and any attached devices are turned off. If your computer and attached devices did not automatically turn off when you shut down your operating system, press and hold the power button for at least 8-10 seconds until the computer turns off.

## Before Working Inside Your Computer

Use the following safety guidelines to help protect your computer from potential damage and to help to ensure your own personal safety.

 **CAUTION:** Before you begin any of the procedures in this section, follow the safety instructions in the *Product Information Guide*.

- ➔ **NOTICE:** Handle components and cards with care. Do not touch the components or contacts on a card. Hold a card by its edges or by its metal mounting bracket. Hold a component such as a processor by its edges, not by its pins.
- ➔ **NOTICE:** Only a certified service technician should perform repairs on your computer. Damage due to servicing that is not authorized by Dell is not covered by your warranty.
- ➔ **NOTICE:** When you disconnect a cable, pull on its connector or on its pull-tab, not on the cable itself. Some cables have connectors with locking tabs; if you are disconnecting this type of cable, press in on the locking tabs before you disconnect the cable. As you pull connectors apart, keep them evenly aligned to avoid bending any connector pins. Also, before you connect a cable, ensure that both connectors are correctly oriented and aligned.
- ➔ **NOTICE:** To disconnect a network cable, first unplug the cable from your computer and then unplug the cable from the network device.
  - 1 Disconnect all telephone or network cables from the computer.
- ➔ **NOTICE:** To avoid damaging the system board, you must remove the main battery before you service the computer.
  - 2 Disconnect your computer and all attached devices from their electrical outlets.

- 3 Press the power button to ground the system board.

 **CAUTION:** To guard against likelihood of electric shock, laceration by moving fan blades or other unexpected injuries, always unplug your computer from the electrical outlet before opening the cover.

- 4 Open the computer cover.

 **NOTICE:** Before touching anything inside your computer, ground yourself by touching an unpainted metal surface, such as the metal at the back of the computer. While you work, periodically touch an unpainted metal surface to dissipate static electricity, which could harm internal components.

## Removing the Computer Cover

 **CAUTION:** Before you begin any of the procedures in this section, follow the safety instructions in the *Product Information Guide*.

 **CAUTION:** To guard against electrical shock, always unplug your computer from the electrical outlet before removing the cover.

 **CAUTION:** Do not operate your equipment with any cover(s) (including computer covers, bezels, filler brackets, front-panel inserts, etc.) removed.

- 1 Follow the procedures in "Before You Begin" on page 105.

 **NOTICE:** Ensure that sufficient space exists to support the removed cover.

 **NOTICE:** Ensure that you are working on a level, protected surface to avoid scratching either the computer or the surface on which it is resting.

- 2 Lay your computer on its side with the computer cover facing up.
- 3 Remove the two screws securing the cover, using a screwdriver.

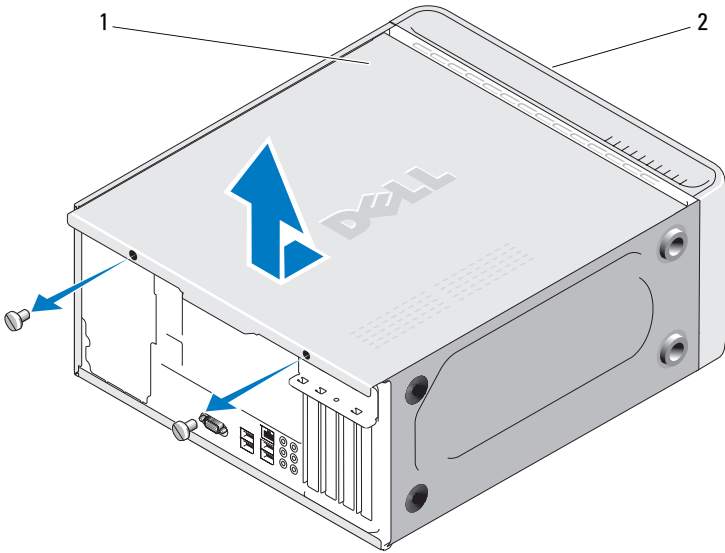

1 computer cover      2 front of computer

- 4 Release the computer cover by pulling it away from the front of the computer and lifting it up.
- 5 Set the cover aside in a secure location.

# Inside View of Your Computer

**!** **CAUTION:** Before you begin any of the procedures in this section, follow the safety instructions in the *Product Information Guide*.

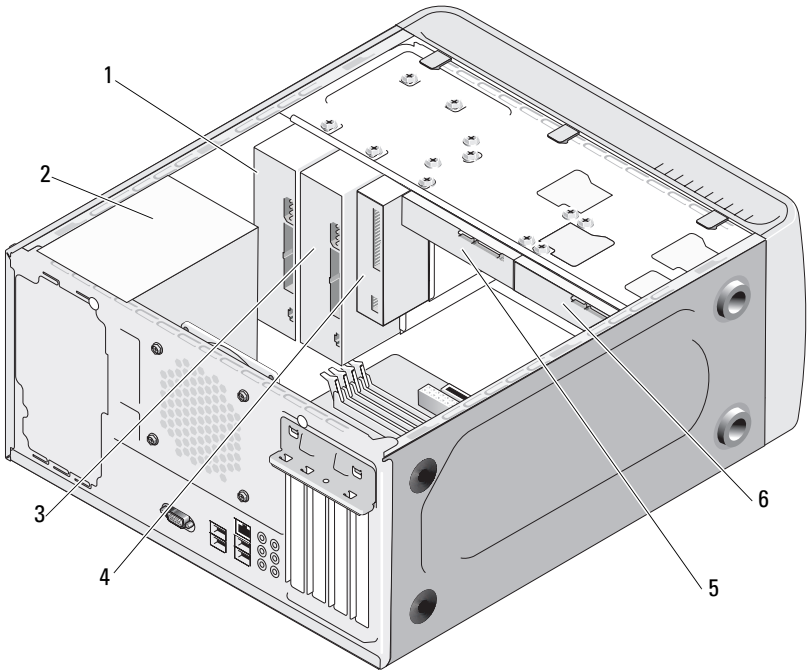

**NOTE:** The inside view of your computer may vary based on the computer model.

- |   |                              |   |              |   |                          |
|---|------------------------------|---|--------------|---|--------------------------|
| 1 | CD or DVD drive              | 2 | power supply | 3 | optional CD or DVD drive |
| 4 | floppy drive or Media Reader | 5 | hard drive   | 6 | optional hard drive      |

# System Board Components

## Inspiron 530

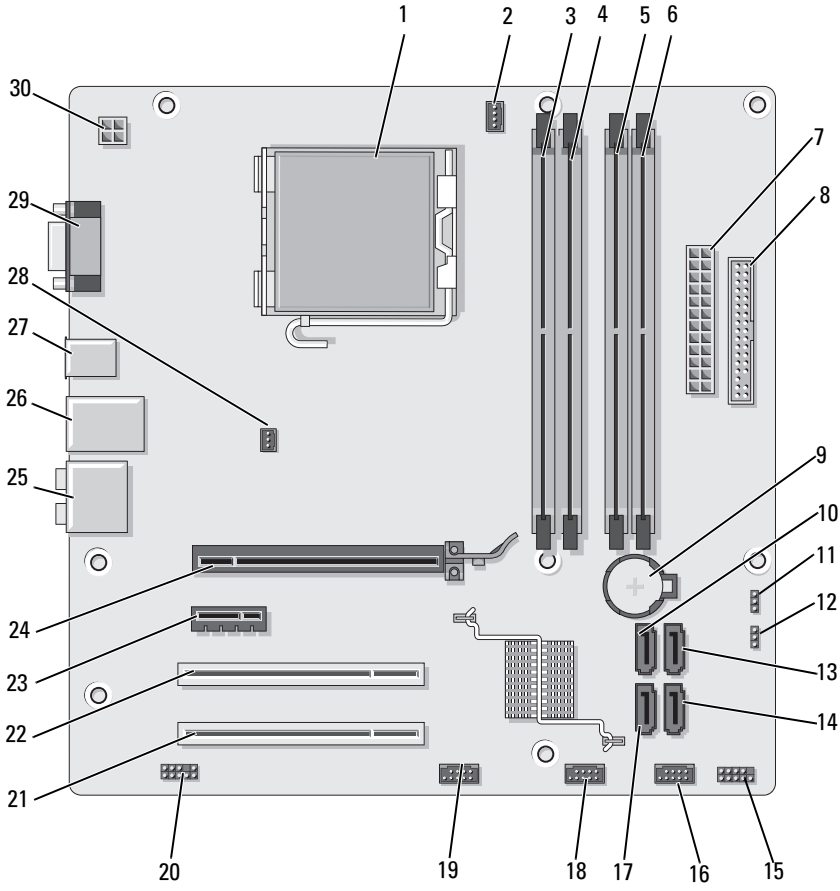

1	processor socket (CPU)	2	processor fan connector (CPU_FAN)	3	memory module connectors (DIMM_1)
4	memory module connectors (DIMM_2)	5	memory module connectors (DIMM_3)	6	memory module connectors (DIMM_4)
7	main power connector (ATX_POWER)	8	Floppy Drive Connector	9	battery socket
10	serial ATA drive connectors (SATA0)	11	CMOS jumper (CLEAR_CMOS)	12	password jumper (CLEAR_PW)
13	serial ATA drive connectors (SATA1)	14	serial ATA drive connectors (SATA4)	15	front panel connector (F_PANEL)
16	front USB connector (F_USB1)	17	serial ATA drive connectors (SATA5)	18	front USB connector (F_USB2)
19	front FlexBay connector (F_USB3)	20	front audio (F_AUDIO)	21	PCI connector (PCI2)
22	PCI connector (PCI1)	23	PCI Express x1 connector (PCIE_X1)	24	PCI Express x16 connector (PCIE_X16)
25	audio connectors	26	2 USB and 1 LAN connector	27	2 USB connectors
28	chassis fan connector (CHASSIS_FAN)	29	video connector (VGA)	30	power for cpu (ATX_CPU)

# Inspiron 530a

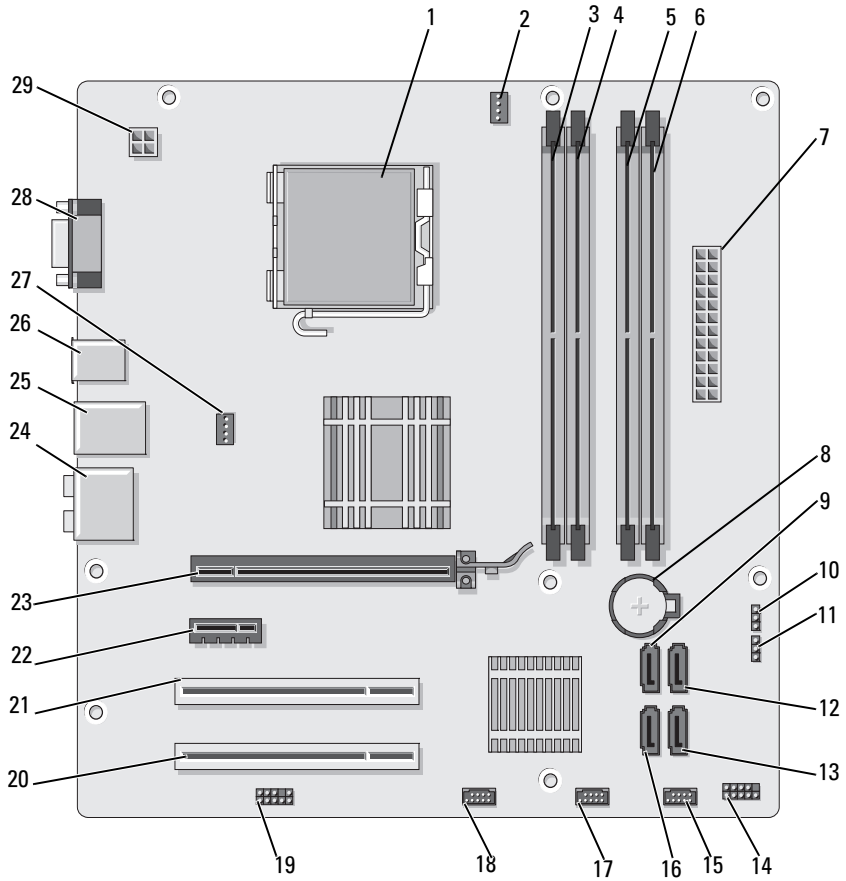



1	processor socket (CPU)	2	processor fan connector (CPU_FAN)	3	memory module connectors (DIMM_1)
4	memory module connectors (DIMM_2)	5	memory module connectors (DIMM_3)	6	memory module connectors (DIMM_4)
7	main power connector (ATX_POWER)	8	battery socket	9	serial ATA drive connectors (SATA0)
10	CMOS jumper (CLEAR CMOS)	11	password jumper (CLEAR_PW)	12	serial ATA drive connectors (SATA1)
13	serial ATA drive connectors (SATA4)	14	front panel connector (F_PANEL)	15	front USB connector (F_USB1)
16	serial ATA drive connectors (SATA5)	17	front USB connector (F_USB2)	18	front FlexBay connector (F_USB3)
19	front audio (F_AUDIO)	20	PCI connector (PCI2)	21	PCI connector (PCI1)
22	PCI Express x1 connector (PCIE_X1)	23	PCI Express x16 connector (PCIE_X16)	24	audio connectors
25	2 USB and 1 LAN connector	26	2 USB connectors	27	chassis fan connector (CHASSIS_FAN)
28	video connector (VGA)	29	power for cpu (ATX_CPU)		

# Inspiron 530b

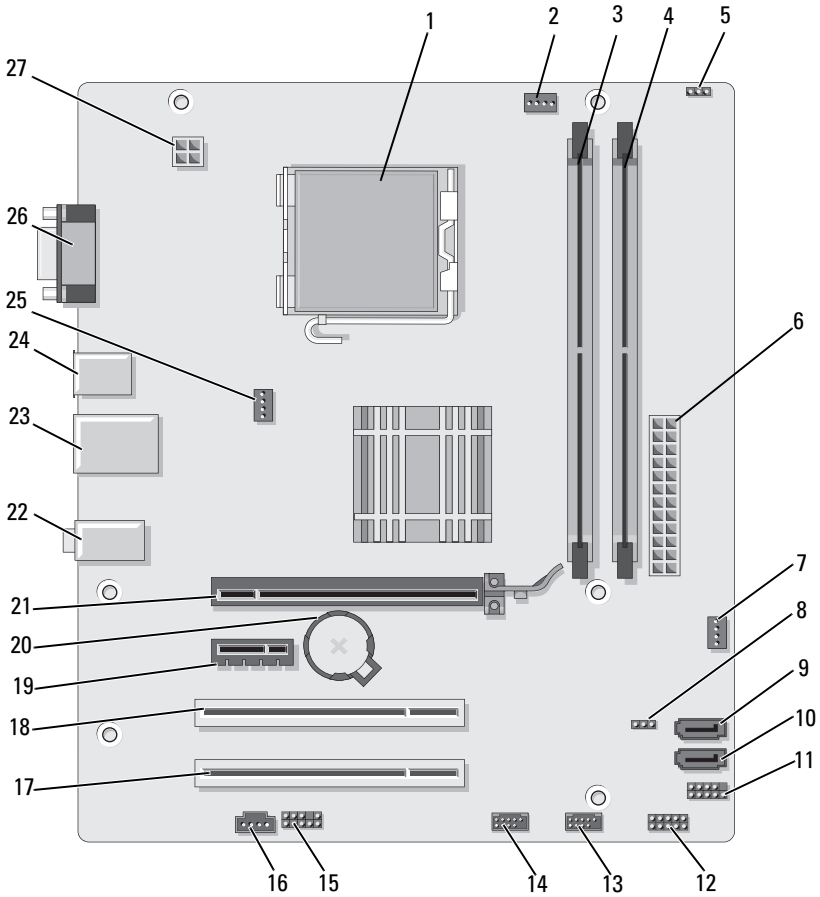

1	processor socket (CPU)	2	processor fan connector (CPU_FAN)	3	memory module connectors (DIMM_1)
4	memory module connectors (DIMM_2)	5	password jumper (CLEAR_PW)	6	main power connector (ATX_POWER)
7	SYS_FAN2	8	CLR_CMOS	9	serial ATA drive connectors (SATA2)
10	serial ATA drive connectors (SATA1)	11	FP1	12	JSPI 1
13	front USB connector (F_USB1)	14	front USB connector (F_USB2)	15	F_AUDIO
16	CD_IN	17	PCI connector (PCI2)	18	PCI connector (PCI1)
19	PCI Express x1 connector (PCIE_x1)	20	battery socket	21	PCI Express x16 connector (PCIE_x16)
22	audio connectors	23	2 USB and 1 LAN connector	24	2 USB connectors
25	chassis fan connector (CHASSIS_FAN)	26	video connector (VGA)	27	power for cpu (ATX_CPU)

# Inspiron 530c

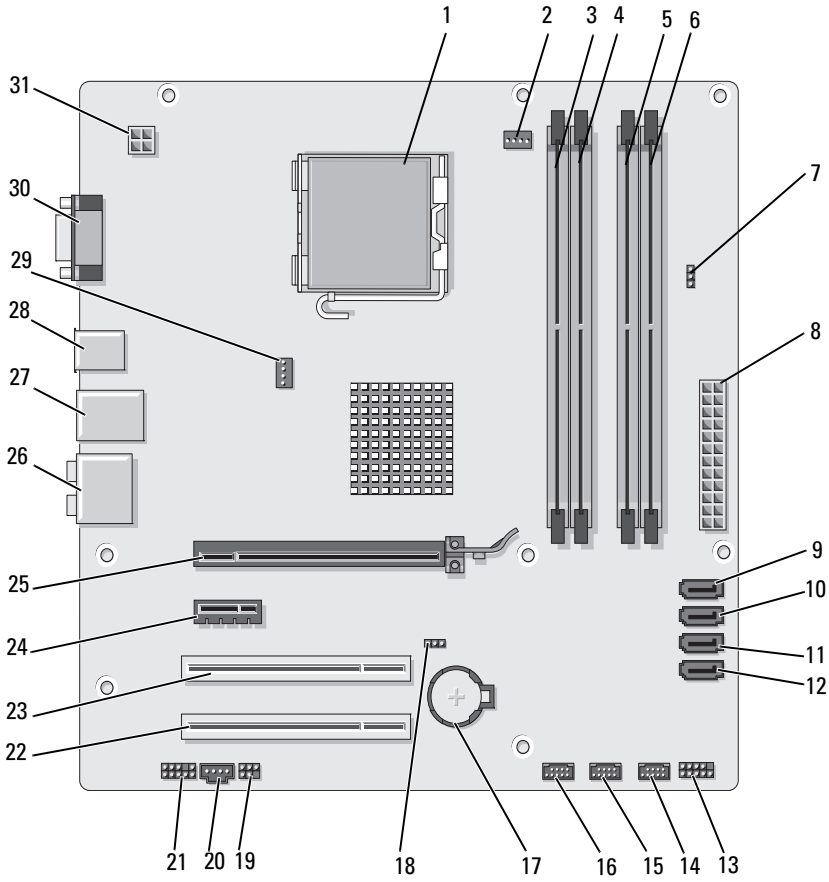

1	processor socket (CPU)	2	processor fan connector (CPU_FAN)	3	memory module connectors (DIMM_1)
4	memory module connectors (DIMM_2)	5	memory module connectors (DIMM_3)	6	memory module connectors (DIMM_4)
7	password jumper (CLR_PSWD)	8	main power connector (ATX_POWER)	9	serial ATA drive connectors (SATA0)
10	serial ATA drive connectors (SATA1)	11	serial ATA drive connectors (SATA2)	12	serial ATA drive connectors (SATA3)
13	front panel connector (F_PANEL)	14	front USB connector (F_USB3)	15	front USB connector (F_USB2)
16	front USB connector (F_USB1)	17	battery socket	18	CMOS jumper (CLEAR CMOS)
19	SPDIF	20	CD_IN	21	front audio (F_AUDIO)
22	PCI connector (PCI2)	23	PCI connector (PCI1)	24	PCI Express x1 connector (PCIE_X1)
25	PCI Express x16 connector (PCIE_X16)	26	audio connectors	27	2 USB and 1 LAN connector
28	2 USB connectors	29	chassis fan connector (CHASSIS_FAN)	30	video connector (VGA)
31	power for cpu (ATX_CPU)				

# Inspiron 530d

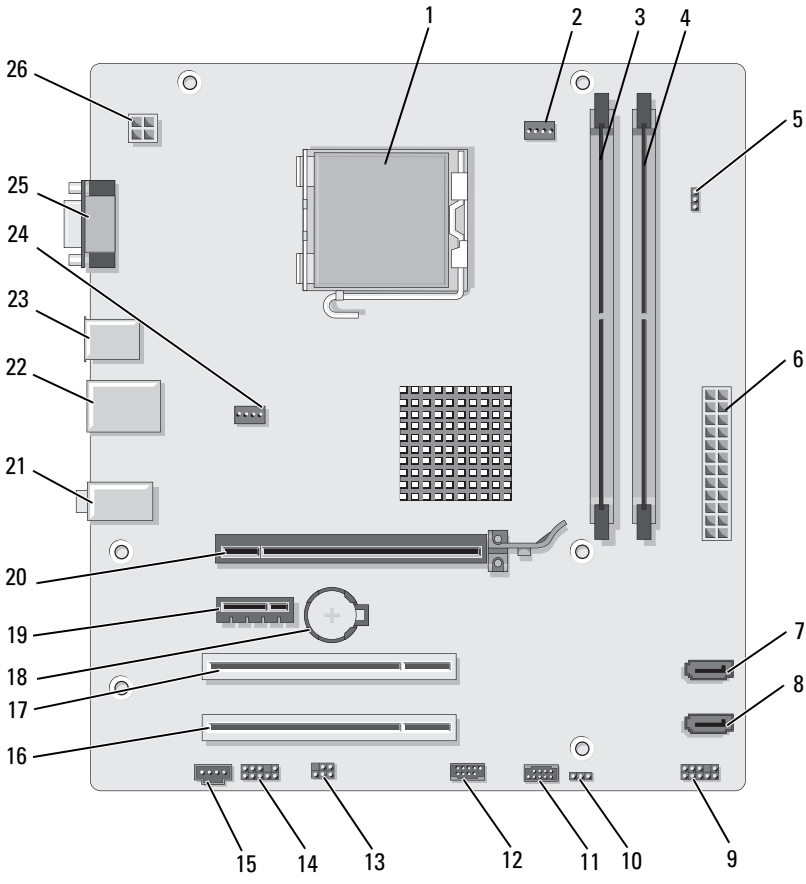

1	processor socket (CPU)	2	processor fan connector (CPU_FAN)	3	memory module connectors (DIMM_1)
4	memory module connectors (DIMM_2)	5	password jumper (CLEAR_PSWD)	6	main power connector (ATX_POWER)
7	serial ATA drive connectors (SATA1)	8	serial ATA drive connectors (SATA0)	9	Front Panel
10	CMOS jumper CLR_CMOS	11	USB2	12	USB1
13	SPDIF	14	front audio (F_AUDIO)	15	CD_IN
16	PCI connector (PCI2)	17	PCI connector (PCI1)	18	battery socket
19	PCI Express x1 connector (PCIE_X1)	20	PCI Express x16 connector (PCIE_X16)	21	audio connectors
22	2 USB and 1 LAN connector	23	2 USB connectors	24	fan connector (SYS_FAN)
25	video connector (VGA)	26	power for cpu (ATX_CPU)		

# Power Supply DC Connector Pin Assignments

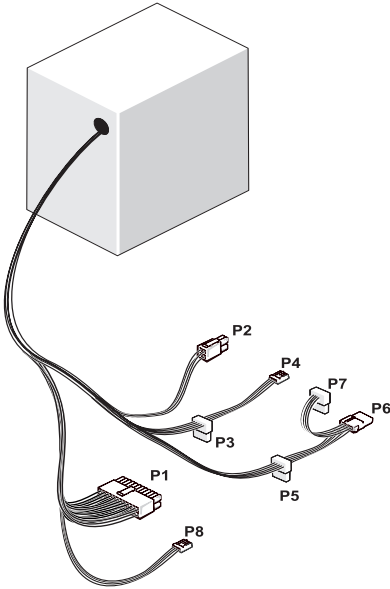

## *DC Power Connector P1*

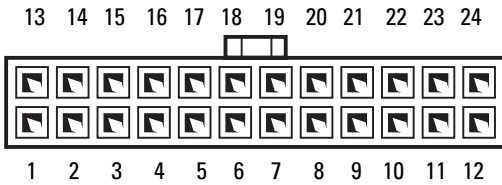



<b>Pin Number</b>	<b>Signal name</b>	<b>Wire Color</b>	<b>Wire Size</b>
1	+3.3 V	Orange	20 AWG
2	+3.3 V	Orange	20 AWG
3	RTN	Black	20 AWG
4	+5 V	Red	20 AWG
5	RTN	Black	20 AWG
6	+5 V	Red	20 AWG
7	RTN	Black	20 AWG
8	POK	Gray	22 AWG
9	+5 V AUX	Purple	20 AWG
10	+12 V	Yellow	20 AWG
11	+12 V	Yellow	20 AWG
12	+3.3 V	Orange	20 AWG
13	+3.3 V	Orange	20 AWG
13	+3.3 V Sense	Brown	22 AWG
14	-12 V	Blue	22 AWG
15	RTN	Black	20 AWG
16	PS_ON	Green	22 AWG
17	RTN	Black	20 AWG
18	RTN	Black	20 AWG
19	RTN	Black	20 AWG
20	OPEN		
21	+5 V	Red	20 AWG
22	+5 V	Red	20 AWG
23	+5 V	Red	20 AWG
24	RTN	Black	20 AWG

### DC Power Connector P2



Pin Number	Signal Name	18-AWG Wire
1	RTN	Black
2	RTN	Black
3	+12 VADC	Brown
4	+12 VADC	Brown

### DC Power Connectors P3, P4, P5, and P6



Pin Number	Signal name	18-AWG Wire
1	+3.3 VDC	Orange
2	RTN	Black
3	+5 VDC	Red
4	RTN	Black
5	+12 VBDC	Yellow

### DC Power Connector P7

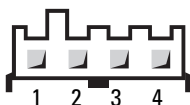

Pin Number	Signal Name	22-AWG Wire
1	+5 VDC	Red
2	GND	Black
3	GND	Black
4	+12 VDC	Yellow

### **DC Power Connector P8 (For 350 W PSU only)**



**NOTE:** The P8 connector is not used on your computer.

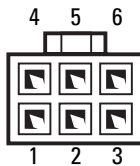

Pin Number	Signal Name	18-AWG Wire Color
1	+12 VDC	Yellow
2	+12 VDC	Yellow
3	+12 VDC	Yellow
4	GND	Black
5	GND	Black
6	GND	Black

## Memory

You can increase your computer memory by installing memory modules on the system board. Your computer supports DDR2 memory. For additional information on the type of memory supported by your computer, see "Memory" on page 179.



**NOTICE:** Do not install ECC or buffered memory modules. Only unbuffered, non-ECC memory is supported.

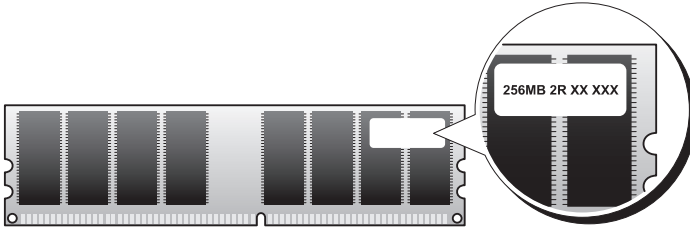

## Memory Installation Guidelines

### Inspiron 530/530a/530c

- DIMM connectors must be populated in numerical order beginning with connectors DIMM\_1 and DIMM\_3, then connectors DIMM\_2 and DIMM\_4. If a single DIMM is installed, you must install it in connector DIMM\_1.

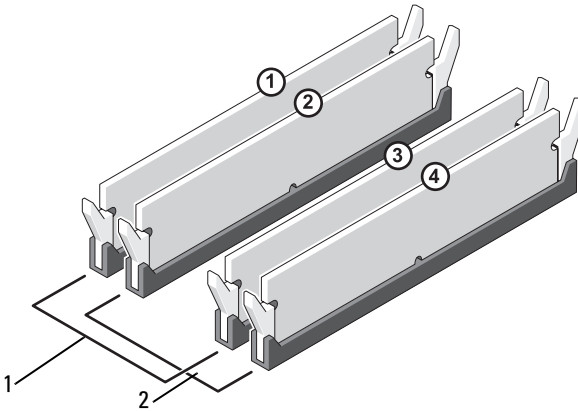

- 1 Pair A: matched pair of memory modules in connectors DIMM\_1 and DIMM\_3
- 2 Pair B: matched pair of memory modules in connectors DIMM\_2 and DIMM\_4

## Inspiron 530b/530d

- DIMM connectors must be populated in numerical order beginning with connector DIMM\_1 and then connector DIMM\_2.

If a single DIMM is installed, you must install it in connector DIMM\_1.

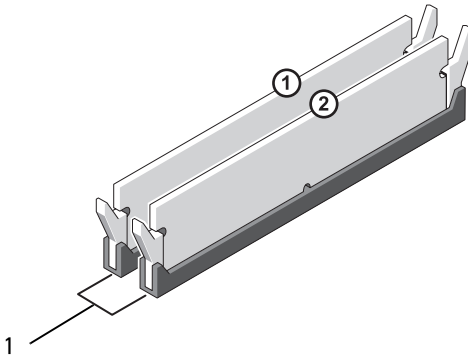

- 1 Pair A: matched pair of memory modules in connector DIMM\_1 and DIMM\_2

For best performance, memory modules should be installed in *pairs of matched memory size, speed, and technology*. If the memory modules are not installed in matched pairs, the computer will operate, but with a slight reduction in performance. (See the label on the module to determine the module's capacity.) For example, if you install a mixed pair of DDR2 533-MHz and DDR2 667-MHz and 800 MHz memory, the modules function at the slowest speed installed.

**➡ NOTICE:** If you remove your original memory modules from the computer during a memory upgrade, keep them separate from any new modules that you may have, even if you purchased the new modules from Dell. If possible, do not pair an original memory module with a new memory module. Otherwise, your computer may not start properly. You should install your original memory modules in pairs either in: DIMM connectors 1 and 3 or DIMM connectors 2 and 4 (not applicable for Inspiron 530b/530d).

**📎 NOTE:** Memory purchased from Dell is covered under your computer warranty.

## Installing Memory

**⚠ CAUTION:** Before you begin any of the procedures in this section, follow the safety instructions in the *Product Information Guide*.

**⚠ CAUTION:** Before installing memory, you must remove the PCI Express x16 card. See "Cards" on page 129.

**🔄 NOTICE:** To prevent static damage to components inside your computer, discharge static electricity from your body before you touch any of your computer's electronic components. You can do so by touching an unpainted metal surface on the computer chassis.

- 1 Follow the procedures in "Before You Begin" on page 105.
- 2 Press the securing clip at each end of the memory module connector.

### Inspiron 530/530a/530c

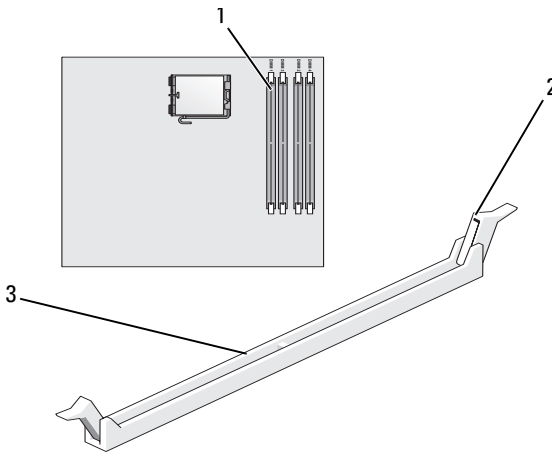

- 1 memory connector closest from processor (DIMM\_1)      2 securing clips (2)      3 connector

## Inspiron 530b/530d

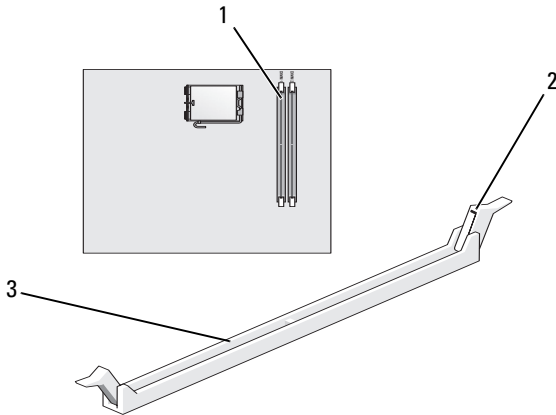

- 1 memory connector closest from processor (DIMM\_1)    2 securing clips (2)    3 connector

- 3 Align the notch on the bottom of the module with the crossbar in the connector.

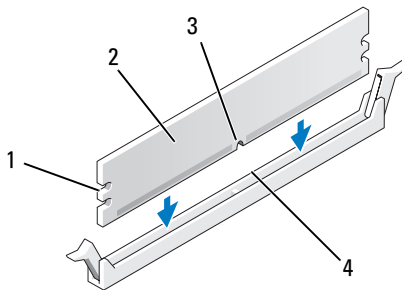

- 1 cutouts (2)    2 memory module  
3 notch    4 crossbar

- ➔ **NOTICE:** To avoid damage to the memory module, press the module straight down into the connector while you apply equal force to each end of the module.

- 4 Insert the module into the connector until the module snaps into position. If you insert the module correctly, the securing clips snap into the cutouts at each end of the module.

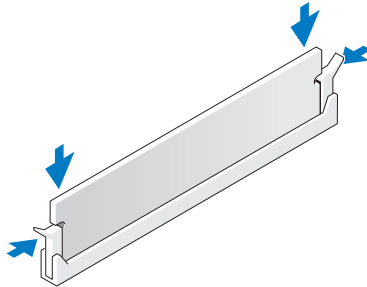

- 5 Replace the PCI Express x16 card. See "Cards" on page 129.
- 6 Replace the computer cover.
- ➔ **NOTICE:** To connect a network cable, first plug the cable into the network device and then plug it into the computer.
- 7 Connect your computer and devices to electrical outlets, and turn them on.
- 8 Right-click the **My Computer** icon and click **Properties**.
- 9 Click the **General** tab.
- 10 To verify that the memory is installed correctly, check the amount of memory (RAM) listed.

## Removing Memory

- ⚠ **CAUTION:** Before you begin any of the procedures in this section, follow the safety instructions in the *Product Information Guide*.
  - ⚠ **CAUTION:** Before removing memory, you must remove the PCI Express x16 card. See "Cards" on page 129.
  - ➔ **NOTICE:** To prevent static damage to components inside your computer, discharge static electricity from your body before you touch any of your computer's electronic components. You can do so by touching an unpainted metal surface on the computer chassis.
- 1 Follow the procedures in "Before You Begin" on page 105.
  - 2 Press out the securing clip at each end of the memory module connector.



- 3 Grasp the module at the end of the board and lift up.
- 4 Replace the PCI Express x16 card. See "Cards" on page 129.

## Cards

**!** **CAUTION:** Before you begin any of the procedures in this section, follow the safety instructions in the *Product Information Guide*.

**➡** **NOTICE:** To prevent static damage to components inside your computer, discharge static electricity from your body before you touch any of your computer's electronic components. You can do so by touching an unpainted metal surface on the computer chassis.

Your Dell™ computer provides the following slots for PCI and PCI Express cards:

- One PCI Express x16 card slot (SLOT1)
- One PCI Express x1 card slot (SLOT2)
- Two PCI card slots (SLOT3, SLOT4)

See "Inside View of Your Computer" on page 109 for card slot location.

### PCI and PCI Express Cards

Your computer supports two PCI cards, one PCI Express x16 card and one PCI Express x1 card.

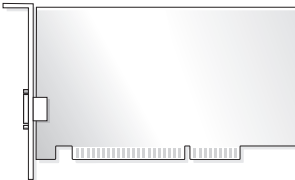

- If you are installing or replacing a card, follow the procedures in the next section.
- If you are removing but not replacing a card, see "Removing a PCI/PCI Express Card" on page 134.
- If you are replacing a card, remove the current driver for the card from the operating system.

## Installing a PCI/PCI Express Card

- 1 Follow the procedures in "Before You Begin" on page 105.
- 2 Remove the computer cover. See "Removing the Computer Cover" on page 107.

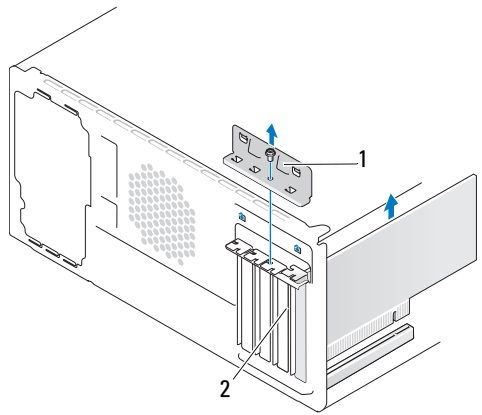

1 card retention bracket      2 filler bracket

- 3 Remove the screw holding the card retention bracket.
- 4 Lift the card retention bracket and set it aside in a secure place.
- 5 If you are installing a new card, remove the filler bracket to create a cardslot opening.
- 6 If you are replacing a card that is already installed in the computer, remove the card.

If necessary, disconnect any cables connected to the card.

- For PCI card, grasp the card by its top corners, and ease it out of its connector.
- For PCI Express card, pull the securing tab, grasp the card by its top corners, and then ease it out of its connector.

 **NOTE:** The position of the card shown in the illustration is indicative and may vary from the original.

**7** Prepare the card for installation.

See the documentation that came with the card for information on configuring the card, making internal connections, or otherwise customizing it for your computer.

**!** **CAUTION:** Some network adapters automatically start the computer when they are connected to a network. To guard against electrical shock, laceration by moving fan blades, or other unexpected injuries, always unplug your computer from the electrical outlet before installing any cards.

**8** Place the card in the connector and press down firmly. Ensure that the card is fully seated in the slot.

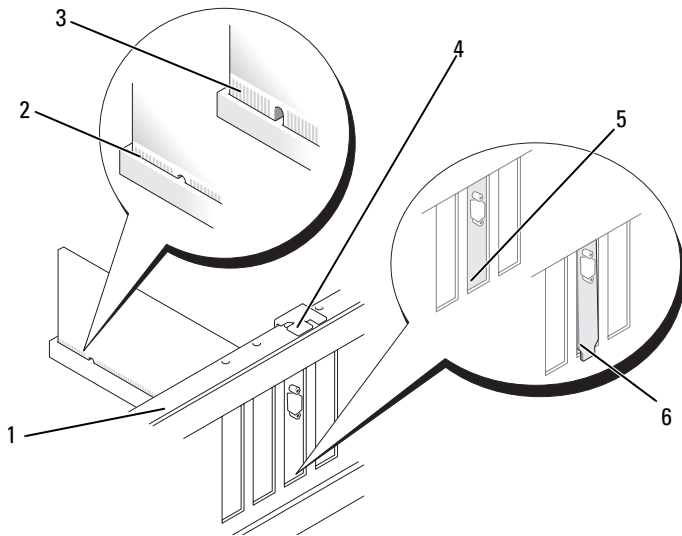

- 1 alignment bar    2 fully-seated card    3 not fully seated card  
4 alignment guide    5 bracket within slot    6 bracket caught outside of slot

**9** If you are installing the PCI Express card into the x16 card connector, position the card so the securing slot is aligned with the securing tab.

- 10** Place the card in the connector and press down firmly. Ensure that the card is fully seated in the slot.

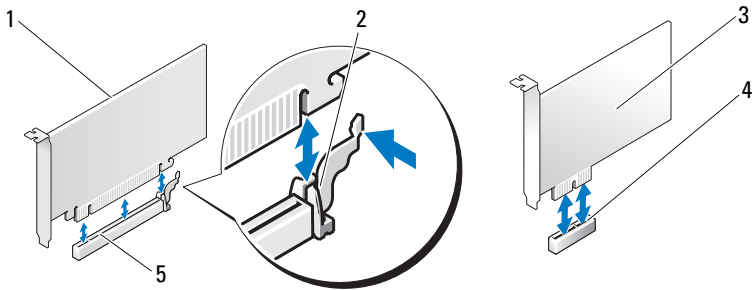

- 1 PCI Express x16 card      2 securing tab      3 PCI Express x1 card  
4 PCI Express x1 card slot    5 PCI Express x16 card slot

- 11** Replace the card retention bracket ensuring that:
- The guide clamp is aligned with the guide notch.
  - The tops of all cards and filler brackets are flush with the alignment bar.
  - The notch in the top of the card or filler bracket fits around the alignment guide.

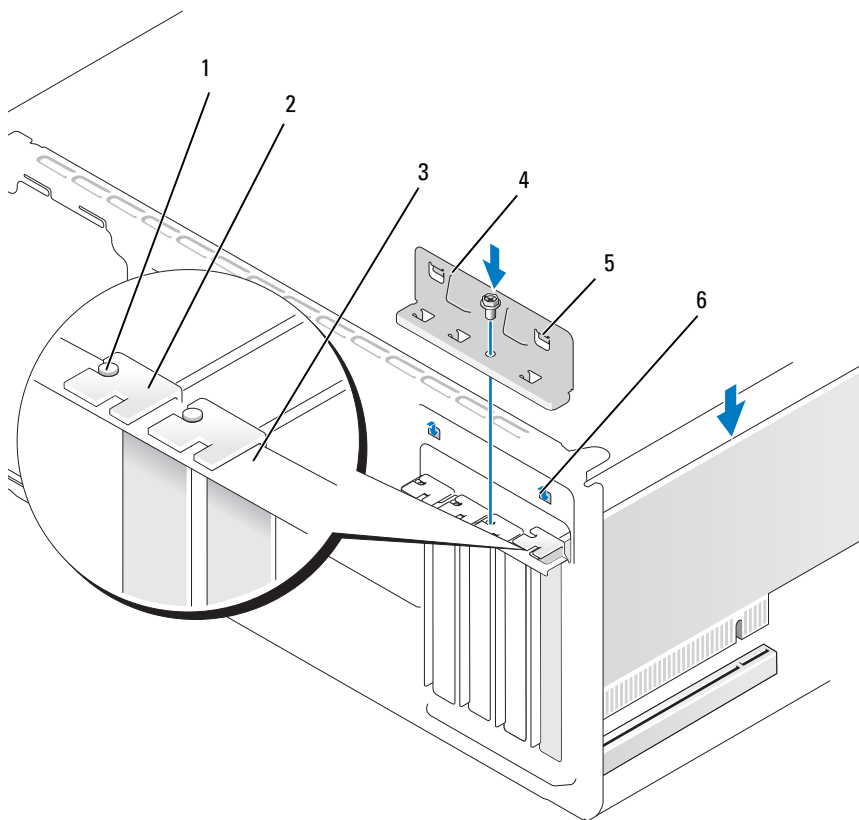

- |   |                        |   |                 |   |                 |
|---|------------------------|---|-----------------|---|-----------------|
| 1 | alignment guide        | 2 | filler bracket  | 3 | alignment bar   |
| 4 | card retention bracket | 5 | guide clamp (2) | 6 | guide notch (2) |

**12** Fix the card retention bracket by replacing and tightening the screw.

**13** Connect any cables that should be attached to the card.

See the documentation for the card for information about the card's cable connections.

**➡ NOTICE:** Do not route card cables over or behind the cards. Cables routed over the cards can prevent the computer cover from closing properly or cause damage to the equipment.

 **NOTICE:** To connect a network cable, first plug the cable into the network device and then plug it into the computer.

- 14 Replace the computer cover, reconnect the computer and devices to electrical outlets, and then turn them on.
- 15 If you installed a sound card:
  - a Enter system setup (see "System Setup" on page 187), go to **Onboard Devices** and select **Integrated Audio**, and then change the setting to **Off**.
  - b Connect external audio devices to the sound card's connectors. Do not connect external audio devices to the microphone, speaker/headphone, or line-in connectors on the back panel. See "Back View of the Computer" on page 19.
- 16 If you installed an add-in network adapter and want to disable the integrated network adapter:
  - a Enter system setup (see "System Setup" on page 187), go to **Onboard Devices** and select **Integrated NIC**, and then change the setting to **Off**.
  - b Connect the network cable to the add-in network adapter's connectors. Do not connect the network cable to the integrated connector on the back panel. See "Back View of the Computer" on page 19.
- 17 Install any drivers required for the card as described in the card documentation.

### Removing a PCI/PCI Express Card

- 1 Follow the procedures in "Before You Begin" on page 105.
- 2 Remove the computer cover. See "Removing the Computer Cover" on page 107.
- 3 Remove the screw holding the card retention bracket.
- 4 Lift the card retention bracket and set it aside in a secure place.
- 5 If you are replacing a card that is already installed in the computer, remove the card.

If necessary, disconnect any cables connected to the card.

- For PCI card, grasp the card by its top corners, and ease it out of its connector.
- For PCI Express card, pull the securing tab, grasp the card by its top corners, and then ease it out of its connector.

- 6 If you are removing the card permanently, install a filler bracket in the empty card-slot opening.



**NOTE:** Installing filler brackets over empty card-slot openings is necessary to maintain FCC certification of the computer. The brackets also keep dust and dirt out of your computer.

- 7 Replace the card retention bracket, ensuring that:

- The guide clamp is aligned with the guide notch.
- The tops of all cards and filler brackets are flush with the alignment bar.
- The notch in the top of the card or filler bracket fits around the alignment guide.

- 8 Fix the card retention bracket by replacing and tightening the screw.



**NOTICE:** To connect a network cable, first plug the cable into the network device and then plug it into the computer.

- 9 Replace the computer cover, reconnect the computer and devices to electrical outlets, and then turn them on.

- 10 Remove the card's driver from the operating system.

- 11 If you removed a sound card:

- a Enter system setup (see "System Setup" on page 187), go to **Onboard Devices** and select **Integrated Audio**, and then change the setting to **On**.
- b Connect external audio devices to the audio connectors on the back panel of the computer. See "Back View of the Computer" on page 19.

- 12 If you removed an add-in network connector:

- a Enter system setup (see "System Setup" on page 187), go to **Onboard Devices** and select **Integrated NIC**, and then change the setting to **On**.
- b Connect the network cable to the integrated connector on the back panel of the computer. See "Back View of the Computer" on page 19 and "Back Panel Connectors" on page 22.

# Bezel

**⚠ CAUTION:** Before you begin any of the procedures in this section, follow the safety instructions in the *Product Information Guide*.

**⚠ CAUTION:** To guard against electrical shock, always unplug your computer from the electrical outlet before removing the cover.

## Removing the Bezel

- 1 Follow the procedures in "Before You Begin" on page 105.
- 2 Remove the computer cover (see "Removing the Computer Cover" on page 107).

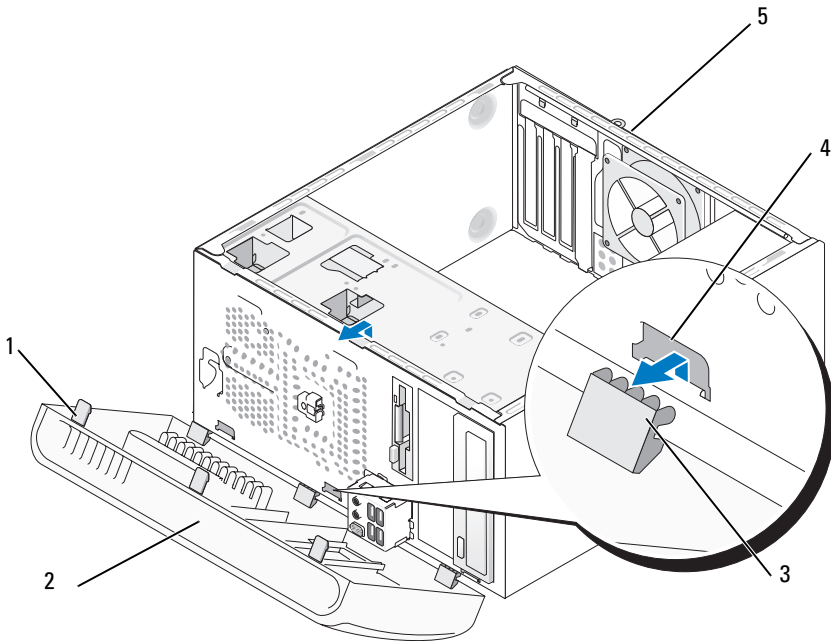

- |                    |                    |                   |
|--------------------|--------------------|-------------------|
| 1 bezel grip (3)   | 2 bezel            | 3 bezel clamp (3) |
| 4 clamp insert (3) | 5 back of computer |                   |

- 3 Grasp and lift the bezel grips one at a time to release it from the front panel.



- 4 Rotate and pull the bezel away from the front of the computer to release bezel clamps from bezel insert.
- 5 Set aside the bezel in a secure location.

## Replacing the Bezel

- 1 Align and insert the bezel clamps in the bezel insert.

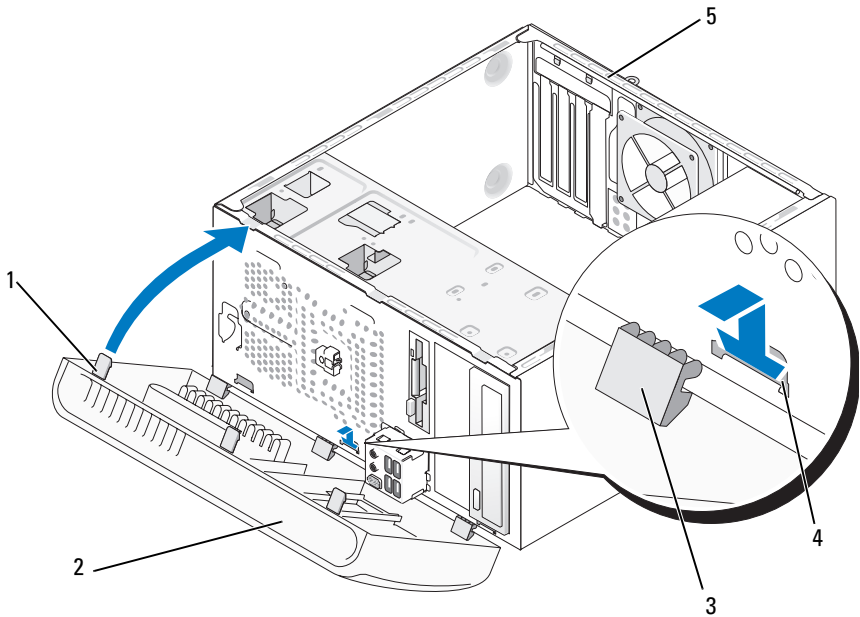

- |                   |                         |                  |
|-------------------|-------------------------|------------------|
| 1 bezel grip (3)  | 2 bezel                 | 3 bezel clamp(3) |
| 4 clamp insert(3) | 5 back side of computer |                  |
- 2 Rotate the bezel toward the computer until it snaps into place on the front panel.

# Drives

Your computer supports a combination of these devices:

- Up to two serial ATA hard drives
- One optional floppy drive or an optional Media Card Reader
- Up to two CD or DVD drives

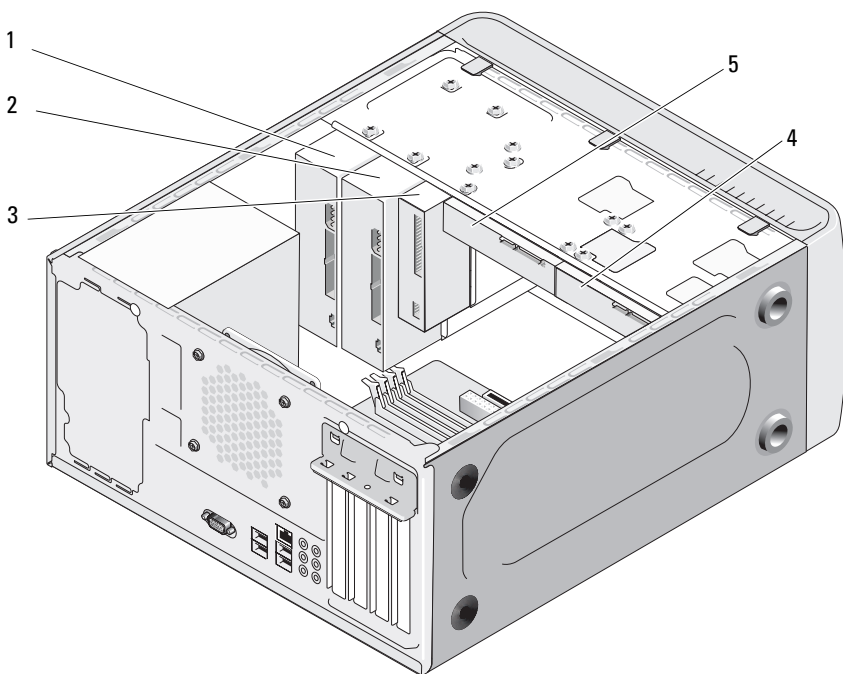

- |   |                     |   |                          |   |                                   |
|---|---------------------|---|--------------------------|---|-----------------------------------|
| 1 | CD or DVD drive     | 2 | optional CD or DVD drive | 3 | floppy drive or Media Card Reader |
| 4 | optional hard drive | 5 | hard drive               |   |                                   |

## Recommended Drive Cable Connections

- Connect serial ATA hard drives to connectors labeled "SATA0" or "SATA1" on the system board.
- Connect serial ATA CD or DVD drives to connectors labeled "SATA4" or "SATA5" on the system board.

 **NOTE:** SATA 4 and SATA 5 are not supported on Inspiron 530b/530d.

## Connecting Drive Cables

When you install a drive, you connect two cables—a DC power cable and a data cable—to the back of the drive.

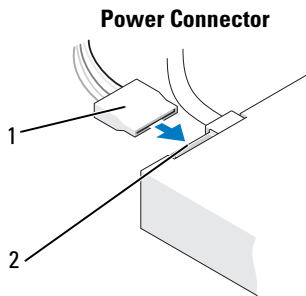

1 power cable      2 power input connector

## Drive Interface Connectors

The drive cable connectors are keyed for correct insertion. Properly align the cable connector key on the cable and the drive before connecting.

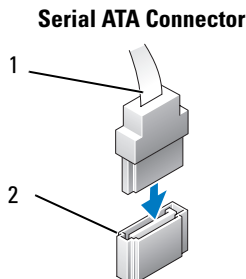

1 interface cable      2 interface connector

## Connecting and Disconnecting Drive Cables

When connecting and disconnecting a serial ATA data cable, disconnect the cable using the pull-tab.

The serial ATA interface connectors are keyed for correct insertion; that is, a notch or a missing pin on one connector matches a tab or a filled-in hole on the other connector.

## Hard Drives



**CAUTION:** Before you begin any of the procedures in this section, follow the safety instructions in the *Product Information Guide*.



**CAUTION:** To guard against electrical shock, always unplug your computer from the electrical outlet before removing the cover.



**NOTICE:** To avoid damage to the drive, do not set it on a hard surface. Instead, set the drive on a surface, such as a foam pad, that will sufficiently cushion it.



**NOTICE:** If you are replacing a hard drive that contains data you want to keep, back up your files before you begin this procedure.

Check the documentation for the drive to verify that it is configured for your computer.

## Removing a Hard Drive

- 1 Follow the procedures in "Before You Begin" on page 105.
- 2 Remove the computer cover (see "Removing the Computer Cover" on page 107).
- 3 Disconnect the power and data cables from the drive.
- 4 Disconnect the data cable from the system board.

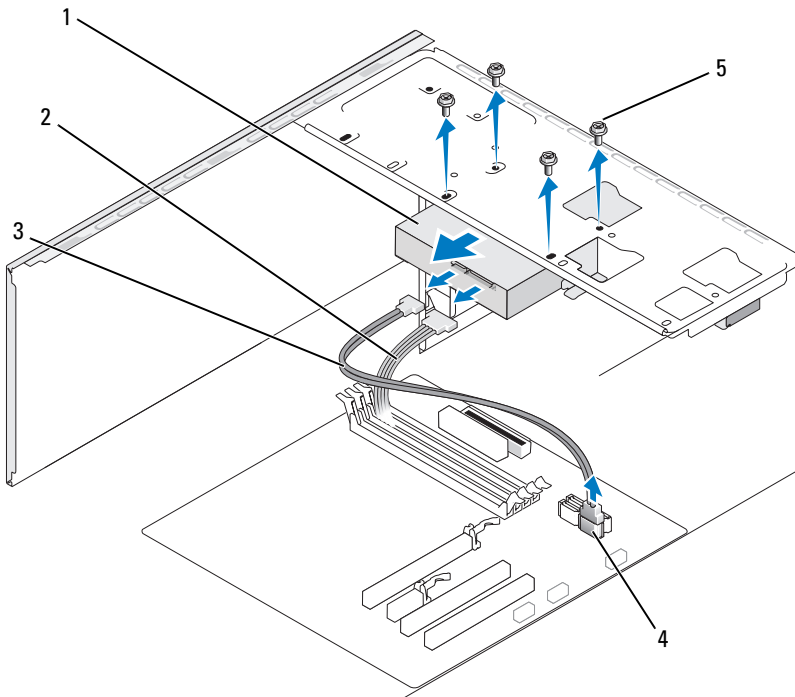

- 1 hard drive                      2 power cable      3 serial ATA data cable  
4 system board connector      5 screws (4)

 **NOTE:** The location of connectors on the system board may vary depending on your computer. See "Inside View of Your Computer" on page 109.

5 Remove the four screws securing the hard drive.

 **NOTICE:** Ensure that you do not scratch the screw holes with the screw driver as the hard disk circuit board assembly is exposed here.

6 Slide the drive out away from the front of the computer.

7 If removing this drive changes the drive configuration, then be sure to reflect these changes in system setup. When you restart your computer, enter system setup (see "System Setup" on page 187), then go to the "Drives" section of the System Setup and under **Drive 0 through 3**, set the Drive to the correct configuration.

- 8 Replace the computer cover (see "Replacing the Computer Cover" on page 176).
- 9 Connect computer and other devices to an electrical outlet.

### Installing a Hard Drive

- 1 Follow the procedures in "Before You Begin" on page 105.
- 2 Remove the computer cover (see "Removing the Computer Cover" on page 107).
- 3 Check the documentation for the drive to verify that it is configured for your computer.
- 4 Slide the hard drive into the hard drive bay.
- 5 Align the four screw holes in the hard drive with the screw holes in the hard drive bay.

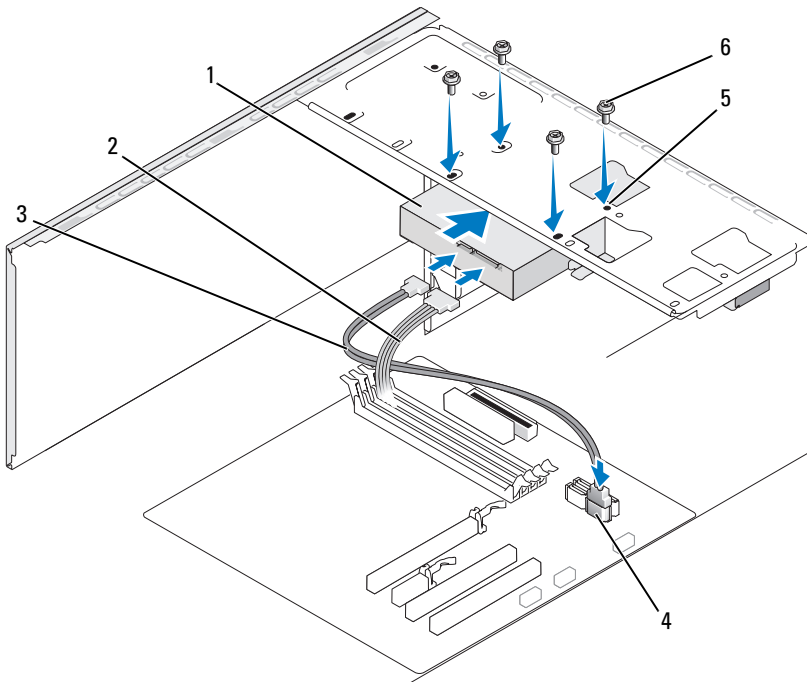



- |   |                        |   |                                       |   |                       |
|---|------------------------|---|---------------------------------------|---|-----------------------|
| 1 | hard drive             | 2 | power cable                           | 3 | serial ATA data cable |
| 4 | system board connector | 5 | screw holes in the hard drive bay (4) | 6 | screws(4)             |

- 6 Replace and tighten the four screws to secure the hard drive.
- 7 Connect the power and data cables to the drive.
- 8 Connect the data cable to the system board.
- 9 Check all cables to be certain that they are properly connected and firmly seated.
- 10 Replace the computer cover (see "Replacing the Computer Cover" on page 176).
-  **NOTICE:** To connect a network cable, first plug the cable into the network port or device and then plug it into the computer.
- 11 Connect your computer and devices to electrical outlets, and then turn them on.
- 12 See the documentation that came with the drive for instructions on installing any software required for drive operation.
- 13 Check the System Setup for drive configuration changes (see "Entering System Setup" on page 188).

### Installing a Second Hard Drive

 **CAUTION:** Before you begin any of the procedures in this section, follow the safety instructions in the *Product Information Guide*.

 **CAUTION:** To guard against electrical shock, always unplug your computer from the electrical outlet before removing the cover.

 **NOTICE:** To avoid damage to the drive, do not set it on a hard surface. Instead, set the drive on a surface, such as a foam pad, that will sufficiently cushion it.

 **NOTE:** For additional drives, extra screws are not shipped during initial purchase of the computer, but are shipped with the additional drives.

- 1 Follow the procedures in "Before You Begin" on page 105.
- 2 Remove the computer cover (see "Removing the Computer Cover" on page 107).

- 3** Check the documentation for the drive to verify that it is configured for your computer.
- 4** Slide the second hard drive into the second hard drive bay.
- 5** Align the screw holes in the second hard drive with the screw holes in the second hard drive bay.

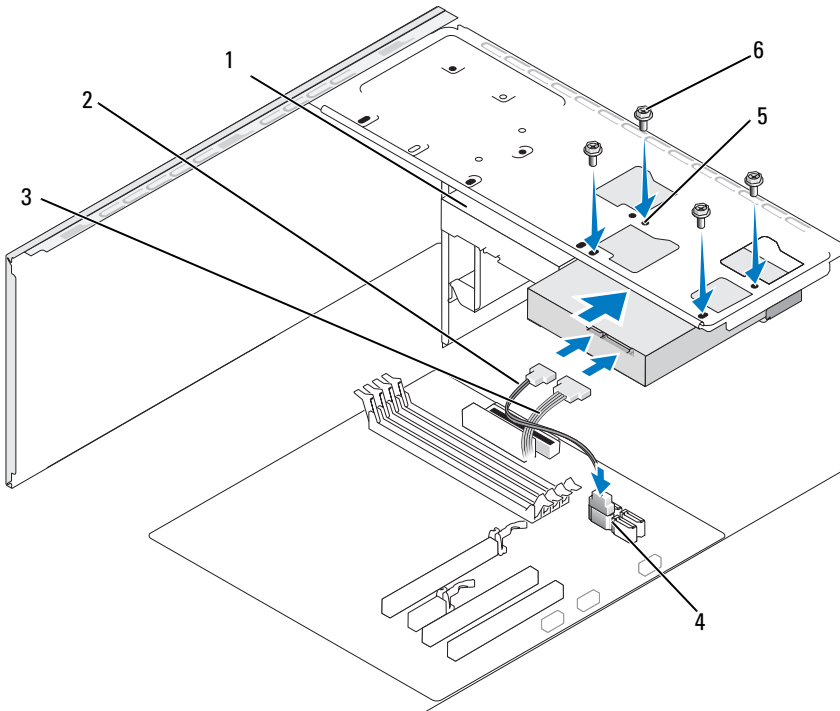

- |                                |   |               |
|--------------------------------|---|---------------|
| 1 second hard drive (optional) | 2 serial ATA data cable                 | 3 power cable |
| 4 system board connector       | 5 screw holes in the hard drive bay (4) | 6 screws (4)  |

- 6** Replace and tighten the four screws to secure the hard drive.
- 7** Connect the power and data cables to the drive.



- 8 Connect the data cable to the system board.
- 9 Check all cables to be certain that they are properly connected and firmly seated.
- 10 Replace the computer cover (see "Replacing the Computer Cover" on page 176).
-  **NOTICE:** To connect a network cable, first plug the cable into the network port or device and then plug it into the computer.
- 11 Connect your computer and devices to electrical outlets, and then turn them on.
- 12 See the documentation that came with the drive for instructions on installing any software required for drive operation.
- 13 Check the System Setup for drive configuration changes (see "Entering System Setup" on page 188).

### Floppy Drive (Optional)



**CAUTION:** Before you begin any of the procedures in this section, follow the safety instructions in the *Product Information Guide*.



**CAUTION:** To guard against electrical shock, always unplug your computer from the electrical outlet before removing the cover.



**NOTE:** If you are adding a floppy drive, see "Installing a Floppy Drive" on page 147.

### Removing a Floppy Drive

- 1 Follow the procedures in "Before You Begin" on page 105.
- 2 Remove the computer cover (see "Removing the Computer Cover" on page 107).
- 3 Remove the bezel (see "Removing the Bezel" on page 136).

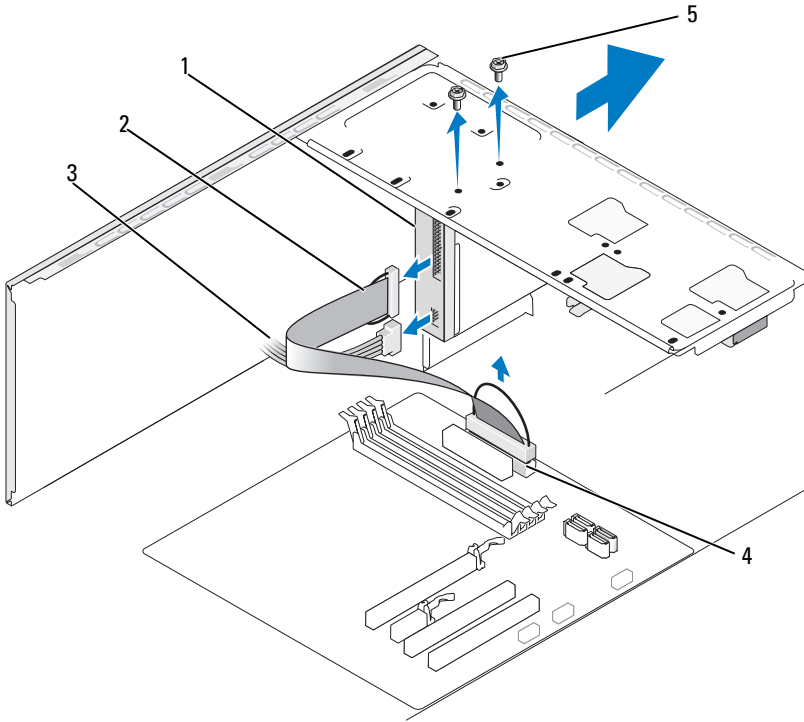

- |                          |              |               |
|--------------------------|--------------|---------------|
| 1 floppy drive           | 2 data cable | 3 power cable |
| 4 system board connector | 5 screws (2) |               |

**NOTE:** The location/connectors may vary depending on your system type. For more information, see "System Board Components" on page 110.

- 4 Disconnect the power and data cables from the back of the floppy drive.

**NOTE:** If you have installed a PCI Express x16 card, this card may cover the floppy-drive connectors. Remove this card before disconnecting the floppy-drive cables (see "Removing a PCI/PCI Express Card" on page 134)

- 5 Disconnect the data cable from the system board.
- 6 Remove the two screws securing the floppy drive.
- 7 Slide the floppy drive out through the front of the computer.

- 8 If you are not replacing the drive, reinstall the drive panel insert (see "Replacing the CD/DVD Panel Insert" on page 159).
- 9 Replace the computer cover (see "Replacing the Computer Cover" on page 176).
- 10 Connect your computer and devices to electrical outlets, and then turn them on.
- 11 Check the system setup for the appropriate diskette Drive Option changes (see "Entering System Setup" on page 188).

### Installing a Floppy Drive

- 1 Follow the procedures in "Before You Begin" on page 105.
- 2 Remove the computer cover (see "Removing the Computer Cover" on page 107).
- 3 Remove the bezel (see "Removing the Bezel" on page 136).
- 4 If you are installing a new floppy drive rather than replacing a drive, align the tip of a Phillips screwdriver with the slot on the break-away metal plate and rotate the screwdriver outwards to break the metal plate.

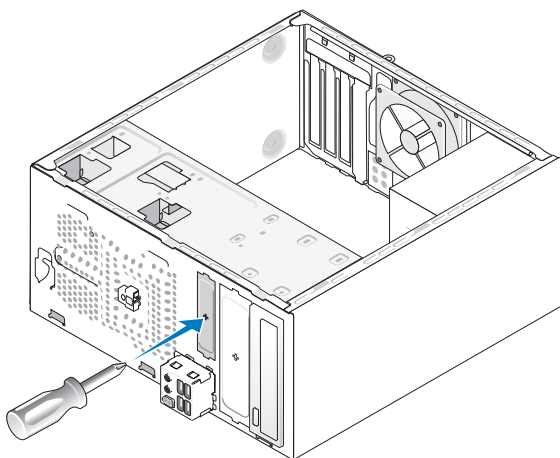

- 5 Gently slide the floppy drive into place in the FlexBay slot.
- 6 Align the screw holes in the floppy drive with the screw holes in the FlexBay.

- 7 Tighten the two screws to secure the floppy drive.
- 8 Attach the power and data cables to the floppy drive.
- 9 Connect the other end of the data cable to the connector labeled "FLOPPY" on the system board (see "Inside View of Your Computer" on page 109) and route the cable through the clip on the shroud.

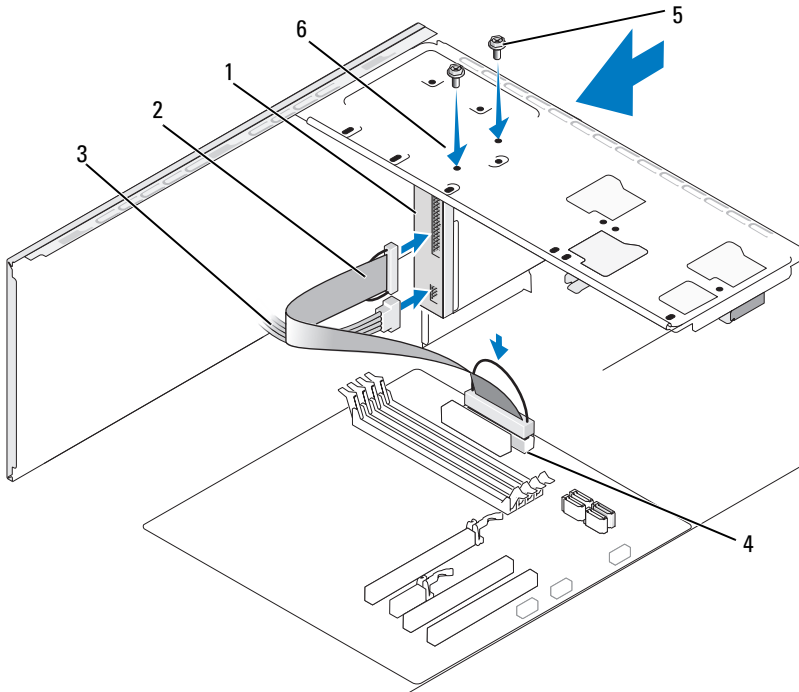

- |                          |                     |                                   |
|--------------------------|---------------------|-----------------------------------|
| 1 floppy drive           | 2 data cable        | 3 power cable                     |
| 4 system board connector | 5 custom screws (2) | 6 screw holes in the floppy drive |

 **NOTE:** The location/connectors may vary depending on your system type. For more information, see "System Board Components" on page 110.

- 10 Check all cable connections, and fold cables out of the way to avoid blocking airflow between the fan and cooling vents.
- 11 Replace the bezel (see "Replacing the Bezel" on page 137).

**12** Replace the computer cover (see "Replacing the Computer Cover" on page 176).

**➔ NOTICE:** To connect a network cable, first plug the cable into the network device and then plug it into the computer.

**13** Connect your computer and devices to their electrical outlets, and turn them on.

See the documentation that came with the drive for instructions on installing any software required for drive operation.

**14** Enter system setup (see "System Setup" on page 187) and select the appropriate **Diskette Drive** option.

**15** Verify that your computer works correctly by running the Dell Diagnostics (see "Dell Diagnostics" on page 90).

### Removing the FlexBay Break-Away Metal Plate

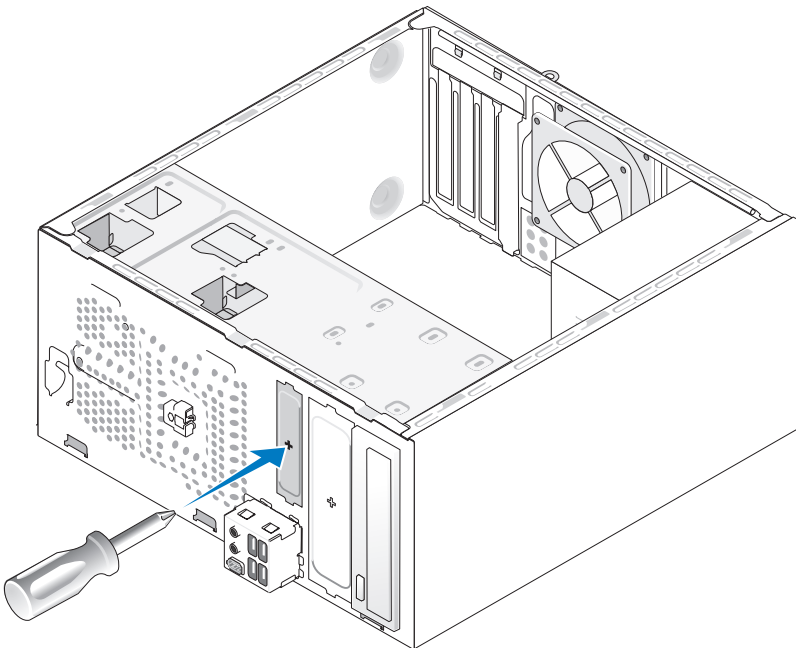

Align the tip of a Phillips screwdriver with the slot on the break-away metal plate and rotate the screwdriver outwards to break and remove the metal plate.

### Replacing the Drive Panel Insert

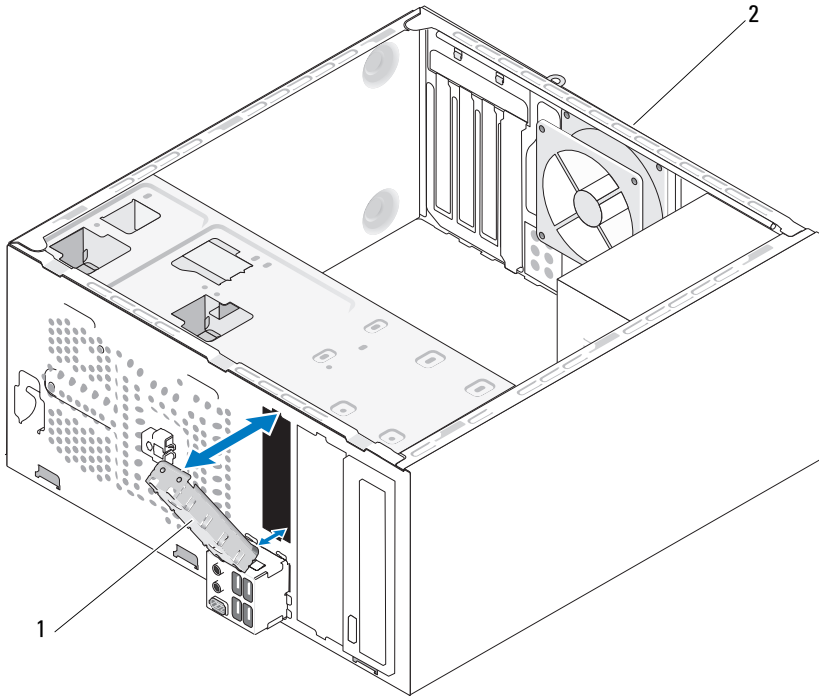

1 drive panel insert (optional) 2 back of the computer

Align the drive panel insert along the edges of the empty slot of the floppy drive and push the panel insert. The drive panel insert is locked in place.

 **NOTE:** To comply with FCC regulations, it is recommended that you replace the drive panel insert whenever the floppy drive is removed from the computer.

## Media Card Reader

**⚠ CAUTION:** Before you begin any of the procedures in this section, follow the safety instructions in the *Product Information Guide*.

**⚠ CAUTION:** To guard against electrical shock, always unplug your computer from the electrical outlet before removing the cover.

### Removing a Media Card Reader

- 1 Follow the procedures in "Before You Begin" on page 105.
- 2 Remove the computer cover (see "Removing the Computer Cover" on page 107).
- 3 Remove the bezel (see "Removing the Bezel" on page 136).

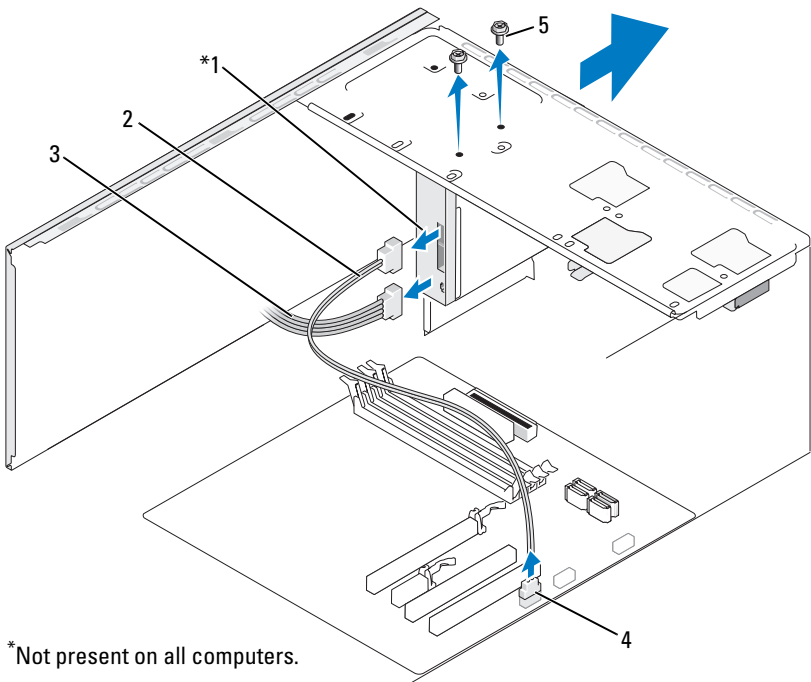

\*Not present on all computers.

- |                          |                     |               |
|--------------------------|---------------------|---------------|
| 1 Media Card Reader      | 2 data cable        | 3 power cable |
| 4 system board connector | 5 custom screws (2) |               |



**NOTE:** The location/connectors may vary depending on your system type. For more information, see "System Board Components" on page 110.

- 4 Disconnect the FlexBay USB cable and the power cable from the back of the Media Card Reader and from the internal USB connector on the system board (see "Inside View of Your Computer" on page 109).
- 5 Remove the two screws securing the Media Card Reader.
- 6 Slide the Media Card Reader out through the front of the computer.
- 7 If you are not reinstalling the Media Card Reader, replace the drive panel insert, as needed.
- 8 Replace the bezel (see "Replacing the Bezel" on page 137).
- 9 Replace the computer cover (see "Replacing the Computer Cover" on page 176).
- 10 Connect your computer and devices to electrical outlets, and then turn them on.

### Installing a Media Card Reader

- 1 Follow the procedures in "Before You Begin" on page 105.
- 2 Remove the computer cover (see "Removing the Computer Cover" on page 107).
- 3 Remove the bezel (see "Removing the Bezel" on page 136).
- 4 If this is a new card reader installation:
  - Remove the drive panel insert (see "Removing the FlexBay Break-Away Metal Plate" on page 149).
  - Remove the Media Card Reader from its packaging.
- 5 Gently slide the Media Card Reader into place in the FlexBay slot.
- 6 Align the screw holes in the Media Card Reader with the screw holes in the FlexBay.
- 7 Tighten the two screws to secure the Media Card Reader.



**NOTE:** Ensure that the Media Card Reader is installed before the FlexBay cable is connected.

- 8 Connect the FlexBay USB cable to the back of the Media Card Reader and to the internal USB connector on the system board (see "Inside View of Your Computer" on page 109).



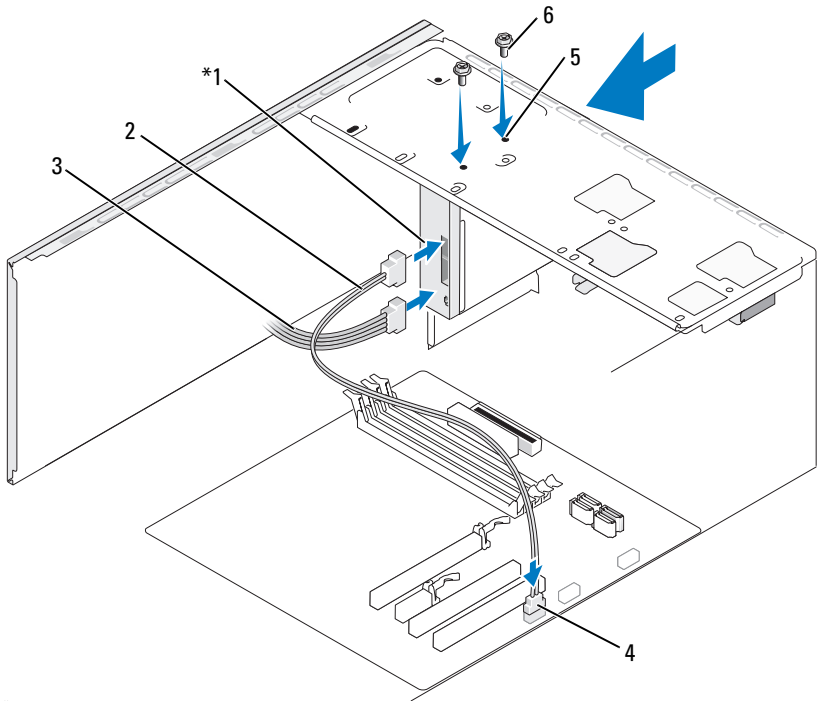

\*Not present on all computers.

- |   |                        |   |                                 |   |                   |
|---|------------------------|---|---------------------------------|---|-------------------|
| 1 | Media Card Reader      | 2 | data cable                      | 3 | power cable       |
| 4 | system board connector | 5 | screw holes in the FlexBay slot | 6 | custom screws (2) |

- 9 Replace the bezel (see "Replacing the Bezel" on page 137).
- 10 Replace the computer cover (see "Replacing the Computer Cover" on page 176).
- 11 Connect your computer and devices to electrical outlets, and then turn them on.

## CD/DVD Drive

**⚠ CAUTION:** Before you begin any of the procedures in this section, follow the safety instructions located in the *Product Information Guide*.

**⚠ CAUTION:** To guard against electrical shock, always unplug your computer from the electrical outlet before removing the cover.

### Removing a CD/DVD Drive

- 1 Follow the procedures in "Before You Begin" on page 105.
- 2 Remove the computer cover (see "Removing the Computer Cover" on page 107).
- 3 Remove the bezel (see "Removing the Bezel" on page 136).
- 4 Disconnect the CD/DVD drive data cable from the system board connector.
- 5 Disconnect the power cable and the CD/DVD drive data cable from the back of the drive.

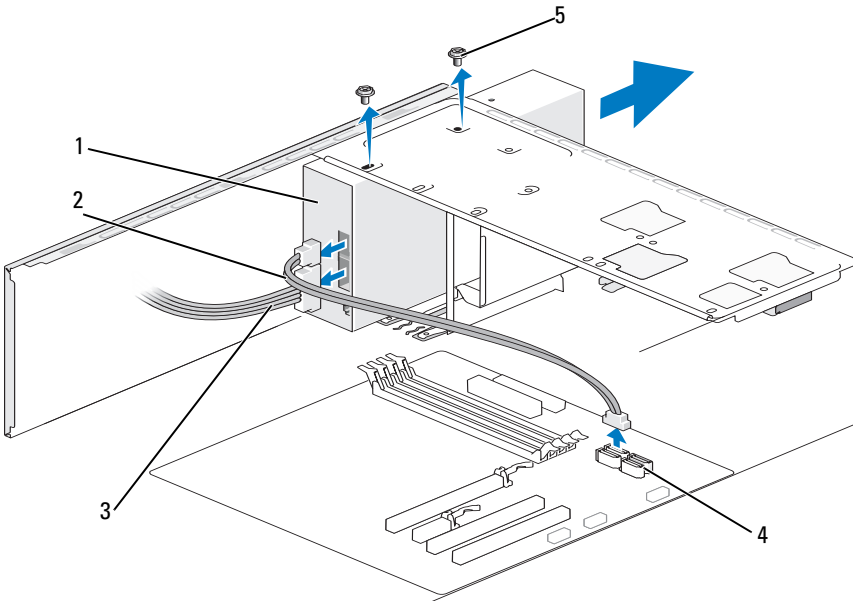

- |                          |                     |               |
|--------------------------|---------------------|---------------|
| 1 CD/DVD drive           | 2 data cable        | 3 power cable |
| 4 system board connector | 5 custom screws (2) |               |

- 6** Remove the two screws securing the CD/DVD drive.
- 7** Slide the CD/DVD drive out through the front of the computer.
- 8** If you are not replacing the drive, replace the drive panel insert (see "Replacing the Drive Panel Insert" on page 150).
- 9** Replace the drive panel (see "Drives" on page 138).
- 10** Replace the bezel (see "Replacing the Bezel" on page 137).
- 11** Replace the computer cover (see "Replacing the Computer Cover" on page 176).
- 12** Connect your computer and devices to electrical outlets, and then turn them on.
- 13** Configure the drives in system setup (see "Entering System Setup" on page 188).

### **Installing a CD/DVD Drive**

- 1** Follow the procedures in "Before You Begin" on page 105.
- 2** Remove the computer cover (see "Removing the Computer Cover" on page 107).
- 3** Remove the bezel (see "Removing the Bezel" on page 136).
- 4** Gently slide the drive into place.
- 5** Align the screw holes in the CD/DVD drive with the screw holes in the CD/DVD drive bay.
- 6** Replace and tighten the two screws securing the CD/DVD drive.
- 7** Connect the power and data cables to the drive.
- 8** Connect the data cable to the system board connector on the system board.

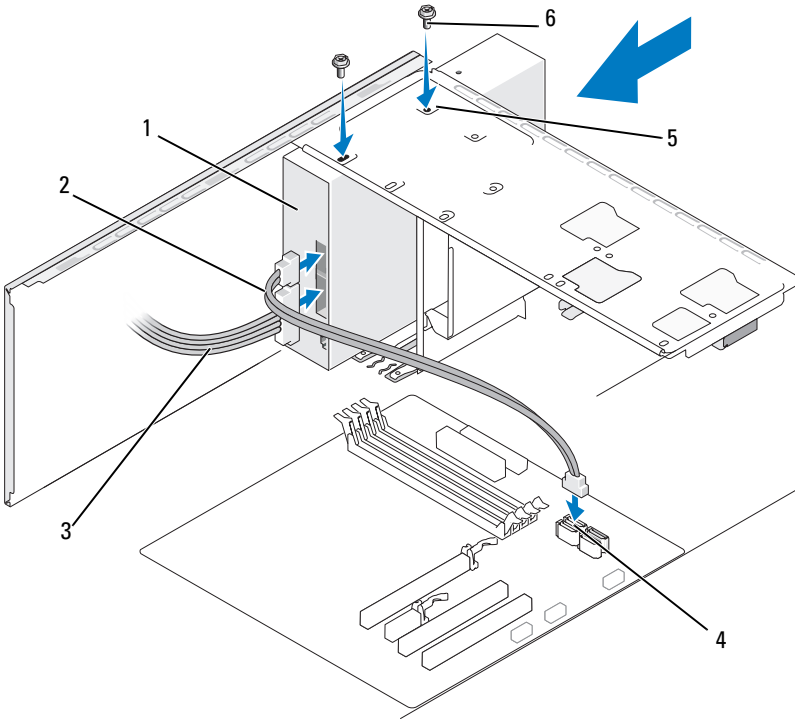

- |   |                        |   |                                     |   |                   |
|---|------------------------|---|-------------------------------------|---|-------------------|
| 1 | CD/DVD drive           | 2 | data cable                          | 3 | power cable       |
| 4 | system board connector | 5 | screw holes in the CD/DVD drive bay | 6 | custom screws (2) |

**NOTE:** The location/connectors may vary depending on your system type. For more information, see "System Board Components" on page 110.

**9** Replace the bezel (see "Replacing the Bezel" on page 137).

**10** Replace the computer cover (see "Replacing the Computer Cover" on page 176).

**NOTICE:** To connect a network cable, first plug the cable into the network device and then plug it into the computer.

- 11** Connect your computer and devices to their electrical outlets, and turn them on.  
See the documentation that came with the drive for instructions on installing any software required for drive operation.
- 12** Enter system setup (see "System Setup" on page 187) and select the appropriate **Drive** option.
- 13** Verify that your computer works correctly by running the Dell Diagnostics (see "Dell Diagnostics" on page 90).

### Installing a Second CD/DVD Drive

- 1** Follow the procedures in "Before You Begin" on page 105.
- 2** Remove the computer cover (see "Removing the Computer Cover" on page 107).
- 3** Remove the bezel (see "Removing the Bezel" on page 136).

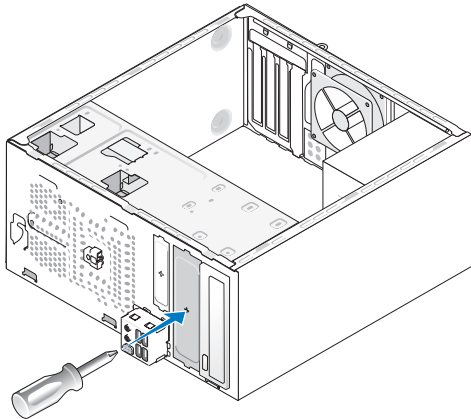

- 4** Align the tip of a Phillips screwdriver with the slot on the break-away metal plate and rotate the screwdriver outwards to break the metal plate.
- 5** Gently slide the drive into place.
- 6** Align the screw holes in the CD/DVD drive with the screw holes in the CD/DVD drive bay.
- 7** Replace and tighten the two screws securing the CD/DVD drive.
- 8** Connect the power and data cables to the drive.

- 9** Connect the data cable to the system board connector on the system board.

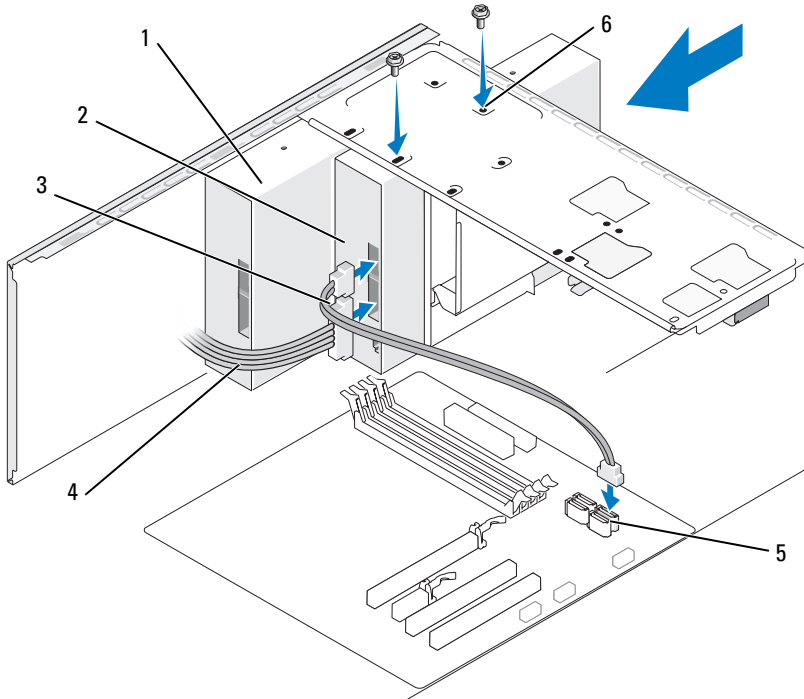

- |   |              |   |                        |   |                                     |
|---|--------------|---|------------------------|---|-------------------------------------|
| 1 | CD/DVD drive | 2 | second CD/DVD drive    | 3 | data cable                          |
| 4 | power cable  | 5 | system board connector | 6 | screw holes in the CD/DVD drive bay |

- 10** Check all cable connections, and fold cables out of the way to avoid blocking airflow between the fan and cooling vents.
- 11** Replace and tighten the two screws securing the CD/DVD drive.
- 12** Replace the bezel (see "Replacing the Bezel" on page 137).
- 13** Replace the computer cover (see "Replacing the Computer Cover" on page 176).

**➔ NOTICE:** To connect a network cable, first plug the cable into the network device and then plug it into the computer.

**14** Connect your computer and devices to their electrical outlets, and turn them on.

See the documentation that came with the drive for instructions on installing any software required for drive operation.

**15** Enter system setup (see "System Setup" on page 187) and select the appropriate **Drive** option.

**16** Verify that your computer works correctly by running the Dell Diagnostics (see "Dell Diagnostics" on page 90).

### Replacing the CD/DVD Panel Insert

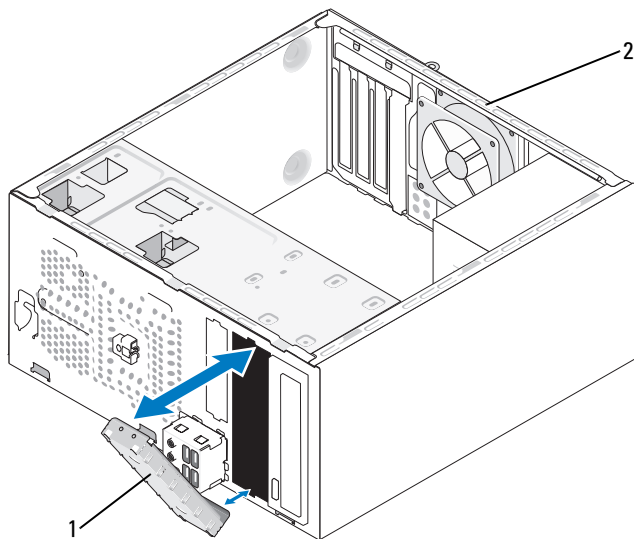

1 CD/DVD panel insert (optional)    2 back of the computer

Align the CD/DVD panel insert along the edges of the empty slot for CD/DVD and push. CD/DVD panel insert is locked in place.

**🔧 NOTE:** To comply with FCC regulations, it is recommended that you replace the CD/DVD panel insert whenever the CD/DVD is removed from the computer.

# Battery

## Replacing the Battery

 **CAUTION:** Before you begin any of the procedures in this section, follow the safety instructions in the *Product Information Guide*.

 **NOTICE:** To prevent static damage to components inside your computer, discharge static electricity from your body before you touch any of your computer's electronic components. You can do so by touching an unpainted metal surface on the computer chassis.

A coin-cell battery maintains computer configuration, date, and time information. The battery can last several years. If you have to repeatedly reset time and date information after turning on the computer, replace the battery.

 **CAUTION:** A new battery can explode if it is incorrectly installed. Replace the battery only with the same or equivalent type recommended by the manufacturer. Discard used batteries according to the manufacturer's instructions.

To replace the battery:

- 1 Record all the screens in system setup (see "System Setup" on page 187) so that you can restore the correct settings in Step 9.
- 2 Follow the procedures in "Before You Begin" on page 105.
- 3 Remove the computer cover (see "Removing the Computer Cover" on page 107).
- 4 Locate the battery socket (see "Inside View of Your Computer" on page 109).
- 5 Carefully press the battery release lever away from the battery and the battery will pop out.



- 6 Insert the new battery into the socket with the side labeled "+" facing up, then snap the battery into place.

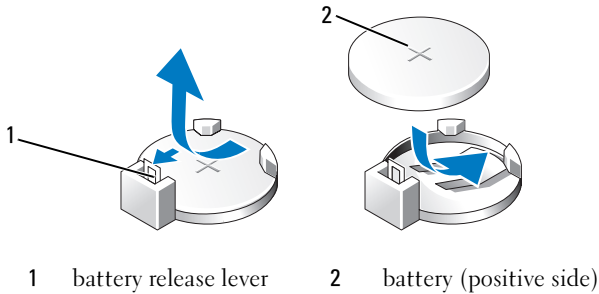

- 7 Replace the computer cover (see "Replacing the Computer Cover" on page 176).

➡ **NOTICE:** To connect a network cable, first plug the cable into the network device and then plug it into the computer.

- 8 Connect your computer and devices to electrical outlets, and then turn them on.

- 9 Enter system setup (see "System Setup" on page 187) and restore the settings you recorded in Step 1. Then go to the **Maintenance** section and clear the low battery and other errors associated with the battery replacement in the **Event Log**.

- 10 Properly dispose of the old battery.

See the *Product Information Guide* for battery disposal information.

## Power Supply

⚠ **CAUTION:** Before you begin any of the procedures in this section, follow the safety instructions located in the *Product Information Guide*.

➡ **NOTICE:** To prevent static damage to components inside your computer, discharge static electricity from your body before you touch any of your computer's electronic components. You can do so by touching an unpainted metal surface on the computer chassis.

## Replacing the Power Supply

- 1 Follow the procedures in "Before You Begin" on page 105.
- 2 Remove the computer cover (see "Removing the Computer Cover" on page 107).
- 3 Disconnect the DC power cables from the system board and the drives.  
Note the routing of the DC power cables underneath the tabs in the computer chassis as you remove them from the system board and drives. You must route these cables properly when you replace them to prevent them from being pinched or crimped.
- 4 Remove the hard drive cable, CD/DVD drive data cable, front panel ribbon cable, and any other cables from the securing clip on the side of the power supply.
- 5 Remove the four screws that attach the power supply to the back of the computer chassis.

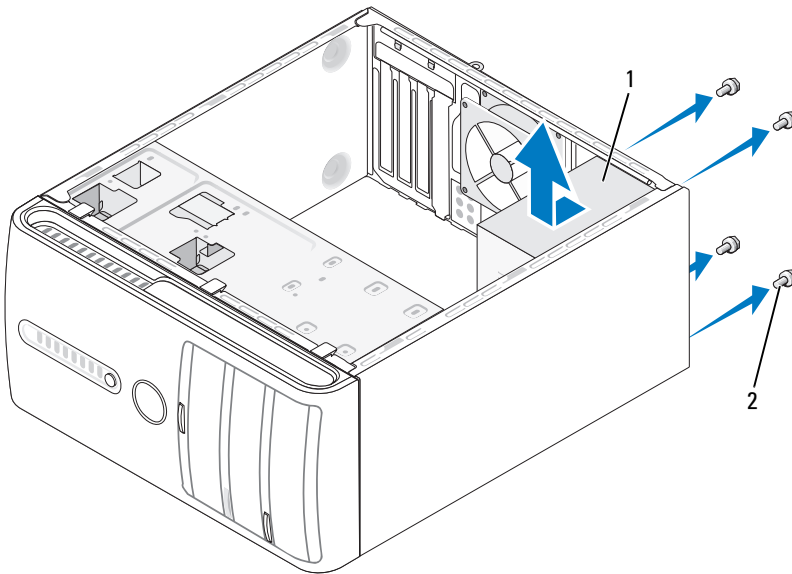

1 power supply

2 screws (4)

- 6 Slide out the power supply and lift it out.
- 7 Slide the replacement power supply towards the back of the computer.
- 8 Replace and tighten all screws that secure the power supply to the back of the computer chassis.

 **CAUTION:** Failure to replace and tighten all screws may cause electrical shock as these screws are a key part of the system grounding.

 **NOTICE:** Route the DC power cables under the chassis tabs. The cables must be properly routed to prevent the cables from being damaged.

- 9 Reconnect the DC power cables to the system board and drives.

- 10 Secure the hard drive cable, CD/DVD drive data cable, and the front panel ribbon cable to the securing clip on the side of the power supply.

 **NOTE:** Double-check all cable connections to make sure they are secure.

- 11 Replace the computer cover (see "Replacing the Computer Cover" on page 176).

- 12 Connect your computer and devices to an electrical outlet, and turn them on.

- 13 Verify that the computer works correctly by running the Dell Diagnostics (see "Dell Diagnostics" on page 90).

## I/O Panel

 **CAUTION:** Before you begin any of the procedures in this section, follow the safety instructions in the *Product Information Guide*.

 **CAUTION:** To guard against likelihood of electric shock, laceration by moving fan blades or other unexpected injuries, always unplug your computer from the electrical outlet before opening the cover.

 **CAUTION:** The heat sink assembly, power supply, and other components may be very hot during normal operation. Be sure that they have had sufficient time to cool before you touch them.

 **NOTICE:** To prevent static damage to components inside your computer, discharge static electricity from your body before you touch any of your computer's electronic components. You can do so by touching an unpainted metal surface on the computer chassis.

## Removing the I/O Panel

**NOTE:** Note the routing of all cables as you remove them so that you can re-route them correctly when installing the new I/O panel.

- 1 Follow the procedures in "Before You Begin" on page 105.
- 2 Remove the computer cover (see "Removing the Computer Cover" on page 107).
- 3 Remove the bezel (see "Removing the Bezel" on page 136).

**NOTICE:** When sliding the I/O panel out of the computer, be extremely careful. Carelessness may result in damage to the cable connectors and the cable routing clips.

- 4 Disconnect all the cables that are connected to the I/O panel from the system board.
- 5 Remove the screw that secures the I/O panel.
- 6 Carefully remove the I/O panel from the computer.

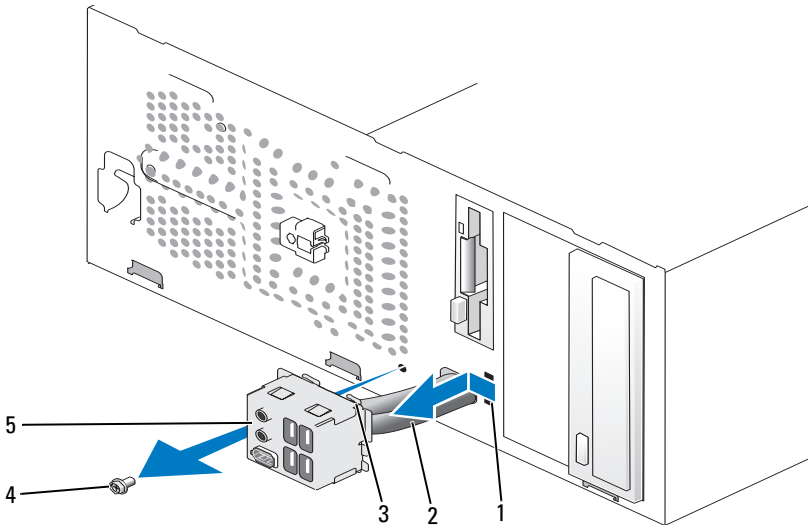

- |                        |          |
|------------------------|----------|
| 1 I/O panel clamp slot | 2 cables |
| 3 I/O panel clamp      | 4 screw  |
| 5 I/O panel            |          |

## Installing the I/O Panel

1 Place the I/O panel into the slot.



**NOTICE:** Take care not to damage the cable connectors and the cable routing clips when sliding the I/O panel into the computer.

2 Align and slide the I/O panel clamp into the I/O panel clamp slot.

3 Replace and tighten the screw that secures the I/O panel.

4 Reconnect the cables to the system board.

5 Replace the bezel (see "Replacing the Bezel" on page 137).

6 Replace the computer cover (see "Replacing the Computer Cover" on page 176).

7 Connect your computer and devices to an electrical outlet, and turn them on.

8 Verify that the computer works correctly by running the Dell Diagnostics (see "Dell Diagnostics" on page 90).

## Processor Fan



**CAUTION:** Before you begin any of the procedures in this section, follow the safety instructions in the *Product Information Guide*.



**CAUTION:** To guard against likelihood of electric shock, laceration by moving fan blades or other unexpected injuries, always unplug your computer from the electrical outlet before opening the cover.



**CAUTION:** The heat sink assembly, power supply, and other components may be very hot during normal operation. Be sure that they have had sufficient time to cool before you touch them.



**NOTICE:** To prevent static damage to components inside your computer, discharge static electricity from your body before you touch any of your computer's electronic components. You can do so by touching an unpainted metal surface on the computer chassis.



**NOTE:** The processor fan with the heatsink is one single unit. Do not try to remove the fan separately.

## Removing the Processor Fan/Heat Sink Assembly

- ➔ NOTICE:** Do not touch the fan blades when you are removing the processor fan/heat sink assembly. This could damage the fan.
- 1 Follow the procedures in "Before You Begin" on page 105.
  - 2 Remove the computer cover (see "Removing the Computer Cover" on page 107).
  - 3 Disconnect the processor fan cable from the system board (see "Inside View of Your Computer" on page 109).
  - 4 Carefully move away any cables that are routed over the processor fan/heat sink assembly.
  - 5 Loosen the four captive screws securing the processor fan/heat sink assembly and lift it straight up.

**⚠ CAUTION:** Despite having a plastic shield, the heat sink fan assembly may be very hot during normal operation. Be sure that it has had sufficient time to cool before you touch it.

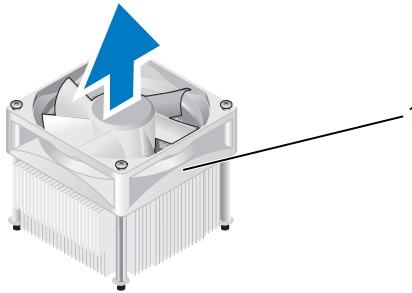

1 processor fan/heat sink assembly

**🔗 NOTE:** The processor fan/heat sink assembly in your computer may not look exactly like the one shown in the illustration above.

## Installing the Processor Fan/Heat Sink Assembly

➡ **NOTICE:** When reinstalling the fan, ensure that you do not pinch the wires that run between the system board and the fan.

- 1 Align the captive screws on the processor fan/heat sink assembly to the four metal screw hole projections on the system board.

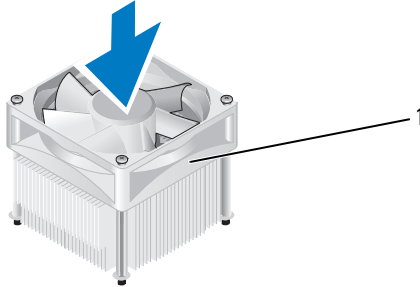

1 processor fan/heat sink assembly

✎ **NOTE:** The processor fan/heat sink assembly in your computer may not look exactly like the one shown in the illustration above.

- 2 Tighten the four captive screws.

✎ **NOTE:** Ensure that the processor fan/heat sink assembly is correctly seated and secure.

- 3 Connect the processor fan/heat sink assembly cable to the CPU\_FAN system board connector (see "Inside View of Your Computer" on page 109).
- 4 Replace the computer cover (see "Replacing the Computer Cover" on page 176).
- 5 Connect your computer and devices to an electrical outlet, and turn them on.

# Processor

 **CAUTION:** Before you begin any of the procedures in this section, follow the safety instructions located in the *Product Information Guide*.

## Removing the Processor

- 1 Follow the procedures in "Before You Begin" on page 105.
- 2 Remove the computer cover (see "Removing the Computer Cover" on page 107).

 **CAUTION:** Despite having a plastic shield, the heat sink assembly may be very hot during normal operation. Be sure that it has had sufficient time to cool before you touch it.

- 3 Remove the processor fan/heat sink assembly from the computer (see "Removing the Processor Fan/Heat Sink Assembly" on page 166).

 **NOTICE:** Unless a new heatsink is required for the new processor, reuse the original heat sink assembly when you replace the processor.



- 4 At the processor, place your finger upon the hook end of the release lever, then push down and out to release it from the tab that secures it.

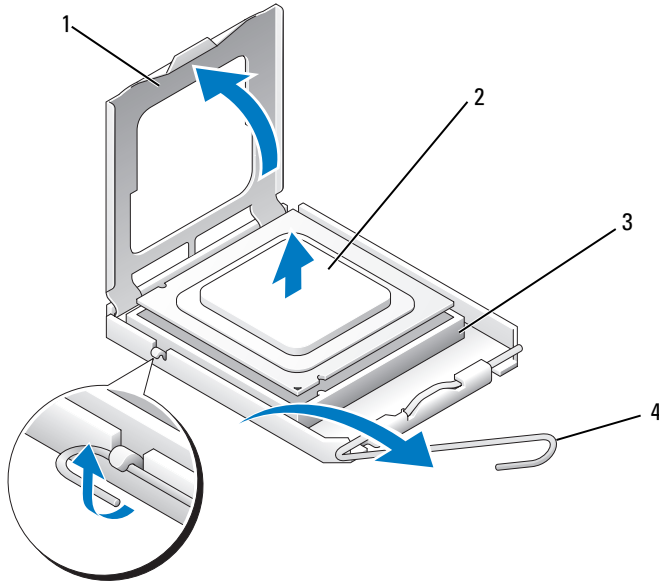

- |   |                 |   |               |
|---|-----------------|---|---------------|
| 1 | processor cover | 2 | processor     |
| 3 | socket          | 4 | release lever |

**➡ NOTICE:** When replacing the processor, do not touch any of the pins inside the socket or allow any objects to fall on the pins in the socket.

- 5 Gently remove the processor from the socket.

Leave the release lever extended in the release position so that the socket is ready for the new processor.

## Installing the Processor

- ➔ **NOTICE:** Ground yourself by touching an unpainted metal surface on the back of the computer.
- ➔ **NOTICE:** When replacing the processor, do not touch any of the pins inside the socket or allow any objects to fall on the pins in the socket.
  - 1 Follow the procedures in "Before You Begin" on page 105.
  - 2 Unpack the new processor, being careful not to touch the underside of the processor.
- ➔ **NOTICE:** You must position the processor correctly in the socket to avoid permanent damage to the processor and the computer when you turn on the computer.
  - 3 If the release lever on the socket is not fully extended, move it to that position.
  - 4 Orient the front and rear alignment-notches on the processor with the front and rear alignment-notches on the socket.
  - 5 Align the pin-1 corners of the processor and socket.
- ➔ **NOTICE:** To avoid damage, ensure that the processor aligns properly with the socket, and do not use excessive force when you install the processor.
  - 6 Set the processor lightly in the socket and ensure that the processor is positioned correctly.
  - 7 When the processor is fully seated in the socket, close the processor cover. Ensure that the tab on the processor cover is positioned underneath the center cover latch on the socket.
  - 8 Pivot the socket release lever back toward the socket, and snap it into place to secure the processor.

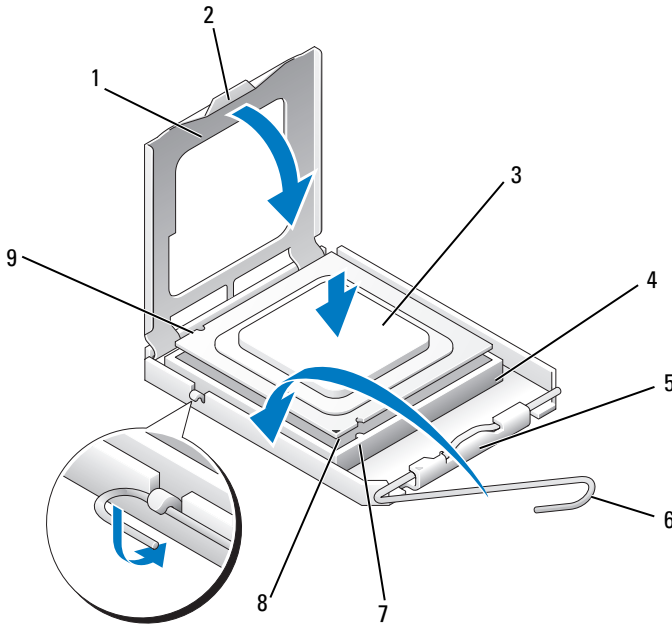

- |                         |                             |                        |
|-------------------------|-----------------------------|------------------------|
| 1 processor cover       | 2 tab                       | 3 processor            |
| 4 processor socket      | 5 center cover latch        | 6 release lever        |
| 7 front alignment-notch | 8 processor pin-1 indicator | 9 rear alignment notch |

9 Clean the thermal grease from the bottom of the heat sink.

➔ **NOTICE:** Ensure that you apply new thermal grease. New thermal grease is critical for ensuring adequate thermal bonding, which is a requirement for optimal processor operation.





10 Apply the new thermal grease to the top of the processor.

11 Install the processor fan/heat sink assembly (see "Installing the Processor Fan/Heat Sink Assembly" on page 167).

➔ **NOTICE:** Ensure that the processor fan/heat sink assembly is correctly seated and secure.

12 Replace the computer cover (see "Replacing the Computer Cover" on page 176).

# Chassis Fan

-  **CAUTION:** Before you begin any of the procedures in this section, follow the safety instructions in the *Product Information Guide*.
-  **CAUTION:** To guard against likelihood of electric shock, laceration by moving fan blades or other unexpected injuries, always unplug your computer from the electrical outlet before opening the cover.
-  **CAUTION:** The heat sink assembly, power supply, and other components may be very hot during normal operation. Be sure that they have had sufficient time to cool before you touch them.
-  **NOTICE:** To prevent static damage to components inside your computer, discharge static electricity from your body before you touch any of your computer's electronic components. You can do so by touching an unpainted metal surface on the computer chassis.

## Removing the Chassis Fan

-  **NOTICE:** Do not touch the fan blades when you are removing the chassis fan. This could damage the fan.
- 1 Follow the procedures in "Before You Begin" on page 105.

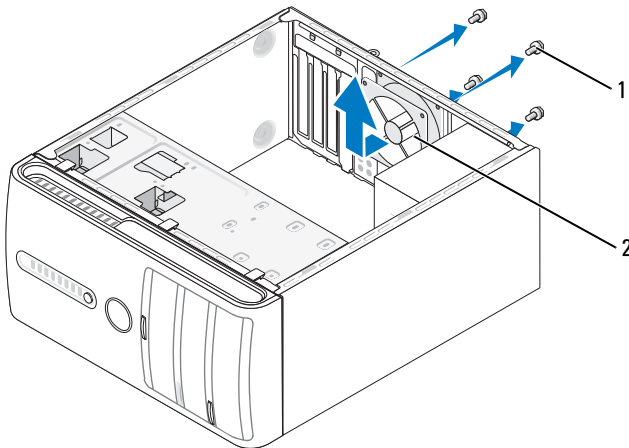

1 screws (4)      2 chassis fan

- 2 Remove the computer cover (see "Removing the Computer Cover" on page 107).
- 3 Remove the four screws securing the chassis fan.
- 4 Slide the chassis fan towards the front of the computer and lift it up.

## Replacing the Chassis Fan

- 1 Follow the procedures in "Before You Begin" on page 105.

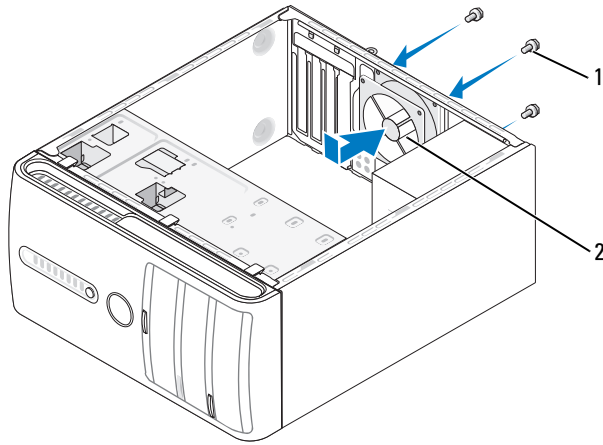



1 screws (4)      2 chassis fan

- 2 Remove the computer cover (see "Removing the Computer Cover" on page 107).
- 3 Slide the chassis fan in place towards the back of the computer.
- 4 Tighten the four screws to secure the chassis fan.

# System Board

## Removing the System Board

 **CAUTION:** To guard against likelihood of electric shock, laceration by moving fan blades or other unexpected injuries, always unplug your computer from the electrical outlet before opening the cover.

 **CAUTION:** The heat sink assembly, power supply, and other components may be very hot during normal operation. Be sure that they have had sufficient time to cool before you touch them.

 **NOTICE:** Before touching anything inside your computer, ground yourself by touching an unpainted metal surface, such as the metal at the back of the computer. While you work, periodically touch an unpainted metal surface to dissipate any static electricity that could harm internal components.

- 1 Follow the procedures in "Before You Begin" on page 105.
- 2 Remove the computer cover (see "Removing the Computer Cover" on page 107).
- 3 Remove any add-in cards on the system board (see "Cards" on page 129).
- 4 Remove the processor and heat sink assembly (see "I/O Panel" on page 163).
- 5 Remove the memory modules (see "Removing Memory" on page 128) and document which memory module is removed from each memory socket so that the memory modules can be installed in the same location after the board is replaced.
- 6 Disconnect all cables from the system board. Note the routing of all cables as you remove them so that you can re-route them correctly after installing the new system board.
- 7 Remove the eight screws from the system board.
- 8 Lift the system board up and out.

## System Board Screws

### *Inspiron 530/530a/530c*

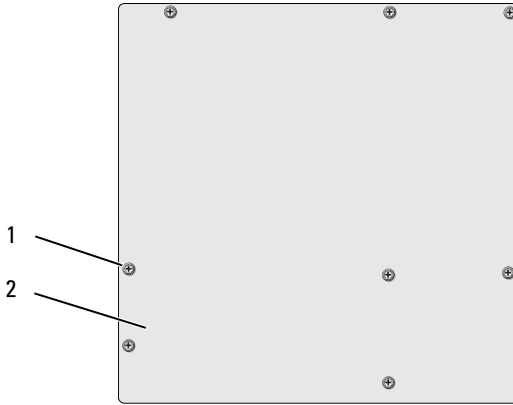

1 screws (8) 2 system board

### *Inspiron 530b/530d*

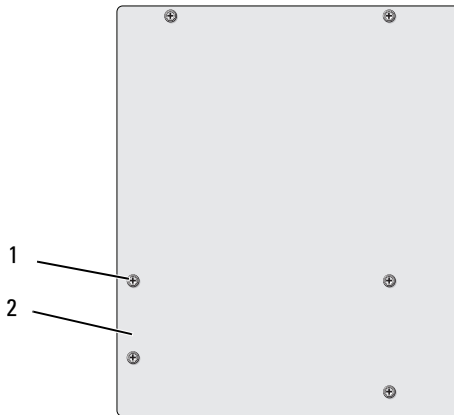

1 screws (6) 2 system board

Place the system board assembly that you just removed next to the replacement system board to compare and ensure they are identical.

## Installing the System Board

- 1 Gently align the board into the chassis and slide it toward the back of the computer.
  - 2 Using the screws, secure the system board to the chassis.
  - 3 Replace the cables that you removed from the system board.
  - 4 Replace the processor and the heat sink assembly (see "Installing the Processor" on page 170).
-  **NOTICE:** Ensure that the heat sink assembly is correctly seated and secure.
- 5 Replace the memory modules into the memory sockets at the same locations from which you removed them (see "Installing Memory" on page 126).
  - 6 Replace any add-in cards on the system board.
  - 7 Replace the computer cover (see "Replacing the Computer Cover" on page 176).
  - 8 Connect your computer and devices to an electrical outlet, and turn them on.
  - 9 Verify that the computer works correctly by running the Dell Diagnostics (see "Dell Diagnostics" on page 90).

## Replacing the Computer Cover

 **CAUTION:** Before you begin any of the procedures in this section, follow the safety instructions located in the *Product Information Guide*.

 **CAUTION:** Do not operate your equipment with any cover(s) (including computer covers, bezels, filler brackets, front-panel inserts, etc.) removed.

- 1 Ensure that all cables are connected, and fold cables out of the way.
- 2 Ensure that no tools or extra parts are left inside the computer.
- 3 Align the tabs at the bottom of the computer cover with the slots located along the edge of the computer.
- 4 Press the computer cover down and slide it towards the front of the computer until you feel a click or feel the computer cover securely installed.
- 5 Ensure that the cover is seated correctly.



- 6 Replace and tighten the two screws that secure the computer cover, using a screwdriver.

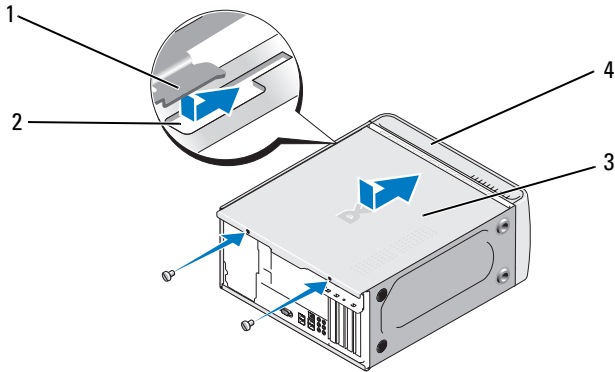

- |   |                    |   |                       |
|---|--------------------|---|-----------------------|
| 1 | computer cover tab | 2 | slot                  |
| 3 | computer cover     | 4 | front of the computer |

- 7 Move the computer to the upright position.

- ➡ **NOTICE:** To connect a network cable, first plug the cable into the network device and then plug it into the computer.
- ➡ **NOTICE:** Ensure that none of the system air-vents are blocked. Blocking them would cause serious thermal problems.



# Appendix

## Specifications

### Inspiron 530/530a/530c

<b>Processor</b>	
Processor type	Intel® Core™ 2 Quad processor Intel® Core™ 2 Duo processor Intel® Pentium® Dual-Core processor Intel® Celeron® processor
Level 2 (L2) cache	At least 512 KB pipelined-burst, eight-way set associative, writeback SRAM
<b>Memory</b>	
Type	DDR2 SDRAM(667/800-MHz)
Memory connectors	four
Memory capacities	512 MB, 1 GB or 2 GB
Minimum memory	512 MB
Maximum memory	4 GB (Inspiron 530 only ) 8 GB(Inspiron 530a/530c)
<b>Computer Information</b>	
Chipset	G33/ICH9
RAID Support	RAID 1 support (on-board)
DMA channels	seven
Interrupt levels	24
BIOS chip (NVRAM)	16 Mb (Inspiron 530 only) 8Mb (Inspiron 530a/530c)
NIC	Integrated network interface capable of 10/100 communication

<b>Video</b>	
Type	Intel integrated video
<b>Audio</b>	
Type	Realtek ALC888 (7.1 Channel audio)
<b>Expansion Bus</b>	
Bus type	PCI 2.3 PCI Express 1.0A SATA 1.0 and 2.0 USB 2.0
Bus speed	PCI: 133 MB/s PCI Express: x1 slot bidirectional speed - 500 MB/s x16 slot bidirectional speed - 8GB/s SATA: 1.5 Gbps and 3.0 Gbps USB: 480 Mbps high speed, 12 Mbps full speed, 1.2 Mbps low speed
PCI	
connectors	two
connector size	124 pins
connector data width (maximum)	32 bits
PCI Express	
connector	one x1
connector size	36 pins
connector data width (maximum)	1 PCI Express lane
PCI Express	
connector	one x16
connector size	164 pins
connector data width (maximum)	16 PCI Express lanes

---

## Drives

---

Externally accessible:	one 3.5-inch drive bay (FlexBay) two 5.25-inch drive bays
Internally accessible	two 3.5-inch drive bays
Available devices	two 3.5-inch Serial ATA hard drives and two 5.25-inch Serial ATA CD-ROM, CD-RW, DVD-ROM, DVD-RW, or combo drive (optional) one 3.5-inch floppy drive (optional) or Media Card Reader (optional)

**NOTE:** Floppy drive is supported only on Inspiron 530.

---

## Connectors

---

### External connectors:

Video	15-hole connector
Network adapter	RJ-45 connector
USB	two front-panel and four back-panel USB 2.0-compliant connectors
Audio	six connectors for 7.1 support

### System board connectors:

Serial ATA	four 7-pin connectors
Internal USB device	two 9-pin connector (supports one flexbay device)
Floppy drive	one 34-pin connector
Processor fan	one 4-pin connector
Chassis fan	one 3-pin connector
PCI 2.3	two 124-pin connectors
PCI Express x1	one 36-pin connector
PCI Express x16	one 164-pin connector
Front panel control	one 9-pin connector
Front panel USB	one 9-pin connector (one connector supports two USB ports)

---

**Connectors (continued)**

---

Front panel audio HDA header	one 9-pin connector
Processor	one 775-pin connector
Memory	four 240-pin connectors
Power 12V	one 4-pin connector
Power	one 24-pin connector

**Inspiron 530b/530d**

---

**Processor**

---

Processor type	Intel <sup>®</sup> Core™ 2 Duo processor Intel <sup>®</sup> Pentium <sup>®</sup> Dual-Core processor Intel <sup>®</sup> Celeron <sup>®</sup> processor
Level 2 (L2) cache	At least 512 KB pipelined-burst, eight-way set associative, writeback SRAM

---

**Memory**

---

Type	DDR2 SDRAM(667/800-MHz)
Memory connectors	two
Memory capacities	512 MB, 1 GB, 2 GB
Minimum memory	512 MB
Maximum memory	4 GB

---

**Computer Information**

---

Chipset	G31/ICH7
RAID Support	NO RAID
DMA channels	seven
Interrupt levels	24
BIOS chip (NVRAM)	8 Mb
NIC	Integrated network interface capable of 10/100 communication

<b>Video</b>	
Type	Intel integrated video
<b>Audio</b>	
Type	Realtek ALC662 (5.1- Channel audio)
<b>Expansion Bus</b>	
Bus type	PCI 2.3 PCI Express 1.0A SATA 1.0 and 2.0 USB 2.0
Bus speed	PCI: 133 MB/s PCI Express: x1 slot bidirectional speed - 500 MB/s x16 slot bidirectional speed - 8GB/s SATA: 1.5 Gbps and 3.0 Gbps USB: 480 Mbps high speed, 12 Mbps full speed, 1.2 Mbps low speed
PCI	
connectors	two
connector size	124 pins
connector data width (maximum)	32 bits
PCI Express	
connector	one x1
connector size	36 pins
connector data width (maximum)	1 PCI Express lane
PCI Express	
connector	one x16
connector size	164 pins
connector data width (maximum)	16 PCI Express lanes

---

**Drives**

---

Externally accessible:	one 5.25-inch drive bays
Internally accessible	one 3.5-inch drive bays
Available devices	one 3.5-inch Serial ATA hard drives and one 5.25-inch Serial ATA CD-ROM, CD-RW, DVD-ROM, DVD-RW, or combo drive (optional) one Media Card Reader (optional)

---

**Connectors**

---

## External connectors:

Video	15-hole connector
Network adapter	RJ-45 connector
USB	two front-panel and four back-panel USB 2.0-compliant connectors
Audio	three connectors for 5.1 support

## System board connectors:

Serial ATA	two 7-pin connectors
Internal USB device	one 9-pin connector (supports one flexbay device)
Floppy drive	NIL
Processor fan	one 4-pin connector
Chassis fan	one 3-pin connector
PCI 2.3	two 124-pin connectors
PCI Express x1	one 36-pin connector
PCI Express x16	one 164-pin connector
Front panel control	one 9-pin connector
Front panel USB	one 9-pin connector (one connector supports two USB ports)
Front panel audio HDA header	one 9-pin connector
Processor	one 775-pin connector



---

**Connectors (continued)**

---

Memory	four 240-pin connectors
Power 12V	one 4-pin connector
Power	one 24-pin connector

**Inspiron 530/530a/530b/530c/530d**

---

**Controls and Lights**

---

Front of computer:

Power button	push button
Power light	blue light — Blinking blue in sleep state; solid blue for power-on state  amber light — The blinking amber indicates a problem with the system board. A solid amber light when the system does not boot indicates that the system board cannot start initialization. This could be a system board or a power supply problem (see "Power Problems" on page 77).
Drive activity light	blue light — A blinking blue light indicates the computer is reading data from or writing data to the SATA hard drive or CD/DVD.

Back of computer:

Link integrity light (on integrated network adapter)	green light — A good connection exists between the network and the computer.  off (no light) — The computer is not detecting a physical connection to the network.
Network activity light (on integrated network adapter)	yellow blinking light — A good connection exists between the network and the computer.

---

**Power**

---

DC power supply:

Wattage	300 W 350 W (for computers with Intel® Core™ 2 Quad processor)
Maximum heat dissipation	162 W 188 W (for computers with Intel® Core™ 2 Quad processor) <b>NOTE:</b> Heat dissipation is calculated by using the power supply wattage rating.
Voltage (see the safety instructions located in the <i>Product Information Guide</i> for important voltage setting information)	115/230 Vac, 50/60 Hz, 7A/4A 90~135 Vac / 180~265 Vac, 50/60 Hz, 7A/4A (Japan only)

Coin cell battery 3-V CR2032 lithium coin cell

---

**Physical**

---

Height	36.2 cm (14.2 inches)
Width	17.0 cm (6.7 inches)
Depth	43.5 cm (17.1 inches)
Weight	12.7 kg (28.0 lb)

---

**Environmental**

---

Temperature:

Operating	10° to 35°C (50° to 95°F)
Storage	-40° to 65°C (-40° to 149°F)

Relative humidity 20% to 80% (noncondensing)

---

**Environmental (continued)**

---

Maximum  
vibration:

Operating	5 to 350 Hz at 0.0002 G <sup>2</sup> /Hz
Storage	5 to 500 Hz at 0.001 to 0.01 G <sup>2</sup> /Hz

Maximum shock:

Operating	40 G +/- 5% with pulse duration of 2 msec +/- 10% (equivalent to 20 in/sec [51 cm/sec])
Storage	105 G +/- 5% with pulse duration of 2 msec +/- 10% (equivalent to 50 in/sec [127 cm/sec])

Altitude:

Operating	-15.2 to 3048 m (-50 to 10,000 ft)
Storage	-15.2 to 10,668 m (-50 to 35,000 ft)

Airborne  
contaminant level G2 or lower as defined by ISA-S71.04-1985

## System Setup

### Overview

Use system setup as follows:

- To change the system configuration information after you add, change, or remove any hardware in your computer
- To set or change a user-selectable option such as the user password
- To read the current amount of memory or set the type of hard drive installed

Before you use system setup, it is recommended that you write down the system setup screen information for future reference.

 **NOTICE:** Unless you are an expert computer user, do not change the settings for this program. Certain changes can make your computer work incorrectly.

## Entering System Setup

- 1 Turn on (or restart) your computer.
- 2 When the blue DELL™ logo is displayed, you must watch for the F2 prompt to appear.
- 3 Once this F2 prompt appears, press <F2> immediately.



**NOTE:** The F2 prompt indicates that the keyboard has initialized. This prompt can appear very quickly, so you must watch for it to display, and then press <F2>. If you press <F2> before you are prompted, this keystroke will be lost.

- 4 If you wait too long and the operating system logo appears, continue to wait until you see the Microsoft® Windows® desktop. Then, shut down your computer (see "Turning Off Your Computer" on page 106) and try again.

## System Setup Screens

The system setup screen displays current or changeable configuration information for your computer. Information on the screen is divided into three areas: the options list, active options field, and key functions.

System Info		Item Help
<b>Options List</b> — This field appears on the left side of the system setup window. The field is a scrolled list containing features that define the configuration of your computer, including installed hardware, power conservation, and security features.	<b>Option Field</b> — Scroll up and down the list with the up- and down-arrow keys. As an option is highlighted, the Option Field displays more information about that option and the option's current and available settings.	This field contains information about each option. In this field you can view your current settings and make changes to your settings.  Use the right and left arrow keys to highlight an option. Press <Enter> to make that selection active.
<b>Key Functions</b> — This field appears at the bottom of the screen. This lists keys and their functions within the active system setup field.		

## System Setup Options



**NOTE:** Depending on your computer and installed devices, the items listed in this section may not appear, or may not appear exactly as listed.

---

<b>System Info</b>	
BIOS Info	Shows the BIOS version number and date information.
Service Tag	Shows the service tag of the computer.
CPU Info	Identifies whether the computer's processor supports Hyper-Threading and lists the processor bus speed, processor ID, clock speed, and L2 cache.
Memory Info	Indicates amount of installed memory, memory speed, channel mode (dual or single), and type of memory installed.

---

<b>Standard CMOS Features</b>	
Date/Time	Displays current date and time settings. Date (mm:dd:yy)
SATA Info	Displays the SATA drives integrated in the system (SATA-0; SATA-1; SATA-2; SATA-3; SATA-4; SATA-5)
SATA HDD Auto-Detection	Auto detects the SATA connector to which the hard drive is attached.
Capacity	The combined installed capacity of all the SATA devices.
Drive A	None; 1.44M, 3.5 in (1.44M, 3.5 inches by default)
Halt On	All Error; All, But Keyboard (All, But Keyboard by default)

---

<b>Advanced BIOS Features</b>	
CPU Feature	<ul style="list-style-type: none"><li>• Limit CPUID Value—Enabled; Disabled (Disabled by default)</li><li>• Execute Disable Bit—Enabled; Disabled (Enabled by default)</li><li>• Virtualization Technology—Enabled; Disabled (Enabled by default)</li><li>• Core Multi-Processing—Enabled; Disabled (Enabled by default)</li></ul>
Boot Up NumLock	Off; On (On by default)

---

**Boot Device Configuration**

---

Removable Device Priority	Used to set the device priority of removable devices like USB floppy drives. The items displayed are dynamically updated according to the removable devices connected.
Hard Disk Boot Priority	Used to set the device priority of hard drives. The items displayed are dynamically updated according to the hard drives detected.
First Boot Device	Removable; Hard Disk; CDROM; USB-CDROM; Legacy LAN; Disabled (Removable by default)
Second Boot Device	Removable; Hard Disk; CDROM; USB-CDROM; Legacy LAN; Disabled (Hard disk by default)
Third Boot Device	Removable; Hard Disk; CDROM; USB-CDROM; Legacy LAN; Disabled (CD-ROM by default)
Boot Other Device	Enabled; Disabled (Disabled by default)

---

**Advanced Chipset Features**

---

Init Display First	PCI Slot, Onboard (PCI Slot by default)
Video Memory Size	1 MB, 8 MB (8 MB by default)
DVMT Mode	FIXED, DVMT (DVMT by default)
DVMT/FIXED Memory Size	128 MB, 256 MB, MAX (128 MB by default)

---

**Integrated Peripherals**

---

USB Device Setting	<ul style="list-style-type: none"><li>• USB Controller—Enabled or Disabled (Enabled by default)</li><li>• USB Operation Mode—High Speed; Full/Low Speed (High Speed by default)</li></ul>
Onboard FDC Controller	Enabled or Disabled (Enabled by default)
Onboard Audio Controller	Enabled or Disabled (Enabled by default)
Onboard LAN Controller	Enabled or Disabled (Enabled by default)
Onboard LAN Boot ROM	Enabled or Disabled (Disabled by default)

---

SATA Mode	IDE; RAID (IDE by default)
-----------	----------------------------

**NOTE:** Applicable for Inspiron 530, 530a and 530c only.

---

### Power Management Setup

---

ACPI Suspend Type	S1(POS); S3(STR) (S3(STR) by default)
Remote Wake Up	On; Off (On by default)
Auto Power On	Enabled; Disabled (Disabled by default)
Auto Power On Date	0
Auto Power On Time	0:00:00
AC Recovery	Off; On; Last (Off by default)

---

## Boot Sequence

This feature allows you to change the boot sequence for devices.

### Option Settings

- **Diskette Drive** — The computer attempts to boot from the floppy drive. If the floppy disk in the drive is not bootable, if no floppy disk is in the drive, or if there is no floppy drive installed in the computer, the computer generates an error message.
- **Hard Drive** — The computer attempts to boot from the primary hard drive. If no operating system is on the drive, the computer generates an error message.
- **CD Drive** — The computer attempts to boot from the CD drive. If no CD is in the drive, or if the CD has no operating system, the computer generates an error message.
- **USB Flash Device** — Insert the memory device into a USB port and restart the computer. When **F12 = Boot Menu** appears in the upper-right corner of the screen, press <F12>. The BIOS detects the device and adds the USB flash option to the boot menu.



**NOTE:** To boot to a USB device, the device must be bootable. To make sure that your device is bootable, check the device documentation.

## Changing Boot Sequence for the Current Boot

You can use this feature, for example, to tell the computer to boot from the CD drive so that you can run the Dell Diagnostics on the *Drivers and Utilities* media, but you want the computer to boot from the hard drive when the diagnostic tests are complete. You can also use this feature to restart your computer to a USB device such as a floppy drive, memory key, or CD-RW drive.



**NOTE:** If you are booting to a USB floppy drive, you must first set the floppy drive to OFF in system setup (see page 187).

- 1 If you are booting to a USB device, connect the USB device to a USB connector.
- 2 Turn on (or restart) your computer.
- 3 When **F2 = Setup**, **F12 = Boot Menu** appears in the upper-right corner of the screen, press <F12>.

If you wait too long and the operating system logo appears, continue to wait until you see the Microsoft Windows desktop. Then shut down your computer and try again.

The **Boot Device Menu** appears, listing all available boot devices. Each device has a number next to it.

- 4 At the bottom of the menu, enter the number of the device that is to be used for the current boot only.

For example, if you are booting to a USB memory key, highlight **USB Flash Device** and press <Enter>.



**NOTE:** To boot to a USB device, the device must be bootable. To make sure your device is bootable, check the device documentation.

## Changing Boot Sequence for Future Boots

- 1 Enter system setup (see "Entering System Setup" on page 188).
- 2 Use the arrow keys to highlight the **Boot Device Configuration** menu option and press <Enter> to access the menu.



**NOTE:** Write down your current boot sequence in case you want to restore it.

- 3 Press the up- and down-arrow keys to move through the list of devices.
- 4 Press plus (+) or minus (-) to change the boot priority of device.



# Clearing Forgotten Passwords

**!** **CAUTION:** Before you begin any of the procedures in this section, follow the safety instructions located in the *Product Information Guide*.

- 1 Follow the procedures in "Before You Begin" on page 105.
- 2 Remove the computer cover (see "Removing the Computer Cover" on page 107).
- 3 Locate the 3-pin password connector (PSWD) on the system board.

**NOTE:** The location of the password connector may vary depending on the system.

## Inspiron 530

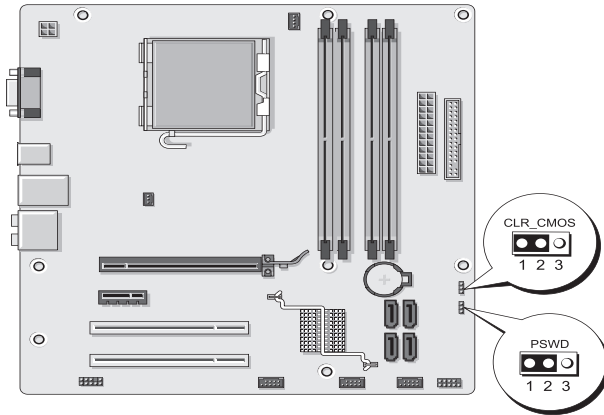

## Inspiron 530a

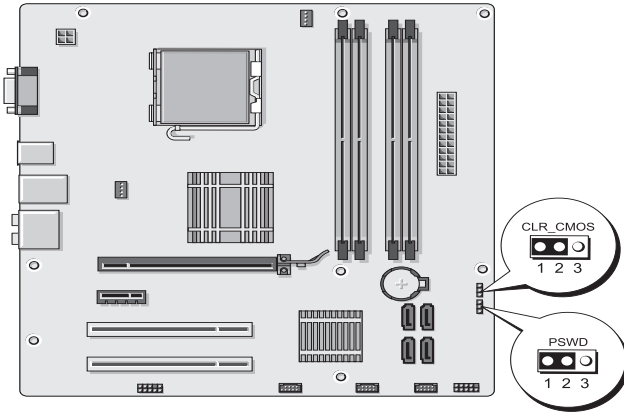

## Inspiron 530b

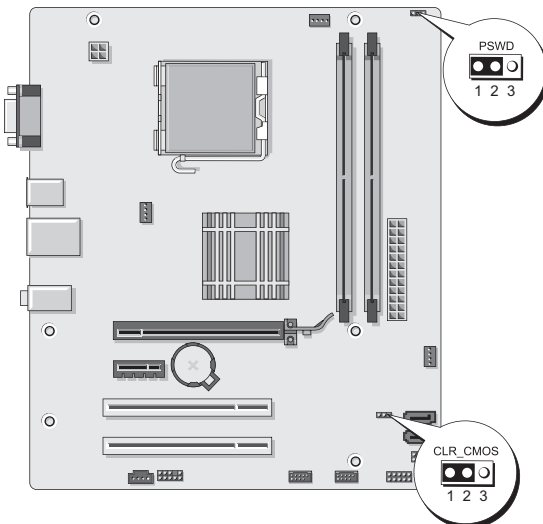

## Inspiron 530c

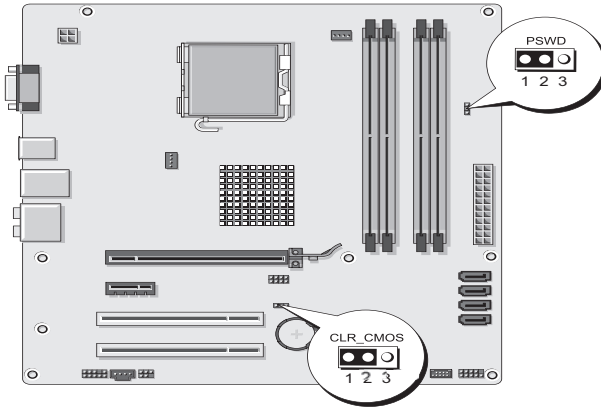

## Inspiron 530d

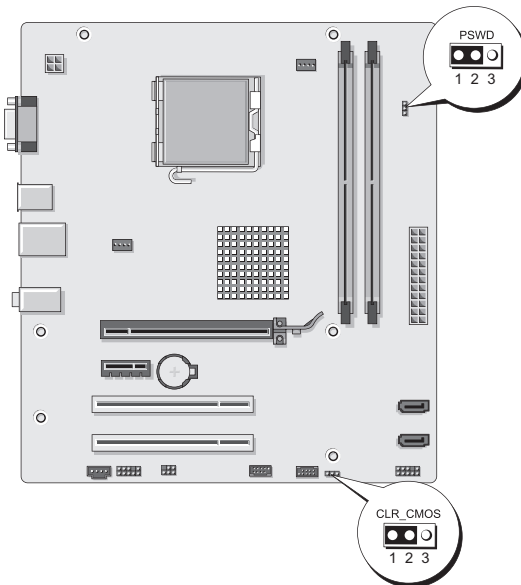

- 4 Remove the 2-pin jumper plug from pins 2 and 3 and fix it on pins 1 and 2.

- 5 Wait for approximately five seconds to clear the password.
  - 6 Remove the 2-pin jumper plug from pins 1 and 2 and replace it on pins 2 and 3 to enable the password feature.
  - 7 Replace the computer cover (see "Replacing the Computer Cover" on page 176).
-  **NOTICE:** To connect a network cable, first plug the cable into the network device and then plug it into the computer.
- 8 Connect your computer and devices to electrical outlets, and turn them on.

## Clearing CMOS Settings

 **CAUTION:** Before you begin any of the procedures in this section, follow the safety instructions located in the Product Information Guide.

- 1 Follow the procedures in "Before You Begin" on page 105.



**NOTE:** The computer must be disconnected from the electrical outlet to clear the CMOS setting.

- 2 Remove the computer cover (see "Removing the Computer Cover" on page 107).
- 3 Reset the current CMOS settings:
  - a Locate the 3-pin CMOS jumper (CLEAR CMOS) on the system board based on your computer model:
    - "Inspiron 530" on page 193
    - "Inspiron 530a" on page 194
    - "Inspiron 530b" on page 194
    - "Inspiron 530c" on page 195
    - "Inspiron 530d" on page 195
  - b Remove the jumper plug from the CMOS jumper (CLEAR CMOS) pins 2 and 3.
  - c Place the jumper plug on the CMOS jumper (CLEAR CMOS) pins 1 and 2 and wait approximately five seconds.
  - d Remove the jumper plug and replace it on the CMOS jumper (CLEAR CMOS) pins 2 and 3.

- 4 Replace the computer cover (see "Replacing the Computer Cover" on page 176).
- ➔ **NOTICE:** To connect a network cable, first plug the cable into the network port or device and then plug it into the computer.
- 5 Connect your computer and devices to electrical outlets, and turn them on.

## Flashing the BIOS

The BIOS may require flashing when an update is available or when replacing the system board.

- 1 Turn on the computer.
- 2 Locate the BIOS update file for your computer at the Dell Support website at [support.dell.com](http://support.dell.com).
- 3 Click Download Now to download the file.
- 4 If the Export Compliance Disclaimer window appears, click Yes, I Accept this Agreement.  
The File Download window appears.
- 5 Click Save this program to disk, and then click OK.  
The Save In window appears.
- 6 Click the down arrow to view the Save In menu, select Desktop, and then click Save.  
The file downloads to your desktop.
- 7 Click Close when the Download Complete window appears.  
The file icon appears on your desktop and is titled the same as the download BIOS update file.
- 8 Double-click the file icon on the desktop and follow the on-screen instructions.

# Cleaning Your Computer

 **CAUTION:** Before you begin any of the procedures in this section, follow the safety instructions located in the Product Information Guide.

## Computer, Keyboard, and Monitor

 **CAUTION:** Before you clean your computer, disconnect the computer from the electrical outlet. Clean your computer with a soft cloth dampened with water. Do not use liquid or aerosol cleaners, which may contain flammable substances.

- Use a vacuum cleaner with a brush attachment to gently remove dust from the slots and holes on your computer and from between the keys on the keyboard.

 **NOTICE:** Do not wipe the display screen with any soap or alcohol solution. Doing so may damage the antiglare coating.

- To clean your monitor screen, lightly dampen a soft, clean cloth with water. If possible, use a special screen-cleaning tissue or solution suitable for the monitor's antistatic coating.
- Wipe the keyboard, computer, and plastic part of the monitor with a soft cleaning cloth moistened with a solution of three parts water and one part dishwashing detergent.

 **NOTICE:** Do not soak the cloth or let water drip inside your computer or keyboard.

## Mouse

If your screen cursor skips or moves abnormally, clean the mouse. To clean a non-optical mouse:

- 1 Turn the retainer ring on the underside of your mouse counterclockwise, and then remove the ball.
- 2 Wipe the ball with a clean, lint-free cloth.
- 3 Blow carefully into the ball cage to dislodge dust and lint.
- 4 If the rollers inside the ball cage are dirty, clean the rollers with a cotton swab moistened lightly with isopropyl alcohol.
- 5 Recenter the rollers in their channels if they are misaligned. Ensure that fluff from the swab is not left on the rollers.
- 6 Replace the ball and retainer ring, and turn the retainer ring clockwise until it clicks into place.

## Floppy Drive (Optional)



**NOTICE:** Do not attempt to clean drive heads with a swab. You might accidentally misalign the heads, which prevents the drive from operating.



**NOTE:** The floppy drive may not be available on all the models.

Clean your floppy drive using a commercially available cleaning kit. These kits contain pretreated floppy disks to remove contaminants that accumulate during normal operation.

## CDs and DVDs



**NOTICE:** Always use compressed air to clean the lens in the CD/DVD drive, and follow the instructions that come with the compressed air. Never touch the lens in the drive.

If you notice problems, such as skipping, with the playback quality of your CDs or DVDs, try cleaning the discs.

- 1 Hold the disc by its outer edge. You can also touch the inside edge of the center hole.



**NOTICE:** To prevent damaging the surface, do not wipe in a circular motion around the disc.

- 2 With a soft, lint-free cloth, gently wipe the bottom of the disc (the unlabeled side) in a straight line from the center to the outer edge of the disc.

For stubborn dirt, try using water or a diluted solution of water and mild soap. You can also purchase commercial products that clean discs and provide some protection from dust, fingerprints, and scratches. Cleaning products for CDs are safe to use on DVDs.

## Dell Technical Support Policy (U.S. Only)

Technician-assisted technical support requires the cooperation and participation of the customer in the troubleshooting process and provides for restoration of the operating system, software programs, and hardware drivers to the original default configuration as shipped from Dell, as well as the verification of appropriate functionality of the computer and all Dell-installed hardware. In addition to this technician-assisted technical support, online technical support is available at [support.dell.com](http://support.dell.com). Additional technical support options may be available for purchase.

Dell provides limited technical support for the computer and any "Dell-installed" software and peripherals<sup>1</sup>. Support for third-party software and peripherals is provided by the original manufacturer, including those purchased and/or installed through Dell Software and Peripherals, Readyware, and Custom Factory Integration<sup>2</sup>.

- <sup>1</sup> Repair services are provided pursuant to the terms and conditions of your limited warranty and any optional support service contract purchased with the computer.
- <sup>2</sup> All Dell-standard components included in a Custom Factory Integration (CFI) project are covered by the standard Dell limited warranty for your computer. However, Dell also extends a parts replacement program to cover all nonstandard, third-party hardware components integrated through CFI for the duration of the computer's service contract.

### **Definition of "Dell-Installed" Software and Peripherals**

Dell-installed software includes the operating system and some of the software programs that are installed on the computer during the manufacturing process (Microsoft<sup>®</sup> Office, Norton Antivirus, and so on).

Dell-installed peripherals include any internal expansion cards, or Dell-branded module bay or PC Card accessories. In addition, any Dell-branded monitors, keyboards, mice, speakers, microphones for telephonic modems, docking stations/port replicators, networking products, and all associated cabling are included.

### **Definition of "Third-Party" Software and Peripherals**

Third-party software and peripherals include any peripheral, accessory, or software program sold by Dell not under the Dell brand (printers, scanners, cameras, games, and so on). Support for all third-party software and peripherals is provided by the original manufacturer of the product.

## **FCC Notice (U.S. Only)**

### **FCC Class B**

This equipment generates, uses, and can radiate radio frequency energy and, if not installed and used in accordance with the manufacturer's instruction manual, may cause interference with radio and television reception. This equipment has been tested and found to comply with the limits for a Class B digital device pursuant to Part 15 of the FCC Rules.



This device complies with Part 15 of the FCC Rules. Operation is subject to the following two conditions:

- 1 This device may not cause harmful interference.
- 2 This device must accept any interference received, including interference that may cause undesired operation.

 **NOTICE:** The FCC regulations provide that changes or modifications not expressly approved by Dell Inc. could void your authority to operate this equipment.

These limits are designed to provide reasonable protection against harmful interference in a residential installation. However, there is no guarantee that interference will not occur in a particular installation. If this equipment does cause harmful interference with radio or television reception, which can be determined by turning the equipment off and on, you are encouraged to try to correct the interference by one or more of the following measures:

- Reorient the receiving antenna.
- Relocate the system with respect to the receiver.
- Move the system away from the receiver.
- Plug the system into a different outlet so that the system and the receiver are on different branch circuits.

If necessary, consult a representative of Dell Inc. or an experienced radio/television technician for additional suggestions.

The following information is provided on the device or devices covered in this document in compliance with the FCC regulations:

Product name:	Dell™ Inspiron™ 530 Series
Model number:	DCMF
Company name:	Dell Inc. Worldwide Regulatory Compliance & Environmental Affairs One Dell Way Round Rock, TX 78682 USA 512-338-4400

 **NOTE:** For further regulatory information, see your Product Information Guide.

## Contacting Dell

 **NOTE:** If you do not have an active Internet connection, you can find contact information on your purchase invoice, packing slip, bill, or Dell product catalog.

Dell provides several online and telephone-based support and service options. Because availability varies by country and product, some services may not be available in your area. To contact Dell for sales, technical support, or customer service issues:

- 1 Visit [support.dell.com](http://support.dell.com).
- 2 Verify your country or region in the Choose A Country/Region drop-down menu at the bottom of the page.
- 3 Click Contact Us on the left side of the page.
- 4 Select the appropriate service or support link based on your need.
- 5 Choose the method of contacting Dell that is convenient for you.

# Glossary

Terms in this Glossary are provided for informational purposes only and may or may not describe features included with your particular computer.

## A

**AC** — alternating current — The form of electricity that powers your computer when you plug the AC adapter power cable in to an electrical outlet.

**ACPI** — advanced configuration and power interface — A power management specification that enables Microsoft® Windows® operating systems to put a computer in standby or hibernate mode to conserve the amount of electrical power allocated to each device attached to the computer.

**AGP** — accelerated graphics port — A dedicated graphics port that allows system memory to be used for video-related tasks. AGP delivers a smooth, true-color video image because of the faster interface between the video circuitry and the computer memory.

**AHCI** — Advanced Host Controller Interface — An interface for a SATA hard drive Host Controller which allows the storage driver to enable technologies such as Native Command Queuing (NCQ) and hot plug.

**ALS** — ambient light sensor — A feature that helps to control display brightness.

**antivirus software** — A program designed to identify, quarantine, and/or delete viruses from your computer.

**ASF** — alert standards format — A standard to define a mechanism for reporting hardware and software alerts to a management console. ASF is designed to be platform- and operating system-independent.

## B

**battery life span** — The length of time (years) during which a portable computer battery is able to be depleted and recharged.

**battery operating time** — The length of time (minutes or hours) that a portable computer battery powers the computer.

**BIOS** — basic input/output system — A program (or utility) that serves as an interface between the computer hardware and the operating system. Unless you understand what effect these settings have on the computer, do not change them. Also referred to as *system setup*.

**bit** — The smallest unit of data interpreted by your computer.

**Bluetooth® wireless technology** — A wireless technology standard for short-range (9 m [29 feet]) networking devices that allows for enabled devices to automatically recognize each other.

**boot sequence** — Specifies the order of the devices from which the computer attempts to boot.

**bootable CD** — A CD that you can use to start your computer. In case your hard drive is damaged or your computer has a virus, ensure that you always have a bootable CD or floppy disk available.

**bootable disk** — A disk that you can use to start your computer. In case your hard drive is damaged or your computer has a virus, ensure that you always have a bootable CD or floppy disk available.

**bps** — bits per second — The standard unit for measuring data transmission speed.

**BTU** — British thermal unit — A measurement of heat output.

**bus** — A communication pathway between the components in your computer.

**bus speed** — The speed, given in MHz, that indicates how fast a bus can transfer information.

**byte** — The basic data unit used by your computer. A byte is usually equal to 8 bits.

## C

**C** — Celsius — A temperature measurement scale where 0° is the freezing point and 100° is the boiling point of water.

**cache** — A special high-speed storage mechanism which can be either a reserved section of main memory or an independent high-speed storage device. The cache enhances the efficiency of many processor operations.

**L1 cache** — Primary cache stored inside the processor.

**L2 cache** — Secondary cache which can either be external to the processor or incorporated into the processor architecture.

**carnet** — An international customs document that facilitates temporary imports into foreign countries. Also known as a *merchandise passport*.

**CD-R** — CD recordable — A recordable version of a CD. Data can be recorded only once onto a CD-R. Once recorded, the data cannot be erased or written over.

**CD-RW** — CD rewritable — A rewritable version of a CD. Data can be written to a CD-RW disc, and then erased and written over (rewritten).

**CD-RW drive** — A drive that can read CDs and write to CD-RW (rewritable CDs) and CD-R (recordable CDs) discs. You can write to CD-RW discs multiple times, but you can write to CD-R discs only once.

**CD-RW/DVD drive** — A drive, sometimes referred to as a combo drive, that can read CDs and DVDs and write to CD-RW (rewritable CDs) and CD-R (recordable CDs) discs. You can write to CD-RW discs multiple times, but you can write to CD-R discs only once.

**clock speed** — The speed, given in MHz, that indicates how fast computer components that are connected to the system bus operate.

**COA** — Certificate of Authenticity — The Windows alpha-numeric code located on a sticker on your computer. Also referred to as the *Product Key* or *Product ID*.

**Control Panel** — A Windows utility that allows you to modify operating system and hardware settings, such as display settings.

**controller** — A chip that controls the transfer of data between the processor and memory or between the processor and devices.

**CRIMM** — continuity rambus in-line memory module — A special module that has no memory chips and is used to fill unused RIMM slots.

**cursor** — The marker on a display or screen that shows where the next keyboard, touch pad, or mouse action will occur. It often is a blinking solid line, an underline character, or a small arrow.

## D

**DDR SDRAM** — double-data-rate SDRAM — A type of SDRAM that doubles the data burst cycle, improving system performance.

**DDR2 SDRAM** — double-data-rate 2 SDRAM — A type of DDR SDRAM that uses a 4-bit prefetch and other architectural changes to boost memory speed to over 400 MHz.

**DDR3 SDRAM** — double-data-rate 3 SDRAM — A type of DDR SDRAM that uses a 8-bit prefetch and other architectural changes to boost memory speed to over 800 MHz.

**device** — Hardware such as a disk drive, printer, or keyboard that is installed in or connected to your computer.

**device driver** — See *driver*.

**DIMM** — dual in-line memory module — A circuit board with memory chips that connects to a memory module on the system board.

**DIN connector** — A round, six-pin connector that conforms to DIN (Deutsche Industrie-Norm) standards; it is typically used to connect PS/2 keyboard or mouse cable connectors.

**disk striping** — A technique for spreading data over multiple disk drives. Disk striping can speed up operations that retrieve data from disk storage. Computers that use disk striping generally allow the user to select the data unit size or stripe width.

**DMA** — direct memory access — A channel that allows certain types of data transfer between RAM and a device to bypass the processor.

**docking device** — See *APR*.

**DMTF** — Distributed Management Task Force — A consortium of hardware and software companies who develop management standards for distributed desktop, network, enterprise, and Internet environments.

**domain** — A group of computers, programs, and devices on a network that are administered as a unit with common rules and procedures for use by a specific group of users. A user logs on to the domain to gain access to the resources.

**DRAM** — dynamic random-access memory — Memory that stores information in integrated circuits containing capacitors.

**driver** — Software that allows the operating system to control a device such as a printer. Many devices do not work properly if the correct driver is not installed in the computer.

**DSL** — Digital Subscriber Line — A technology that provides a constant, high-speed Internet connection through an analog telephone line.

**dual-core** — A technology in which two physical computational units exist inside a single processor package, thereby increasing computing efficiency and multi-tasking ability.

**dual display mode** — A display setting that allows you to use a second monitor as an extension of your display. Also referred to as *extended display mode*.

**DVD-R** — DVD recordable — A recordable version of a DVD. Data can be recorded only once onto a DVD-R. Once recorded, the data cannot be erased or written over.

**DVD+RW** — DVD rewritable — A rewritable version of a DVD. Data can be written to a DVD+RW disc, and then erased and written over (rewritten). (DVD+RW technology is different from DVD-RW technology.)

**DVD+RW drive** — drive that can read DVDs and most CD media and write to DVD+RW (rewritable DVDs) discs.

**DVI** — digital video interface — A standard for digital transmission between a computer and a digital video display.

## E

**ECC** — error checking and correction — A type of memory that includes special circuitry for testing the accuracy of data as it passes in and out of memory.

**ECP** — extended capabilities port — A parallel connector design that provides improved bidirectional data transmission. Similar to EPP, ECP uses direct memory access to transfer data and often improves performance.

**EIDE** — enhanced integrated device electronics — An improved version of the IDE interface for hard drives and CD drives.

**EMI** — electromagnetic interference — Electrical interference caused by electromagnetic radiation.

**ENERGY STAR®** — Environmental Protection Agency requirements that decrease the overall consumption of electricity.

**EPP** — enhanced parallel port — A parallel connector design that provides bidirectional data transmission.

**ESD** — electrostatic discharge — A rapid discharge of static electricity. ESD can damage integrated circuits found in computer and communications equipment.

**expansion card** — A circuit board that installs in an expansion slot on the system board in some computers, expanding the capabilities of the computer. Examples include video, modem, and sound cards.

**expansion slot** — A connector on the system board (in some computers) where you insert an expansion card, connecting it to the system bus.

**ExpressCard** — A removable I/O card adhering to the PCMCIA standard. Modems and network adapters are common types of ExpressCards. ExpressCards support both the PCI Express and USB 2.0 standard.

**Express Service Code** — A numeric code located on a sticker on your Dell™ computer. Use the Express Service Code when contacting Dell for assistance. Express Service Code service may not be available in some countries.

**extended display mode** — A display setting that allows you to use a second monitor as an extension of your display. Also referred to as *dual display mode*.

**extended PC Card** — A PC Card that extends beyond the edge of the PC Card slot when installed.

## F

**Fahrenheit** — A temperature measurement scale where 32° is the freezing point and 212° is the boiling point of water.

**FBD** — fully-buffered DIMM — A DIMM with DDR2 DRAM chips and an Advanced Memory Buffer (AMB) that speeds communication between the DDR2 SDRAM chips and the system.

**FCC** — Federal Communications Commission — A U.S. agency responsible for enforcing communications-related regulations that state how much radiation computers and other electronic equipment can emit.

**fingerprint reader** — A strip sensor that uses your unique fingerprint to authenticate your user identity to help secure your computer.

**folder** — A term used to describe space on a disk or drive where files are organized and grouped. Files in a folder can be viewed and ordered in various ways, such as alphabetically, by date, and by size.

**format** — The process that prepares a drive or disk for file storage. When a drive or disk is formatted, the existing information on it is lost.

**FSB** — front side bus — The data path and physical interface between the processor and RAM.

**FTP** — file transfer protocol — A standard Internet protocol used to exchange files between computers connected to the Internet.

## G

**G** — gravity — A measurement of weight and force.

**GB** — gigabyte — A measurement of data storage that equals 1024 MB (1,073,741,824 bytes). When used to refer to hard drive storage, the term is often rounded to 1,000,000,000 bytes.

**GHz** — gigahertz — A measurement of frequency that equals one thousand million Hz, or one thousand MHz. The speeds for computer processors, buses, and interfaces are often measured in GHz.

**graphics mode** — A video mode that can be defined as  $x$  horizontal pixels by  $y$  vertical pixels by  $z$  colors. Graphics modes can display an unlimited variety of shapes and fonts.

**GUI** — graphical user interface — Software that interacts with the user by means of menus, windows, and icons. Most programs that operate on the Windows operating systems are GUIs.



## H

**hard drive** — A drive that reads and writes data on a hard disk. The terms hard drive and hard disk are often used interchangeably.

**heat sink** — A metal plate on some processors that helps dissipate heat.

**hibernate mode** — A power management mode that saves everything in memory to a reserved space on the hard drive and then turns off the computer. When you restart the computer, the memory information that was saved to the hard drive is automatically restored.

**HTTP** — hypertext transfer protocol — A protocol for exchanging files between computers connected to the Internet.

**Hz** — hertz — A unit of frequency measurement that equals 1 cycle per second. Computers and electronic devices are often measured in kilohertz (kHz), megahertz (MHz), gigahertz (GHz), or terahertz (THz).

## I

**IC** — integrated circuit — A semiconductor wafer, or chip, on which thousands or millions of tiny electronic components are fabricated for use in computer, audio, and video equipment.

**IDE** — integrated device electronics — An interface for mass storage devices in which the controller is integrated into the hard drive or CD drive.

**IEEE 1394** — Institute of Electrical and Electronics Engineers, Inc. — A high-performance serial bus used to connect IEEE 1394-compatible devices, such as digital cameras and DVD players, to the computer.

**infrared sensor** — A port that allows you to transfer data between the computer and infrared-compatible devices without using a cable connection.

**integrated** — Usually refers to components that are physically located on the computer's system board. Also referred to as *built-in*.

**I/O** — input/output — An operation or device that enters and extracts data from your computer. Keyboards and printers are I/O devices.

**I/O address** — An address in RAM that is associated with a specific device (such as a serial connector, parallel connector, or expansion slot) and allows the processor to communicate with that device.

**IrDA** — Infrared Data Association — The organization that creates international standards for infrared communications.

**IRQ** — interrupt request — An electronic pathway assigned to a specific device so that the device can communicate with the processor. Each device connection must be assigned an **IRQ**. Although two devices can share the same **IRQ** assignment, you cannot operate both devices simultaneously.

**ISP** — Internet service provider — A company that allows you to access its host server to connect directly to the Internet, send and receive e-mail, and access websites. The ISP typically provides you with a software package, user name, and access phone numbers for a fee.

## **K**

**Kb** — kilobit — A unit of data that equals 1024 bits. A measurement of the capacity of memory integrated circuits.

**KB** — kilobyte — A unit of data that equals 1024 bytes but is often referred to as 1000 bytes.

**key combination** — A command requiring you to press multiple keys at the same time.

**kHz** — kilohertz — A measurement of frequency that equals 1000 Hz.

## **L**

**LAN** — local area network — A computer network covering a small area. A LAN usually is confined to a building or a few nearby buildings. A LAN can be connected to another LAN over any distance through telephone lines and radio waves to form a wide area network (WAN).

**LCD** — liquid crystal display — The technology used by portable computer and flat-panel displays.

**LED** — light-emitting diode — An electronic component that emits light to indicate the status of the computer.

**local bus** — A data bus that provides a fast throughput for devices to the processor.

**LPT** — line print terminal — The designation for a parallel connection to a printer or other parallel device.

## **M**

**Mb** — megabit — A measurement of memory chip capacity that equals 1024 Kb.

**Mbps** — megabits per second — One million bits per second. This measurement is typically used for transmission speeds for networks and modems.

**MB** — megabyte — A measurement of data storage that equals 1,048,576 bytes. 1 MB equals 1024 KB. When used to refer to hard drive storage, the term is often rounded to 1,000,000 bytes.

**MB/sec** — megabytes per second — One million bytes per second. This measurement is typically used for data transfer ratings.

**media bay** — A bay that supports devices such as optical drives, a second battery, or a Dell TravelLite™ module.

**memory** — A temporary data storage area inside your computer. Because the data in memory is not permanent, it is recommended that you frequently save your files while you are working on them, and always save your files before you shut down the computer. Your computer can contain several different forms of memory, such as RAM, ROM, and video memory. Frequently, the word memory is used as a synonym for RAM.

**memory address** — A specific location where data is temporarily stored in RAM.

**memory mapping** — The process by which the computer assigns memory addresses to physical locations at start-up. Devices and software can then identify information that the processor can access.

**memory module** — A small circuit board containing memory chips, which connects to the system board.

**MHz** — megahertz — A measure of frequency that equals 1 million cycles per second. The speeds for computer processors, buses, and interfaces are often measured in MHz.

**Mini PCI** — A standard for integrated peripheral devices with an emphasis on communications such as modems and NICs. A Mini PCI card is a small external card that is functionally equivalent to a standard PCI expansion card.

**Mini-Card** — A small card designed for integrated peripherals, such as communication NICs. The Mini-Card is functionally equivalent to a standard PCI expansion card.

**modem** — A device that allows your computer to communicate with other computers over analog telephone lines. Three types of modems include: external, PC Card, and internal. You typically use your modem to connect to the Internet and exchange e-mail.

**module bay** — See *media bay*.

**MP** — megapixel — A measure of image resolution used for digital cameras.

**ms** — millisecond — A measure of time that equals one thousandth of a second. Access times of storage devices are often measured in ms.

## N

**network adapter** — A chip that provides network capabilities. A computer may include a network adapter on its system board, or it may contain a PC Card with an adapter on it. A network adapter is also referred to as a *NIC* (network interface controller).

**NIC** — See *network adapter*.

**notification area** — The section of the Windows taskbar that contains icons for providing quick access to programs and computer functions, such as the clock, volume control, and print status. Also referred to as *system tray*.

**ns** — nanosecond — A measure of time that equals one billionth of a second.

**NVRAM** — nonvolatile random access memory — A type of memory that stores data when the computer is turned off or loses its external power source. NVRAM is used for maintaining computer configuration information such as date, time, and other system setup options that you can set.

## O

**optical drive** — A drive that uses optical technology to read or write data from CDs, DVDs, or DVD+RWs. Example of optical drives include CD drives, DVD drives, CD-RW drives, and CD-RW/DVD combo drives.

## P

**partition** — A physical storage area on a hard drive that is assigned to one or more logical storage areas known as logical drives. Each partition can contain multiple logical drives.

**PC Card** — A removable I/O card adhering to the PCMCIA standard. Modems and network adapters are common types of PC Cards.

**PCI** — peripheral component interconnect — PCI is a local bus that supports 32- and 64-bit data paths, providing a high-speed data path between the processor and devices such as video, drives, and networks.

**PCI Express** — A modification to the PCI interface that boosts the data transfer rate between the processor and the devices attached to it. PCI Express can transfer data at speeds from 250 MB/sec to 4 GB/sec. If the PCI Express chip set and the device are capable of different speeds, they will operate at the slower speed.

**PCMCIA** — Personal Computer Memory Card International Association — The organization that establishes standards for PC Cards.

**PIO** — programmed input/output — A method of transferring data between two devices through the processor as part of the data path.

**pixel** — A single point on a display screen. Pixels are arranged in rows and columns to create an image. A video resolution, such as 800 x 600, is expressed as the number of pixels across by the number of pixels up and down.

**Plug-and-Play** — The ability of the computer to automatically configure devices. Plug and Play provides automatic installation, configuration, and compatibility with existing hardware if the BIOS, operating system, and all devices are Plug and Play compliant.

**POST** — power-on self-test — Diagnostics programs, loaded automatically by the BIOS, that perform basic tests on the major computer components, such as memory, hard drives, and video. If no problems are detected during POST, the computer continues the start-up.

**processor** — A computer chip that interprets and executes program instructions. Sometimes the processor is referred to as the CPU (central processing unit).

**PS/2** — personal system/2 — A type of connector for attaching a PS/2-compatible keyboard, mouse, or keypad.

**PXE** — pre-boot execution environment — A WfM (Wired for Management) standard that allows networked computers that do not have an operating system to be configured and started remotely.

## R

**RAID** — redundant array of independent disks — A method of providing data redundancy. Some common implementations of RAID include RAID 0, RAID 1, RAID 5, RAID 10, and RAID 50.

**RAM** — random-access memory — The primary temporary storage area for program instructions and data. Any information stored in RAM is lost when you shut down your computer.

**readme file** — A text file included with a software package or hardware product. Typically, readme files provide installation information and describe new product enhancements or corrections that have not yet been documented.

**read-only** — Data and/or files you can view but cannot edit or delete. A file can have read-only status if:

- It resides on a physically write-protected floppy disk, CD, or DVD.
- It is located on a network in a directory and the system administrator has assigned rights only to specific individuals.

**refresh rate** — The frequency, measured in Hz, at which your screen's horizontal lines are recharged (sometimes also referred to as its *vertical frequency*). The higher the refresh rate, the less video flicker can be seen by the human eye.

**resolution** — The sharpness and clarity of an image produced by a printer or displayed on a monitor. The higher the resolution, the sharper the image.

**RFI** — radio frequency interference — Interference that is generated at typical radio frequencies, in the range of 10 kHz to 100,000 MHz. Radio frequencies are at the lower end of the electromagnetic frequency spectrum and are more likely to have interference than the higher frequency radiations, such as infrared and light.

**ROM** — read-only memory — Memory that stores data and programs that cannot be deleted or written to by the computer. ROM, unlike RAM, retains its contents after you shut down your computer. Some programs essential to the operation of your computer reside in ROM.

**RPM** — revolutions per minute — The number of rotations that occur per minute. Hard drive speed is often measured in rpm.

**RTC** — real time clock — Battery-powered clock on the system board that keeps the date and time after you shut down the computer.

**RTCST** — real-time clock reset — A jumper on the system board of some computers that can often be used for troubleshooting problems.

## S

**SAS** — serial attached SCSI — A faster, serial version of the SCSI interface (as opposed to the original SCSI parallel architecture).

**SATA** — serial ATA — A faster, serial version of the ATA (IDE) interface.

**ScanDisk** — A Microsoft utility that checks files, folders, and the hard disk's surface for errors. ScanDisk often runs when you restart the computer after it has stopped responding.

**SCSI** — small computer system interface — A high-speed interface used to connect devices to a computer, such as hard drives, CD drives, printers, and scanners. The SCSI can connect many devices using a single controller. Each device is accessed by an individual identification number on the SCSI controller bus.

**SDRAM** — synchronous dynamic random-access memory — A type of DRAM that is synchronized with the optimal clock speed of the processor.

**serial connector** — An I/O port often used to connect devices such as a handheld digital device or digital camera to your computer.

**Service Tag** — A bar code label on your computer that identifies your computer when you access Dell Support at [support.dell.com](http://support.dell.com) or when you call Dell for customer service or technical support.

**setup program** — A program that is used to install and configure hardware and software. The **setup.exe** or **install.exe** program comes with most Windows software packages. *Setup program* differs from *system setup*.

**shortcut** — An icon that provides quick access to frequently used programs, files, folders, and drives. When you place a shortcut on your Windows desktop and double-click the icon, you can open its corresponding folder or file without having to find it first. Shortcut icons do not change the location of files. If you delete a shortcut, the original file is not affected. Also, you can rename a shortcut icon.

**SIM** — Subscriber Identity Module — A SIM card contains a microchip that encrypts voice and data transmissions. SIM cards can be used in phones or portable computers.

**smart card** — A card that is embedded with a processor and a memory chip. Smart cards can be used to authenticate a user on computers equipped for smart cards.

**S/PDIF** — Sony/Philips Digital Interface — An audio transfer file format that allows the transfer of audio from one file to another without converting it to and from an analog format, which could degrade the quality of the file.

**standby mode** — A power management mode that shuts down all unnecessary computer operations to save energy.

**Strike Zone™** — Reinforced area of the platform base that protects the hard drive by acting as a dampening device when a computer experiences resonating shock or is dropped (whether the computer is on or off).

**surge protectors** — Prevent voltage spikes, such as those that may occur during an electrical storm, from entering the computer through the electrical outlet. Surge protectors do not protect against lightning strikes or against brownouts, which occur when the voltage drops more than 20 percent below the normal AC-line voltage level.

Network connections cannot be protected by surge protectors. Always disconnect the network cable from the network connector during electrical storms.

**SVGA** — super-video graphics array — A video standard for video cards and controllers. Typical SVGA resolutions are 800 x 600 and 1024 x 768.

The number of colors and resolution that a program displays depends on the capabilities of the monitor, the video controller and its drivers, and the amount of video memory installed in the computer.

**S-video TV-out** — A connector used to attach a TV or digital audio device to the computer.

**SXGA** — super-extended graphics array — A video standard for video cards and controllers that supports resolutions up to 1280 x 1024.

**SXGA+** — super-extended graphics array plus — A video standard for video cards and controllers that supports resolutions up to 1400 x 1050.

**system board** — The main circuit board in your computer. Also known as the *motherboard*.

**system setup** — A utility that serves as an interface between the computer hardware and the operating system. System setup allows you to configure user-selectable options in the BIOS, such as date and time or system password. Unless you understand what effect the settings have on the computer, do not change the settings for this program.

## T

**TAPI** — telephony application programming interface — Enables Windows programs to operate with a wide variety of telephony devices, including voice, data, fax, and video.

**text editor** — A program used to create and edit files that contain only text; for example, Windows Notepad uses a text editor. Text editors do not usually provide word wrap or formatting functionality (the option to underline, change fonts, and so on).

**TPM** — trusted platform module — A hardware-based security feature that when combined with security software enhances network and computer security by enabling features such as file and e-mail protection.

**travel module** — A plastic device designed to fit inside the module bay of a portable computer to reduce the weight of the computer.

## U

**UMA** — unified memory allocation — System memory dynamically allocated to video.

**UPS** — uninterruptible power supply — A backup power source used when the electrical power fails or drops to an unacceptable voltage level. A UPS keeps a computer running for a limited amount of time when there is no electrical power. UPS systems typically provide surge suppression and may also provide voltage regulation. Small UPS systems provide battery power for a few minutes to enable you to shut down your computer.



**USB** — universal serial bus — A hardware interface for a low-speed device such as a USB-compatible keyboard, mouse, joystick, scanner, set of speakers, printer, broadband devices (DSL and cable modems), imaging devices, or storage devices. Devices are plugged directly in to a 4-pin socket on your computer or in to a multi-port hub that plugs in to your computer. USB devices can be connected and disconnected while the computer is turned on, and they can also be daisy-chained together.

**UTP** — unshielded twisted pair — Describes a type of cable used in most telephone networks and some computer networks. Pairs of unshielded wires are twisted to protect against electromagnetic interference, rather than relying on a metal sheath around each pair of wires to protect against interference.

**UXGA** — ultra extended graphics array — A video standard for video cards and controllers that supports resolutions up to 1600 x 1200.

## V

**video controller** — The circuitry on a video card or on the system board (in computers with an integrated video controller) that provides the video capabilities—in combination with the monitor—for your computer.

**video memory** — Memory that consists of memory chips dedicated to video functions. Video memory is usually faster than system memory. The amount of video memory installed primarily influences the number of colors that a program can display.

**video mode** — A mode that describes how text and graphics are displayed on a monitor. Graphics-based software, such as Windows operating systems, displays in video modes that can be defined as  $x$  horizontal pixels by  $y$  vertical pixels by  $z$  colors. Character-based software, such as text editors, displays in video modes that can be defined as  $x$  columns by  $y$  rows of characters.

**video resolution** — See *resolution*.

**virus** — A program that is designed to inconvenience you or to destroy data stored on your computer. A virus program moves from one computer to another through an infected disk, software downloaded from the Internet, or e-mail attachments. When an infected program starts, its embedded virus also starts.

A common type of virus is a boot virus, which is stored in the boot sectors of a floppy disk. If the floppy disk is left in the drive when the computer is shut down and then turned on, the computer is infected when it reads the boot sectors of the floppy disk expecting to find the operating system. If the computer is infected, the boot virus may replicate itself onto all the floppy disks that are read or written in that computer until the virus is eradicated.

**V** — volt — The measurement of electric potential or electromotive force. One V appears across a resistance of 1 ohm when a current of 1 ampere flows through that resistance.

## W

**W** — watt — The measurement of electrical power. One W is 1 ampere of current flowing at 1 volt.

**WHr** — watt-hour — A unit of measure commonly used to indicate the approximate capacity of a battery. For example, a 66-WHr battery can supply 66 W of power for 1 hour or 33 W for 2 hours.

**wallpaper** — The background pattern or picture on the Windows desktop. Change your wallpaper through the Windows Control Panel. You can also scan in your favorite picture and make it wallpaper.

**WLAN** — wireless local area network. A series of interconnected computers that communicate with each other over the air waves using access points or wireless routers to provide Internet access.

**write-protected** — Files or media that cannot be changed. Use write-protection when you want to protect data from being changed or destroyed. To write-protect a 3.5-inch floppy disk, slide its write-protect tab to the open position.

**WWAN** — wireless wide area network. A wireless high-speed data network using cellular technology and covering a much larger geographic area than WLAN.

**WXGA** — wide-aspect extended graphics array — A video standard for video cards and controllers that supports resolutions up to 1280 x 800.

## X

**XGA** — extended graphics array — A video standard for video cards and controllers that supports resolutions up to 1024 x 768.

## Z

**ZIF** — zero insertion force — A type of socket or connector that allows a computer chip to be installed or removed with no stress applied to either the chip or its socket.

**Zip** — A popular data compression format. Files that have been compressed with the Zip format are called Zip files and usually have a filename extension of **.zip**. A special kind of zipped file is a self-extracting file, which has a filename extension of **.exe**. You can unzip a self-extracting file by double-clicking it.

**Zip drive** — A high-capacity floppy drive developed by Iomega Corporation that uses 3.5-inch removable disks called Zip disks. Zip disks are slightly larger than regular floppy disks, about twice as thick, and hold up to 100 MB of data.

# Index

## A

audio. *See sound*

## B

battery

problems, 63

replacing, 160

beep codes, 86

BIOS, 187

boot sequence, 191

changing, 192

option settings, 191

booting

to a USB device, 192

## C

cards

installing PCI, 130

PCI, 129

removing PCI, 134

slots, 129

types supported, 129

CD/DVD drive

installing, 155, 157

problems, 65

removing, 154

CD-RW drive

problems, 65

CDs, 34

playing, 31

Check Disk, 66

CMOS settings

clearing, 196

computer

beep codes, 86

components inside, 109

crashes, 70-71

inside view, 109

restore to previous state, 98

stops responding, 70

conflicts

software and hardware

incompatibilities, 97

copying CDs

general information, 34

helpful tips, 36

how to, 34

copying DVDs

general information, 34

helpful tips, 36

how to, 34

cover

removing, 107

replacing, 176

## D

### Dell

- contacting, 202
- support policy, 199
- support site, 12

### Dell Diagnostics, 90

### diagnostics

- beep codes, 86
- Dell, 90

### documentation

- End User License Agreement, 11
- ergonomics, 11
- Finding Information, 11
- online, 12
- Product Information Guide, 11
- regulatory, 11
- safety, 11
- Setup Diagram, 11
- warranty, 11

### drive-panel insert

- removing, 149
- replacing, 150, 159

### drivers, 94

- about, 94
- identifying, 94
- reinstalling, 95

### Drivers and Utilities media, 96

- Dell Diagnostics, 90

### drives, 138

- hard drive, 140
- installing CD/DVD, 155, 157
- installing floppy, 147
- installing hard drive, 142

### problems, 64

- removing CD/DVD, 154
- removing floppy, 145
- removing hard drive, 140
- second hard drive, 143
- serial ATA, 140

### DVD drive

- problems, 65

### DVDs, 34

- playing, 31

## E

### e-mail

- problems, 66

### End User License Agreement, 11

### ergonomics information, 11

### error messages

- beep codes, 86
- troubleshooting, 68

## F

### Files and Settings Transfer Wizard, 54, 60

### Finding Information, 11

### Flex Bay drive

- Media Card Reader, 16-19

### floppy drive

- installing, 147
- removing, 145

## H

- hard drive
  - installing, 142
  - installing second, 143
  - problems, 66
  - removing, 140
- hardware
  - beep codes, 86
  - conflicts, 97
  - Dell Diagnostics, 90
- Help and Support, 13
- hibernate mode, 41, 43-44

## I

- I/O panel
  - replacing, 165
- installing parts
  - before you begin, 105
  - recommended tools, 105
  - turning off your computer, 106
- Internet
  - problems, 66
- Internet connection
  - about, 60
  - options, 60
  - setting up, 60
- IRQ conflicts, 97

## K

- keyboard
  - problems, 69

## L

- labels
  - Microsoft Windows, 12
  - Service Tag, 12, 16, 18

## M

- Media Card Reader
  - installing, 151-152
  - problems, 73
  - removing, 151
  - using, 36
- memory
  - installing, 126
  - problems, 74
- messages
  - error, 68
- modem
  - problems, 66
- monitor
  - blank, 83
  - clone mode, 40
  - connect DVI, 38-39
  - connect TV, 38-39
  - connect two, 38-39
  - connect VGA, 38-39
  - display settings, 40
  - extended desktop mode, 40
  - hard to read, 84
- mouse
  - problems, 75

## N

- network
  - problems, 76
  - setting up, 58

## O

- operating system
  - reinstalling Windows Vista, 98
  - reinstalling Windows XP, 98

## P

- password
  - clearing, 193
  - jumper, 193
- PC Restore, 100
- PCI cards
  - installing, 130
  - removing, 134
- playing CDs and DVDs, 31
- power
  - button, 16, 18
  - conserving, 40
  - hibernate mode, 41, 43-44
  - managing, 40
  - options, 42
  - options, advanced, 46
  - options, schemes, 42
  - plan, 45
  - problems, 77
  - standby mode, 40, 44

- power light
  - conditions, 77
- power options properties, 42
- Power Plan Properties, 45
- printer
  - cable, 29
  - connecting, 29
  - problems, 78
  - setting up, 29
  - USB, 29
- problems
  - battery, 63
  - beep codes, 86
  - blue screen, 71
  - CD drive, 65
  - CD-RW drive, 65
  - computer crashes, 70-71
  - computer stops responding, 70
  - conflicts, 97
  - Dell Diagnostics, 90
  - drives, 64
  - DVD drive, 65
  - e-mail, 66
  - error messages, 68
  - general, 70
  - hard drive, 66
  - Internet, 66
  - keyboard, 69
  - Media Card Reader, 73
  - memory, 74
  - modem, 66
  - monitor is blank, 83

- monitor is hard to read, 84
- mouse, 75
- network, 76
- power, 77
- power light conditions, 77
- printer, 78
- program crashes, 70
- program stops responding, 70
- programs and Windows
  - compatibility, 71
- restore to previous state, 98
- scanner, 80
- screen is blank, 83
- screen is hard to read, 84
- software, 70-72
- sound and speakers, 81
- technical support policy, 199
- troubleshooting tips, 63
- volume adjusting, 81

Product Information Guide, 11

Program Compatibility Wizard, 71

## R

- regulatory information, 11
- reinstalling
  - Windows Vista, 98
  - Windows XP, 98
- Removing Memory, 128

## S

- S.M.A.R.T, 89
- safety instructions, 11
- SATA. See *serial ATA*
- scanner
  - problems, 80
- serial ATA, 140
- Service Tag, 12, 16, 18
- service tag, 16, 18
- settings
  - system setup, 187
- Setup Diagram, 11
- software
  - conflicts, 97
  - problems, 70-72
- sound
  - problems, 81
  - volume, 81
- speaker
  - problems, 81
  - volume, 81
- specifications
  - audio, 180, 183
  - computer information, 179, 182
  - connectors, 181, 184
  - controls and lights, 185
  - drives, 181, 184
  - environmental, 186
  - expansion bus, 180, 183

- memory, 179, 182
  - physical, 186
  - power, 186
  - processor, 179, 182
  - video, 180, 183
- standby mode, 40, 44
- Starting the Dell Diagnostics
  - From the Drivers and Utilities CD, 91
- Starting the Dell Diagnostics
  - From Your Hard Drive, 90
- support
  - contacting Dell, 202
  - policy, 199
- support website, 12
- System Restore, 98
- system setup
  - about, 187
  - entering, 188
  - options, 189
  - screens, 188

## **T**

- technical support
  - policy, 199
- transferring information to a new computer, 54, 60
- troubleshooting
  - conflicts, 97
  - Dell Diagnostics, 90
  - Hardware Troubleshooter, 97
  - Help and Support, 13

- restore to previous state, 98
- tips, 63

## **TV**

- connect to computer, 38-39

## **U**

### **USB**

- booting to devices, 192

- Using Windows Device Driver Rollback, 95

## **V**

### **volume**

- adjusting, 81

## **W**

- warranty information, 11

### **Windows**

- Files and Settings Transfer Wizard, 54

### **Windows Vista**

- Device Driver Rollback, 95
- Hardware Troubleshooter, 97
- Help and Support, 13
- Program Compatibility Wizard, 71
- reinstalling, 98
- scanner, 80
- System Restore, 98



## Windows XP

- Device Driver Rollback, 95

- Files and Settings Transfer

  - Wizard, 60

- Help and Support, 13

- reinstalling, 98

- System Restore, 98

## wizards

- Files and Settings Transfer

  - Wizard, 54, 60

- Program Compatibility

  - Wizard, 71

